

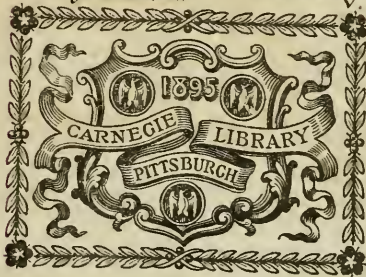

Class [redacted] Book [redacted]

v. 19











# Electric Railway Review

PUBLISHED EVERY SATURDAY.

FORMERLY THE STREET RAILWAY REVIEW.

THE WILSON COMPANY, CHICAGO.

160 Harrison Street, Chicago  
130 Nassau Street, New York  
1529 Williamson Bldg., Cleveland

Vol. XIX  
No. 1

CHICAGO, JANUARY 4, 1908

Whole No. 245  
Subscription: Domestic . . . \$2  
Foreign . . . \$5  
Canada . . . \$3.50

Electric railway employes who wish to get the greatest good from their work in the New Year should surely

*Buy                      Read                      Study*

## “The Motorman and His Duties”

By following this plan each will secure intimate knowledge of the principles governing the operation of electric railway cars.

This book explains in simple language, devoid of mathematics and technicalities, many points not generally understood by the average employe who has to do with the operation or care of electric railway rolling stock. Such knowledge cannot fail to make his services more valuable to his company and more satisfactory to himself, and it will also better fit him for promotion.

The revised, enlarged and improved sixth edition is now ready. Two hundred pages; 138 illustrations; three folding sheets of multiple-unit wiring diagrams; cloth binding. *Price, \$1.50 per copy, prepaid.*

Send your address on a postal for a pamphlet of sample pages, etc.

**The Wilson Company**      160 Harrison Street  
CHICAGO, U. S. A.

# National Air Brakes

## For Electric Railway Service

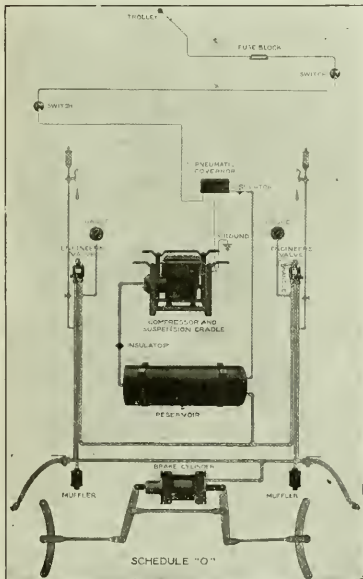

Diagram of National Straight Air Brake Equipment

possess distinctively new and improved features which invite the careful consideration of progressive railway men.

They have attained an enviable distinction as the standard of efficiency, reliability and simplicity. The careful design and construction of the component parts of the apparatus make "National Air Brakes" the most efficient, compact and serviceable brakes for modern traction service at a minimum of expense for operation and maintenance.

**Bulletins on any or all of the apparatus sent upon request.**

## National Brake & Electric Co.

Milwaukee, U. S. A.

NEW YORK: 111 Broadway

PHILADELPHIA: Land Title Building

BOSTON: F. E. Huntress, 131 State Street

General Sales Office

519 First National Bank Building

CHICAGO

DENVER: Hendrie & Bulthoff Co.

SAN FRANCISCO, CAL.: W. F. McKENNY  
526 Mission Street

LONDON: 14 Great Smith St., Westminster



# Electric Railway Review

FORMERLY THE STREET RAILWAY REVIEW

VOLUME XIX

January 1 to May 31, 1908

THE WILSON COMPANY

160 Harrison Street

Chicago



# GENERAL INDEX

## A

Accidents—	Albany & Hudson Railroad—	Ashtabula Electric Street Railroad, Track and Roadway—
—Aurora Elgin & Chicago Railroad, 459	—Financial 340	—Associations 391
—Central Illinois Traction Co. Near Charleston, 53, 274, 205, 546	—Power Plant 310, 368	—American Government Accountants—
—Detroit Jackson & Chicago Railway at Ypsilanti 546	Albany Street Railway, Track and Roadway 396	—Government Supervision of Railway Accounts, By H. C. Adams, 43
—Fraudulent Claims in Baltimore, 428, 451	Albia Interurban Railway, Track and Roadway 355, 396	—American Railway Engineering and Maintenance of Way—
—Indiana Commission Reports, 185, 603	Alexander, E. F., Single-Phase Railway, Loomis, 478, M. 85, 86	—Maintenance of Way—
—Interborough Rapid Transit Co. Elevated Metropolitan West Side Elevated (Chicago) 619	Allen, Loomis, Practical Views on Trucks for Electric Motor Service, 103	—American Street and Interurban Railway—
—New York City, During April, 1908, 232	Allis-Chalmers Co.—	—Accounting Circular, Tentative Classification of Operating Expenses—
—Philadelphia Rapid Transit Co., 640	—30, 157, 165, 226, 282, 435, 610, 637, 664	—Bulletins 317, 319, 351
—Ontario, Canada, During 1907, 565	—Motor-Driven Tool Grinder, 436	—Executive Committee Meeting, 215, 660
—Prevention of Boston Elevated Railway 186, 246	—Screens, 284	—Executive Committee Meeting—
—Quebec Bridge Disaster, Report on Cause 239	Alton Granite & St. Louis Traction Co.—	—Membership Pamphlet 373
—Recent 23, 52, 243, 275, 306	—Effect of 2-Cent Steam Railway Fare on Traffic 76	—Standing Committees 358
—Reduction of in Omaha, 3129	Alton St. Louis & Cairo Railroad, Incorporated 517	—Statistical Bureau of Information, 19, 460
—South Side Elevated Railroad (Chicago) 460	Amarillo, Tex., Electric Line Opened, 52	—American Street and Interurban Railway Accountants—
—See Also Claims.	Amarillo Street Railway, Semi-Steel Cars 61	—Executive Committee Meeting, 180
Accomac Power & Traction Co., Track and Roadway 55, 247	American Blower Co.—	—Standing Committees 358
Accounting—	—Ventilation of New York Central Power Stations 494	—Index Bureaus 295
—Central Electric Accounting Conference, 142, 185, 211, 275, 473	American Brake Shoe Foundry Co., 343, 552	—American Street and Interurban Railway Engineers—
—Depreciation 823	—New Foundry at Chattanooga, 552	—Executive Committee Meeting, 127, 180
—By C. N. Duffy 523	American Bridge Co. 552	—Standardization Committee—
—By Daniel Royse 508	American Car & Foundry Co. 343, 433	—Asks Data on Cars, 641
—International Traction Co., Buffalo, 342	—Cars, Northwestern Elevated Railroad, 550	—Meeting 590
—Steam Plant 360	American Car Co., Orders, 552, 644	—Standing Committees 325
—Government Supervision of Railway Accounts, By Henry C. Adams, 43	American Cities Railway & Light Co. (New York), Dividends, 370	—American Street and Interurban Railway Manufacturers' 343
—Interstate Commerce Commission Statistics and Accounts, By C. L. Wight 513	American Electric Co., Electrical Engineers, 23, 52, 84, 91, 92, 128, 159, 185, 186, 219, 245, 275, 276, 306, 332, 334, 394, 429, 486, 487, 545, 546, 579, 632	—American Street and Interurban Railway Transportation and Traffic—
—Interstate Commerce Commission System—	American Electric Co., Bonus System, 217	—Organization of, 163, 65, 127, 143, 179
—Abbreviated Classification of Operating Expenses 334, 47	American Light & Traction Co., Financial 164, 369	—Standing Committees 358
—Action by Ohio Commission, 588	American Light Heat & Traction Co., Financial 583	—American Supply and Machinery Manufacturers' 435
—Co-operation of Interstate and State Commissions 532	American Locomotive Co., 29, 60, 165, 400, 433, 520	—Australasian Tramway Officers' Association Organized 181
—Electrical and Gas Corporations, 532	American National Corporation, 99	—Canadian Electrical 394
—Indiana and Ohio Lines, 529	American Railway Appliances Co., 664	—Central Electric Accounting Conference—
—Michigan Railroad Commission Will Not Adopt 439	American Railway Insurance Co., 128	—142, 185, 211, 275, 473, 513
—New Hampshire Railroad Commission's Attitude 474	—Dividends 98, 225, 466, 519, 663	—Central Electric Railway—
—Petition on Behalf of New York State Association 591	—Earnings 98, 225, 466, 519, 663	—38, 325, 362, 379, 516, 596, 645
—Resolutions of New York State Association 378	American Society for Testing Materials, 579	—Classification of Operating Expenses, Resolutions Concerning 379
—Revision of Classification of Operating Expenses, 464, 614, 624	American Steel Foundries, 625	—Standing Committees 327
—Tentative Classification of Operating Expenses, 266, 299, 334, 349, 351, 375	American Telephone & Telegraph Co., 435, 610	—Central Electric Traffic—
—Replies to Circular No. 20, 374, 375, 376, 377, 379, 408, 409, 410, 422, 441, 471, 474, 513, 523, 525, 538, 572, 594	—Power Plant 339	—Organization of, 11, 13, 101, 108, 186
Monthly Coal Statement, United Railways & Electric Co. of Baltimore, 391	—Track and Roadway 25, 188	—Fitchburg & Leominster Street Railway Relief 504
Relation Between Banker and Engineer 372	Amusement Parks, See Parks.	—Ft. Wayne & Wabash Valley Traction Co. Employees' Mutual Benefit Association 647
Uniform System for Electric Lighting Companies 623	Anderson, Ind., Indiana Union Traction Co., Repair Shops 364, 367, 405	—Georgia Railway & Electric Employees' Grand Rapids Electrical Show Association 493
Adams, Henry C., Government Supervision of Railway Accounts 43	Anderson & Athens Electric Railway, Track and Roadway 431	—Iowa Electrical 504
Adams, F. O., Rail & Safety Appliances Co., 435	Anderson Traction Co., Financial 340, 466, 609	—Iowa Street and Interurban Railway, 486
Adams & Westlake Co., 552	Annapolis, Md., Track and Roadway, 337	—Annual Meeting 242
Adreon & Co., 313	Anniston Electric & Gas Co., Track and Roadway 308	—Michigan Electric 460
A Means for Traffic Development, 30	Arc Lamps for Lighting Car Interiors, 453	—Missouri Electric Light, Gas and Street Railway 275, 516
Aurora Elgin & Chicago Railroad, 24	Archbold-Brady Co., 338, 371	—National Electric Light 275, 516
Chicago Railways 24	Ardmore Traction Co.—	—Uniform System of Accounting for Electric Lighting Companies, 623
Central Illinois Traction Company Methods 340	—Rolling Stock 371	—Northwestern Electrical 71
Illinois Traction System, 246	—Track and Roadway 188, 366, 633	—Annual Meeting 128
Indiana Union Traction Co., 246	Argentina Railway, Track and Roadway, 633	—Officers and Employees' Association, Ft. Wayne & Wabash Valley Traction Co., 215
Inland Empire System, Methods of, 211	Arkansas Valley Traction Co., Track and Roadway 221	—Ohio Electric Railway Beneficial 295
Portland Railway Light & Power Co., 576	Armature Beating, Big for 388	—Oklahoma Electric Light, Railway and Gas 394, 657
Promotion of Traffic, By C. F. Price, Station Service 640	—Armature Boxes, Hand Lathes, 409	—Pennsylvania Street Railway, Uniform Accounting System 87
United Railways & Electric Co. of Baltimore, 393, 428, 451, 515, 578	—Armature Disc Notcher, Ferracuto, 401	—Railway Signal 83
Value of, 393, 428, 451, 515, 578	—Armature Repair Shop Methods, 565	—Southwestern Electrical and Gas, 351
Africa, Long-Distance Transmission 315, 331	—Armature Stands 183	—Convention 597
Air Brakes—	—Armature Truck 360	—Question 599
—Automatic Valve Interlock 40	Armstrong, Albert H., Heavy Electric Traction 358	—Street Railway Association of State of New York 306, 330, 350, 429, 460
—National for Chicago Railways Co., 522	Arnois, Alexander, Rolling Stock, 192	—Brief on Accounting Scheme Submitted to Public Service Commission, Second District 501
Air Compressors—	—Report on Capacity of New York Subway 654	—Interurban Rules 91
—National Type 436	—Report on New York Subway Cars, 654	—Resolutions Concerning Tentative Classification 378
—Westinghouse, For Pumping, 166	—Signal and Interlocking System, New York Subway 265	—Technical Publishing 586
Albany Railway & Electric Co., 605	Ashenfelter, H. M., Some Useful Shop Sentences 533	Atha Steel Casting Co., 467
—Incorporated 605	Ashville & Hendersonville Railroad, Track and Roadway 55, 368, 517	—Gears for Electric Traveling Cranes, 592
—Track and Roadway 581, 606		—Athens, La., Track and Roadway, 188
		—Athens & Anderson Electric Railway, Track and Roadway 366

\*An asterisk indicates maps, portraits or other illustrations. †A dagger indicates an editorial.



# ELECTRIC RAILWAY REVIEW

Crane, for Handling Coal.....	270	—Elevated Railroad Traffic.....	186, 308	Cincinnati Newport & Covington Light	466
Crane, United Railways & Electric		—Metropolitan West Side Elevated Rail-		& Traction Co., Dividends.....	59, 466
Company of Baltimore.....	658	way—		Cincinnati Northern Traction Co.—	
Express, Boise & Interurban Railway.....	321	—Accident.....	219	—Limited Service Between Cincinnati and	
Gas-Electric Motor.....	410	—Annual Report.....	169	Dayton.....	129
Hand-Cranked Railways.....	289	—Car Wiring.....	461	—Power Plant.....	57
Indianapolis Crawfordsville & Western		—Employment of Trainmen.....	449	—Track and Roadway.....	55
Traction Co.....	622	—Valves and Governors Under Seats.....	763	Cincinnati Electric Street Railway, Divi-	
Interurban, Choctaw Railway & Light-		Northwestern Elevated Railroad.....	560	dends.....	390
ing Co.....	422	—Evanston Extension Opened.....	630	Cincinnati Wilmington & Xenia Traction	
Mexico, Semi-Steel Cars.....	190	Public Service Commission Proposed.....	90	Co., Incorporated.....	488
Motor and Trail in St. Joseph, Mo.....	386	Railways Advertising Service.....	24	Citizens' Electric Co., Financial.....	191
Motor, Stover.....	228	St. Louis Elevated Railroad.....		Citizens' Electric Street Railway, Divi-	
Motor, Chicago Park Railway.....	454	—Accident.....	460	dends.....	28
New York Subway, Arnold Report.....	256	—Extensions and Improvements.....	269	Citizens' Light & Transit Co., Track and	
Northwestern Elevated Railroad, Chi-		—Increased Expenses.....	167	Roadway.....	606
cago.....	262	—Low Voltage Plans Under Consideration.....	487, 545	Citizens' Traction Co., Dividends.....	636
Oregon Electric Railway.....	260	—Through Routes on Elevated Roads.....	268, 325	City & Elm Grove Railroad, Lower Falls	
Parlor, Mexico Electric Tramways Co.....	747	—Through Routes on Surface Lines.....	325, 335	City & Suburban Electric Railway, Track	
Passenger and Baggage, Waterloo		—Transfer Used on Through Route.....	325	and Roadway.....	549
and Cedar Falls & Northern Railway.....	425	—Union Elevated Loop Service.....	632	Claim Investigator, Successful Qualifica-	
Passenger and Freight, Los Angeles &		Chicago & Joliet Electric Railway—		tions of.....	438, 448, 475, 536,
Redondo Railway.....	445	—Effect of 2-Cent Steam Railway Fare		City Railway, Dayton, O., Dividends.....	28, 567
Passenger Smoking and Baggage, Buf-		on Traffic.....	77	Claims.....	
falo Lockport & Rochester Railway.....	453	—Financial.....	163, 278	—Index Bureau.....	295
Pay-As-You-Enter Cars.....		Chicago & Milwaukee Electric Railroad—		—Methods of Handling, By Arthur W.	
Chicago Railways Co.....	265	—Financial.....		Gross.....	912
Cleveland Electric Railway.....	424	59, 191, 224, 249, 311, 340, 434, 466,	583	Clark Manufacturing Co., Dividends.....	518
International Railway, Buffalo.....	424	—Joint Rates with Steam Roads.....	24, 51	—Lightning Arrester.....	468
Howett Car Co. Design.....	553	—Reversing.....	15, 156	Clark, H. P.—	
Monterey Railway Light & Power Co.		—Track and Roadway.....	548, 606	—Practical Motor Coil Making.....	657
Proposed Design.....	273	Chicago & Oak Park Elevated Railroad—		—Practical Shop Hints.....	25
Public Service Railway of New Jer-		—Annual Report.....	257	Cleveland, O.—	
sey.....	213	—Financial.....	191	—Strike, Municipal Traction Co., 578, 630,	
—Fare Receiver.....	484	—Track Elevation.....	604	Three-Cent Fares.....	573, 757
Semi-Steel, Cincinnati Car Co.....	423	Chicago & Southern Traction Co.—		—Valuation and Merger of Railways.....	
Pittsburg Harmony Butler & New Cas-		—Description.....	352	90, 127, 149, 158,	
tle Railway.....	254	—Rolling Stock.....	281	185, 218, 220, 244, 274, 305, 362, 393,	
Refrigerator, Ft. Wayne & Springfield		—Track and Roadway.....	162	428, 459, 486, 515, 523, 537, 588,	
Railway.....	330	Chicago Bailey Co.....	313	582, 604	
Richmond & Chesapeake Bay Railway		Chicago City Railway—		Cleveland & Indianapolis Interurban Rail-	
Semi-Convertible, Utah Light & Rail-	298	—Annual Report.....	331	way, Track and Roadway.....	462
way Co.....	461	—Car Cleaning and Inspection.....	406, 410	Cleveland Alliance & Mahoning Valley	
Semi-Steel, Amarillo Street Railway.....	161	—Car House.....	313	Railway, Cleveland, O., Track and	
Semi-Steel Semi-Convertible for Mex-		—Car House Records and Terminal		Roadway.....	95
ico.....	114	—Cleaning.....	406, 410	Cleveland Brooklyn & Elyria Rail-	
Single-Deck Without Monitors.....	114	—Cars, Pay-As-You-Enter.....	214	Track and Roadway.....	431, 606
Typical Traction Cars, By Charles A.		—Dividends.....	192, 281	Cleveland Electric Railway—	
Heron.....	151	—Fenders.....	297	—Financial.....	133, 280
Washington, Baltimore & Annapolis		—Financial.....	164, 191, 249, 311, 340, 492	—Pay-As-You-Enter Cars.....	424
Electric Railway.....	251	—Police Expedite Traffic.....	192	Columbus Car and Eastern Traction Co.,	
Water, Oakland Traction Co.....	656	—Thermit Welding.....	447	Incorporated.....	605
Wassler Magazine Co.....	552	—Through Routes.....	265, 325	Cleveland Painesville & Eastern Rail-	
Cassler Magazine Co.....	552	—Track and Roadway.....	221, 431, 462	road—	
Cassville & Western Railway, Track and		Chicago Consolidated Traction Co.—		—Annual Report.....	169
Roadway.....	488	—Financial.....	663	—Contest for Trademark Design.....	395
Catenary Sectionalization.....	80, 84	—Reduction in Fares.....	246	—Effect of 2-Cent Steam Railway Fare	
Catocin & Pen-Mar Railway, Incorporated		Chicago Inland Traction Co., Incorporated	431	on Traffic.....	76
.....	337	Chicago Kanawake & Champlain Electric		Cleveland, Southwestern & Columbus	
Cedar Rapids 2-Cent Steam Railway Fare		Chicago Lake Shore & South Bend Rail-		Railway.....	
on Traffic.....	76	way—		—Effect of 2-Cent Steam Railway Fare	
—Power Plant.....	607	—Cars.....	638	on Traffic.....	75
—Traffic Arrangement with Chicago.....	628	—Description.....	542	—Financial.....	224, 260
Northwestern Railway.....	395, 438	—Dividends.....	249	—Substations.....	682
Census of Electric Railways.....	535	—Rolling Stock.....	371, 520	—Track and Roadway.....	247, 661
Central Arkansas Electric Railways Co.,		—Track and Roadway.....	95, 162, 462	Clubs—	
Track and Roadway.....	247	Chicago-New York Air Line Railroad.....	245	—Employees', Illinois Traction System.....	186, 114
Central Iowa City Railway.....	349	—Receivership.....	305	—Engineers', Philadelphia.....	545
Central Crawford Traction Co., Track		Chicago Peoria & Peoria Railway, Roll-		—Machinery of New York.....	1631
and Roadway.....	130	ing Stock.....	342, 400	—New England Street Railway.....	384, 332
Central Illinois Traction Co., Accident		Chicago Ottumwa & Western Railway—		—New York Railroad.....	389, 579
Report.....	53, 274, 305	—Incorporated.....	431	—Railroad, of New York.....	631
Central Inspection Bureau.....	60, 610	—Financial.....	517	—Suburban Railway.....	275
Central Pennsylvania Traction Co., Power		—Air Brakes.....	522	—Purchase of.....	429
Plant.....	455	—Betterment of Service.....	220	—Weathering of.....	225
Central Railway (Clinton, Ia.), Track and		—Cars, Pay-As-You-Enter Type.....	265	—Tests.....	53
Roadway.....	162	Chicago Union Traction Reorganiza-		Cochise County Electric Railroad, Incor-	
Central Railway (Peoria, Ill.), Electroly-		tion.....	127, 158	porated.....	580
sis Solt.....	264	—Financial.....	369, 468, 492, 519, 609	Columb, R. D. Hand Lathe for Armate-	
Central States Bridge Co.....	134	—Rolling Stock.....	250, 313, 371, 400, 493, 630	ure Boxes.....	*409
Central Texas Traction Co., Track and		—Strike Threatened.....	603, 631	Cole, Adam, Trolley Wheels, Harps and	
Roadway.....	130	—Through Routes.....	325	Poles.....	*385
Centralia & Central City Street Railway,		—Track and Roadway.....	338, 462, 517	Columbia & Walla Walla Traction Co.,	
Rolling Stock.....	493	Chicago South Bend & Northern Indiana		Track and Roadway.....	488
Centralia & Chelalis Railway & Power		Railway—		Columbia, Elkhart & Western Electric	
Co., Track and Roadway.....	188	—Power Plant.....	222	Co., Power Plant.....	549
Chambersburg Greencastle & Waynesboro		—Rolling Stock.....	585	Columbus, Miss., Track and Roadway.....	130
Street Railway—		—Useful Shop Schemes.....	563	Columbus Electric Co., Earnings 133, 342, 609	
—Power Plant.....	190, 222	Chicago to New York by Trolley.....	428	Columbus Delaware & Marion Rail-	
—Rolling Stock.....	337	—Financial.....	97, 609	way—	
—Track and Roadway.....	221, 431, 548	—New Depot Route.....	52	—Financial.....	311
Champlain & Sanford Railroad, Incorporated		Chippewa Valley Electric Railroad, Roll-		—Track and Roadway.....	162, 517
.....	547	ing Stock.....	134	Columbus Magnetic Springs & Northern	
Charleston & Casey Traction Co., Incor-		Chippewa Valley Railway Light & Power		Railway—	
porated.....	641	—Rolling Stock.....	400	—Effect of 2-Cent Steam Railway Fares	
Charleston & Sunnerville Electric Rail-		Choctaw Railway & Lighting Co.—		on Interurban Electric Railway	
way—		—Interurban Cars.....	422	Traffic.....	124
—Financial.....	28, 269	—Rolling Stock.....	134, 493, 552	Columbus Newark & Zanesville Electric	
—Track and Roadway.....	25, 338, 488	Cincinnati O., Track and Roadway.....	606	Railway, Dividends.....	28, 434
Charleston Consolidated Railway Gas &		Chicago Car Co.....		Columbus Railway, Dividends.....	98, 250, 585, 636
Electric Co., Dividends.....	98	—Orders.....	226, 342, 552, 585, 610, 664	Columbus Railway & Light Co.—	
Charleston Railway Gas & Electric Co.,		—Pay-As-You-Enter Car, Semi-Steel.....	423	—Car House.....	134
Power Plant.....	26	—Pay-As-You-Enter Cars, Newark, N. J.....	*123	—Dividends.....	192, 466
Charlotte Electric Railway Light & Power		Cincinnati and Eastern Traction		—Financial.....	191
Co., Track and Roadway.....	297	Co., Incorporated.....	185, 603	—Trail Car Operations.....	*374
Shaw-Shawmut Co.....	282	Chippewa Valley Electric Railroad, Roll-		Columbus Street Railway & Light Co.,	
Shawnee Auxiliary Bond.....	283	ing Stock.....	134	Track and Roadway.....	308
Cherokee Belt & Interurban Railway,		Chippewa Valley Electric Railroad, Roll-		Columbus Urban & Western Electric	
Incorporated.....	296	ing Stock.....	134	Railway, Rolling Stock.....	400, 385
Chester Railway Supply Co.....	371, 493	Chittenden & Vergennes Traction Co.,		Commissions, Railroad—	
Chester Traction Co.....	487, 515, 545, 579, 604	—Financial.....	97, 609	—Illinois.....	
Chicago—		—New Depot Route.....	52	—Annual Report.....	328
—Advertising Methods of Railways.....	24	Chippewa Valley Electric Railroad, Roll-		—Indiana.....	
—Competition Payments of Elevated Loop		ing Stock.....	134	—Accident Reports.....	185, 603

\*An asterisk indicates maps, portraits or other illustrations. †A dagger indicates an editorial.

—Bureau of Inspection.....	109	—Indianapolis Crawfordville & Western Traction Co.....*	617	Des Moines & Sioux City Railway, Track and Roadway.....	247, 548
—Inspection of Interlocking Devices Re- quired.....	52	—Kokomo Marion & Western Traction Co.....*	560	Des Moines City Railway—	
—Interchange of Traffic Between Steam and Interurban Roads.....	128	—New Midge in Indiana.....	123	—Financial.....	311
—Interurban Mileage.....	13	—New York & Haven & Hartford Railroad, New York-Port Chester Electric Line.....	44	—Owl Car Service.....	220
—Investigation of Operating Condi- tions.....	90	—Oregon Electric Railway.....	255, 258	—Pay-As-You-Enter Cars.....	572
—Low Rate to Amusement Park Not Discriminatory.....	25	—Power Plant, Central Pennsylvania Traction Co.....	455	—Power Plant.....	248
—Meeting with Operating Officials of Electric Railways.....	235, 425, 306	—Repair Shops, York Railways Co.....	440	—Rolling Stock.....	520
—Train Operation and Maintenance of Pay Rules.....	394	—South Side Elevated Railroad (Chicago). —Extensions and Improvements.....	269	—Track and Roadway.....	338
—Uniform System of Filing Tariffs.....	160	—Steam Railroad, During 1907.....	17	—Wages.....	159, 276, 334
—Massachusetts—		—Steukenville & East Liverpool Rail- way & Light Co.....	291	Des Moines Interurban Railway, Re- trenches.....	159
—Annual Report.....	33	—Syracuse Lake Shore & Northern Rail- road.....	174	Des Moines Witterset & Craston Electric Railway, Track and Roadway.....	247, 338
—Maintaining Schedules at Charles- town, Mass.....	63	—T-Rail, By Mark Lowd.....	598	Detroit Flint & Saginaw Railway, Finan- cial.....	636
—Springfield, Mass., Fares.....	219	—Track, in 1907.....	13	Detroit Jackson & Chicago Railway, Ac- countant at Ypsilanti.....	546
—Michigan—		Conveyor, Dirt, San Francisco Oakland & San Jose Railway.....	282	Detroit United Railway—	
—Use of Steam Cars by Michigan United Railways.....	516	Cook & Lee, Manufacturing Co.....	826	—Annual Report.....	199
—Will Not Adopt Accounting System of Interstate Commerce Commission.....	439	Coos Bay Gas & Electric Co., Track and Roadway.....	488	—Earnings.....	635
—Minnesota—		Coquille Valley Power Co., Power Plant.....	490	—Effect of 2-Cent Steam Railway Fare on Traffic.....	76
—Jurisdiction over Electric Roads.....	276	Corsica Electric Interurban Railway, Track and Roadway.....	367	—Financial.....	191, 344
—New Hampshire—		Coupler, Automatic, Gibbs.....	391	—Injunction Against Fare Ordinance Dis- obeyed.....	305
—Classification of Operating Expenses, 44 New York Public Service Commission, First District.....	540	Coupling, Hendershot.....	195	—T-Rail.....	48, 663
—Brakes and Peders, Plans for.....	540	Crafts, P. P., Handling Fares on Interur- ban Railways.....	504	—Three-Cent Fare.....	332, 459
—Chart, Interborough - Metropolitan System.....*	294	Crane Co. Pipe Threading and Cutting Machine.....	638	—Ventilation of Cars.....	181
—Coney Island Fare Case.....	516	Cranes—		Diamond State Rapid Transit Co.—	
—Fares.....	307	—Electric Pillar, Northern Engineering Works.....	196	—Rolling Stock.....	520
—Rapid Transit Law, Proposed Changes.....	91	—Jib Type, Oakland Traction Co.....	457	—Track and Roadway.....	462, 517
—Report for Six Months Ended De- cember 31, 1907.....	94	—Creosotes, Grading of.....	1555	Dickinson & Southern Railway, Track and Roadway.....	221
—Service Investigation.....	25, 333, 430, 516, 632, 659	Crocker-Wheeler Co.....	371, 493, 637	Dielectric Manufacturing Co.....	550
—Subway—		Crown Point Ind., Track and Roadway.....	581	—Discipline—	
—Capacity of Arnold Report.....	654	Cumberland Valley Railroad, Rolling Stock.....	462	—Employment of Trainmen, Metropolitan West Side Elevated Railway, Chi- cago.....	449
—Cars, Arnold Report.....	429	Curtain Supply Co.....	352	—Bonus System, American Korean Elec- tric Co.....	217
—New Route Recommended.....	419, 572	Closed Electric Ring.....	549	—Merit System, Ft. Wayne & Wabash Valley Railway.....	197, 215,
—Plans.....	441	Curtis Motor Truck Co., Orders.....	225	—Relations with Employees.....	1167
—Signals, Arnold Report.....	355	D		Dispatching, Telegraph Signal System, By C. F. Button.....	1117
—Work of.....	274, 459	Dallas, Tex., Track and Roadway.....	462	Doble, Robert M., Hydro-Electric Power Development.....	226
—New York Public Service Commission, Second District.....	126	Dallas Consolidated Electric Street Rail- way, Track and Roadway.....	277	Donora & Eldora Street Railway, Track and Roadway.....	221, 548
—Annual Report.....	326	Dallas Electric Corporation, Earnings.....	133	Doors—	
—Brief on Accounting Scheme Sub- mitted by New York State Associa- tion.....	591	Dallas Electric Corporation and Subsidi- ary Companies, Earnings.....	549	—Kinnear.....	166
—Fares.....	307	Dallas Interurban Electric Railway, Track and Roadway.....	247, 548	—Reversible Rolling, Erwood.....	344
—Long Island Fare Case.....	325	Danbury & Bethel Street Railway, Finan- cial.....	609	Dossert & Co.....	50, 165, 251, 282, 343, 403
—Reduced Fares for Students.....	160	Danville Car Co., 60, 165, 281, 342, 371, 400.....	400	—Connectors.....	226
—Service Orders.....	632	—Semi-Steel Cars, Amarello Street Rail- way.....	61	Drake's Branch, Va., Track and Road- way.....	581
—Ohio—		Dartmouth & Westport Street Railway, Dividends.....	585	Dressel Railway Lamp Works.....	492
—Action Concerning Classification of Accounts.....	588	Davenport & Manchester Interurban Rail- way, Track and Roadway.....	462, 488	Droué, G., Co., Rolling Stock & Battery Roadway.....	226
—Personnel.....	128	Dayton & Troy Electric Railway.....	418	Duffy, C. N.—	
—Public Service Commission for Chi- cago Proposed.....	90	—Effect of 2-Cent Steam Railway Fare on Traffic.....	76	—Classification of Operating Expenses.....	419
—Wisconsin—		Dayton & Xenia Transit Co., Financial.....	369	—Depreciation.....	83
—Bargain Issue of Southern Wisconsin Railway Approved.....	45	Dayton Traction & Hoqua Traction Co., Hand Lathe for Armature Boxes.....	409	Duluth Street Railway.....	53
—Commutators, Repairing of.....	183	Dayton Street Railway—		—Earnings.....	192, 584
—Concord Maynard & Hudson Street Rail- way.....	237, 307	—Rolling Stock.....	492	—Office Building.....	456
—Fares.....	307	—Track and Roadway.....	308	—Shelter Stations.....	492
—Financial.....	133, 609	Dearborn Drug & Chemical Works.....	251	Duluth Superior Traction Co., Dividends.....	59, 466
—Materials, Selection of.....	385	Decatur, Ind., Track and Roadway.....	396	Dunville Wellandport & Beamsville Electric Railway, Track and Road- way.....	309, 338
—Reinforced.....	461	DeKalb-Sycamore & Interurban Traction Co., Effect of 2-Cent Steam Rail- way Fare on Traffic.....	75	Dwyer, Dennis, Public Taxation.....	119
—Failures of.....	365	Delaware & Atlantic City Railroad, Financial.....	434	E	
—In Electric Railway Work. By N. M. Stark.....	511	Delaware & Hudson Co.—		Earl, Charles L., Trolley Retriever.....	135
—Tests.....	364	—Electric Railways.....	483	Earnings—	
—Surface Finish, By M. C. Tuttle.....	265	—Financial.....	369	—Electric Railways During Financial Depression.....	405
—Track Foundation, By H. L. Weber.....	121	Delaware Marion Mt. Gilead Mt. Vernon Newark & Southern Coal Tramway Co., Track and Roadway.....	55	—Statistics for 191 Lines During 1907.....	483
Conestoga Traction Co.—		Delaware River & Atlantic City Railroad, Financial.....	311, 341	Edg. St. Louis & Suburban Co.—	
—Advertising Methods.....	327	Delaware Subway Railway Co.....	339	—Dividends.....	98, 519
—Car Houses.....	66, 84	Denneen, Francis S., Insulation of High- Tension Transmission Lines.....	648	—Passenger Duplex Hat Checks.....	456
—Fare Receipts, Prizes for Retaining.....	268	Denver & Interurban Railroad—		East Shore & Suburban Railway, Power Plant.....	163
—Track and Roadway.....	462, 517	—Car House.....	251, 342	Eastern Pennsylvania Railway, Track and Roadway.....	338
Coney Island & Brooklyn Railroad—		—Rolling Stock.....	60, 192, 235	Eastern Railway Construction Co., Track and Roadway.....	338
—Power Plant.....	280, 519	—Track and Roadway.....	183, 221, 367, 462, 548	Eastern Wisconsin Railway & Light Co., Effect of 2-Cent Steam Railway Fares on Traffic.....	129
—Substations.....	131	Denver City Tramway Co.—		Edgemoor Profit from.....	344
Connecticut Co.—		—Financial.....	133	Edgefield & Augusta Electric Railway, Track and Roadway.....	634
—Power Plant.....	368	—Improvements During 1907.....	42	Edmonton Street Railway, Track and Roadway.....	548
—Track and Roadway.....	188, 338, 397, 431, 548, 581	—Trail Car Operation.....	374	Education Address of H. H. Norris at Purdue University.....	173
Connecticut Railway & Lighting Co.—		Deppe, W. P., Possibilities of Electric Railways.....	381	Edwards, O. M., Co., Compression Sash Pins.....	245
—Car Houses.....	400	Des Moines, Ia.—		Eldorado Springs Tiffin Monogay Springs & Lowry City Railroad, Track and Roadway.....	55
—Dividends.....	192	—Franchise Case.....	91, 275	Electric Cable Co.....	193, 343
—Connecticut Valley Street Railway—		—Track and Roadway.....	188	Electric Express Co.....	94
—Car Houses.....	465	—Franchise Case.....	91, 275	Electric Railway Review, Consolidation with Street Railway Journal.....	1587
—Fares Increased.....	430	—Track and Roadway.....	188	Electric Railway Service in Central States, By H. A. Nichol.....	113
—Rolling Stock.....	552	Des Moines, Ia.—		Electric Railways—	
—Consolidated Car Heating Co.....	60	—Franchise Case.....	91, 275	—And the General Public, By E. B. Edwards.....	118
Consolidated Railways Light & Power Co., Method of Making Motor Con- nections.....	273	—Track and Roadway.....	188	—Experimental Trip, New York to Chi- cago.....	1106
Consolidated Traction Co., Dividends.....	28	Des Moines, Ia.—		—Future of the Interurban Road.....	426
—Boise & Interurban Railway.....	320	—Franchise Case.....	91, 275		
—Car House, International Railway.....	476	—Track and Roadway.....	188		
—Car House, United Railways & Electric Co. (Baltimore), at Electric Park.....	232				
—Chicago & Southern Traction Co.....	352				
—Engineering Features, Washington Street Tunnel, Boston.....	655				

—Jurisdiction of Interstate Commerce	77	Fare Box, Tee Registering.....	732	—Accidents, Prevention of.....	308
—Labor Dismissal.....	311	Fare Boxes.....	1436	—Blue Book.....	7317, 4377
—Possibilities of, By W. P. Deppe.....	381	Fares—		—Construction Car.....	1566
—Report of Michigan Commission of		—Atlantic Case.....	25, 365	—Earnings.....	59, 466, 492, 663
—Labor.....	603	—Between Brazil and, Terre Haute, Ind.....	365	—Effect of 2-Cent Steam Railway Fare	
—United Federal Jurisdiction.....	163	—Blue Hill Street Railway Increases.....	433	—On Traffic.....	75
—United States Census.....	535	—Chicago Consolidated Traction Co.....	246	—Employes' Mutual Benefit Association.....	647
Electric Service Supplies Co., Grip Nut.....	227	—Cleveland, Three-Cent.....	1523, 1587	—Financial.....	249
Electric Shocks.....	378	—Coney Island Controversy.....	187, 364, 516	—Merit System.....	119, 215, 653
Electric Storage Battery Co.....	435	—Detroit Utility.....	305, 332, 349	—Officers and Employes' Association.....	215
Electric Traction, Heavy, By A. H. Armstrong.....	358	—Four-Cent, Louisville Railway Co.....	160	—Terminal Station.....	134
Electric Traction Supply Co.....	251	—Five-Cent, Between Council Bluffs and Omaha.....	94	—Welfare Work.....	540
Electrical Exposition International.....	52	—Georia Railway & Electric Co.....	308	—W. L. Williams, Ont., Financial.....	551
Electrical Machinery, Severe Tests, General Electric.....	346	—Handling on Interurban Railways, By P. P. Crafts.....	*504	—Ft. Worth Springtown & Mineral Wells Electric Railway, Track and Roadway.....	463
Electrical Shows—		—Illinois Traction System.....	430	—Ft. Worth Weatherford & Mineral Wells Interurban Construction Co., Track and Roadway.....	221
—Omaha, York.....	186	—Interurban Springtown and Decatur.....	246	—Ft. Worth Weatherford & Mineral Wells Interurban Railway, Track and Roadway.....	162
—Omaha.....	313	—Long Island Railroad.....	516	—Franchise Tax Bill, Ohio.....	148
—St. Louis.....	275	—Low Rate to Amusement Park Not Discriminative.....	25	—Franchises—	
Electrification.....	1373	—Massachusetts, 53, 93, 327, 1256, 272, 307, 355, 364, 429, 430, 437, 439, 487, 1497		—Aberdeen, S. D.....	547
—Mexican Railways.....	404	—Methods of Increasing.....	134	—Beverly, Ga.....	130
—New York Central & Hudson River Railroad, Results Attained.....	300	—Mexico Street Railways.....	*231	—Argenta, Ark.....	547
—New York New Haven & Hartford Branch Lines.....	237	—Minneapolis, Minn.....	307	—Augusta, Ga.....	94, 220
—Saratoga.....	121	—New York and Long Island Traction Co., Reduces.....	335	—Atlantic City, N. J.....	661
—St. Petersburg Street Railways.....	151	—No-Seat No-Fare Ordinance in New York.....	23	—Carlson Sp., N. Y.....	580
—Swedish State Railways.....	1285	—Omaha & Council Bluffs Railway & Bridge Co.....	7614	—Batavia, N. Y.....	220
Electrolysis Suits—		—Omaha & Council Bluffs Street Railway.....	161	—Bellefontaine, O.....	396, 605
—In California (Peoria).....	364	—Portland, Ore., Reduction Contested.....	336	—Berkeley, Cal.....	55, 377
—In Massachusetts.....	306	—Portsmouth & Exeter Street Railway Increases.....	295	—Birmingham, Ala.....	396
Elgin Woodstock & Lake Geneva Railroad, Incorporated.....	462	—Pricing for Electric.....	268	—Bloomfield, N. J.....	25
Elizabethtown & Florin Street Railway, Track and Roadway.....	327	—Pupils' Identification Cards, Public Service Railway, Newark.....	*184	—Bloomington, Ind.....	130
Elkins, W. Va., Track and Roadway.....	361	—Pittsburg Railways Co.....	25	—Bloomington & Normal Railway & Light Co.....	487
Elkins Electric Railroad.....	247	—Reductions Between Toledo and Cleveland.....	186	—Bluefield, W. Va.....	547
Ellend, J. G., Co.....	435	—Registers, Rooke Automatic.....	469, 495	—Bowling Green, O.....	488
Ellwood City, Pa., Track and Roadway.....	309	—Round-Trip Tickets, Illinois Traction System.....	53	—Bridgeport, Ala.....	357
Ellwood City & Wertenburg Electric Railway, Incorporated.....	431	—Springfield (Mass.) Street Railway.....	93	—Brooklyn, N. Y.....	428
Elmira Corning & Waverly Railroad, Track and Roadway.....	548	—Steam Railway 2-Cent, Effect on Interurban Electric Railway Traffic.....	176	—Brownsville, Tex.....	337
Elmira Water Light & Railroad Co.....	899	—St. Louis, N. Y., Track and Roadway.....	165, 75, 124, 176	—Cairo, Ill.....	130
El Paso Electric Co., Earnings, 133, 342, 609		—Students, New York Schools.....	166	—Calgary, Alberta.....	94, 589
El Reno Railway, Track and Roadway.....	431	—Terre Haute Indianapolis & Eastern Traction Co.....	277	—Calumet & South Chicago.....	428
Elyria Southern Railway, Track and Roadway.....	130	—Through Ticket System on Massachusetts Ticket System, Indianapolis & Cincinnati Traction Co.....	*439	—Charlotte, N. Y.....	547
Employes—		—Twin City Rapid Transit Co.....	246	—Chattanooga, Tenn.....	517
—Beneficial Association, Ohio Electric Railway.....	295	—Two-Cent Steam Railway, Pares and Interurban Electric Railway Traffic.....	165, 75, 124, 176	—Cherokee Belt & Interurban Railway.....	661
—Bonne System, American Korean Electric Co.....	217	—United Traction Company of Albany.....	546	—Chesaning, Mich.....	633
—Examination on Illinois Traction System.....	334	—Varely Sayre & Athens Traction Co.....	530	—Cheyenne, Wyo.....	336
—Fitchburg & Lowell Street Railway Relief Association.....	504	Fargo & Moorhead Street Railway, Rolling Stock.....	192	—Chicago, Ill.....	55, 220, 337, 396
—Merit System of Discipline, Ft. Wayne & Wabash Valley Traction Co.....	647	—Fast Run, Inland Empire System.....	126	—Christiana, Pa.....	147
—Mutual Benefit Association, Ft. Wayne & Wabash Valley Traction Co.....	653	—Fayetteville, N. Y., Track and Roadway.....	221	—Cincinnati, Ala.....	220
—Trainmen, Employment of, Metropolitan West Side Elevated Railway of Chicago.....	449	—Chicago City Railway.....	*297	—Colfax, Ia.....	488
—Trainmen on United Railways & Electric Co. of Baltimore.....	515	—Lambert Device Adopted by Portland Council.....	92	—Colorado Springs, Colo.....	633
Employes, See Also Discipline.....		—New York City Lines.....	540	—Columbia, Mo.....	462
—Engineering Agency.....	195	—Worcester Double-Acting.....	*402	—Coryus, Wis.....	356
—Erie Railroad, Rolling Stock.....	192	Ferracute Machine Co., Armature Disc Notcher.....	*401	—Culiacan, Mex.....	130
—Erwood, John, Reversible Rolling Door.....	*344	Findlay-Marion Railway & Light Co., Track and Roadway.....	309, 483	—Dallas, Tex.....	55, 130, 337, 396, 462
—Escanaba Electric Street Railway, Power Plant.....	635	—Fire Hazards.....	1437	—Decatur, Ill.....	220
—Express Service, Springfield (Mass.) Street Railway.....	220	—Fire Protection in Car Houses.....	541	—Defiance, O.....	25
—Essex Valley Land Co., Incorporated.....	483	Fitchburg & Leominster Street Railway—		—Des Moines Case.....	91, 275
—Eunice Lafayette & Abbeville Railroad, Track and Roadway.....	188	—Freight Service.....	277	—East St. Louis, Ill.....	94
—Evansville & Southern Indiana Traction Co., Track and Roadway.....	162, 431	—Exhibitor Compound Co.....	343	—Edmonds, Wash.....	431
—Evansville Henderson & Uniontown Traction Co., Track and Roadway.....	26	—Flexible Mesh Rail Bond Co.....	232	—Elk Lick, Pa.....	431
—Evansville Mt. Carmel & Olney Interurban Railway, Track and Roadway.....	309	—Floor Surfacter, Wattles Electric.....	*403	—El Paso, Tex.....	462
—Evansville, W. Va., Co., Track and Roadway.....	338	—Ford, Bacon & Davis.....	467	—Enid, Okla.....	130
—Evansville Suburban & Newburg Railway, Effect of 2-Cent Steam Railway Fare on Traffic.....	75	—Forestclosures and Receiverships During Forest City Railway—		—Evans, Colo.....	337
—Evansville Terminal Railway—		—Dividends.....	28, 434	—Evansville, Ind.....	547
—Financial.....	583	—Financial.....	435	—Fairbank, Minn.....	661
—Track and Roadway.....	431	—Rolling Stock.....	435	—Farmingdale, L. I.....	580
—Exeter, Exeter & Amesbury Street Railway, Financial.....	249, 341	—Forsyth Brothers Co.....	585	—Flat Rock, Mich.....	366
—Exeter Railway & Lighting Co., Incorporated.....	488	Ft. Dodge Des Moines & Southern Railroad, Financial.....	551	—Gary, Ind.....	308
—Expanded Metal, Permeated, E. B. Co.....	52	Ft. Dodge Des Moines & Spirit Lake Railway, Track and Roadway.....	221	—Gadsden, Ga.....	130
—Express Service—		—Ft. Smith Checotah & Shawnee Interurban Railway—		—Glasgow, Pa.....	247, 308
—Between Springfield, Mass., and Hartford, Conn.....	94	—Incorporated.....	55	—Gresham, Ore.....	161
—Contracts with Electric Lines.....	34, 276	—Track and Roadway.....	367	—Harrisburg, Pa.....	462
F		—Ft. Smith Light & Traction Co.—		—Haverstraw, N. Y.....	220
Fairbanks, Morse & Co., Office Building and Warehouse.....	664	—New Car Construction.....	427	—Houston, Tex.....	130
Fairbanks & Clarkburg Traction Co.—		—Track and Roadway.....	548	—Hummelstown, Pa.....	488
—Financial.....	583	—Ft. Wayne & Springfield Railway—		—Indeterminate.....	
—Power Plant.....	549	—Refrigerator Cars.....	330	—By J. C. Hutchins.....	376, 1405
—Track and Roadway.....	517	—Rolling Stock.....	225	—Indianapolis Frankfort Delphi & Chicago Traction Co.....	547
Fairmont & Waverly Electric Railroad, Track and Roadway.....	489	—Track and Roadway.....	149, 338, 548	—Ithaca, N. Y.....	161
—Track and Roadway.....	489	—Ft. Co. & Wabash Valley Traction Co.....		—Kansas City, Mo.....	161

\*An asterisk indicates maps, portraits or other illustrations. †A dagger indicates an editorial.

—North Yakima, Wash.	327	Georgia Railway & Electric Co.—		Harlan, James S., Jurisdiction of Inter-	
—Oakland, Cal.	330	Dividends	98, 225, 519	state Coasting Commission over	77
—Ocean City, N. J.	247	—Employees' Benefit Association	334	Electric Railways	
—Ogden, Utah	396	—Fare Cases	303	Harrisburg, Pa., Central Pennsylvania	
—Oshkosh, Wis.	488	—Financial	191, 280	Traction Co., Power Plant	455
—Oxnard, Cal.	661	—Rolling Stock	192	Harrisburg Electric Railway	225
—Paducah, Ky.	661	Gibbs, W. A.		Harrison, F. P., Electric & Manufactur-	611
—Pavilion, N. Y.	547	—Automatic Couplers	391	ing Co.	343
—Perry, N. Y.	458	—Train Indicating Device	521	Hartford & Springfield Street Railway,	
—Phoenix, Ariz.	580	(Gidden) Varnish Co.	98	Havana Electric Railway	583
—Piedmont, Md.	150	Globe Ticket Co., Improved Forms of		Hartshorn, Stewart	165
—Pittsburg, Pa.	661	Tickets	92	Hattiesburg Traction Co.—	
—Portland, Ore.	130, 366, 488, 580,	Glue Pots, Electrically Heated, West-		—Power Plant	397
—Pueblo, Colo.	366	inghouse	*284	—Track and Roadway	397
—Racine, Wis.	487	Goble, F. C., Car Building, Los Angeles		Havran Electric Railway	397
—Redding, Cal.	366	& Redondo Railway	445	—Dividends	399
—Redlands, Cal.	188, 547, 605	Goldschmidt Thermit Co.	556	—Financial	311, 551
—Richmond, Cal.	462	Goose Creek Railway & Power Manufac-		Hazelhurst, Miss., Track and Roadway	463
—Sacramento, Cal.	661	turing Co.		Headlight, Arc, Trolley Supply Co.	611
—St. Louis, Mo.	308, 431	—Incorporated	396	Heaters, Smith	*183
—Salt Lake City, Utah	130, 462	—Power Plant	529	Heath & Milligan Manufacturing Co.	664
—San Diego, Cal.	188	—Track and Roadway	241	Heating, Hot Water, Cost of	166
—San Francisco, Cal.	188, 517	Governor, R. C., Railway Accounts	43	Hecht, J. L., Steam Turbines	125
—Seattle, Wash.	337, 547	Grafon Street Railway, Track and Road-		Heckel, G. B., Paints, Oils	496
—Sheboygan, Ill.	130, 188, 277	way	309	Heron, Charles A., Typical Traction Cars	*151
—Shreveport, La.	396	Grafton Traction Co., Track and Road-		Hicks Car & Locomotive Works, 193, 313, 342	
—Springfield, Ill.	547	way	209	Hinstorf, D. C., Description of Chicago	
—Stockton, Cal.	605	Grand Central Traction Co.—		Holyoke Street Railway—	*352
—Streator, Ill.	25	—Rolling Stock	493, 520	—Dividends	28
—Summerville, S. C.	366	—Track and Roadway	221, 517	—Fares	364
—Taylorville, Ill.	366	Grand Green, Mich., Track and Road-		—Financial	191, 399
—Terre Haute, Ind.	517, 605	way	338	Honolulu Rapid Transit & Land Co.,	
—Toledo, O.	308, 396	Grand Junction, Colo., Track and Road-		Financial	551
—Tolleston, Ill.	308	way	489	Hopkinson, R. L., Track and Roadway	189
—Vancouver, Wash.	308	Grand Rapids Electric Railway, Track		Hose Bridge, Philadelphia Rapid Transit	*302
—Walla Walla, Wash.	220, 488	and Roadway	189,	Houghton County Street Railway—	
—Washington, D. C.	94, 130, 396	Grand Rapids Grand Haven & Muskegon		—Dividends	370
—Wenatchee, Wash.	396	Railway		—Earnings	164, 370, 670
—Weston, Or.	547	—Comparison with Steam Roads	160	—Power Plant	399
—Wilmington, Del.	366, 661	—Effect of 2-Cent Steam Railway Fare	76	—Track and Roadway	309
Frankfort Delphi & Northern Traction		Grand Rapids Holland & Chicago Rail-		Hudson & Long Island Traction Co.—	
Co., Track and Roadway	189	—Effect of 2-Cent Steam Railway Fares	124	—Incorporated	462
Franklin, Pa., Track and Roadway	377	—Handling Intoxicating Liquors	546	—Track and Roadway	548
Franklin & Townensing Street Railway,		Grand Rapids Railway—		Hudson & Manhattan Railroad—	
Track and Roadway	162, 367	—Dividends	225, 281, 519	—Hudson River Tunnels	*240
Freeborn Engineering & Construction Co.	400	—Parks	*515	—Signal Equipment	292
Frestman & Sons Manufacturing Co.	165	—Ramona	52	Hudson Companies—	
Freeport, Ill., Track and Roadway	248	Grand Trunk Railway—		Financial	191, 399
Freight, Fitchburg & Leominster Street		Sarna Tunnel		—Rolling Stock	192
Railway	277	—Electric Locomotives	306	—Tunnel Under Hudson River	23
Freight Rates, See Rates, Freight.		Grand Valley Railway—		Hudson Valley Railway, Financial	584
French Point Street Railway, Track and		—Description	*177	Humphrey Traction & Manufacturing Co.	610
Roadway	55	—Financial	97	—Wobbe, Trolley Wheel	*402
Fresno Traction Co., Track and Roadway	55	—Rolling Stock	60	Hunt, Robert W. & Co.	60, 193, 552
Fruita Land & Power Co.—		—Track and Roadway	55, 463	Huron (S. D.) Gas & Electric Railway,	
—Incorporated	208	Granger, Wash., Track and Roadway	95	Track and Roadway	581
—Power Plant	310	Graphic, Lubricating, U. S. Graphic		Hutchings, J. C., Indeterminate Fra-	
Fuel, Coal Tests	53	Co.	137	ctions	376, 1405
Fulton Ferry Railway, New York, Finan-		Gray's Harbor Railway & Light Co.—		I	
cial	609	—Financial	349	Idaho Oregon & Washington Electric	
Fundy Park Amusement Co., Track and		—Power Plant	368	Railway, Track and Roadway, 189, 431	
Roadway	547	—Track and Roadway	367	Idaho Washington & Oregon Traction	
Funerai Car Service in Mexico	326	Grayson Electric Corporation, Track and		Co., Power Plant	607
		Roadway	189	Illinois Central Electric Railway	
		Great Northern Railway, Power Plant	371	—Rolling Stock	165, 281
		Green Engineering Co.	371	—Track and Roadway	309, 517, 606
		Green Fuel Economizer Co., Economizer		Illinois Traction Co.	519
		Practice	344	—Financial	634
		Greenhill & Carolina Railway—		Illinois Traction System—	
		—Power Plant	582	—Advertising Methods	*626
		—Track and Roadway	581	—Baggage and Express	546
		Griffin Double Tread Car Wheel Co.	552	—Contract with U. S. Express Company	276
		Grimes, E. B., Electric Railways and	118	—Effect of 2-Cent Steam Railway Fare	
		Tramways	118	on Traffic	75
		Grip Nut	*227	—Employees' Club	114
		Gross, Arthur W., Methods of Handling		—Fares	480
		Claims by Electric Railways	512	—Mail Service	187
		Guadalajara, Mexico—		—Rates Between Springfield and Deca-	
		—Power Plant	635	tur, Ill.	246
		—Track and Roadway	309	—Rolling Stock	313, 371
		Guadalajara Railway Light & Power Co.,		—Round-Trip Tickets	371
		Power Plant	464	—Terminals	165
		Guelph Radial Railway, Track and Road-		—Theater Car	336
		way	130	—Through Service, Danville to Spring-	
		Guthrie, Ira E., Classification of Operat-		field	54
		ing Expenses	408	—Track and Roadway	131, 248, 338, 397
		H		—Trainmen's Examination	275, 334
		Habirsham Wire Co.	60	Illinois Tunnel Co.	93
		Hagerman, Idaho, Power Plant	549	—Electric Locomotives for Chicago Tun-	
		Hagy, J. Milton, Waste Works, G. E.	611	nel	*495
		Motor	611	—Railway Connections	395
		Hamilton Radial Electric Railway, Track		Illinois Valley Railway, Rolling Stock	
		and Roadway	162	Improved Automatic Air Brake Co.	281, 342
		Hamilton Street Railway, Car Houses	193	Indiana, Annual Report on Electric Rail-	193
		Hancock, E. L., Flat Spots on Car and		roads	388
		Locomotive Wheels	242	Indiana County Traction Co., Rolling	
		Hancock & Lake Linden Traction &		Stock	165
		Power Co., Incorporated	220	Indiana Engineering Society, Annual	
		Hanford Electric Railroad, Track and		Convention	123
		Roadway	338	Indiana Malleable Casting Corporation,	
		Hanover & McSherrystown Street Rail-		Indiana Union Traction Co.—	
		way, Hanover, Pa., Track and		—Advertising Methods	246
		Roadway	95, 489,	—Crossing Sign Post	*359
		606		—Effect of 2-Cent Steam Railway Fare	
		Hanover, N. York Railway—		on Traffic	76
		—Description	*288	—Financial	249, 311
		—Track and Roadway	95	—Monthly Magazine	461
		Hardy, F. T., Merit System of Discipline,		—Passenger Station	193
		Ft. Wayne & Wabash Valley Traction		—Purchasing Ties	303
		Co.	653	—Recutting Pinions	*451

\*An asterisk indicates maps, portraits or other illustrations. †A dagger indicates an editorial.



—Repair Shops, Anderson, Ind., 464, \*67, 105  
 —Rolling Stock, 29, 98, 192  
 —Strike, 23, 51, 128, 244, 307  
 —Thermite Welding, 447  
 —Through Trip Between Chicago and Indianapolis, 633  
 Indianapolis & Cairo Traction Co., Track and Roadway, 26  
 Indianapolis & Cincinnati Traction Co.—  
 —Financial, 341  
 —Ticket System, \*241  
 Indianapolis & Louisville Traction Co.—  
 —Financial, 133  
 —Track and Roadway, 56  
 —Twelve Hundred-Volt System, 389  
 Indianapolis & South Bend Traction Co.—  
 —Incorporated, 221  
 —Track and Roadway, 431, 634  
 Indianapolis Cloverdale & Terre Haute Traction Co.—  
 —Incorporated, 488  
 —Track and Roadway, 517, 661  
 Indianapolis Columbus & Southern Traction Co.—  
 —Effect of 2-Cent Steam Railway Fare on Traffic, 75  
 —Power Plant, 432  
 —Track and Roadway, 278  
 Indianapolis Crawfordsville & Western Traction Co.—  
 —Description, \*617  
 —Effect of 2-Cent Steam Railway Fare on Traffic, 75  
 —Track and Roadway, 548  
 Indianapolis Frankfort & Chicago Traction Co., Incorporated, 580  
 Indianapolis Huntington Columbia City & Northwestern Traction Co.—  
 —Financial, 191  
 —Track and Roadway, 189  
 Indianapolis Newcastle & Toledo Electric Railway, Track and Roadway, 431  
 Indianapolis Switch & Frog Co., 313  
 Indianapolis Traction & Terminal Chicago City Payments, 93  
 Inland Empire System—  
 —Advertising Cards, \*211  
 —Fruit Growers' Special, 461  
 —Recon Run, 129  
 Insulating Varnishes and Compounds, 46  
 Insulation, High-Tension Transmission Lines, By Francis S. Denneen, \*648  
 Insulation—  
 —Ohio Brass Trolley Section, 4136  
 —Strain, Western Electric, 195  
 —Suspended, 134  
 Insurance, American Railway, 51  
 Insurance Co. Organization, 128  
 Interborough Metropolitan Co., Financial, 164, 249, 311, 519, 609  
 Interborough Metropolitan System, Chart Showing Controlled Companies, \*294  
 Interborough Rapid Transit Co.—  
 —Accident, 159  
 —Brooklyn Subway Extension Opened, 578  
 —Brooklyn Tunnel Opened, 531  
 —Dividends, 342  
 —Financial, 191, 280, 341, 369, 434, 466, 551  
 —Rolling Stock, 250, 400  
 —Subway Car, Arnold Report, \*255, 367  
 —Track and Roadway, 287  
 Interlake Railroad, Chicago, Ill., Incorporated, 492  
 Interlocking, Inspection of Plants Required, Indiana, 52  
 Intermountain Railway, Track and Roadway, 131  
 International Railway (Buffalo)—  
 —Car House, 476  
 —Cars, Pay-As-You-Enter Type, \*37, 453  
 —Financial, 224, 663  
 —Rolling Stock, 400  
 International Traction Co. (Buffalo)—  
 —Financial, 472  
 —Depreciation, 399  
 International Traction System (Buffalo), Annual Report, 439  
 Interstate Commerce Commission—  
 —Accounting System—  
 —Action by Ohio Railroad Commission, 588  
 —Co-operation with State Commissions, 87  
 —Electrical and Gas Corporations, 529  
 —Indiana and Ohio Lines, 529  
 —Michigan Railroad Commission Will Not Adopt, 439  
 —New Hampshire Railroad Commission's Attitude, 474  
 —Petition on Behalf of New York State Association, 591  
 —Resolution of New York State Association, 378  
 —Revision of Classification of Operating Expenses, 464, 624  
 —Tentative Classification of Operating Expenses, 266, 299, 437, 531  
 —Fines to Circuit, 374, 375, 376, 377, 379, 408, 409, 419, 442, 444, 471, 471, 513, 525, 525, 558, 572, 594  
 —Electric Roads Under Federal Jurisdiction, 763  
 —Fare Reduction, Omaha & Council Bluffs Street Railway, 161  
 —Interchange and Joint Rates Ordered, 395  
 —Jurisdiction over Electric Railways, By James S. Harlan, 77

—10-Cent Fare, Omaha & Council Bluffs Railway & Bridge Co., 764  
 —Through Routes and Joint Rates, 395, 448  
 Interstate Consolidated Street Railway, Track and Roadway, 581  
 Interstate Electric Railway, Track and Roadway, 218, 463  
 Interstate Railways Co., Financial, 59, 431  
 Interstate Traction Co., Jersey City, N. J., Incorporated, 366  
 Interurban Construction Co., Track and Roadway, 397  
 Interurban Express Co., Existence Terminated, 246  
 Inter-Urban Railway (Des Moines)—  
 —New Wage Scale, 362  
 —Track and Roadway, 189, 248  
 —Financial, 191  
 —Power Plant, 490  
 —Rolling Stock, 610  
 —Substation, 607  
 Inter-Urban Road, Future, 286  
 Iowa Portland Cement Co., 619  
 Iowa & Illinois Railway—  
 —Effect of 2-Cent Steam Railway Fares on Traffic, 124  
 —Handling Fares, \*504  
 Iowa & Northwestern Railway, Track and Roadway, 309  
 Iowa Railroad, Track and Roadway, 489, 491  
 Irwin, Pa., Track and Roadway, 489  
 Irwin & Herminie Street Railway, Incorporated, 366  
 Iwan Brothers, 467  
 J  
 Jacks, Machine for Testing, 156  
 Jackson, Mich., Michigan United Railways, Gates, 326  
 Jacksonville, Tex., Track and Roadway, 338, 431  
 Jacksonville Electric Co.—  
 —Dividends, 59  
 —Earnings, 133, 370, 609  
 —Power Improvements, 407  
 —Remodeling Power Station, \*589  
 —Rolling Stock, 98  
 —Track and Roadway, 414, 431  
 —Woodclair & Woodland Traction Co., Track and Roadway, 581  
 Jefferson Interurban Railway—  
 —Incorporated, 366  
 —Track and Roadway, 277  
 —Jennings, William, C., 251  
 Jersey Central Traction Co.—  
 —Rolling Stock, 616  
 —Track and Roadway, 518  
 Jersey City, N. J., No-Seat No-Fare Ordinance, 23  
 Jewett Car Co.—  
 —Cars, Elevated, Brooklyn Rapid Transit Co., \*171  
 —Cars, Pay-As-You-Enter, \*553  
 —Orders, 29, 98  
 —Johns-Manville, H. W. Co., 60, 165, 226, 585  
 —Exhibit at Chicago Electrical Show, 138  
 Johnson, P. W., Talks with the Claim Investigator, 448, 475, 536, 567  
 Johnstown, Pa., Track and Roadway, 463  
 Johnstown Passenger Railway—  
 —Dividends, 434  
 —Track and Roadway, 95, 277  
 Joliet & Southern Traction Co., Track and Roadway, 56, 277, 463, 371  
 Joplin, Mo., Chicago Railway, Track and Roadway, 463, 489, 518, 661  
 Journal Packing, Steel Wool, \*227  
 Joyce-Cridland Co., Machine for Testing Jacks, \*196  
 Juniata Valley Electric Street Railway, Track and Roadway, 606  
 K  
 Kalamazoo Elkhart & South Bend Traction Railroad, Track and Roadway, 131, 489  
 Kalamazoo Railway Supply Co., 193  
 —Rolling Stock, Scraper, 612  
 Kansas City, Mo.—  
 —Public Utilities Commission Proposed, 159  
 —Track and Roadway, 432  
 Kansas City & Bonner Springs Railway, Track and Roadway, 634  
 Kansas City & Kansas Southwestern Electric Railway, Incorporated, 337  
 Kansas City & Olathe Electric Railway, Track and Roadway, 548  
 Kansas City & Southeastern Railroad, Track and Roadway, 432  
 Kansas City Railway & Light Co.—  
 —Dividends, 250, 632  
 —Earnings, 28, 192, 342, 584  
 —Financial, 191  
 —Track and Roadway, 548, 581  
 Kansas City St. Joseph, Excelsior Springs, Electric Railway, Track and Roadway, 309  
 Kansas City Springfield & Southern Railway, Track and Roadway, 56, 548, 606  
 Kansas-Colorado & Railroad Co., Track and Roadway, 581, 634

Kansas Southern Electric Railway, Track and Roadway, 56  
 Kansas Traction Co., Track and Roadway, 548  
 —Wagon, 163, 548  
 Kenora, Ont., Track and Roadway, 189  
 Kentucky & Ohio River Interurban Railway, Track and Roadway, 432, 489, 606  
 Kingston, Consolidated Railroad Co., Track and Roadway, 131  
 Kinneair Manufacturing Co., Steel Rolling Doors, 166  
 Knoxville Railway & Light Co.—  
 —Dividends, 466  
 —Earnings, 636  
 —Track and Roadway, 26  
 Kokomo Frankfort & Terre Haute Traction Co.—  
 —Incorporated, 661  
 —Track and Roadway, 221, 463  
 Kokomo Marion & Western Traction Co.—  
 —Description, \*560  
 —Effect of 2-Cent Steam Railway Fare on Traffic, 75  
 —Kuhlman, G., Car Co., 75  
 —Cars, Pay-As-You-Enter, International Railway of Buffalo, \*37  
 —Orders, 192, 313, 400, 520, 552  
 L  
 Lackawanna & Wyoming Valley Railroad, Third-Rail Street Brush, \*185  
 Lackawanna & Wyoming Valley Rapid Transit Co., Financial Co., 370  
 Laconia Car Co., Elevated Cars, Brooklyn Rapid Transit Co., \*171  
 La Crosse City Railway, Track and Roadway, 432  
 Lake City, Ia., Track and Roadway, 95  
 Lake Erie & Youngstown Railway—  
 —Rolling Stock, 664  
 —Track and Roadway, 606, 624  
 Lake Erie, Bowling Green & Napoleon Railway, Track and Roadway, 26, 548  
 Lake Shore Electric Railway—  
 —Annual Report, 169  
 —Reduced Fares Between Toledo and Cleveland, 186  
 —Track and Roadway, 56, 131, 432  
 Lake View Traction Co., Track and Roadway, 131, 278, 548  
 Lamps, Arc, for Car Interiors, \*286, \*318, \*453  
 Lamps, Locking Socket for, \*102  
 Lancaster & York Furnace Street Railway, Track and Roadway, 280  
 Lancaster County Railway & Light Co., Track and Roadway, 26  
 Laurel Railway, Incorporated, 547  
 Lawrence County Railroad, Rolling Stock, 250  
 Lawson, F. A., & Co., 343  
 Lawson & Simons, 313  
 Lawson Denton & Dallas Electric Railway, Track and Roadway, 367  
 Lederachville & Pennsburg Traction Co., Track and Roadway, 367  
 Lefebvre, A. H., Single-Truck Cars Without Monitor, \*144  
 Legal Decisions, Recent Electric Railway, By J. L. Rosenberger, 21, 49, 88, 443, 374, 443, 444, 536, 606, 629  
 Legal Decisions, See Also Special Department of Index.  
 Legislation—  
 —District of Columbia, 158, 244, 274, 363, 545, 545  
 —Maryland, 369, 429  
 —Massachusetts, 369, 429  
 —New Jersey, 127, 158, 218, 306, 334, 394, 429  
 —New York, 90, 127, 218, 244, 274, 306, 334, 363, 394, 429, 460, 486, 515, 545  
 —Ohio, 30, 158, 185, 218, 240, 266, 334, 364, 394, 429, 460, 486, 515, 545  
 —Ontario, Can., 306  
 —Virginia, 127, 186, 274  
 Lehigh Valley Transit Co.—  
 —Financial, 37, 370  
 —Rolling Stock, 467, 493, 637  
 —Lewis, Charles S., & Co., 493  
 —Lewis, Myron H., & Clifford B. Moore, 60  
 Lewiston Augusta & Waterville Street Railway—  
 —Power Plant, 368  
 —Substations, 96, 248  
 Lexington & Interurban Railways Co., Earnings, 159, 466, 519  
 Lighting, Car, with Arc Lamps, \*326, \*318, \*453  
 Lightning Arrester, Clark, \*183  
 Lima & Honeyoe Electric Light & Railroad—  
 —Power Plant, 57  
 —Track and Roadway, 309, 548  
 Lima & Toledo Traction Co., Track and Roadway, 221, 309  
 Limited Service—  
 —Between Cincinnati and Dayton, 129  
 —Ohio Electric Railway, 34  
 Lincoln Traction Co., Dividends, 519  
 Lindsley Brothers Co., 165  
 Little Falls, Minn., Track and Roadway, 378  
 Little Falls, N. Y., Track and Roadway, 131  
 Little Rock, Ark., Chicago Electric Railway, Track and Roadway, 548, 581

\*An asterisk indicates maps, portraits or other illustrations. †A dagger indicates an editorial.

Little Rock & Pine Bluff Traction Co.— —Rolling Stock .....	29	—Delaware & Hudson Co., Electric Rail- ways .....	483	Milner & Northside Electric Railway, Track and Roadway .....	35, 463, 606
—Track and Roadway .....	162	—Grand Valley Railway .....	177	Milwaukee, Wis., Track and Roadway ..	95
Little Rock-Pine Bluff Transit Co., Track and Roadway .....	489	—Haver & York Railway .....	218	Milwaukee & Fox River Valley Railroad, Track and Roadway .....	278, 581, 634
Little Rock Railway & Electric Co., Financial .....	492	—Indianapolis Crawfordsville & Western Traction Co. ....	687	Milwaukee Coke & Gas Co., Rolling Stock .....	134
Locomotives— —Combination Freight and Switching, Los Angeles & Redondo Railway .....	446	—Interurban Railways, Central States— Columbia Marion & Western Traction Co. ....	560	Milwaukee Electric Railway & Light Co. ....	98, 519
—Illinois Tunnel, Chicago .....	445	—New Subway Route, New York City ..	52	—Financial .....	164, 191
Logansport & South Bend Traction Co., Incorporated .....	488	—Oregon Electric Railway .....	258	—Power Plant .....	368
London Street Railway, Financial .....	312	—Washington Baltimore & Annapolis Electric Railway .....	2,200	—Track and Roadway .....	56, 248
London Underground Electric Railways, Financial .....	551	Marion Bluffton & Eastern Traction Co., Rolling Stock .....	585	—Financial .....	164
Long Island Railroad— —Fares .....	516	Market Street Elevated Railway— —Financial .....	312	—Power Plant .....	582
—Track and Roadway .....	662	—Signals .....	422	—Track and Roadway .....	606
Lorain Steel Co. ....	520	Marlam Construction Co., Incorporated ..	366	Milwaukee Northern Railway— —Rolling Stock .....	192
Lord Electric Co., .....	98, 99, 135	Marquette County Gas & Electric Co.— —Power Plant .....	131	—Track and Roadway .....	518
Los Angeles, Cal.— —Pacific Electric Railway, Station at Monrovia .....	595	—Track and Roadway .....	489	Minneapolis, Minn., Twin City Rapid Transit Co., Annual Report .....	287
Los Angeles & Port Orient Railway, Track and Roadway .....	548	Marshall & Co. ....	581, 634	Minneapolis St. Paul Rochester & Du- quette Traction Co., Track and Roadway .....	95, 288
Los Angeles & Redondo Railway— —Car Building .....	445	Maryland Electric Railways Co.— —Financial .....	224, 609	Minnesota Steel & Machinery Co., Minnesota Construction Co., Track and Roadway .....	548
—Locomotive, Combination Freight and Switching .....	446	—Track and Roadway .....	548	Mississippi Valley Electric Railway ..	634
—Rolling Stock .....	225	Marland Railway & Electric Supply Co., Maryland Railway Supply Co. ....	371	Mississippi Valley Interurban Railway, —Incorporated .....	188
Los Angeles & San Francisco Short Line Electric Railroad, Track and Roadway ..	463	—Fares, 53, 93, 94, 219, 237, 256, 272, 307, 325, 355, 394, 429, 430, 1437, 477, 1197, 605 .....	605	—Rolling Stock .....	467
Los Angeles Pacific Co., Track and Roadway .....	162, 248	—Wrecking Jacks .....	155	Missouri & Kansas Traction Co., Track and Roadway .....	371
Los Angeles Railway .....	543	Massachusetts Chemical Co., Massachusetts Electric Companies, Finan- cial .....	125, 193, 28, 370	Missouri Oklahoma & Gulf Railway, Track and Roadway .....	121
—Power Distribution, Feeder Loop .....	543	Massillon Southern Railway, Track and Roadway .....	431	Mitsukuni, M. Co., Orders .....	192
—Temple Marker .....	543	Massillon Wooster & Mansfield Traction Co., Rolling Stock .....	256	Mobile Light & Railroad Co.— —Improvements During 1907 .....	88
—Track and Roadway .....	56, 367	—Track and Roadway .....	431	—Track and Roadway .....	278
Louisiana Light, Power & Traction Co., Louisiana, Mo. ....	463	Matamoros & Santa Cruz Railway, Track and Roadway .....	278	Mogholon, N. M., Track and Roadway ..	520
Louisville & Eastern Railroad, Track and Roadway .....	263	Mattoon City Railway, Rolling Stock .....	275	Moline Incandescent Lamp Co., Monitors, Single-Track Cars Without, Black River Traction Co. ....	1139, *144
Louisville & Portland Railroad, Track and Roadway .....	463	Mattoon City Railway, Pana & Hillsboro Traction Co., Track and Roadway ..	489, 581	Monterey, Cal., Track and Roadway .....	239
Louisville & Northern Railway & Light- ing Co.— —Dividends .....	166	Meade, Norman G., Armature Repair Shop Methods .....	565	Monterey Railway Light & Power Co., Pay-As-You-Enter Cars .....	226
—Station .....	193	Medical Aid Lock .....	141, 162	Montgomery & Chester Electric Railway, Track and Roadway .....	432
Louisville & Southern Indiana Traction Co., Rolling Stock .....	434	Memphis Covington & Northern Rail- road, Track and Roadway .....	338	—Incorporated .....	337
Louisville Railway— —Annual Report .....	257	Memphis Street Railway, Dividends .....	466	—Track and Roadway .....	489
—Financial .....	164, 250	Memorise & Marinette Light & Traction Co. ....	662	—Rolling Stock .....	281, 406
—Cent Fares .....	160	—Financial .....	662	—Track and Roadway .....	358
—Improvements in Service .....	54, 93	—Power Plant .....	607	Montreal & Southern Counties Electric Railway, Track and Roadway .....	489
—Power Plant .....	339	Mentzel, H. F., Shop Practice, Allegheny Valley Street Railway .....	*10	Montreal Street Railway— —Dividends .....	98, 519
—Strike-Breaking .....	184	Metaline Rapid Transit Co., Track and Roadway .....	338	—Earnings .....	133, 281, 466, 584
—Track and Roadway .....	338, 581	Meters— —Dicto Portable .....	251	—Financial .....	294
Louisville Traction Co.— —Dividends .....	391	—Weston Electrical Instrument Co. ....	461	—Rolling Stock .....	192
—Financial .....	341	Metropolitan Street Railway (Kansas City), Service Investigation .....	219	Moorhead, Minn., Track and Roadway ..	95
Lowd, Mark, T-Rail Track Construction ..	*598	Metropolitan Street Railway (New Chicago)— —Financial .....	224, 312, 399	Morganston, Kan., Park Valley Electric Railway, Track and Roadway .....	292
Lovel & Fitchburg Street Railway, Track and Roadway .....	229	—Investigation, Grand Jury Report .....	514	Morrisburg Electric Railway, Track and Roadway .....	397
Lubricator, .....	*303	Metropolitan West Side Elevated Railway (Chicago)— —Accidents .....	219	Motormen Admitted to Brotherhood of Locomotive Engineers .....	632
Lucas, John, & Co. ....	520	—Annual Report .....	169	Motor Oil Cup Lid .....	*328
Lufkin Rule Co. ....	585	—Automatic Interlock .....	40	Motor Starter Boxes, Westinghouse .....	*404
—Plant .....	*315	—Car Wiring .....	*601	—Brush-Holder Troubles .....	1347
Lumber, Baines, Harwood Lumber Co., Lumen Bearing Co., .....	135, 165	—Employment of Trainmen .....	449	—Series Repulsion .....	*78, 84, 85, 56
Lysall, W. R., Painting Poles Near Switches .....	640	—Financial .....	49, 663	Mt. Hood Railway & Power Co.— —Rolling Stock .....	342
Lynchburg Traction & Light Co., Finan- cial .....	97	—Valves and Governors Under Seats .....	763	—Power Plant .....	432

M

McCarty, Lewis P., Shop Practice, Tampa Electric Co. ....	*290	Mexico— —Electrification of Railways .....	404	Mt. Vernon Railway & Light Co., Finan- cial .....	56
MacGovern, Archer & Co. ....	467	—Furner Car Service .....	404	—Track and Roadway .....	192
McGure-Cummings Manufacturing Co., Cars, Aurora Elgin & Chicago Rail- road .....	520, 178	—Sight-Seemz Car Service .....	*326	Mt. Vernon Street Railway .....	466
—Cars, Combination Passenger and Bag- gage, for Waterloo Cedar Falls & Northern Railway .....	425	Mexico Electric Tramways Co., "Seeing Mexico" Parlor Car Service .....	*47	Mt. Vernon Traction Co., Engineer .....	610
—Orders .....	38, 250, 371, 425	Mexico Parlor Car Service .....	47	Municipal Journal .....	245
—Miner, Tenn., Track and Roadway ..	367	—Track and Roadway .....	222, 338, 463	Municipal Traction Co.— —Power Plant .....	518
Macon Railway & Light Co.— —Financial .....	250	Mexico Street Railways, By T. J. Nich- ols .....	*231	—Rolling Stock .....	610, 637
—Track and Roadway .....	162	Meyer, B. H., Public Service Laws of Wisconsin .....	459	—Strike .....	578, 630, 660
Magnets and Solenoids, Porter Manufac- turing Co. ....	253	Meyers, William J., Indeterminate Fran- chises .....	473	Muncie & Portland Traction Co., Elec- tion of 2-Cent Steam Railway Fares on Traffic .....	176
Mahoning & Shenango Railway & Light Co.— —Rolling Stock .....	192	Meyersdale Salisbury Street Railway, Financial .....	164	Mural & Co., .....	343
—Track and Roadway .....	489	Michigan, Electric Railways, Report of Commission of Labor .....	602	Murdoch, .....	380
Mail Service, Illinois Traction System ..	187	Michigan United Railways Co.— —Effect of 2-Cent Steam Railway Fares on Traffic .....	124	Murphyshoro Electric Railway Light Heat & Power Co., Rolling Stock .....	493
Manchester, Derry Street Railway, Financial .....	250	—Gatenem .....	326	Murphyshoro Street Railway Light Heat & Power Co., Track and Roadway ..	489, 549
Manchester (Kv.) Traction Co., Track and Roadway .....	581	—Track and Roadway .....	489	Murray, .....	88, 84, 86
Manchester (N. H.) Traction Light & Power Co., Dividends .....	166	—Use of Pere Marquette Railroad Cars ..	516	Murray, Utah, Track and Roadway .....	489
Manhattan Elevated Railway, Dividends, Mankato Electric Traction Co., Track and Roadway .....	370	—Use of Pere Marquette Railroad Cars ..	516	Muskogee (Okla.) Electric Railway .....	473
—Power Plant .....	548, 606	—Fares .....	307	Muskogee (Okla.) Electric Railway, Track and Roadway .....	268
Manning, Maxwell Moore .....	125	Mileage, Interurban Railroads in Indiana Milford & Uxbridge Street Railway .....	237	Myersdale Construction & Equipment Co., Incorporated .....	661
—Hendershot Coupling .....	*195	Milk Traffic .....	237		
—Atlantic City & Shore Railroad .....	41	—Aurora Elgin & Chicago Railroad .....	*996		
—Bois & Interurban Railway .....	320	—Philadelphia Rapid Transit Co. ....	580		
—Chicago Lake Shore & South Bend Railway .....	542	—Wolken Bros., Galvanized Steel Pole ..	*345		
		Willey Electric Co. ....	467		

\*An asterisk indicates maps, portraits or other illustrations. †A dagger indicates an editorial.

**N**

Nanki Railway of Japan, Rolling Stock..... 552  
 Nanz Clock Co..... 585  
 Nashville Interurban Railroad, Track and Roadway..... 36, 95, 397, 631  
 Nashville Railway & Light Co.....  
 —Dividends..... 131  
 —Power Plant..... 297, 432  
 —Track and Roadway..... 463  
 Nathan Manufacturing Co..... 371  
 Natick & Cochituate Street Railway, Fares..... 307  
 National Brake & Electric Co.....  
 —Air Brakes for Chicago Railways Co..... 522  
 —Air Compressors..... 436  
 —Orders..... 520  
 National Brake Co..... 610  
 National Construction Co., Power Plant..... 490  
 National Tube Co..... 520  
 National Vacuum Cleaning Co., Vacuum Method for Car Cleaning..... 468  
 Nebraska Electric Trades Exposition Co..... 520  
 Neff, S. S., Ticket Methods Atlantic City & Shore Railroad..... 441  
 Nelson (H. C.) Electric Tramway, Car Engines..... 552  
 Nelsonville Athens & Gloucester Traction Co., Track and Roadway..... 309  
 New Bedford & Onset Street Railway, Rolling Stock..... 371  
 New Doty Manufacturing Co..... 193  
 New England Trolley Wheel Co..... 29  
 New Jersey & Pennsylvania Traction Co., Power Plant..... 518  
 New Orleans & Seashore Air Line Railway—  
 —Incorporated..... 161  
 —Track and Roadway..... 131  
 New Orleans City Railway, Dividends..... 59  
 New Orleans Railway & Light Co.—  
 —Annual Report..... 499  
 —Financial..... 341, 499  
 —Rolling Stock..... 371  
 —Screw Pump..... 284  
 —Service..... 277  
 —Transfer System..... 94, 129  
 New York, N. Y.—  
 —Accidents During April, 1908..... 632  
 —Brooklyn Bridge Extension..... 154  
 —Electrical Show..... 186  
 —Fares..... 307  
 —Metropolitan Street Railway, Grand Jury Report on Investigation..... 514  
 —Rapid Transit Law..... 91, 127  
 —Subway..... 603  
 —Capacity, Arnold Report..... 654  
 —Cars, Arnold Report..... 1255, 262  
 —New Route..... 119, 52  
 —Signals, Arnold Report..... 355  
 —Track Improvements..... 90  
 —Track and Roadway..... 662  
 —Transportation Situation..... 7140  
 New York & Long Island Railroad..... 30  
 New York & North Shore Traction Co., Track and Roadway..... 248  
 New York Car & Truck Co..... 343  
 New York Car Wheel Co..... 529  
 New York Central & Hudson River Railroad—  
 —Electrification, Results Attained..... 300  
 —Power Stations, Ventilation of..... 444  
 New York Central Lines, Rolling Stock..... 400  
 New York City Railway—  
 —Action to Forfeit Charter..... 305, 333, 394  
 —Car House..... 313, 627  
 —Cars, Pay-As-You-Enter Type..... 392, 583  
 —Contract with Express Company Not Renewed..... 365  
 —Financial, 59, 97, 164, 192, 370, 399, 466, 492  
 —Practical Motor Car Making..... 627  
 —Receivers' Protest Against Order of Commission Regarding Equipment..... 51  
 —Receivers Want Funds for Improvements..... 324  
 —Rolling Stock..... 371, 637  
 —Substation..... 339  
 —Transfer System..... 129, 440, 1485, 487, 596, 597, 632  
 New York Edison Co., Breakdown Service Charges..... 1497  
 New York New Haven & Hartford Railroad—  
 —Branch Line Railroad Electrification..... 4317  
 —Electric Railways in Massachusetts..... 4613  
 —Financial..... 312, 399, 609  
 —New York-Port Chester Electric Line..... 44  
 —Overhead Construction..... 80, 84, 86  
 —Power Plant..... 482, 464  
 —Rolling Stock..... 226, 371  
 —Salaries Reduced..... 306  
 —Single-Phase Equipment for Branch Line..... 52  
 New York-Philadelphia Co., Financial..... 132, 251, 344  
 New York to Chicago by Trolley..... 1101  
 Newark, N. J.—  
 —Public Service Railway—  
 —Cars, Pav-As-You-Enter Type..... 213  
 —Fare Receiver..... 184  
 —Pulse Identification Cards..... 184  
 Newark Martinsburg & Mt. Vernon Electric Railway, Track and Roadway..... 549  
 Newell Street Railway, Rolling Stock..... 98  
 Newspapers, Newark, N. J., Pay-As-You-Enter Cars in Chicago..... 1347, 362, 428

Newton & Boston Street Railway, Fares Increased..... 430  
 Newton Street Railway, Fares Increased..... 430  
 Newtown Railway, Financial..... 97  
 Niagara St. Catharines & Toronto Railway, Track and Roadway..... 606  
 Niagara Transmission Line..... 138  
 Nicholl, Franklin M., Trucks for Electric Motor Service..... 199  
 Nicholl, H. A., Electric Railway Progress in Central States..... 113  
 Nicholl.....  
 —Cars for City Service..... 35  
 —Mexico Street Railways..... 231  
 —Sight-Seeing and Funeral Car Service..... 426  
 —Single-Truck Cars Without Monitors..... 144  
 Niles Car & Manufacturing Co..... 135  
 —Cars.....  
 —Combination Passenger, Smoking and Baggage, Buffalo Lockport & Rochester Railway..... 453  
 —Chicago Lake Shore & South Bend Railway..... 628  
 —Interurban, Choctaw Railway & Lighting Co..... 422  
 —Orders..... 134, 313, 552  
 Nipissing Central Electric Railway, Track and Roadway..... 56  
 Norfolk & Portsmouth Traction Co.—  
 —Earnings..... 98, 166, 192, 663  
 —Financial..... 466  
 —Installations..... 490  
 Norris, I. H., Address at Purdue University..... 173  
 North American Co., Annual Report..... 141  
 North Coast Power Co., Power Plant..... 490  
 North Jackson Street Railway, Town & Improvement Co., Financial..... 98  
 North Midland Electric Railway, Track and Roadway..... 248  
 North Union, Wash., Track and Roadway..... 189  
 Northampton Street Railway—  
 —Dividends..... 59  
 —Financial..... 281  
 —Northampton Traction Co., Effect of 2-Cent Steam Railway Fares on Traffic..... 124  
 Northern Electric Co..... 607  
 —Power Plant..... 309  
 —Track and Roadway..... 400, 493  
 Northern Engineering Works..... 136  
 Electric Pillar Cranes..... 169  
 Northern Ohio Traction & Light Co.—  
 —Annual Report..... 169  
 —Dividends..... 342  
 —Earnings..... 134, 251, 519  
 —Rolling Stock..... 549  
 Northern Power Co., Power Plant..... 549  
 Northern Texas Electric Co.—  
 —Dividends..... 281  
 —Earnings..... 584  
 —Financial..... 399  
 Northern Texas Traction Co.—  
 —Earnings..... 134, 342  
 —Financial..... 190, 310  
 —Power Plant..... 549  
 —Track and Roadway..... 634  
 Northwestern Elevated Railroad (Chicago)—  
 —Cars..... 500  
 —Compensation Payments of Union Gate and Trap..... 638  
 Oakland Traction Co.—  
 —Car Wiring Cables..... 236  
 —Cars, California Type..... 479  
 —Crane, Air Lift Lift..... 157  
 —4,000-Gallon Water Car..... 58  
 —Power Plant..... 57  
 —Track and Roadway..... 56, 549  
 —Trucks, Air Lift Lift..... 157  
 Ocean Shore Railway, Track and Roadway..... 62  
 Olesca & Middletown Railway, Financial..... 636  
 Ohio Southern Traction Co., Columbus, O., Track and Roadway..... 95  
 Ohio Brass Co..... 552  
 Ohio Trolley Section Insulator..... 136  
 Ohio Electric Railway..... 46  
 —Financial..... 224, 399  
 —Limited Service..... 94  
 —Substation..... 297, 339  
 —Track and Roadway..... 338, 367, 459, 606  
 Ohio Franchise Tax Bill..... 148

Ohio Traction Co., Dividends..... 192, 555  
 O'Leary, John F., Tickets as a Fare Medium for Street and Interurban Railway Traffic..... 651  
 Oil Engines, Testing..... 659, 657  
 Oil Filter..... 426  
 Oklaonax Electric Railway, Track and Roadway..... 463  
 Oklahoma & Golden City Railway, Track and Roadway..... 162  
 Oklahoma City & Shawnee Interurban Railway, Incorporated..... 462  
 Oklahoma City B. & L. Line Railroad, Incorporated..... 606  
 Oklahoma City Rapid Transit Railway, Track and Roadway..... 309  
 Oklahoma B. & Reno Rapid Transit Co., Incorporated..... 633  
 Oklahoma-El Reno Interurban Traction Co., Incorporated..... 580  
 Oklahoma Race Separation Law..... 245, 275  
 Oklahoma Railway.....  
 —Rolling Stock..... 467  
 —Track and Roadway..... 278  
 Old Colony Street Railway, Financial..... 584  
 Oley Electric Railway, Track and Roadway..... 278  
 Olney, Ill., Track and Roadway..... 26, 222  
 Omaha & Council Bluffs Railway & Bridge Co., Financial..... 614  
 Omaha & Council Bluffs Street Railway—  
 —Accidents, Avoiding..... 139, 368  
 —Car House..... 121  
 —Claims, Methods of Handling..... 512  
 —Dividends..... 59, 161  
 —Fare Reductions..... 94  
 —Five-Cent Fare Between Council Bluffs and Omaha..... 94  
 —Mirrors for the Automobile..... 523  
 —Owl Car Service..... 52  
 —Rolling Stock..... 661  
 —Track and Roadway..... 26, 162, 606  
 Omaha & Nebraska Central Railway, Track and Roadway..... 56  
 Oneida Railway, Trademark..... 182  
 Oneonta & Mohawk Valley Railroad—  
 —Financial..... 370  
 —Rolling Stock..... 610  
 Ontario West Shore Electric Railway, Track and Roadway..... 26, 162, 606  
 Operation—  
 —Bar Line Service..... 639  
 —Brooklyn Bridge Terminal..... 51, 214  
 —Cause for Study of..... 229  
 —Chicago to New York by Trolley..... 428  
 —Meeting of Indiana Commission and Electric Railway Officials..... 255, 255, 306  
 —Mirrors for Motormen..... 523  
 —New York to Chicago by Trolley..... 1101  
 —Reducing Car Mileage..... 317  
 —Reducing Dead Mileage..... 147  
 —Theater Train Service..... 433, 54  
 —Through Routes on Chicago Elevated Roads..... 268, 335  
 —Through Routes on Surface Lines in Chicago..... 265, 325  
 —Train-Inducing Device, Gibbs..... 521  
 —Train Operation and Maintenance of Way Rules in Indiana..... 394  
 —Vigilance in Discipline..... 639  
 —Welfare Work on Ft. Wayne & Wabash Valley Traction Co..... 540  
 —Wrecking Jacks in Massachusetts..... 1555  
 Oregon Electric Railway.....  
 —Category Construction and Bonds..... 252  
 —Construction Plans..... 541  
 —Description..... 1255, 258  
 —Financial..... 28, 551  
 —New Line Opened..... 25  
 —Substation..... 210  
 —Track and Roadway..... 309, 367, 465, 490  
 Oregon Interurban Railway, Track and Roadway..... 606, 634  
 Oregon Rapid Transit & Power Co.—  
 —Incorporated..... 266  
 —Track and Roadway..... 463  
 Oshkosh, Wis., Track and Roadway..... 56  
 Ous, Bone & Co..... 552  
 Ottawa, Ont., Track and Roadway..... 463  
 Ottawa Electric Railway.....  
 —Financial..... 192  
 —Rolling Stock..... 313  
 —Track and Roadway..... 189  
 —Wage Controversy..... 632  
 Overhead Construction—  
 —Oregon Electric Railway..... 252  
 —Sectionalization..... 80, 84, 86  
 —Washington Baltimore & Annapolis Electric Railway..... 265  
 —With Bridges, Syracuse Lake Shore & Northern Railway..... 1174  
 —With Improved Bracket..... 1167  
 Overhead Section Insulator for Trolley, Ohio Brass Co..... 136  
 Owl Car Service.....  
 —Boston Elevated Railway..... 329  
 —Des Moines..... 54, 220  
 —Omaha..... 52  
 —Toledo..... 129, 336

**P**

Pacific Coast Railway, Track and Roadway..... 56  
 Pacific Electric Railway—  
 —Financial..... 434

\*An asterisk indicates maps, portraits or other illustrations. †A dagger indicates an editorial.

—Station at Monrovia, Cal. ....	*555	—Wage Controversy.....	429, 460, 546, 579, 605, 631	Putney, H. M., Classification of Operating Expenses.....	474
—Track and Roadway.....	26, 162, 338, 397	Pittsburg Underground Railway, Incorporated.....	517	<b>Q</b>	
Parine Traction Co., Track and Roadway.....	634	Pittsfield Street Railway, Track and Roadway.....	367	Quebec, Que., Report on Cause of Bridge Failure.....	319
Paducah Southern Electric Railroad, Track and Roadway.....	57, 490	Pleasantville Traction Co., Track and Roadway.....	549	Quebec & Saguenay Electric Railway, Track and Roadway.....	319
Paint Tests.....	1498	Plymouth Carver & Wareham Street Railway, Financial.....	519	Quincy, Cal., Track and Roadway.....	150
By C. B. Beckler.....	196	<b>Poles—</b>		Quincy Horse Railway & Carrying Co., Rolling Stock.....	231, 342
Pana Girard & Jacksonville Railway, Track and Roadway.....	397, 422	—Painting, Near Switches.....	1587, 649	Quincy, Manchester, Sargent Co., Rapid Transit Co., Incorporated.....	250, 282, 493, 585
Panasote Co.....	135, 552	—Palms, Telephone and Lighting.....	859	<b>R</b>	
Paris & Sulgaco Traction Co.—		—Steel, Milliken.....	459	Railroad Supply Co.....	493
—Incorporated.....	320	Porter, H. F., Failures of Reinforced Concrete.....	461	Rails, Guard.....	1588
—Track and Roadway.....	309	Porter Manufacturing Co.....	*815	Railway Blue Book.....	377
Paris Traction Co., Financial.....	619	—Solenoids and Magnets.....	253	Railway Materials Co.....	585
Parkersburg Bridge Co., Incorporated.....	561	Portland, Ore., Track and Roadway.....	606	Railway Specialty & Supply Co.....	59, 251
—Grand Rapids Railway.....	*575	Portland Eugene & Eastern Railway—		Railway Steel-Spring Co.....	343, 552
—Ramona.....	52	—Track and Roadway.....	26, 96, 309	Ralston & Le Baron.....	193
—Southern Michigan Railway, Near Berlin Springs.....	153	Portland Railway Light & Power Co.—		Rapid Transit Co., Incorporated.....	633
Toronto Railway, Harbor Beach.....	*567	—Advertising Methods.....	576	Rates, Freight—	
Parlor Car Service, Mexico Electric Tramways Co.....	47	—Boarding Railroad's Incoming Cars by Passengers.....	219	—Joint Steam and Electric Railways, 24, 1438	
Pasadena, Cal., Track and Roadway.....	95, 162	—Dividends.....	332	—Joint Steam and Electric, Chicago & Milwaukee Electric Railroad.....	54, 768
Paterson, N. J., Battering Device.....	283	—Fare Reduction Contested.....	346	—United Traction Company of Albany.....	580
Paul Smith's Railroad, Track and Roadway.....	26	—Financial.....	584	Raymond Concrete Pile Co.....	343
Paul's Valley, Okla., Track and Roadway.....	581	—Power Plant.....	584	Real Estate Improvement Co., Wattles Electric Floor Surfacers.....	*403
Paving with Wood.....	1347	—Rolling Stock.....	281, 552, 664	Receiverships—	
Pay-As-You-Enter Car Co.....	313, 493	—Substation.....	490, 662	—And Foreclosures During 1907.....	8
Pay-As-You-Enter Cars.....	264	—Track and Roadway.....	310, 367	—Chicago-New York Air Line Railroad.....	305
Chicago City Railway.....	93	Portsmouth & Exeter Street Railway, Fares advanced.....	295	—Chicago & Milwaukee Electric Railroad.....	17, 156
Chicago Railways Co.....	*265	Potomac Valley Railway, Incorporated.....	365	Red Bud & Belleville Interurban Railway, incorporated.....	130
Cleveland Electric Railway.....	*424	Pottstown & Reading Street Railway, Track and Roadway.....	367	Redlands & Yucaipe Electric Railroad, Track and Roadway.....	634
Des Moines City Railway.....	572	Pottsville Union Traction Co., Track and Roadway.....	464	Redlands Central Railway, Track and Roadway.....	189, 464
For City Service, By T. J. Nicholl.....	35	Power Distribution, Feeder Loop, Los Angeles Railway.....	*543	Red Oak & Northwestern Interurban Promotion Co., Inc., Railroad.....	547
International Railway (Buffalo).....	*37, 452	<b>Power Plants—</b>		Refrigerator Car, Ft. Wayne & Springfield Railway.....	*330
—Jewett Car Company Design.....	*553	—Automatic Synchronizing.....	329	Registers—	
Monterey Railway Light & Power Co.....	*239	—Roller Practice.....	176	—Fare.....	
New York City Railway.....	359, 373, 393, 583	—Central Pennsylvania Traction Co.....	*455	—Rooke Automatic.....	469, 495
Proposed Design, By.....	283	—Economizer, Green.....	344	—Tec.....	432
—Public Service Railway of New Jersey.....	513	—High-Voltage, Design of.....	52	Richmond & Chesapeake Bay Railway, Single-Phase Equipment.....	*298
—Fare Receiver.....	484	—Renovating Plans.....	52	Richmond & Winchester Interurban Railway, Track and Roadway.....	432
—Sale of Newspapers.....	*347, 362, 428	—United Railways of St. Louis.....	*480	Ridge Avenue Passenger Railway, Dividends.....	370
—Steel-Steel Car Co.....	429	—Utility of Second-Hand Machinery, With Turbines.....	125	Ridgway, Track and Roadway.....	371
Peekskill Lighting & Railroad Co., Dividends.....	98	—By C. W. Pen Dell.....	120	Rio Roanoke Railway & Electric Co.—	
Pen Dell, C. W., Steam Turbine Plants.....	120	Power Specialty Co.....	29, 165, 252	—Power Plant.....	250
Pendleton, Ore., Track and Roadway.....	518, 581	Prairie State Traction Co., Track and Roadway.....	549	—Track and Roadway.....	310, 464
Peninsular Railway, Track and Roadway.....	278	—Preston Car & Coach Co.....	60, 313, 342	Robertson, W. & Co., Steel Wool Journal Packing.....	327
Pennsylvania, Report on Electric Railroads.....	576	Price, Charles E., Proposed Design for Pay-As-You-Enter Car.....	*273	Robins Conveying Belt Co.....	233
Pennsylvania Railroad, Medical Air Lock.....	469	Price, Charles E., Promotion of Traffic.....	115	Rochester Corning & Elmira Traction Co.—	
Pensacola Electric Co.—		Priest Rapids Railway, Track and Roadway.....	56	—Track and Roadway.....	464, 549, 634
—Earnings.....	134, 370, 609	Promotion of Traffic.....	1139	—Financial.....	663
—Wage Increase Asked.....	61	—Aunt Elgin, Chicago Railroad.....	*327	Rochester Railway, Dividends.....	28, 399
People's Railway, Track and Roadway.....	96	—Conestoga Traction Co.....	*327	Rochester Railway & Light Co.—	
Perfection Pipe Co.....	250	Prosser Traction Co., Track and Roadway.....	131, 432, 464	—Dividends.....	98, 281, 519, 626
Peru, Ind., Track and Roadway.....	26	Protective Relations.....	1523	Rochester Scottsville & Caledonia Electric Railroad, Track and Roadway.....	634
Petaluma & Santa Rosa Railway, Rolling Stock.....	281	—By E. B. Grimes.....	118	Rochester Syracuse & Eastern Railroad—	
Philadelphia & Easton Electric Railway, Effect of 2-Cent Steam Railway Fares on Traffic.....	176	—Public's Debt to the Public Service.....	88	—Financial.....	192, 236, 342
Philadelphia & Western Railroad, Rolling Stock.....	492	—Relations Between Banker and Engineer, By J. C. Kelsey.....	452, 1472	Rock Island Southern Railroad, Track and Roadway.....	222
Philadelphia Co. (Pittsburg)—		—United Railways & Electric Co. (Baltimore).....	91, 276, 428, 362, 393, 343	Roebling's, John A., Sons Co.....	251
—Dividends.....	225, 466	Public Service Commission for Chicago Proposed.....	578	Rogers, S. C., Classification of Operating Expenses.....	558
—Financial.....	192, 554, 609	Public Service Corporation of New Jersey, Dividends.....	434	Rolling Stock—	
Philadelphia Rapid Transit Co.—		Public Service Laws of Wisconsin, By B. H. Meyer.....	559	—Development in Design.....	12
—Accident.....	660	Public Service Railway (Newark, N. J.)—		—Ordered in 1907.....	43, 5
—Controversy with Employes.....	23, 51, 92	—Cars, Pay-As-You-Enter Type.....	*213	Rome & Osceola Railroad, Track and Roadway.....	634
—Extra Charge for Transfers.....	1558	—Fare Receiver.....	484	Rochesters Manufacturing Co.....	637
—Hose Bridge.....	302	—Pupils' Identification Cards.....	184	Rooke Automatic Register Co. Automatic Register and Fare Collector.....	469, 495
—Milk Traffic.....	580	—Track and Roadway.....	309, 549	Rosenberger, J. L., Recent Electric Railway Legal Decisions.....	21, 49, 83, 243, 304, 331, 361, 392, 458, 544, 577, 602, 629
—Rolling Stock.....	342, 552, 610	Publicity, Value of.....	1471	Rosstter, MacGovern & Co.....	193
—Sued for Electrolysis Damages.....	92	Pueblo & Arkansas Valley Electric Railway, Track and Roadway.....	140	Royce, Daniel, Depreciation in Electric Railways.....	508
—Track and Roadway.....	95, 367	Puget Sound Electric Railway—		Rural Electric Railway & Power Co., Incorporated.....	396
—Transfers.....	580, 673	—Earnings.....	134, 342, 636	Russell Car & Snow-Plow Co., Orders.....	192
Philadelphia Traction Co., Dividends.....	342	—Track and Roadway.....	222, 432, 549	Rutland Railway Light & Power Co.—	
—"Grade F," General Electric Co.....	612	Puget Sound International Railway & Power Co., Track and Roadway.....	248	—Financial.....	370, 585
—Scheme for Secutting.....	*451	Pullman Co., Orders, Advertising.....	374, 406, 193, 530	—Rolling Stock.....	467
Pipe Threading and Cutting Machine, Crane.....	*638	Pump, Circulating, Allis-Chalmers.....	286	<b>S</b>	
Pittsburg, Pa.—		Pumping with Air Compressors.....	161	S-E. Missouri Cypress Co.....	165
—Track and Roadway.....	189, 397	Pump, Fire, Advertising.....	476	Safety Car Coupler Co.....	60
—Pay-As-You-Enter Experiments.....	313	Purpurey, Thomas, Broadway Car House, Purchasing, Value of Consulting Engineer in.....	1613	Saginaw Owosso & Lansing Railway, Track and Roadway.....	490
Pittsburg & Allegheny Valley Railway, Financial.....	551	Purchasing, Value of Cost Data.....	1614	Saginaw Valley Traction Co., Effect of 2-Cent Steam Railway Fare on Traffic.....	76
Pittsburg & Butler Street Railway—		Putnam, W. R., Public's Debt to the Public Service Corporation.....	88	St. Charles Street Railroad, Dividends.....	59
—Express Company Contract.....	94	Putnam & Westchester Traction Co., Track and Roadway.....	162	St. Francis County Electric Railway, Track and Roadway.....	131
—Power Plant.....	368, 464	<b>Q</b>		St. Joseph & Stroud & Elial Railway, Track and Roadway.....	248
—Rolling Stock.....	552, 585				
Pittsburg Automatic Vise & Tool Co.....	343				
Pittsburg Carburg Railway, Track and Roadway.....	278, 432				
Pittsburg Harmony Butler & New Castle Railway—					
—Cars.....	*954				
—Track and Roadway.....	26, 397				
Pittsburgh Lisbon & Western Railroad, Track and Roadway.....	278, 338				
Pittsburgh Railways Co.—					
—Bridge Tolls.....	159				
—Double-Flow Steam Turbines, Westinghouse.....	*642				
—Fares.....	256				
—Rolling Stock.....	664				
—Transfer System.....	129, 161				

St. Joseph Railway Light Heat & Power		Securities, Improvement in the Bond	1613	—Washington Baltimore & Annapolis	900
—Dividends	370	Market		Electric Railway	1193
—Trail Car Operation	374, 376	Sealey, Garrett T., South Side Elevated	269	Sioux City, Ia., Track and Roadway	594
—Power Plant	490	Railroad Extensions	269	Sioux City Traction Co., Track and	
St. Joseph Valley Traction Co., Track		Sellers, William, & Co.—		Roadway	278
and Roadway	189	—Car Wheel Boring Mill	522	Sistersville, W. Va., Track and Roadway	57
St. Louis, Mo.—		—Universal Tool Grinder	436	Sleet Brush, Third-Rail	412
—Tax Ordinance Sustained	630	Service—		Sleet Scrapers and Wheels, Nuttall	126
—Track and Roadway	606	—Betterment, Chicago Railways Co.	220	Smith, E. D., Power Generating and	
—Third Railways—		—Brooklyn Rapid Transit Co. Ordered to		Distributing Systems, United Rail-	
—Power Generating and Distributing		Increase Service	94	ways, Company of St. Louis	450
Systems	480	—Federal Car Service in Mexico	326	Smith & Wallace Order	637
—Traffic During 1907	186	—Interruptions	1255	Smith, Peter, Heater Co.	29
St. Louis Car Co.	135	—Limited, Between Cincinnati and Day-		—Heater Equipments	138
—Cars—		—Live and Dead Trailers	129	Snodgrass Valley Railway—	
—Semi-Convertible, Utah Light & Rail-		—Louisville Railway	54	—Rolling Stock	585
way Co.	403	—Metropolitan Street Railway, Kansas		—Track and Roadway	607
—Pittsburg, Harmony Butler & New		City	249	Solenoids and Magnets, Porter Manufac-	
Castle Railway	251	—New Orleans Railway & Light Co.	277	—Luring Co.	253
—Orders		—New York City, Improvement Ordered	25	South Bend-Raymond Electric Co., Track	
—134, 165, 192, 225, 213, 467, 585, 664		—New York City Public Service Commis-		and Roadway	96
St. Louis Electric Show	275	sion Orders	307	South Bethlehem & Saucun Street Rail-	
St. Louis Montezano & Southern Rail-		—New York Public Service Commission		way	
way—		Investigation	420, 516	—Rolling Stock	134
—Passenger Station	281	Owl Car		—Track and Roadway	57
—Track and Roadway	248, 549	—Boston Elevated Railway	329	South Memphis Traction & Electric Co.	
St. Louis Surface & Paint Co., Railways	60	—Deer Moines City Railway	54, 220	—Track and Roadway	464
St. Louis Terry, Haute & Quincy Traction		—Omaha & Council Bluffs Street Rail-		South Morgantown Traction Co., Track	
Co., Track and Roadway	367	way	52	and Roadway	662
St. Matthews, S. C., Track and Roadway	397	—Toledo, O.	129, 336	South Richmond Railway, Track and	
St. Paul City Railway, Rolling Stock	250	—Parker, Wm., Pugh Street Electric Rail-		Roadway	490
St. Paul Minneapolis & Seattle Electric		way	336	South San Joaquin Improvement Co.,	
Railway, Incorporated	94	—San Francisco, Cal., Ordinance	52	Incorporated	488
St. Petersburg, Russia—		—Sight-Seeing Cars in Mexico	326	South Side Elevated Railroad (Chicago)—	
—Rolling Stock	134	—Theater Trains, Spokane & Inland Em-		—Accident	460
—Traffic	151	pire Railroad	133, 54	—Annual Report	142
St. Tammany & New Orleans Railway &		—Through, Between Indianapolis and		—Dividends	342
Ferry Co., Track and Roadway	367, 549	Louisville	499	—Extensions and Improvements	312
Salem, Ore., Track and Roadway	464	—Through, Indianapolis to Terre Haute	128	—Financial	224, 312
Salt Lake & Spencer Railway, Substa-		—Power Plant	397	—Increased Expenses	1167
tion	635	Shaw, James F., & Co.	343	Southern Car Co.	226
Salt Lake & Ogden Railway, Track and		Shelboyan Light Power & Railway Co.		Southern Colorado Power & Railway	
Roadway	297, 549, 607	—Financial	585	—Incorporated	55
San Angelo, Tex., Track and Roadway	222	Sheffield Co., Rolling Stock	610	—Track and Roadway	131
San Antonio Power & Traction Co., In-		Shelby Steel Tube Co.	99	Southern Michigan Railway—	
corporated	606	Sheridan, Wyo., Track and Roadway	367	—Park Near Berrien Springs	155
San Angelo Traction Co.—		Sherwin-Williams Co.	552	—Track and Roadway	96
—Power Plant	310	Shop Equipment, Expansion of	3556	Southern Railway Supply Co.	282
—Track and Roadway	310	Shop Practice—		Southern Street Railroad, Incorporated	94
San Antonio Traction Co., Rolling Stock	281	—Allegheny Valley Street Railway	410	Southern Traction Co., Track and Road-	
San Bernardino Valley Traction Co.,		—Armature Banding Device	354	way	662
Power Plant	368	—Armature Repair Shop Methods	360	Southern Wisconsin Railway, Bond Issue	
San Diego, Cal., Track and Roadway	26	—Armature Truck	360	Approved	45
Sandusky, Norwalk & Mansfield Electric		—Car House Records and Terminal		Southwestern Traction Co., Rolling Stock	313
Railway, Rolling Stock	467	Cleaning	406, 410	Sparta-Melrose Electric Railway &	
San Francisco, Cal.—		—Economy	1613	Power Co., Track and Roadway	607
—Ordinance to Regulate Service	52	—Plaster of Paris Models	497	Spokane, Wash., Inland Empire System,	
—Subway	18	—Practical Hints, By H. P. Clarke	228	Advertising Cards	211
San Francisco & Bay Counties Railway,		—Practical Motor Coil Making	627	Spokane & Inland Empire Railway—	
Incorporated	247	—Recutting Pinions, Indiana Union Trac-		—Financial	133, 399
San Francisco Oakland & San Jose Con-		—Repair Records, United Railways &		—Theater Trains	339, 34
solidated Railway	435	Electric Co. (Baltimore)	526	—Track and Roadway—	
—Rolling Stock	432	—Repair Work Record, United Railways		222, 248, 367, 432, 490, 585	
—Track and Roadway	338, 432	—Savings Electric Co. (Baltimore)	327	Spokane & Newport Electric Railway,	
San Francisco Vallejo & Napa Valley		—Small Roads	71	Track and Roadway	26
Electric Railway, Track and Road-		—Track Layout	4497	Spokane Traction Co., Rolling Stock	585
way	131	—Travel Hoists at Tampa, Fla.	530	Springfield Clear Lake & Rochester Elec-	
Sander	71	—Trolley Wheel Arbor	392	tric Railway, Track and Roadway	518
Sanderson & Porter	251	—Useful Schemes	833	Springfield Consolidated Railway, Sta-	
San Jacinto, Cal., Track and Roadway	490	—Whitening Floors with Lime	474	tion	684
Santa Ana Tustin & Huntington Beach		Shop Tools, Motor Driven	471	Springfield Railway & Light Co., Divi-	
Railroad, Track and Roadway	367	Shops—		dends	399
Sapulpa & Interurban Railway	424	—Arrangement of Tracks	437	Springfield Street Railway—	
Sarnia Street Railway, Rolling Stock	342	—Indiana Union Traction Co.	105	—Financial	92, 219, 364
Savannah, Ga., Schedules	94	—Location of Motors	4101	—Freight and Express Service	220
Savannah Electric Co., Earnings, 134, 341,	636	—Repair, Indiana Union Traction Co.	67	—Freight Cars of Steam Roads Operated	129
Schedules		—Repair, York Railways Co.	440	—Power Improvements	359
—Boston & Worcester Street Railway	160	Shore Line Electric Railway, Track and		Standard Paint Co.	193, 552
—Boston Elevated Railway	329	Roadway	339	Standard Steel Tie Co.	400
—Savannah, Ga.	94	Short Line Terminal Co., Incorporated	396	Standardization, Clearance and Third	
Schenectady Railway—		Shovel, Electric Vulcan Iron Works	4316	Rails	332
—Financial	241, 466	Shreveport, La., Track and Roadway	96	Star Brass Works	60
—Substation	210	Shreveport Suburban Railway, Incorpo-		Star Brass Co., Kalamazoo Trolley	
—Track and Roadway	681	rated	277	Wheels	401
—Withdrawal of Constation Tickets	325	Shrewsbury Traction Co., Transfer Lit.	129, 170	Stark, N. M., Reinforced Concrete in	
Schoch, Eugene P., Review of Timber		Shrewsbury, Pa., Track and Roadway	518	Electric Railway, Won	511
Conservation	1555	Sidney & Glace Bay Railway, Power		Starring, M. B., Interstate Commerce	
Schuykill & Poughlin Traction Co. Inco-		Plant	131	Commission System of Accounting	594
orporated	547	Signal System, Telegraph, By Chauncey		Stations and Buildings—	
Schuykill Railway Co., Financial	133	P. Button	4117	—Office Building, Duluth Street Rail-	
Scioto Valley Traction Co.—		Signals—		way	456
—Effect of 2-Cent Steam Railway Fares	466	—Hudson & Manhattan Railroad Tunnels	293	—Pacific Electric Railway at Monrovia,	
on Traffic	124	—Market Street Elevated Railway, Phil-		Cal.	595
—Financial	636	adelphia	4229	—Shelter Stations, Duluth Street Rail-	
—Seattle, Wash.—		—New York Subway, Arnold Report	355	way	492
—Superintendent of Public Utilities	487	—Train Indicating Device, Gibbs	451	—Canadian Electric Railways for 1907	
—Track and Roadway	26, 248	—With Oil Lights, Blake	284	—Receiverships and Foreclosures Dur-	
Seattle Electric Co.—		Signs, Painting Poles Near Switches	587, 640	ing 1907	8
—Dividends	370	Single-Phase—		—Rolling Stock Ordered in 1907	43, 5
—Earnings	134, 225, 636	—Construction Statistics	4285	—Track Construction in 1907	43
—Financial	132, 663	—Equipment for Branch Line of New		Steam Railways—	
—Improvements During 1907	109	York New Haven & Hartford Rail-		—Construction During 1907	17
—Power Plant	239	road	52	—Effect of 2-Cent Fare on Electric Rail-	
—Rolling Stock	134, 664	—Hanover, York Railway	288	way Traffic	165, 75, 124, 176
—Track and Roadway	338, 297, 607, 662	—Railway Motors for Locomotives	475, 84, 85, 86	Sterling-Meaker Co.	282
Seattle Snodgrass & Everett Railway—		—Richmond & Chesapeake Bay Railway	298	Steuernville & East Liverpool Railway &	
—Incorporated	547			Light Co.	
—Track and Roadway	607			—New construction	291
Seattle-Tacoma Short Line, Track and				—Track and Roadway	222, 634
Roadway	662			Stewart, John A., Electric Co.	585

\*An asterisk indicates maps, portraits or other illustrations. †A dagger indicates an editorial.

Stillwater Power & Railway Co., Incorporated..... 547

Stone & Webster Companies—  
—Earnings and Expenses..... 217  
—Executive Offices..... \*137

Stover Motor Car Co., Passenger Motor Car..... \*228

Strang Gas-Electric Car Co., Motor Car..... \*154

Stratford, Ont., Track and Roadway..... 190

Street Railway Journal, Consolidation with Electric Railway Review..... \*587

Strike-Breaking, Louisville Railway Co. 184

Strikes—  
—Chester Traction Co..... 579, 604  
—Cleveland, O..... 578, 630, 660  
—Indiana Union Traction Co..... 23, 51, 128, 244, 307  
—Municipal Traction Co. (Cleveland)..... 630, 660  
—Pensacola Electric Co..... 486, 545  
—Threatened, Chicago Railways Co..... 603  
—Wilmington City Railway..... 632

Stroudsburg & Water Gap Street Railway—  
—Power Plant..... 607  
—Track and Roadway..... 490, 518

Stuart Island Co., Substations  
—Feeding Portable..... 4497  
—Portable, United Railways of St. Louis..... \*180

Subways  
—Brooklyn, N. Y..... 578, 603  
—New York City..... 91, 127, 218, 317, 393, 428, 455, 4471, 486, 603  
—Capacity, Arnold Report..... 654  
—Landing, Arnold Report..... \*292  
—New Route..... \*19, 52  
—Signals, Arnold Report..... 355  
—Track Improvements..... 90  
—Proposed Between Philadelphia and Camden..... 332

Sullivan, J. L.,  
—Home-Made Oil Filter..... \*426  
—Lubricator..... \*303  
—Repairing of Conductors..... \*183

Swallow Falls Electric Light & Power Co., Track and Roadway..... 607

Swedish Railways, Electrification..... \*285

Swedish Publishing..... 610

Switzerland, High-Tension Direct-Current Railway..... 234

Symington, T. H. Co..... 400, 435

Syracuse & Suburban Railroad, Rolling Stock..... 98

Syracuse Lake Shore & Northern Railroad, Overhead Construction, with Bridges..... \*167, \*174

Syracuse Rapid Transit Co.—  
—Dividends..... 28, 98, 466  
—Financial..... 133, 370  
—Trademark..... \*182  
—Synchronizing, Automatic..... 329

**T**

T-Rail Track Construction, By Mark Low..... \*598

Tacoma, Wash., Power Plant..... 163

Tampa & Sulphur Springs Traction Co., Track and Roadway..... 26

Tampa Electric Co.—  
—Dividends..... 585  
—Earnings..... 134, 341, 609  
—Shop Practice..... \*390

Tariffs  
—Local and Joint Freight, Toledo Urban & Interurban Railroad..... 187  
—Uniform System of Filing in Indiana..... 160

Taunton & Pawtucket Street Railway, Fares..... 272

Taxation—  
—Indiana Railways..... 516  
—Minnesota Electric Roads..... 307  
—Public, By Judge Annis Dwyer..... 119  
—St. Louis Tax Ordinance Sustained..... 630  
—United Railways Co. of St. Louis..... 394

Taylor, R. C.,  
—Anderson Shops, Indiana Union Traction Co..... \*67  
—Fundamental Brake Rigging..... 114, \*139  
Taylor, Tex., Track and Roadway..... 464

Taylor & Penn Co..... 343

Taylorville, Ill., Track and Roadway..... 397

Taylorville Electric Railway—  
—Incorporated..... 547  
—Track and Roadway..... 607

Taylorville Street Railway Light Heat & Power Co., Track and Roadway..... 397

Telegraph Signal Co..... 313

Temple Marker, Los Angeles Railway..... \*543

Terrace, Ill., Traction Co..... 57

Terre Haute Indianapolis & Eastern Traction Co.—  
—Fares..... 277  
—Power Plant..... 190  
—Through Service, Indianapolis to Terre Haute..... 128  
—Track and Roadway..... 190, 239, 582

Terre Haute Robinson, Olney & Southwestern Railway—  
—Incorporated..... 517  
—Track and Roadway..... 634

Terre Haute Traction & Light Co., Dividends..... 281

Texas Portland Cement Co..... 610

Texas Traction Co.—  
—Rolling Stock..... 134  
—Station..... 585  
—Track and Roadway..... 57, 239, 490, 518, 615

Texas Union Traction Co., Incorporated, 188

Thermit Welding—  
—Chicago City Railway..... \*447  
—Indiana Union Traction Co..... \*417

Thermopolis, Wyo., Track and Roadway..... 490

Thief River Electric Railway, Incorporated..... 337

Third Avenue Railroad, Financial..... 59, 192, 224, 312, 339  
—Rolling Stock..... 225, 500, 460, 637  
—Shops..... 664  
—Transfers..... 448, 487, 498, 516, 596, 597, 622

Third-Rail Street Brush..... \*485

Thorp, J. C., Steam Turbine Development..... \*573

Ticket, in Third Avenue City Shore Railroad..... \*33, \*41

Tickets—  
—Duplex Hat Check, East St. Louis & Suburban Railway..... \*456  
—Duplex, on Massachusetts Lines..... 439  
—Engraved, Protection in..... \*129  
—Fraudulent Use of..... 126, 158  
—Impaired Forms..... 242  
—Indianapolis & Cincinnati Traction Co..... \*241  
—Pupils' Identification Cards, Newark, N. J..... \*184

Street and Interurban Railways, By  
—G. H. Palmer..... \*651  
—Round-Trip, Illinois Traction System..... 53  
—Thefts of..... 306

Tickets, See Also Fares.  
—Indiana Union Traction Co..... 303  
—Treated..... \*197

Timber Preservation—  
—Grading of Crossovers..... \*555  
—Paving Blocks..... 1405  
—Review of, By Eugene P. Schoch..... 1555, 568

Titzel, C. Edgar, New Business Department, of a Railway..... \*227

Toch Brothers..... 371

Toledo, O., Owl Car Service..... 129

Toledo & Chicago Interurban Railway, Financial..... 250, 519

Toledo, O., Indiana Railway  
—Effect of 2-Cent Steam Railway Fare on Traffic..... 76  
—Financial..... 59, 312, 484

Toledo Union Harbor & Detroit Railroad, Financial..... 663

Toledo Fostoria & Findlay Railway, Track and Roadway..... 163

Toledo Ottawa Beach & Northern Railway, Track and Roadway..... 607

Toledo Railways & Light Co.—  
—Annual Report..... 103  
—Earnings..... 133, 636  
—Financial..... 133, 636  
—Owl Car Service..... 336

Toledo Urban & Interurban  
—Effect of 2-Cent Steam Railway Fare on Traffic on Traffic..... 76  
—Financial..... 585  
—Local and Joint Freight Tariffs..... 187  
—Rolling Stock..... 225, 313

Toledo Union Motor-Driven  
Tools, Expansion of Shop Equipment..... \*566

Topeka Railway, Track and Roadway..... 96

Topeka Southwestern Railway, Rolling Stock..... 98

Toronto, Can., Track and Roadway..... 131, 278

Toronto & York Radial Railway, Track and Roadway..... 607

Toronto Railway—  
—Annual Report..... 349  
—Dividends..... 466  
—Financial..... 225  
—Rolling Stock..... 134  
—Scarboro Beach Park..... \*367

Toronto Suburban Railway, Track and Roadway..... 607

Torrington & Winchester Street Railway, Power Plant..... 96, 163

Track and Roadway—  
—Bonds, Oregon Electric Railway..... \*252  
—Clearance Chart for Curves..... 74  
—Construction in 1907..... \*436  
—Crossing Sign Post..... \*359  
—Foundations for T-Rails..... \*101  
—Paving Blocks..... \*405  
—Shelby Stations, Duluth Street Rail-  
way..... \*292  
—Standard Clearance..... 733  
—Substructures for Tracks in Streets..... \*121  
—Construction in 1907..... \*598  
—T-Rail, Detroit United Railway..... 48, \*63  
—T-Rail in El Paso..... \*285

Track Elevation, Chicago & Oak Park Elevator Railroad..... 604

Track Scraper, Root..... \*612

Trademarks, Utica & Mohawk Valley, Syracuse Rapid Transit and Oneida Street Railways..... \*182

Traction—  
—Development by Advertising..... 30  
—Gatemans on Michigan United Railways  
—Interchange Between Steam and Electric Lines, Indiana..... 128

—Milk—  
—Aurora Elgin & Chicago Railroad..... \*296  
—Philadelphia Rapid Transit Co..... 580  
—Promotion of..... \*139  
—By C. F. Price..... 115

Trailers, Live, in St. Joseph, Mo..... \*386

Transfers—  
—Abuses of..... \*405  
—Birmingham..... 516  
—Brooklyn Rapid Transit Co..... 461  
—Extra Charge in Philadelphia..... \*556  
—Form Used on Through Route in Chicago..... \*325  
—Galveston Electric Co., New System..... 54  
—New York City Railway..... 129, 430, 448, 487, 498, 516, 596, 632  
—Newark Rapid Transit & Light Co..... 314  
—Philadelphia Rapid Transit Co..... 584, 633  
—Pittsburgh Railways Co..... 129, 161  
—Richmond, Va..... 546  
—Shreveport, La..... 170  
—Shreveport Traction Co., New System..... 129  
—United Railroads of San Francisco..... 336  
—United Railways & Electric Co. (Baltimore)..... 299  
—Washington (D. C.) Railway & Electric Co..... 329, 487

Transmission—  
—Galvanized Steel Poles for..... \*345  
—Thury System..... \*318, 331  
—United Railways of St. Louis..... \*180

Transmission Lines, Feeder Loop, Los Angeles Railway..... \*543

Transportation Equipment Co., Dividends..... 29

Tec Register, Fare Box..... 52

Traverse City, Mich., Track and Roadway..... 310

Tri-City Railway & Light Co., Davenport, Ia..... 466

Trolley Retriever, Peerless..... \*611

Trolley Supply Co., Arc Headlight and Trolley Retriever..... \*611

Trolley Wheel Arbor..... \*303

Trolley Wheel—  
—Humphrey..... \*402  
—Kalamazoo..... 293  
—Langen..... 201

Trolley Wheel, Harp and Poles, By Adam Cole..... \*385

Tropico, Cal., Track and Roadway..... 635

Troy Rensselaer & Pittsfield Street Railway, Track and Roadway..... 607

Truck, with Motor Suspension..... \*470

Trucks—  
—Oakland City Traction Co..... \*9  
—Electric Motor and Trailer..... \*382  
—Electric Motor Service, By F. M. Nicholl..... 199  
—Electric Motor Service, Practical Views on, By C. Loomis Allen..... 103

Tunnel—  
—Belmont Tunnel Under East River, New York..... 90  
—Boston, Washington Street, Engineering Features..... 655  
—Brooklyn, Opening of..... 511  
—Hudson & Manhattan Railroad Under Hudson River..... \*240  
—Pennsylvania Railroad, Medical Air Lock..... \*469  
—Sarnia, Ont.—  
—Electric Locomotives..... 306  
—Electrification..... 23

Tupper, C. A., Growth of Spokane Motor & Western Traction Co..... \*560

Turbines, Steam—  
—By J. L. Hecht..... 125  
—By C. W. Pen Dell..... 120  
—Curtis, Sales of..... 442  
—Development of, By J. C. Thorp..... \*573  
—Double-Flow, Westinghouse, for Pittsburgh Railways Co..... \*642

Turbines, Westinghouse Business..... 372

Tuttle, M. C., Surface Finish on Concrete Construction..... 265

Tuttle, W. B., Producer Gas for Engine Use..... \*555, 617

Tweedy, Hood & Finley..... 637

Twin City & Lake Superior Street Railway—  
—Incorporated..... 606  
—Track and Roadway..... 163, 635

Twin City General Electric Co., Track and Roadway..... 222

Twin City Rapid Transit Co.—  
—Annual Report..... 287  
—Dividends..... 134, 342, 519  
—Earnings..... 28, 342, 584  
—Fares..... 245  
—Financial..... \*257, 800  
—License Tags..... 128  
—Rolling Stock..... 226  
—Substation..... 432  
—Track and Roadway..... 26, 339

**U**

Underground Electric Railways, London, Financial..... 98, 492, 663

Union Electric Co., Financial..... 485

Union Railway, Financial..... 133, 164, 334

Union Spring & Manufacturing Co..... 552

Union Street Railway, Dividends..... 225, 585

Union Traction Co., Santa Cruz, Cal., Rolling Stock..... 520

\*An asterisk indicates maps, portraits or other illustrations. †A dagger indicates an editorial.

Union Traction Co. (Indiana), Dividends.....	370	Wabash Valley Traction Co., Track and Roadway.....	635	West Penn Railways Co.—	519
Union Traction Co. (West Virginia), Incorporated.....	661	Wages—		—Dividends.....	134, 519
United Gas & Electric Co., 372	372	Beaver Valley Traction Company Increases.....	660	—Effect of 2-Cent Steam Railway Fares on Traffic.....	124
United Indurated Fibre Co.....	493	Chicago Railways Co., Trainmen Ask Increase.....	545	—Power Plant.....	635
United Railroads of San Francisco—		Inter-Urban Railway (Des Moines).....	362	—Track and Roadway.....	57, 222, 607
—Financial.....	225, 341	—Ottawa (Ont.) Electric Railway Controversy.....	632	Western Electric Co.....	282, 371
—Power Plant.....	635, 662	—Pensacola Electric Co., Carmen Ask Increase.....	91	—Exhibit at Chicago Electrical Show.....	157
—Transfer System.....	336	Pittsburg Railway Co., 429, 460, 546, 579, 605, 631		—Strain Insulators.....	155
United Railways (Jersey City), Incorporated.....	266	—Washington & Canonsburg Railway Increase.....	660	Western Illinois & Iowa Railroad, Incorporated.....	161
United Railways (Portland, Ore.), Track and Roadway.....	464	Walla Walla Valley Traction Co., Rolling Stock.....	552, 664	Western New York & Pennsylvania Traction Co. Track and Roadway.....	161
United Railways & Electric Co. (Baltimore)—		Wallis, R. N., Classification of Operating Expenses.....	144	—Excursion with Steam Road.....	232
—Accident Frauds.....	428, 451	Warren Gilbert, Shelton Street Duluth Street Railway.....	232	—Financial.....	38, 312
—Annual Report.....	658	Warren-Hisbee Railway, Track and Roadway.....	164	Western Electric & Manufacturing Co., 92, 159, 219, 245, 361, 394, 429, 545, 604	
—Car Defect Report.....	272	Warren Portland & Jefferson Traction Co., Track and Roadway.....	310	Western Tube Co.....	38, 99
—Car House at Electric Park.....	*332	Washington Alexandria & Mt. Vernon Railroad, Track and Roadway.....	28	Western Wire Sales Co.....	251
—Coal, Monthly Statement.....	*391	Washington Arlington & Falls Church Railway, Track and Roadway.....	57	Westinghouse Air Brake Co.....	373
—Crane Cars.....	515	Washington Baltimore & Annapolis Electric Railway—		—Air Compressors for Pumping.....	*166
—Employment of Trainmen.....	515	—Descent.....	4198, *200	Westinghouse, Church, Kerr & Co., Orders.....	192
—Financial.....	250, 492	—Terminal Station.....	192	Westinghouse Electric & Manufacturing Co., 226, 314, 493, 520, 552	
—Overcapitalization.....	*524	—Track and Roadway.....	57	—Electric Locomotives for Chicago Subways.....	*195
—Public Relations.....	21, 276, *285, 362, 393, *578	—Traffic.....	580	—Electrically Heated Glue Pot.....	*281
—Carriage Report.....	*518	Washington & Gettysburg Railroad, Track and Roadway.....	134, 397, 518	—Motor Starter Boxes.....	*404
—Employment of Trainmen.....	515	Washington & Gettysburg Railroad, Track and Roadway.....	134, 397, 518	—Orders.....	226
—Financial.....	250, 492	Washington Patuxent & Drum Point Railroad, Incorporated.....	462	—Reorganization.....	100, 135, 165
—Overcapitalization.....	*524	Washington Railway & Electric Co.—		Westinghouse Machine Co., 29, 343, 435, 467, 610	
—Public Relations.....	21, 276, *285, 362, 393, *578	—Changes in Control.....	192, 551, 610	—Double-Flow Steam Turbines, Pittsburgh Railways Co.....	*642
—Repair Work Record.....	*327	—Financial.....	520, 552, 610	—Gas Engines.....	372, 638
—Transfer Methods.....	*299	—Rolling Stock.....	248, 397, 518	—Steam Turbine Development.....	372, 638
United Railways Co. of St. Louis—		Transfer System.....	129	Weston, George, Report on Chicago Elevated Loop.....	515
—Annual Report.....	473	Washington Traction Co., Financial.....	464	Weston Electrical Instrument Co.—	
—Dividends.....	28, 399	Washington Water Power Co. (Spokane)—		—Meters.....	254
—Earnings.....	28, 250, 370, 519, 663	—Dividends.....	399	—Recording Mill-Voltmeter and Shunt Ammeter.....	*31
—Financial.....	225	Washington Westminster & Gettysburg Railroad, Track and Roadway.....	37, 490, 582	Westside Electric Street Railway, Rolling Stock.....	312
—Carriage Report.....	*518	Waste, G. E. Motor, Hazy Waste Works, Waterloo, Cedar Falls & Northern Railway—		Wetzel & Tyler Railway, Financial.....	626
—Substations, Portable.....	*480	—Cars, Combination Passenger and Baggage.....	425	Whatecom County Railway & Light Co.—	
—Transmission System.....	*480	—Financial.....	551, 610	—Dividends.....	281
—Traffic During 1907.....	186	—Track and Roadway.....	248, 397, 518	—Earnings.....	134, 70, 584
United Railways Investment Co.—		Transfer System.....	129	Wheatland Street Railway, Track and Roadway.....	222
—Annual Report.....	557	Washington Traction Co., Financial.....	464	Wheel Boring Mill, Sellers.....	522
—Financial.....	133, 551	—Dividends.....	399	Wheel Truing Brake Shoe Co.....	99
United States Graphite Co., Lubricating Graphite.....	137	Washington Westminster & Gettysburg Railroad, Track and Roadway.....	37, 490, 582	Wheeler Condenser & Engineering Co.....	495
United Traction & Electric Co., Dividends.....	342	Wason Manufacturing Co., Orders.....	552	Wheeling & Western Traction Co., Incorporated.....	581
United Traction Co. (Albany)—		Waste, G. E. Motor, Hazy Waste Works, Waterloo, Cedar Falls & Northern Railway—		—Wheels—	
—Fares.....	546	—Cars, Combination Passenger and Baggage.....	425	—Flat Spots, By E. L. Hancock.....	*242
—Financial.....	281, 312, 580	—Financial.....	551, 610	—Steel Versus Iron.....	170
—Freight Rates.....	580	—Track and Roadway.....	248, 397, 518	White, J. G. & Co., 29, 493, 585	
—Track and Roadway.....	368	Transfer System.....	129	Wichita Railroad & Light Co., Track and Roadway.....	278
United Traction Co. (Reading)—		Washington Traction Co., Financial.....	464	Wight, C. L., Interstate Commerce Commission Statistics and Accounts.....	513
—Traffic Light.....	278	—Dividends.....	399	Williamsport Passenger Railway—	
—Track and Roadway.....	57, 278	Washington Westminster & Gettysburg Railroad, Track and Roadway.....	37, 490, 582	—Car House.....	281
Utah Light & Railway Co.—		Wason Manufacturing Co., Orders.....	552	—Shops.....	250
—Car House.....	664	Waste, G. E. Motor, Hazy Waste Works, Waterloo, Cedar Falls & Northern Railway—		Wilmington, Edgemoor Electric Railway, Financial.....	225
—Cars, Semi-Convertible.....	*403	—Cars, Combination Passenger and Baggage.....	425	Wilmington City Railway, Strike.....	622
—Carriage Report.....	363	—Financial.....	551, 610	Wilmington Railway & Electric Co., Annual Report.....	319
—Track and Roadway.....	339	—Track and Roadway.....	248, 397, 518	Wilson, James G., Manufacturing Co.....	585
Utica & Mohawk Valley Railway—		Transfer System.....	129	Wilson Co., The.....	552
—Dividends.....	38	Washington Traction Co., Financial.....	464	Winchester & Washington Railway, Power Plant.....	582
—Earnings.....	370	—Dividends.....	399	Window Fixtures, Curtain Supply Co.....	*314
—Financial.....	370	Washington Westminster & Gettysburg Railroad, Track and Roadway.....	37, 490, 582	Windows—	
—Track and Roadway.....	368	Wason Manufacturing Co., Orders.....	552	—Anti-Rattler Device, Gaba.....	*283
—Trademark.....	*182	Waste, G. E. Motor, Hazy Waste Works, Waterloo, Cedar Falls & Northern Railway—		—Compression Sash Fixture, Edwards.....	*345
V		Waterloo, Cedar Falls & Northern Railway—		Windsor, Essex & Lake Shore Rapid Railway—	
Vacuum Cleaner Co.....	98, 135	—Cars, Combination Passenger and Baggage.....	425	—Financial.....	281
Vacuum Impregnating Manufacturing Co.....	637	—Financial.....	551, 610	—Track and Roadway.....	131, 397, 449
Vaile & Kiems, Trolley Wheel and Bushing.....	385	—Track and Roadway.....	248, 397, 518	Windsorsville & East Hartford Street Railway, Track and Roadway.....	190
Vallejo & Northern Railway, Track and Roadway.....	464	Watertown, N. Y., Black River Traction Co., Single-Truck Cars Without Ambrators.....	*144	Winnabago Traction Co.—	
—Incorporated.....	583	Wausau Street Railroad, Power Plant.....	278	—Effect of 2-Cent Steam Railway Fares on Traffic.....	75
—Power Plant.....	662	Waverly Sayre & Athens Traction Co., Fares.....	580	—Rolling Stock.....	192, 281, 312
Van Brunt Street & Erie Basin Railroad, Rolling Stock.....	192	Weber, H. L., Construction Car, Ft. Wayne & Wabash Valley Traction Co.....	*156	—Track and Roadway.....	432, 490
Van Buren Street & C. Advertising Methods.....	30	—Structures for Tracks in Streets.....	*191	Winnipeg Electric Railway—	
Varnishes, Insulating.....	46	Weber Gas Engine Co.....	282, 343	—Annual Report.....	319
Vauclain, A. C., Electric Motor and Trailer Trucks.....	*332	Weber Monessen Bellevorn & Fayette City Street Railway, Rolling Stock.....	134	—Dividends.....	370
Veblen Traction Co., Track and Roadway Ventilation.....	368	Weeks, H. E., Classification of Operating Expenses.....	442	—Financial.....	225
—Cars.....	*167	Welding Torment.....	447	—Track and Roadway.....	432, 490
—Detroit Unit.....	181	—Chicago City Railway.....	*447	Winnipeg Electric Railway.....	319
—New York Central Power Stations.....	*494	—Indiana Union Traction Co.....	*447	—Annual Report.....	319
Ventura Terminal Railway, Track and Roadway.....	96	Wellburg Bethany & Washington Traction Co., Track and Roadway.....	582	—Dividends.....	370
Vera Cruz, Mex., Electric Railway Service.....	401	Wendell & MacDuffie.....	552	—Financial.....	225
Vera Cruz Electric Light Power & Traction Co., Power Plant.....	637	Westboro & Hopkinton Street Railway, Fares.....	307	—Track and Roadway.....	222
Vicksburg Railway & Light Co., Financial.....	637	West Chester Kennett & Wilmington Electric Railway, Financial.....	312	Winona Interurban Railway—	
Vicksburg Traction Co., Incorporated.....	633	West Chester, Kennett & Wilmington Electric Railway, Financial.....	312	—Financial.....	225
Vincennes Traction & Light Co.—		West Chester, Kennett & Wilmington Electric Railway, Financial.....	312	—Steam Railways Refuse to Interchange Traffic.....	633
—Financial.....	192	West Chester, Kennett & Wilmington Electric Railway, Financial.....	312	—Track and Roadway.....	282, 582
—Track and Roadway.....	278	West Chester, Kennett & Wilmington Electric Railway, Financial.....	312	Wisconsin Electric Service Co., By E. H. Meyer.....	559
Vincennes West Baden & Louisville Railroad, Track and Roadway.....	490	West Chester, Kennett & Wilmington Electric Railway, Financial.....	312	Wisconsin Engine Co.....	282, 313
Virginia Passenger & Power Co.—		West Chester, Kennett & Wilmington Electric Railway, Financial.....	312	Wood, Charles N., Co.....	467
—Power Plant.....	190	West Chester, Kennett & Wilmington Electric Railway, Financial.....	312	Wood River East Alton & Bunker Hill Traction Co.—	
—Substation.....	582	West Chester, Kennett & Wilmington Electric Railway, Financial.....	312	—Incorporated.....	606
—Transfers.....	546	West Chester, Kennett & Wilmington Electric Railway, Financial.....	312	—Track and Roadway.....	607
Visalia Electric Railroad.....	360	West Chester, Kennett & Wilmington Electric Railway, Financial.....	312	Woodman, R., Manufacturing Co.....	313
—Track and Roadway.....	57	West Chester, Kennett & Wilmington Electric Railway, Financial.....	312	Woodstock & Syracuse Traction Co., Incorporated.....	488
Vordermark, H. E., Employees' Mutual Benefit Association, Ft. Wayne & Wabash Valley Traction Co.....	647	West Chester, Kennett & Wilmington Electric Railway, Financial.....	312		
Wesland, H. H., Testimonial Dinner.....	219	West Chester, Kennett & Wilmington Electric Railway, Financial.....	312		
Wesley Iron Works, Electric Shovel.....	316	West Chester, Kennett & Wilmington Electric Railway, Financial.....	312		
Vulcan Iron Works Co.....	520	West Chester, Kennett & Wilmington Electric Railway, Financial.....	312		
Vulcan Steam Shovel Co.....	520	West Chester, Kennett & Wilmington Electric Railway, Financial.....	312		
W		West Chester, Kennett & Wilmington Electric Railway, Financial.....	312		
Wabash Valley Railroad, Track and Roadway.....	57, 278, 490	West Chester, Kennett & Wilmington Electric Railway, Financial.....	312		

\*An asterisk indicates maps, portraits or other illustrations. †A dagger indicates an editorial.

Woodstock Marenzo Genoa & Seacombe Electric Railway, Track and Roadway ..... 190  
 Worcester Consolidated Street Railway—  
 —Electrolysis Suit ..... 306  
 —Fares ..... 237  
 —Financial ..... 28  
 Worcester Railway Supply Co., Double-Acting Fenders ..... \*402  
 Wrecking Jacks ..... 4555  
 Wright, W. H. S., Supply Co. .... 228  
 Wyckoff Pipe & Creosoting Co. .... 467

Y  
 Yakima Intervalley Electric Railroad—  
 —Incorporated ..... 220  
 —Track and Roadway ..... 607  
 Yakima Valley Transportation Co., Track and Roadway ..... 26, 549, 582  
 Yazoo City Light Water & Sewerage Plant, Rolling Stock ..... 606  
 York & Shrewsbury Electric Railway, Track and Roadway ..... 268  
 York Haven Water Power Co., Power Plant ..... 607

York, Pa., Track and Roadway ..... 464  
 York Railways Co.—  
 —Effect of 2-Cent Steam Railway Fares on Traffic ..... 124  
 —Hanover & York Single-Phase Railway \*228  
 —Repair Shops ..... \*440  
 —Track and Roadway ..... 549, 635  
 Youngstown & Ohio River Railroad, Track and Roadway ..... 397

Z  
 Zelnicker Crayon Works ..... 251, 435

PERSONAL

A  
 Abbott, Jack ..... 58  
 Ackerman, J. Walter ..... 223  
 Adams, Martin ..... 27  
 Adkins, H. H. \*608, 635  
 Ager, J. W. .... 29  
 Ahorn, H. .... 163  
 Aiken, H. C. .... 635  
 Allen, John ..... 132  
 Anderson, A. A. .... 132  
 Anderson, Samuel ..... 519  
 Andrew, J. M. .... 279  
 Andrews, James D. .... 132  
 Angus, S. F. .... 280  
 Apperson, R. D. .... 97  
 Arnold, B. M. .... 132  
 Atwood, W. B. .... 313  
 Averill, E. S. .... 313  
 Ayars, David P. .... 635

B  
 Bailey, W. P. .... 132  
 Baldwin, C. D. .... 97  
 Baldwin, Walter H. .... 552  
 Baughert, J. J. .... 608  
 Beard, J. F. .... 310, 368  
 Bares, A. .... 368  
 Barr, Thomas Carson ..... 280  
 Barron, Adolph M. \*433  
 Barton, Guy C. .... 96, 132  
 Belong, R. B. .... 539  
 Bennion, Lisle ..... 163  
 Benson, Fred M. .... 279  
 Bergdoll, Louis J. .... 251  
 Berry, Frederick S. .... 49  
 Bibb, Judson ..... 223  
 Bieghler, E. B. .... 132  
 Bigelow, Horatio ..... 519  
 Bilson, O. S. .... 58  
 Bourne, A. .... 313  
 Blecker, John S. 223, 311  
 Blomell, M. J. .... 164  
 Blowitz, T. F. .... 163  
 Boardman, William F. .... 662  
 Boleau, W. E. .... 223  
 Botsford, Geis ..... 132  
 Boucher, Howard M. .... 368  
 Boucher, Josia K. 340, 368  
 Bowler, Frederick G. .... 539  
 Bowen, A. P. .... 250  
 Boyland, Miss R. .... 519  
 Boynton, E. C. .... 491  
 Framlette, J. M. .... 249  
 Braschens, John W. .... 371  
 Breckenridge, A. I. .... 58  
 Bremer, Eugene ..... 96  
 Brigger, G. .... 249  
 Brill, John Albert ..... 400, \*477  
 Brine, G. W. 163, 224, 270  
 Bristol, William H. .... 493  
 Brockway, W. B. .... 369  
 Brown, Henry W. .... 550  
 Brower, Joseph ..... 608  
 Brown, A. J. .... 96  
 Brown, Frank H. .... 223  
 Brown, G. S. .... 339  
 Brown, R. W. .... 518  
 Brush, Matthew C. \*384  
 Buchanan, C. B. .... 340  
 Buchanan, F. T. 310, 339  
 Buchanan, Grant ..... 582  
 Bullock, Rockwood H. 339  
 Burgess, Daniel E. .... 279  
 Burkhardt, A. .... 368, \*398, 491  
 Burns, C. F. .... 608  
 Busby, William ..... \*339  
 Bush, S. S. .... 58  
 Buswell, Willard K. .... 585  
 Busbell, Henry ..... 58  
 Butler, William M. .... 311  
 Byrner, J. V. .... 163

C  
 Calderwood, J. F. .... 433  
 Calvert, Harry S. .... 190  
 Cameron, D. W. .... 339  
 Cannon, D. B. .... 662  
 Carow, D. S. \*368, 388  
 Carothers, J. A. .... 249

C  
 Calderwood, J. F. .... 433  
 Calvert, Harry S. .... 190  
 Cameron, D. W. .... 339  
 Cannon, D. B. .... 662  
 Carow, D. S. \*368, 388  
 Carothers, J. A. .... 249

C  
 Carpenter, F. D. .... \*106  
 Carr, C. E. A. .... 583  
 Carr, George R. .... 371  
 Cartwright, James W. .... 608  
 Cassidy, P. C. .... 249  
 Chambers, W. S. .... 635  
 Chaplin, James C. .... 279  
 Chapman, G. .... 635  
 Clark, Harold A. .... 371  
 Childs, T. M. .... 465, 519  
 Chubbuck, H. E. .... 249  
 Clark, A. T. .... 635  
 Clark, Harold A. .... 371  
 Clark, J. F. .... 249, 379  
 Clarke, H. J. .... 97  
 Clarke, H. P. .... 369  
 Cleary, John J. .... 279  
 Clemens, F. C. .... 58  
 Cliff, P. E. .... 339  
 Coates, Frank R. .... 282  
 Cobb, Bernard C. .... 519  
 Coen, F. W. .... 190  
 Collins, George L. .... 519  
 Collins, J. F. .... 465, 519  
 Colvin, Joseph ..... 249, 339  
 Compton, C. S. .... 368  
 Constock, A. W. .... 582, 583, 608  
 Cooke, R. W. .... 582  
 Cooley, Frank ..... 433  
 Corbin, Bernard ..... 490  
 Cosper, W. P. .... 135  
 Crabbs, J. T. .... 58  
 Crafts, P. F. 491, \*500, 550  
 Crane, C. F. .... 277, \*58  
 Crawford, Alexander ..... L ..... 97  
 Crawford, C. M. .... 518  
 Crawford, W. C. 339, \*398  
 Creveling, H. C. .... 27  
 Critwell, William ..... 635  
 Cushing, Louis E. 58, 96

D  
 Dalton, Charles H. .... 340  
 Dalton, Henry C. .... 223  
 Dascant, Bryr Irwin ..... 635  
 Davies, Henry J. .... 662  
 Davis, W. E. .... 662  
 Deal, E. C. .... 310  
 Dee, William V. \*282  
 Denman, A. .... 27, 250  
 Denry, William ..... 485  
 Diebel, D. C. .... 310  
 Dimmick, E. S. .... 58  
 Dolan, Peter C. 163, \*224  
 Donecker, A. C. .... 27  
 Donovan, Henry ..... 519  
 Downs, E. E. .... \*340  
 Doyle, James J. .... 27  
 Dozier, Melville, Jr. .... 465, \*491  
 Draper, N. C. .... 635  
 Duck, J. J. .... 249  
 Dunlap, A. C. .... 368  
 Dunlop, George ..... 190, 368  
 Dunston, W. J. .... 249  
 du Pont, A. B. .... 582  
 Dutton, A. C. .... 493  
 Dwyer, William Dudley ..... 368  
 Dwyer, William ..... 163

D  
 Dalton, Charles H. .... 340  
 Dalton, Henry C. .... 223  
 Dascant, Bryr Irwin ..... 635  
 Davies, Henry J. .... 662  
 Davis, W. E. .... 662  
 Deal, E. C. .... 310  
 Dee, William V. \*282  
 Denman, A. .... 27, 250  
 Denry, William ..... 485  
 Diebel, D. C. .... 310  
 Dimmick, E. S. .... 58  
 Dolan, Peter C. 163, \*224  
 Donecker, A. C. .... 27  
 Donovan, Henry ..... 519  
 Downs, E. E. .... \*340  
 Doyle, James J. .... 27  
 Dozier, Melville, Jr. .... 465, \*491  
 Draper, N. C. .... 635  
 Duck, J. J. .... 249  
 Dunlap, A. C. .... 368  
 Dunlop, George ..... 190, 368  
 Dunston, W. J. .... 249  
 du Pont, A. B. .... 582  
 Dutton, A. C. .... 493  
 Dwyer, William Dudley ..... 368  
 Dwyer, William ..... 163

E  
 Eberhart, F. S. .... 132  
 Elliott, William, Jr. .... 163, 190  
 Emerson, J. .... 552  
 Emery, Joseph ..... 27  
 Enright, J. M. .... 465  
 Euker, George W. .... 371  
 Evans, A. Y. .... 96  
 Evans, Frederick ..... 27  
 Evans, Paul H. .... 58, 223

F  
 Farmer, Thomas, Jr. .... 60  
 Farrington, H. E. .... 279  
 Fassett, Edgar S. .... 310  
 Felton, S. M. .... 249  
 Fielder, George ..... 279

F  
 Fisher, H. A. .... 279, \*311  
 Flitts, D. H. .... 635  
 Fitzsimmons, Thomas ..... F ..... 372  
 Foley, Henry ..... 664  
 Folsom, Simon R. .... 449  
 Folsom, E. C. .... 519  
 Foster, E. C. .... 518  
 Foster, Horatio A. .... 520  
 Fothergill, H. R. .... 583  
 Fowle, Frank F. .... 371  
 French, Lester G. .... 398

G  
 Gale, Robert ..... 96  
 Garrett, T. .... 465  
 Garton, W. R. .... 98  
 Gaver, Herman ..... 132  
 Gaw, L. R. .... 333  
 Genne, C. W., Jr. .... 193  
 Gerberich, Dennis G. .... 58  
 Gerhardt, P. W. .... 249, 310  
 Gerke, Jacob ..... 608  
 Gibson, Arthur R. .... 608  
 Gillespie, Henry F. .... 552  
 Gillette, A. L. .... 27  
 Gillette, J. C. .... 582  
 Gils, Arthur R. .... 223  
 Glenn, W. H. .... 163, 223  
 Glover, Benjamin H. .... 369  
 Golliday, L. M. .... 310, 369  
 Gordon, D. A. .... 275  
 Goss, William F. M. .... 159  
 Graham, John R. .... 467  
 Grant, Howard F. .... 608  
 Graves, C. E. .... 190, 465, \*491  
 Greeley, John E. .... 223  
 Green, Francis C. .... 493  
 Green, H. C. .... 279  
 Green, Thomas ..... 279  
 Green, W. E. .... 635  
 Grubin, P. C. .... 310  
 Guthrie, Ira E. .... 132

H  
 Haigh, Henry A. 582, \*608  
 Haigh, Samuel ..... 550  
 Hakes, R. M. .... 319  
 Hallett, R. C. .... 98, 135  
 Hamilton, Charles ..... 190  
 Hamilton, Frank T. .... 96  
 Hamilton, George E. .... 368  
 Hamilton, R. B. .... 249  
 Hammond, F. H. .... 163  
 Handlon, Joseph H. 96, 97  
 Hanna, J. B. .... 190, 223  
 Hanson, J. C. .... 223  
 Hapgood, Richard ..... 223  
 Harder, J. A. .... 190  
 Harding, C. F. .... 223  
 Harrington, Daniel ..... 368  
 Harrington, L. W. .... 58  
 Harris, A. H. .... 310  
 Harris, W. 163, 491, 550  
 Harris, W. D. .... 279  
 Harrison, H. C. .... 398  
 Havens, V. L. .... 223  
 Hawley, C. S. .... 371  
 Hayes, R. M. .... 368  
 Hayes, L. C. .... 433  
 Hayward, A. H. .... 519  
 Heim, J. J. .... 360  
 Hein, J. H. 249, 279  
 Henderson, E. W. .... 398  
 Hendricks, Wayne ..... 368  
 Henry, Frank R. \*369, 398  
 Herflicker, D. H. .... 562  
 Hewes, A. J. .... 368  
 Hewitt, C. F. .... 433  
 Hewlett, A. M. .... 29, 60  
 Bilton, George P. .... 491  
 Hibber, Edwin ..... 249  
 Hippee, George B. .... 223

H  
 Haigh, Henry A. 582, \*608  
 Haigh, Samuel ..... 550  
 Hakes, R. M. .... 319  
 Hallett, R. C. .... 98, 135  
 Hamilton, Charles ..... 190  
 Hamilton, Frank T. .... 96  
 Hamilton, George E. .... 368  
 Hamilton, R. B. .... 249  
 Hammond, F. H. .... 163  
 Handlon, Joseph H. 96, 97  
 Hanna, J. B. .... 190, 223  
 Hanson, J. C. .... 223  
 Hapgood, Richard ..... 223  
 Harder, J. A. .... 190  
 Harding, C. F. .... 223  
 Harrington, Daniel ..... 368  
 Harrington, L. W. .... 58  
 Harris, A. H. .... 310  
 Harris, W. 163, 491, 550  
 Harris, W. D. .... 279  
 Harrison, H. C. .... 398  
 Havens, V. L. .... 223  
 Hawley, C. S. .... 371  
 Hayes, R. M. .... 368  
 Hayes, L. C. .... 433  
 Hayward, A. H. .... 519  
 Heim, J. J. .... 360  
 Hein, J. H. 249, 279  
 Henderson, E. W. .... 398  
 Hendricks, Wayne ..... 368  
 Henry, Frank R. \*369, 398  
 Herflicker, D. H. .... 562  
 Hewes, A. J. .... 368  
 Hewitt, C. F. .... 433  
 Hewlett, A. M. .... 29, 60  
 Bilton, George P. .... 491  
 Hibber, Edwin ..... 249  
 Hippee, George B. .... 223

I  
 Insull, Samuel ..... 132  
 Irwin, E. J. .... 491  
 Irwin, Joseph I. .... 132  
 Ivers, Harry B. .... 608

J  
 Jackson, Alexander ..... 311  
 Johnson, James W. .... 435  
 Johnston, J. F. .... 132  
 Jones, William ..... 369  
 Jorian, A. W. .... \*47

\*An asterisk indicates maps, portraits or other illustrations. †A dagger indicates an editorial.



<b>P</b>	<b>R</b>	<b>S</b>	<b>T</b>	<b>W</b>
Pagan, H. W. .... 58	Ralcliffe, George L. .... 582	Scarrett, George R. .... 279	Stitcher, R. B. .... 397, 662	Walcott, A. H. .... 339
Palmer, C. E. .... 223	Ralph, A. C. .... 96	Schindler, A. D. .... 58	Stoddard, J. M. .... 163	Walker, Edwin M. .... 27
Palmer, L. H. .... 465	Raiston, C. A. .... 193	Schoepf, A. F. .... 365	Strechau, R. .... 491	Wallace, Harold U. .... 279
Parry, William C. .... 340	Ramsay, Gordon .... 165	Scott, J. F. .... 468	Sullivan, J. L. .... 279, 310	Wattles, Gordon W. .... 190
Parsons, Hosmer Buckingham .... 608	Rawson, J. S. .... 635	Seullin, Terrance .... 582	Sunny, E. E. .... 135, 610	Wattles, Joseph E. .... 318
Patten, Paul B. .... 250, 493	Redding, S. A. .... 224	Shaffer, George H. .... 310	Symington, E. H. .... 313	Wengel, John .... 311
Patterson, William H. .... 97	Reed, Samuel G. .... 339	Shaw, James F. .... 311		Wessel, J. F. .... 97
Pawling, George .... 251	Rehner, A. W. .... 190	Shepard, Arthur B. .... 321		West, Arthur .... 282, 343
Paxson, Levi .... 27	Reidhead, F. E. .... 223, 311	Shonberger, C. W. .... 193		Weston, Charles V. .... 96
Peabody, Francis S. .... 363	Reynolds, A. E. .... 268	Shepherd, S. R. .... 193		Weston, George .... 96
Perling, H. G. .... 467	Reynolds, A. G. .... 132	Shimlock, G. S. .... 608		Wetmore, E. P. .... 465, 550
Petty, Herbert C. .... 637	Rhines, F. K. .... 98	Shinnick, F. A. .... 635		Whipple, J. L. .... 520, 585
Pevatt, J. S. .... 241	Richards, C. L. .... 313	Shryock, Osborne .... 93		White, Elmer M. .... 662
Phillimore, W. R. .... 329	Richards, E. M. .... 163	Sicker, A. .... 635		Whitfield, George H. .... 340
Pierce, G. O. .... 433	Ritz, H. B. .... 279	Simons, J. E. .... 313		Whitridge, P. W. .... 58
Pitchee, William A. .... 637	Roach, John Millard .... 174	Sims, C. S. .... 310		Wicks, H. T. .... 519
Polk, H. H. .... 197	Roberts, P. C. .... 550	Sinclair, C. A. .... 150		Wilkinson, F. A. .... 339
Polk, Jefferson S. .... 223	Robertson, Edwin W. .... 163, 190	Smith, Arthur B. .... 465		Witt, John .... 190
Pontius, D. W. .... 635	Rogers, Charles L. .... 331	Smith, Arthur L. .... 58, 279		Turner, Charles F. .... 58
Pope, J. R. .... 58	Rohrer, Henry .... 190	Smith, Byron L. .... 559		Turner, W. S. .... 193
Potter, E. A. .... 368	Rolston, William E. .... 97	Smith, C. A. .... 163, 493		Twyford, H. B. .... 330
Potter, E. E. .... 465, 414	Rosenberger, I. R. .... 662	Smith, Fred W. .... 559		
Potter, H. S. .... 27	Ruby, Frederick .... 210	Snow, Walter D. .... 610		
Power, William W. .... 165	Rumsey, J. B. .... 608	Spotts, Charles H. .... 585		
Pratt, George E. .... 610	Ruth, Isaac S. .... 190	Stack, John K. .... 190, 379		
Price, J. Boyd .... 18		Stanford, R. S. .... 310		
Proff, William E. .... 550		Steel, E. P. .... 310		
Pruyn, Robert C. .... 493		Stevens, B. R. .... 97		
		Stephens, A. K. .... 36, 97		
<b>Q</b>	<b>S</b>		<b>U</b>	<b>V</b>
Quest, Harry C. .... 520	Sallee, J. D. .... 58		Underwood, A. W. .... 329	Venable, J. A. .... 520
	Sanville, H. F. .... 60			
	Sawtelle, Walter L. .... 608			

ELECTRIC RAILWAY LEGAL DECISIONS

<b>B</b>	—True Rule with Regard to Rights of Vehicles at ..... 304	House, Moving of Along Track Not Consistent with Company's Rights ..... 361
Boarding Car, Intending Passenger Running After and Falling in Attempting ..... 544	Curve, Rights of Pedestrian Crossing in Front of Standing Car at ..... 361	<b>I</b>
Brakes, Car ..... 602	<b>D</b>	Injunction, Enforcement of Ordinance Requiring Stops Will Not be Enjoined ..... 50
Bumper, Passenger Riding on and Getting Caught in Rope ..... 544	Damages, Verdict of \$3,500 Sustained ..... 21	<b>J</b>
<b>C</b>	Derrick, Line of, Use of to Remove Motors Assumed ..... 89	Jerking—
Car—	Door, Passenger on Platform Falling Off After Opening of by Conductor ..... 392	—Distinction with Regard to in Stopping of Cars ..... 304
—Flying Up of Trap Door ..... 544	<b>E</b>	—Starting Car with Severe While Passenger is Entering Door ..... 204
—None Having Passed in Fifteen Minutes ..... 57	Ejection—	<b>L</b>
—Ordinary Jolting or Jerking of ..... 211	—By Conductor of Trailer, of Passenger Paying Fare on Motor Car ..... 89	Looking and Listening, Getting Down Backward from Vehicle at Side of Track ..... 544
—Ownership of ..... 243	—Requirement as to Stopping of Car Before Electric Railway, Operation of Not to be Interfered with by Unusual Use of Street ..... 361	Lookout, Motorman Must Keep Close and Give Warning at Crossings ..... 577
—Rights of Pedestrian Crossing in Front of a Standing at Curve ..... 361	Employes—	<b>M</b>
—Work, Use of Without Stop ..... 458	—Kind of Required for Exercise of Highest Care ..... 21	Mail Carriers, Municipalities Not Prevented from Giving or Contracting for Free Transportation for ..... 629
—Cleaning and Repairing May be Delegated ..... 22	—Risk from Train, Rail Assumed by Painting Elevated Structure ..... 629	Motorman—
—Liability for Injury in Alighting of Person Boarding Car "Not in Service" ..... 243	—Risk Not Assumed by ..... 89	—Being Inexperienced Not Negligence ..... 304
—Liability for Ownership of, Regardless of Control of Railway ..... 243	—Flying Up of Trap Door in Car ..... 544	—Duty of Begins When Child Leaves Sidewalk and Starts for Tracks ..... 458
—No Liability for Injury from Ordinary and Usual Movements of ..... 243	—No Error in Excluding When Having No Report of Accident ..... 21	—Duty of Observing a Horse or Team Manifesting Fright ..... 50
Reasonableness and Application of Ordinance Requiring Sufficient to Give Seats ..... 332	—Of Negligence, Collision as ..... 243	—Duty of to Hold Car Stationary Until Passengers are in Place of Safety ..... 304
Child—	—Sign of Car "Not in Service" Not Conclusive ..... 243	—Duty of to Man Stopping Over in Way of Car to Unload Wagon ..... 577
—Care Required of ..... 602	—Testimony of Passenger as to Speed Admissible in ..... 458	—Duty of to Man Stopping Over in Way of Car to Unload Wagon Without Looking Guilty of ..... 577
—Leaves Sidewalk and Starts for Tracks, Duty of Motorman Begins When ..... 458	Extension, Consideration of Neighboring Property Benefits from Improving Street So That Railway Company Seeks ..... 49	—Liability of for Injuries from Leaving Controller and Passenger Turning on Power ..... 50
—Sitting on End of Crosstie ..... 602	<b>F</b>	Liability of for Supposed Involuntary Act ..... 243
City, Necessary Party for Settlement of Controversy Between Companies ..... 49	Fare, Duty to Person Not Paying ..... 544	—Must Keep Close Lookout and Give Warning at Crossings ..... 577
Collision—	Company Held to Provision for Half Fare for School Children Regardless of Constitutionality ..... 331	Negligence on Account of Should be Submitted to Jury ..... 204
—Evidence of Negligence ..... 213	Division of Immaterial ..... 22	Requirements of ..... 602
—Right of Motorman When Not Apparent Danger of ..... 49	Municipalities Not Prevented from Giving or Contracting for Half Fares for School Children ..... 629	Moving Car, Alighting from Where Snow is Banked ..... 458
Companies, City Necessary Party for Settlement of Controversy Between Company—	Passengers May Refuse to Allow Others to Pay ..... 602	<b>N</b>
—Acts of Conductor for Which It Must Provide by Reference to Objects Along the Track ..... 361	Firmen, Municipalities Not Prevented from Giving or Contracting for Free Transportation for ..... 629	Negligence—
—Tracks Treated as Property of Company Using Them ..... 22	Gate, Liability for Injury from Defective ..... 50	Conductor Not Guilty of When Several Passengers Signal to Stop Car ..... 602
Conductor—	<b>G</b>	Going from Platform to Step of Moving Car Preparatory to Alighting ..... 89
—Absence of and Inexperience of Motorman May be Considered in Determining Whether Car was at Full Stop or Not ..... 49	Headlight, Concealment of by Dust ..... 577	In Case of Pedestrian Crossing in Front of Standing Car at Curve ..... 361
—Acts of Which Company Must Provide with Reference to Objects Along the Track ..... 361	Highways, Danger Remedy for Enforcing Performance of Duties in Respect to ..... 231	In One Car Passing Another in Discharging Passengers ..... 577
—Duty of to Hold Car Stationary Until Passengers are in Place of Safety ..... 391	Horses—	Man Stopping over in Way of Car to Unload Wagon Without Looking Guilty of ..... 577
—Liability of Assault of on Passenger Waiting for Transfer After Alighting ..... 49	Manifesting Fright, Duty of Motorman ..... 50	Motorman Being Inexperienced Not ..... 304
—Of Trailer, Electing Passenger Paying Passenger on Platform Falling Off After Opening of Door by ..... 392	—What May be Assumed by Motorman on Seeing Horse Near Track ..... 304	—Not Every Increase of Speed or Sudden Jerk Amounts to ..... 361
—Rights of Passenger Carried Beyond Destination and Injured After Leaving Car with Advice of Controller, Liability for Injuries from Motorman Leaving and Passenger Turning on Power ..... 50		—On Account of Motorman Should be Submitted to Jury ..... 204
Crossing—		—Opening of Door of ..... 392
—Motorman Must Keep Close Lookout and Give Warning at ..... 577		Riding Upon Platform Not ..... 392

—What Constitutes, in Manner of Start-  
ing Cars ..... 243  
Notice, Passenger Giving, or Failing to  
Give, of Intended Destination..... 22

**O**  
Ordinance—  
—Enforcement of Requiring Stops Will  
Not be Enjoined..... 50  
—Reasonableness and Application of Re-  
quiring Sufficient Cars to Give Seats..... 332  
—Restricting Speed Applies to Territory  
Added to Municipality..... 243  
Validity of City Permitting the Sale  
Giving Away or Receiving of Trans-  
fers ..... 21

**P**  
Painters, Assume Risk from Third Rail,  
Passenger—  
—Acts Constituting ..... 243  
—Care Required When Given Right to  
Ride on Inner Running Board..... 458  
—Carried Beyond Street and Injured  
Crossing Rough Track..... 629  
Company Not Liable for Injuries to  
One Caused by Another Giving Sig-  
nal to Start..... 577  
—Duty of at Stations..... 577  
—Ejection of, Requirement as to Stopping  
of Car Before..... 304  
—Going from Platform to Alighting..... 89  
—Intending, Falling in Running After  
Car ..... 544  
—Liability of Assault of Conductor on  
When Waiting for Transfer After  
Alighting ..... 49  
—Liability for Injury from Acceleration  
of Speed After Passenger Has Gone  
on Platform to Alight After Signal..... 21  
—Liability for Injuries from Motorman  
Leaving Controller and Passenger  
Turning on Power..... 50  
—May Refuse to Allow Another to Pay  
Fare ..... 602  
—May Testify as to Speed..... 458  
—Not Called Upon to Provide Against a  
Defective Appliance..... 50  
—On Platform Falling Off After Opening  
of Door by Conductor..... 392  
—Paying Fare on Motor Car, Ejected by  
Conductor of Trailer..... 89  
—Riding on Bumper and Getting Caught  
in Rope ..... 544  
—Rights of, Carried Beyond Destination  
and Injured After Leaving Car with  
Advice of Conductor ..... 22  
—What Constitutes ..... 544  
—Whether One Unimportant..... 332  
Passengers—  
—Duty to ..... 243  
—Reasonable Care Only Required as to  
on Running Board..... 630  
—Having Gotten on, Time and Manner  
Cars May be Started..... 304  
—When Relation Terminates..... 629  
—When Several Signal to Stop Car..... 602  
Pedestrian—  
—Duty of Walking on Track..... 577  
—Rights of Crossing in Front of Stand-  
ing Car ..... 361  
Pedestrians, Duty of Walking on or Near  
Tracks Owing to Obstruction in  
Streets ..... 49

Platform—  
—Liability for Injury to Person Going on  
Narrow Between Tracks to Take  
Car ..... 392  
—Passenger on Falling Off After Open-  
ing of Door by Conductor..... 392  
—Policemen, Municipalities Not Prevented  
from Giving or Contracting for Free  
Transportation for ..... 629

**R**  
Remedy, for Performance of Duties in  
Respect to Highways..... 331  
Rope, Passenger Riding on Bumper and  
Getting Caught in..... 544  
Rules, Unreasonableness of..... 89  
Running Board—  
—Care Required of Passenger Given Right  
to Ride on Inner..... 458  
—Reasonable Care Only is Required as  
to Passengers on..... 630  
—Requirements of Conductor in Passing  
Along ..... 361  
—Woman Getting on Does Not Justify  
Emergency Stop..... 602

**S**  
School Children, Company Held to Pro-  
visions for Half Fares for Regard-  
less of Constitutionality of Law..... 331  
Seats, Reasonableness and Application  
of Ordinance Requiring Sufficient  
Cars to Give..... 332  
Signal—  
—Company Not Liable for Injuries to One  
Passenger Caused by Another Giv-  
ing Starting ..... 577  
—Liability for Injury from Acceleration  
of Speed After Passenger Has Gone  
on Platform to Alight After..... 21  
—When Several Passengers Signal to  
Stop Car ..... 602  
Snow, Alighting from Moving Car Where  
Banked ..... 458  
Speed—  
—Liability for Injury from Acceleration  
of After Passenger Has Gone on  
Platform to Alight After Signal..... 21  
—More Cars at Moderate Recommended..... 602  
—Not Every Increase of or Sudden Jerk-  
ing Amounts to Negligence..... 361  
—Ordinance Restricting Applies to Ter-  
ritory Added to Municipality..... 243  
—Passenger May Testify as to..... 458  
—Reasonableness..... 21  
—Regulation Distinction Between Steam  
and Electric Cars..... 304  
Starting—  
—Company Not Liable for Injuries to One  
Passenger Caused by Another Giv-  
ing Signal for..... 544  
—Time and Manner Cars May be Started  
After Passengers Have Gotten on..... 304  
—When Liable for Injuries from..... 243  
Statutes—  
—Constitutionality of Provision in for  
Half Fares for School Children..... 331  
—Transfers Cannot be Limited to One  
Direction ..... 458  
—When Authorizing Trip Between Any  
Two Points Transfers Cannot be  
Limited to One Direction..... 458  
Stations, Duty at..... 577  
Steam Roads, Speed Regulation Distinc-  
tion Between Steam and Electric  
Cars ..... 304

Step—  
—Going from Platform to Step of Moving  
Car Preparatory to Alighting..... 89  
—Use of Work Car Without ..... 458  
—Woman Getting on Does Not Justify  
Emergency Stop ..... 602  
Stopping—  
—Car Must be Stopped Before Ejection of  
Passenger ..... 304  
—Distinction with Regard to Jerks..... 304  
—Enforcement of Ordinance Requiring  
Stops Will Not be Enjoined..... 50  
—Inexperience of Motorman and Absence  
of Conductor May be Considered in  
Determining Whether Car was at  
Full Stop or Not..... 49  
—No Reason for When Way Seems Clear..... 49  
—Woman Getting on Running Board or  
Step Does Not Justify Emergency..... 602  
Street, Moving of Cars Along Track in  
Not Consistent with Company's  
Right ..... 361

**T**  
Track, What May be Assumed on Seeing  
Horse Standing Near..... 304  
Tracks—  
—Company's Possession of Presumed to  
be Exclusive..... 49  
—Duty of Motorman Begins When Child  
Leaves Sidewalk and Starts for..... 458  
—Duty of Pedestrian Walking on..... 577  
—Duty of Pedestrians Walking on or  
Near Owing to Obstructions in  
Streets ..... 49  
—Getting Down Backward from Vehicle  
at Side of..... 544  
—Liability for Injury to Person Going on  
Narrow Platform Between to Take  
Car ..... 392  
—Moving of House Along Track Not Con-  
sistent with Company's Rights..... 629  
—Passenger Injured Crossing Rough..... 629  
—Risk from Third Rail in Elevated As-  
sumed by Painters..... 22  
—Suddenly Turning Team to Cross..... 22  
—Treated as Property of Company Using  
Transfer, Liability for Assault of Con-  
ductor on Passenger Waiting for  
After Alighting ..... 49  
Transfers  
—Cannot be Limited to One Direction  
When Statutes Authorize Trip Be-  
tween Any Two Points..... 458  
—Duty Owed to Person Tendering and  
Not Accepted..... 54  
—Sufficiently Requested ..... 49  
—Validity of City Ordinance Prohibiting  
the Sale, Giving Away or Receiv-  
ing of ..... 21  
Trap Door, Flying Up of in Car..... 544  
Trespasser, Not a..... 392  
Trespassers, Duty to Adult and Infant..... 602  
Trolley Pole Slipping Off Wire..... 544

**V**  
Vehicle—  
—Getting Down Backward from at Side  
of Tracks ..... 544  
—Injury to Man on Stopping Over in Way  
of Car to Unload Wagon..... 577  
Vehicles, True Rule with Regard to  
Rights of at Crossings..... 304

**W**  
Warning, Motormen Must Keep Close  
Lookout and Give at Crossings..... 577

ADVERTISING LITERATURE

**A**  
Aberthaw Construction Co..... 467  
Allis-Chalmers Co..... 491  
—39, 194, 283, 343, 401, 435, 467, 521, 586  
American Asphaltum & Rubber Co..... 586  
American Carbon & Battery Co..... 29  
American Casting Co..... 494  
American Conduit Co..... 494  
American Engineering Co..... 467, 586  
American Spiral Pipe Works..... 252  
Arlington Manufacturing Co..... 491  
Arnold Co..... 193  
Association of American Portland Cement  
Manufacturers ..... 586

**B**  
Blake & Knowles Steam Pump Works..... 136  
Boston Gear Works..... 252  
Boughton, J. A..... 491  
Brill, The J. G. Co..... 39, 136, 401, 467  
Brown Hoisting Machinery Co..... 467  
Brown-Meriam-Abbott Co..... 586  
Bryant Zinc Co..... 491  
Buch's, A., Sons & Co..... 49  
Buckeye Engine Co..... 372

**C**  
Callahan, George, & Co..... 194  
Chandler Brothers & Co..... 166

Chicago Mica Co..... 467  
Cleveland Crane & Car Co..... 435  
Coates Clipper Manufacturing Co..... 521  
Consolidated Car-Heating Co..... 136  
Cortright Metal Roofing Co..... 61  
Crocker-Wheeler Co..... 494  
Cutler-Hammer Clutch Co..... 194

**D**  
Dayton Manufacturing Co..... 29  
Dise Grader & Plow Co..... 343  
Dixon, Joseph, Crucible Co..... 61, 194, 435

**E**  
Eastern Granite Roofing Co..... 166  
Electric Journal..... 194  
Expanded Metal & Corrugated Bar..... 343, 520, 367

**F**  
Fairbanks, Morse & Co..... 29  
Fibre Conduit Co..... 344

**G**  
Garvin Machine Co..... 467  
General Compressed Air & Vacuum Ma-  
chinery Co..... 401

General Electric Co..... 637  
—30, 194, 283, 314, 344, 372, 494, 586, 637  
General Film-Proofing Co..... 494  
General Railway Supply Co..... 494  
General Storage Battery Co..... 494  
Goheen Manufacturing Co..... 29  
Goldschmidt Thermit Co..... 468, 585  
Green Fuel Evaporizer Co..... 544, 372  
Gulick-Henderson & Co..... 99

**H**  
Hart Steel Co..... 372  
Hill, B. B., Manufacturing Co..... 520  
Hyatt Roller Bearing Co..... 552

**I**  
Illinois Malleable Iron Co..... 610  
Inland Empire System..... 467

**J**  
Jackson, George W..... 610  
Jackman, E. S., & Co..... 521  
Johns, H. W., Manville Co..... 135, 282, 401, 435, 520, 586, 637

**K**  
Kalamazoo Railway Supply Co..... 226  
Koehring Machine Co..... 401





# Westinghouse

## No. 92-A Railway Motor

### For City and Suburban Service

*For City Service* a double equipment on cars not exceeding 30 feet over all, and weighing, without equipment, not over 15,000 pounds, will maintain a schedule on a level track of 10 to 13 1-2 miles per hour.

*For City and Suburban Service* a quadruple equipment on double-truck cars not exceeding 40 feet over all, and weighing, without equipment, not over 30,000 pounds, will attain a maximum speed of 23 to 25 miles per hour.

Our Circular No. 1100 goes fully into particulars. Write for it.

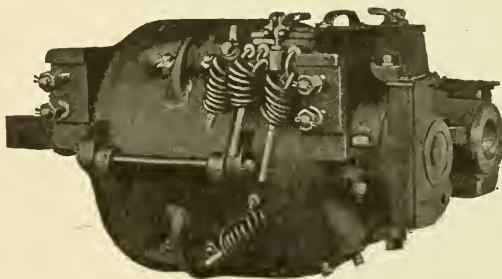

## Westinghouse Electric & Mfg. Co.

Atlanta  
Baltimore  
Boston

Buffalo  
Chicago  
Cincinnati

Cleveland  
Dallas  
Denver

Detroit  
Kansas City  
Los Angeles  
Minneapolis

New Orleans  
New York  
Philadelphia

Pittsburg  
St. Louis  
Salt Lake City

San Francisco  
Seattle  
Syracuse

Canada: Canadian Westinghouse Co., Ltd., Hamilton, Ontario Mexico: G. & O. Braniff & Co., City of Mexico



In Addition to the quick-recharge, quick-service, graduated-release, high-pressure emergency features of the

### Westinghouse "AMM" Automatic Brake

A Straight-Air Release can be provided on the leading or operating car, the brake-cylinder exhaust being controlled at the brake valve, allowing the brakes on that car to be graduated off exactly as in straight-air operation. Under certain conditions this additional feature is of great advantage, as for instance in finishing a high-speed stop smoothly and accurately, or when holding a train on grade at a station or for signal.

Phamplet T-5031 fully describes the AMM equipment

### Westinghouse Traction Brake Co.

Pittsburg, Pennsylvania

## The Roney Stoker

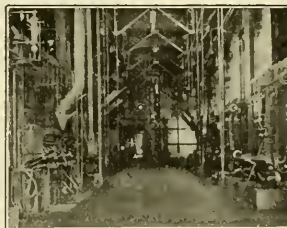

### Claims Recognition

as the Stoker which has been developed to its present state of exceptional efficiency, by hard daily service, under the supervision of experienced men whose only aim was constant improvement.

Over 1,000,000 H. P. in daily service

### The Westinghouse Machine Co.

Pittsburg, Pennsylvania

## ALPHABETICAL INDEX TO ADVERTISEMENTS.

Acme White Lead & Color Works.....	Dearborn Drug & Chemical Works.....27	Macallen Co.....	Security Register & Mfg. Co.....
Advance Lumber Co.....26	Drouv, The G. Co.....25	McGuire-Cummings Mfg. Co.....	Sheaff & Jastad.....30
Allis-Chalmers Co.....21	Drummond Detective Agency.....36	Marshall, R. W., & Co.....23	Simmons, John, Co.....18
Aluminum Co. of America.....27	Durkin Controller Handle Co.....21	Massachusetts Chemical Co.....12	Smith, Peter, Heater Co.....26
Co.....	Earl, C. I.....	Meyers, Fred J., Mfg. Co.....23	Spier Carlson Co.....30
American Electrical Works.....	Eclipse Railway Supply Co.....23	Middletown Car Works.....31	Standard Brake Shoe Co.....14
American Frog & Switch Co.....	Electric Railway Equipment Co.....	Miller Anchor Co.....18	Standard Motor Truck Co.....14
Anderson, Albert & J. M., Mfg. Co.....25	Electric Ky. Improvement Co.....33	Milloy Electric Co., The.....29	Standard Paint Co.....29
Armstrong Oiler Co.....20	Electric Service Supplies Co.....	Model Stoker Co., The.....30	Standard Steel Works.....13
Arnold Company.....30	Engineering Agency, The.....23	Morden Frog & Crossing Wks.....	Standard Underground Cable Co.....
Atlas Anchor Co.....18	Engineers and Contractors.....30	National Brake & Electric Co. 2.....	Standard Varnish Works.....23
Babeock & Wilcox Co.....13	Fairbanks, Morse & Co.....	National Carbide Co.....22	Star Brass Works.....18
Baker, The Wm. C., Heating & Supply Co.....	Ford, Bacon & Davis.....	National Lock Washer Co.....36	Stearns & Webster Engr. Corp.....30
Baldwin Locomotive Works.....15	Galena-Signal Oil Co.....11	Naugle Pole & Tie Co.....26	Stuart-Howland Co.....36
Barbour-Stockwell Co.....	General Electric Co.....35	New York Switch & Crossing Co.....24	Symington, T. H., Co.....17
Barnes, G. H., Hardwood Lumber Co.....26	General Storage Battery Co.....23	Niles Car & Mfg. Co.....36	Telegraph Signal Co.....16
Beaver Dam Malleable Iron Co.....	Gillette Chemical Co.....19	Nuttall, R. D., Co.....	Trolley Supply Co.....
Beidler, Francis, & Co.....	Goben Mfg. Co.....25	Ohio Brass Co.....5	Under-Feed Stoker Co.....18
Bellamy Testrite Mfg. Co.....23	Goldschmidt Thermit Co.....25	Okonite Co., Ltd.....13	United States Graphite Co., The.....24
Bendall, Eugene & Co.....30	Green Engineering Co.....28	Pacific Coast Pole Co.....26	Van Dorn & Dutton Co.....30
Berthold & Jennings.....	Green Fuel Economizer Co.....	Pantasote Co.....27	Van Dorn, W. T., Co.....
Blake Signal & Mfg. Co.....	Grip Nut Co.....33	Patten, Paul B.....	Van Valkenburgh, E. C.....28
Bliss, R., Mfg. Co.....28	Hagy, J. Milton, Waste Wks.....12	Pay-As-You-Enter Car Co.....9	Waddell & Mahon.....36
Bond, Ernest.....29	Hals & Kilham Mfg. Co.....	Powder Specialty Co.....26	Wallace Supply Co.....
Brill, The J. G., Co.....34	Harrison, F. P., Elec. Mfg. Co.....12	Pressed Steel Car Co.....31	Wanted and For Sale Cards.....
Brown, Harold J.....31	Hartshorn, Stewart, Co.....29	Queen & Co.....28	Washington Steel Castings & Coupler Co.....25
Brown Hoisting Machy. Co.....26	Heine Safety Boiler Co.....13	Rail Joint Co.....26	Watson-Stilling Co.....29
Buchner, J. W., Co.....23	Henderson-Ames Co.....23	Railway Steel-Spring Co.....	Wendell & MacDuffie.....
Burnham, Williams & Co.....18	Heywood Bros. & Wakefield Co.....	Recording Fare Register Co.....27	Western Electric Co.....11
Byles, H. M., & Co.....30	Holman, D. F., Ry. Tracklayer Co.....	Reed, Francis, Co.....	Westinghouse Elec. & Mfg. Co.....
Central Inspection Bureau.....30	Homer Commutator Co.....12	Reiter, A. L., & Co.....30	Westinghouse Machine Co.....3
Chase-Shawmutt Co.....11	Hooven-Owens-Rentschler Co.....23	Ridlon, Frank, Co.....19	Westinghouse Traction Brake Co.....
Churchill Cedar Co.....26	Hope Webbing Co.....	Roberts & Abbott Co.....30	Weston Electrical Instrument Co.....
Cincinnati Car Co.....31	Humbird Lumber Co., Ltd.....	Rodger Ballast Car Co.....30	Wharton, Wm., Jr., & Co.....
Cincinnati Frog & Switch Co.....26	Indestructible Fibre Co.....	Rooke Automatic Register Co.....23	Wheeler Condenser & Eng'g Co.....
Cleveland Armature Works.....32	Jewett Car Co.....17	Russell Car & Snow-Plow Co.....31	Wheel Truing Brake Shoe Co.....30
Cleveland Frog & Cross. Co.....24	Johann, F. A.....23	S.-E. Missouri Cypress Co.....26	White, J. G., & Co.....30
Collier, Barron G.....18	Johns-Manville, H. W., Co.....19	St. Louis Car Co.....7	Whitmore Mfg. Co., The.....27
Columbia Construction Co.....	Kalamazoo Ry. Supply Co.....19	St. Louis Car Wheel Co.....27	Wilson, J. G., Mfg. Co.....32
Consolidated Car Bender Co.....28	Kenneth W. Wadsworth, Co.....29	St. Louis Surface & Paint Co.....27	Wood, Milwaukee, Co.....12
Consolidated Car-Heating Co.....26	Kinnear Manufacturing Co.....32	Sanderson & Porter.....30	Woodman, R., Mfg. & Supply Co.....
Contractors' Supply & Equipment Co.....	Lindsay Bros. Co., The.....26	Saxton, E. C.....30	Worcester, C. H., Co.....26
Cooper Heater Co.....27	Lorain Steel Co.....18	Schroeder Headlight Co.....	Zelnicke, Walter A., Supply Co.....23
Crane Co.....16	Lufkin Rule Co.....36	Shimer & Chase Co.....30	
Creaghead Engineering Co.....30	Lumen Bearing Co.....23		
Curtain Supply Co.....23, 36			
Davis, The John, Co.....21			
Detroit Graphite Co.....32			

## CLASSIFIED LIST OF ADVERTISERS.

<b>Advertising, Street Car.</b> Collier, Barron G., Flat Iron Bldg., New York.	<b>Asbestos Materials.</b> Johns-Manville, H. W., Co., New York.	<b>Bells and Gongs—Continued.</b> Kuhlman, The G. C., Car Co., Cleveland. McGuire-Cummings Mfg. Co., Chicago. Ohio Brass Co., Mansfield, O. Reiter, G. C., Canton, O. Stephenson, John, Co., Elizabeth, N. J. Wallace Supply Co., Chicago. Wason Mfg. Co., Springfield, Mass. Western Electric Co., Chicago.	<b>Bonds, Rail—Continued.</b> Goldschmidt Thermit Co., 43 Exchange Pl., New York. Johns-Manville, H. W., Co., New York. Ohio Brass Co., Mansfield, O.
<b>Air Brakes—(See Brakes and Brake Parts).</b>	<b>Axles—(See Wheels and Axles).</b>	<b>Black Lead.</b> Detroit Graphite Co., Detroit, Mich. U. S. Graphite Co., Saginaw, Mich.	<b>Brackets and Cross Arms.</b> Anderson, Albert & J. M., Mfg. Co., Boston. Creaghead Engineering Co., Cincinnati, O. Electric Railway Equipment Co., Cincinnati, O. Electric Service Supplies Co., 200 Plymouth Bldg., Chicago. Lindsay Bros. Co., Spokane, Wash.
<b>Air Compressors—(See Compressors, Air).</b>	<b>Badges and Buttons.</b> Electric Service Supplies Co., 200 Plymouth Bldg., Chicago. Recording Fare Register Co., New Haven, Conn.	<b>Block System—(See Signals).</b>	<b>Blowers—(See Mechanical Draft)</b>
<b>Alloys and Bearing Metals.</b> Brown, H. P., 120 Liberty St., New York. General Electric Co., Schenectady, N. Y. Harrison Elec. & Mfg. Co., 169 South St., New York. Lumen Bearing Co., Buffalo, N. Y. Ohio Brass Co., Mansfield, O. Ridlon, Frank, Co., 200 Summer St., Boston.	<b>Ballast Cars—(See Cars, Ballast).</b> Lorain Steel Co., 18 South St., New York.	<b>Block System—(See Signals).</b>	<b>Boilers.</b> Babeock & Wilcox Co., N. Y. Fairbanks, Morse & Co., Chicago. Green Fuel Economizer Co., Matteawan, N. Y. Heine Safety Boiler Co., 421 Olive St., St. Louis. Rossiter, MacGovern & Co., 17 Battery Pl., New York.
<b>Aluminum Wire, Etc.</b> Aluminum Co. of America, Pittsburg.	<b>Ball Bearing.</b> Symington, T. H., Co., Baltimore, Md.	<b>Blue Printing Machines.</b> Buckeye Engine Co., Salem, O.	<b>Boiler Cleaning Compound.</b> Dearborn Drug & Chemical Works, Chicago. Johns-Manville, H. W., Co., New York.
<b>Amorphous.</b> Miller Anchor Co., Cleveland, O. Electric Service Supplies Co., 200 Plymouth Bldg., Chicago. Miller Anchor Co., Norwalk, O. Ohio Brass Co., Mansfield, O.	<b>Bases—(See Trolley Poles and Fittings).</b>	<b>Bolters.</b> Babeock & Wilcox Co., N. Y. Fairbanks, Morse & Co., Chicago. Green Fuel Economizer Co., Matteawan, N. Y. Heine Safety Boiler Co., 421 Olive St., St. Louis. Rossiter, MacGovern & Co., 17 Battery Pl., New York.	<b>Bonds, Rail.</b> Brown, H. P., 120 Liberty St., New York. Chase-Shawmutt Co., Newburyport, Mass. Electric Railway Improvement Co., Cleveland, O. Electric Service Supplies Co., 200 Plymouth Bldg., Chicago. General Electric Co., Schenectady, N. Y.
<b>Armatures and Coils, Winding and Repairing.</b> Cleveland Armature Works, Cleveland. Electric Service Supplies Co., 200 Plymouth Bldg., Chicago. General Electric Co., Schenectady, N. Y. Harrison Elec. & Mfg. Co., 169 South St., New York. Marshall, R. W., & Co., 95 Nuttall, R. D., Co., Pittsburg. Ohio Brass Co., Mansfield, O. Ridlon, Frank, Co., 200 Summer St., Boston. Symington, T. H., Co., Baltimore, Md. Van Dorn & Dutton Co., Cleveland, O.	<b>Batteries.</b> General Storage Battery Co., 42 Broadway, New York.	<b>Boilers.</b> Babeock & Wilcox Co., N. Y. Fairbanks, Morse & Co., Chicago. Green Fuel Economizer Co., Matteawan, N. Y. Heine Safety Boiler Co., 421 Olive St., St. Louis. Rossiter, MacGovern & Co., 17 Battery Pl., New York.	<b>Brakes and Brake Parts.</b> Allis-Chalmers Co., Milwaukee, Wis. American Car Co., St. Louis. Brill, The J. G., Co., Philadelphia. Electric Service Supplies Co., 200 Plymouth Bldg., Chicago. General Electric Co., Schenectady, N. Y. Kuhlman, The G. C., Car Co., Cleveland. McGuire-Cummings Mfg. Co., Chicago. National Brake & Electric Co., Milwaukee. Stephenson, John, Co., Elizabeth, N. J. Wason Mfg. Co., Springfield, Mass. Westinghouse Traction Brake Co., Pittsburg, Pa.
<b>Armature Lifts.</b> Electric Service Supplies Co., 200 Plymouth Bldg., Chicago.	<b>Bells and Gongs.</b> American Car Co., St. Louis. Brill, The J. G., Co., Philadelphia. Electric Service Supplies Co., 1020-24 Filbert St., Phila.	<b>Boiler Cleaning Compound.</b> Dearborn Drug & Chemical Works, Chicago. Johns-Manville, H. W., Co., New York.	<b>Brakes and Brake Parts.</b> Allis-Chalmers Co., Milwaukee, Wis. American Car Co., St. Louis. American Brake Shoe & Fdry. Co., Mahwah, N. J. American Car Co., St. Louis. Barbour-Stockwell Co., Cambridgeport, Mass.

# A New Year's Gift

For the **General Manager**  
**Purchasing Agent**  
**Superintendent**  
**Electrical Engineer**  
**Master Mechanic**  
and **Storekeeper**



The O. B. Co. Monthly Bulletin will be sent free to anyone connected with executive, purchasing or operative department of an electric railway. Each issue contains timely information regarding new developments in the railway line, descriptions of new devices, news of the trade, digest of current technical literature, want advertising department, etc.

¶ If you do not already receive the Bulletin, kindly *send in your name now*, and mention this advertisement

## THE OHIO BRASS COMPANY

**Mansfield : Ohio**

Please enter my name for free subscription to the **MONTHLY BULLETIN**

Name.....  
Street and No .....  
City..... State.....  
Company.....  
Capacity with Co.....  
( Cut this out and return to us )

## CLASSIFIED LIST OF ADVERTISERS—Continued.

- Brakeshoes—Continued.**  
Brill, The J. G. Co., Philadelphia.  
Kuhlman, The G. C., Car Co., Cleveland.  
McGuire-Cummings Mfg. Co., Chicago.  
Marshall, R. W. & Co., 95 Liberty St., New York.  
Standard Brake Shoe Co., Aurora, Ill.  
Stephenson, John, Co., Elizabeth, N. J.  
Wason Mfg. Co., Springfield, Mass.  
Wharton, Wm., Jr., & Co., Philadelphia.  
Wheel Truing Brake Shoe Co., Detroit.
- Bridges, Bascule and Concrete.**  
Wallace-Coates Engineering Co., Chicago.  
Johann, F. A., 1624 Pierce Bldg., St. Louis.
- Bridge Timbers.**  
Beidler, Francis, & Co., Chgo.
- Brushes, Motors and Dyanmos.**  
Electric Service Supplies Co., 200 Plymouth Bldg., Chicago.  
General Electric Co., Schenectady, N. Y.  
National Carbon Co., Cleveland, O.  
Ridlon, Frank, Co., 200 Summer St., Boston.  
Speer Carbon Co., St. Marys, Pa.
- Bumpers, Car.**  
American Car Co., St. Louis.  
Brill, The J. G. Co., Philadelphia.  
Kuhlman, The G. C., Car Co., Cleveland.  
Stephenson, John, Co., Elizabeth, N. J.  
Wason Mfg. Co., Springfield, Mass.
- Car Cleaner.**  
Gillette Chemical Co., 42 Broadway, New York.
- Car House Doors.**  
Kinnear Mfg. Co., Columbus, O.  
Wilson, J. G., Mfg. Co., New York.
- Car Replacers.**  
Electric Service Supplies Co., 200 Plymouth Bldg., Chicago.  
Fairbanks, Morse & Co., Chgo.  
Kalamazoo Railway Supply Co., Kalamazoo, Mich.  
Ohio Brass Co., Mansfield, O.
- Car Roof Paint, Canvas.**  
St. Louis Surface & Paint Co., St. Louis, Mo.
- Car Seats.**  
American Car Co., St. Louis.  
Brill, The J. G. Co., Philadelphia.  
Hale & Kilburn Mfg. Co., Philadelphia.  
Heywood Bros. & Wakefield Co., Wakefield, Mass.  
Kuhlman, The G. C., Car Co., Cleveland.  
Stephenson, John, Co., Elizabeth, N. J.  
Wallace Supply Co., Chicago.  
Wason Mfg. Co., Springfield, Mass.
- Car Signs—(See Signs, Cars and Track).**
- Car Steps.**  
Electric Service Supplies Co., 200 Plymouth Bldg., Chicago.  
Wallace Supply Co., Chicago.
- Car Trimmings—(See Trimmings, Car).**
- Cars, Ballast.**  
Rodger Ballast Car Co., Chgo.
- Cars, Dump.**  
Fairbanks, Morse & Co., Chgo.  
Middletown Car Works, Middletown, Pa.  
Rodger Ballast Car Co., Chgo.  
Russell Car & Snow-Plow Co., Ridgway, Pa.
- Cars, Passenger and Freight—Continued.**  
Fairbanks, Morse & Co., Chgo.  
Jewett Car Co., Newark, O.  
Johann, F. A., 1624 Pierce Bldg., St. Louis.  
Kuhlman, The G. C., Car Co., Cleveland.  
McGuire-Cummings Mfg. Co., Chicago.  
Niles Car & Mfg. Co., Niles, O.  
Pressed Steel Car Co., Pittsburgh.  
Rodger Ballast Car Co., Chgo.  
Russell Car & Snow-Plow Co., Ridgway, Pa.  
Standard Motor Truck Co., Pittsburgh.  
Stephenson, John, Co., Elizabeth, N. J.  
Wason Mfg. Co., Springfield, Mass.
- Cars, Pay-As-You-Enter.**  
Pay-As-You-Enter Car Co., 26 Cortlandt St., New York.
- Cars, Rebuilt.**  
Detroit Carbuilding & Equipment Co., Detroit, Mich.
- Cars, Second-Hand.**  
Detroit Carbuilding & Equipment Co., Detroit, Mich.  
Marshall, R. W., & Co., 95 Liberty St., New York.  
Zelnicker, Walter A., Supply Co., St. Louis.
- Cars, Steel.**  
Middletown Car Works, Middletown, Pa.  
Pressed Steel Car Co., Pittsburgh.  
Standard Motor Truck Co., Pittsburgh.
- Castings, Brass.**  
Star Brass Works, Kalamazoo, Mich.
- Castings, Iron and Steel.**  
American Brake Shoe & Foundry Co., Mahwah, N. J.  
Green Engineering Co., Com'l Nat. Bk. Bldg., Chicago.  
Lorain Steel Co., Johnstown, Pa.  
National Brake & Electric Co., Milwaukee.
- Catchers—(See Trolley Retrievers and Catchers).**
- Cattle Guards.**  
Fairbanks, Morse & Co., Chgo.  
Kalamazoo Railway Supply Co., Kalamazoo, Mich.
- Cements, Cable and Transformer.**  
Massachusetts Chemical Co., Walpole, Mass.
- Circuit-Breakers.**  
Electric Service Supplies Co., 200 Plymouth Bldg., Chicago.  
General Electric Co., Schenectady, N. Y.  
Western Electric Co., Chicago.
- Coal Handling Machinery—(See Conveyors).**
- Coils—(See Armatures and Coils).**
- Commutators and Parts.**  
Cleveland Armature Works, Cleveland.  
Electric Service Supplies Co., 1020-24 Fibert St., Philadelphia.  
General Electric Co., Schenectady, N. Y.  
Harrison Elec. & Mfg. Co., 169 South St., New York.  
Homer Commutator Co., Cleveland, O.  
Marshall, R. W., & Co., 95 Liberty St., New York.  
Ohio Brass Co., Mansfield, O.  
Stuart-Howland Co., Boston.
- Compressors, Air.**  
Fairbanks, Morse & Co., Chgo.  
General Electric Co., Schenectady, N. Y.  
National Brake & Electric Co., Milwaukee.  
Westinghouse Traction Brake Co., Pittsburgh.
- Concrete Mixers.**  
Contractors' Supply & Equip. Co., Chicago.
- Condensers.**  
Wheeler Con. & Eng. Co., New York.
- Conduits.**  
Electric Service Supplies Co., 200 Plymouth Bldg., Chicago.  
Western Electric Co., Chicago.
- Contractors.**  
Arnold Company, 181 La Salle St., Chicago.  
Byllesby, H. M., Co., Am. Trust Bldg., Chicago.  
Columbia Construction Co., Milwaukee, Wis.  
Creaghead Engineering Co., Cincinnati, O.  
Green Engineering Co., Com'l Nat. Bk. Bldg., Chicago.  
Register, A. L., & Co., 112 N. Broad St., Philadelphia.  
Sanderson & Porter, 32 William St., New York.  
Saxton, E. 841 Bladensburg R., Washington, D. C.  
Sheaff & Jaastad, 83 Broad St., Boston.  
Stone & Webster Engineering Corp., Boston.  
Wharton, Wm., Jr., & Co., Philadelphia.  
White, J. G., & Co., 49 Exchange Pl., New York.
- Controllers and Attachments.**  
Durkin Con. Handle Co., Arcade Bldg., Philadelphia.  
Electric Service Supplies Co., 200 Plymouth Bldg., Chicago.  
General Electric Co., Schenectady, N. Y.  
Harrison Elec. & Mfg. Co., 169 South St., New York.  
Johns-Manville, H. W. Co., New York.  
Marshall, R. W., & Co., 95 Liberty St., New York.  
Westinghouse Electric & Mfg. Co., Pittsburgh.
- Conveyors and Coal Handling Machinery.**  
Green Engineering Co., Com'l Nat. Bk. Bldg., Chicago.  
Northern Engineering Works, Detroit, Mich.
- Cord, Bell and Trolley.**  
American Car Co., St. Louis.  
Brill, The J. G. Co., Philadelphia.  
Electric Service Supplies Co., 1020-24 Fibert St., Philadelphia.  
Kuhlman, The G. C., Car Co., Cleveland.  
Stephenson, John, Co., Elizabeth, N. J.  
Stuart-Howland Co., Boston.  
Wason Mfg. Co., Springfield, Mass.
- Couplers, Car.**  
American Car Co., St. Louis.  
Brill, The J. G. Co., Philadelphia.  
Kuhlman, The G. C., Car Co., Cleveland.  
McGuire-Cummings Mfg. Co., Chicago.  
Ohio Brass Co., Mansfield, O.  
Stephenson, John, Co., Elizabeth, N. J.  
Van Don, W. T. Co., Poughon St., Chicago.  
Wallace Supply Co., Chicago.  
Washburn, E. C., Minneapolis.  
Wason Mfg. Co., Springfield, Mass.
- Coverings, Pipe and Boiler.**  
Johns-Manville, H. W. Co., New York.
- Cranes, Hoists and Lifts.**  
American Car Co., St. Louis.  
Brill, The J. G. Co., Philadelphia.  
Brown Hoisting Machinery Co., Cleveland, O.  
Kuhlman, The G. C., Car Co., Cleveland.  
Northern Engineering Works, Detroit, Mich.  
Stephenson, John, Co., Elizabeth, N. J.  
Van Dorn & Lutton Co., Cleveland, O.  
Wason Mfg. Co., Springfield, Mass.
- Cross Arms—(See Brackets and Cross Arms).**
- Crossing Gates—(See Gates and Guards).**
- Crossings, Track—(See Switches).**
- Curtains, Fixtures and Materials.**  
American Car Co., St. Louis.  
Brill, The J. G. Co., Philadelphia.  
Curtain Supply Co., 93 Ohio St., Chicago.  
Electric Service Supplies Co., 200 Plymouth Bldg., Chicago.  
Hartshorn, Stewart, Co., East Newark, N. J.
- Curtains, Fixtures and Materials—Continued.**  
Kuhlman, The G. C., Car Co., Cleveland.  
Marshall, R. W., & Co., 95 Liberty St., New York.  
National Lock Washer Co., Newark, N. J.  
Fantasole Co., 11 Broadway, New York.  
Stephenson, John, Co., Elizabeth, N. J.  
Wason Mfg. Co., Springfield, Mass.
- Cylinder Oil.**  
Power Specialty Co., 111 Broadway, N. Y.
- Derailing Devices.**  
American Frog & Switch Co., Hamilton, O.  
Cincinnati Frog & Switch Co., Cincinnati, O.  
Cleveland Frog & Crossing Co., Cleveland, O.
- Detective Agency.**  
Drummond Detective Agency, New York.
- Diaphragms.**  
Wood, G. S., Great Northern Bldg., Chicago.
- Doors and Fixtures.**  
American Car Co., St. Louis.  
Brill, The J. G. Co., Philadelphia.  
Kuhlman, The G. C., Car Co., Cleveland.  
Stephenson, John, Co., Elizabeth, N. J.  
Wallace Supply Co., Chicago.  
Wason Mfg. Co., Springfield, Mass.
- Doors, Steel Rolling.**  
Kinnear Manufacturing Co., Columbus, O.  
Wilson, J. G., Mfg. Co., New York.
- Draft, Mechanical—(See Mechanical Draft).**
- Draft Rigging.**  
Van Dorn, W. T. Co., Chgo.  
Wallace Supply Co., Chicago.
- Drills, Track.**  
Brown, H. P., 120 Liberty St., New York.  
Electric Service Supplies Co., 200 Plymouth Bldg., Chicago.  
Fairbanks, Morse & Co., Chgo.  
Kalamazoo Railway Supply Co., Kalamazoo, Mich.  
Marshall, R. W., & Co., 95 Liberty St., New York.  
Reed, Francis, Co., Worcester, Mass.  
Ridlon, Frank, Co., 200 Summer St., Boston.
- Drying Appliances.**  
Green Fuel Economizer Co., Matteawan, N. Y.
- Dynamo and Generators.**  
Cleveland Armature Works, Cleveland, O.  
Fairbanks, Morse & Co., Chgo.  
General Electric Co., Schenectady, N. Y.  
National Brake & Electric Co., Milwaukee, Wis.  
Rosser, MacGovern & Co., 17 Battery Pl., New York.  
Western Electric Co., Chicago.  
Westinghouse Electric & Mfg. Co., Pittsburgh, Pa.
- Economizers, Fuel.**  
Green Fuel Economizer Co., Matteawan, N. Y.
- Electric Instruments.**  
Electric Service Supplies Co., 200 Plymouth Bldg., Chicago.  
General Electric Co., Schenectady, N. Y.  
Johns-Manville, H. W. Co., New York.  
Western Electric Co., Chicago.  
Westinghouse Electric & Mfg. Co., Pittsburgh, Pa.  
Weston Electric Instrument Co., Newark, N. J.
- Electric Railway Supplies, General.**  
Cleveland Armature Works, Cleveland, O.  
Creaghead Engineering Co., Cincinnati, O.  
Electric Service Supplies Co., 200 Plymouth Bldg., Chicago.



# ST. LOUIS CAR CO. ST. LOUIS-MO.

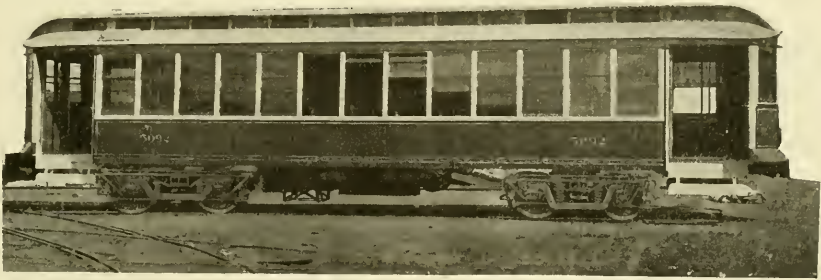

## Builders *of* Electric Cars

of every kind in the largest and best equipped factory in the world.

Specifications & Drawings  
furnished - on - application

## CLASSIFIED LIST OF ADVERTISERS—Continued.

- Electric Railway Supplies, General—Continued.**  
Fairbanks, Morse & Co., Chgo. General Electric Co., Schenectady, N. Y.  
Harrison Elec. & Mfg. Co., 169 South St., New York.  
Johns-Manville, H. W., Co., New York.  
Marshall, R. W., & Co., 95 Liberty St., New York.  
Ohio Brass Co., Mansfield, O.  
Stuart-Howland Co., Boston.  
Wallace Supply Co., Chicago.  
Western Electric Co., Chicago.
- Enamels.**  
Acme White Lead & Color Works, Detroit, Mich.  
St. Louis Surfacor & Paint Co., St. Louis, Mo.
- Engine Apparatus.**  
Green Fuel Economizer Co., Matteawan, N. Y.
- Engineers and Contractors.**  
Arnold Company, Chicago.  
Byllesby, H. M., & Co., Chgo. Columbia Construction Co., Milwaukee, Wis.  
Ford, Bacon & Davis, New York.  
Register, A. L., & Co., Philadelphia.  
Roberts & Abbott Co., Cleveland, O.  
Sanderson & Porter, New York.  
Saxon, E., Washington, D. C.  
Sheaff & Jaastad, Boston.  
Stone & Webster Eng. Corporation, Boston.  
White, J. G., & Co., New York.
- Engines, Gas and Oil.**  
Euckeye Engine Co., Salem, O.  
Fairbanks, Morse & Co., Chgo. Westinghouse Machine Co., Pittsburg.
- Engines, Hoisting.**  
Fairbanks, Morse & Co., Chgo.
- Engines, Steam.**  
Euckeye Engine Co., Salem, O.  
Hooven-Owens-Rentschler Co., Hamilton, O.  
Rossiter, MacGovern & Co., 17 Battery Pl., New York.  
Westinghouse Machine Co., Pittsburg.
- Fans, Exhaust and Ventilating.**  
General Electric Co., Schenectady, N. Y.  
Green Fuel Economizer Co., Matteawan, N. Y.  
Western Electric Co., Chicago.  
Westinghouse Elec. & Mfg. Co., Pittsburg.
- Fare Boxes—(See Electric Railway Supplies).**
- Fare Registers and Register Fittings.**  
Electric Service Supplies Co., 200 Plymouth Bldg., Chicago.  
Recording Fare Register Co., New Haven, Conn.  
Rooke Automatic Register Co., Providence, R. I.  
Security Register & Mfg. Co., 42 Broadway, New York.
- Feedwater Apparatus.**  
Green Fuel Economizer Co., Matteawan, N. Y.  
Wheeler Condenser & Eng'g Co., New York.
- Feed Wire—(See Wire and Cables).**
- Fenders and Guards.**  
Consolidated Car Fender Co., Providence, R. I.  
Eclipse Railway Supply Co., Cleveland, O.  
Electric Service Supplies Co., 1020-24 Fibert St., Phila.  
McGuire-Cummings Mfg. Co., Chicago.  
Marshall, R. W., & Co., 95 Liberty St., New York.
- Flangers, Snow.**  
Kalamazoo Railway Supply Co., Kalamazoo, Mich.  
McGuire-Cummings Mfg. Co., Chicago.  
Ohio Brass Co., Mansfield, O.  
Van Dorn & Dutton Co., Cleveland, O.
- Frogs—(See Switches, Frogs and Crossings).**
- Fuel Economizers—(See Economizers, Fuel).**
- Fuses and Fuse Devices.**  
Chase-Shawmutt Co., Newburyport, Mass.
- Fuses and Fuse Devices—Continued.**  
Electric Service Supplies Co., 200 Plymouth Bldg., Chicago.  
General Electric Co., Schenectady, N. Y.  
Johns-Manville, H. W., Co., New York.  
Western Electric Co., Chicago.  
Westinghouse Elec. & Manufacturing Co., Pittsburg.
- Gaskets, Bronze.**  
Pacer Specialty Co., 111 Broadway, New York.
- Gates and Guards.**  
Bliss, R., Mfg. Co., Pawtucket, R. I.  
Kalamazoo Railway Supply Co., Kalamazoo, Mich.
- Gear Cases.**  
Electric Service Supplies Co., 200 Plymouth Bldg., Chicago.  
General Electric Co., Schenectady, N. Y.  
Marshall, R. W., & Co., 95 Liberty St., New York.
- Gears and Pinions.**  
Electric Service Supplies Co., 200 Plymouth Bldg., Chicago.  
General Electric Co., Schenectady, N. Y.  
Marshall, R. W., & Co., 95 Liberty St., New York.  
Nuttall, R. D., Co., Pittsburg.  
Van Dorn & Dutton Co., Cleveland, O.
- Generators—(See Dynamos).**
- Gongs—(See Bells and Gongs).**
- Graphite.**  
Detroit Graphite Co., Detroit, Mich.  
U. S. Graphite Co., Saginaw, Mich.
- Graphite Paint—(See Paint).**
- Grates, Chain.**  
Green Engineering Co., Com'l Nat. Bk. Bldg., Chicago.
- Grease—(See Lubricants).**
- Grinders.**  
Brown, Harold P., 120 Liberty St., New York.
- Guy Anchors—(See Anchors).**
- Harps, Trolley—(See Trolley Poles and Fittings).**
- Headlights.**  
Electric Service Supplies Co., 200 Plymouth Bldg., Chicago.  
Fairbanks, Morse & Co., Chgo. General Electric Co., Schenectady, N. Y.  
Ridlon, Frank, Co., 200 Summer St., Boston.  
Schroder Headlight Co., Evansville, Ind.  
Stuart-Howland Co., Boston.  
Trolley Supply Co., Canton, O.
- Headlinings, Passenger Car.**  
Indestructible Fibre Co., 45 Broadway, New York.
- Heaters, Car, Electric.**  
Consolidated Car-Heating Co., Albany, N. Y.  
Johns-Manville, H. W., Co., New York.
- Heaters, Car, Hot Water, and Stove.**  
Baker, The Wm. C., Heating & Sup. Co., New York.  
Cooper Heater Co., The, Dayton, O.  
Electric Service Supplies Co., 1020-24 Fibert St., Phila.  
McGuire-Cummings Mfg. Co., Chicago.  
Smith, Peter, Heater Co., Detroit, Mich.
- Heating and Ventilating Apparatus—(See Mech. Draft).**
- Hoists—(See Cranes, Hoists and Lifts).**
- Hose Bridges.**  
Ohio Brass Co., Mansfield, O.
- Hydraulic Machinery.**  
Watson-Stillman Co., 26 Cortlandt St., New York.
- Inspection.**  
Central Inspection Bureau.
- Instruments, Measuring and Testing—(See Electrical Instruments).**
- Insulating Tapes.**  
General Electric Co., Schenectady, N. Y.  
Harrison Elec. & Mfg. Co., 169 South St., New York.  
Massachusetts Chemical Co., Walpole, Mass.  
Okonite Co., Ltd., 253 Broadway, New York.  
Western Electric Co., Chicago.
- Insulations and Insulating Material.**  
Anderson, A. & J. M., Mfg. Co., Boston.  
Creaghead Engineering Co., Cincinnati, O.  
Electric Railway Equipment Co., Cincinnati, O.  
Electric Service Supplies Co., 200 Plymouth Bldg., Chicago.  
General Electric Co., Schenectady, N. Y.  
Johns-Manville, H. W., Co., New York.  
Macallen, The, Co., Boston.  
Massachusetts Chemical Co., Walpole, Mass.  
Ohio Brass Co., Mansfield, O.  
Okonite Co., Ltd., 253 Broadway, New York.  
Ridlon, Frank, Co., 200 Summer St., Boston.  
Standard Paint Co., 100 Willoughby St., New York.  
Standard Varnish Works, New York.  
Stuart-Howland Co., Boston.  
Western Electric Co., Chicago.
- Jacks.**  
American Car Co., St. Louis.  
Brill, The J. G., Co., Philadelphia.  
Electric Service Supplies Co., 200 Plymouth Bldg., Chicago.  
Fairbanks, Morse & Co., Chgo. Kalamazoo Railway Supply Co., Kalamazoo, Mich.  
Kuhlman, The G. C., Car Co., Cleveland.  
Marshall, R. W., & Co., 95 Liberty St., New York.  
Morden Frog & Crossing Co., Chicago.  
Security Register & Mfg. Co., New York.  
Stephenson, John, Co., Elizabeth, N. J.  
Wason Mfg. Co., Springfield, Mass.  
Watson-Stillman Co., 26 Cortlandt St., New York.
- Joints, Expansion—(See Steam Fittings).**
- Joints, Rail.**  
Goldschmidt Thermit Co., 43 Exchange Pl., New York.  
Rail Joint Co., 29 W. 34th St., New York.
- Joints, Welded—(See Rail Joints, Welded).**
- Journal Boxes.**  
American Car Co., St. Louis.  
Brill, The J. G., Co., Philadelphia.  
Kuhlman, The G. C., Car Co., Cleveland.  
McGuire-Cummings Mfg. Co., Chicago.  
Stephenson, John, Co., Elizabeth, N. J.  
Symington, T. H., Co., Baltimore, Md.  
Wason Mfg. Co., Springfield, Mass.
- Journal Lubricators—(See Lubricants).**
- Journal Packing, Steel Wool.**  
Robertson, Wm., & Co., Great Northern Bldg., Chicago.
- Lamps, Arc and Incandescent.**  
Anderson, A. & J. M., Mfg. Co., Boston.  
Electric Service Supplies Co., 200 Plymouth Bldg., Chicago.  
General Electric Co., Schenectady, N. Y.  
Ridlon, Frank, Co., 200 Summer St., Boston.  
Stuart-Howland Co., Boston.  
Western Electric Co., Chicago.  
Westinghouse Electric & Mfg. Co., Pittsburg, Pa.
- Lamp Sockets.**  
Electric Service Supplies Co., 200 Plymouth Bldg., Chicago.  
General Electric Co., Schenectady, N. Y.
- Law Books.**  
Bender, Matthew, & Co., Albany, N. Y.
- Lifts—(See Cranes, Hoist and Lift).**
- Lightning Arresters.**  
Electric Service Supplies Co., 200 Plymouth Bldg., Chicago.  
General Electric Co., Schenectady, N. Y.  
Stuart-Howland Co., Boston.  
Western Electric Co., Chicago.  
Westinghouse Elec. & Manufacturing Co., Pittsburg.
- Line Material.**  
Anderson, A. & J. M., Mfg. Co., Boston.  
Creaghead Engineering Co., Cincinnati, O.  
Johns-Manville, H. W., Co., New York.  
Electric Ry. Equipment Co., Cincinnati, O.  
Electric Service Supplies Co., 200 Plymouth Bldg., Chicago.  
General Electric Co., Schenectady, N. Y.  
Macallen, The, Co., Boston.  
Marshall, R. W., & Co., 95 Liberty St., New York.  
Recording Fare Register Co., New Haven, Conn.  
Stuart-Howland Co., Boston.  
Western Electric Co., Chicago.
- Lock and Nut Washers.**  
Grip Nut Co., 152 Lake St., Chicago.  
National Lock Washer Co., Newark, N. J.
- Lockers, Metal.**  
Electric Service Supplies Co., 200 Plymouth Bldg., Chicago.
- Locomotives.**  
Baldwin Locomotive Works, Philadelphia.  
Johann, F. A., 1624 Pierce Bldg., St. Louis.
- Locomotives, Electric.**  
American Car Co., St. Louis.  
Baldwin Locomotive Works, Philadelphia.  
Brill, The J. G., Co., Philadelphia.  
General Electric Co., Schenectady, N. Y.  
Kuhlman, The G. C., Car Co., Cleveland.  
McGuire-Cummings Mfg. Co., Chicago.  
Stephenson, John, Co., Elizabeth, N. J.  
Wason Mfg. Co., Springfield, Mass.  
Westinghouse Elec. & Manufacturing Co., Pittsburg.
- Locomotives, Gasoline.**  
Fairbanks, Morse & Co., Chgo.
- Lubricants.**  
Dearborn Drug & Chemical Works, Chicago.  
Detroit Graphite Co., Detroit, Mich.  
Galena-Signal Oil Co., Franklin, Ill.  
U. S. Graphite Co., Saginaw, Mich.  
Whitmore Mfg. Co., Cleveland, O.
- Lumber.**  
Barnes, G. H., Hardwood Lumber Co., St. Louis, Mo.  
Beider, Francis, & Co., Chgo. Berthold & Jennings, St. Louis, Mo.  
Lindsay Bros. Co., Spokane, Wash.  
S-E. Missouri Cypress Co., Campbell, Mo.
- Lumber, Asbestos.**  
Johns-Manville, H. W., Co., New York.
- Malleable Iron.**  
Beaver Dam Malleable Iron Co., Beaver Dam, Wis.
- Measuring Tapes.**  
Lufkin Rule Co., Saginaw, Mich.
- Mechanical Draft.**  
Green Fuel Economizer Co., Matteawan, N. Y.
- Meters.**  
Johns-Manville, H. W., Co., New York.  
Weston Electrical Instrument Co., Newark, N. J.

Continued Successful Operation of

# Pay-As-You-Enter Cars

has demonstrated that it is far better and more satisfactory

- to run more cars during rush hours
- to furnish a seat to practically every passenger
- and to get a fare from every passenger before entering the car

than to follow the old plan of running a smaller number of crowded cars, filled with dissatisfied passengers, a large percentage of whom have escaped the payment of fares.

Add to these advantages the greatly increased safety of operation (because of the constant presence of the conductor on the rear platform) and the increased speed (because of the improved method of loading and unloading passengers) and you have the principal reasons why the

## PAY-AS-YOU-ENTER CAR

is the greatest fare-collection improvement in the history of street railways.

We license manufacturers and railways to build and use the Pay-As-You-Enter Car, the patents on which are owned by

## The Pay-As-You-Enter Car Company

DUNCAN McDONALD,  
*President* 26 Cortlandt Street, New York

THOS. W. CASEY,  
*Manager*

## CLASSIFIED LIST OF ADVERTISERS—Continued.

- Molded Goods.**  
Massachusetts Chemical Co., Walpole, Mass.  
Wood, G. S., Great Northern Bldg., Chicago.
- Motors, Electric.**  
Cleveland Armature Works, Cleveland, O.  
Fairbanks, Morse & Co., Chgo. General Electric Co., Schenectady, N. Y.  
National Brake & Electric Co., Milwaukee.  
Rossiter, MacGovern & Co., 17 Battery Pl., New York.  
Western Electric Co., Chicago.  
Westinghouse Elec. & Manufacturing Co., Pittsburg.
- Nut Locks.**  
Grip Nut Co., 152 Lake St., Chicago.  
National Lock Washer Co., Newark, N. J.
- Nuts and Bolts.**  
Grip Nut Co., 152 Lake St., Chicago.  
Lorain Steel Co., Philadelphia.  
National Lock Washer Co., Newark, N. J.
- Oilers.**  
Armstrong Oiler Co., 31st and Chestnut St., Philadelphia.
- Oils—(See Lubricants).**
- Overhead Equipment—(See Electric Railway Supplies).**
- Packings.**  
Electric Service Supplies Co., 200 Plymouth Bldg., Chicago.  
Johns-Manville, H. W., Co., New York.  
Power Specialty Co., 111 Broadway, New York.
- Packing, Steel Wool Journal.**  
Robertson, Wm., & Co., Gt. Northern Bldg., Chicago.
- Paints.**  
Acme White Lead & Color Works, Detroit.  
Detroit Graphite Co., Detroit.  
Gohsen Mfg. Co., Canton, Mass.  
Massachusetts Chemical Co., Walpole, Mass.  
Standard Paint Co., 100 William St., New York.  
St. Louis Surfer & Paint Co., St. Louis, Mo.  
U. S. Graphite Co., Saginaw, Mich.
- Pay-As-You-Enter Cars.**  
Pay-As-You-Enter Car Co., 26 Cortlandt St., New York.
- Pipe Bends and Fittings—(See Steam Fittings).**
- Plumbago.**  
Detroit Graphite Co., Detroit, Mich.  
U. S. Graphite Co., Saginaw, Mich.
- Poles, Metal.**  
Creaghead Engineering Co., Cincinnati, O.  
Electric Railway Equipment Co., Cincinnati, O.  
Electric Service Supplies Co., 200 Plymouth Bldg., Chicago.
- Poles and Ties, Wood.**  
Advance Lumber Co., Cleveland, O.  
Barnes, G. H., Hardwood Lumber Co., St. Louis, Mo.  
Beldier, Francis, & Co., Chgo.  
Berthold & Jennings, St. Louis.  
Churchill Cedar Co., Spokane, Wash.  
Humbird Lumber Co., Sand Point, Idaho.  
Lindsley Bros. Co., Spokane, Wash.  
Nagle Pole & Tie Co., 226 La Salle St., Chicago.  
Pacific Coast Pole Co., Spokane, Wash.  
S. E. Missouri Cypress Co., Campbell, Mo.  
Worcester, C. H., Co., Tribune Bldg., Chicago.
- Punches—(See Ticket Punches).**
- Rail Benders.**  
Electric Service Supplies Co., 200 Plymouth Bldg., Chicago.  
Fairbanks, Morse & Co., Chgo.  
Kalamazoo Railway Supply Co., Kalamazoo, Mich.
- Rail Bonds—(See Bonds, Rail).**
- Rail Brackets.**  
Beaver Dam Malleable Iron Co., Beaver Dam, Wis.
- Rail Drills—(See Drills, Track).**
- Rail Feed Wire—(See Wire and Cables).**
- Rail Joints and Chairs—(See Joints, Rail).**
- Rail Joints, Welded.**  
Goldschmidt Thermit Co., 43 Exchange Pl., New York.  
Lorain Steel Co., Philadelphia.
- Rails, New.**  
Lorain Steel Co., Philadelphia.  
New York Switch & Crossing Co., Hoboken, N. J.  
Wharton, Wm., Jr., & Co., Philadelphia.
- Rails, Relaying.**  
Zelnicke, Walter A., Supply Co., St. Louis.
- Railway Equipment.**  
Johann, F. A., 1624 Pierce Bldg., St. Louis.
- Railway Velocipedes.**  
Fairbanks Morse & Co., Chgo.  
Kalamazoo Railway Supply Co., Kalamazoo, Mich.
- Registers and Fittings—(See Fare Registers).**
- Relays.**  
Weston Electrical Instrument Co., Newark, N. J.
- Roofing.**  
Johns-Manville, H. W., Co., New York.
- Rubber Goods, Mechanical.**  
Wood, G. S., Great Northern Bldg., Chicago.
- Rubber Preservative.**  
Wood, G. S., Great Northern Bldg., Chicago.
- Sand Apparatus.**  
American Car Co., St. Louis.  
Brill, The J. G., Co., Philadelphia.  
Electric Service Supplies Co., 200 Plymouth Bldg., Chicago.  
Kuhlman, The G. C., Car Co., Cleveland.  
Marshall, R. W., & Co., 95 Liberty St., New York.  
Ohio Brass Co., Mansfield, O.  
Ridlon, Frank, Co., 200 Summer St., Boston.  
Stephenson, John, Co., Elizabeth, N. J.  
Wason Mfg. Co., Springfield, Mass.
- Sash Balances and Fixtures.**  
National Lock Washer Co., Newark, N. J.
- Sash Operating Devices.**  
Drouvé, The G. Co., Bridgeport, Conn.
- Seats, Car—(See Car Seats).**
- Shade Rollers—(See Curtains, Fixtures and Materials).**
- Shutters, Steel Rolling.**  
Kinnear Manufacturing Co., Columbus, O.
- Signals.**  
Blake Signal & Manufacturing Co., Boston.  
Telegraph Signal Co., Rochester, N. Y.
- Skylights.**  
Drouvé, The G. Co., Bridgeport, Conn.
- Snow Plows, Sweepers and Scrapers.**  
American Car Co., St. Louis.  
Brill, The J. G., Co., Philadelphia.  
Kalamazoo Railway Supply Co., Kalamazoo, Mich.  
Kuhlman, The G. C., Car Co., Cleveland.  
McGuire-Cummings Mfg. Co., Chicago.  
Russell Car & Snow-Plow Co., Ridgway, Pa.
- Snow Plows, Sweepers and Scrapers—Continued.**  
Stephenson, John, Co., Elizabeth, N. J.  
Wason Mfg. Co., Springfield, Mass.
- Sockets, Waterproof.**  
Johns-Manville, H. W., Co., New York.
- Special Agents.**  
Waddell & Mahon, 1133 Broadway, New York.
- Splicing Compounds and Materials.**  
Massachusetts Chemical Co., Walpole, Mass.
- Springs.**  
American Car Co., St. Louis.  
Brill, The J. G., Co., Philadelphia.  
Kuhlman, The G. C., Car Co., Cleveland.  
McGuire-Cummings Mfg. Co., Chicago.  
Marshall, R. W., & Co., 95 Liberty St., New York.  
Railway Steel Spring Co., 71 Broadway, New York.  
Stephenson, John, Co., Elizabeth, N. J.  
Wason Mfg. Co., Springfield, Mass.
- Sprinkling Cars.**  
American Car Co., St. Louis.  
Brill, The J. G., Co., Philadelphia.  
Kuhlman, The G. C., Car Co., Cleveland.  
McGuire-Cummings Mfg. Co., Chicago.  
Stephenson, John, Co., Elizabeth, N. J.  
Wason Mfg. Co., Springfield, Mass.
- Steam Apparatus.**  
Green Fuel Economizer Co., Matteawan, N. Y.
- Steam Fittings, Etc.**  
Crane Co., Chicago.  
Davis, The John, Co., Chgo.  
Simmons, John, Co., 110 Centre St., New York.
- Power Specialty Co., 111 Broadway, New York.**
- Steel Cars.**  
American Car Co., St. Louis.  
Brill, The J. G., Co., Philadelphia.  
Kuhlman, The G. C., Car Co., Cleveland.  
Stephenson, John, Co., Elizabeth, N. J.  
Wason Mfg. Co., Springfield, Mass.
- Steel Tapes.**  
Lufkin Rule Co., Saginaw, Mich.
- Stokers.**  
Babcock & Wilcox Co., 85 Liberty St., New York.  
Green Engineering Co., Com'l Nat. Bk. Bldg., Chicago.  
Model Stoker Co., Dayton, O.  
Under-Feed Stoker Co., Am., Chicago.  
Westinghouse Machine Co., Pittsburg.
- Storage Batteries—(See Batteries).**
- "Strike-Breakers."**  
Drummond Detective Agency, 9 Ann St., New York.  
Waddell & Mahon, 1133 Broadway, New York.
- Superheaters.**  
Power Specialty Co., 111 Broadway, New York.
- Switches, Frogs and Crossings.**  
American Frog & Switch Co., Hamilton, O.  
Barbour-Stockwell Co., Cambridgeport, Mass.  
Cincinnati Frog & Switch Co., Cincinnati, O.  
Cleveland Frog & Crossing Co., Cleveland, O.  
Fairbanks, Morse & Co., Chgo.  
Lorain Steel Co., Philadelphia.  
Morden Frog & Crossing Co., Rookery, Chicago.  
New York Switch & Crossing Co., Hoboken, N. J.
- Switches, Frogs and Crossings—Continued.**  
Wharton, Wm., Jr., & Co., Philadelphia.
- Switchboards and Switchboard Instruments.**  
Anderson, A. & J. M., Mfg. Co., Boston.  
Chase-Shawmut Co., Newburyport, Mass.  
General Electric Co., Schenectady, N. Y.  
Western Electric Co., Chicago.  
Westinghouse Electric & Mfg. Co., Pittsburg.  
Weston Electrical Instrument Co., Newark, N. J.
- Tapes and Webbing.**  
Hope Webbing Co., Providence, R. I.  
Johns-Manville, H. W., Co., New York.  
Massachusetts Chemical Co., Walpole, Mass.  
Okonite Co., Ltd., 253 Broadway, New York.
- Testing Instruments.**  
Weston Electrical Instrument Co., Newark, N. J.
- Ticket Choppers and Destroyers.**  
Fatten, Paul B., Salem, Mass.
- Ticket Punches.**  
Meyers, Fred J., Mfg. Co., Chicago.  
Woodman Mfg. & Sup. Co., Boston.
- Teplates.**  
Beaver Dam Malleable Iron Co., Beaver Dam, Wis.
- Ties and Poles, Wood—(See Poles and Ties).**
- Timber.**  
Beldier, Francis, & Co., Chgo.  
Lindsley Bros. Co., Spokane, Wash.  
S-E. Missouri Cypress Co., Campbell, Mo.
- Tools, Pneumatic—(See Pneumatic Tools).**
- Track Cleaners and Scrapers.**  
American Car Co., St. Louis.  
Brill, The J. G., Co., Philadelphia.  
Kalamazoo Railway & Supply Co., Kalamazoo, Mich.  
Kuhlman, The G. C., Car Co., Cleveland.  
McGuire-Cummings Mfg. Co., Chicago.  
Marshall, R. W., & Co., 95 Liberty St., New York.  
Ohio Brass Co., Mansfield, O.  
Stephenson, John, Co., Elizabeth, N. J.  
Van Dorn & Dutton Co., Cleveland, O.  
Wason Mfg. Co., Springfield, Mass.
- Track Drills—(See Drills, Track).**
- Track Tools.**  
Electric Service Supplies Co., 200 Plymouth Bldg., Chicago.  
Kalamazoo Railway Supply Co., Kalamazoo, Mich.
- Trimmings, Car.**  
American Car Co., St. Louis.  
Brill, The J. G., Co., Philadelphia.  
Curtain Supply Co., Park Row Bldg., New York.  
Kuhlman, The G. C., Car Co., Cleveland.  
National Lock Washer Co., Newark, N. J.  
Stephenson, John, Co., Elizabeth, N. J.  
Wallace Supply Co., Chicago.  
Wason Mfg. Co., Springfield, Mass.  
Wood, G. S., Great Northern Bldg., Chicago.
- Trolley Guards.**  
Electric Service Supplies Co., 200 Plymouth Bldg., Chicago.
- Trolley Poles and Fittings.**  
General Electric Co., Schenectady, N. Y.  
Johns-Manville, H. W., Co., New York.  
Marshall, R. W., & Co., 95 Liberty St., New York.

# WESTERN ELECTRIC COMPANY

CHICAGO — NEW YORK — PHILADELPHIA — SAINT LOUIS — SAINT PAUL — SAN FRANCISCO  
 CINCINNATI — SEATTLE — ATLANTA — LOS ANGELES — INDIANAPOLIS — CLEVELAND  
 SAN LUIS OBT. —

Start the Year 1908 Right

You can do this by using  
WESTERN ELECTRIC

## D. C. GENERATORS

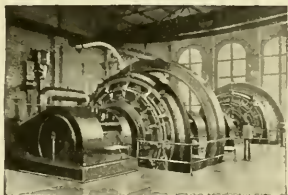

We make them in sizes large or small and can guarantee prompt deliveries. Write for Bulletin No. 3080-C today



# → 93.3% ← REDUCTION

in the drop over a contact carrying 1,000 amperes was the result of a recent test made in a power house of the Commonwealth Edison Company of Chicago, by the use of the

## HAROLD BROWN ALLOYS.

Contacts amalgamated with these Alloys over ten years ago by the Metropolitan West Side Elevated Ry. Co. of Chicago are *still as bright as when first applied.*

In October, 1897, the South Side Elevated R. R. Co. of Chicago amalgamated the terminals of the bonds used on the third rail and recent investigation showed the contacts to be *perfectly free from oxide and as good as when first installed.*

It is of these Alloys that the

## Plastic Rail Bond

is made.

*The bond that will transmit 3,000 amperes without the slightest injury and show but 5 per cent depreciation after eleven years' severe service.*

Consider these FACTS, or, better still,

**TRY IT.**

**HAROLD P. BROWN,** 120 Liberty Street, NEW YORK. ■■■

# Galena-Signal Oil Company

FRANKLIN, PA.

THEIR SPECIALTIES

**STREET RAILWAY LUBRICATION** including both rolling stock and power house equipment.

Same skillful expert supervision given in this service as in steam railway service has produced very satisfactory results. The business of our Street Railway Department has increased beyond every expectation. In 1906 this department sold ten times the number of barrels of oil sold by the same department in 1903.

We are under contract with many of the largest street and interurban railways of the country.

We guarantee cost per thousand miles in street railway service when conditions warrant it.

Write to Franklin, Pennsylvania, for further particulars.

**STEAM RAILWAY LUBRICATION** Sole manufacturers of the celebrated Galena Couch, Engine and Car Oils for steam railway lubrication. Sibley's Perfection Valve Oil for cylinder lubrication, and Perfection Signal Oil for use in railway signal lanterns.

**GALENA RAILWAY SAFETY OIL** Made especially for use in headlights, cab, classification and tail lights, and for switch and semaphore lamps. Burns equally well with the long time as with the one-day burner; with or without chimney as the burner requires. Is pure water white in color; high fire test, low cold test, and splendid gravity.

CHAS. MILLER, President

# SHAWMUT Railway Link Fuses

ACCURATELY RATED CAREFULLY MADE



WE CAN MAKE IMMEDIATE DELIVERY ON STANDARD CAPACITIES AND STANDARD CENTERS

## CAR HEATER FUSES



Type P



Type A

Have you Bulletins Nos. 27 and 100?

**CHASE-SHAWMUT CO.**  
NEWBURYPORT, MASS.

CLASSIFIED LIST OF ADVERTISERS—Continued.

Trolley Retrievers and Catchers.  
Earl, C. I., Bowling Green Bldg., New York.  
Electric Service Supplies Co., 1020-24 Filbert St., Phila.  
Milley Electric Co., Bucyrus O.  
Ridlon, Frank, Co., 200 Summer St., Boston.  
Trolley Supply Co., Canton, O.

Trolley Wagons.  
Kalamazoo Railway Supply Co., Kalamazoo, Mich.

Trolley Wheels—(See Trolley Poles and Fittings).

Trolley Wire—(See Wire and Cables).

Trolleys, Track.  
Cleveland Armature Works, Cleveland, O.

Trucks, Car.  
American Car Co., St. Louis.  
Baldwin Locomotive Works, Philadelphia.  
Brill, The J. G., Co., Philadelphia.  
Kuhlman, The G. C., Car Co., Cleveland.  
McGuire-Cummings Mfg. Co., Chicago.  
Standard Motor Truck Co., Pittsburg, Pa.  
Standard Varnish Works, New York City.  
Stephenson, John, Co., Elizabeth, N. J.

Trucks, Car—Continued.  
Van Dorn & Dutton Co., Cleveland, O.  
Wason Mfg. Co., Springfield, Mass.

Turbines.  
General Electric Co., Schenectady, N. Y.  
Hooven-Owens-Rentschler Co., Hamilton, O.  
Westinghouse Machine Co., Pittsburg, Pa.

Uniforms.  
Henderson-Ames Co., The, Kalamazoo, Mich.

Valves—(See Steam Fittings).

Varnish.  
Acme White Lead & Color Works, Detroit.  
Electric Service Supplies Co., 200 Plymouth Bldg., Chicago.  
Harrison Elec. & Mfg. Co., 169 South St., New York.  
Marshall, E. W., & Co., 95 Liberty St., New York.  
Massachusetts Chemical Co., Walpole, Mass.  
Milloy Electric Co., Bucyrus O.  
Nuttall, R. D., Co., Pittsburg, Pa.  
Ridlon, Frank, Co., 200 Summer St., Boston.  
Standard Paint Co., 100 William St., New York.  
Star Brass Works, Kalamazoo, Mich.  
Trolley Supply Co., Canton, O.  
Walpole Supply Co., Chicago.  
Westinghouse Electric & Mfg. Co., Pittsburg, Pa.

Ventilators.  
Drouvé, The G., Co., Bridgeport, Conn.

Vestlettes.  
Bellamy Vestlette Mfg. Co., Cleveland, O.

Waste, Cotton and Wool.  
Hagy, J. Milton, Waste Wks., Philadelphia, Pa.

Water Softening Apparatus.  
Dearborn Drug & Chemical Works, Chicago.  
Kennicott Water Softener Co., Chicago.

Wheels and Axles.  
American Car Co., St. Louis.  
Brill, The J. G., Co., Philadelphia.  
Griffin Wheel Co., Chicago.  
Kuhlman, The G. C., Car Co., Cleveland.  
Lorain Steel Co., Philadelphia.  
McGuire-Cummings Mfg. Co., Chicago.

Marshall, S. W., & Co., 95 Liberty St., New York.  
Railway Steel-Fring Co., New York.  
St. Louis Car Wheel Co., St. Louis.  
Standard Steel Works, Philadelphia.  
Stephenson, John, Co., Elizabeth, N. J.  
Wason Mfg. Co., Springfield, Mass.  
Wheel Grinders.  
Wheel Truing Brake Shoe Co., Detroit, Mich.

Whitewashing Machines.  
Wallace Supply Co., Chicago.

Window Fixtures.  
Drouvé, The G., Co., Bridgeport, Conn.

Wiping Rags.  
Hagy, J. Milton, Waste Wks., Philadelphia, Pa.

Wire, Aluminum.  
Aluminum Co. of America, Pittsburg, Pa.

Wire, Insulated.  
Aluminum Co. of America, Pittsburg, Pa.  
American Electrical Works, Providence, R. I.  
General Electric Co., Schenectady, N. Y.  
Okonite Co., Ltd., 253 Broadway, New York.  
Standard Underground Cable Co., Pittsburg, Pa.  
Stuart-Howland Co., Boston.

Wire and Cables.  
Aluminum Co. of America, Pittsburg, Pa.  
American Electrical Works, Providence, R. I.  
Bridgeport Brass Co., Bridgeport, Conn.  
General Electric Co., Schenectady, N. Y.  
Okonite Co., Ltd., 253 Broadway, New York.  
Standard Underground Cable Co., Pittsburg, Pa.

**Electric Railway Material**  
of every description  
**F. P. HARRISON ELECTRIC & MFG. CO.**  
(Incorporated)  
169-170 South St. NEW YORK

**GUILFORD S. WOOD**  
HIGH GRADE  
**Mechanical Rubber Goods**  
AIR BRAKE HOSE A SPECIALTY  
P. & W. PRESERVATIVE FOR HOSE  
CAR FURNISHINGS  
GREAT NORTHERN BUILDING, CHICAGO, ILL.

**Ring in the Old  
Don't Buy the New**

1	Get a can of ARMALAC and go after that rotten or burned out armature according to directions—you will save money.	1
8		9
9	Sample for the asking to street railways and manufacturing electric companies.	0
2	SEND FOR OUR BOOKLET ANYWAY.	8

**MASSACHUSETTS CHEMICAL CO.**  
Walpole, Mass.

Waste for Electric Railway Service  
**Motor Packing Waste**

Free from dirt and grit. Easy to pack. All long strands. Good absorber. One packing of the journal box will last longer than with the ordinary waste.

**WIPING WASTE**  
White and colored sanitary cleaned wiping rags.  
Samples submitted.

**The J. Milton Hagy Waste Works**  
433 Spruce St. INCORPORATED Philadelphia

**Hamilton-Corliss Engines**

AWARDED GOLD MEDAL AT WORLD'S FAIR, ST. LOUIS

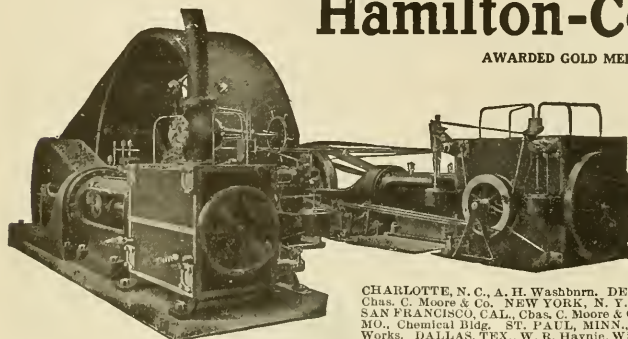

Made in all sizes. We also build other types for all purposes.  
You are cordially invited to visit our factories and to send for catalog.

**The Hooven-Owens-Rentschler Co.**  
Hamilton, Ohio, U. S. A.

BRANCH OFFICES:  
ATLANTA, GA., Equitable Building. BOSTON, MASS., H. E. Rundlett. CHICAGO, ILL., Marquette Building.  
CHARLOTTE, N. C., A. H. Washburn. DENVER, COLO., Stearns-Roger Mfg. Co. LOS ANGELES, CAL., Chas. C. Moore & Co. NEW YORK, N. Y., 38 Cortlandt St. PITTSBURGH, PA., Mackesney Building.  
SAN FRANCISCO, CAL., Chas. C. Moore & Co. SEATTLE, WASH., Chas. C. Moore & Co. ST. LOUIS, MO., Chemical Bldg. ST. PAUL, MINN., R. B. Whitacre & Co. HONOLULU, S. I., Honolulu Iron Works. DALLAS, TEX., W. R. Haynie, Wilson Bldg. NEW ORLEANS, LA., 417 Rennes Bldg.



**TRADE MARK**  
Registered U. S. Patent Office

# The Standard for Rubber Insulation

RAILWAY FEED WIRES insulated with OKONITE are unequalled for flexibility, durability and efficiency, and are in use by the leading Electric Street Railway Companies. OKONITE is preferred above any other insulation for Car Wiring, Telegraph and Telephone Purposes

**Okonite Wires, Okonite Tape, Manson Tape, Candee Weatherproof Wires**

SAMPLES AND ESTIMATES ON APPLICATION

## THE OKONITE Co., Ltd.,

WILLARD L. CANDEE, H. DURANT CHEEVER, Managers.  
GEORGE T. MANSON, Gen'l Supt.; W. H. HODGINS, Secretary.

253 Broadway, NEW YORK

## THE BABCOCK & WILCOX COMPANY

85 Liberty Street, New York

Babcock & Wilcox ——— Stirling ——— A & T Horizontal ——— Cahall Vertical

# WATER TUBE STEAM BOILERS

STEAM SUPERHEATERS

Works: Bayonne, N. J. Barberton, Ohio.

MECHANICAL STOKERS

BRANCH OFFICES:

BOSTON, Delta Bldg.  
PHILADELPHIA, 110-112 North American Bldg.  
SAN FRANCISCO, 53 First Street  
PITTSBURGH, Farmers Deposit Nat. Bank Bldg.  
NEW ORLEANS, 343 Baronne St.

DENVER, 410 Seventeenth St.  
SALT LAKE CITY, 318 Atlas Block  
WASHINGTON, Colorado Building  
CHICAGO, Marquette Bldg.  
ATLANTA, GA., 1132 Candler Bldg.

CLEVELAND, 709 New England Bldg.  
MEXICO CITY, 7 Avenida, Juarez  
HAYANA, CUBA, 110 1/2 Calle de la Habana  
LOS ANGELES, 321 Trust Bldg.  
CINCINNATI, O., Traction Bldg.

# HEINE Water Tube BOILERS

THE KIND THAT ARE IMITATED

ARE MANUFACTURED ONLY BY THE

## HEINE SAFETY BOILER COMPANY

421 Olive Street, St. Louis, Mo.

# Standard "City and Suburban" High Speed Double Truck "Short Wheel Base"

TYPE O-50

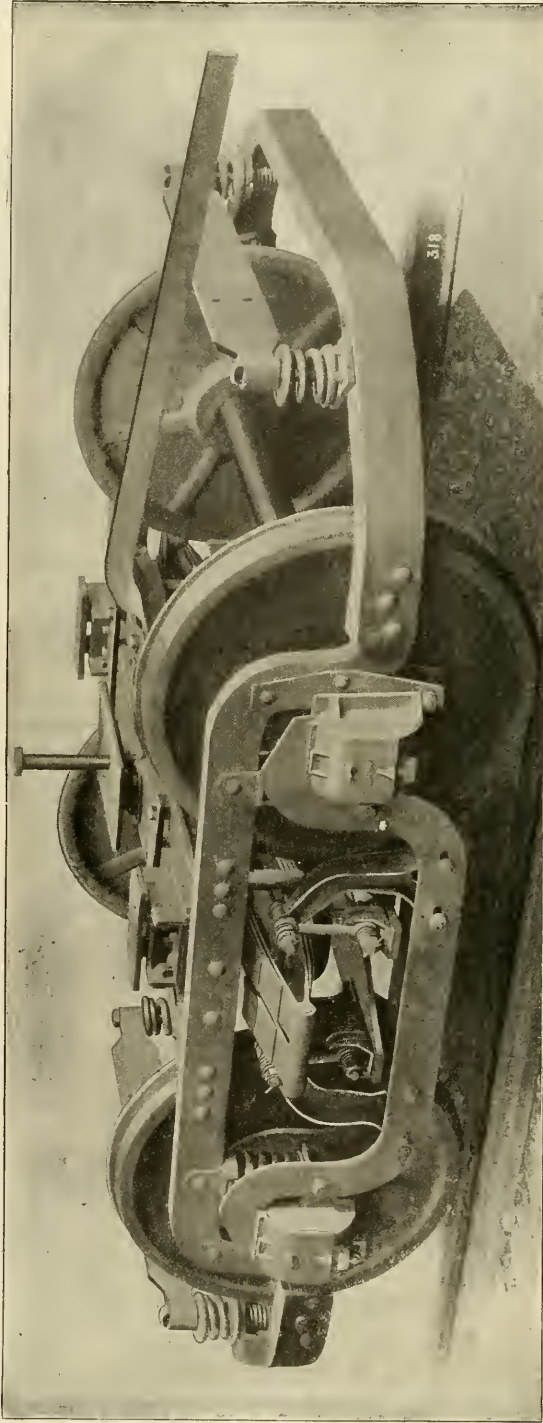

Our new plant is equipped with the most modern truck building machinery and the very best quality of material and workmanship is used in the manufacture of these trucks. M. C. B. standard principles are followed. Frames are made from rolled open hearth steel without welds. We are prepared to build trucks in accordance with purchaser's designs and specifications.

**Standard Motor Truck Company, Frick Bldg., Pittsburg, Pa.**  
 New York Office: 170 Broadway  
 Works: New Castle, Pa.  
 Chicago Office: Fisher Bldg.



# STEEL WOOL Journal Packing

is used in the journal boxes of these  
and other cars of Chicago's South  
Side Elevated Railroad

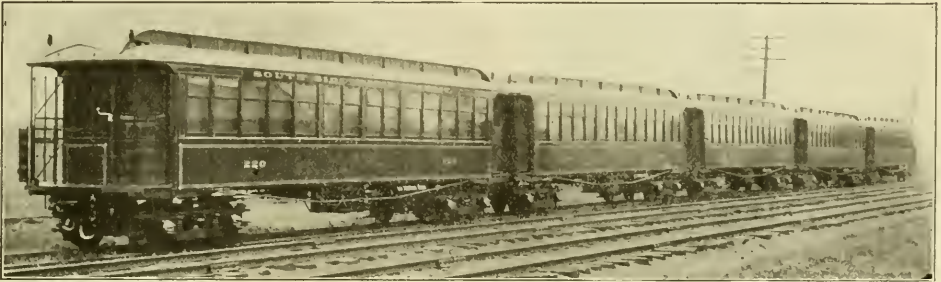

Courtesy the Jewett Car Co.

This perfect packing was not adopted until after the most severe service tests had been made. Continued use proves that Steel Wool Journal Packing saves oil, packing, labor and that it prevents hot boxes and excessive wear.

---

You ought to try Steel Wool Journal Packing.  
Samples are free for the asking.

---

## Wm. Robertson & Company

General Office: Great Northern Bldg., CHICAGO  
Factory: 75 S. Jefferson St., Battle Creek, Mich.

# Ten Seconds is Sufficient

for your dispatcher to set  
a stop signal against any  
car or train approaching  
a meeting point—

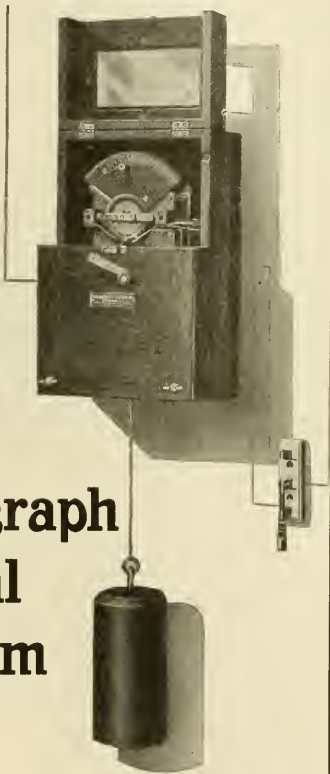

provided,  
of course,  
that your  
line is  
equipped  
with the

## Telegraph Signal System

Dispatcher merely inserts plug in the  
little machine illustrated above—the sys-  
tem does the rest—and does it every time

One Line Wire. Adoption Cost Extremely Low  
Write for Descriptive Literature

### Telegraph Signal Co.

282 State Street, Rochester, N. Y.

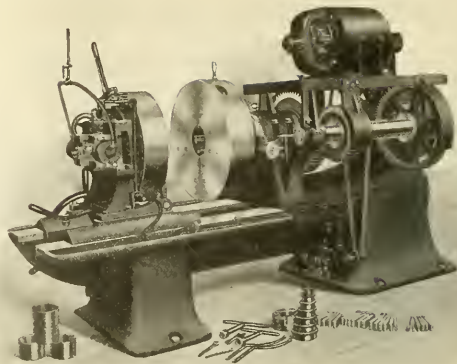

## Improved Pipe Machines

**T**HE E. C. & B. pipe-cutting and  
threading machines, manufactured  
by Crane Co., have been on the market  
for many years and are unsurpassed for  
durability and for rapidity and economy  
of operation. The line is very complete,  
ranging from small hand-operated tools  
up to machines for handling 18-inch pipe.

**Machines are furnished either  
belt, engine or motor driven.**

The illustration shows the No. 3½ tool, capacity  
2½ to 6 inches, designed especially for rapid produc-  
tion. Of the quick grip and sliding die head type,  
it is very substantially and compactly built, there  
being practically but three pieces to the machine.  
The details which play such an important part in  
the operation of pipe machines have been carefully  
attended to. Among these may be mentioned:

Pipe may be gripped or released without  
stopping the machine, by moving a lever,  
owing to the special construction of the  
gripping chuck.

Pipe that is not perfectly round is gripped  
without slipping between the eight remov-  
able roller contact jaws.

For centering or gripping long lengths of  
pipe, an independent three-jaw chuck is  
provided at the rear end of the spindle.

Die head is provided with patented air  
cutting-off device, the most efficient  
means yet invented for cutting pipe.

Changing dies is accomplished by dropping  
the hinger cover.

*Special catalogues of pipe machines sent upon request*

**CRANE CO.**  
CHICAGO  
ESTABLISHED 1855

# Baltimore Center and Side Bearings

FOR ELECTRIC TRUCKS



**Impossible  
to Clog  
Balls**

**No  
Lubrication  
Necessary**

**SAVES:** { FLANGE WEAR  
RAIL WEAR  
TRUCK REPAIRS

**DURABILITY:** { PROVEN  
UNDER  
HEAVIEST  
LOADS

BALTIMORE  
MD.

**THE T. H. SYMINGTON CO.**

CHICAGO  
ILL.

## FOR SALE. FOR QUICK DELIVERY

**6 55-ft. Passenger, Baggage  
and Smoking Car Bodies**

Main Compartment 26' 0"  
Smoking " 10' 6"  
Baggage " 10' 0"  
Seating Capacity, 54

**8 60-ft. Passenger, Baggage  
and Smoking Car Bodies**

Main Compartment 28' 6"  
Smoking " 11' 0"  
Baggage " 8' 0"  
Seating Capacity, 58

**5 52-ft. Passenger and  
Smoking Car Bodies — Double  
End**

Seating Capacity, 60

**3 52-ft. Passenger and  
Baggage Car Bodies — Double  
End**

Seating Capacity, 56

**2 50-ft. Express Car Bodies**

*Write or wire us for further information.*

**The Jewett Car Co.** Newark  
Ohio

CAR ADVERTISING

# Barron & Collier

ALMOST EVERYWHERE

Flat Iron Building, New York.

"THEY NEVER PULL UP"



MILLER ANCHOR CO., Norwalk, Ohio  
ELECTRIC SERVICE SUPPLIES CO., Chicago Agents

It's Great!

Have you received a working model of the Atlas Anchor?

Ask for one—free.

THE ATLAS ANCHOR CO., Cleveland, Ohio



NULLI SECUNDUS

J STOKER & SONS

THE UNDER-SEED STOKER CO. OF AMERICA  
MARQUETTE BLDG. CHICAGO



WE NOW MAKE 75% OF THE TROLLEY WHEELS.  
WE WANT TO MAKE THE OTHER 25%.

THE STAR BRASS WORKS  
KALAMAZOO, MICH.



## BALDWIN LOCOMOTIVE WORKS

BURNHAM, WILLIAMS & CO., PHILADELPHIA, PA., U. S. A.

Builders of **LOCOMOTIVES OF EVERY DESCRIPTION**  
Including **ELECTRIC LOCOMOTIVES** and

# ELECTRIC TRUCKS



Truck built for Indianapolis, New Castle & Toledo Electric Railway Company.

## STANDARD STEEL WORKS,

HARRISON BUILDING PHILADELPHIA, PA.

**SOLID FORGED ROLLED AND STEEL TIERED WHEELS** ELLIPTIC AND COIL SPRINGS  
mounted on axles and fitted with Motor Gears for Electric Railway Service

# PIPE FITTINGS AND VALVES

FOR THE HEATING AND PLUMBING TRADE

TRADE  MARK

## JOHN SIMMONS CO.

104-110 Centre Street, NEW YORK

## THE LORAIN STEEL COMPANY

Girder Rails and High Tee Rails  
High-Grade Special Track Work

GENERAL OFFICES  
THE PENNSYLVANIA BUILDING, PHILADELPHIA, PA.

## ASBESTOS WOOD

AS A SUBSTITUTE FOR  
SLATE, MARBLE OR FIBRE

is without an equal, because it is absolutely fire-proof and has an electrical resistance almost equal to sheet mica. Can be worked with ordinary wood-working tools—holds screws well and can be finished in any colors desired.



### AS A FIREPROOFING MATERIAL

ASBESTOS WOOD is the best fire-proof sheathing known for electric cars. Its use is indicated wherever it is desirable to protect the electrical equipment from grounds and short circuits, and also to prevent danger of fire from the same causes.

ASBESTOS WOOD can be used in almost all cases where wood, slate or marble are usually employed and where fire-proof construction is desired.

WRITE NEAREST BRANCH FOR CATALOG.

**H. W. JOHNS-MANVILLE CO.**



New York  
Milwaukee  
Chicago  
Boston  
Seattle  
Baltimore

Philadelphia  
St. Louis  
Pittsburg  
Cleveland  
Buffalo  
San Francisco

Kansas City  
Los Angeles  
Minneapolis  
New Orleans  
Dallas  
London 720

## GILLETTE SANITARY SPRAY



**CLEANS EVERYTHING  
BUT A GUILTY CONSCIENCE**

Car cleaning made easier and cars kept cleaner.

Does away with the use of water, except in extreme cases, thereby preventing the opening of joints and rotting of timber caused by the use of water.

Kills dust, prevents it from rising while sweeping floors, carpets and upholstery.

It polishes woodwork, mirrors and windows, and preserves varnish and colors.

Kills all germs, thoroughly disinfects and sanitizes the car.

Requires less labor and less expense than any other method of cleaning cars.

Is used in the principal hotels, residences, apartment houses and amusement places, as well as in daily use on the cars of the New York City Ry. Co.

For particulars, address

**GILLETTE CHEMICAL CO.**

42 BROADWAY, NEW YORK CITY

3-6

## Trolley Catchers

THE RIDLON No. 2



Made  
a  
little  
stronger  
than  
the  
service  
requires

Thoroughly up-to-date and embodying many exclusive advantages. Manufactured by skilled mechanics in our own factory, where every detail is given careful supervision.

*Catchers sent on 30 days' trial*

**FRANK RIDLON COMPANY**

200 Summer St., Boston, Mass.

Pacific Coast Representatives:

**THE H. M. ESTES CO.**

GENERAL OFFICE, SAN FRANCISCO, CAL.

Los Angeles, Cal.

Branch Offices:

Portland, Ore.

2

## ROOT Snow Scraper

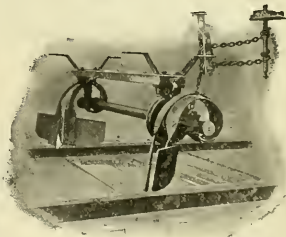

For any type of car, for any type of rail, for any condition of snow the **Root Snow Scraper** gives perfect results.

It is the only Scraper made that cleans out the groove and prevents the wheel flange from compressing the snow into ice — a very important point.

*We guarantee both the Scraper and its results*

**Kalamazoo Railway Supply Co.**

KALAMAZOO, MICH., U. S. A.

5

# Persistence in Advertising

**L**ONG AGO some one said in reference to advertising, "Keeping everlastingly at it brings success." This is just as true today as it was yesterday and will be tomorrow.

¶ But sometimes a manufacturer, who wouldn't expect a sales force to break into a new territory to any extent much under a year's time, expresses surprise because the first few insertions of some new advertising do not produce immediate results.

¶ He is willing to give his salesmen ample time to become acquainted, but seems to think the advertising ought to commence doing business instanter.

¶ Probably he never read an advertisement that made him do immediately as the advertiser desired, yet believes that his advertising ought to make the reader get busy at once.

¶ Be fair! Do *real* advertising and then give it a fair opportunity to make good!

¶ Advertising will help sell your goods, if rightly done. Does it every day for others—will do it for you, too.

¶ You know electric railway men do not lie awake nights figuring how many advertisements they can answer the next day—but their minds *are* open to impressions through advertising—impressions that lead to sales.

¶ These impressions you can make only by "keeping everlastingly at it."

*If you say the word, we will gladly send a representative to discuss an advertising plan for your particular business.*

**Electric Railway Review** 160 Harrison Street  
CHICAGO, U. S. A.

# Allis-Chalmers Company

MILWAUKEE, WIS.

**I**F you are using Christensen air brake equipments, we suggest that you allow us to fill your orders for repair parts, as we have the sole right to manufacture under the Christensen patents and are naturally more interested than our competitors in the quality of material and workmanship of the parts furnished.

A copy of our Bulletin No. 1509, giving the price list of repair parts, with catalogue numbers opposite each item for convenience in ordering, will be sent to you upon request

**Let us quote you prices on your next repair part order**

Save  
Your  
Armatures

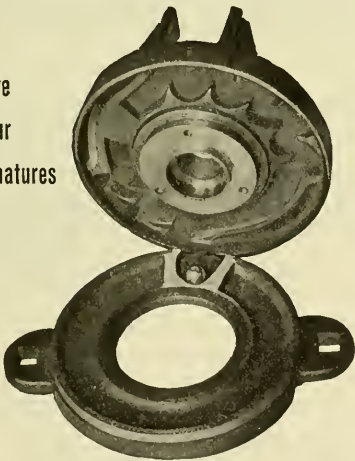

Regulator open

No. 3  
Ball  
Check

## Durkin Controller Handle Co.

Main Office, 1515 Sansom St.  
Treas. Office, 811 Arcade Bldg.  
PHILADELPHIA

SOUTHERN AGENT

UNIVERSAL RAILWAY SUPPLY COMPANY  
BALTIMORE

## “TWO GOOD THINGS”



“Hughson”  
High Pressure  
Reducing  
Valve

“Hochfeldt  
Eclipse”  
Back Pressure  
and  
Relief Valve

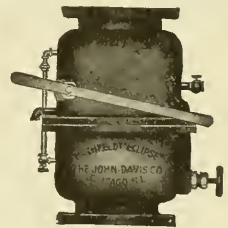

“ARE THE BEST OF THEIR KIND”

Manufactured by

# THE JOHN DAVIS COMPANY

HALSTED 22<sup>ND</sup> AND UNION STS. - CHICAGO

Walter G. Ruggles Co., 54 High St., Boston, Mass., New England Agent  
Send for Catalogue and Prices

We furnish material for power plants to sketch ready for erection

# CLASSIFIED ADVERTISEMENTS

Undeclared advertisements are inserted under this heading at the uniform rate of one cent a word; minimum charge twenty-five cents. Replies directed to this office will be forwarded when required to any address in the United States, Canada or Mexico without extra charge. Advertisements received at the Chicago office by 9 a. m. Thursday will appear in the issue for the same week.

## POSITIONS WANTED.

A young man, 27 years of age, with ten years' experience, wants position as engineer or electrician; unmarried; habits strictly temperate; high-class references. Address "No. 710," care Electric Railway Review, Chicago.

**Wanted**—To make a change in the near future as manager or general superintendent of street railway by an experienced and successful general superintendent; correspondence solicited. Address "No. 517," care Electric Railway Review, Chicago.

**Position by a single man,** 29 years old, practical electrician and machinist, 10 years' experience, familiar with electric car and locomotive repairs, power and substation practices. Non-union man. Address "No. 620," care of Electric Railway Review, New York, N. Y.

A young man (29) with seven years' experience in every branch of the transportation department desires a position with a street railway company anywhere west. Best references as to experience and character. Address "No. 538," care Electric Railway Review, Chicago.

**Position wanted** as master mechanic or shop foreman by a competent man with extensive experience and splendid references. Understands city and interurban cars and equipments in every detail; an expert armature winder, can handle men and repairs economically and successfully. Position as winder accepted if given advancement. Employed but desires change. Address "No. 522," care Electric Railway Review, Chicago.

## POSITIONS WANTED.

**Auditor, experienced** in electric railway and building and construction accounting, wants position with fair-sized company. Energetic and good systematizer. "No. 627," references. Address "No. 527," care Electric Railway Review, Chicago.

**Graduate civil engineer,** Cornell University 1902, experienced in field work and trade journalism, now engaged, desires work with technical journal or publicity department of manufacturing establishment. Address "No. 525," care of Electric Railway Review, Chicago.

**Young man,** 30 years of age, who has nearly completed a course of "Electric Lighting and Railway" in the International Correspondence Schools, desires position which will give him practical experience in power house and switchboard work. Willing to start at a nominal salary. Address "No. 526," care of Electric Railway Review, Chicago.

**Position wanted**—Graduate electrical engineer of five years' experience in the construction and operation of electrical and steam power plant apparatus; its operation and maintenance; has held position of responsibility with large corporation; can handle mechanical and electrical engineering propositions of various kinds successfully; familiar with machine shop practice and the handling of all types of labor; expert on turbo-generator sets. Location no object; 28 years old; unmarried; habits strictly temperate. Highest class references. Address "No. 521," care Electric Railway Review, Chicago.

## POSITIONS WANTED.

**Position wanted** by young man (22), good habits, with interurban road; wishes to gain practical operating experience. No technical training. Good references. Address "No. 523," care Electric Railway Review, Chicago.

**Position wanted** by a thorough practical engineer and machinist; 16 years' experience with compound Corliss engines and turbines, A. C. and D. C. electrical apparatus. Age 35; efficient and reliable; references. Address "No. 520," care of Electric Railway Review, Chicago.

**Experienced and efficient engineer** with power station experience (both planning and construction, as chief engineer and as superintendent of construction) desires position with operating company as engineer, assistant to manager or superintendent. Address "No. 515," care the Electric Railway Review, Chicago.

## POSITIONS OPEN.

**Twelve offices,** covering entire street railway and manufacturing world, 1,000 technical and office positions open. Confidential service; write today, HAP-GOODS, 305 Broadway, New York, or 1010 Hartford Bldg., Chicago.

## MISCELLANEOUS WANTS.

You can sell second-hand cars, machinery and material through advertising on this page. Ask about the special rates. Electric Railway Review, 160 Harrison Street, Chicago.

## BOOKS AND PUBLICATIONS.

Ask us about any book on electric railway and allied subjects. We publish some and sell all that are in print. The Wilson Company, 160 Harrison Street, Chicago.

We want your friends to read the Electric Railway Review. You will do them—and us—a favor by sending their addresses. We will gladly mail free sample copies. Electric Railway Review, 160 Harrison Street, Chicago.

If interested in any phase of steam transportation, you will find every development covered fully and accurately in The Railway Age. It is the leader and acknowledged authority in this field. Ask for free sample copies. The Railway Age, 160 Harrison Street, Chicago.

A copy of "The Motorman and His Duties," the standard handbook on the theory and practice of electric car operation, is worth many times its cost to every man interested in the subject. Send for 16-page pamphlet of sample pages. The Wilson Company, 160 Harrison Street, Chicago.

If you have copies of the Street Railway Review of February or June, 1906, or of the index for 1904, or of the Electric Railway Review of October, 1906, write us at once, stating condition and naming price for each copy. Address "No. 514," care Electric Railway Review, 160 Harrison street, Chicago.

## Wanted—

# A NEW YORK REPRESENTATIVE

for the ELECTRIC RAILWAY REVIEW

—a man thirty-two to thirty-five years old, energetic, resourceful, of pleasing address and staying qualities, who has a good record as a successful advertising salesman. ¶ Our proposition includes more than mere space-selling, as we give advertisers a complete advertising service at the cost of white space. This means that our representative must know what good advertising is and how it is produced, and be able to tell others who don't know but ought to. He must be able to co-operate intelligently with the advertiser in planning advertising campaigns that will help sell goods, though it is not imperative that he be capable of producing finished advertisements. Experience on technical or trade journals, while desirable, is not necessary. ¶ The man who can meet our exacting requirements will be offered an unusual opportunity. In replying, give an idea of salary expected.

THE WILSON COMPANY, 160 Harrison St., Chicago



**R.W. MARSHALL & CO.**  
 95 and 97 Liberty St., New York  
 Second-Hand Machinery and Equipment  
**ELECTRIC RAILWAY MATERIALS**

**FOR SALE CHEAP!**  
 One 1422 eight-wheel locomotive  
 Ten 34-foot 50,000 capacity flat cars  
 Two Greenleaf turntables  
 70 box cars, 40 and 50,000 capacity  
 80 Good Second-hand Bridges  
 Specifications and Blue Prints on application  
**F. A. JOHANN**  
 1624 Pierce Bldg., St. Louis, Mo.

**RAILS**  
*Locomotives Cars Etc.*  
*Bought & Sold*  
*Walter & ZELWICKER Supply Co.*  
 17 ST. LOUIS

WHEN YOU WANT Surveyors, Civil, Mechanical or Electrical Engineers, Draftsmen, Power and Sub-station Attendants—just write us.  
**THE ENGINEERING AGENCY**  
 Monadnock Bldg., Chicago

**ROSSITER, MACGOVERN & CO. (Inc.)**  
 90 West Street, New York  
**ENGINES** Boilers, Locomotives, Cars,  
**GENERATORS** 2nd Hand  
 Transformers, Railway, A. C. & D. C. **MOTORS**

**THE CURTAIN SUPPLY CO.**  
 CAR CURTAINS  
 CHICAGO, 85-93 Ohio Street 1819 Park Row Bldg., NEW YORK

**Gongs** For Street Cars **Bells**  
 G. C. REITER, Canton, Ohio

The Fred. J. Meyers  
**Mfg. Co.** Hamilton, O.  
 Largest Manufacturers in the World of  
**TICKET AND CONDUCTORS' PUNCHES**  
 Send for catalog of 75 different styles of punches with 1000 different dies.  
 Write for special prices.



**TRACKLAYING BY MACHINERY**  
 SIMPLE, RAPID AND ECONOMIC  
 D. F. HOLMAN RAILWAY TRACKLAYER CO., 1102 Ellsworth Bldg., Chicago

**TICKET PUNCHES**  
 Our Cast Steel Ticket Punches are a must for all universally used for cancelling transfer and other tickets.  
 We handle all kinds of Railway Supplies.  
**R. Woodman Mfg. & Supply Co.**  
 63 Oliver St., BOSTON, MASS., U. S. A.

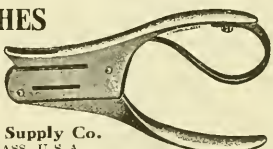

**VOLTALAC**  
 TRADE MARK  
**FOR INSULATING ARMATURE AND FIELD COILS**  
 Almost Every Big Electric Railway in the U. S. and Europe uses it  
**STANDARD VARNISH WORKS**  
 LONDON NEW YORK CHICAGO

**40% SAVED**  
 BY USING  
**Lumen Bronze Axle Bearings**  
 Cast in metal mold—require no-machine finish  
**Lumen Bearing Company**  
 BUFFALO — TORONTO

THE  
**Bellamy Vestlette**  
 For Street Railway Conductors  
**ABSOLUTELY SAFE.** Money cannot be lost or stolen from these pockets **OVER 150,000 IN USE**  
 Saves the price of a coat yearly. Conductor's uniform always presentable. Adopted as a part of the uniform by over 200 Street Railway Companies. Price \$2.00, sent to any address prepaid, where we have no agent. Agents wanted on every line.  
**The Bellamy Vestlette Mfg. Co., Cleveland, O.**  
 and A. F. JURY, 265 Yonge St., Toronto, Canada  
 Patented April 27, 1897



Do you know about our Regulator?  
 ASK US  
**GENERAL STORAGE BATTERY CO**  
 Works, Boonton, N. J. Offices, 42 Broadway, N. Y.



Advertise in the **Electric Railway Review**  
 To get an employe.  
 To secure a job.  
 To sell second-hand machinery, cars, etc.  
 Want Ads cost only one cent a word per insertion. Special rates on "For Sale" Cards—ask about them.

**ECLIPSE Life Guard**  
 Manufactured by the  
**ECLIPSE RAILWAY SUPPLY CO.**  
 Cleveland, Ohio

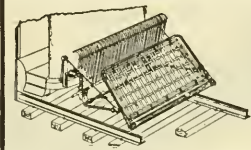

**High Grade Caps**  
 for street railway men. Our prices will interest all who wear caps. Send for Electric Railway Uniform catalog.  
**The Henderson-Ames Co.**  
 Kalamazoo, Mich.





### Orgy of the Growl Devils

You can quiet the riot of the Growl Devils in fast-running electric car gears, save gear wear and power by using

U. S. G. Co's

### Graphited Wood Grease

Incorporated with thoroughly graphited wood pulp (or fibre), this Grease reduces friction to a minimum and makes gears practically noiseless. It "stays put," is very adhesive and lasting, prevents "grinding," does not ooze out of boxes or require frequent application—a labor, power, trouble and money saver.

Ask for booklet W-3.

**THE UNITED STATES GRAPHITE CO.**  
SAGINAW, MICH., U. S. A.

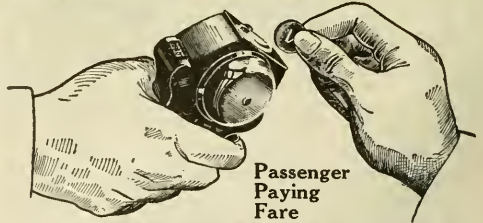

Passenger  
Paying  
Fare

Every nickel collected is registered before reaching the conductor's hand when you use the

## Rooke Automatic Fare Collector

The Rooke System is a revolution in fare-collecting methods, and as far superior to old systems as the trolley car is to the horse car.

Why not ask us to prove it?

**Rooke Automatic Register Co.**  
PROVIDENCE RHODE ISLAND

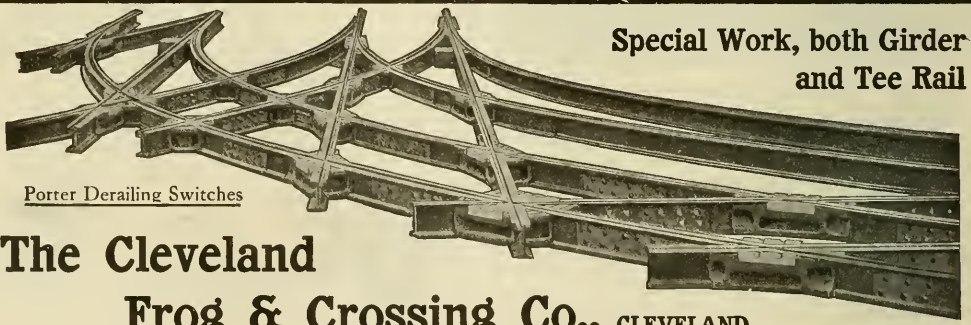

Special Work, both Girder and Tee Rail

Porter Derailing Switches

### The Cleveland Frog & Crossing Co., CLEVELAND

Avoid Accidents

By Using This Switch

SPECIAL TRACK WORK OF EVERY DESCRIPTION

### New York Switch & Crossing Co.

HOBOKEN, N. J.

### Anti-Straddling or Anti-Kicking Tongue Switch

It will not drive down at the heel, because it is held to either side with a spring tension and firmly down on its bed. A car can not straddle this tongue.

WRITE FOR SPECIAL CIRCULAR

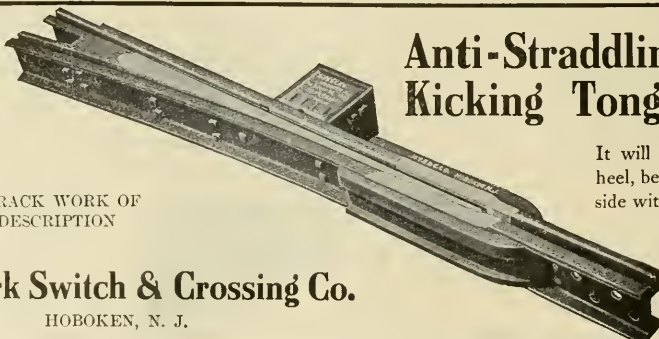

# TUBULAR POLES IRON OR STEEL



FOR  
ELECTRIC  
RAILWAYS  
ELECTRIC  
LIGHTING CO'S  
SIGNAL) SER-  
TELEPHONE) VICE  
TELEGRAPH)  
TRANSMISSION  
L I N E S  
AND  
CATENARY  
S U S P E N S I O N  
L I N E S

**ELECTRIC RAILWAY EQUIPMENT CO.**  
General Office: CINCINNATI-O-U-S-A  
Shops: READING PA - WHEELING WVA

# NOW

is the time to save money

We enable you to do this by repairing your broken steel motor cases at small expense

**W**E ARE prepared to undertake the repair of broken steel motor cases at our Jersey City Works. We are equipped with exceptional facilities for doing this work quickly, efficiently and economically. Furthermore, all work of this nature done at these shops will be guaranteed in every particular; in fact, we will REFUND THE ENTIRE VALUE OF THE MOTOR CASE in any instance where it is shown that under regular service conditions and within a period of one year from the time of making the repair, our weld did not hold and that the motor case broke again in the same place as the original fracture.

Can we do more?

Write for full details, shipping instructions and prices NOW, as this offer holds for only three months from date.

Pamphlet No. 36-Q gives full information.

**GOLDSCHMIDT THERMIT CO.**  
90 West Street, New York  
432-436 Folsom Street, San Francisco

## WASHBURN Traction Draft Rigging

The highest development of its kind, so designed and constructed that the draft rigging is always directly in the line of all pulling and buffing strains. In other words, the spring takes up all shocks without undue strains on the rigging.

This is the draft rigging that enabled heavy interurban cars to be hauled on their own wheels in trains from St. Louis to Los Angeles without a breakage.

Further comment on their strength is unnecessary.

Ask for new catalogue of traction devices.

**Washburn Steel Castings & Coupler Co., Minneapolis, Minn.**

Western Agents: Tweedy, Hood & Finlen, 204 Fisher Bldg., Chicago

Canadian Agent: John Taylor, Montreal

13

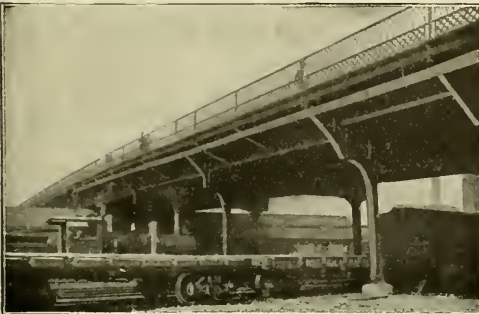
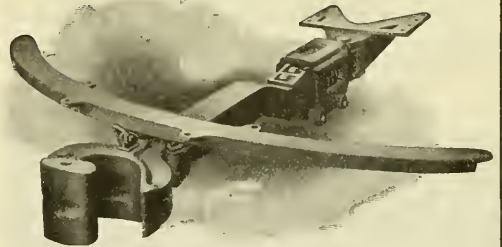

York Street Bridge, Toronto, Canada  
Electric Railway Bridge over Steam Railroads

## Carbonizing Coating

preserves metal where all other paints fail.

**Durability and Economy Guaranteed.**

Manufactured exclusively by

**The Goheen Manufacturing Co.**

Canton, Ohio, U. S. A.

Dock House, Billiter Street, London, E. C., England

THE RAILWAY SPECIALTY AND SUPPLY CO. **SMITH IMPROVED NUTS** Great Northern Building CHICAGO

**THE PETER SMITH HEATER CO.** The Pioneer Manufacturers of **HOT WATER HEATERS** for City and Interurban Cars. OFFICE AND WORKS: DETROIT, MICH.

**FOSTER SUPERHEATERS** INSTALLED IN ANY TYPE OF BOILER. Descriptive Catalogue on Request. **POWER SPECIALTY COMPANY** 111 Broadway, New York

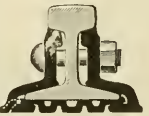
	Over 25,000 miles in use		Rolled from Best Quality Steel		Catalogs at Agencies Baltimore, Md. Portland, Ore. Boston, Mass. Seattle, Wash. Chicago, Ill. St. Paul, Minn. Denver, Colo. St. Louis, Mo. Pittsburg, Pa. Troy, N. Y. London, Eng. Montreal, Can.
CONTINUOUS JOINT		WEBER JOINT		WOLHAUPTER JOINT	HIGHEST AWARDS—Paris, 1900; Buffalo, 1901; St. Louis, 1904

Additional safety and economy in **Track Maintenance** has been proved by the use of Continuous, Weber and Wolhaupter base-supported rail joints—after ten (10) years' service, having a record of over 25,000 miles in use—the extent of which is evidence of their excellence.

**THE RAIL JOINT COMPANY**  
General Offices: 29 West 34th Street, New York City  
Makers of Rail Joints for Standard and Special Rail Sections, also Girder, Step or Compromise, and Insulating Rail Joints, protected by patents in United States and Foreign Countries.

**The Lindsley Brothers Company**  
Producers and Shippers of **WESTERN CEDAR POLES** and Manufacturers of **RED FIR CROSS ARMS**  
Eastern Sales Office, Monadnock Bldg., CHICAGO SPOKANE, WASHINGTON

We have in our Chicago Yard available for **RUSH SHIPMENTS** a **SELECTED STOCK** of **POLES** and **TIES**  
**NAUGLE POLE AND TIE CO.**  
Chicago Office, 226 La Salle Street

We are Producers and Wholesale Dealers in Western  
**CEDAR POLES**  
Yards in Washington, Idaho, Montana and British Columbia  
WRITE US FOR DELIVERED PRICES  
**CHURCHILL CEDAR CO.,** Box 1409, Spokane, Wash.

**Idaho Cedar Poles**  
PACIFIC COAST POLE CO. SPOKANE, WASH.

**G. H. BARNES HARDWOOD LUMBER CO.**  
Office and Yard: Main and Warren Sts., ST. LOUIS, MO.  
Ties, Car Oak, Poplar, Ash, Cherry, Plain and Quartered Oak

**ELECTRIC HEATERS** For All Classes of Cars  
New York Consolidated Car-Heating Co. Chicago

Complete Plants for the Rapid Handling of Material  
Every Sort of Hoisting Apparatus  
**BROWN HOISTING MACHINERY CO.** Cleveland, Ohio

**POLES and PILING**  
20,000 35s and 40s  
Ready to Ship at Once  
**S-E. Missouri Cypress Co.,** Campbell, Mo.

**C. H. WORCESTER CO.**  
**CEDAR POLES**  
PRODUCERS AND WHOLESALERS  
Suite 1710 Tribune Building CHICAGO

**CHESTNUT POLES**  
Cedar, Oak and Chestnut Ties  
FROM OUR OWN TIMBER LANDS  
**THE ADVANCE LUMBER CO.**  
CLEVELAND, OHIO

# Dearborn Water Purifying Reagents

Increase the efficiency and the years of service of steam boilers by keeping them in good condition internally. Gallon sample of the water required for analysis before preparing treatment.

## Dearborn Drug & Chemical Works

WM. H. EDGAR, FOUNDER

299 BROADWAY, NEW YORK      POSTAL TELEGRAPH BLDG., CHICAGO

### THE MIGHTY MIDGET **HOT WATER CAR HEATER**

Adapted for Large Electric Cars and Long Distance Lines. Exclusively used on Largest Electric Systems. Ask for Catalog

**THE WILLIAM C. BAKER HEATING & SUPPLY CO.,** 143 LIBERTY STREET  
NEW YORK

### RE-ENFORCED SPOKE WHEELS

For City and Suburban Cars

ST. LOUIS CAR WHEEL CO., St. Louis, Mo.

### GRIFFIN WHEEL CO.

CHICAGO

CHILLED IRON CAR WHEELS      IRON OR STEEL AXLES

The  
Recording  
Fare Register  
Company



New  
Haven,  
Conn.

### Coach and Car (Metal) Surfacer

Elastic -- Durable -- Economical



ST. LOUIS SURFACER  
& PAINT COMPANY  
St. Louis, U. S. A.



It costs  
just two 5c fares

to heat a car 24 hours if you  
use a COOPER HEATER

Send for interesting pamphlet

The Cooper Heater Co., Dayton, Ohio

11

## Whitmore's Gear Protective Composition

will thoroughly lubricate the gears and pinions  
and make them noiseless, and perform what  
all other lubricants have failed to do.

☞ We shall be pleased to furnish, upon application, the names of roads that have been using our product for the past three years.

The Whitmore Manufacturing Company  
Cleveland, Ohio, U. S. A.

## Pantasote

The National Standard for Car Curtains and Car Upholstery.

### AGOSOTE HEADLINING

The only headlining made in one solid piece. Will not separate, warp or blister. Waterproof and homogeneous.

### THE PANTASOTE COMPANY

707 Fisher Building, Chicago, Ill.

11 Broadway, New York

# ALUMINUM

## Railway Feeders

And all kinds of Electrical Conductors

Aluminum Feeders are less than one-half the weight of copper feeders and are of equal conductivity and strength. If insulated wire or cable is required, high grade insulation is guaranteed.

Write for prices and full information.

Aluminum Company of America  
PITTSBURGH, PA.

Formerly The Pittsburgh Reduction Company

# Queen Testing Sets

"The Recognized Standard"

Voltmeters  
Ammeters  
Switchboard  
and Portable  
Alternating  
and Direct  
Current



Queen Acme Testing Set

U. S. Stand-  
ard Testing  
Sets  
Rail Bond  
Testers  
Galvanom-  
eters, etc., etc.  
Electrical  
Instruments for  
All Purposes

QUEEN & CO., Inc., Philadelphia, Pa.



TELL  
THE  
PEOPLE

## E. C. Van Valkenburgh

Promotional Advertising  
for Electric Railways  
2117 West 102d St.  
CHICAGO

A comprehensive plan based on local conditions in your territory and having for its object the systematic development of travel over your road—

Copy that will bring to public attention, in a forceful manner, all the attractive features of your service and your territory—

Careful attention to all matters of detail essential in obtaining satisfactory results from your advertising expenditure—

These are some of the important features of the Van Valkenburgh Advertising Service, a service that co-operates with your traffic department and insures timely advertising matter that will produce results.

Let us submit a plan for your consideration.

## WESTON Electrical Instrument Co.

Main Office and Works:  
WAVERLY PARK, NEWARK, N. J.

### Illuminated Dial Station Instruments

SEND FOR NEW CATALOGUE



Weston Standard Illuminated  
Dial Station Voltmeter  
Model 11

Berlin—European Weston Electrical Instrument Co., Ritterstrasse, No. 38  
Paris, France—E. H. Cadot, 12 Rue St. Georges  
London—Audrey House, Ely Place, Holborn  
New York Office—74 Cortlandt St.

## GREEN TRAVELING LINK GRATES

Highest  
Capacity  
Highest  
Efficiency  
Automatic  
Smokeless  
Labor Saving  
Cheap Fuel

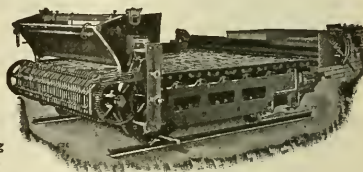

## GREEN ENGINEERING CO.

Main Office: Commercial National Bank Bldg., Chicago, Ill.  
BRANCH OFFICES: Pittsburgh : St. Louis : St. Paul : Louisville  
General Foundry Work a Speciality

## "Not an Experiment"

The Providence Fender has been in successful operation on hundreds of roads for 13 years, and has proved itself reliable under all conditions of Street Railway service.

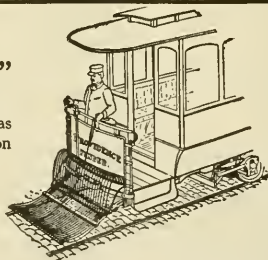

### CONSOLIDATED CAR FENDER COMPANY

Office and Factory: PROVIDENCE, R. I.  
Branch Office: 110 E. Twenty-third St., New York  
European Agents: Cumploire d'Electricite, 6, Rue Boudreau, Paris, France



Established 1877.



## ALBERT & J. M. ANDERSON MFG. CO.,

Makers of

ELECTRICAL APPLIANCES:  
SWITCHES, SWITCHBOARDS,  
TIME SWITCHES, LINE MATERIAL,  
COPPER CASTINGS (75% CONDUCTIVITY).  
289-293 A ST., BOSTON, MASS., U. S. A.

Branches:

New York, 135 Broadway. Chicago, 175 Dearborn Street.

Agencies:

Boston, Pettingell-Andrews Co. San Francisco, Eccles & Smith Co.  
New York, R. W. Marshall & Co. Atlanta, Newcomer-Manly Co.  
St. Louis, J. C. White. Denver, E. M. Messiter.



Toronto, Ont., H. J. Surtees.



## Over 46,500 of Wood's Car Gate

Patented U. S. and Canada

### Equipments Now in Use

Do not bother passengers. Easy to operate. Light, strong, serviceable. Simple to apply on all styles of cars.

Ask for Prices

THE R. BLISS MFG. CO., Pawtucket, R.I., U.S.A.

New York Office, National Novelty Corporation, 826 Broadway

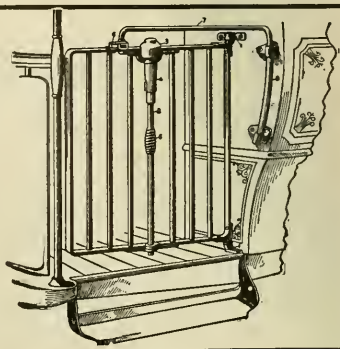
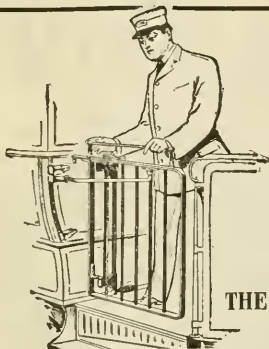

# SOFT WATER for Power Plants Eliminates Boiler Troubles

— does away with scale, corrosion or pitting, leaky flues, mud burning and all the attendant expensive evils.

To get soft water

— first, analyze the water and ascertain what harmful impurities it contains

— then, remove the impurities before the water goes into the boiler. Do not try to make a water softener out of the boiler.

The most successful water softener is the Kennicott. It is built upon the right lines and its operation is simple. The result is simple, too — just soft water that will not scale or corrode.

Every Kennicott Water Softener is guaranteed to produce definite results before it is built. You know exactly what the machine will do and what it will cost to do it before you give your order.

And the sale is conditioned solely upon the fulfillment of our agreement in every particular.

Write for full particulars of our fair and square proposition.

**Kennicott Water Softener Co.**  
CHICAGO

1

# BUCKEYE ENGINE CO.

SALEM, OHIO

Builders of High Class  
**STEAM AND GAS ENGINES**  
in powers from 25 to 10,000 H. P.

Correspond with us before placing orders.  
Catalogues on application.



Factory of The Milloy Electric Company  
Bucyrus, Ohio

## The Milloy Trolley Base

built in our new and specially equipped factory, insures a quality which will give excellent service under ordinary and extraordinary conditions.

The Milloy Base is unusually low, has even tension on high or low wire. Has no fulcrum, no friction, no oil, no center post. Always efficient. Particulars on request.

**THE MILLOY ELECTRIC COMPANY**  
Bucyrus, Ohio

## HARTSHORN'S SPRING SHADE ROLLERS

Used the World Over Wherever Cars are Run

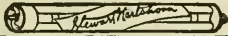

**STEWART HARTSHORN CO.**  
EAST NEWARK, N. J.

**P & B  
INSULATING  
VARNISHES**

Send for  
Literature  
and prices.

**THE STANDARD PAINT COMPANY,**  
100 WILLIAM ST., NEW YORK.

BRANCHES: CHICAGO, ST. LOUIS, KANSAS CITY,  
PHILADELPHIA, BOSTON, ATLANTA,

Possess the highest  
insulative efficiency.

**P & B  
ELECTRICAL  
COMPOUNDS**

Meet every  
requirement  
in electrical  
work.

**P & B  
INSULATING  
TAPE**

# Hydraulic Jacks

The different styles and sizes of Watson-Stillman Jacks number 400. No matter what your particular job may be, we have the hydraulic jack to handle it with greatest convenience, dispatch and economy.

No matter whether the load is lighter or heavy, we have the tool. Every Watson-Stillman tool is guaranteed.

Send for Jack Catalogue and you will see a sure way out of your Jack troubles.

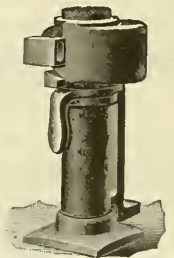

## THE WATSON-STILLMAN CO.

Main Office, 26 Cortlandt Street, New York City  
Branch Office, 453 The Rookery, Chicago, Ill.

**THE ARNOLD COMPANY**  
ENGINEERS-CONSTRUCTORS  
ELECTRICAL - CIVIL - MECHANICAL.  
181 LA SALLE STREET  
CHICAGO

**H. M. Byllesby & Company**  
Incorporated  
ENGINEERS  
American Trust Bldg., Chicago

Design, Construct and Operate  
Railway, Light, Power and  
Hydraulic Plants

EXAMINATIONS AND  
REPORTS

**J. G. WHITE & COMPANY**  
INCORPORATED  
**Engineers, Contractors**

43-49 Exchange Place,  
41-43 Wall Street

**New York, N. Y.**

Principal Philippine Office: Manila, P. I.

**The Roberts & Abbott Co.**

E. P. ROBERTS ENGINEERS W. H. ABBOTT

**Electric Railways, Light and Power**

Complete Industrial Plants Water Power Development

CLEVELAND CHICAGO PHILADELPHIA BALTIMORE

**SANDERSON & PORTER**  
ENGINEERS AND CONTRACTORS

EXAMINATIONS - REPORTS - DESIGNS - SPECIFICATIONS  
CONSTRUCTION-EQUIPMENT-SUPERVISION AND MANAGEMENT  
OF RAILWAY, LIGHT AND POWER PROPERTIES  
HYDRO-ELECTRIC DEVELOPMENTS  
52 WILLIAM STREET NEW YORK

**Surface, Jet and Barometric Condensers**  
**Edwards Air Pumps Centrifugal Pumps**  
**Water Cooling Towers**

**Wheeler Condenser & Engineering Company**

West and Cedar Streets, NEW YORK Works, CARTERET, N. J.  
Monadnock Block, CHICAGO, ILL.

**STONE & WEBSTER ENGINEERING  
CORPORATION**

**CONSTRUCTING ENGINEERS**

147 MILK STREET, BOSTON

**ELECTRIC RAILWAY, LIGHT & POWER PLANTS**  
**WATER POWER DEVELOPMENTS**

**A. L. REGISTER & CO.**

Engineers and General Contractors--Electric Railways  
112 North Broad St. PHILADELPHIA, PA. Established 1889

**CENTRAL INSPECTION BUREAU**

Inspection of Rails, Ties, Cars, Motors, Bridges, Buildings, Etc.  
17 STATE STREET - - - NEW YORK CITY

**SHIMER & CHASE CO.**

Experienced Promoters of Electrical Railway Projects  
Correspondence Solicited OMAHA, NEB.

A. U. Jaastad P. J. Harleman F. E. Greenwood  
**SHEAFF & JAASTAD**  
ENGINEERS

Broad Exchange Building, 88 Broad Street, BOSTON, MASS.

**LINE MATERIAL**

ELECTRIC SUPPLIES FOR RAILWAYS, POWER PLANTS, ETC.  
THE CREGHEAD ENGINEERING CO., 346 Main Street, Cincinnati, Ohio

WRITE TO **MODEL STOKER COMPANY** DAYTON OHIO  
for detailed information about the best  
**AUTOMATIC SMOKELESS FURNACE**

SPRINGS--TIRES--STEEL-TIRED WHEELS  
**RAILWAY STEEL-SPRING CO.**

General Offices: 71 Broadway, New York

**St. Ry. Rep.**

Report the Street Railway Decisions with  
Notes of the State and Federal Courts.  
**MATTHEW BENDER & CO.**  
ALBANY, N. Y.

**HART CONVERTIBLE CAR**  
BALLAST, CONDOLA AND CONSTRUCTION  
RODGER BALLAST CAR CO., Railway Exchange, CHICAGO

**GEARS AND PINIONS**

FOR ALL TYPES OF MOTORS

THE VAN DORN & DUTTON CO., CLEVELAND, OHIO

**WHEEL TRUING BRAKE SHOES**

Repair Crippled Wheels While Running  
THE WHEEL TRUING BRAKE SHOE CO., Detroit, Mich.

**BRAKESHOOES**  
STANDARD  
BRAKESHOE COMPANY  
GEN'L OFFICES & WORKS-AURORA, ILL.-CHICAGO OFFICE 315 RY. EXCH.

**E. SAXTON**  
**CONTRACTOR**

SPECIALTIES:

**CONDUIT ELECTRIC RAILWAYS**

**TROLLEY LINES**

CITY AND SUBURBAN

**CONDUIT SYSTEMS, ETC.**

OFFICE, 841 BLADENSBURG ROAD, WASHINGTON, D. C.  
Long Distance Telephone, East 887



(END VIEW)

Has adjustable steel noses — suitable for general urban and light interurban service. The most efficient low-priced electric snow-plow on the market.

## The Russell Pedestal Electric Snow-Plow No. 6

Further information on request — also catalog Electric Snow Plows.

**RUSSELL CAR & SNOW-PLOW CO., Ridgway, Pa.**

Wendell & MacDuffie, Cortlandt St., New York, Eastern Sales Agents; Robinson & Cary Co., St. Paul, Minn., C. A. Ralston, Fisher Bldg., Chicago, Ill., Western Sales Agents; Dominion Supply Co., Winnipeg, Manitoba, Western Canada Sales Agents.

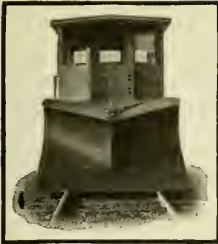

## Middletown Car Works, Inc.

MIDDLETOWN, PA., U. S. A.

LONDON OFFICE: 6 OLD JEWRY, LONDON, E. C.

Steel Frame Cars have proven in steam service far superior to old fashioned Wood Frame Construction. We would be pleased to send you Photographs and Specifications.

Manufacturers of All Kinds of

Steel Frame Box Express Cars. Hopper Ash and Cinder Cars.  
Rail Laying Cars and Work Cars.

WILLIAM B. DEMING, Export Agent . . . 17 State Street, NEW YORK  
H. A. CLARK & CO., Domestic Agents . . . 17 State Street, NEW YORK



## CAR BODIES

Of All Types

## TRUCKS

To Suit

**CINCINNATI  
CAR COMPANY**

CINCINNATI, OHIO

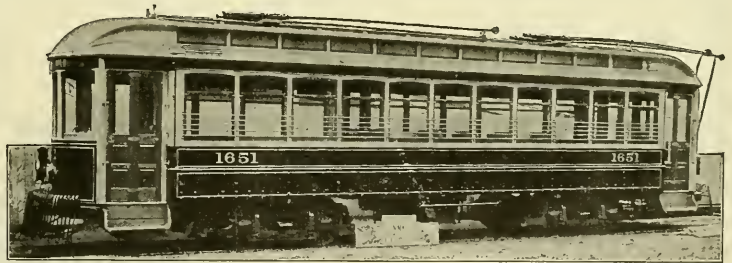

STANDARD SEMI-CONVERTIBLE—For Use All the Year

# Steel Passenger Cars and Trucks

For Steam and Electric Railways

Steel and Composite Freight Cars for all Classes of Service

# Pressed Steel Car Co.

Offices: PITTSBURGH, NEW YORK, CHICAGO, ATLANTA, ST. LOUIS, MEXICO CITY, SYDNEY, N. S. W.

## POLE PAINTS

that insure economy through exceptional durability. Let us send you a color card.

**Detroit Graphite Company**  
DETROIT, MICH.  
Dept. S.

## ROLLING DOORS

In Steel, Wood or Bronze

FOR CAR BARNs, FREIGHT SHEDS, ETC.

Made by the

**JAS. G. WILSON MFG. CO.**

New York Office: 3 W. 29th Street

ESTABLISHED 1876

Incorporated 1903

## Kinnear STEEL Rolling Doors FOR CAR HOUSES

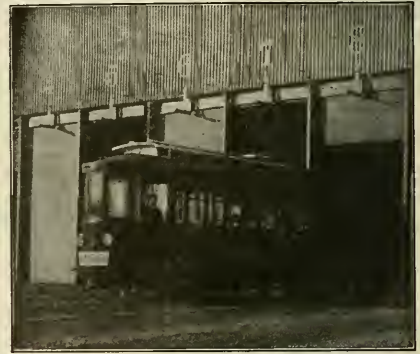

Operate Easily, Speedily, Satisfactorily  
and are very durable. Write for Catalog  
**The Kinnear Manfg. Co.**

COLUMBUS, OHIO  
BOSTON 85 WATER ST. CHICAGO 112 CLARK ST. PHILADELPHIA 1011 CHESTNUT ST.

## Save Money on Repairs and Parts for Railway Motors

by patronizing our works  
—the largest of their kind  
in America—where we

- make Armatures complete, re-shaft and rewind them
- furnish Commutators complete, refilled and assembled
- do all kinds of field work for nearly all different makes of Dynamos and Motors.

We give the best of service. You can pay freight both ways (unless very far distant) and still save money.

**Cleveland Armature Works**  
Cleveland, Ohio

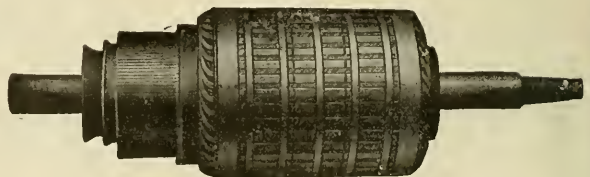
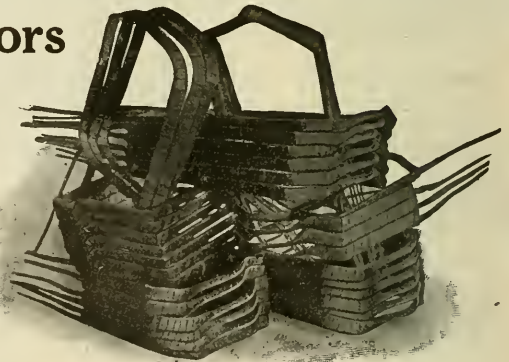

# Electric Railway Review

PUBLISHED EVERY SATURDAY BY THE WILSON COMPANY, CHICAGO

Entered as second-class matter January 5, 1907, at the postoffice at Chicago, Ill., under the act of March 3, 1879.

160 Harrison Street, Chicago  
150 Nassau Street, New York  
1529 Williamson Bldg., Cleveland

Vol. XIX  
No. 1

CHICAGO, JANUARY 4, 1908.

Whole No.  
245

Subscription: Domestic . . . \$2  
Foreign . . . \$5  
Canada . . . \$3.50

The average master mechanic of a small road is a mechanical genius and the problems which he must solve vary so widely in character that his position would not be well filled if he were not able continually to advance new methods for saving time and money. The earnings of a small road do not permit it to equip shops with many

of the tools considered economical in the repair work of larger roads; therefore, it devolves upon the master mechanic to improvise shop methods that will permit him to repair his cars as cheaply as possible, substituting home-made apparatus for expensive machinery. He observes in his work that the few equipments of a small road must be inspected as rigorously as those on the larger roads and, to show the highest profit from his work, they must be kept in an equally high state of repair. In this issue of the Electric Railway Review the shop practice of the Allegheny Valley Street Railway, a comparatively small interurban road in Pennsylvania, is described by H. F. Meutzel, master mechanic. This article presents an interesting description of the very thorough methods of inspection practiced, and describes many shop practices that have been found satisfactory.

The plan of enforcing the pay-as-you-enter system of fare collection, without the use of cars especially built for the purpose, as attempted in Pittsburg last week, does not seem to have been a startling success. As reported in last week's issue of the Electric Railway Review, the Pittsburg Railways Company on December 24 began

to require the passengers to enter by the rear platform and leave by the front platform and to pay their fares as they entered the car. It was stated that the object was to enable the conductor to remain on the rear platform in order to lessen accidents. This practice lasted less than a week. Many of the passengers absolutely refused to comply with the company's wishes and did everything in their power to handicap the conductors, such as by requiring them to change bills and by purposely boarding the cars in crowds. In a short time the conductors were completely discouraged and notified the company that they could not enforce the order. On December 30 the order was rescinded. It is stated that the climax came when a woman with a baby and a number of packages entered a car holding her nickel in her mouth and swallowed it while explaining her predicament to the conductor. We are not advised whether the Pittsburg Railways Company wished to make a test of the pay-as-you-enter idea before ordering special cars, or whether it hoped to make the plan succeed without the pay-as-you-enter cars, but in either case it seems extremely inadvisable to try such a plan without previous preparation of the conductors and the public. In Chicago, where the pay-as-you-enter cars have met with remarkable success since they were first put in service on November 24, the street railway company conducted an extensive campaign of education before trying the new methods. The conductors were carefully coached at the car barns for three weeks and the benefits to be derived from the new plan were outlined at length in the newspapers and in folders distributed to the public before the cars were put in service.

As a result every conductor and most of the passengers knew exactly what to do when the time came. It is to be regretted that the future success of such an important improvement in street railway transportation, conducive to the welfare of the companies and the public alike, should have been allowed to be prejudiced by these apparently ill-advised experiments.

The decision to form a traffic association which shall be allied with the Central Electric Railway Association as a branch of that organization is of far-reaching importance. It means that the companies will consider questions pertaining to traffic in the thorough manner in which they have discussed subjects relating to operation, maintenance and engineering in the sessions of the association which it is now evident will have an allied body. The suggestion of the formation of a traffic organization has its foundation in the need for co-operation which actuated the steam railways in their establishment of similar organizations. As connections have been built between various interurban electric railways, the possibilities for local traffic have naturally and gradually opened the way for business affording longer hauls; and consolidation of the properties of various companies has increased the length of ride possible without change of cars. A traffic association will do more to facilitate and promote the movement of passengers and freight traffic between connecting interurban lines than traffic arrangements at random could accomplish. The new association will have abundant work laid out for it. Letters which have been published in the Electric Railway Review from some of those who are interested in the success of the organization indicate that it will be thought desirable to discuss means for the promotion of traffic at the various meetings. This is a subject upon which many successful general managers could be invited to address the association. The new association, if successfully started, will have an excellent opportunity to do valuable service for the interested roads.

Last week we published in the Electric Railway Review, on page 981, a description of a special sand box, arranged to deliver the sand between the two wheels of the truck. The experience with this car on tracks covered with snow shows that such a method of delivering sand has two special advantages: First, with the delivery pipe between the wheels of the truck the sand is placed on the head of the rail, no matter whether the car be on curved or straight track. Second, when the track is covered with snow the front car wheels serve to clean the rail so that the sand delivered behind these wheels may be used effectively. How well this sanding scheme works out in practice is described in a recent communication from John A. Buggy, superintendent of the Delaware County & Philadelphia Electric Railway Company, who says: "It will, perhaps, be interesting to know that the sand car which we recently constructed and sent you a description of has been equipped with track scrapers for removing snow. During a recent storm we found the car very useful by reason of the fact that the scrapers in

front first removed nearly all of the snow; then the front wheels flattened down the small amount remaining on the track, so that the sand pipe distributed the sand on the rail and left a well-sanded rail for the rear wheels to take hold of. If we had used our earlier type of sand box and pipe construction the sand would have been thrown on the snow in front of the car and afterward swept away by the sweepers; or else, as we usually have done, we would have run into the drifts, removed part of the snow and then have applied sand in the rear of the car, backing the car to the rear for several feet upon the sanded rail, thus being able to get up speed and again run into the snow as far as possible, or until the wheels began to slip. Our experience with the car as re-modeled, however, has been that with snow up to a foot deep and on level track we can continue straight along. Through a recent storm the work done by this car during one night more than paid for the alterations."

### THE YEAR'S PROGRESS IN ROLLING STOCK.

A brief review of the electric railway rolling stock in operation at the close of the year 1907 shows no marked change in car design as a whole, but it does show that there have been put into general use improvements which clearly indicate a decided advancement in rolling stock construction.

Considering first cars for city service, the most important development has been the widespread adoption of the pay-as-you-enter plan of fare collection. A change in body design from the earlier type of car used in heavy city service is required for the new method of collecting fares. It is necessary to have platforms of greater length and to rearrange the doors in the end bulkheads, providing separate entrances and exits. Otherwise, with the exception of details such as guide railings and door operating mechanisms, no radical changes are required to adopt the pay-as-you-enter feature for city service.

The past year has seen the continued introduction of all-steel cars for surface, elevated and interurban use. While riveted steel is yet new in this application, its satisfactory service in the steam railway field gives every assurance that the desired improvements in strength and maintenance costs of all-steel cars will be attained. Fostered by the satisfactory service of all-steel cars there is a rapidly growing tendency for a more general use of steel in the under and side framing of all types of cars. The demands for higher speeds in turn require stronger cars and these can only be obtained within economical limits by reinforcements of steel or steel construction.

There has been a marked advancement during the past year in the construction and use of what may be called utility cars. Such equipments comprise special cars for erecting and maintaining overhead construction, transfer cars equipped with small chain blocks, for carrying materials in yards and between shops, and heavy crane cars equipped with large motors and high lifting capacity swinging boom cranes. The latter mentioned equipments, equipped either with motor-operated or hand-operated lifting tackle, are especially valuable for wrecking purposes, and, when used in city service, for handling special track work when repairs are made during the day.

In principle trucks vary but little from those of a year ago, the improvements noted having been changes in details. For interurban service steel-tired or the forged and rolled steel wheels grow rapidly in favor; in fact, some of the more recently completed lines operate at such high speeds and use such heavy equipments that it would hardly be safe to use cast-iron wheels, because the flange thickness is so greatly restricted by city special work.

Car designers and builders now have standard dimensions for axles and other truck parts, to which the American Street and Interurban Railway Association, the Engineering Asso-

ciation and the Central Electric Railway Association have given their approval. These standards as recommended have been formulated only after a most thorough study by builders and purchasers. With these available it now remains for the manufacturers and purchasers of cars to adopt them if they would receive the benefits so long sought.

The general appearance of interurban car bodies approaches from year to year more closely that of the Pullman type. Few changes in body design have been made. Considering rolling stock in a general way, the equipments have grown in size to meet the demands of increased interurban traffic. The growth in length has, of course, been attended by a proportionate increase in weight, requiring motive power equipments of greater capacity. Much credit is due the manufacturers of railway motors for the improvements which they have made in the design of motors. With the very limited space available between the axles of a car a serious problem confronted the motor manufacturer when units of higher power were demanded for fast interurban schedules. These conditions have been met by refinements within the motor case, so that increased power is now available within the long since well-filled clearance space.

Probably the most important advancement in motor design, and one which has permitted the demands for motors of larger capacity to be met, is the use of commutating pole or interpole motors. Briefly, such motors differ in no way from the more familiar types, except that between each pair of field poles is a thin auxiliary pole, the field of which serves to assist in reversing the current in an armature coil as that coil passes under a brush. The result is a great improvement in commutation through a wide range of loading.

Improvements of value have been made in control apparatus during the past year. These have been matters of detail rather than of principle. The most marked change in control work, other than these detail improvements, has been the more general use of the bridge form of transfer from series to parallel connection, which avoids the opening of the circuit of either motor during the transition and thereby continues the torque of both motors through acceleration. For high-speed equipments this refinement of control is especially desirable. On heavy city equipments, and especially those which haul trailers, the contactor or unit switch is finding a more general use in connection with platform controllers.

Much attention has been paid during the past year to improving the insulation, as well as the commutation, of railway motors. These improvements are demanded by the gradual increase in the operating voltage. Interurban roads are now operating with trolley voltages of 11,000 and 6,600 alternating and 1,200 volts direct current. The control apparatus for the alternating-current motors feeds the motors at a maximum pressure of about 250 volts, but the tendency for heating and insulation breakdown is proportionately greater than with direct current. Therefore special measures have been taken to improve insulation. With the 1,200-volt direct-current equipments the pairs of motors on each truck are connected in series, so that the insulation requirements vary in no way from those on 600-volt roads.

For interurban work the automatic air brake is being quite generally installed on new equipments. The improved service offered by such brakes is required wherever cars are to be operated in multiple—and there are now few interurban roads which are not prepared or preparing to run their cars in trains. Several of the more recently built interurban roads have equipped their cars with controllers provided with "deadman" handles. These assure a quick stop should the motorman accidentally remove his hand from the controller handle. This improved controller detail comprises attachments which, on being released by the removal of the motorman's hand, instantly and automatically cut off the current being fed to the motors and apply the emergency air.

These few improvements mentioned do not complete the

record of rolling stock progress for 1907. They may be classed rather as general improvements applicable to either interurban or city cars as separate classes. In addition to the general improvements there has been carried on in the shops of the various roads much creditable work tending toward the betterment of the cars on individual systems by adding improvements and small changes in designs, which adapt the rolling stock more satisfactorily to local conditions.

---

#### ROLLING STOCK ORDERED IN 1907.

---

Following the practice established last year the Electric Railway Review presents in this issue a detailed statement of the rolling stock equipment ordered in 1907 by the street and interurban railways of North America. The statistics show that during the year 1907 orders were placed for 6,216 cars and 95 electrical locomotives, a total of 6,311 equipments. Compared with the previous year this is an increase of 184 equipments, which may be considered as quite satisfactory when it is remembered that the steam railroads ordered during the same period 1,741 less passenger cars and 158,604 less freight cars than they did during the year 1906.

Rolling stock statistics recently compiled by The Railway Age show that during 1907 the steam railroads ordered a total of 1,791 passenger cars. The electric railways during the same period, as shown by the table presented in this issue, ordered 4,810 passenger cars. In other words, the passenger equipment orders for electric railway service exceeded those for steam railway service by 3,019 cars. The statistics presented in the Electric Railway Review on January 5, 1907, covering the year 1906, when compared with rolling stock statistics for steam railroad use, showed that during the year 1906 the electric roads ordered 57.3 per cent more passenger cars than the steam roads. Bearing this in mind it is quite remarkable that a similar comparison for this year shows that the electric roads have ordered during 1907 269 per cent of the number of passenger cars ordered by the steam railroads.

Considering the totals of the electric railway cars ordered during the year 1907, as compared with the year 1906, we find that for city use there were ordered last year 3,483 equipments. These 3,483 equipments, compared with 3,730 in 1906, show a decrease of 247 in 1907 orders. For interurban passenger service there were ordered 927 cars during 1907, as compared with 1,204 for the year 1906, a decrease of 277. There were ordered in 1907 for passenger service on elevated-railways 400 cars, an increase of 81 over the 319 cars ordered in 1906 for similar service.

While the statistics of orders for passenger cars, with the exception of those for elevated service, show a slight decrease for 1907 as compared with 1906, the orders for freight equipment on street and interurban railways, on the other hand, indicate a remarkable growth in that field. During 1907 orders were placed for 1,406 freight cars, which, as compared with the orders for 851 placed during 1906, shows an increase of 655 cars. In 1906 a total of 23 electric locomotives were ordered, which number has been exceeded in the year just ended by 72, there having been 95 locomotives ordered in 1907 for electric railway freight service.

It is indicative of the rapid growth of freight traffic on interurban roads that the orders placed for freight equipment aggregate close to 24 per cent of the total orders during 1907.

The electric railway companies are becoming more active in car building. This year, out of a total of 6,311 cars ordered, 772, or 12.2 per cent, are to be built in company shops. In the year 1906 10.4 per cent of the orders were placed with company shops, which, compared with the figure earlier mentioned, shows that the roads are gradually building a larger proportion of their rolling stock.

Unfortunately there are not available figures showing the total number of rolling stock equipments in North America at

the beginning of the year 1907. Considering, however, that the totals presented in American Street Railway Investments, compiled from reports gathered over a period of several months, may be assumed as correct for the close of the year 1906 there were in operation at the beginning of 1907 87,652 street and interurban railway cars. The addition of 6,311 cars in 1907 represents an increase of 7.2 per cent and makes a total of 93,963 cars. A similar comparison made a year ago showed that the increase during the year 1906 was 7.4 per cent.

At the beginning of 1907 the total street and interurban railway track mileage in the United States and Canada was estimated to be 38,082 miles. This total represents an increase of 3,976 miles in one year, and if a similar increase has taken place during 1907 there are today 42,058 miles of street and interurban railway track in the United States and Canada, with approximately 2.23 cars per mile of track.

The electric railways at large are to be congratulated because of their remarkable growth during the past decade and it is especially gratifying at this time to learn that the rolling stock equipments ordered during 1907 show a considerable increase.

---

#### NEW TRACK CONSTRUCTION IN 1907.

---

While the year 1907 has been a prosperous one for the electric railways and a memorable one from many points of view, one of the most important and striking features of the development has been the amount of new construction completed. Figures showing the total amount of new mileage for the year are unfortunately not yet available, but there are many indications that 1907 will equal if not surpass the record of any previous year in this respect. At the close of 1906 the electric railway mileage of the country was 36,212, having increased 3,695 miles, or 11.4 per cent during the year. The increase in steam railway mileage during 1906 was 6,100. The new track added by the steam roads during 1907 amounted to 5,874 miles, a slight decrease from the figures of the preceding year. It is not believed, however, that electric railway construction has been affected by the same causes as the steam roads, and a total of close to 40,000 miles at the close of 1907 would not be surprising.

While the weak condition of the money market, which has prevailed for the past three months, has undoubtedly lessened the amount of new construction to some extent, the effect has not been so great as might have been expected, or as it has been in the case of the steam roads. Its effect is more likely to manifest itself in the results for 1908. Most of the important new enterprises, which have been carried to completion during 1907, were financed during the prosperous times of 1906, and early 1907. They were thus so nearly completed by the time the financial stringency began to be felt, that it was too late to stop work and it was necessary to complete the lines in order to protect the capital invested. Moreover, the business of the electric railways is in such small units that it is not so sharply affected by a financial stringency and there has not been the same occasion for curtailment as in the case of the steam roads.

Although many smaller extensions have undoubtedly been postponed on account of the lack of currency the greatest effect of the panic has been on the embryo railroads, those which had secured right of way and franchises and were seeking to finance their projects. Most of these have been obliged to postpone their plans altogether until a more prosperous period and as a panic affects the strong and weak alike the set-back will be evident when the mileage for 1908 is compiled.

While the increase in mileage applies generally throughout the United States, the new construction work has been most active in the far western states of Washington, Oregon and California, and in the central states Indiana, Ohio and Illinois. Figures for the state of Indiana, as compiled by the

state railroad commission, bring out the striking fact that the increase in electric interurban railway mileage in that state during 1907, 426 miles, is greater than the increase in steam railroad mileage in any state, Louisiana leading with 422 miles. There are now 1,538.93 miles of electric railway in Indiana, not including street railways, as compared with 1,113 in 1906 and with the steam mileage of 7,239.55.

A large proportion of the new track put in service during 1907 has been built by new companies, although the existing lines have been active in extending their properties by connecting short lines in order to form through routes and by building feeders. The greatest development of the year is seen in the number of long interurban roads that have been put in operation. The city lines have made important extensions, but in general their greatest efforts have been concentrated on betterments and improvements in power houses, rolling stock, etc., and in rebuilding their tracks. It is in the construction of long interurban roads, that is roads over 40 or 50 miles in length, built according to the highest standards of steam railroad construction, and in many cases operated in direct competition with the steam railroads, that the year has made itself most memorable. Most of these have been described at length in the columns of the Electric Railway Review.

The new lines in Indiana that have been opened during the year include four which are over 30 miles in length: the Indianapolis Crawfordville & Western Traction Company from Indianapolis to Crawfordville, 45 miles; the Lafayette-Logansport line of the Ft. Wayne & Wabash Valley Traction Company; the Indianapolis & Louisville Traction Company, which operates with 1,200-volt direct current from Seymour to Sellersburg, 41 miles, and by its connection with the Indianapolis Columbus & Southern and the Louisville & Northern completes a through route from Indianapolis to Louisville; and the Marion Bluffton & Eastern Traction Company, operating from Marion to Bluffton, 30 miles. In this connection it is worthy of note that the Terre Haute Indianapolis & Eastern Traction Company has completed a connection between the lines radiating from Indianapolis and the Terre Haute system, and now operates a total of 351 miles. The Chicago Lake Shore & South Bend Railway has been under active construction since last spring, and will connect South Bend, Ind., with Chicago, Ill., a distance of 81 miles. Much of the track has been laid and it is hoped to begin operation before summer.

In Illinois the greater part of the new construction has been done by the Illinois Traction System, which has completed during 1907 a single-phase line from Peoria to Bloomington and lines from Clinton to Bloomington, Champaign to Decatur and Lincoln to Mackinaw. Preliminary work is now in progress for the long-talked-of extension to Chicago and active work is being done on the \$2,500,000 bridge over the Mississippi river at St. Louis. The Elgin & Belvidere Electric Company, which completed its track in 1906, did not, however, begin operating its line from Elgin to Belvidere, 36 miles, until February, 1907. The Chicago & Southern Traction Company also laid most of the track for its extension from Harvey to Kankakee during 1906, but did not begin operation until November, 1907.

Ohio was very completely served by electric lines at the close of 1906, with a total of approximately 2,600 miles. Consequently most of the new work during 1907 has been in the way of short links to complete the network. The Youngstown & Southern Railway has added 26 miles of new line from Youngstown to Leetonia, and with the completion of the Youngstown & Ohio River Railroad will offer through service from Youngstown to East Liverpool, about 45 miles. Other important enterprises now under way in Ohio are the Lima-Bellefontaine extension of the Ohio Electric Railway, 45 miles, the electrification of the Columbus & Lake Michigan line from Defiance to Lima, and the completion of the Lima & Toledo line, both by the same company,

In Wisconsin the Milwaukee Northern Railway has completed the first section of its line out of Milwaukee and expects to extend to Sheboygan and Fond du Lac. The Milwaukee Electric Railway & Light Company has also completed a number of short extensions.

The most interesting and important of the new additions to the electric railway map is doubtless the single-phase line of the Spokane & Inland Railway in Washington. This road is operated as a division of the Inland Empire System and extends south from Spokane to Spring Valley Junction, where it divides into two branches, one to Colfax, and the other to Palouse, a total distance of 116 miles. An extension to Moscow, Idaho, 16.5 miles, is now under construction and a line to Lewiston, Idaho, 43 miles farther, is contemplated. Much of the Spokane & Inland's track was laid during 1906, but the road was not put in operation until last year.

Several important projects for new lines in Washington are well under way, but have not yet reached the stage of accomplishment.

In Oregon the Oregon Electric Railway is now completing its line from Portland to Salem, 53 miles long, and it is announced that operation will begin this month.

California also has an impressive amount of new track to its credit. The Ocean Shore Railway, which will connect San Francisco and Santa Cruz, a distance of 81 miles, has completed a large proportion of its construction, but was unexpectedly delayed in its work by the earthquake last spring. The Northern Electric Railway has opened several new lines during the year and when the lines now under construction and rapidly approaching completion are finished, will have a total of 165 miles of track. The Los Angeles-Interurban and Pacific Electric Railway system has also opened several extensions and now has a total of 550 miles of single track, besides 25 miles of side track.

In the middle west the most important new line is the Ft. Dodge Des Moines & Southern Railroad, which began operating from Ft. Dodge to Des Moines, Ia., 85 Miles in November, using an electrified portion of the Newton & Northwestern steam road.

In Pennsylvania, which like Ohio was already covered by a network of short lines, the greatest activity has been shown in short extensions of existing lines and although several ambitious enterprises have progressed during the year the only extensive new lines placed in operation are the single-phase line of the Pittsburg & Butler Street Railway and the line of the Philadelphia & Western, from a connection with the Philadelphia system to Wayne, 11.8 miles.

In the south a large number of important projects are now being carried out which will add greatly to the transportation facilities of that section. The Texas Traction Company of Dallas, while it has not laid much of its track, has finished the grading and bridge work for 65 miles of line, from Sherman to Dallas, Tex., which will be operated by single-phase current. The Stone & Webster Engineering Corporation has extensive plans for the development of Texas, which will probably be delayed until the financial situation improves.

In the east a large number of small connecting lines have been built although the construction has not been so active as in the newer localities of the west. The Washington Baltimore & Annapolis Electric Railway has practically completed its line from Baltimore to Annapolis, 36 miles. The especial features of interest in the east are the electrification of portions of four steam railroads, the New York Central, the New York New Haven & Hartford, the Erie, and the West Shore, all of which have been placed in operation during the year just past.

---

The first car was operated over the new line of the Illinois Traction System from Lincoln to Mackinaw, Ill., on December 31. Regular service on a 2-hour headway was started on January 1. The distance is 27 miles.

# ELECTRIC RAILWAY ROLLING STOCK ORDERED IN 1907.

A detailed statement of the electric railway rolling stock equipment ordered by the roads of North America during the year 1907 is presented herewith. One year ago, in the Electric Railway Review for January 5, 1907, there were published for the first time similar statistics covering the purchases during the year 1906. The figures here presented are compiled from official sources and from the regular weekly records of the Electric Railway Review. These statistics are as complete and accurate as it is possible to make them in the time available for their compilation. The records as presented show equipment ordered from company shops as well as those for which orders were placed with car manufacturers.

It is interesting to note that this year the grand total shows a healthy increase over that for 1906. The passenger car orders except for elevated service are less than a year ago, but orders for freight cars and electric locomotives for freight handling show a decided increase. The totals show

orders for 3,483 cars for city passenger service, 927 for interurban passenger service, 400 for elevated service, 1,406 freight cars and 95 electric locomotives. These totals for 1907 compare with those for 1906 as shown by the following summary:

	1906.	1907.
Passenger cars, city	3,730	3,483
Passenger cars, interurban	1,204	927
Passenger cars, elevated	319	400
Freight cars	851	1,406
Electric locomotives	23	95
<b>Total</b>	<b>6,127</b>	<b>6,311</b>

That the electric railway companies are rapidly increasing their car building facilities is evidenced by the statement that 772, or 12.2 per cent, of the equipments ordered in 1907 were to be built in company shops, as compared with 10.4 per cent for the year 1906.

## ROLLING STOCK EQUIPMENT ORDERED IN 1907.

Purchaser.	No.	Class.	Length.	Serv.	Trucks.	Builder.	Purchaser.	No.	Class.	Length.	Serv.	Trucks.	Builder.
Albany & Hudson	2	Comb.	43-0	.....	D. T.	Wason	Charlotte Elec. Ry.						
Alton Gr. & St. L. Trac. Co.	6	Pass.	40-0	City	D. T.	American Car	Lt. & Pwr. Co.	1	Frt.	40-0	City	D. T.	Moffitt M. & M. Co.
Amarillo St. Ry.	4	.....	32-7	City	D. T.	Danville Car	Chattanooga Rys.	15	Semiconv.	28-0	City	S. T.	Kuhlman
Anaconda Copper Mining Co.	1	Pass.	54-0	City	D. T.	St. Louis	Chatta. St. Ry.	2	.....	.....	City	S. T.	Jewett
Asheville Elec. Co.	4	Semiconv.	30-6	City	S. T.	Brill	Chester Trac. Co.	7	Semiconv.	40-0	City	D. T.	Brill
Atl. Shore Line	2	Open	.....	Int.	D. T.	Brill		5	Pass.	40-10	Int.	D. T.	A. M. C. & F. Co.
	4	Pass.	.....	Int.	D. T.	Brill	Chi. & Joliet Elec. Ry.	4	Pass.	36-6	Int.	D. T.	Stephenson
Auburn & Syrac. Mining Co.	2	Pass. & Baggs.	.....	Int.	D. T.	Brill	Chi. & Mil. Elec.	20	Loco.	.....	Int.	D. T.	Jewett
Aurora Elgin & Chicago	1	Open	.....	Int.	D. T.	Cincinnati		2	Loco.	.....	.....	.....	General Electric
	2	Pass.	48-0	Int.	D. T.	McGuire-Cum.		2	Loco.	.....	.....	.....	Westinghouse
	2	Pass.	52-10 1/2	Int.	D. T.	Hicks	Chicago City Ry.	300	Pay-as-You-Enter	48-3	City	D. T.	Pullman
Austin Elec. Ry. Bangor Ry. & Elec. Co.	4	Open	.....	City	D. T.	Southern Car		15	Semiconv.	.....	Int.	D. T.	Brill
	2	Pass.	30-4	City	S. T.	Brill	Chi. Elec. Trac. Co.	15	.....	.....	Int.	D. T.	Kuhlman
	2	Pass.	32-6	City	S. T.	Brill		10	.....	.....	Int.	D. T.	St. Louis
	2	Pass.	40-0	Int.	D. T.	Brill	Chi. L. S. & S. Bend	15	Pass. & Sm.	57-0	Int.	D. T.	Niles
Baton Rouge Electric & Gas Co.	9	Semiconv.	30-6	City	S. T.	St. Louis		8	Pass., Sm. & Baggs.	57-0	Int.	D. T.	Niles
Beaumont Traction Co.	1	.....	.....	.....	S. T.	Co. Shops		1	Exp.	50-0	Int.	D. T.	Niles
Bellaire-S.W. Trac. Co.	5	Semiconv.	.....	.....	D. T.	Brill	Chi.-N. Y. Elec. Air Line	2	Closed	49-6	Int.	D. T.	Niles
Beloit Trac. Co.	6	Pass.	.....	.....	D. T.	St. Louis	Chi. So. Bend & Nor. Ind.	10	Pass.	61-0	Int.	D. T.	Cincinnati
Belton & Temple Traction	1	Baggs.	45-6	Int.	D. T.	Co. Shops	Chicago Un. Trac. Co.	4	Pass.	41-0	City	D. T.	Niles
Benton & Fairfield Birm. R. L. & P. Co.	4	Frt.	.....	.....	D. T.	Co. Shops	Choctaw Ry. & Lt.	1	Frt.	46-0	Int.	D. T.	Co. Shops
Boise-Interurban	2	Closed	.....	.....	D. T.	St. Louis		4	Frt.	35-0	.....	D. T.	Co. Shops
Boston & W. St. Ry.	4	Exp.	43-0	Int.	D. T.	Danville	Cinn. Georgetown & Ports.	4	.....	.....	.....	.....	Co. Shops
	6	Semiconv.	.....	Int.	D. T.	Brill	Cincinnati Nor.	20	Semiconv.	21-0	.....	S. T.	Cincinnati
	2	Coal	32-6	City	D. T.	Co. Shops	Cinn. Trac. Co.	50	Pass.	728-0	City	D. T.	Cincinnati
	2	Loco.	30-7 1/4	City	D. T.	Co. Shops	Citizens' Light & Transit Co.	6	Pass.	28-0	City	S. T.	Brill
Boston Elev. Ry.	6	.....	.....	.....	D. T.	Brill		3	Pass.	23-0	City	S. T.	Brill
Brantford & Hamilton	6	.....	.....	.....	D. T.	Brill	Citizens' Ry. (Lincoln, Neb.)	8	Conv.	.....	City	S. T.	American Car
Bristol & Plainv. Tramway Co.	1	Pass.	31-0	City	S. T.	Wason		2	Conv.	31-0	City	S. T.	McGuire-Cum.
B. C. Elec. Ry.	2	Pass.	32-6	City	S. T.	Co. Shops	Citizens' Ry. (Waco, Tex.)	2	Pass.	30-0	City	S. T.	American Car
	9	Pass.	43-4	City	D. T.	Co. Shops		4	Pass.	30-0	City	S. T.	Co. Shops
	3	Pass.	50-0	Int.	D. T.	Co. Shops	Citizens' R. & L. Co. (Ft. Worth, Tex.)	5	Open	30-0	City	.....	Kuhlman
	1	Motor	35-0	City	D. T.	Co. Shops	City & Elm Grove.	1	Frt.	40-0	Int.	D. T.	Co. Shops
	10	Flat	35-0	City	D. T.	Co. Shops		1	Pass.	43-0	Int.	D. T.	Southern Car
	10	Plat.	.....	.....	D. T.	Brill	City Ry. (Dayton, O.)	11	Pass.	28-7	City	S. T.	Barney & Smith
Brooklyn Rapid Transit	100	Semiconv.	.....	City	D. T.	Brill	Clement Ry. & Ltg. Co.	1	Loco.	.....	.....	.....	General Electric
	50	Semiconv.	.....	Elev.	D. T.	Laconia	Clinton St. Ry.	2	Semiconv.	30-8	City	S. T.	American Car
	50	Semiconv.	.....	Elev.	D. T.	Jewett	Col. Belt Elec. Ry.	3	.....	.....	City	D. T.	St. Louis
Buff. & L. E. Trac. Co.	25	Pass.	.....	Int.	D. T.	Cincinnati	Colo. Sp. & Int.	2	Closed	37-0	City	D. T.	Co. Shops
Buff. Lock & Roch.	15	Comb.	31-8	Int.	D. T.	Niles		2	Closed	42-0	.....	D. T.	Co. Shops
	2	Exp.	50-7	Int.	D. T.	Niles	Columbia Elec. St. Ry. L. & Pr. Co.	2	Open	.....	City	D. T.	A. M. C. & F. Co.
Burlington Trac. Co.	3	Pass.	38-0	Both	D. T.	Jones' Sons		2	Semiconv.	.....	City	D. T.	Kuhlman
Butler Pass. Ry.	1	Pass.	.....	City	S. T.	Brill	Col. Mag. Spr. & No. Col. New Albany & Johnstown	1	Pass.	50-0	Int.	D. T.	Jewett
Cairo Elec. & Trac. Co.	4	Semiconv.	30-0	City	S. T.	American Car		2	Closed	31-0	City	S. T.	Brill
Calumet Elec. St. Ry.	2	Pass.	46-8	City	D. T.	Kuhlman	Col. Ry. & Lt. Co.	10	Pass.	42-0	City	D. T.	Kuhlman
Camden Interstate Ry.	5	.....	48-0	Int.	D. T.	Kuhlman	Coney Is. & Brook.	10	.....	.....	Int.	D. T.	Brill
	8	Pass.	48-0	Int.	D. T.	Niles	Connaught & Erie.	6	Closed	30-0	City	D. T.	A. M. C. & F. Co.
	1	.....	48-0	Int.	D. T.	Jewett	Connecticut Co.	94	Closed	30-0	City	D. T.	Wason
	5	Closed	48-0	Int.	D. T.	Cincinnati		9	Closed	33-0	City	D. T.	Wason
	2	Work	48-0	Int.	D. T.	Co. Shops		71	Open	.....	City	D. T.	Wason
	2	.....	48-0	Int.	D. T.	Cincinnati		3	Exp.	44-4	.....	D. T.	Wason
Ced. Rap. & Marion City	4	Pass.	.....	.....	.....	Co. Shops	Coronado R. R. Cumb. & West-empport	6	Pass.	31-6	City	D. T.	Co. Shops
Cent. Pa. Trac. Co.	5	Semiconv.	29-5	City	S. T.	Brill		2	Frt.	42-6	Int.	D. T.	Co. Shops
Chambs. & Gettys. Elec. Ry.	1	Pass.	42-8	Int.	D. T.	Cumberland Valley R. R. Co.		1	Ballast	42-6	Int.	D. T.	Co. Shops
Charl. Con. Ry. Gas & Elec. Co.	1	Frt.	.....	.....	.....	Co. Shops	Dallas Con. St. Ry.	5	Open	.....	City	D. T.	American Car
Charlotte Elec. Ry. Lt. & Pwr. Co.	6	Semiconv.	31-0	City	S. T.	Brill	Danv. St. Ry. & Lt. Co.	6	.....	.....	City	.....	Danville
	1	Open	41-0	Int.	D. T.	Southern Car	Dayton & Troy.	1	Exp.	H-17	.....	D. T.	Co. Shops
	1	Frt.	33-0	City	D. T.	Moffitt M. & M. Co.		8	Pump	25-0	Int.	D. T.	Hicks

ROLLING STOCK EQUIPMENT ORDERED IN 1907—Continued.

Purchaser.	No.	Class.	Length.	Serv.	Trucks.	Builder.	Purchaser.	No.	Class.	Length.	Serv.	Trucks.	Builder.	
Dayton & Troy	4	Pass.	25-0	City	S. T. Barney & Smith	Jacksonville Elec.	8	.....	.....	.....	.....	D. T.	.....	
Day'tn Cov. & Piqua	4	Open	42-0	Int.	D. T. Wason	Folsom Elec. Ry.	12	Open	City	.....	.....	S. T.	.....	
Denver & Int.	4	Semi-conv.	50-0	Int.	D. T. Co. Shops	Joplin & Pitts.	6	.....	Int.	.....	.....	D. T.	.....	
Deny. C. Tramw.	4	Semi-conv.	38-10 1/4	City	D. T. Woerber Bros.	Kan. City Ry. & Lt.	25	.....	City	.....	.....	Jewett	.....	
Detroit Jack. & Chi. United Ry.	10	Trail	40-13 1/2	City	D. T. Woerber Bros.	Kenosha Elec. Ry.	6	.....	City	.....	.....	S. T.	.....	
Douglas St. Ry.	15	Pass.	52-0	Int.	D. T. Woerber Bros.	Key West Elec. Co.	2	Open	33-0	City	.....	S. T.	.....	
Eastern Pa. Ry.	5	Semi-conv.	46-7 1/2	City	D. T. Cincinnati	Laconia St. Ry.	1	Semi-conv.	38-0	City	.....	D. T.	.....	
East St. Louis & Suburban	200	Coal	.....	.....	D. T. Cincinnati	LaCrosse City Ry.	4	.....	.....	.....	.....	D. T.	.....	
East Shore & Sub. E. Ohio Trac. Co.	2	Pass.	48-0	Int.	D. T. Cincinnati	LaFayette & Lo. gansport Trac.	5	.....	Int.	.....	.....	Cincinnati	.....	
Eastern Wisconsin Ry. & Lt. Co.	3	Semi-conv.	40-1	Int.	D. T. Cincinnati	Lake Chas. St. Ry.	2	Open	37-8	City	.....	Cincinnati	.....	
Easton Trans. Co.	6	Semi-conv.	30-1	City	D. T. Cincinnati	Lerdo & Torreon Elec. Ry.	2	Open	35-0	.....	.....	Brill	.....	
Elgin & Belvidere.	3	Closed	49-6	City	D. T. Cincinnati	.....	2	Closed	30-0	.....	.....	Brill	.....	
Elmira Wat. Lt. & R. R.	2	Open	.....	.....	D. T. Cincinnati	.....	4	Pass.	30-0	.....	.....	Brill	.....	
El Paso Elec. Ry.	4	Semi-conv.	40-0	City	D. T. Cincinnati	.....	4	Frnt	35-0	.....	.....	Brill	.....	
Erie Trac. Co.	2	Flat	36-0	Int.	D. T. Erie Car Wks.	.....	2	Closed	30-0	.....	.....	Brill	.....	
Fairmont & Clarkburg	1	Exp.	.....	.....	S. T. Jewett	.....	4	Pass.	42-0	Int.	.....	Brill	.....	
Farmington St. Ry.	2	.....	20-8	.....	D. T. Brill	.....	8	Semi-conv.	42-0	Int.	.....	D. T.	.....	
Forest City Ry.	50	.....	.....	.....	D. T. Brill	.....	6	Pass.	55-0	.....	.....	Brill	.....	
Ft. Dodge Des Moines & So.	1	Exp.	53-0	Int.	D. T. Niles	.....	5	Semi-conv.	21-0	City	.....	S. T.	.....	
Port Wayne & Springfield	1	Exp.	50-0	Int.	D. T. Co. Shops	.....	12	Pass.	21-0	City	.....	D. T.	.....	
Pt. Wayne & Wab. Val. Trac. Co.	6	Semi-conv.	.....	.....	Cincinnati	.....	7	Pass.	45-0	Int.	.....	D. T.	.....	
Fries Mfg. & Pwr. Co.	2	Pass.	30-1	City	S. T. Brill	.....	10	Pass.	32-1	City	.....	S. T.	.....	
Galesburg & Keokuk	3	Semi-conv.	32-0	City	S. T. Kuhlman	.....	4	Exp.	39-4	Both	.....	D. T.	.....	
Galesburg Ry. & Lt. Co.	2	Pass.	37-0	Int.	D. T. Danville	.....	4	Coal	30-0	.....	.....	D. T.	.....	
Galt Prest. & Hes.	8	Open	32-0	City	S. T. Danville	.....	5	.....	.....	.....	.....	St. Louis	.....	
Gary St. & Int. Ga. Ry. & Elec. Co.	40	Loco.	36-5	City	D. T. Ottawa	.....	15	Smi-conv.	40-2	City	.....	D. T.	.....	
Grand Rapids Ry.	10	Box.	.....	.....	D. T. Danville	.....	5	Semi-conv.	.....	.....	.....	S. T.	.....	
Gray's Harb. Elec. Co.	1	Semi-conv.	31-8	City	S. T. Co. Shops	.....	25	.....	City	.....	.....	St. Louis	.....	
Gulfport & Miss. Coast Tr. Co.	3	Semi-conv.	36-4	City	D. T. American Car	.....	20	Closed	Elev.	.....	.....	D. T.	.....	
Hagerstown R. Co.	2	Trail	40-4 1/2	Int.	D. T. American Car	.....	25	Pass.	.....	.....	.....	D. T.	.....	
Haltax Electric Tramway	4	Frnt.	35-0	Int.	D. T. Co. Shops	.....	10	Semi-conv.	31-0	City	.....	S. T.	.....	
Hanover & McSherrystown Co.	1	Exp.	24-0	.....	S. T. Ottawa	.....	2	Pass.	30-0	Int.	.....	D. T.	.....	
Havana Cent.	50	Box	.....	.....	S. T. Co. Shops	.....	6	Pay-As-You-Enter	.....	.....	.....	D. T.	.....	
Holyoke St. Ry.	7	Open	40-0	City	D. T. Wason	.....	1	Pay-As-You-Enter	51-10	City	.....	D. T.	.....	
Houston Elec. Co.	10	Closed	40-0	City	D. T. Wason	.....	10	Frnt	33-0	Both	.....	D. T.	.....	
Hudson Valley	3	Pass.	51-0	Int.	D. T. St. Louis	.....	15	Frnt	33-0	Both	.....	D. T.	.....	
Hull Electric Co.	5	Pass.	29-0	City	D. T. Westinghouse	.....	8	Semi-conv.	.....	.....	.....	D. T.	.....	
Humboldt Tr. Co.	5	Semi-conv.	41-6	Both	S. T. Ottawa	.....	15	Nashv. Ry. & Lt. Co.	15	Pass.	42-0	City	D. T.	.....
Ill. Trac. Sys.	12	Pass.	34-0	Int.	D. T. W. L. Holman	.....	10	Nat'l City & Otay	4	Pass.	51-6	Int.	D. T.	.....
Ind. Col. & East.	2	Loco.	.....	.....	D. T. Danville	.....	6	Newton & N. W.	1	Exp.	53-0	Int.	D. T.	.....
Ind. Union Trac. Co.	6	Exp.	.....	.....	S. T. Danville	.....	1	N. Y. Aub. & Lansing	10	.....	Int.	D. T.	.....	
Indpls. & Cinn. Tr. Indpls. & East.	10	Exp.	.....	.....	D. T. Am.C. & F. Co.	.....	40	N. Y. & Queen's	40	.....	.....	.....	Am. C. & F. Co.	
Ind. & Louisv.	8	Pass.	50-4	Int.	D. T. Am.C. & F. Co.	.....	156	N. Y. City Ry.	156	Pay-as-You-Enter	48-0	City	D. T.	.....
Ind. Crawfords. & West. Tr. Co.	6	Frnt.	50-0	Int.	D. T. American Car	.....	120	.....	.....	.....	.....	D. T.	.....	
Interb. R. Tr. Co.	84	Loco.	.....	.....	D. T. Danville	.....	43	Norfolk & Ports Trac.	43	Semi-conv.	30-8	.....	D. T.	.....
Intern. Ry. Co.	50	Loco.	.....	.....	D. T. Danville	.....	1	Comb.	.....	.....	.....	D. T.	.....	
		Loco.	.....	.....	D. T. Danville	.....	2	Closed	.....	.....	.....	D. T.	.....	
		Loco.	.....	.....	D. T. Danville	.....	1	Frnt	.....	.....	.....	D. T.	.....	
		Loco.	.....	.....	S. T. Danville	.....	26	Open	.....	.....	.....	D. T.	.....	
		Loco.	.....	.....	Jeffrey Bettendorf	.....	5	Pass.	45-5	.....	.....	D. T.	.....	
		Loco.	.....	.....	D. T. American Car	.....	14	Conv.	42-0	Int.	.....	D. T.	.....	
		Loco.	.....	.....	D. T. Co. Shops	.....	5	Semi-conv.	35-0	City	.....	S. T.	.....	
		Loco.	.....	.....	D. T. Co. Shops	.....	6	Box	32-0	City	.....	S. T.	.....	
		Loco.	.....	.....	D. T. Co. Shops	.....	1	Exp.	50-0	Int.	.....	D. T.	.....	
		Loco.	.....	.....	D. T. Cincinnati	.....	4	Pass.	50-0	Int.	.....	D. T.	.....	
		Loco.	.....	.....	D. T. Cincinnati	.....	3	Comb.	.....	.....	.....	D. T.	.....	
		Loco.	.....	.....	D. T. Cincinnati	.....	6	Comb.	.....	.....	.....	D. T.	.....	
		Loco.	.....	.....	D. T. Cincinnati	.....	3	Pass.	.....	.....	.....	D. T.	.....	
		Loco.	.....	.....	D. T. Niles	.....	50	Pass.	.....	.....	.....	Am. C. & F. Co.	.....	
		Loco.	.....	.....	D. T. Niles	.....	10	Northern St. Ry.	10	.....	.....	D. T.	.....	
		Loco.	.....	.....	D. T. Jewett	.....	10	No. Texas Trac.	10	Semi-conv.	30-0	City	S. T.	.....
		Loco.	.....	.....	D. T. Jewett	.....	10	Northern N. Elev.	10	Semi-conv.	30-0	City	D. T.	.....
		Loco.	.....	.....	D. T. Jewett	.....	2	Northwestern Pac.	2	Trail	47-1 1/2	Elev.	D. T.	.....
		Loco.	.....	.....	D. T. St. Louis	.....	8	Comb.	.....	.....	.....	D. T.	.....	
		Loco.	.....	.....	D. T. Wason	.....	8	Pass.	.....	.....	.....	D. T.	.....	
		Loco.	.....	.....	D. T. Am.C. & F. Co.	.....	20	Oakland Traction	20	Calif.	50-0	.....	D. T.	.....



January 4, 1908.

## ROLLING STOCK EQUIPMENT ORDERED IN 1907—Continued.

Purchaser.	No.	Class.	Length.	Serv.	Trucks.	Builder.	Purchaser.	No.	Class.	Length.	Serv.	Trucks.	Builder.	
Oakland Traction.	20	Calif.	55-0	.....	D. T.	Co. Shops	Sioux City Trac.	4	Trail.	40-0	City	D. T.	Co. Shops	
	20	Calif.	55-0	.....	D. T.	Co. Shops	Co.	4	.....	.....	.....	D. T.	Indp. & Cin. Tr.	
	10	Coach	.....	.....	.....	Co. Shops	So. Chgo. City Ry.	11	.....	.....	Int.	D. T.	Co. Shops	
	10	Flat	.....	.....	.....	Co. Shops	Southwest Mo.	8	Pass.	.....	.....	D. T.	Co. Shops	
Ogden R. T. Co.	2	Pass.	.....	Int.	D. T.	Co. Shops	Southwestern Trac.	6	Pass.	50-0	Int.	D. T.	Ottawa	
Okl. City Ry.	4	Loco.	.....	.....	.....	Co. Shops	Co.	.....	.....	.....	.....	.....	.....	
	1	Pass.	.....	City	.....	Co. Shops	Empire	75	Box	.....	Int.	.....	Seattle Car	
	3	Loco.	.....	.....	.....	Co. Shops	Loco.	14	Box	.....	Int.	.....	Westinghouse	
Omaha & Council Bluffs	35	Closed Summer	.....	.....	D. T.	American Car	Flat	80	.....	.....	.....	.....	Fitz-Hugh, Luther	
	8	.....	.....	.....	D. T.	Co. Shops	Detroit	15	.....	City	.....	.....	D. T.	St. Louis
Omaha Lincoln & Beatrice	1	Motor	29-7 1/2	City	S. T.	St. Louis	Springfield Ry. & Lt.	15	.....	.....	.....	.....	.....	St. Louis
Ore. Elec. Ry.	2	Loco.	30-1	Int.	D. T.	Jewett	.....	4	Closed	.....	.....	.....	.....	St. Louis
Ottawa Elec. Ry.	12	Open	30-0	City	S. T.	Ottawa	Springfield (Mo.)	2	Open	.....	.....	.....	.....	.....
	12	Closed	32-0	City	S. T.	Ottawa	St. Ry.	4	.....	City	.....	S. T.	Kuhlman	
Pac. Coast Ry.	20	Flat	.....	.....	.....	Co. Shops	Springfield Consol. Ry.	6	.....	City	.....	D. T.	Jewett	
Pan-Handle Trac. Co.	5	Pass.	45-0	Int.	D. T.	Kuhlman	Stauben & E. Liv. Ry. & Light Co.	5	Pass.	32-7	City	S. T.	American Car	
Peekskill Ltg. & R. R.	1	.....	.....	.....	.....	McGuire-Cummings	Strouds'g & Water Gap St. Ry.	3	Pass.	42-0	Int.	D. T.	Kuhlman	
Peoples St. Ry. Co.	10	Pass.	37-5	City	D. T.	St. Louis	Syracuse & Sub. 1	2	Pass.	38-0	Int.	D. T.	Brill	
Petaluma & Santa Rosa	2	Flat	33-0	.....	.....	Co. Shops	Syracuse L. S. & N. 7	1	Pass.	46-5	Int.	D. T.	Co. Shops	
Phila. Rap. Trans. Co.	40	Coach	49-7	Elev.	D. T.	Pressed Steel	Syracuse R. T. Ry.	25	Pass.	45-0	City	D. T.	Kuhlman	
Pittsburg McKSp. & Greensb. Ry.	4	Pass.	44-0	Int.	D. T.	St. Louis	Tacoma R. T. Ry.	18	Pass.	50-0	Both	D. T.	Jewett	
Pittsburg Rys.	50	.....	45-8	Both	D. T.	St. Louis	Power Co.	1	Loco.	40-0	Both	D. T.	Co. Shops	
Pitts. Harm. Butler & N. Castle.	12	.....	.....	.....	.....	St. Louis	Tampa Elec. Co.	12	Pass.	.....	City	S. T.	Jewett	
Pittsfield Elec. St. Ry.	1	Closed	.....	.....	D. T.	Wason	Tampa & Sulphur Springs Trac.	6	.....	.....	.....	.....	McGuire-Cummings	
	2	Open	.....	.....	D. T.	Wason	Terre Haute Ind. & East.	4	.....	51-6	Int.	D. T.	Jewett	
Ponce Ry. & Lt. Co.	2	Flat	22-0	City	S. T.	Co. Shops	.....	20	.....	55-0	Int.	D. T.	Jewett	
Fort Arthur Elec. Ry. Lt. & Tel. Commn.	2	Pass.	50-0	Int.	D. T.	Ottawa	.....	10	.....	32-0	City	S. T.	Cincinnati	
Portland Ry. Lt. & Power Co.	10	Box	40-0	.....	.....	Co. Shops	.....	20	.....	37-6	City	D. T.	Jewett	
	9	Flat	41-0	.....	.....	Integrate	.....	1	Flat	41-0	Both	D. T.	Co. Shops	
	10	Flat	30-0	.....	.....	Hicks	Texas Trac. Co.	15	.....	.....	Int.	.....	St. Louis	
	15	Flat	41-0	.....	.....	Hicks	Toledo Rys. & Lt.	14	Semiconv.	.....	City	.....	Co. Shops	
	15	Pass.	Open	City	D. T.	American Car	Toledo & Western	5	.....	52-0	.....	D. T.	Niles	
	15	Pass.	43-0	City	D. T.	American Car	.....	1	Box	36-0	.....	S. T.	Georgia Car	
	2	Elec. Loco.	.....	.....	.....	Gen. Elec. Co.	.....	1	Caboose	.....	.....	.....	Co. Shops	
Portland Ry.	20	Pass.	40-0	City	D. T.	American Car	Toledo Fostoria & Findlay	4	.....	51-1	Int.	D. T.	Niles	
	20	Pass.	40-0	City	D. T.	American Car	Tol. Pt. Clinton & Lakeside	5	Flat	.....	.....	D. T.	Hicks L. & C. Wk.	
Public Service Ry. Co.	51	Pass.	42-3	City	D. T.	Stephenson	Tol. Urban & Int.	1	Pass.	.....	.....	.....	Cincinnati	
	200	Pass.	42-8	City	D. T.	Cincinnati	Topeka Ry.	8	Pass.	32-0	City	S. T.	American Car	
Pueblo & Sub. Trac. & Ltg. Co.	2	Pass.	55-0	Int.	D. T.	Woebor Bros.	Toronto Ry.	100	Pass.	.....	Enter	D. T.	Co. Shops	
Puget Sd. Elec. Ry.	2	Pass.	50-0	Int.	D. T.	St. Louis	Toronto & York Radial	6	Pass.	55-0	Int.	D. T.	Co. Shops	
	3	Trail	50-0	Int.	D. T.	St. Louis	.....	1	Frt.	45-0	Int.	.....	Co. Shops	
	4	Parlor	55-0	Int.	D. T.	St. Louis	Toronto Sub. Ry.	3	Pass.	32-6	Int.	S. T.	Toronto Ry. C. Co.	
Que. Ry. Lt. & Power Co.	30	Flat	.....	.....	.....	Rathbun	.....	3	Pass.	28-6	Int.	S. T.	Co. Shops	
Radford Water Power Co.	1	Semiconv.	.....	.....	D. T.	Brill	.....	1	Exp.	35-0	Int.	S. T.	Co. Shops	
Raleigh Elec.	3	Semiconv.	41-2	Both	D. T.	Southern	Trans. St. Mary's Trac. Co.	20	Semiconv.	41-9	City	D. T.	Brill	
Rhode Island Co.	2	Exp.	41-2	Both	D. T.	Wason	Tri-City Ry. Co.	20	Pass.	34-0	City	S. T.	Co. Shops	
Richmond Lt. & R. R.	20	Open	43-0	City	D. T.	Stephenson	Trinidad Elec.	1	Loco.	30-0	Int.	D. T.	Co. Shops	
Roanoke Ry. & Elec. Co.	2	Conv.	.....	.....	D. T.	Brill	Twin City	70	Pass.	46-7 1/2	Int.	D. T.	Co. Shops	
	2	Semiconv.	.....	.....	D. T.	Brill	Union Elec. Co.	3	Box	30-0	City	S. T.	Danville	
Rochester Syracuse & East.	4	.....	.....	Int.	D. T.	Kuhlman	Union Trac. Co.	2	.....	.....	.....	.....	American Car	
Rockford & Int.	4	Exp.	.....	Int.	D. T.	Co. Shops	United Rys. (St. Louis)	5	Pass.	40-0	City	D. T.	Co. Shops	
Rockland Thomaston & Camden.	2	Frt.	.....	.....	.....	Co. Shops	United Trac. Co.	25	.....	.....	.....	.....	Co. Shops	
Sacramento Elec. Gas & Ry.	44	Pass.	.....	.....	D. T.	Co. Shops	Utah Lt. & Ry.	50	Semiconv.	.....	City	D. T.	Jones' Sons	
St. Jos. Ry. Lt. Ht. & Pwr.	10	Open	.....	.....	D. T.	American Car	.....	3	Loco.	.....	.....	D. T.	St. Louis	
	10	Closed	.....	.....	D. T.	American Car	Va. Pass. & Power Co.	20	Semiconv.	45-0	City	D. T.	Brill	
San Antonio Trac. Co.	10	Semiconv.	.....	City	D. T.	Kuhlman	Visalia Elec. Ry.	1	Loco.	.....	.....	.....	Baldwin	
San Bernardino Valley Trac.	2	Pass.	38-0	Int.	D. T.	St. Louis	Walla Walla Valley Trac. Co.	1	Frt.	.....	.....	.....	Co. Shops	
San Diego Elec. Ry.	12	Pass.	31-6	City	.....	Co. Shops	Warren-Bisbee Ry.	6	Pass.	.....	.....	D. T.	McGuire-Cum.	
San Fran. Vallejo & Napa Val.	2	Comb.	55-0	Int.	D. T.	Niles	Wash. Baltimore & Annapolis	19	Closed	60-0	Int.	D. T.	Niles	
	5	Pass.	55-0	Int.	D. T.	Niles	.....	4	Pass.	B. 54-0	Int.	D. T.	Niles	
	5	Pass.	43-0	Int.	D. T.	Niles	.....	2	Ex. & Sw.	54-0	Int.	D. T.	Niles	
Sanganon Val. Co.	1	Pass.	40-0	Int.	D. T.	St. Louis	Washington Ry. & Elec. Co.	25	Closed	41-2	.....	D. T.	St. Louis	
San Jose & Santa Clara County.	12	Semiconv.	.....	.....	D. T.	St. Louis	Washington Water Power Co.	1	Frt.	.....	Int.	D. T.	Co. Shops	
Sarnia St. Ry.	4	Pass.	.....	Both	D. T.	Ottawa	.....	2	Box Trail.	.....	Int.	.....	Co. Shops	
Savanna Elec. Schenectady Ry.	6	Pass.	40-6	City	D. T.	St. Louis	Waterloo Cedar F. & Northern	10	Open	30-0	City	S. T.	McGuire-Cum.	
	6	Pass.	41-10	City	D. T.	St. Louis	.....	7	Closed	32-0	City	S. T.	McGuire-Cum.	
Scranton Ry.	1	Exp.	.....	.....	D. T.	Jewett	Wausau St. Ry.	5	Pass.	21-0	City	D. T.	Cincinnati	
Seattle Elec. Co.	7	Cable	28-1	City	D. T.	Co. Shops	W. Chester St. Ry.	2	Pass.	42-9	Int.	S. T.	Brill	
	2	Cable	30-4	City	D. T.	Co. Shops	West Jersey & Sea Shore	10	Pass.	.....	Int.	.....	Am. C. & F. Co.	
	2	Frt.	42-0	City	D. T.	Co. Shops	.....	7	Pass.	.....	Int.	.....	Wason	
Seattle-Everett Int. Ry.	4	Pass.	41-0	Int.	D. T.	American Car	.....	2	Comb.	.....	Int.	.....	Wason	
Sea View R. R.	1	Frt.	48-0	Both	D. T.	Co. Shops	Western Ry. & Lt. Co.	3	.....	.....	.....	D. T.	Danville	
Shawinigan Falls Ry.	1	Loco.	.....	.....	.....	Can. Gen. Elec. Co.	.....	2	.....	.....	.....	D. T.	Danville	
Sheboygan Lt. Pow. & Ry. Co.	6	.....	28-0	City	S. T.	Cincinnati	Western Ohio	4	Frt.	48-11	Int.	S. T.	Co. Shops	
	3	.....	45-8	Int.	D. T.	Cincinnati	Whitcom Co. Ry. & Lt. Co.	1	Loco.	.....	.....	.....	Co. Shops	
Sherbrooke St. Ry.	4	Pass.	30-0	City	S. T.	Ottawa	.....	1	Exp.	.....	.....	.....	Co. Shops	
Sioux City Trac. Co.	8	Closed	37-0	City	D. T.	Co. Shops	.....	2	Coach	.....	City	S. T.	Jewett	

ROLLING STOCK EQUIPMENT ORDERED IN 1907—Continued.

Purchaser.	No.	Class.	Length.	Serv.	Trucks.	Builder.
Whateom Co. Ry. & Light Co.	3	Dump	.....	.....	.....	Oliver Mfg. Co.
.....	3	Flat	.....	.....	.....	Co. Shops
Wheeling Trac.	1	Semiconv.	40-0	City	D. T.	Kuhlman
Wilkesbarre & Hazleton	1	Exp.	.....	.....	.....	Co. Shops
Willamette Valley Trac.	5	.....	.....	.....	.....	Jewett
Williamsport Pass. Ry.	4	.....	.....	.....	.....	Brill
Wind. Essex & L.	5	Pass.	.....55-0	Int.	D. T.	Ottawa
Shore Rap. Ry.	2	Pass.	.....42-0	City	D. T.	Co. Shops
Winnipeg Elec. Ry.	28	Pass.	.....42-0	City	D. T.	Ottawa
Winona Int. Ry.	6	.....	.....	Int.	D. T.	Jewett
Winona Ry. & Lt. Co.	2	Pass.	.....28-0	City	S. T.	McGuire-Cum.
Worcest. & Holden St. Ry. Co.	1	Flat	.....32-0	.....	D. T.	Co. Shops
Worcester Consol. St. Ry.	10	Open	.....46-0	City	D. T.	Brill
.....	15	Closed	.....41-0	City	D. T.	Brill
.....	5	Closed	.....45-0	Int.	D. T.	Brill
.....	5	Exp.	.....	.....	.....	Wason
York Rys. Co.	1	Bagg.	.....45-0	Int.	D. T.	McGuire-Cum.
.....	2	Pass.	.....47-6	Int.	D. T.	Am. C. & F. Co.
.....	3	Pass.	.....30-6	Int.	S. T.	Am. C. & F. Co.
.....	4	Pass.	.....31-3	Int.	D. T.	Niles
.....	2	Bagg.	.....50-0	Int.	D. T.	Niles
Youngstown & Ohio River	5	Pass.	.....50-0	Int.	D. T.	Niles
.....	3	Comb.	.....50-0	Int.	D. T.	Niles
.....	1	Frt.	.....50-0	Int.	D. T.	Niles
<b>Total cars</b>	<b>6,311</b>					

RECEIVERSHIPS AND FORECLOSURES DURING 1907.

The list of electric railways for which receivers were appointed in 1907 shows plainly the effect of the condition of the money market. Most of the companies which became involved in financial troubles were small, but they include both established systems and new lines under construction which found themselves unable to meet obligations because of the inability to raise capital to prosecute their plans as stringency in the money market became more acute.

The most serious receivership proceedings inaugurated during the year were those involving the New York City Railway and the Metropolitan Street Railway of New York. As the investigations before the public service commission, first district, have disclosed, the difficulties of these companies were deep-seated. Although they culminated in the troublous times of last year, the causes were in nowise related to current conditions. The distress of these companies, furnishing urban transportation in one of the most densely settled passenger traffic territories in the world, had their foundation in abnormal overcapitalization and manipulation. While no one can say at this time how long the receivership of these properties will last, it is believed that the allied lines forming the other principal part of the Interborough-Metropolitan Company will not be involved in the drastic proceedings to which resort has been had for the leading surface roads in the merger.

It was anticipated that the receivership of the Chicago Union Traction Company, which has continued for nearly five years in the second largest city in the country, would be ended in 1907, but the difficulty of reconciling the various interests prevented the consummation of the reorganization of this property. Although the formal receivership may last for an indefinite time, complete arrangements have now been made for the reorganization of this property.

The list of receiverships established in 1907 shows a total of 26 roads operating 972 miles of track and having outstanding \$87,262,500 bonds and \$86,525,195 stock, making an aggregate capitalization for all of the companies of \$173,787,695. The companies follow:

Receiverships Established in 1907.

Railway—	Miles of track.	Stock.	Bonds.
Auburn & Turner Railroad, Lewiston, Me.	9	\$ 100,000	\$ 5,000
Vicksburg (Miss.) Railway & Light Company	9	500,000	325,000

Southern Light & Traction Company, Natchez, Miss.	7	456,700	340,000
Indianapolis Newcastle & Toledo Electric Ry., Newcastle, Ind.	140	3,500,000	4,500,000
Canyon City Florence & Royal Gorge Railroad, Canyon City, Colo.	.....	1,500,000	50,000
Mineral Wells (Tex.) Electric System	6	.....	.....
Missouri Water Light & Traction Company, Nevada, Mo.	4	100,000	.....
Winebago Traction Company, Oshkosh, Wis.	38	650,000	966,000
Mattoon (Ill.) City Railway—Central Illinois Traction Company, Mattoon, Ill.	14	500,000	490,000
North Jacksonville Street Railway Town & Improvement Company, Jacksonville, Fla.	6	.....	.....
Atlantic City & Suburban Traction Co., Pleasantville, N. J.	15	750,000	750,000
Catskill (N. Y.) Electric Railway	6	138,000	132,000
Washington Traction Company, South Charleston, O.	14	.....	.....
Mt. Mansfield Electric Railroad, Stowe, Vt.	12	510	200,000
Trenton Lakewood & Atlantic Railway, Trenton, N. J.	40	80,000	.....
Conneaut & Erie Traction Company, Erie, Pa.	35	800,000	1,179,500
Shelbyville & Ohio River Electric Railroad	.....	150,000	1,000,000
New York City Railway	517	20,000,000	1,761,000
Metropolitan Street Railway, New York	.....	52,000,000	70,814,000
Wilmington New Castle & Southern Railway	14	329,985	300,000
Indianapolis Huntington Columbia City & Northwestern Railway, Indianapolis	.....	1,500,000	200,000
Washington Arlington & Falls Church Railway, Rosslyn, Va.	25	100,000	350,000
Syracuse & South Bay Railway, Syracuse, N. Y.	.....	120,000	300,000
Cleveland & Sharon Electric Ry.	41	2,500,000	2,500,000
Pittsburg & Allegheny Valley Railway, Pittsburg, Pa.	20	750,000	1,100,000
<b>Totals</b>	<b>972</b>	<b>\$86,525,195</b>	<b>\$87,262,500</b>

The difficulties of the Atlantic City & Suburban Traction Company were the result of too heavy a bonded debt and of competition. It is expected that the property will be sold under foreclosure in March and returned to its owners. The receivership of the Catskill Electric Railway followed foreclosure of the mortgage on the property. The Mt. Mansfield Electric Railroad was placed in the hands of a receiver early in the year, but was sold under foreclosure in December and will be reorganized and established anew. The Trenton Lakewood & Atlantic Railway, the Shelbyville & Ohio River Electric Railroad, the Indianapolis Newcastle & Toledo Electric Railway, and the Indianapolis Huntington Columbia City & Northwestern Railway were under construction. The Auburn & Turner Railroad has been in the hands of a receiver since May 16, 1907, and all bills since that time have been paid and the receivers have expended \$1,500 on improvements and have had a considerable cash balance in the bank at all times. Nothing has been done toward disposing of the property by sale owing to conditions of the money market, but there are several possible buyers for the road.

The receivership of the Vicksburg Railway & Light Company was caused by the financial condition of the company and disagreement among those who controlled it. The Southern Light & Traction Company of Natchez, Miss., was placed in the hands of a receiver on account of a decision of the Mississippi supreme court declaring that the company was operating in violation of the anti-trust law of that state. The property of the Rockland South Thomaston & Owl's Head Railway of Lewiston, Me., was sold at foreclosure, but the court refused to confirm the sale and no subsequent sale has been held. The Canyon City Florence & Royal Gorge Interurban Railway of Canyon City, Colo., was placed in the hands of a receiver in January. The property has not been sold at

foreclosure or otherwise, but it is being purchased as needed and found useful by the Canyon City & Royal Gorge Railway, which is building an electric line from Canyon City to the top of the Royal Gorge, 25 miles. No assumption of the property of the old company is contemplated by the new company. The Mineral Wells Electric System was not incorporated and no stock or bonds were outstanding on the property.

The receivership of the Mattoon City Railway and of the Central Illinois Traction Company resulted from the serious wreck on the interurban line between Mattoon and Charleston in August last. Plans are being made for the settlement of the difficulties of the company and it is probable that the lines will be restored to their owners before long. The Syracuse & South Bay Railway of Syracuse, N. Y., went through foreclosure proceedings in February and the property was purchased by C. D. Beebe and transferred to the Syracuse & South Bay Electric Railroad. This company is now engaged in completing the road, which will be a double-track line from Syracuse to South Bay, a distance of 12 miles, and will, it is expected, be in operation on or before June 1, 1908. At the time of foreclosure only one track had been laid and it was in an uncompleted condition.

The number of foreclosure sales is much smaller than the list of receiverships. As conditions in the money market became more acute as the year progressed, there was less encouragement for roads which had sought the protection of the courts to re-establish their corporate positions than if all conditions had been favorable. The following shows the list of foreclosure sales in the year:

Foreclosure Sales in 1907.

Railway—	Miles of track.	Stock.	Bonds.
Newtown (Pa.) Electric Street Railway	28	\$ 300,000	\$ 300,000
Hudson Pelham & Salem Electric Railway	29	365,000	365,000
Henderson (Ky.) City Railway	10	250,000	150,000
Rockland South Thomaston & Owl's Head Railway	4		100,000
Syracuse & South Bay Railway, Syracuse, N. Y.		120,000	300,000
Mt. Mansfield Electric Railroad, Stowe, Vt.	12	510	200,000
Philadelphia & Easton Railway, Doylestown, Pa.	33	1,025,000	\$25,000
Chicago Electric Traction Co.	31	2,000,000	650,000
South Middlesex Street Railway	16	100,000	100,000
Chicago General Railway	21	500,000	1,727,500
Totals	184	\$4,660,510	\$4,717,500

The Newtown Electric Street Railway was acquired in the interest of the Newtown Langhorn & Bristol Street Railway and was afterward acquired by the new Bucks County Electric Railway, which acquired several connecting properties in and near Newtown, Pa. The Hudson Pelham & Salem Electric Railway had been in the hands of a receiver since December 11, 1904. When the receiver was appointed the company had \$365,000 bonds and a like amount of stock outstanding; but the property was sold at foreclosure on July 19, 1907, and was purchased by the Hudson Pelham & Salem Street Railway Company, which with the same mileage has issued \$200,000 bonds and \$200,000 stock. The sale at foreclosure of the property of the Chicago Electric Traction Company ended a receivership which had lasted since 1900. The property was acquired in the interest of the Chicago & Southern Traction Company, which is building a line to Kankakee and had been operating over the tracks of the Chicago Electric Traction Company in order to secure a Chicago entrance. The property of the Chicago General Railway had also been in the hands of a receiver since 1900.

The Nashville Interurban Railway, which is building from Nashville to Franklin, Tenn., has closed a power contract with the Nashville Railway & Light Company.

CLASS I TRUCK USED AT OAKLAND.

A special type of truck known as the "Class I" truck is used on all city equipments of the Oakland Traction Company at Oakland, Cal. From the illustration presented it will be noted that the principal side members of this design of truck are channel iron sections cut out at the ends to saddle over the journal boxes. No springs are used in the truck except those nested between the truck bolster and the transom. The truck bolster is a single casting made to move vertically within the confines of the transom. It

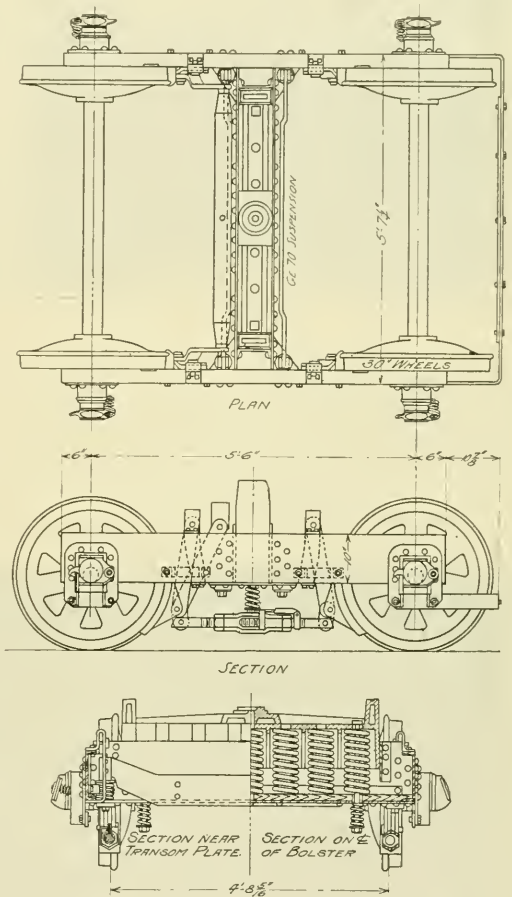

Oakland Traction Company—Class I Truck for City Service.

is supported by seven coil springs mounted as shown in the illustration. This type of truck has an advantage in that a large proportion of its parts are structural steel sections, which can be purchased in the open market and assembled with facility. These trucks as described and illustrated are built complete in the Emeryville shops of the Oakland Traction Company. Each truck carries two GE-70 motors.

It is announced that the Utah Light & Railway Company, Salt Lake City, Utah, will begin this summer the erection of a 10,000-horsepower power plant at the Devil's Gate, on property owned by the Harriman interests, and that its construction will cost about \$500,000.

### SHOP PRACTICE OF THE ALLEGHENY VALLEY STREET RAILWAY.

BY H. F. MENTZEL, MASTER MECHANIC.

The Allegheny Valley Street Railway Company operates an interurban line from Natrona to Aspinwall, Pa., 19 miles, and a local line from Natrona to New Kensington, 7.8 miles. These

four local cars, but as the traffic is heavy on Saturday and Sunday we sometimes need our entire equipment out on the road. On days of heavy travel, we couple our multiple-unit cars, running them in 2-car trains. Frequently three or four extra cars are required for special runs during the afternoon and evening.

All our repair work is done in the daytime, so that the night shop men act only as inspectors, except for such light

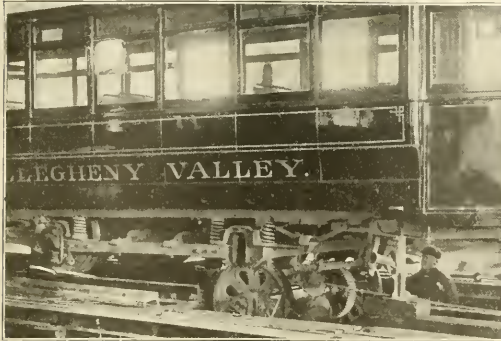

Allegheny Shop Practice—Changing Wheels from Single-Truck Car.



Allegheny Shop Practice—View of Wheels Being Raised from Repair Pit.

are both single-track lines laid with 7-inch girder rail. The interurban division has a double overhead trolley, which construction required no switches at regular turnouts. Believing that some of the shop practices on this line may be of interest to those engaged in similar work on other lines, I shall describe in detail our methods of inspection and repair work.

#### Rolling Stock.

The equipment which is now operated includes ten 45-foot double-truck cars. Each of these cars is equipped with four

duties as oiling cars, changing trolley wheels and adjusting brakes.

#### Car House Inspection—Night.

Our night men do no armature changing or repairing, unless it is a trivial repair such as a burned-off motor lead or brush spring or a controller finger.

As each car is taken off the road at night it is run over a pit by the inspectors and the brakes are adjusted, if necessary. Then the motors are inspected for armature clearance and all



Allegheny Shop Practice—Method of Supporting Body and Truck When Changing Wheels on Interurban Equipment.

Westinghouse 101-B motors. The control on eight of the cars is the Westinghouse electro-pneumatic type and on the other two cars the General Electric type M control is used. There are also ten 31-foot single-truck cars with Westinghouse No. 68 motors and B-23 controllers and two 28-foot single-truck cars with Westinghouse 38-B motors and K-11 controllers. The voltage on the line is 550.

The regular week-day schedule requires six interurban and

bolts gone over and if car is equipped with air the pump motor is shut off and the air reservoir drained. We have a bulletin board placed in the shop, and if a car is found to have low armature bearings and bad shoes the inspector does not renew the shoes or inspect the car further. He runs it off the pit track and devotes his time to other cars. He then marks up the car on the bulletin board, thus:

"Car No. 39 low armature bearings No. 2, motor, bad shoes,

not inspected." This car remains marked up this way until repaired, then is marked up, "Car No. 39, O. K."

**Starting Cars from Car House.**

All interurban cars are known by numbers and local cars by letters and a list is hung up in the crew room each morning, showing which car goes on any run, and where placed, thus:

"Car No. 34, run No. 2, time 5:02 a. m., No. 4 track, operating barn.

"Car No. 17, run No. A, time 5:27 a. m., No. 2 track, storage barn."

No car washing is done at night. The cleaner sweeps all cars, keeping up fires and cleaning cuspidors. All cab win-

ds of circuit slowly are removed and repaired. The fingers are adjusted and a drop light is held at back of the switches to facilitate the inspection of the contacts of the switches controlling the motor circuits.

Next is the air inspection. The supply pipe and train line are examined for leaks. Then the brake pipe is filled to 50 pounds pressure and inspected. The brake valve is taken apart and oiled. The governor is inspected and its piston oiled, and if the governor is not cutting in and out properly, it is reset.

We have no printed forms for air brake shop tests. We use a typewritten form as illustrated. These are filled out and the records made when the air brake apparatus has had an overhauling. The blanks are kept for reference and also to encourage the repair man in doing good work. We have found that their use creates a rivalry among the men, each striving to have the best report on tight piping. We pay particular attention to the brake equipment. The illustration was made from actual report, and I think the report a good one. This test as reported was made after the pump had been cleaned with gasoline and filled with new oil, the brake cylinder had been oiled and cleaned and the piping inspected.

Our air pumps and brake cylinders are taken from under the car every six months or as closely to that interval as possible, cleaned and the necessary repairs made. Since equipping our cars we have changed the suction of the air pump and

A. V. St. Ry. Co.		58-4-15-07 FORM 1-1
<b>INSPECTION CARD</b>		
Time <u>9:50 A M</u>		
Car No. <u>37</u>		Date <u>12-4-07</u>
MOTOR No. 1	<u>O.K. replaced axle Bearing</u>	
MOTOR No. 2	" "	
MOTOR No. 3	" "	
MOTOR No. 4	<u>Loose gear case O.K.</u>	
BATTERIES AND CONTROL	<u>Cleaned &amp; filled O.K.</u>	
TRUCK No. 1	<u>Inspected Blower O.K.</u>	
TRUCK No. 2	<u>2 new shoes</u>	
BODY	<u>Brakes adjusted</u>	
BODY	<u>O.K.</u>	
CURTAINS	" "	
SIGNAL BELLS	<u>Replaced Batteries</u>	
SEATS	<u>Reiled O.K.</u>	
WINDOWS	<u>Replaced cab Window</u>	
SAND BOXES	<u>O.K.</u>	
FENDERS	<u>O.K.</u>	
TROLLEY WHEELS	<u>O.K.</u>	
RETRIEVERS	<u>O.K. cleaned &amp; oiled</u>	
TROLLEY HOPE	<u>O.K.</u>	
AIR PUMP	<u>Oiled</u>	
GOVERNOR	<u>11 + set 65-75</u>	
PIPING	<u>O.K.</u>	
<u>H. E. Henry</u> Repairman		

Allegheny Valley St. Ry. Co.		
Shop Test.	Air Brakes.	
Car # <u>38</u>	Date <u>11-19-07</u>	Type <u>Westing.</u>
Pump ) Cut in <u>65</u> lbs. ) Pumped up from	Governor ) Cut out <u>75</u> lbs. ) 0 to <u>75</u> lbs. <u>1</u> Mi <u>48</u> Sec.	
Leaked from <u>75</u> lbs. to <u>65</u> lbs. <u>23</u> Mi. <u>46</u> Sec.		
Brake pipe filled to <u>50</u> lbs. Leaked to <u>3</u> Mi. <u>17</u> Sec.		
Voltage Variation <u>500 to 525 V</u> <u>W. Simmen</u> Inspector.		

**Allegheny Shop Practice—Air Brake Inspection Report.**

piped it from the inside of the car. The suction pipe end is in a box 8 inches square having screened sides. This box is filled with curled hair and at each inspection the hair is removed and cleaned.

After all control, motor and air apparatus has been inspected and repaired, the oiling is done and an inspection card illustrated is filled out and given to the shop foreman.

The inspection of G. E. type M control is made in the same manner. When two or three car trains are sent out from the shop, they are made up and the control is operated from each end of the train before being put into service.

**Changing Armatures.**

If an armature is to be removed it is secured to the upper half of the motor and lower half dropped. The armature is then removed with an armature jack.

All our air equipped cars are provided with hose connections. If we change an armature in a car not having air equipment, a hose is connected to any air car that may be handy so that all armatures when changed or fitted with new bearings may be blown out as well as the motors.

We turn all our bearings to fit. When an armature shaft is badly worn it is turned off true with no attempt to standardize the sizes as we would not get enough of the same size to justify us in making special size mandrels.

**Changing Wheels.**

As the illustration shows, we have a section of our pit-track that is removable. We change the wheels on our double-truck cars without removing the trucks. Two long rack jacks

**Allegheny Shop Practice—Car Inspection Report.**

downs in the car are cleaned first, the remaining time is then devoted to cleaning body windows.

**Inspection—Daylight.**

Inspection of cars with Westinghouse multiple control is made about every seven days. Each car is provided with hose connections for air and the inspector first blows out the motors and all the control apparatus. The brakes and trucks are inspected next. Then armature clearance.

The batteries for the control are next inspected and re-filled, if necessary, and every 30 days they are removed and re-charged as the charging given them by pump motors varies according to time the pump motor is operated.

After this inspecting has been done, one man operates the control while another inspects the line switch, reverser and switch group. Any switches found coming in or dropping out

are placed in the pit so that they will catch the axle inside of the gear wheels.

On single-truck cars we place a timber across the trap and raise the motor off the axle with a turn-buckle. This puts the weight of the motor on the car body instead of on the truck. A jack is placed on each side of the car body and at the end where the wheels are to be changed. Then the body and the truck are raised until the weight is off the wheels. The pit jacks are then raised until the wheels are clear of the track, which is then removed. The old wheels are then dropped into the pit, rolled to one side and the new wheels are put in.

It takes longer to remove gear cases, axle bearings and journal box bolts than it does to change wheels. Two men in our shop will change 3 pairs of wheels in 10 hours on the small cars.

The wheels on large cars are changed in the same way, except that as the truck is not fastened to the body, as on our single-truck cars, we first lift the body clear of the truck. Then at one end we place barrels in the pit to support the truck, and at the other end a timber is placed across the end of the truck and supported on each side by jacks. We have had a great deal of trouble with chipped and broken flanges

them in conduit. The cross sills of cars, with the exception of end sills, are based for 1 1/4-inch pipe conduit. We put three pipes lengthwise of the car, as shown by the sketch. The center pipe is used for the resistance leads and the two outer pipes contain the motor wires. These pipes are run within 8 inches of each end of the car body. From the end of the pipes the wires are carried to the controllers and resistances through the regular canvas hose. At the ends of the piping the wires are protected with canvas hose to prevent chafing.

The trolley ground wires are run under the car, the trolley connection on one side of the traps and the ground wire in the other. The wires of the different motors are put in in

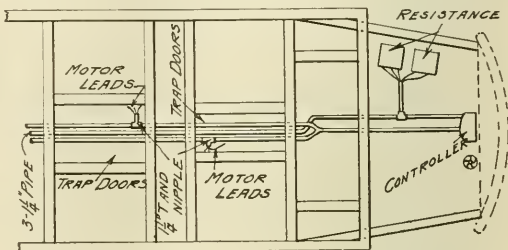

Allegheny Shop Practice—Arrangement of Conduits for Motor Wiring.

separate pipes. We have neither had trouble from cables since making these changes nor do we expect any.

Floors.

Our cars have double floors and a special construction is used to make a satisfactory trap door of double thickness. An accompanying sketch shows our method of bolting together the two thicknesses in the trap doors. The underside of the upper flooring is grooved, 1/4 by 2 inches, 4 inches from the ends. In these grooves is placed an iron strap 1/4 by 2 inches

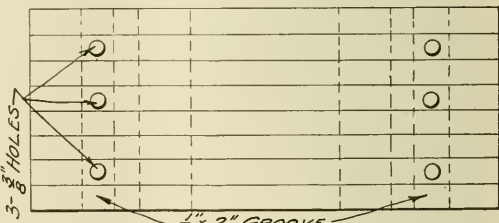
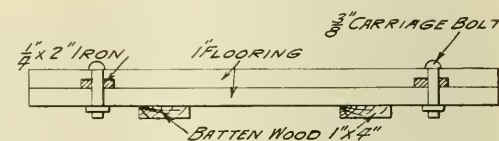

Allegheny Shop Practice—Details of Double Thickness Trap Doors.

in section. Bolts, 3 by 3/8 inches, passing through the iron hold the double flooring together. A wood batten, 1 by 4 inches, is fastened underneath as shown. This construction affords a trap door that will not split lengthwise, a trouble often occurring in the usual form of trap.

Rewinding Headlight Resistance.

Accompanying sketches show our way of rewinding porcelain resistance tubes used in the resistance boxes of Crouse-Hinds arc headlights for 500-volt street railway circuits. One

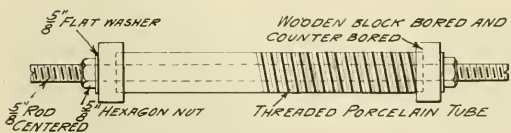
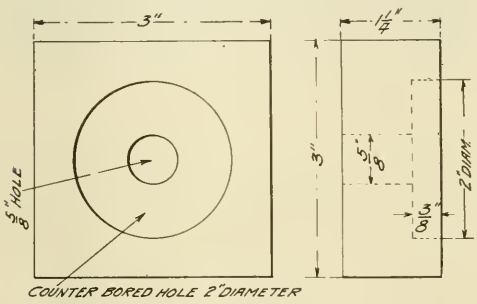

Allegheny Shop Practice—Scheme for Winding Heater Coils.

from cast wheels and are changing to steel tired and rolled steel wheels as rapidly as possible.

Car Washing.

All car washing is done by daylight. Cars are placed on the washing track after having been swept out. Cars are washed roof and all with the hose. The body is washed with soap and rinsed and wiped dry with a chamois skin. The inside of car and cabs are washed in the same way, if necessary; the seats are removed and the dust is blown out with an air hose.

Windows are cleaned last; we have been using "bon-ami" with success on windows. Cars are not washed at any stated time, the decision of the time being left to the barn foreman as cars are washed under his direction.

Car Wiring.

Our single-truck cars are all fitted with cross seats and no provision is made for running motor cables in the cars. Formerly we had considerable trouble with cable cutouts in wet weather, these being caused by water thrown by the wheels. To provide against the recurrence of such troubles, in fitting these cars for winter service we remove all cables and replace

block is removed, the tube put on, and the block replaced; the centering tube nuts are then drawn tight and the whole placed in a small lathe. Five minutes is all the time required to wind the wire on the tube. This scheme, while not original, is nevertheless handy.

#### Trolley Wheels.

We use Bayonet trolley harps only, and 6-inch felt-oiler trolley wheels made by the Detroit Trolley Wheel Company. When we receive new wheels, we put them in a tank filled with a light body oil, allowing them to remain there at least five hours. The tank is fitted with 24 hooks arranged along the side. When the wheels are lifted out of the oil a new axle pin is inserted in each one and they are then hung on the hooks until needed for a car. We always keep, in the storeroom, 12 wheels fitted to their harps, so that when required for use all that it is necessary to do is to place one on a pole and fill the reservoir of the wheel with oil. We find that by soaking the wheels as described, we can wear 9 out of 10 wheels through and still have the bushings in good condition. The reason for this result is easily understood: When wheels are put in service without soaking, the oil which is put in the reservoir is soaked up by the felt and none is left for future oiling, but if the wheels with felts in them are soaked first the oil finally put in is not taken up except to lubricate the bushing directly. This plan has given us excellent results.

#### MEETING CALLED TO FORM CENTRAL ELECTRIC TRAFFIC ASSOCIATION.

For the purpose of organizing a traffic association, a meeting of traffic officials of electric railways in the Central Electric territory will be held at the Algonquin hotel, Dayton, O., on January 22. The call for the meeting has been issued by F. D. Norveil, general passenger and freight agent of the Indiana Union Traction Company, Anderson, Ind. Mr. Norveil believes that the organization will be successfully established at this meeting and that it will prove to be of vast benefit to the electric railway interests in the territory which will be included, Ohio, Indiana, Illinois, the southern part of Michigan and the northern part of Kentucky. Mr. Norveil's letter, an abstract of which follows, shows that the proposed traffic association will not only have the cordial support of the Central Electric Railway Association, but will be a part of that organization:

#### Letter of F. D. Norveil.

Pursuant to the call for a meeting for the purpose of forming a traffic organization, composed of the traffic officers of the various electric lines in Indiana, Ohio, part of Michigan, Illinois and Kentucky, comprising practically the same territory as that which makes up the Central Passenger Association's territory, I would call your attention to the report of an impromptu meeting held at Indianapolis on November 20, 1907, when the subject was informally discussed. In view of its favorable reception by the representatives of the lines present on that day, and the almost unanimous replies received from various other traction lines in the states named, in favor of such an organization, and with the consent of the president and officers of the Central Electric Railway Association, we have set the day for the first meeting of the proposed traffic association. The meeting will be held at the Algonquin hotel, Dayton, O., on Wednesday, January 22, 1908. As this is the day before the regular annual meeting of the Central Electric Railway Association, which will be held at the same point, we would be glad if you would arrange to come prepared to make a two days' stay, devoting Wednesday to the preliminary organization of the traffic association, and spending Thursday at the Central Electric Railway Association's meeting. A banquet will be held at the Algonquin hotel on Thursday night, which we would be glad to have you attend. We are sure that you will derive much pleasure, and certainly great benefit from such a meeting and it will result in good to the traction lines interested.

In order that all electric railway organizations may remain closely allied, the president and officers of the Central Electric Railway Association, have consented to the formation of such an organization as a branch of that body.

This meeting is therefore indorsed by the Central Electric Railway Association, as attested by the signature of the president hereto attached.

#### Report of the Indianapolis Meeting.

The report of the meeting at Indianapolis on November 20, which is signed by the secretary, J. F. Starkey, follows:

On October 2, 1907, at a meeting called by the railway commission of Indiana for the purpose of adopting a uniform size of tariffs, and a system for filing same, the clerk of the commission appointed a committee of interurban traffic men for this purpose. On November 20, this committee invited all of the Indiana traffic officers to attend a meeting held at the Indiana state house to ratify the report of the committee.

After the adjournment of the committee, members of the various Indiana lines suggested that a meeting be held for informal discussion regarding a permanent traffic organization. This meeting was held at the Terminal building, and following is a list of the officials present:

F. D. Norveil, general passenger and freight agent Indiana Union Traction and Terre Haute Indianapolis & Eastern Traction companies.

W. S. Whitney, general passenger and freight agent Ohio Electric Railway.

J. B. Crawford, superintendent transportation Ft. Wayne & Wabash Valley Traction Company.

C. T. Price, passenger agent Western Ohio Railway.

A. G. Kelley, auditor Ft. Wayne & Springfield Traction Company.

C. G. Lohman, general superintendent Chicago South Bend & Northern Indiana Railway.

J. W. Mettlen, general freight agent Indianapolis Crawfordsville & Western Traction Company.

R. J. Thompson, assistant secretary and treasurer Indianapolis & Louisville Traction Company.

M. E. Graston, division passenger and freight agent Indiana Union Traction Company.

J. F. Starkey, division passenger and freight agent Indiana Union Traction Company.

J. H. Crall, division passenger and freight agent Indiana Union Traction and Terre Haute Indianapolis & Eastern Traction companies.

George S. Henry, traffic manager, Indianapolis & Cincinnati Traction Company.

After an informal, brief discussion on the matter of through freight rates and percentages, Mr. Norveil was appointed chairman, and he called the meeting to order, appointing Mr. Starkey secretary.

The chairman stated briefly the object of the meeting, which was that we might discuss the idea of the formation of a traffic organization, as a branch of the Central Electric Railway Association, which would be composed of the members of the traffic departments of the several interurban lines, represented and interested, and whose duties would be to formulate and compile tariffs, and joint arrangements whereby through traffic might be secured on a basis that would be beneficial and satisfactory to all concerned. After some discussion—in which all present seemed to be of one mind concerning such organization, that of the affirmative—the chairman stated that he thought it wise to have a committee appointed to formulate some sort of constitution for the proposed organization, such committee to present the constitution at the next meeting to be approved or modified, as deemed best at the meeting. Joint passenger and freight rates are to be in the hands of the association. The joint association was preferred at first, but if desirable, later on, a separation would be made, one association being formed for the passenger department, and another for the freight department.

On motion by Mr. Lohman, seconded by Mr. Graston, for the appointment of a committee of five to formulate the constitution, Mr. Price suggested that nine be appointed instead of five, and this being agreed upon, the chairman appointed the following as a committee:

W. S. Whitney, chairman, Columbus, O.

Charles F. Price, Lima, O.

George S. Henry, Indianapolis, Ind.

R. J. Thompson, Louisville, Ky.

A. G. Kelley, Ft. Wayne, Ind.

B. R. Stephens, Springfield, Ill.

George M. Parker, Detroit, Mich.

F. D. Norveil, Indianapolis, Ind.

J. O. Wilson, Cleveland, O.

After a brief discussion as to the territory this organization should cover, it was decided to include Indiana, Ohio, lower Michigan, and a portion of Illinois, and the northern part of Kentucky. The matter of expense incident to the initial work of the organization was discussed, but no decision was reached. It was decided that the chairman, Mr. Norveil,

should ask the various lines interested their opinions regarding the issuance of a joint interline passenger tariff looking to the furtherance of through traffic.

At the meeting of the Central Electric Railway Association, referred to in the foregoing, the annual election of officers will be held.

**ADVERTISING THE AURORA ELGIN & CHICAGO RAILROAD.**

The Aurora Elgin & Chicago Railroad was successfully advertised in the summer traffic season of 1907. Small advertisements were published frequently in the daily newspapers

attention of more purchasers of real estate to the district tributary to the road. He tried at first to interest people by working through different real estate firms, but did not find this method successful. When inquiries are received now by Mr. Breckinridge in response to his direct advertising, he refers the seekers after information to the principal real estate agents in Chicago or in the various towns who are posted concerning the particular class of property desired, believing that in this way he will accomplish much better results with people who are attracted by the country life and the unusual transportation facilities afforded by the road.

Other car posters have been used successfully by Mr. Breckinridge. The one which advertises the "Panhandle

**LIMITED TRAINS**  
FROM  
 GILBERTS, HUNTLEY, UNION, MARENGO, GARDEN PRAIRIE AND BELVIDERE  
 LEAVE FIFTH AVENUE TERMINAL AT  
**8.15 A.M., 12.00 NOON AND 6.15 P.M.**  
 AURORA, ELGIN & CHICAGO R. R.  
AND  
 ELGIN-BELVIDERE ELECTRIC CO.  
Connecting at Belvidere for Rockford, Freeport, Beloit, Janesville, and all points on  
**ROCKFORD & INTER-URBAN RY.**

NO OUTING EQUAL TO OUR  
**"PANHANDLE TRIP"**  
 110 MILES OF BEAUTIFUL SUBURBAN, COUNTRY AND RIVER SCENERY FOR \$1.25  
WITH STOP-OVER PRIVILEGE AT  
**AURORA AND ELGIN**  
Trains Every Half-hour on Week Days, Every Fifteen Minutes on Sundays, from 5th Ave. Terminal, Marshfield Ave. and 52nd Ave.  
**AURORA, ELGIN & CHICAGO R. R.**  
THE GREAT THIRD-RAIL ELECTRIC

Advertising the Aurora Elgin & Chicago Railroad—Posters Placed in Cars.

in Chicago to direct attention to the short trips offered by this company, both on its own lines and through connections with other railways. With the approach of winter weather the advertising of this character was discontinued and efforts

"Trip" has been effective in making famous that ride of 110 miles for \$1.25 from Chicago to Aurora and Elgin and return to Chicago. If close connections are made the round trip can be completed in four hours and 25 minutes. This trip is

**A Day in the Country**  
Will Do You Good  
Our new Outing Folder Will Tell You Where to Go.

**Aurora, Elgin & Chicago R. R.**  
 THE FOX RIVER VALLEY ROUTE

Special Car Furnished at Reasonable Rates.

Frequent Service.  
 Down Town Terminal  
 Union Loop, 5th Ave.,  
 near Jackson Blvd.

Trains now run direct to Oak Ridge and Mt. Carmel comeeries, with Federal Service from any station on Metropolitan Elevated.  
 Phone Harrison 5388.



THE PLACE  
**WHEATON COUNTRY FAIR**

THE DAYS  
**SEPTEMBER 12, 13, 14**

THE WAY  
**AURORA, ELGIN & CHICAGO RAILROAD**  
 The Great Third Rail Electric.

Trains every half hour all day. Additional express trains mornings and evenings. SPECIAL RATE, 50c Round Trip. Terminal Fifth av., near Jackson Blvd. All trains stop for passengers at Marshfield av., Fifth-Second av., and Desplaines av. Information, Phone Harrison 5388.

**Aurora, Elgin & Chicago Railroad**  
 The Fox River Valley Route

Outing Suggestions



To AURORA  
via Third Rail. Thence to GENEVO or YORKVILLE via our Fox River Trolley.

To BATAVIA  
via Third Rail. Thence to GENEVA or ST. CHARLES via Fox River Trolley.

To ELGIN  
via Third Rail. Thence to DUNDAS or CARPENTERSVILLE via Fox River Trolley.

"PANHANDLE" TRIP  
To AURORA or ELGIN via Third Rail, up or down the river by trolley and return to Chicago.

Frequent Service      Fast Trains  
 Seats for All          Low Rates

Terminal: FIFTH AV., Near  
 Jackson Boulevard  
 Information Phone Harrison 5388

Advertising the Aurora Elgin & Chicago Railroad—Samples of Newspaper Advertisements.

are now being made to attract business to the lines of the road in other ways. Richard Breckinridge, the traffic agent, had posters printed urging people who contemplate the construction of suburban homes to investigate the beautiful country along the Aurora Elgin & Chicago. These posters are carried in the cars of both the Aurora Elgin & Chicago road and the Metropolitan West Side Elevated Railway of Chicago, the tracks of which are used by the Aurora Elgin & Chicago in gaining entrance to the central business district of the city of Chicago. Mr. Breckinridge has advertised at numerous times within the last few years with the idea of attracting the

made entirely on the lines of the Aurora Elgin & Chicago road.

Daily Newspaper Advertising.

The effect of the advertising in the Chicago daily newspapers was manifest in large traffic in innumerable instances during last summer. Samples of the advertisements which were published are given in this issue. Mr. Breckinridge found that publication of these advertisements, measuring about four inches or 56 lines of newspaper space, attracted sufficient people to make a perceptible difference in traffic on all the days when the weather was favorable. The copy for



the advertisements was changed with nearly every insertion, but in most of them the trade-mark of the road appeared. When any special event was to take place at any point on the line it was advertised specially if weather conditions appeared favorable. For instance, when Judge Ben B. Lindsey, of the Denver juvenile court, spoke at the Aurora Chautauqua in Aurora, on Sunday, August 11, advertisements were published in the papers on August 10, calling attention briefly to the fact and to the frequent trains on the "great third rail electric."

During some of the hottest summer weather advertising was published on Saturday mornings. One week the advertisement was headed "Every Day is Cool on the Aurora Elgin & Chicago." On another Saturday it was announced that the Aurora Elgin & Chicago "Offers Outings for All Summer Long in Chicago's Greater Park, the Fox River Valley." After calling attention to the time of trains and the location

**Persons contemplating Suburban Homes would do well to investigate the beautiful country**  
ALONG THE  
**Aurora, Elgin & Chicago R. R.**  
**GOOD TOWNS—LOW RATES—FAST TRAINS**  
**REAL ESTATE AT REASONABLE PRICES**  
FOR FURTHER INFORMATION CALL ON  
**RICHARD BRECKINRIDGE, Traffic Agent**  
FIFTH AVENUE TERMINAL, CHICAGO

Advertising the Aurora Elgin & Chicago Railroad—Sample of Poster Placed in Cars.

of the downtown terminal this advertisement added "High Speed Without Cinders, Dust or Smoke; Beautiful Scenery, Modern Cars, Low Rates."

**Rates of Fare.**

Other advertising issued by the road includes booklets with maps and half-tone pictures of scenes on the lines. The booklets also contain the rates of fare, which are as follows:

	Miles.	Single-trip fare.	Round-trip fare.	Fare by using \$5.00 interchangeable coupon ticket.	54-ride monthly individual ticket.	60-ride monthly individual ticket.
Maywood	11.0	\$0.10	\$0.20	.....	.....	.....
Bellewood	13.0	.15	.30	.....	.....	.....
South Elmhurst	16.0	.20	.40	.16%	5.70	6.30
Lombard	20.5	.25	.50	.20%	6.00	6.65
Glen Ellyn	23.0	.30	.55	.25	6.40	7.10
Wheaton	25.5	.35	.65	.29½	6.75	7.50
Chicago Golf Grounds	26.5	.40	.75	.33½	7.65	8.50
Warrenville	30.5	.45	.85	.37½	8.10	9.00
Aurora	39.5	.60	1.10	.50	9.00	10.00
Glenwood Park	39.5	.55	1.00	.45%	.....	.....
Batavia	40.0	.55	1.00	.45%	8.75	9.70
Wayne	34.8	.50	.95	.41%	8.55	9.50
Elgin	42.0	.60	1.10	.50	9.00	10.00

Tokio, Japan, has 90 miles of electric railways, exclusive of suburban lines, all under the management of one Japanese company. The 700 cars in daily use carry an average of 300,000 passengers, and have already displaced more than half the jinrickshaws. A 2½-cent fare and complete transfer system is in force, but as yet there are no unions. Wages are on a minimum basis of \$6 per month for both conductor and motorman. The track is narrow gauge, owing to the narrow streets. All the cars, etc., are made in Japan from American and European ideas.—Exchange.

**A SUGGESTION TO ELIMINATE OVERCROWDING OF SURFACE CARS IN NEW YORK.**

The transit committee of the City Club of New York, which has made extensive investigations of the city's transportation problems, on December 28 sent to the public service commission a letter protesting against the proposed ordinance to regulate the number of passengers to be carried on the surface cars. In place of such a regulation, the committee proposes a plan of requiring the company to operate cars providing a definite number of seats. The letter is as follows:

The receivers of the New York Railway Company have submitted to your commission a draft of a regulation or ordinance, designed to limit to 65 the number of passengers that may ride on a street surface car at any one time. They ask your endorsement of this proposed measure.

Believing you will welcome an expression of opinion from any citizens interested in and studying the transit problem of the city, we submit for consideration our views on the proposed regulation.

We believe it is an unwise measure for the following reasons:

- (1) Your commission appears to have ample power to so regulate the handling of cars as to furnish the greatest possible convenience to the public.
- (2) It is inexpedient to attempt to regulate the number standing in cars by limiting the load, because (a) the American public is unaccustomed to such restrictions, and would not readily adapt itself to this form of regulation; (b) the enforcement of such a regulation, if in the form of an ordinance, would necessarily rest in the hands of the police, and these officers would not be likely to enforce it. An ordinance has been on the books for many years, section 57, revised code of ordinances, which requires that no electric car in Brooklyn "shall carry more passengers than 50 per cent more than its seating capacity." There is no pretense of enforcing it. (c) Such a regulation becomes a dead letter through lack of enforcement, and the public, seeing overcrowding after its enactment as bad as before, would lose faith in all attempts at regulation, and would come to believe that overcrowding is an unavoidable evil.

We desire to propose a form of regulation which we believe will do all that can wisely be done to equalize the load carried by each car.

Where increased transit facilities were needed the commission has heretofore issued orders for an additional number of cars to be run between certain hours. This method has undoubtedly secured a larger number of cars, but has not secured the full number of seats needed or possible in general, since the cars in use are small, with but two longitudinal side seats, and are constructed to accommodate standing rather than sitting passengers. What is desired, we assume, is that such a type of car shall be used as will furnish the greatest possible number of seats in a given period.

We therefore suggest that the commission periodically ascertain the traffic needs of every line and thereupon require the operating company to furnish during every 5-minute period a designated number of seats, rather than a stated number of cars. If the track capacity has been reached with the present type of cars, such order would make it necessary on the part of the operating company to increase the seating capacity of each car.

This form of regulation has the following advantages:

- (1) The enforcement remains in the hands of the commission.
- (2) It is definite and enforceable.
- (3) A would-be passenger may choose whether he desires to ride on a crowded car or to wait for other cars, which, under this regulation, he may be assured will speedily come.
- (4) It tends to induce the operating company to furnish cars with a maximum number of sittings rather than a maximum standing room as at present. It may cause them to experiment with larger cars or double-decked cars, or some type which will furnish the maximum number of seats per unit.

We believe that regulation of the running of cars by the above method would not only secure to the public the best accommodation possible with the present type of cars, but would also tend to cause the operating companies to secure a type of car that would utilize the tracks to their fullest capacity.

The Georgia Railway & Electric Company of Atlanta, Ga., announces that approximately 46,000,000 passengers were carried on its lines during the year 1907, an increase of 6,000,000, or 14 per cent over 1906.

**DEPRECIATION OF CARDIFF ELECTRIC TRAMWAY AND LIGHTING UNDERTAKINGS.\***

In a report to the chairman and members of the "Electric Lighting, and Tramway" committee, John Alcock, the Cardiff city treasurer and controller, deals with the question of depreciation in regard to both the tramways and lighting undertakings as follows:

**Tramways.**

I have recently given further attention to this question, and have been supplied by the city electrical engineer and manager with the rates of depreciation which he considers represent fair wear and tear, based upon his expert knowledge of the condition of the Cardiff plant, and the undertaking generally. I have extracted the expenditure of the various sections of the work as shown by the following table, and against such cost I have calculated the annual amount of depreciation which is necessary, and in a further column the sinking fund, which has been set aside to redeem the loans which have been raised on those parts of the undertaking which are subject to depreciation.

Purpose—	Expenditure.	Per cent.	Sinking fund instalment.		
			Amount.	Years.	Am't.
Track and bonding....	£209,369	5	£10,468	30	£4,225
Cars .....	79,602	10	7,960	15	4,202
Buildings .....	115,365	2½	2,884	30	2,228
Buildings .....	8,500	2½	212	25	230
Engines and generators	41,591	5	2,079	30	839
Engines and generators	22,500	5	1,125	25	597
Boilers, pumps, economizers .....	15,544	5	777	30	313
Boilers, pumps, economizers .....	6,350	5	317	25	168
Mechanical stokers and coal bunkers.....	1,736	5	86	30	35
Mechanical stokers and coal bunkers.....	2,550	5	127	25	67
Steam and other pipes.	8,485	5	424	30	171
Steam and other pipes.	6,374	5	318	25	169
Switchboards and instruments .....	5,933	7½	444	30	119
Tools, plants, etc.....	4,268	7½	320	30	86
Conduits and cables....	53,957	3	1,678	30	1,088
	£582,124		£29,159		£14,637

In the foregoing calculations, nothing has been provided for the depreciation of the accumulators. The reason for this is that they are being maintained by the Tudor Accumulator Company for a period of ten years from July, 1901, and it does not appear necessary during the continuance of this contract that further provision should be made.

If, however, the present conditions were altered, it would be necessary for me to submit a further report on this particular expenditure.

Annual depreciation as per foregoing table.....	£29,159
Annual charge for sinking fund.....	£14,637

Annual amount to be provided in addition to sinking fund.....	£14,522
---	---------

Note.—Of this amount the committee has already approved the provision of \$5,500 as per resolution dated February 22, 1907, leaving a further annual sum of £9,022 still to be provided.

I do not think I need labor the point as to whether a provision for depreciation is necessary—this, I feel, will be readily conceded. There is, however, a question as to how such depreciation should be calculated, and I recommend that the committee approve the principle of setting aside as a depreciation fund the difference between the actual depreciation, based on the life of the several parts, and the sinking fund, which has been set aside in respect thereof.

The argument has been advanced that the corporation, in addition to maintaining a sinking fund, should also provide for the full depreciation on their various undertakings, but I do not agree with this contention, as the outcome of such a practice would mean that the present generation would redeem the loans, and at the end of the time an amount equal to the whole of the capital invested would be in hand in addition, in the shape of a depreciation fund, notwithstanding the fact that the undertaking had been kept up to date as far as this was possible out of revenue. To provide sinking fund and full depreciation would inflict a double burden upon the present generation which I do not think fair, and I feel that if a

certain amount is set aside each year, based upon the difference between the depreciation and the sinking fund, that the corporation will have done all that can reasonably be expected.

Some portion of the existing materials could be utilized when the track is reconstructed, and there may possibly be a sum in hand on this particular section which would exceed the actual amount required for reconstruction, calculated at £4,000 per mile, but the sum in hand would not exceed the balance of loan remaining due on the track, and which had not already been provided by means of a sinking fund. The question of obsolescence of plant may in the future operate on the subject of depreciation, but, as a matter of fact, it is impossible to state with any degree of definiteness the liability which might accrue under this heading as it entirely depends upon improvements in machinery and also the introduction of labor-saving appliances, etc.

**Electric Lighting.**

The city electrical engineer and manager has kindly supplied me with the various rates of depreciation which, in his opinion, represents the annual fair wear and tear of the various portions of the electric light undertaking. In this case, also, I have extracted the expenditure of the various sections of the work which are subject to depreciation, and they are shown by the following table, with the annual amount of such depreciation and the annual charges for contribution to sinking fund.

Purpose—	Expenditure.	Per cent.	Sinking fund instalment.		
			Amount.	Years.	Am't.
Buildings .....	£ 20,342	2½	£ 539	25	£ 539
Machinery .....	41,980	5	2,099	25	1,114
Mains and services .....	105,361	3	3,160	25	2,796
Transformers, motors, etc. ....	30,436	5	1,521	25	807
Meters .....	10,800	7½	810	25	286
Electrical instruments..	4,660	7½	349	25	123
	£213,579		£8,478		£5,655

A provision has not been made for accumulators, as the conditions are similar to those which obtain in the tramways department.

From this it will be seen that the loan charges necessitate payments to the sinking fund amounting to £5,655 per annum. The period sanctioned for the loans does not represent the life of the various sections of the undertaking and the full depreciation works out at £8,478 per annum. The difference between these two sums, namely, £2,823, is the amount which I recommend to be set aside in addition to the sinking fund, in order that when the effective life of the various portions of the plant and machinery comes to an end, due provision will have been made for the repayment of the original loan, viz., sinking fund in hand, plus depreciation fund.

**Generally.**

The rates of depreciation are based upon the supposition that they will operate in each case from the date of the opening of the works. This in the case of the tramways would be 1902, and electric light 1895, and the committee may be met with the statement ha such depreciation should be provided from these dates, calculated on the capital expenditure at the end of each financial year. I would, however, point out that there are no funds available for this purpose, and, under all the circumstances, I recommend that the first payment to the fund be dealt with in the current year's accounts, and that the future profits be also transferred to depreciation funds until such time as the amount standing to the credit thereof equals the amount which should be in the fund. If in any year the profits should be insufficient to meet the charges recommended for depreciation, I suggest that such liability should be the first charge on future profits.

Arthur Ellis, city electrical engineer and manager, entirely agrees with the views expressed in this report.

At a meeting of the committee the report was adopted.

The Ohio Electric Railway Company is building a power house near Lewistown reservoir for the Bellefontaine-Lima line, now nearly completed, and is erecting a substation near West Liberty for the Bellefontaine-Springfield line, which has been in operation for about two years. When the new Lima line is opened, about April 1, it is stated that the company will open a pleasure resort at the Lewistown reservoir, which has been made a state park, and will arrange an hourly service in each direction between Bellefontaine and Lima and Springfield.

\*From Electrical Engineering (London) December 19, 1907.

**RECEIVERS APPOINTED, THEN DISCHARGED, FOR CHICAGO & MILWAUKEE ELECTRIC RAILROAD.**

On a petition of attorneys for the holder of 25 shares of stock, Judge Tuthill of the Cook county circuit court appointed receivers for the Chicago & Milwaukee Electric Railroad on December 31. As this step was taken without notice to the road, all concerned took immediate measures to adjust the differences which precipitated the receivership, with the result that on January 3 attorneys for the principal interests involved appeared before the court and secured the discharge of the receivers.

Charles G. Dawes, formerly comptroller of the currency and now president of the Central Trust Company, Chicago, ex-Mayor Carter H. Harrison of Chicago and Gordon A. Ramsay were named as receivers, but only Mr. Ramsay qualified.

The bill on which the action of the court was based was filed by Tolman, Redfield & Sexton, representing Charles J. Monahan, the owner of the 25 shares of stock. The bill alleged manipulation of stocks and bonds by Albert C. Frost, president of the Chicago & Milwaukee Electric Railroad, and charged that through "dummy" directors Mr. Frost had secured large, if not the controlling, interests in the following corporations:

Chicago & Milwaukee Electric Railway, an Illinois corporation, with capital of .....	\$1,000,000
Chicago & Milwaukee Electric Railroad, an Illinois corporation, with capital of .....	5,000,000
Chicago & Milwaukee Electric Railroad, a Wisconsin corporation, with a capital of .....	300,000
Chicago & Milwaukee Electric Railway, a Wisconsin corporation with a capital of .....	100,000
Waukegan Fox Lake & Western Railway, an Illinois corporation, with a capital of .....	100,000
Kenosha Electric Railway, a Wisconsin corporation, with a capital increased from \$50,000 to .....	1,000,000
Chicago & Milwaukee Power Company, an Illinois corporation, with a capital of .....	5,000,000
Ravinia Park Company, an Illinois corporation, with a capital of .....	200,000
The Racine Stone Company, a Wisconsin corporation, with a capital of .....	100,000
The Libertyville Trotting Association, an Illinois corporation (capital not given) .....	
The Alaska Central Railroad Company, a Washington corporation (capital not given) .....	
A. C. Frost & Co., a firm or copartnership .....	

Mr. Frost is said to have been connected in his dealings with the railroad company from 1897 to 1902 with "his client," whose name was not given. The "client" is understood to have been George A. Ball, a glass manufacturer of Muncie, Ind., who announced promptly that he still has an interest in the companies and is satisfied with the management.

The bill declared that when Mr. Frost announced to the directors that the business of the company required improvements in the line of the railroad from Evanston to Waukegan, a power plant at Highwood, reconstruction of trolley lines and a second line of track from Highland Park north, the work was done by the Republic Construction Company, of which Mr. Frost was president.

Following the action of the court conferences were held all day on January 1 between two of the receivers, John S. Miller, representing Mr. Frost, and representatives of various other interests. It was impossible for the attorneys to reach an agreement on that day, but the fact was developed that larger interests than those divulged in the bill setting forth the rights of the holder of 25 shares of stock were involved. Among those who participated in the conferences were G. L. Francis, R. Cassels and Amelius Jarvis of Toronto, representing large bondholders in Canada.

The final result of the conferences, which lasted all day and until midnight on January 2, was the agreement to appear before the court on the morning of January 3 and ask for a termination of the receivership. Mr. Dawes issued the following statement concerning the agreement which was signed by the various interests:

In this connection I will say that this is the result of the negotiations among the parties in interest, lasting now continuously for two days and a night, in which, without exception, every difference has been sunk by all in their co-operation for what was believed to be for the common good. These concessions have not been small. They have been many and large. In view of the very great variety and extent, both direct and collateral, of the interests involved, not only here but abroad, the outcome is most satisfactory. It only indicates that among business men the spirit of co-operation for good in a common cause can yet be appealed to with confidence and safety.

Mr. Tolman made a statement in which he said:

None of our demands has been denied. Our charges of fraud and manipulation, however, fall of their own weight, and they are buried and forgotten. The whole trouble will now be smoothed out in a private and peaceable manner and not in court. All interests have been provided for in the stipulation of settlement. Trustees will be appointed in any cases where the situation demands. In this manner the rough edges will be ironed down and claims gradually but certainly met.

Mr Frost has issued a statement as follows:

Although the action taken was a most unfortunate one, especially as it was taken on the eve of the company's semi-annual payment of interest, the company's finances have not been affected. The January interest coupons, amounting to \$250,000, are being paid as presented and the funds are provided to meet all other obligations of the company, as well as the completion of the road into Milwaukee early this spring. For the purpose of having the charges in the bill, that stocks and bonds of this company have been used for building up other enterprises, proved to be absolutely false, I have executed a document by which Mr. Dawes will have the right to examine into this question, and if he finds that funds or securities of any kind have been used for the building up of other enterprises these funds and securities will be immediately placed in the possession of the company. The facts are that this company has issued no bonds or stocks for nearly three years, during which time nearly \$500,000 has been expended on its property for permanent improvements and betterments. I take this opportunity of stating that Mr. Dawes worked untiringly two days and a large part of one night in his effort to have the receivership dismissed and the property restored to the company for the good of the community and the large number of investors interested.

**STEAM RAILROAD CONSTRUCTION DURING 1907.**

Figures compiled by The Railway Age show the number of miles of new track built by the steam railroads during the calendar year 1907 in each state as follows:

State—	No. lines.	Miles.	State—	No. lines.	Miles.
Alabama .....	14	185.60	Nebraska .....	4	40.70
Alaska .....	2	27.08	Nevada .....	9	189.21
Arizona .....	1	26.66	New Jersey .....	1	.56
Arkansas .....	16	138.14	New Mexico .....	6	121.45
California .....	14	253.46	New York .....	12	98.99
Colorado .....	7	79.29	North Carolina ..	12	155.77
Dist. of Columbia 1		6.90	North Dakota ..	5	197.45
Florida .....	10	320.00	Ohio .....	3	19.98
Georgia .....	9	157.99	Oklahoma .....	4	160.80
Idaho .....	7	124.68	Oregon .....	6	57.57
Illinois .....	11	106.47	Pennsylvania .....	27	147.67
Indiana .....	7	108.32	South Carolina ..	9	73.02
Iowa .....	4	78.00	South Dakota ..	7	385.83
Kansas .....	3	16.70	Tennessee .....	12	40.79
Kentucky .....	9	60.33	Texas .....	25	381.09
Louisiana .....	22	422.41	Utah .....	4	36.10
Maine .....	1	33.00	Vermont .....	1	5.09
Maryland .....	1	.70	Virginia .....	13	206.45
Michigan .....	13	66.08	Washington .....	7	311.01
Minnesota .....	10	217.36	West Virginia ..	14	94.47
Mississippi .....	19	261.59	Wisconsin .....	7	117.84
Missouri .....	11	91.11	Wyoming .....	3	74.64
Montana .....	2	175.90			

Total in 45 states and territories.....374 5,874.25

Note.—It will be noted that the total number of lines given is not the sum of those in each state because of the fact that several lines extend into two or more states. During 1906 the steam roads built 6,100 miles of new track. The decrease for 1907 is therefore 226 miles.

The Brooklyn Rapid Transit Company will reduce its line of \$16,000,000 fire insurance with stock companies to \$3,000,000. The rest of the risk will be carried directly by the company.

INTERURBAN MAP OF THE CENTRAL STATES.

(WITH INSET.)

Following the practice of the past two years we present herewith as a supplement to the first issue of the year a map showing the electric interurban railways of the central states, operating, under construction or projected. A comparison with the maps issued in January, 1906, by the Street Railway Review, and on January 5, 1907, by its successor, the Electric Railway Review, affords an interesting study of the progress of electric railway construction in the territory where the development of interurban roads has been most pronounced. The greater part of the new track has been laid as extensions of existing systems, although several important new roads have been built, especially in Indiana, where the increase in mileage during the year just past amounts to 426 miles. A detailed statement of the mileage of the Indiana lines appears below.

This map, for which we are indebted to The Arnold Company of Chicago, has been carefully brought up to date from official reports, and is believed to be very complete. However, if errors are observed, the Electric Railway Review will be grateful for any information that will assist in making its records more complete.

INTERURBAN MILEAGE IN INDIANA.

Statistics compiled by the Indiana railroad commission show that there are 1,538.93 miles of interurban railroad in the state against 1,113 miles last year, an increase of 426 miles. These statistics do not include street railways. There are 30 electric railway systems in operation in the state, the one of largest mileage being the Terre Haute Indianapolis & Eastern Traction Company, with 351.40 miles. The shortest line is the French Lick & West Baden, operated between those two towns, a distance of 1.9 miles.

The following table exhibits the total and division mileages of the various companies, the letter A indicating that the road operates partly by steam power and the letter B that gasoline motor power is used:

	Miles.	Total miles.
Angola Railway & Power Company—		
Angola-James Lake .....		3.75
Cincinnati Lawrenceburg & Aurora Electric Street Railway Company—		
State Line-Aurora .....		9.13
Dayton & Western Traction Company—		
State Line-Richmond .....		2.50
Evansville & Eastern Electric Railway—		
Newburg-Rockport .....		21.00
Evansville & Mt. Vernon Electric Railroad—		
Evansville-Mt. Vernon .....		16.87
Evansville & Princeton Traction Company—		
Evansville-Princeton .....		28.25
Evansville Suburban & Newburg Railroad (A)—		
Evansville-Newburg .....	10.00	.....
Bvansville Junction-Boonville .....	14.57	24.57
French Lick & West Baden Railway Company—		
French Lick-West Baden .....		1.09
Ft. Wayne & Wabash Valley Traction Company—		
Ft. Wayne-Bluffton .....	24.79	.....
Ft. Wayne-Logansport .....	76.00	.....
Lafayette-Battle Ground .....	9.09	.....
Logansport-Lafayette .....	38.10	147.98
Ft. Wayne & Springfield Railroad—		
Ft. Wayne-Decatur .....		21.60
Hammond Whiting & East Chicago Electric Railway Company—		
Hammond-Whiting-East Chicago .....		25.53
Indiana Union Traction Company—		
Muncie-Union City .....	33.20	.....
Anderson-Middletown .....	9.61	.....
Muncie-Bluffton .....	41.80	.....
Kokomo-Peru .....	19.19	.....
Indianapolis-Muncie .....	56.55	.....
Indianapolis-Logansport .....	79.74	.....
Anderson-Wabash .....	52.94	.....
Alexandria-Tipton .....	20.00	313.03

Indianapolis & Cincinnati Traction Company—		
Indianapolis-Shelbyville .....	28.86	.....
Shelbyville-Greensburg .....	21.07	.....
Indianapolis-Rushville .....	41.30	.....
Rushville-Comersville .....	16.93	108.16
Indianapolis Columbus & Southern Traction Company—		
Indianapolis-Columbus .....	40.04	.....
Columbus-Seymour .....	22.35	62.39
Indianapolis Crawfordsville & Western Traction Company—		
Indianapolis-Crawfordsville .....		45.00
Indianapolis & Louisville Traction Company—		
Seymour-Scottsburg-Sellersburg .....		40.92
Kokomo Marion & Western Traction Company—		
Kokomo-Greentown-Marion .....		27.95
Lebanon & Thornton Traction Company—		
Lebanon-Thornton .....		9.90
Lima & Toledo Traction Company .....		20.73
Louisville & Northern Railway & Light Company—		
Jeffersonville-Charlestown .....	13.68	.....
Watson-Sellersburg .....	4.15	17.83
Louisville & Southern Indiana Traction Company—		
New Albany-Jeffersonville .....		6.00
Muncie & Portland Traction Company—		
Muncie-Dunkirk-Portland .....		30.59
Marion Bluffton & Eastern Traction Company—		
Marion-Bluffton .....		31.57
Northern Indiana Railway Company—		
South Bend-Goshen .....	27.00	.....
South Bend-Lakes .....	6.30	.....
La Porte-Michigan City .....	14.00	47.30
Southern Michigan Railway Company—		
South Bend-Indiana-Michigan Line .....		5.86
St. Joseph Valley Traction Company (B)—		
La Grange-Middleburg .....		17.91
St. Joseph Valley Railway Company (B)—		
La Grange-Angola .....		26.77
Terre Haute Indianapolis & Eastern Traction Company—		
Indianapolis-Lebanon .....	28.29	.....
Lebanon-Frankfort-Lafayette .....	40.46	.....
Lebanon-Crawfordsville .....	23.50	.....
Indianapolis-Dublin .....	51.34	.....
Dunreith-New Castle .....	10.90	.....
Dublin-Richmond .....	17.32	.....
Cambridge City-Milton .....	2.07	.....
Indianapolis-Martinsville .....	30.64	.....
Indianapolis-Plainfield .....	14.23	.....
Indianapolis-Danville .....	20.10	.....
Plainfield-Harmony .....	39.31	.....
Terre Haute-Harmony .....	18.95	.....
Terre Haute-St. Marys-State Line .....	12.04	.....
Terre Haute-Sullivan .....	26.30	.....
Terre Haute-Clinton .....	15.95	351.40
Toledo & Chicago Interurban Railway Company—		
Ft. Wayne-Garrett-Auburn-Waterloo .....	25.00	.....
Garrett-Kendallville .....	12.00	37.00
Winona Interurban Railway Company—		
Warsaw-Goshen .....	25.14	.....
Warsaw-Winona Lake .....	2.00	.....
Peru-Chilli .....	9.21	36.35
Total mileage .....		1,538.93

President W. H. Fledderjohann of the Ft. Wayne & Springfield Railway Company has asked the board of public works and the mayor of Ft. Wayne, Ind., to be allowed to run cars every three hours instead of every hour as provided in the franchise. Mr. Fledderjohann says that owing to the money stringency the operation of an hourly schedule will result in a financial loss to the company.

It is reported that the question of a bond issue for the purpose of constructing a subway system will be placed before the people of San Francisco at an early election. A number of prominent business men are said to have been planning the enterprise for over a year and a petition to the board of supervisors asking for the issuance of \$4,500,000 of bonds is now being prepared. Supervisors M. I. Sullivan and Isidor Jacobs are named among the supporters of the project.



**MAP**  
 SHOWING  
**ELECTRIC INTERURBAN RAILWAYS**  
 IN THE  
**CENTRAL STATES**

90 100



AMERICAN STREET AND INTERURBAN RAILWAY ASSOCIATION.

President C. G. Goodrich of the American Street and Interurban Railway Association has issued a letter to the general managers of member companies, announcing the establishment of a statistical bureau of information. The letter reads as follows:

While necessarily much of the time of the secretary and his assistants during the past two years has been devoted to various matters incident to the general upbuilding of the organization, considerable attention has been given to the establishment of a statistical bureau of information at the association headquarters.

Realizing the great value which such a central source of information may become to the member companies, your executive committee has recently made arrangements whereby the secretary will, from now on, be assisted by a statistician who has had several years of practical experience in this line of electric railway work.

The association already has a valuable statistical library, and this will be enlarged from time to time so that eventually it will contain copies of practically all governmental, state and municipal laws, reports and documents of general value to our members, as well as copies of various books, pamphlets, reports and other statistical data bearing upon the general subject of street and interurban railways.

As fast as data are obtained they will be placed in bulletin form and issued to the member companies. It is expected that such bulletins will be issued monthly hereafter, and the first one, containing confidential information on wages of conductors and motormen, will be ready for distribution in January, 1908.

While a number of lines of investigation are already well under way, there are undoubtedly many other subjects which might be investigated to great advantage to the member companies. As the primary value of the association is to be of real service to all of its members, you will aid very materially in accomplishing its purpose if you will kindly address a letter to the secretary, informing him what investigations in your estimation might be carried on by the association to the best advantage, not only of the member companies in general, but of your own company in particular. There is no question but that the association work can be of value to your company, but to accomplish this result we must have your hearty co-operation.

Bernard V. Swenson, secretary-treasurer of the association, has also issued two circular letters, under date of January 2, 1908, to members and associate members, from which the following extracts are taken:

Much has been accomplished by the committees of the various associations during the past year, probably the most important and far-reaching in value to the member companies being the work of the standardization committee of the Engineering association, the classification committee of the Accountants' association and the insurance committee of the American association.

The Atlantic City convention was the most successful one which has ever been held by the various associations and the several reports contain much that is of interest and value to the member companies. The proceedings of the Accountants' and Claim Agents' associations have already been distributed to the member companies in pamphlet form, and those of the American and Engineering associations will be completed and sent out within another week. The cloth bound volumes, containing the proceedings of all four associations, will be ready for distribution by January 18, which is exactly three months after the close of the convention.

At the 1907 convention the executive committee was requested to take steps toward the organization of a fourth affiliated association which would take over all of the general work of the American association relating to transportation, traffic and operation, leaving the American association free to devote its time to executive matters and questions of broad policy. It is expected that this new association will be organized in the near future and a communication relative to this matter will soon be sent to the member companies.

Since the convention last October much important work has been done by the American and Accountants' associations in connection with the classification of accounts, which is soon to be adopted by the interstate commerce commission. A communication relative to this matter will be sent to each member company in the near future.

The report of the treasurer for the year ending October 1, 1907, showed total receipts of approximately \$25,000 and expenditures of practically the same amount as the receipts.

The expenditures during the year 1907-1908 will probably be somewhat more than those of the year 1906-1907, as the work of all of the associations is becoming broader and more comprehensive. It is therefore quite essential that the old member companies continue in their support and that the membership be increased during the coming year. During the year just past the membership increased approximately 15 per cent, and it is expected that, with a more active campaign for membership, the increase during the coming year will be considerably greater.

Considerable attention has been devoted to the question of a suitable badge to be worn by associate members and several designs have already been submitted to the secretary. It is expected that the executive committee will take some action in this matter at its January meeting.

NEW SUBWAY ROUTE RECOMMENDED BY PUBLIC SERVICE COMMISSION OF NEW YORK CITY.

Almost the last official act of the public service commission of New York City in the first year of its existence was

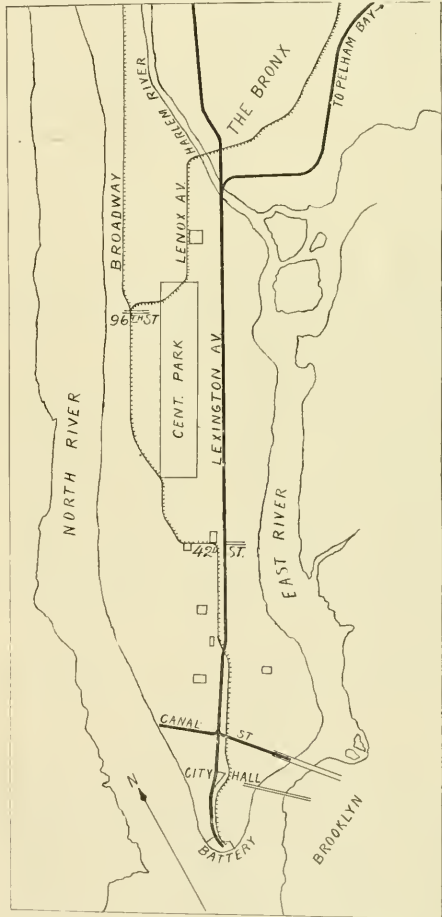

Subway Route Recommended by the Public Service Commission of New York City.

the recommendation of a new subway route to meet the requirements of the boroughs of Manhattan and the Bronx. As shown on the accompanying sketch map, the new route starts from the Battery and closely parallels the existing subway, on

one side or the other of the latter, as far as Forty-second street. Instead of deflecting at this point the proposed new route continues straight ahead under Lexington avenue to the Harlem river. After passing underneath the river the route diverges, one line continuing in a general northeasterly direction toward Pelham Bay and Mamaroneck and the other proceeded in a general northerly direction to and underneath Jerome avenue.

At Canal street branches will extend to the North and East rivers, at the latter point connecting with the approach of Manhattan bridge to Brooklyn.

The estimated cost of the work is \$60,000,000 and it is proposed to have the plans ready for inviting bids about March 1, 1908.

As will be seen from inspection of the sketch, the route follows to a considerable extent the route of the proposed Lexington avenue subway, plans for which were prepared early last year and described in the Electric Railway Review of April 13, 1907, page 486. The former plans failed to meet the approval of the authorities and the matter has been held in abeyance up to the present time.

Prepared as these plans will be, under the authority and with the approval of the commission in advance, it is probable that something tangible will result in the addition of transportation facilities for the Bronx, which needs them so badly. At first glance it appears that the routes, so far as that borough is concerned, are well located to serve the needs of that extensive section without serious interference with existing routes of travel. So far as the downtown section of Manhattan is concerned, the proposed route is criticized in some quarters as following too closely the existing lines of travel. But the central avenue of downtown Manhattan is and probably always will be Broadway, and the distance from Broadway in each direction to the river and to the business establishments located in the intervening territory is so short that it appears that the greater number of passengers are served by locating the route in that vicinity.

A feature that commends itself is the directness of the route. It is substantially a bee-line from the Battery to the Bronx. It is proposed to make it entirely independent of the existing subway, under which it will pass in the neighborhood of Twelfth street, and to make connection with the New York Central at Forty-second street and at Mott Haven (One Hundred and Thirty-eighth street). It will run close to the Steinway tunnel at Forty-second street and to the Blackwell's Island bridge at Fifty-ninth street. At the lower end by a swing to the west at City Hall it will pass close to the end of the Hudson Companies' tunnels and be sufficiently close for another connection at Ninth street. On the Brooklyn side, also, connection would be easy with the authorized Fourth avenue line.

The commission expresses the view that by reason of these numerous possible connections the proposition will be an attractive one from the financial point of view.

#### Malicious Destruction of Property.

Vigorous steps should be taken to punish severely the men or boys who either through wanton mischief or with criminal intent take wire from transmission lines in lonely districts or destroy insulators by using them as a mark to shoot at. One instance is told by our Peoria correspondent: "The lightning storm of last week developed trouble on the Illinois Traction Company's high-tension transmission line. The trouble was finally located, and was found to be caused by hunters shooting away the high-tension insulators. Twenty-two were found to be defective and all had to be replaced. The company has posted a notice offering a reward of \$50 for information that will lead to the arrest and conviction of the guilty persons." This is no isolated case, nor is Illinois the only state in which these depredations are committed. We

have heard of some very ingenious methods adopted to take wire from poles even when transmitting current at high potential, but it would serve no useful purpose to set forth how this perverted cleverness is manifested. But the tampering with transmission circuits is a serious matter to power-generating companies, particularly exasperating because usually there is no trace to the offenders. If existing laws are inadequate, others more stringent should be enacted before the power companies resort to the last expedient of patrolling their lines by armed guards.—The Western Electrician.

#### GERMAN AIR CLEANING APPARATUS.

The system of cleaning cars, residences and offices by compressed air is now being extensively employed in this country as well as in Europe, the vacuum air cleaning system being a modification which is also largely employed. With this apparatus dust suckers carry the dirt into receptacles provided for the purpose and exhausted by pumps. For car cleaning and the cleaning of depots and station offices, a portable, electrically driven vacuum pump or compressor is used. This pump is mounted on a truck with an electric cable coiled on a wheel for providing electric current from any nearby source. A hose connects the pump with a dust sucker. By simply moving this sucker over the car seats or the office furniture the dust is removed rapidly and effectively.

In Germany the apparatus shown in the accompanying illustration is utilized extensively for cleaning the walls,

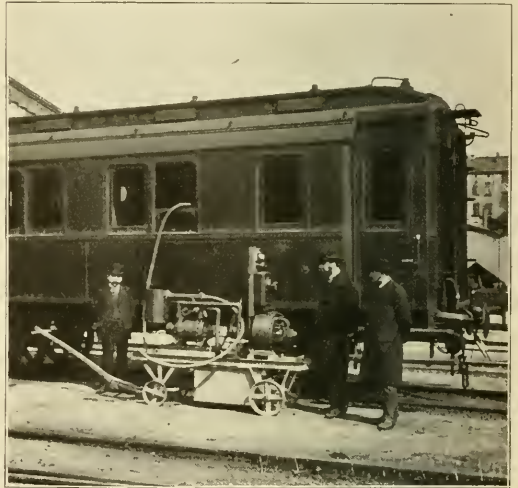

Portable Vacuum Cleaning Outfit.

drapery and furniture of many homes, apartment houses and flats. A permanent pipe is connected to the outside wall of a building, with terminal hose connections near the windows. At the street level a terminal connection is provided to which may be attached a pipe from a portable vacuum pump. The motors, which are of small capacity, are operated from any lighting circuit.

The following statistics, compiled by The Railway Age, give the number of locomotives and passenger and freight cars ordered by the steam railroads of the United States, Canada and Mexico during 1907 and the preceding six years:

	1901.	1902.	1903.	1904.	1905.	1906.	1907.
Locomotives . . . .	4,340	4,665	3,283	2,538	6,265	5,642	3,482
Passenger cars . . .	2,879	3,459	2,310	2,213	3,289	3,402	1,791
Freight cars . . . .	193,439	195,248	108,936	136,561	341,315	310,315	151,711



## RECENT ELECTRIC RAILWAY LEGAL DECISIONS.

BY J. L. ROSENBERGER, LL. B., OF THE CHICAGO BAR.

## Suddenly Turning Team to Cross Track.

Metropolitan Railway Company v. Fonville, 91 Pacific Reporter, 902.—The supreme court of Oklahoma holds that a driver of a vehicle who suddenly turns his team to cross a street railway track without looking and listening for an approaching car, and without taking the ordinary care and precautions imperatively required of all who place themselves in a similar position of danger, is guilty of contributory negligence as a matter of law.

## No Error in Excluding Evidence of Having No Report of Accidents.

Randazzo v. Brooklyn Heights Railroad Company, 106 New York Supplement, 193.—The supreme court of New York, appellate division, second department, holds that in a personal injury case where there was no evidence that the defendant required, or that it was customary for reports of accidents to be made by its employes, there was no error in excluding evidence that there was no report of the alleged accident in question on the files of the company, as such evidence could have no weight.

## Reasonableness of Speed.

Smith v. Connecticut Railway & Lighting Company, 67 Atlantic Reporter, 888.—The supreme court of errors of Connecticut says that the reasonableness of the speed at which a car is run is to be measured by the relation of that speed to the particular circumstances under which it is maintained. A speed of 20 miles an hour might not be unreasonable in the open country, where the view is unobstructed, and there are no travelers in sight. A speed of three or four miles an hour might be unreasonable in a crowded street, when other vehicles or pedestrians were on the tracks in front, or obviously on the point of crossing them.

## Liability for Injury from Acceleration of Speed After Passenger Has Gone on Platform to Alight After Signal.

Ranous v. Seattle Electric Company, 92 Pacific Reporter, 382.—The supreme court of Washington says that cases might be cited establishing: (1) That a street car passenger, who leaves his seat when the car is approaching his destination and goes to the platform for the purpose of alighting when the car comes to a stop, is not as a matter of law guilty of contributory negligence. (2) That a street railway company is not liable to such a passenger for injuries resulting from the ordinary jolting or jerking of the car, or the acceleration of its speed for the purpose of reaching its usual stopping place.

But this case presented a different question. The plaintiff was not injured by the ordinary jerking or jolting of the car in reaching its usual stopping place, nor by the acceleration of its speed for that purpose. The testimony on her part tended to show that at the time of paying her fare, or surrendering her transfer, she made known to the conductor in charge of the car her desire to alight at Sixth avenue, and between Seventh and Eighth avenues she made a like request. As the car passed Seventh avenue the conductor sounded the bell. As the car approached Sixth avenue at a slow rate of speed, she arose from her seat and proceeded to the back platform of the car, with the intention of alighting from the car when the same should come to a stop. As the car reached about the center of Sixth avenue its speed was suddenly accelerated, and the lurch caused by such acceleration threw the plaintiff from her position on the back platform of the car into the street. The evidence, the court holds, was sufficient to justify a verdict in her favor.

As to the contention that the conductor and motorman did not know that the plaintiff was on the platform or in a place of danger, the court says that if the bell was sounded to stop the car at Sixth avenue, as the plaintiff contended, the operators in charge of the car were bound to know that passengers might and constantly do act upon the warning thus given.

## Kind of Employes Required for Exercise of Highest Care—\$3,500 Verdict Sustained.

Connell v. Seattle Renton & Southern Railway Company, 92 Pacific Reporter, 377.—The supreme court of Washington says that it seems almost axiomatic that only very careful, prudent and experienced operators of cars can exercise the highest degree of care.

The plaintiff in this case, it appeared, was standing and holding to a strap in a car crowded full of passengers. The force of a collision with another car threw her violently in the mass of passengers, and she was much bruised about her side and injured about her ribs and spine. She was shown to be very nervous after the accident, although she was reasonably strong and well before. For years she had worked and earned her own living expenses. At the time of the injuries she was employed in a store in the alteration of ladies tailor-made gowns; but after the accident she had been unable to follow that vocation, or any other. Under such evidence the court will not say that a verdict for \$3,500 in her favor was excessive.

## Validity of City Ordinance Prohibiting the Sale, Giving Away or Receiving of Transfers.

City of Chicago v. Openheim and others, 82 Northeastern Reporter, 294.—The supreme court of Illinois says that the defendants were arrested on a charge of violating a city ordinance prohibiting any person from selling a street railway transfer ticket issued by a street railway company within the city, given to a passenger for the purpose of authorizing him to transfer from one car line to another without the payment of additional fare, as also prohibiting any person from giving away such transfer ticket for the purpose of enabling the person to whom given to use or offer it for passage upon any street railway car or cars, and further prohibiting any person from receiving any transfer ticket in the manner prohibited by the ordinance, and from using, attempting to use or offering the same for passage upon any street railway car or cars.

Upon a hearing in the municipal court, without a jury, all of the parties were discharged. The supreme court holds that such disposition of the cases was erroneous, as the ordinance was valid, contrary to the opinion of the lower court.

The supreme court says that this ordinance was enacted for the benefit of passengers wishing to make a trip which necessitated the use of more than one line of the street railway company. It was not within the contemplation of the city council, in adopting the ordinance, that a person wishing to make a trip to a point reached by the initial line of passage should have the right to demand a transfer ticket for the purpose of selling it to someone else, to be used in making a trip over a connecting line of the street railway company. When a passenger pays his fare on the street railway he is entitled to a transfer ticket if in making his trip he desires to transfer from one line to another upon which transfers are issued, and such transfer is good upon the line over which it is issued if used at the place and within the time required. Limiting it to the use of the person to whom issued is not taking it away from him so that he is divested of his title and possession, and does not therefore deprive him of his property.

Nor was the court's opinion changed by the argument that the ordinance prohibits the selling or giving away of street railway transfer tickets without any limitation or restriction and without any regard to the place where issued or the time

when issued, so that if a person to whom a transfer had been issued should sell or give it away at any time after the right to use it had expired, or at any place, however distant, from the place where it was authorized to be used, such person would be subject to the penalties provided by the ordinance for its violation.

**Tracks Treated as Property of Company Using Them—Ownership of Car and Division of Fares Immaterial—Car Cleaning and Repairing May be Delegated.**

*Beckman v. Meadville & Cambridge Springs Street Railway Company*, 67 Atlantic Reporter, 983.—The supreme court of Pennsylvania says that the tracks at the point where the plaintiff's husband was killed were the property of the Meadville Traction Company, but were in joint use by that company and the defendant under a traffic agreement. For the purposes of this case, therefore, they were to be considered as the property of each in turn while in use by it.

Under the agreement the cars of the defendant were to be cleaned and repaired by the traction company. Two cars of the defendant had been delivered under this arrangement to the traction company, which dismantled one of them, attached it by chains to the other, and started both toward the car barn for cleaning and repair. On the way the coupling chains broke and the dismantled car ran on a down grade at increasing speed until it collided with the car of the defendant on a siding, in which latter car was the plaintiff's husband.

The fact that the colliding car was the property of the defendant was immaterial. For the time being it was the property of the traction company, having been delivered to it for repair and not yet returned. Whether it was on its way to the car barn for further work or for storage or for delivery was not material. It had not been returned to the defendant, but was still in the hands and under the control of the traction company, which for this purpose was an independent contractor.

Cleaning and repairing cars was no part of the defendant's franchise which could not be delegated. It was the ordinary case of an independent mechanic receiving an article for repair, and while in custody of it so using it as to injure another person. If the traction company had hauled the car out to the other end of its road for the repairs and the accident had taken place there, where the defendant's cars did not run, no question would have arisen as to the defendant's liability. Yet the case was no different. Neither the ownership of the colliding car nor the place of the accident had any relevancy at all to the question of the defendant's liability.

The negligence, if any, from which the accident resulted was, so far as the evidence showed, that of the workmen who attached the dismantled car to the one drawing it. They were the employees of the traction company. Some effort was made to show that the defendant paid for their services, but the evidence only went so far as to show that as between the two companies the traction company was to repair and clean the cars at cost, and that it therefore kept an account, among other things, of the wages paid for such services, and the defendant paid on that basis. The workmen themselves were employed, controlled and discharged by the traction company and were in no sense coemployees of the defendant.

Another effort was made to hold the defendant liable on the ground that by the agreement it paid the traction company 2½ cents for every passenger it carried over the latter's lines, and therefore when the plaintiff's husband paid his fare there arose a joint obligation of both companies for his safe carriage. But there was no basis for such claim. The defendant under the agreement was a lessee of running rights over the traction company's tracks, and the division of fares was only a method of estimating the rental to be paid. The traction company remained in the sole ownership and control of the road, and the defendant no more entered into a joint liability by that arrangement than any other tenant by an agreement

to pay rent to his landlord. The class of cases arising from accidents caused by defective roadbed running regulations, etc., for which the joint users of the road are equally liable to their passengers, had no applicability to the facts of the present case.

Summing up the whole case, briefly, it showed the defendant using what must be treated as its own track, lawfully and without negligence, and having its passenger killed by the act of a third party, over whom it had no control, and for whose action it was in no wise responsible. The presumption of negligence arising from the death of a passenger by collision having been fully rebutted, and there being no evidence to show negligence in fact, a verdict should have been directed for the defendant.

**Rights of Passenger Carried Beyond Destination and Injured After Leaving Car with Advice of Conductor.**

*Stevens v. Kansas City Elevated Railway Company*, 105 Southwestern Reporter, 26.—The Kansas City court of appeals holds that if the plaintiff informed the conductor of the place where she wished to depart, the place thus designated being a regular station, it became the duty of the conductor to stop the car at that place, call its name or otherwise notify her that she had reached it, and to hold the car a reasonably sufficient time for her to leave it in safety. The relation of passenger and carrier does not cease until the carrier transports the passenger to his destination, and affords him a reasonable opportunity to alight in safety from the vehicle.

Where the passenger is induced to forego the right to be carried to his destination by the representation that he can reach it in safety by following proffered directions, he is justified in relying on the superior knowledge of the trainmen, and should not be held to have abandoned his contract right to be carried to his destination, and there permitted to alight in safety. Constructively he remains a passenger until he reaches that point, and is entitled to recover for any injuries he may sustain from following the negligent directions he received from the carrier's servants. The directions being given by the conductor in an attempt to perform the contract of the carrier are within the scope of his employment, and bind the carrier to answer in damages for the injuries caused by them.

If, however, the plaintiff failed to give timely notice of her intended destination, and when the car stopped at that point to permit passengers to alight remained in her seat, she was not entitled to recover from the fact that the conductor afterward negligently directed her relative to the best way to reach her destination. The court does not agree with counsel for the defendant in the proposition that, when the car left that point, she had ceased to become a passenger, and the defendant owed her no contractual duty. The fare she paid entitled her to ride to the end of the line if she chose. On receiving timely notice from her, it was the duty of the defendant to stop at any regular station and give her a reasonable opportunity to alight. If she failed to give such notice and was carried past the point where she intended to stop, that was her fault, and, although she still continued to be a passenger until she left the car, the defendant owed her no duty to carry her back to her destination under the contract then in force. If she decided to leave the car at the next stopping place and return afoot, the defendant would be in no wise responsible for the consequences of such decision, and when it stopped the car and permitted her to alight it fully discharged its contractual duty, and, from the instant she stepped in safety to the street she ceased to be a passenger. In stepping to the street, under such an hypothesis of facts, the plaintiff voluntarily abandoned her status as passenger and thereafter she could follow the advice or directions the conductor had given her, or proceed in any other way, but in either event the defendant should not be held responsible for her future mishaps.

# News of the Week

## Car Operated Through Hoboken Tunnel.

One of the new steel cars which will be operated through the Hudson Companies' tunnel under the Hudson river made the first complete trip from Morton street, Manhattan, to Hoboken, N. J., on December 28. E. M. Hedley, superintendent of the Hudson River Tunnel Company, acted as motor-man and a number of officials and engineers made up the party.

## Strike on the Local Lines of the Indiana Union Traction Company.

A strike was declared on January 1 by the motormen and conductors employed on the local lines of the Indiana Union Traction Company at Anderson and Muncie, Ind., who are members of the Amalgamated Association of Street and Electric Railway Employees. From reports it seems that the men's reason for the strike is that the company on December 31 signed a 3-year wage contract with the Brotherhood of Interurban Trainmen, of which most of the company's trainmen are members, instead of with the Amalgamated association. Members of the Amalgamated association presented an ultimatum to the company on Monday threatening a strike if the contract with their association was not signed by 6 p. m. The schedules provided for in the two contracts are said to be practically the same. General Manager H. A. Nicholl replied that he had signed a contract with the brotherhood as representing the majority of the employees and that no reduction of wages for either interurban or local men was contemplated.

Strikebreakers from Chicago were placed on the cars in Muncie and Anderson on Tuesday when the men walked out. This action was followed by a riot at Muncie on Tuesday afternoon. The men on the cars were attacked by a stone-throwing mob of strikers and sympathizers and retaliated by shooting. Two bystanders were shot, a street car was demolished and an interurban car was badly damaged. Several persons received injuries. The rioting did not cease until every car was sent to the barns.

On Thursday, when the company again attempted to run cars, the rioting was resumed and the cars had to be taken back to the barns. On Friday morning two cars were wrecked by the strikers. As we go to press we are advised by telegraph that four companies of the Indiana militia are assembled at Indianapolis and four others are waiting outside of the city, having been summoned by Governor Hanly, who awaits word from Adjutant-General Perry before sending them to Muncie. Cars are running at Muncie under police protection, but the company has cars lined up at Indianapolis ready to transport the soldiers to Muncie at a moment's notice if necessary.

**To Discuss Form of Annual Report.**—The Ontario Railway and Municipal Board has fixed January 21 as the date upon which it will receive a deputation of Ontario members of the Canadian Street Railway Association for the purpose of discussing objections to the form of the annual reports required by the board.

**American Institute of Electrical Engineers.**—A meeting of the Worcester Polytechnic Institute section of the American Institute of Electrical Engineers was held at Worcester, Mass., on January 3. J. A. Sandford, Jr., addressed the meeting on the subject of "Requirements, Manufacture and Present Good Usage of Porcelain Insulators for High-Voltage Lines."

**Recent Accidents.**—About twenty persons are said to have been injured in a head-on collision on December 28, between two cars of the Eastern Pennsylvania Railways Company on the line between Tamaqua and Lansford. The accident occurred on a single-track line shortly after midnight during a heavy fog, which prevented the motormen from seeing the cars until too late.

**Railway Signal Association.**—A regular meeting of the Railway Signal Association will be held at New York, N. Y. (Engineering Societies building, Room No. 6), on January 14, beginning at 10 a. m. The programme includes discussion of the reports of the committees on "Automatic Block Signals" and on "Electric Interlocking" and a paper by F. R. Cook on "Economic Operation of Electric Signals and Care and Maintenance of Storage Batteries in Signal Work."

**New York Commission to Continue Investigation.**—Chairman Wilcox of the New York public service commission has announced that the commission will continue at an early date

its investigations into the financial affairs of the various transit lines of the city. The commission also proposes to turn its attention to the new East Side subway, the removal of the New York Central tracks from Eleventh avenue, the building of future subways and hearings on service orders.

**Decision Favors Dallas, Tex., Students.**—Judge Tucker of the district court at Dallas, Tex., has rendered a decision in favor of college students, who brought suit to compel the Dallas Consolidated Electric Street Railway to issue half-fare tickets. The court holds that the act of the legislature of 1903, requiring street railway companies to issue half-fare transportation in certain cases to students not over 16 years of age, is still in force, and that it was not repealed by the anti-free pass law of the thirtieth legislature. The court also holds that the word "grades," as used in the act of 1903, refers to the students and not to the school.

**Electrification of Sarnia Tunnel Nearing Completion.**—The power house, overhead construction, track bonding and practically all other work in connection with the electrification of the Sarnia-Port Huron tunnel of the Grand Trunk under the St. Clair river has been completed and three of the electric locomotives have been received. A preliminary test of the electrical equipment was made during the latter part of last month and it is expected that regular operation of trains through the tunnel by electric locomotives will be commenced in a few weeks. The power station units are two 1,250-kilowatt Parsons turbine generators to furnish single-phase current at 3,300 volts potential direct to the trolley.

**No-Seat No-Fare Hearing.**—Six cases selected by the council for the city of Jersey City, N. J., to test the no-seat no-fare ordinance recently upheld by the state supreme court were heard before a police justice on December 30. The North Jersey Street Railway, against which the cases were brought, was represented by Col. E. W. Hine, assistant to the president, and William D. Edwards, of counsel. Several witnesses for the city testified that they had boarded the company's cars, leaving the Pennsylvania ferry terminal, and refused to pay fare until given seats. They had been informed by the conductors that no seats were available, but that they must pay fare or leave the car. The cases were all postponed until the following day, when the court acquitted the company in one case and fined it \$50 in another.

**Oregon Electric Railway's New Line Opened.**—Regular service from Portland to Salem, Ore., was begun by this company on January 1, with the operation of one car a day between the terminals of the road. As rapidly as possible more equipment will be provided and it is expected that by February 1 eight trains will be running in each direction daily. There are nine regular passenger and freight stations, located as follows: Portland, Multnomah, Tualatin, Tonguin, Wilsonville, Donal, West Woodburn, Waconda and Salem. A temporary arrangement for fares based on the 3-cents-a-mile basis has been announced with round-trip, commutation and week-end tickets at reduced rates. The permanent schedule of fares will be arranged as soon as the details incident to the opening of the line have been worked out. Power for operating the road is obtained from the Portland Railway Light & Power Company. The road, as completed, is 50 miles long. It is proposed, however, to build during the coming year a branch from Portland to Forest Grove, 26 miles long, and one from Salem to Albany and Eugene, Ore., 68 miles long. It is planned to have the Forest Grove branch completed by August 1 of this year.

**Philadelphia Rapid Transit Company Refuses to Deal with Union.**—The strike which the employees of the Philadelphia Rapid Transit Company threatened about two weeks ago has not yet been declared and the general opinion in Philadelphia seems to be that there will be no strike. Mayor Reyburn, at the request of the Central Labor Union, has attempted to arrange for a conference between the officials of the company and the union to discuss the demands of the men for an increase in wages and better working conditions. The directors held a meeting on December 26 and passed resolutions, which were communicated by the mayor to the Central Labor Union, to the effect that they deemed any conferences between the company and the union inadvisable and unnecessary. The directors stated that "the company has already exceeded its abilities in remunerating its employees and any conference could not possibly result in any benefit or change other than enabling outside organizations to levy heavy contributions upon them with no possible benefit in return. President Mahon and other officers of the union have been in Philadelphia, but have not announced any decision to declare a strike. A large number of strikebreakers in the employ of John Farley are still quartered at Willow Grove Park in anticipation of any trouble, but many of them have left the city.

# Traffic and Transportation

Advertise Service in Chicago.

Various electric railways in Chicago had advertisements calling attention to their service in the statistical issues of the daily newspapers published on December 31 or January 1. The Chicago City Railway published full-page advertisements headed "The city gets 55 per cent." Illustrations were given of the new pay-as-you-enter cars with the date 1908, of horse cars pulled through the snow in 1859 and of cable cars with the date 1882. The advertisement was a statement of the position of the company under its new ordinance and described the advantages of the pay-as-you-enter plan and the new system of car dispatching. The following shows the character of the advertisement: "The Chicago City Railway Company proposes to broad-base its future operations upon a degree of public confidence and co-operation impossible in the past. \* \* \* The company holds that under its partnership agreement with the city an unjust claim enforced against it is on a par with the bogus judgment against the municipality. \* \* \* The City Railway is bending every effort to render travel on its lines safe as well as comfortable. The life or limb of a patron is neither an achievement nor an asset. On the contrary, it is a moral horror and a financial loss."

The advertisement of the South Side Elevated Railroad contained a view of Kenwood junction. The Metropolitan West Side Elevated Railway advertised its accessibility to factory sites. The Northwestern Elevated Railroad advertised "Nearly 600 trains each way every 24 hours. The excellent transportation facilities offered by this line should appeal to every prospective purchaser of a home."

## Petition of Electric Railway for Joint Rates with Steam Roads Denied.

The interstate commerce commission has rendered a decision, through Commissioner James S. Harlan, denying the petition of the Chicago & Milwaukee Electric Railroad to have the Illinois Central Railroad and its controlled line, the Yazoo & Mississippi Valley Railroad, establish through routes and joint rates for the transportation of cabbages from points on the electric road to stations on the steam road. The report of the commission decides:

"Notwithstanding the fact that the issue, as made on the pleadings, covers all points on the lines of both companies and calls for joint through rates on general traffic, the testimony on the hearing was directly solely to the need of the complainant for an outlet to southern markets for the cabbage product of that part of southern Wisconsin through which its line passes and which seems to be devoted largely, if not exclusively, to the production of cabbages.

"The application is contested by the principal defendants, as well as by the Chicago & Northwestern Railway, which, on the stipulation of the parties, intervened after the hearing and became a party defendant, on the ground that the cabbage district in question is already served by reasonable and satisfactory through routes.

"Although it does some local freight business between Evanston and Lake Bluff, the principal traffic enjoyed by the complainant between those points is such as pertains to any interurban street car company. But from Lake Bluff the petitioner has constructed a branch line to Rockefeller, which affords it a larger opportunity for conducting a general freight traffic.

"The fact that the complainant has no refrigerator cars of its own in which to move cabbages, if the through routes desired are established by the commission, is not only admitted by the petitioner, but it also confesses that the commission would be unwarranted in compelling the establishment of joint rates and through routes unless the Illinois Central Railroad will voluntarily supply the necessary cars after the routes and rates have been established, or unless the complainant, as a matter of law, can compel it to do so. The record indicates the unwillingness of that defendant to supply the required empty cars to the complainant. And the complainant meets that situation by maintaining that after the through routes and joint rates have been established it will have further redress against that defendant on the ground that if the Illinois Central Railroad, notwithstanding the custom which requires the carrier having the long haul to supply the cars, should refuse the complainant this privilege while supplying cars under similar conditions to other small carriers, its refusal would be an unjust and illegal discrimination that could and ought to be corrected by this commission.

"The defendants insist that reasonable and satisfactory through routes now exist over which the cabbage product of

the district described in the petition may readily and promptly find an outlet to the desired markets in the south. The complainant on the other hand denies that a reasonable and satisfactory through route exists; and in this connection its counsel puts an interpretation upon the provision of law under which the commission is authorized to act in such cases that has not heretofore been suggested. And counsel for the complainant insists that the contention of the defendants that 'the territory through which the petitioner is operating is also served by the Chicago & Northwestern Railway and that reasonable and satisfactory rates (routes) now exist' is based upon 'a perverted reading of the proviso' of that clause. Counsel's own reading of it apparently is that there are no reasonable and satisfactory routes because 'there is no joint rate or through route from points on the petitioner's line to points upon the line of the Illinois Central.' In other words, his contention seems to be that it does not satisfy the requirements of the law if the neighborhood or territory, in which the shipping community is and through which both lines run, is already served by a reasonable and satisfactory through route; but that the law means that if there are already no reasonable and satisfactory through routes to the markets in question from points on his line in that neighborhood or territory the commission has the authority to and must establish such through routes.

"We are unable to perceive the force of this suggestion. It proceeds apparently on the theory that the sole object of the provision above quoted was to afford a means by which new lines, with the aid of the commission, may profitably force their way into shipping districts built up and already well and adequately served by older lines, and thus seize and divide with the latter such traffic as may be offered for movement. If that be the import of the clause in question, it is too well concealed to be readily discernible. With the development of the power of the commission to regulate rates and to protect the public interests by readjusting them when in excess of reasonableness and fairness, the need of competing lines becomes less vital to shipping communities whose transportation facilities are already ample. And had the congress intended thus to interfere in the competitive struggles of carriers for traffic it cannot be doubted that its policy would have been announced in more definite language. We regard it as clear that the purpose of the clause was to afford relief to shipping communities, and not to aid carriers to acquire strategic advantages in their contests with one another. While it may not be doubted that a railroad company is competent to file a complaint before us under the clause in question and to demand an order establishing through routes and joint rates with its connections, its right to such relief is to be tested by the needs of the community which it seeks thus to serve, and not by the fact that stations on its line in such communities have not been accorded such routes and rates by connecting lines.

"The only question therefore that remains to be considered is whether, in the language of the proviso, any 'reasonable or satisfactory through route exists' from the cabbage producing district described in the record to the southern markets which the complainant desires to reach. Under all the facts and circumstances disclosed upon this record, we must hold that the district in question already enjoys the advantages of reasonable and satisfactory through routes. A freight receiving station in an agricultural community that is close at hand to one farmer or producer must of necessity be farther away from his next neighbor. And unless it be that every farmer is entitled to have the rails run to his own door a farming community that is required to haul its products no farther than three-quarters of a mile to a mile and a half, as shown in this record, in order to reach the freight receiving stations of well-established lines, must be held to be reasonably well served. That the shipping district here referred to has been well served by the Chicago & Northwestern Railway is shown by the fact that it has enjoyed a prosperity and growth beyond the average of concededly prosperous farming communities.

"It is scarcely necessary to add that the apprehension of counsel that the merits of complainant's contention may be prejudiced or obscured by the fact that it is an electric line is without foundation. The act makes no distinction between railroads that are operated by electricity and those that use steam; nor has the commission thought at any time to make such distinction. Both are subject to the act when engaged in interstate transportation and are entitled to equal consideration in any controversy before us. Moreover, progress in the science of electricity and the rapid increase of new devices for its application have led many practical railroad men to think that we may be measurably near its general use as the chief motive power in transportation. The complaint must be dismissed, and it will be so ordered."

**Improvement in Service Ordered in New York.**—The public service commission, first district, has ordered the New York City Railway to increase by 50 per cent the number of cars operated in Eighth avenue after midnight, and by 20 to 25 per cent the number at other hours. The New York City Interborough Company has been ordered to re-establish service on the line in Aqueduct avenue, from One Hundred and Fifty-fifth street to Kingsbridge road.

**Change in Fares by Pittsburg Railways Company.**—We are advised by an official of the Pittsburg Railways Company that the change in fare on the night cars to Allegheny was caused by the merging of Allegheny into Pittsburg, making them one municipality. During the last year the Pennsylvania legislature enacted a law providing that the street railways in second-class cities should not charge over one fare. Heretofore the Pittsburg Railways Company had been charging double fare on night cars. This company is testing this law in the supreme court at present, but believes it is better policy to comply with the law than to have any disturbances on the cars, until the decision of the supreme court is rendered.

**Reduction in Fares by Atlanta Northern Railway.**—A voluntary reduction of 28.5 per cent in passenger fares has been announced by the Georgia Railway & Electric Company on the Atlanta Northern Railway, the subsidiary line which operates between Atlanta and Marietta. The reduction was effective as of January 1, 1908. Beginning that day family commutation tickets were placed on sale. The reduced rate, while not ordered, was submitted to the Georgia railroad commission and received its hearty approval. The officials of the company state that they put the rate into effect as an experiment and have the permission of the board to discontinue it if in their opinion it is unsatisfactory. The Atlanta Northern road was put into operation in 1905, on a basis of two cents a mile, when the Western & Atlantic Railroad was charging three cents a mile. Some time after the line was placed in regular operation a reduction in fares was made and individual tickets, good for fifty-four trips, were sold, making the fare between Marietta and Atlanta less than a cent a mile. In the meantime the regular single-trip fare remained the same. Now, however, the family commutation ticket will permit practically every patron to ride at about a cent a mile.

**Low Rate to Amusement Park Not Discriminative.**—The Indiana railroad commission has decided that the rates charged by the Indiana Union Traction Company between Indianapolis and Broad Ripple are not discriminative, as complained by citizens of the latter town. The company charges a 10-cent fare each way between Indianapolis and the town of Broad Ripple, and also sells round-trip tickets from Indianapolis to the White City amusement park, located at Broad Ripple, for 10 cents, with an extra charge of 10 cents for admission to the park. The citizens claimed that it was discrimination to require them to pay 20 cents for a trip to Indianapolis and return while people from Indianapolis could ride to the park and back for 10 cents. The commission says "there is no well-founded objection to the round-trip fare from the city to Broad Ripple park. The purpose of this rate is to induce a flow of traffic from a city of over 200,000 inhabitants to a place of amusement and recreation. Such a place well conducted is to be encouraged, as it furnishes an additional point for recreation and rest for the residents of congested districts in the city."

Justice Davis of the New York supreme court has reserved decision on the application of the New York City Railway to vacate an order for the examination of its nine directors before a referee. The order was obtained by Attorney-General Jackson of New York state and the petition recited that the appointment of receivers by the federal court was brought about by collusion between the Pennsylvania Steel Company, the Degnon Contracting Company of New Jersey and the New York City Railway Company. In his argument before the court Samuel Untermyer said: "The attorney-general seeks to dissolve the corporation, upon the grounds that the corporation has been insolvent for at least one year, and he must show this to the satisfaction of the court. His complaint has no bearing on the issue, and he seeks to examine the directors on what we claim to be matters extraneous to the main issue, which is whether or not this company has been insolvent for more than a year."

A concrete dam 50 feet high and 400 feet long, containing 24,000 cubic yards of concrete, has just been completed for the La Crosse Water Power Company at Hatfield, Wis. There is to be installed a 16,000-horsepower electric transmission plant covering a radius of 90 miles of territory.

## Construction News

### FRANCHISES.

**Bloomfield, N. J.**—The Public Service Corporation of New Jersey will soon make application for permission to double track its line from Glenwood avenue, in Orange, to Bloomfield Centre, N. J. The company also desires to extend its Orange & Passaic Valley line from the present terminus at Bay avenue to Brookdale and ultimately to Paterson, N. J.

**Defiance, O.**—K. V. Haymaker of Defiance, has secured a 25-year franchise for the operation of the proposed Detroit Defiance & Ft. Wayne and the Defiance Paulding & Ft. Wayne electric lines through the city. The last-named road owns eight miles of the old Wabash & Erie canal bank and will be built from Detroit to Ft. Wayne by way of Wau-seon, Lyons, Defiance, Paulding and New Haven, Ind. The council also has granted a franchise to the Toledo Wabash & St. Louis Electric Railroad in which C. D. Whitney and others, of Toledo, O., are interested.

**Millville, N. J.**—A franchise has been granted to a Buffalo syndicate for the construction of a 36-mile interurban railroad from Millville to Ocean City, N. J. Right of way is said to have been secured from the property owners along the proposed route and construction may be started in the spring. The names of those interested were not made public.

**Streator, Ill.**—The Illinois Traction System has officially accepted the 50-year franchise granted by the city council about a week ago for the Chicago Peoria & Ottawa Railway, which is to be part of the system's line to Chicago.

### TRACK AND ROADWAY.

**Americus Railway & Light Company, Americus, Ga.**—It is announced that construction work on this company's 4-mile street railway system in Americus will be started some time this month. A. N. Walker, of the South Carolina Public Service Corporation, will superintend the work. (Mentioned September 28, 1907.)

**Atlanta, Ga.**—Joel Hurt of Atlanta is said to be interested in a proposed interurban railway which will connect Atlanta and Decatur, a suburb of Atlanta. The line will start from a point near Hurt park and reach the city limits of Atlanta over the extension of Ponce de Leon avenue. It is stated that no definite plans have been laid, but the building of other lines by the new company radiating from Atlanta is probable. The promoters are residents along the route or are property owners in the vicinity of the proposed line.

**Aurora, Mo.**—Surveys for an interurban railway which will connect Springfield and Joplin, Mo., have been made by Henry L. Davis, city surveyor. (New road.)

**Burlington, Ind.**—It is reported that A. A. Newer of Burlington, Ind., and others are interested in a project to build an interurban line from Logansport to Frankfort, Ind., via Burlington.

**Charleston & Summerville Electric Railway, Charleston, S. C.**—This company, which has completed considerable grading on its proposed line from Charleston to Summerville, S. C., 27 miles, has been reorganized with the following officers: President, Julius G. Hocke, 15 Whitehall street, New York; secretary and treasurer, George Tupper, Summerville; general counsel, St. Julien Grimke, Charleston. (Mentioned December 14, 1907.)

**Clarkston, Wash.**—A syndicate of Chicago men is said to be planning the construction of a 40-mile electric line in Washington, connecting Anacostia, Asotin, Vineland, Clarkston and Lewiston. It is stated that the syndicate will invest about \$1,500,000 and local capital is being sought to increase the amount to \$2,000,000. Committees have been appointed to secure 25 per cent of the stock subscriptions from local capital, no payment being required until the road is built and in operation. Active construction work is promised as soon as the local stock has been subscribed and will be finished in two and one-half years. Surveys have been started from Asotin to Anacostia, 14 miles, with an elevation of 2,200 feet. Frank McKean, chief engineer. (New road.)

**Denver & Interurban Railway, Denver, Colo.**—Announcement is made of the formal opening of the Ft. Collins division of this road on December 28, when a party of officials of the company and about 200 invited guests made the initial trip over the line. It is stated that cars will now be operated regularly over the four miles of city track now completed in Ft. Collins. Current is supplied by the Northern Colorado Power Company at Lafayette, Colo. The road is owned by

the Colorado & Southern Railroad. Numerous extensions are planned for 1908, among which are the equipping for electrical operation of the Eldorado Springs (steam) Railway and 16¼ miles of extension from Denver to Louisville Junction, the grading for which has been completed. H. W. Cowan is chief engineer, Denver, Colo.

**Evansville Henderson & Uniontown Traction Company, Henderson, Ky.**—It is reported that this company, which proposes to begin construction in the spring on a line from Evansville, Ind., to Henderson, Ky., has filed amended articles of incorporation increasing the capital stock from \$10,000 to \$100,000.

**Indianapolis & Cairo Traction Company, Indianapolis, Ind.**—Charles McDermott, secretary of this company, writes that this line has been surveyed from Indianapolis to Sullivan, 80 miles. Grading has been completed from near Robison to Olney, 16 miles. When completed, the road will connect Indianapolis and Cairo, Ill., a total distance of 258 miles, and will serve the following intermediate towns: Sullivan and Robison, Ind., Olney, Fairfield, McLeansboro, Marion, Vienna, and Mound City, Ill. A. L. Hassler, president, 411 State Life building, Indianapolis; Charles McDermott, secretary. (Mentioned December 28, 1907.)

**Knoxville (Tenn.) Railway & Light Company.**—Ford, Bacon & Davis of New York, who has been engaged for the past four years in rebuilding this company's entire system, have completed the work and removed the construction forces from the city. All of the track has been laid with 90-pound rails.

**Lake Erie Bowling Green & Napoleon Railway, Bowling Green, O.**—It is stated that this company is planning to extend its line westward from Bowling Green to Tontogany, O.

**Lancaster County Railway & Light Company, Lancaster, Pa.**—This company has installed a 1,500-horsepower engine in its power station at Hebron, Pa.

**Louisville & Interurban Railroad, Louisville, Ky.**—Seven miles of new track on the extension out the Bardstown road from Louisville have been completed and placed in operation. The entire extension, which will be 14 miles long, is expected to be completed in the spring.

**Monterey, Cal.**—It is stated that financial arrangements have been concluded for the construction of an electric railway from Monterey to Carmel-by-the-Sea. Surveys are being made by H. B. Fisher, chief engineer, San Jose, Cal. Frank Powers, of the Carmel Development Company, San Francisco, is interested in the new line. (New road.)

**Olney, Ill.**—At a meeting held in Olney on December 24, a company was organized to build an electric line from Olney to Mt. Carmel and Evansville, crossing the Wabash river at Mt. Carmel.

**Omaha & Council Bluffs Street Railway, Omaha, Neb.**—The extension of the Sherman avenue line of this company from Thirty-sixth street and Ames avenue was opened on December 24 to Forty-second street and Grand avenue. The extension from Forty-fifth and Grant streets to the Deaf and Dumb Institute was placed in operation on December 25.

**Ontario West Shore Electric Railway, Goderich, Ont.**—This company which was formed to construct a railway between Goderich and Kincardine, Ont., has asked the city of Goderich to guarantee its bonds to the extent of \$150,000. The company is empowered to issue bonds to the extent of \$15,000 per mile of single track.—About 35 miles.

**Pacific Electric Railway, Los Angeles, Cal.**—It is expected that the 8-mile extension which this company is building from Los Nietos southeast to La Habra, will be completed and in operation by June 1, 1908.

**Paul Smith's Railroad.**—The first electric railroad to serve the Adirondacks region in New York state will be completed, it is stated, in about ten days, when the line recently constructed between Clear Lake Junction and Paul Smith's will be opened for traffic. The road is seven miles long, with a grade of about 1 per cent, and lies through one of the finest forests in the state of New York.

**Peru, Ind.**—Benjamin E. Wallace, James O. Cole, Jerome Herff and Harry Masters, all of Peru, Ind., who organized a company about two years ago for the construction of an electric line from Peru to South Bend, Ind., by way of Rochester, Argos and Plymouth, have interested Indianapolis capitalists in a revival of the project and it is said the company will soon be incorporated. It is stated that the new line will operate in connection with the Indianapolis and Peru branch of the old Union Traction Company of Indiana line, now leased and operated by the Indiana Union Traction Company.

**Pittsburg Harmony Butler & Newcastle Railway, Pittsburg, Pa.**—This company's bridge over Conoquenessing Creek, near Ellwood City, Pa., which was under construction was destroyed by high water last week. The loss is estimated at \$25,000. The destruction of the bridge will materially delay the completion of the line from Pittsburg to Newcastle, upon which work was well advanced. James Bryan, of Pittsburg, is chief engineer.

**Portland Eugene & Eastern Railway, Portland, Ore.**—A. Welch, chief engineer and manager of this proposed 82-mile electric line, writes that four miles of track have been laid and the overhead construction completed in Eugene, since January, 1907. The road traverses a very level country from Eugene to Salem, Ore., by way of Springfield Junction, Albany and Turner. Power for the operation of the completed portion is being purchased from the Willamette Valley Company at Eugene. A substation of 250-kilowatt capacity has been built. Surveys have been completed for the entire distance, 82 miles, and grading will be started in the near future. J. O. Storey, president; A. Welch, manager and chief engineer, Portland, Ore. (Mentioned December 14, 1907.)

**San Diego, Cal.**—Construction work has been started on the proposed electric railway from San Diego, to Delmar, Cal. It is stated that this will form part of an extension which the Pacific Electric Railway Company intends to build along the coast to San Diego. W. H. Keller and C. H. Kirchoff, of Los Angeles, obtained the franchise. (New road.)

**Seattle, Wash.**—K. Allenbaugh, Seattle, Wash., is reported as saying that a new electric railway project is being considered by Seattle capitalists. As now planned the new road is to be constructed from a point near Buckley, Wash., to the Cowlitz pass, a distance of 56 miles, describing a semi-circle around Mt. Rainier. The line will follow the course of the White river from Buckley until it reaches the highest point east of Mt. Rainier, from whence it will follow another stream to the coal fields of Cowlitz pass, serving a rich mineral and timber section.

**Spokane & Newport Electric Railway.**—Engineers are surveying in this vicinity for this proposed road between Spokane and Newport, Wash. It is stated that financial backing has been secured and that construction work will be started the coming year. Power for the operation of the line will be obtained from Albani Falls, adjoining Newport on the east. (New road.)

**Tampa & Sulphur Springs Traction Company, Tampa, Fla.**—Ties and other material have arrived and work was begun last week on the Michigan avenue extension of this company's line to West Tampa.

**Twin City Rapid Transit Company, Minneapolis, Minn.**—It is announced that an extensive programme of improvements at Lake Minnetonka is now being planned, including the electrification of the Minneapolis & St. Louis leased line from Minneapolis to Tonka Bay. In order to complete the line a short stretch of track will have to be built from Excelsior to Manitou Junction. The grading is already completed. It is stated that an amusement park and new boat and railway terminals will be built at Tonka Bay.

**Yakima Valley Transportation Company, North Yakima, Wash.**—The first car was operated over the line of this company on December 24 when A. J. Splawn, president, with a party of officials and directors, made the run from West Yakima Valley to the end of the line, about six miles west of North Yakima, and return. Regular service on a half-hour schedule was started on Christmas day. (Mentioned November 9, 1907.)

#### POWER HOUSES AND SUBSTATIONS.

**Charleston (S. C.) Railway Gas & Electric Company.**—This company has recently made a number of important improvements at its Meetings street power plant, which supplies current for all the city and commercial lights of Charleston as well as the 41-mile railway line. An addition to the boiler room 125 by 80 feet in area has recently been built, and during the past month two additional 500-horsepower Babcock & Wilcox double-deck boilers have been installed. The boiler equipment now has a capacity of 7,500 horsepower and provision has been made for an additional 2,000 horsepower. A Deane duplex boiler feed pump has also been installed and a new boiler feed tank of 50,000 gallons capacity has recently been completed. The power house is favorably situated at present for the receiving of fuel and plans are being formulated for the installation of an automatic conveyor from the storage yard to the boiler room.

**Springfield (Mass.) Street Railway.**—It is announced that this company expects to complete the installation of a 2,000-kilowatt generator and engine within the next few weeks.

## Personal Mention

Mr. A. G. Moser, general manager and purchasing agent of the Chillicothe (O.) Electric Railroad Light & Power Company, has resigned, effective on January 15.

Mr. Arthur J. Gils, heretofore auditor of the Hudson Valley Railway Company, with headquarters at Troy, N. Y., has been elected assistant secretary-treasurer of the company.

Mr. Louis H. Mountney, superintendent of the Lewistown Milton & Watsontown Passenger Railway at Milton, Pa., has been appointed superintendent of the Carbon Street Railway, Mauch Chunk, Pa.

Mr. Martin Ackerman has been appointed superintendent of the Youngstown & Ohio River Railroad Company, with headquarters at Salem, O. Mr. Ackerman formerly was train-master of the Lake Shore Electric Railway.

Mr. James J. Doyle has resigned as general superintendent of the Eastern Ohio Traction Company at Gates Mills, O., and will be succeeded by Mr. Joseph Emery, with the title of superintendent of the Cleveland & Eastern division.

Mr. F. J. Marsh has been appointed superintendent of the Cleveland & Garrettsville division of the Eastern Ohio Traction Company, with headquarters at Chagrin Falls, O., succeeding Mr. C. A. Denman, resigned. Mr. Marsh heretofore has been dispatcher at Gates Mills.

Mr. S. B. Lucas has been appointed master mechanic of the South Chicago City Railway and the Hammond Whiting & East Chicago Electric Railway, with headquarters at South Chicago, Ill. Mr. Lucas formerly was division master mechanic of the Indiana Union Traction Company at Muncie, Ind.

Mr. Levi Paxson, heretofore chief engineer of the Evansville Princeton & Vincennes Interurban Railway, with headquarters at Ft. Branch, Ind., has been appointed electrical engineer of the Evansville & Southern Indiana Traction Company at Evansville, Ind., with entire charge of power stations, substations and overhead construction of the city and interurban lines.

The express auditing department of the Illinois Traction System was removed from Springfield to Champaign, Ill., on January 1 and the work of that department has been consolidated with that of the general auditor's office. George Ostemeier, who has been in charge of the express auditing, has been appointed chief clerk to Traffic Manager B. R. Stephens at Springfield.

Mr. Edwin M. Walker, formerly purchasing agent of the Columbus Railway Light & Power Company, Columbus, Miss., has been appointed general manager of the Citizens' Railway & Light Company, at Muscatine, Ia., succeeding Mr. H. J. Clarke, resigned. Mr. A. L. Gillette, of the St. Paul (Minn.) Gas & Electric Company, has been appointed general superintendent of the company.

Mr. H. S. Potter, for the past three years superintendent of the El Paso Electric Railway at El Paso, Tex., has been appointed general superintendent in charge of both the railway and lighting departments. Mr. George F. Morse of Jacksonville, Fla., has been appointed to fill the new office of superintendent of transportation and will assume charge of the detail work hitherto looked after by Mr. Potter.

Mr. F. C. Crane, passenger and freight agent of the Rochester & Eastern Rapid Railway, Rochester, N. Y., has been appointed general passenger agent of the Eastern Pennsylvania Railway of Pottsville, Pa., under the operating management of J. G. White & Co. Mr. Crane's duties will be particularly the improvement of summer resorts on the Eastern Pennsylvania Railway system in Schuylkill county, and the building up of the excursion business.

Mr. William E. Rolston, who recently was appointed master mechanic of the Cleveland Southwestern & Columbus Railway, with headquarters at Elyria, O., was born on March 23, 1870, at Toronto, Can., where he received a common school education. In 1884 he removed to Streator, Ill., where he attended the high schools, finishing his technical education at the Armour Institute of Technology, Chicago. In 1898 he was appointed engineer in charge of the power station of the Chicago General Railway, where he remained until 1900, when he resigned to become chief engineer of the Dayton & Troy Electric Railway, Dayton, O. He remained with this company until 1906, serving successively as chief engineer, general superintendent and master mechanic until his appointment a

few months later as superintendent of motive power for the Canton division of the Northern Ohio Traction & Light Company. In November, 1906, he resigned to become division superintendent of the Buffalo & Lake Erie Traction Company, with headquarters at Fredonia, N. Y., where he has remained until his present appointment with the Cleveland Southwestern & Columbus Railway.

Mr. H. C. Donecker has recently been appointed to the position of office manager of the American Street and Interurban Railway Association. Mr. Donecker has had a number of years of practical experience in various lines of street railway work. He was first associated with the Lorain Steel Company (then The Johnson Company) of Philadelphia and Johnstown, Pa., during the years 1890 to 1894. He then became connected with Hon. Tom L. Johnson, now mayor of Cleveland, and his brother, Mr. Albert L. Johnson, in the construction and operation of the Nassau Electric Railroad of Brooklyn, N. Y. Leaving there early in 1899, he went west with Mr. J. J. Coleman, who at that time assumed the general management of the newly formed St. Louis Transit Company. Mr. Donecker remained with that company until late in 1900, when he became connected with Col. Giles S. Allison, of the Security Register Company of St. Louis, and remained engaged in that work until the first of the year 1906, at which time he entered the service of Ford, Bacon & Davis of New York City, where his work has been almost entirely of a statistical nature. Mr. Donecker's experience and his training as a statistician will undoubtedly be of great value to the association.

Col. Edwin Warren Hine, whose portrait is presented herewith, on January 1 assumed the duties of secretary of the Public Service Corporation of New Jersey, Newark, N. J., succeeding Mr. Frederick Evans, resigned. He retains his present office as assistant to the president, with the especial function of treating with the public and meeting municipal bodies. Colonel Hine was born in Litchfield, Conn., on March 17, 1854, and received his early education at Mahoney Academy in Ohio. His education was completed at the high school of Washington, D. C. After leaving school he was engaged for a short time in the stationery business, but in 1874 he located at Orange, N. J., and established a prosperous flour and feed business. In 1888 he became interested in the Harvey Steel Company and in the following year was made a director of the company. From 1878 to 1890 Colonel Hine actively engaged in the politics of his locality, serving for eight years on the Essex county board of chosen freeholders and for three years as a director. From 1887 to 1890 he was sheriff of his county. During the Spanish-American war he saw seven months of service with the Seventh army corps stationed at Jacksonville, Fla., under the command of Maj.-Gen. Fitzhugh Lee. His connection with street railway interests dates from 1887, when he was one of the incorporators and directors of the Orange Crosstown Railroad Company, now the Orange & Passaic Valley Railway and a part of the Public Service Corporation of New Jersey. In 1897 he and his associates, Messrs. Chandler and Riker, organized the Westfield & Elizabeth Street Railroad Company, incorporated to build an electric line between Elizabeth and Plainfield, N. J., and opened for traffic in 1899. This property, with the Plainfield Street Railway, the Elizabeth Street Railway and the Rahway Electric Street companies afterward was merged under the name of the Elizabeth Plainfield & Central Jersey Railway Company, of which Colonel Hine was treasurer and managing director until its absorption by the Public Service Corporation. In January, 1904, he was appointed assistant to the president of this company with supervision of the street railway department, since which time his energies have been successfully devoted to the harmonizing of the various departments of the company; and it is to his personal popularity that the change in public sentiment from its former antagonistic spirit to the present favorable attitude is attributed.



Col. Edwin Warren Hine.

# Financial News

**Blue Ridge Light & Power Company, Staunton, Va.**—This company has given a trust deed to J. M. Perry as trustee to secure an issue of \$100,000 of 10-year 6 per cent bonds.

**Boston Suburban Electric Companies.**—Announcement is made that the trustees have voted to defer the declaration of the dividend usually paid in January on the preferred stock.

**Buffalo & Lake Erie Traction Company, Buffalo, N. Y.**—This company has issued \$250,000 additional first refunding mortgage bonds making a total outstanding of \$4,755,000.

**Charleston & Summerville Electric Railway, Charleston, S. C.**—A syndicate has acquired the holdings of A. J. Warner and Ogden Edwards, the president, and the following new officers have been elected: President, Julius G. Hocke; secretary and treasurer, George Tupper; general counsel, Julien Grimke. The foregoing and F. S. Wright and W. O. Sprigg have been elected directors.

**Massachusetts Electric Companies, Boston.**—Gordon Abbott, the president, in response to questions submitted by shareholders at the annual meeting in Boston on December 18, said that the trustees will not declare a scrip dividend representing back dividends until the corporation is in a position to resume the payment of dividends at the regular rate of 4 per cent annually. He added: "The Massachusetts Electric Companies in the last fiscal year received about \$880,000 in dividends from its subsidiary companies. If the subsidiary companies had been able to sell an issue of \$750,000 bonds authorized by the railroad commission the trustees would have been in a position to have declared a dividend on Massachusetts Electric preferred shares this fall. As a sale of these bonds was impossible under the financial conditions then prevailing, the trustees thought it wise to loan the money received in dividends from subsidiary companies back to them. This money will of course come back to the holding company when the subsidiary companies are able to dispose of their bonds. The trustees had to decide whether to pay the dividends on Massachusetts Electric preferred stock or stop work on the additions and improvements on the subsidiary companies, and we choose to continue the improvement of our property and defer the resumption of dividends."

**Oregon Electric Railway.**—The following new officers have been elected: President, George B. Moffatt of Moffatt & White, New York; vice-president and general manager, Guy W. Talbot; secretary, George F. Nevins, who will also be traffic manager and auditor; assistant secretary, A. E. Godard; treasurer, H. W. Brower; assistant treasurer, Fred B. Reed; superintendent, C. A. Coolidge; general counsel, R. B. Moffatt, New York; counsel, Carey & Kerr, Portland; chief dispatcher, C. J. Philipp; chief surgeon, Dr. Ernest Tucker; electrical engineer, H. Milliken; roadmaster, F. W. Prahl; master mechanic, W. O. Fragmaier. The following directors have been elected: Charles M. Pratt, A. C. Bedford, George Barclay Moffatt, William A. White and Sidney Z. Mitchell, all of New York, and Guy W. Talbot and B. Cockingham of Portland.

**Third Avenue Railroad, New York.**—Kuhn, Loeb & Co. of New York have offered to purchase at face value, from January 2 to February 29, 1908, at the Central Trust Company, New York, the semi-annual interest coupons due on January 1, 1908, from such of the first consolidated mortgage 4 per cent bonds as may be deposited with the Central Trust Company under the bondholders' agreement. In a letter dated December 27, 1907, and addressed to J. N. Wallace, chairman of the bondholders' committee, Kuhn, Loeb & Co. say: "It is apparent that the Third Avenue Railroad Company is likely to default in the payment of the interest due January 1 next upon its first consolidated mortgage 4 per cent gold bonds, and that the bondholders' committee, of which you are chairman, will not, by that date, have completed its examination of the affairs of the company, the results of which examination must be known before the bondholders can form an intelligent judgment as to the value of their security and before your committee can consider any plan for the rehabilitation of the bonds. We have accordingly determined, inasmuch as most of the bonds of the above issue were placed by us—at a time when the bonds were universally considered to be investments of the highest rank—to offer to purchase at its face value the January 1, 1908, semi-annual interest coupon from all bonds deposited with your committee before the first day of March next. We are making this offer in order that bondholders may not suffer for lack of opportunity for full investigation and in order that through our purchase of the January coupon bondholders may receive their income until the condition of

the property is ascertained by the examination now being made on behalf of your committee." There are outstanding \$37,560,000 of these bonds, which are part of an authorized issue of \$50,000,000, the remaining \$12,440,000 being reserved to take up various prior liens. In December, 1900, Kuhn, Loeb & Co. placed most of the bonds, which were sold at 104½ and accrued interest. They have sold recently at 49½. At the time the bonds were brought out there was an equity behind them of \$100,000,000, on the basis of market prices then ruling. In a letter addressed to the bankers at the time, H. H. Vreeland, president of the Third Avenue Railroad and the Metropolitan Street Railway, said in part: "It is estimated that after the completion of the electric equipment now in progress, and with the advantages and economies resulting from the close connection with the Metropolitan Street Railway, the annual net earnings of the Third Avenue company will be at least \$3,000,000, which, together with the surplus earnings of the Metropolitan company (after deducting its own fixed charges), on the basis of the results of the last fiscal year, would provide net earnings of nearly \$6,500,000 to meet fixed charges amounting to about \$2,000,000 in all, inclusive of the issue of the new 4 per cent bonds. The Metropolitan Street Railway guarantees unconditionally by indorsement the principal and interest of the Third Avenue Railroad 4 per cent bonds."

**Worcester (Mass.) Consolidated Street Railway.**—The Massachusetts railroad commission has been asked to rescind the orders issued October 25, 1901, and August 5, 1902, approving the sale of \$145,000 and \$350,000 stock, respectively, at \$116 per share, and to substitute a new order for the issue of a like amount at such reduced market price as the directors may determine.

## ELECTRIC RAILWAY EARNINGS.

Kansas City Railway & Light Company.		
	1907.	1906.
November—		
Gross earnings	\$518,423.98	\$466,219.71
Operating expenses	276,029.80	230,387.96
Net earnings	242,394.18	235,831.75
Interest and taxes	151,098.72	145,529.41
Net income	91,295.46	90,302.34
June 1 to November 30—	1907.	1906.
Gross earnings	\$3,166,071.51	\$2,872,989.32
Operating expenses	1,620,217.65	1,414,619.95
Net earnings	1,545,853.86	1,458,369.37
Interest and taxes	924,564.83	869,723.33
Net income	621,289.03	588,645.54
Twin City Rapid Transit Company.		
	1907.	1906.
November—		
Total earnings	\$497,428.50	\$458,637.13
Total operating expense	264,410.14	224,969.27
Net earnings	233,018.36	233,667.86
Total deductions	131,141.65	117,258.32
Net income	101,876.71	116,409.54
January 1 to November 30—	1907.	1906.
Total earnings	\$5,552,879.02	\$5,149,895.88
Total operating expense	2,700,433.90	2,402,454.66
Net earnings	2,852,445.12	2,747,441.22
Total deductions	1,300,525.01	1,236,169.45
Net income	1,551,920.11	1,511,271.77

## Dividends Declared.

Aurora Elgin & Chicago, common, quarterly, three-fourths of 1 per cent; preferred quarterly, 1¼ per cent.  
 Bangor (Me.) Railway & Electric Company, quarterly, 1¼ per cent.  
 Boston & Worcester Electric Companies, preferred, \$2.00.  
 Capital Traction Company, Washington, D. C., quarterly, 1½ per cent.  
 Citizens' Electric Street Railway, Newburyport, Mass., 2½ per cent.  
 City Railway, Dayton, O., common, quarterly, 1¾ per cent; preferred, quarterly, 1½ per cent.  
 Columbus Newark & Zanesville Electric Railway, Newark, O., preferred, quarterly, 1½ per cent.  
 Consolidated Traction Company, Newark, N. J., 2 per cent.  
 Forest City Railway, Cleveland, O., quarterly, 1½ per cent.  
 Holyoke (Mass.) Street Railway, 4 per cent.  
 Rochester (N. Y.) Railway, preferred, quarterly, 1¼ per cent.  
 Syracuse (N. Y.) Rapid Transit Company, preferred, quarterly, 1½ per cent.  
 United Railways, St. Louis, preferred, quarterly, 1¼ per cent.  
 Utica & Mohawk Valley Railway, Utica, N. Y., preferred, quarterly, 1¼ per cent.  
 Washington Alexandria & Mt. Vernon Railway, Washington, D. C., 1 per cent.



# Manufactures and Supplies

## ROLLING STOCK.

**Indiana Union Traction Company**, Anderson, Ind., is said to be considering the purchase of six new cars.

**Little Rock & Pine Bluff Traction Company**, Little Rock, Ark., has placed an order with the Jewett Car Company for six or eight interurban cars.

## SHOPS AND BUILDINGS.

**Belton & Temple Traction Company**, Temple, Tex.—This company is doubling the capacity of its car house at Midway Park and is also building a shop and repair building.

**Joplin & Pittsburg Railway**, Joplin, Mo.—This company will erect a brick car house, 63 by 293 feet, according to plans prepared by A. C. Michaelis, Miners' Bank building, Joplin. Fred Deiter has been awarded the contract.

**Louisville & Northern Railway & Lighting Company**, New Albany, Ind.—The Vincennes street station is being torn down and a new one will be built by the company on Market street.

**Mobile (Ala.) Light & Railroad Company** will build a fire-proof car house with a capacity for 75 cars.

## TRADE NOTES.

**Pressed Steel Car Company** during 1907 received orders for 82 cars for elevated and subway service, 10 of which were for export.

**J. G. White & Co., Incorporated**, New York, has declared the regular quarterly dividend of 1½ per cent on the preferred stock, payable January 2.

**Carnegie Steel Company's** district office in the Candier building, Atlanta, Ga., on January 1, was removed to the Woodward building, Birmingham, Ala. F. A. Dilworth is manager of sales.

**Bayly Manufacturing Company**, Milwaukee, Wis., has received the order for the heating, ventilating and drying apparatus to be installed in the Grand Trunk's new shops at Battle Creek, Mich.

**A. M. Hewlett**, president of the Western Tube Company, Kewanee, Ill., suffered a stroke of paralysis on December 18 and died at his home in Kewanee on December 20. Mr. Hewlett was about 55 years old and had been connected with the company for 20 years.

**Electric Storage Battery Company**, Philadelphia, Pa., has declared a dividend of 1¼ per cent on both the preferred and common stocks of the company payable on January 2 to stockholders of record December 28.

**American Locomotive Company**, New York, has declared the regular quarterly dividend of 1¼ per cent on the preferred stock, payable on January 21, and 1¼ per cent on the common stock, payable on February 26.

**New England Trolley Wheel Company**, Chicopee, Mass., has been incorporated with a capital stock of \$50,000. Louis J. Tetlow is president and Michael I. Shea treasurer and clerk, both of Chicopee Falls.

**Peter Smith Heater Company**, Detroit, Mich., announces that the Electric Service Supplies Company will not represent it after January 1, 1908. The sales department of the Smith company will be looked after in the future from the Detroit office.

**General Fireproofing Company**, Youngstown, O., reports the following as among the recent sales of Trussit: One for roofing the car houses of the Waterloo Cedar Falls & Northern Railway at Cedar Falls, Ia., and one for the entire plant of the Rio de Janeiro Tramway Light & Power Company of Rio de Janeiro, Brazil. The latter shipment will be erected by the Ritter-Conley Manufacturing Company of Pittsburg.

**Transportation Equipment Company**, 1133 Broadway, New York City, has recently been incorporated with a capital stock of \$25,000 for the purpose of manufacturing the Tec registering fare box which is especially adapted for use on the pay-as-you-enter type of car. The president of the company is H. W. Brown, controller of the New York City Railway; secretary and treasurer, Robert C. Adams. The shops of the company are on West Twenty-seventh street, New York City.

**J. W. Ager**, up to now electrical aide in the bureau of yards and docks, United States navy department, has resigned his government position to enter the employ of Muralt & Co.,

engineers, 114 Liberty street, New York, as manager of their southern office in the Title Guarantee building, Birmingham, Ala. Mr. Ager is a graduate of Columbia, where he took the degree of M. E. in 1903, and of the Massachusetts Institute of Technology, where he obtained the E. E. degree in 1904. He then was engineer with the Western Electric Company, New York, during 1905 and 1906, and has been in the service of the United States navy department from 1906 until now. He was last identified with the engineering and construction work being carried out in connection with the movement to consolidate the power plants in the various United States navy yards. Muralt & Co. have obtained several municipal and government contracts in the southern territory and Mr. Ager will undoubtedly prove a very valuable acquisition for them.

**Power Specialty Company**, 111 Broadway, New York, manufacturer of the Foster patented steam superheater, states that notwithstanding the business depression which has been experienced during the past few months, it has entered a large number of important contracts since the first of September, and that its business for 1907 shows a very gratifying increase in volume over any previous year. Present indications in the way of renewed inquiries and resumption of negotiations temporarily suspended, point to the closing of a large amount of business within the next few months. Among many contracts which have been secured since the date mentioned the following are given: Alabama White Marble Company, 600 horsepower in Wickes boilers; Babcock & Wilcox Company, for Pensacola navy yard, 1,600 horsepower in Babcock & Wilcox boilers; United Shoe Machinery Company, 1,032 horsepower in Babcock & Wilcox boilers; Clark Thread Company, Newark, N. J., 2,500 horsepower in Stirling boilers; American Railway Company, 838 horsepower in Stirling boilers; Louisville & Eastern Railroad, 600 horsepower in Heine boilers; Schlitz Brewing Company, 2,000 horsepower in Edge Moor boilers; Anheuser-Busch Brewing Company, 2,000 horsepower in Heine boilers; Tonawanda Board & Paper Company, 900 horsepower in return tubular boilers.

**Westinghouse Machine Company** has made public the following plan whereby the receivership may be dissolved, and the business of the company restored to the stockholders: The company shall issue 3-year 6 per cent notes for its existing indebtedness. These notes are to be secured by the company's bonds at 85 per cent of their face value as collateral, and are to be in denominations of \$500 or multiples thereof. Claims of less than \$1,000 are to be paid in cash. On claims exceeding \$1,000 the creditor will receive 3-year 6 per cent notes to the amount of the nearest multiple of \$500 that is not in excess of the claim, the balance being paid in cash. It is further agreed that the company shall not pay a dividend to its stockholders until provision has been made for the payment of all the notes outstanding. A copy of the plan and agreement is being sent to each creditor, with a letter from the creditors' committee and from the receivers urging its acceptance, and also a letter from George Westinghouse, president, signifying the Westinghouse Machine Company's concurrence and approval. There seems to be no doubt that the plan will be successful. Following are the members of the creditors' committee: Wilson A. Shaw, president Bank of Pittsburg; Robert Wardrop, president People's National Bank; H. C. Bughman, president Second National Bank; James C. Chaplin, vice-president Colonial Trust Company; B. B. Mellon, vice-president Mellon National Bank, all of Pittsburg; Horace E. Smith, Philadelphia; Frederick S. Moseley, Boston; Frederick D. Underwood and John F. Wallace, both of New York.

## ADVERTISING LITERATURE.

**Dayton Manufacturing Company**, Dayton, O.—Catalogue No. 143 illustrates and describes Eckert water and dry cast closets.

**Fairbanks, Morse & Co., Chicago, Ill.**—An attractive little booklet in colors descriptive of Sheffield motor cars and gasoline locomotives has just been issued.

**Gohene Manufacturing Company**, Canton, O.—Zevy's engineers' contract book, a very useful and complete publication, is distributed with this company's compliments.

**McConway & Torley Company**, Pittsburg, Pa.—A newly issued catalogue sets forth the advantages of the Janney M. C. B. coupler with radial movement for interurban and other electric cars.

**American Carbon & Battery Company**, East St. Louis, Ill.—A handsome wall calendar with embossed art subject calls attention to this company's line of carbon products and porcelain insulators.

**A. Buch's Sons & Co., Elizabethtown, Pa.**—Catalogue G-6 is descriptive of the Eagle steel park swings, manufactured by this company. These are now in use in many of the lead-

ing parks of electric railways. Steel swings of other types are also described and illustrated in the pamphlet. Catalogue B-6 illustrates and describes the Keystone land roller, which is particularly designed for leveling parks, golf grounds, lawns, etc.

The Arnold Company, Chicago, Ill.—One of a series of illustrated postcards shows the progress made to December in the construction of the Grand Trunk's locomotive repair shop at Battle Creek, Mich., which is under supervision of this company.

The J. G. Brill Company, Philadelphia, Pa.—The last number of Brill's Magazine has for its leading article an interesting description of the pay-as-you-enter cars for the New York City Railway Company. The article is illustrated by a number of half-toues.

Niles Car & Manufacturing Company, Niles, Ohio.—A large and attractive catalogue of this company's most recent products has been issued by the sales agents, J. A. Hanna Company, 312 Electric Building, Cleveland, O. A number of fine illustrations are used effectively, and the book is enclosed in handsome embossed covers.

Technical Literature Company, 220 Broadway, New York, N. Y.—The monthly magazine of technical information heretofore known as Technical Literature has been changed to the Engineering Digest. The change was made owing to a somewhat general misunderstanding by technical readers as to the nature of the contents. The policy of the magazine will not be altered.

General Electric Company, Schenectady, N. Y.—Recent publications include Bulletin No. 4550, which describes a number of the company's well-known line of carbon break circuit-breakers. The bulletin also contains descriptions of auxiliary switches, automatic tripping devices, etc., to be used with the circuit-breakers, and gives complete data as to capacities, prices and dimensions of the devices shown. It contains 36 pages and is conveniently arranged for reference.—Bulletin No. 4531 illustrates and describes various types of Thompson horizontal edgewise instruments for switchboard service, including ammeters, voltmeters, single-phase wattmeters, poly-phase wattmeters, frequency indicators and power factor indicators.

#### BUSINESS CONDITIONS.

President W. H. Whiteside of the Allis-Chalmers Company in a recent interview thus expressed his views of the present business conditions: "It is daily becoming more apparent that the general business of the country has not been so seriously injured by the recent sudden financial depression as the public has been inclined to believe. And I am firmly of the opinion that the thing now most necessary is to loosen the chains of conservatism and give courage an opportunity to assert itself and make advances consistent with the general prosperous conditions and well-distributed resources of the country. As the production and use of basic machinery, such as prime movers for the generation of power, is a very potent and a leading factor in our commercial activities, very naturally it is one of the first lines of business to be affected when the pendulum swings from optimism to pessimism, and likewise the first to feel the effect when the change in sentiment again manifests itself. The number and character of inquiries which our offices located in the principal commercial centers of the country have recently been receiving convincingly demonstrate a return of confidence, and bear evidence that not only a diversified, but a large volume of business will be offering ere the middle of the first quarter of 1928 has been passed.

"Until within a few months manufacturers everywhere in the United States found themselves urgently in need of increased facilities for carrying on their own business, and when they are again called upon to supply the normal demands of business, and to replenish stocks in the hands of jobbers and retailers, many of which are now nearing the point of depletion, they must, of necessity, again work their plants to the full of their present capacities, and add increased machinery equipment, the plans for which in numerous instances are already well matured.

"The railroads of the country, whose policy of retrenchment has continued for approximately a year, notwithstanding the largest offerings of traffic, with resultant increased earnings, in their entire history, must shortly be compelled to again enter the market and make large expenditures for renewals, including train equipment, steel rails and general supplies. This, coupled with the approaching need for the renewal of stocks of metal employed in all branches of industry, which, through shut downs of furnaces and smelters and the continued use of iron, steel and copper for current

consumption, have now been lowered very near to the minimum, and giving due consideration to the large balance now in our favor in our commerce with foreign nations, and to the well-distributed revenues from our exceptionally large agricultural products, cannot fail to create an early demand for new machinery and auxiliary equipment.

"The outlook is therefore distinctly encouraging."

#### A MEANS FOR TRAFFIC DEVELOPMENT.

In connection with the interest aroused in the promotion of traffic by the recent discussions before the various associations of street and interurban railway men there is another subject which is closely related and which should receive careful attention. This is the subject of electric railway advertising.

Aside from the wide field of activity of the energetic traffic manager, a field with which every electric railway man is more or less familiar there is a still wider field which may aptly be termed the "field of individual traffic," which in a great majority of cases has remained untouched or at best has been little more than scratched. It includes a class of traffic that it is impossible for the traffic department to reach through personal work, but which will respond readily to properly directed advertising and which is highly desirable and profitable, since it can be handled very largely on regular cars and trains and at regular rates of fare.

The methods to be adopted to reach and interest this class of travel will, of course, vary in individual cases, it being necessary to study operating and other local conditions, as well as the character of the territory served before the extent and character of the advertising to be undertaken can be determined. The fact remains, however, that there are few roads, either interurban or city, that could not be benefited by a judicious use of printer's ink.

In the case of the interurban road a wide field for development is presented by the natural desire on the part of people living in the country to visit and take an ever-increasing part in the activities of the larger towns and cities, and the inclination of the city dweller to spend more of his time in the woods and open country away from his usual haunts. The growth of the vacation habit and the increasing favor of the electric car for long-distance travel also open up wide possibilities for many roads.

For the city system the problem and the method of treatment are necessarily somewhat different, but on every system there are some features of the service or attractions that will furnish a basis for profitable publicity, while in the larger cities, with their numerous lines and routes, there are opportunities for the development of profitable traffic in getting the regular passenger "off his beat" on trips and excursions, and by placing the conveniences of the system before strangers and transients in an attractive manner.

In this connection the announcement of E. C. Van Valkenburgh, 2117 West One Hundred and Second street, Chicago, who handles the advertising of electric railways exclusively, will be of interest.

The service offered takes the place in the organization of the electric railway of an advertising manager, but with the advantage that by maintaining a separate organization it is possible to view the road and its service more from the standpoint of the passenger, without the danger of having the point of view biased by a too intimate contact with the perplexities of operation and management which necessarily engage the attention of exclusive employes and officials of the company. Then, again, by being in touch with a number of roads and their varying problems a wider range of ideas and methods of procedure is developed.

Among the advantages this service affords may be mentioned: (1) It provides a definite plan of action which has been formulated, after a careful study of all contributing factors, with a view to the building up of weak points as well as the traffic in general. (2) It insures attractive and timely copy for printed matter, since a close relation is maintained with the traffic department and a close watch is kept for anything of a character to create or encourage travel. (3) Close attention to the matters of detail which are necessarily a part of the work, but which are always more or less of an annoyance to an official having other duties to attend to.

For the purpose of reassuring purchasers, Allis-Chalmers company has adopted the policy of testing every turbine and generator in its works to a speed 20 per cent in excess of the rated speed, thus subjecting the material to stresses 44 per cent above the normal. This overspeed test taxes the machine as it cannot be taxed in practice, for, even should the main governor fail to work, the safety governor will stop the turbine long before it reaches such a speed.

**THE NEW RECORDING MILLI-VOLTMETER AND SHUNT AMMETER.**

Electrical engineers have long felt the need for an accurate and sensitive recording milli-voltmeter which is adapted to practical every-day service as well as for laboratory tests. There has also been a demand for a recording ammeter of the shunt type which can be connected by leads to the main busbar. The shunt system is especially economical where heavy currents are to be indicated or recorded, as the instruments may be located at a considerable distance from the main current, thus saving great expense in carrying the main conductors to the point where the instrument is located. The recorders illustrated herewith have been designed to meet these practical demands.

The two most important fundamental features of these recorders are a sensitive electrical movement of special design, made by the Weston Electrical Instrument Company, and a new recording system using a patented smoked chart, so arranged that there is no friction between the recording arm and the chart.

These instruments are so sensitive that the recording arm will move over the whole scale for five milli-voits or less, making it possible to accurately record one ten-thousandth of one volt. The graduations on the chart are evenly proportioned over the entire range, the same as the Weston ammeter, so that even though there is only a small current flowing, the readings may be as readily taken as if the current was the maximum that the instrument would record. This feature will be greatly appreciated, as there are many places where it is important that the records be perfectly clear, even though the loads are very light when the outfit is first installed.

The records are made on a novel semi-transparent smoked chart, which is periodically brought into momentary contact with the end of the recording arm by means of a special vibrating device. In this way a series of white dots are made on the smoked surface. These form a continuous line and a record is thus made without causing any friction between the moving arm and the chart. The rate of vibration of the chart is timed to suit the frequency and range of the variation in the current to be recorded. The usual period of vibration of the chart is once in 10 seconds, but to obtain continuous lines where the fluctuations of the current are quite rapid, the vibrating attachment is made to operate twice every second. When the record is completed the chart is

direction of the current, as in many cases the direction of the current changes from negative to positive during the day.

It is expected that by using a number of these instruments operating simultaneously at different points, stray currents in water and gas mains or in any underground structure may be recorded, making it possible to discover the causes of trouble and how they may be eliminated.

The recording ammeter is shown in Figure 3 connected to a standard Weston 10,000-ampere shunt, to which is also connected a Weston indicating station ammeter. This illustration shows that the recorder may be readily applied to any

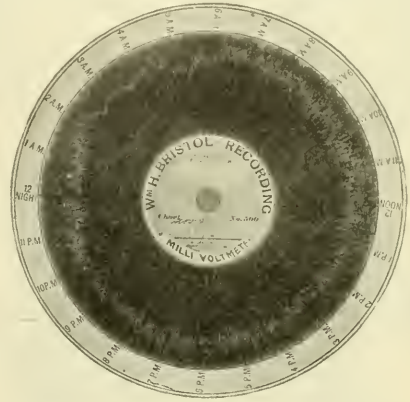

Figure 2—Facsimile of Chart from Milli-Voltmeter.

standard shunt which is already in service, without disturbing the indicating instrument at the switchboard. As illustrated here, leads of almost any desired length may be used to connect the indicating and recording instruments to the shunt on the main busbar. It is even possible to have the recording ammeter located in the superintendent's office at a great dis-

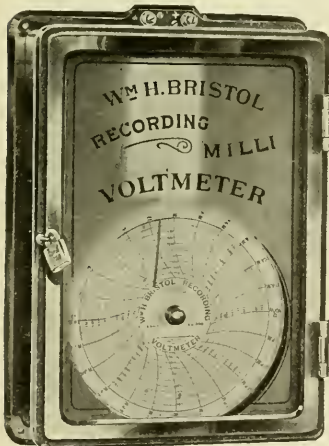

Figure 1—Recording Milli-Voltmeter.

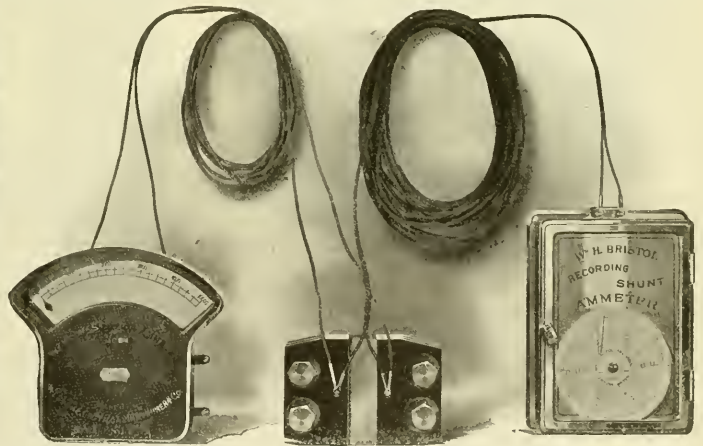

Figure 3—Recording Instruments with Connections.

dipped in a simple fixitive solution which makes the record permanent for filing.

The recording milli-voltmeter is shown in Figure 1 and Figure 2 is a reduced photographic facsimile of a chart taken from one of these instruments in connection with electrolysis surveys of underground structures which are being conducted by the Electrical Testing Laboratories of New York City. The graduations of this chart are arbitrary. It was revolved once in 24 hours and was vibrated once every 10 seconds. The zero position of the recording arm was the middle of the scale, so that the record might be independent of the

tance from the shunt and the indicating instrument located on the switchboard convenient for the observation of the operator. Such combination outfits could be furnished as units, with leads of the proper lengths to suit the individual cases.

The recording shunt ammeter has been successfully applied for taking continuous records of the current on a large trolley system, where the fluctuations are very rapid and varied as much as 4,000 amperes several times in a minute. The charts for such work as this are made to revolve once in one hour and the vibrator operates twice in one second. For

preliminary tests, the recorders are provided with special fast vibrators for the smoked chart and with a clock movement to revolve the chart once in one hour, but for continuous daily records the standard 24-hour charts are recommended. These instruments are manufactured by William H. Bristol, 45 Vesey street, New York City.

#### THE TEC REGISTERING FARE BOX.

When the pay-as-you-enter type of cars are put into operation on the Madison avenue line of the New York City Railway they will be equipped with a new type of register known as the Tec registering fare box. This device was designed for and is peculiarly adapted to the collecting and registering of fares on the pay-as-you-enter car. It presents a number of very novel and practical features. The box registers fares automatically, being electrically operated by four dry cells of a special type. The chief object attained is that the conductor does not have access to the money until after the fare has been registered, but the box is so designed that im-

inserting of a thin guard into the fare channel to keep any coins from passing the contact lever while it is withdrawn to permit the preceding coin to drop, and the shoving to one side of the last fare registered preparatory to receiving the next coin.

After the fare has been dropped into the slot at the top of the box it is registered and exposed to the view of the conductor almost instantaneously. To enable the detection of bad coins the last three or four nickels registered always remain in view of the conductor, so that it is possible for him to detect a bad coin not only immediately upon its registration, but even after two or three more passengers have dropped nickels into the box. The coins thus exposed for inspection are pushed one at a time into a conductor's money drawer, to which the conductor has access for use in making change.

Probably the most important feature of this register is that it is so constructed that the conductor cannot stop the collection of nickels, even should the mechanism of the machine be fouled in any way. The fare register is so built that if the mechanism becomes inoperative from any cause the nickels, while dropped in the same slot, are caused automatically to fall through the inclosure at the left of the usual channel and into a locked receptacle to which the conductor

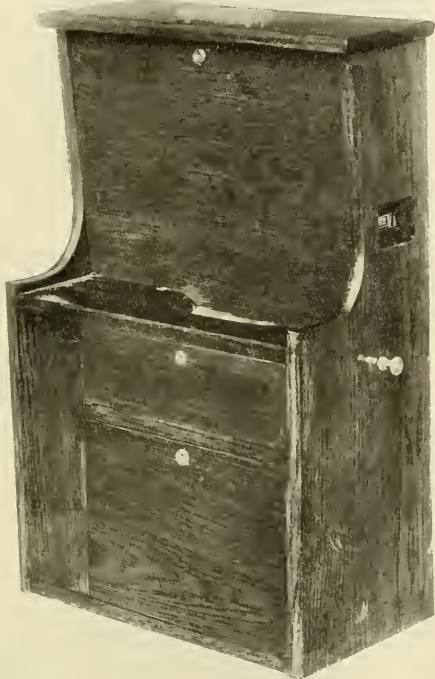

The Tec Fare Box—Exterior.

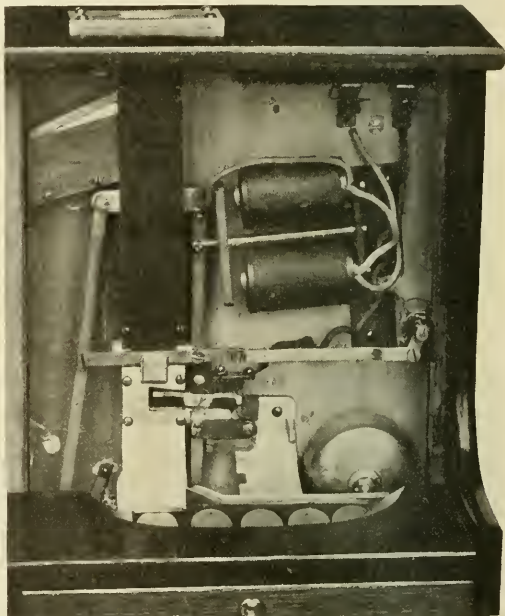

The Tec Fare Box—Interior.

mediately after its registration the money is available for use as change.

The height of the register is 18 inches. It is 6 inches wide at the bottom and 3 inches wide at the top. It will stand on a pedestal just inside the railing in front of the conductor.

From the accompanying illustrations showing the details of construction a comprehensive idea of its operation may be obtained. The fare is dropped in a slot at the top of the box and passing down the inclosure strikes a balanced lever, which, being forced downward at the end protruding into the fare channel by the weight of the coin, causes the other end to rise and make a contact, thus completing an electric circuit. At the moment the exterior end of the lever has risen to contact an L-shaped lever, by means of its pivotal connection, drops under the contact lever and holds it in that position until a complete registration has been made. The circuit is next broken by means of a lug, permitting both levers to assume their natural positions. It will be noticed that as the current is thrown into use the magnet drawing its helper into place manipulates the various attachments fastened to the helper, which include connections to the register and bell, the

has no access. This second receptacle is accessible only to the inspector. Thus the registering mechanism may become damaged and yet there be no excuse for the conductor to take nickels direct from the passengers.

To provide for another emergency it is within the power of the conductor to operate the register by hand by unlocking his change drawer, and pulling it out an inch or two so that it will release the hand pull bar shown on the right-hand side of the fare box.

In the view of the exterior of the registering fare box the three openings are shown on the front. These are accessible only by key. The upper receptacle contains the registering mechanism, the middle opening is the money drawer and the lower drawer holds the batteries. On the right is shown the face of the register and the pull bar, while on the left is a small opening for the use of the inspector.

The Tec registering fare box, which is built by the Transportation Equipment Company, 1133 Broadway, New York City, has been given severe tests equal to more than a year's service resulting in practically no appreciable wear on any of its parts and with no apparent decrease in the efficiency of the batteries.

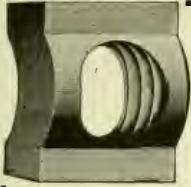

## Use GRIP NUTS on track bolts

and You Have a Better, Safer Track

GRIP NUTS never let loose under any strain, jar or vibration unless bolts break.

### GRIP NUT COMPANY

500 Fifth Avenue, NEW YORK

152 Lake Street, CHICAGO

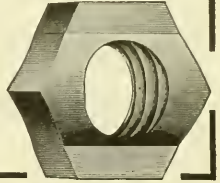

## Interchangeable?

Yes, it is the standard type selected by the A. S. & I. R. A. Standardization Committee. Its adoption on your road will bring not only *uniformity*, but *economy* as well.

The facts in the case sent on your request

### American Brake Shoe & Foundry Co.

New York Chicago Chattanooga MAHWAH, N. J.



The M. C. B. Christie Flanged Steel Back Brake Shoe for use on wheels with 3-inch tread and over.

5

Bonding and rebonding are better done by this car because its two processes

## Electric Brazing and Copper Welding

insure perfect mechanical and electrical union between bond and rail. And it is the only method that does produce this result at moderate cost.

*Write us for further facts.*

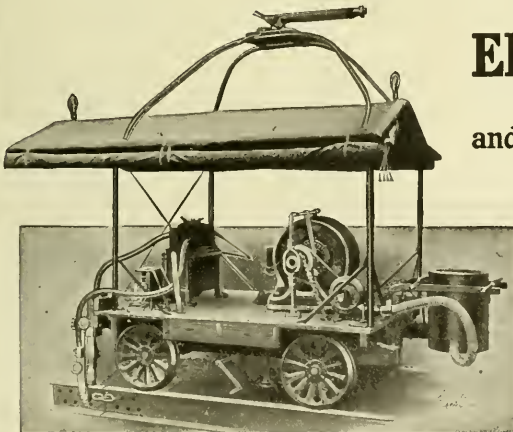

## The Electric Railway Improvement Co.

6005 Carnegie Avenue, Cleveland, Ohio

6

---

## THE J. G. BRILL COMPANY, PHILADELPHIA, PA.

AMERICAN CAR COMPANY, ST. LOUIS, MO.  
 G. C. KUHLMAN CAR COMPANY, CLEVELAND, OHIO  
 JOHN STEPHENSON COMPANY, ELIZABETH, N. J.  
 WASON MANUFACTURING CO. SPRINGFIELD, MASS.

MAIN OFFICE: PHILADELPHIA, PA.  
 LONDON OFFICE: 110 CANNON ST. E. C.  
 PACIFIC COAST AGENTS: PIERSON  
 ROEDING & CO., SAN FRANCISCO.  
 AUSTRALIAN AGENTS: NOYES  
 BROTHERS, SYDNEY. CABLES:  
 "BRILL," PHILA., "AXLES" LONDON.

---

*CARS TRUCKS SEATS RATTAN SPRINGS SPECIALTIES SUPPLIES*

## DERAILMENTS AT CURVES

Most of the recent disasters to trains on steam roads while rounding curves at a high rate of speed have been caused, not by broken rails, but by the absence of cushioned side swing in the trucks. The average speed of electrically operated cars on interurban lines in the United States is higher than on steam roads while the average track conditions are much inferior and the curves more frequent and of shorter radii, yet the Brill No. 27-E Truck, which is used on the great majority of these electric lines, has never been derailed except in collisions. It is the only high-speed truck that has a cushioned side swing. The swing bolster used in "M. C. B." types and all other trucks, is uncushioned, and, therefore, when curves are taken at more than moderate speed, the swing stops with a jerk which drives the wheel flanges against the outer rail head with dangerous and sometimes fatal force.

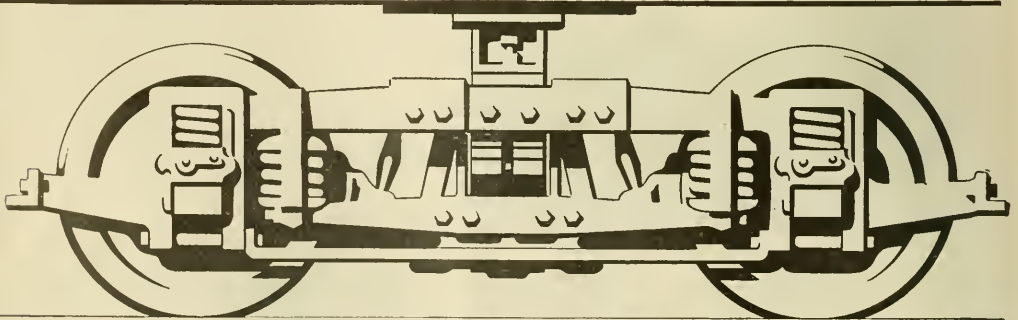

---

*THE BRILL NUMBER 27-E TRUCK (PATENTED)*

# General Electric Company



## Railway Motor Gears



### The Steel Foundry



General Electric Company's Steel Foundry, where all castings for G. E. Gears are made.

Every operation, from the pouring of the steel to the finishing cut, is subject to scrutiny and test by experienced specialists in our own Foundry and Machine Shops.

To insure homogeneous castings and freedom from shrinkage cracks, heavy "risers" are employed.

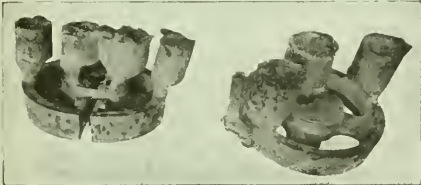

Split and solid Gear Castings removed from sand, showing large "risers."

All Gear Castings are sand-blasted, to insure detection of faults. Imperfect castings are scrapped before leaving the foundry.



Sand-Blasting Gear Castings to remove all foreign materials from surface of steel-castings.

**"Original Equipment Quality"**

means

**"Original Equipment Service"**

*The second advertisement of this series on General Electric Company Railway Motor Gears will appear in the January 11 issue of the Electric Railway Review and will treat on the Machine Shops.*

1550

Chicago Office:  
Monadnock Bldg.

Principal Office:  
**Schenectady, N. Y.**

Sales Offices in  
all large cities

**Stuart-Howland Co.**  
Everything Electrical  
BOSTON

**LUFKIN**  
**MEASURING TAPES**  
are the choice of expert electrical engineers in all quarters of the globe. Absolute accuracy and the highest possible degree of durability make them especially adapted to Electric Railway Work.  
New York: London, Eng. Windsor, Can.  
**THE LUFKIN RULE CO.**  
SAGINAW MICH., U. S. A.



**THE NATIONAL LOCK WASHER CO., NEWARK, N. J.**  
Curtains - Curtain Fixtures - Sash Locks - Sash Balances - Nut Locks  
CHICAGO OFFICE: 419 MONADNOCK BLOCK

**THE CINCINNATI FROG & SWITCH COMPANY, CINCINNATI, OHIO**  
FROGS, SWITCHES, CROSSINGS, CURVES, SWITCH STANDS  
RAIL BRACES AND SPECIAL TRACK WORK

**NILES CARS**  
(The Electric Pullmans)  
LARGE, FAST INTERURBANS  
OUR SPECIALTY  
**Niles Car & Mfg. Co.**  
Works: NILES, OHIO  
Sales Office: J. A. HANNA CO.,  
312 Electric Bldg., Cleveland, Ohio



**CAR CURTAINS**

Did you ever stop to think how much is added to the appearance of your cars by tasteful window curtains?

Let us give you an estimate upon new ones for those winter cars you are renovating.

**The Curtain Supply Company**  
Main Office and Works,  
85-93 Ohio Street, CHICAGO, ILL.  
530 Mission Street SAN FRANCISCO  
1819 Park Row Bldg. NEW YORK

**WADDELL & MAHON**  
Special Agents

PHILADELPHIA OFFICE: Room 312 Lippincott Bldg. Long Distance Telephone 2403 Walnut  
BALTIMORE OFFICE: Room 406 Baltimore American Bldg. Long Distance Telephone 5347 St. Paul  
BOSTON OFFICE: Room 411 Post-Office Square Building Long Distance Telephone, 959 Fort Hill

**ALWAYS ON DUTY**  
1133 BROADWAY  
Suite 1024 and 1026 St. James Building  
NEW YORK

Long Distance Telephone 4882 Madison Sq. Night ( 2905 Melrose  
Telephones ) 2903 Melrose

**Have You Any Labor Troubles?  
Do You Anticipate Trouble?  
We Are Licensed Special Agents**

We are not a Detective Agency, but Special Agents who act for Corporations and Manufacturers in the termination of labor difficulties. We secure and furnish non-union mechanics in all trades, and skilled labor in all branches of industry, for service during strikes, and establishing the open shop. We also furnish Special Police Patrolmen, trained to their duties for the protection of non-union workmen and security of property. We establish, operate and maintain Commissaries for the maintenance of non-union workmen, performing Special Service during strikes and lockouts.

**We Are Not a Detective Agency  
We Are Successful  
We Get Results**

**Drummond's Detective Agency**  
RAILWAY WORK A SPECIALTY  
A. L. DRUMMOND, GENERAL MANAGER, EX-CHIEF U. S. SECRET SERVICE, NEW YORK.



# Electric Railway Review

PUBLISHED EVERY SATURDAY.

FORMERLY THE STREET RAILWAY REVIEW.

THE WILSON COMPANY, CHICAGO.

160 Harrison Street, Chicago  
150 Nassau Street, New York  
1529 Williamson Bldg., Cleveland

Vol. XIX  
No. 2

CHICAGO, JANUARY 11, 1908

Whole No.  
246

Subscription: Domestic . . . \$2  
Foreign . . . \$5  
Canada . . . \$3.50

## Advertise

- to make your house and your goods well known among prospective customers
- to give your concern strong prestige and, eventually, pre-eminence in your field
- to smooth the way for your salesmen and cut down the time required to secure acquaintance
- to produce inquiries for your printed advertising matter from interested buyers
- to make those impressions upon the minds of prospective customers that turn doubt into belief and belief into orders
- to help, in a dozen different ways, sell your goods, and at far less cost than by any other method.

Advertising is doing these things every day for others—perhaps for your competitors—and advertising will do them for you, too, if rightly handled.

All you have guessed about advertising may not be right, so don't infer that advertising won't help your business, for it will, and we'll gladly show you how.

Just ask us to have an advertising representative call. No obligation—no contract to sign unless you want to—just a straight business conference.

## Electric Railway Review

160 Harrison Street, Chicago

# A Case of Strength

## and why it wins

¶ Unnecessary strength, if it means additional weight, is loss. *Lyon Sheet Steel Gear Cases* are as strong as cast cases and weigh from 75 to 100 pounds less. They are heavily reinforced by rivets and extra sheets of steel at the brackets and where all strains come.

¶ Provided it has the other requisites, common sense teaches that a gear case which will not break or crack when struck is superior to a cast case.

¶ When we say that *Lyon Sheet Steel Gear Cases* cost less than cast cases, with all other requisites of perfect gear protection, will we get your next order?

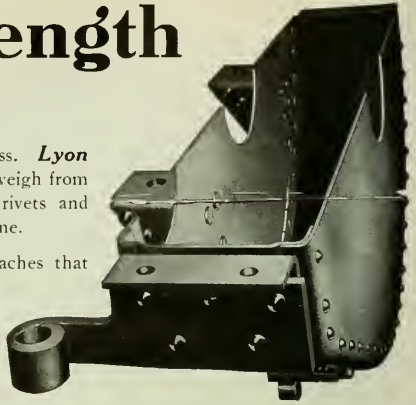

Catalogue No. 34 will give more specific data

## ELECTRIC SERVICE SUPPLIES Co.

"Supplies for Every Electric Service"

MAYER & ENGLUND DEPT.  
PHILADELPHIA

GARTON-DANIELS DEPT.  
KEOKUK

PORTER & BERG DEPT.  
CHICAGO

— BRANCHES —

NEW YORK

PITTSBURG

SAINT LOUIS

ATLANTA

# National Air Brakes

## EMERGENCY VALVES WITH QUICK-RELEASE FEATURE.

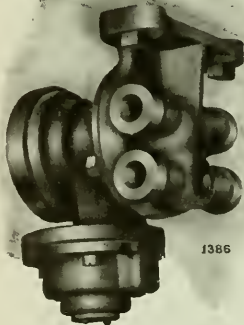

"National" Emergency Quick-Release Valve

WRITE FOR DESCRIPTIVE BULLETIN.

The new "National" Emergency Valve with quick-release feature combines with the straight air brake system the emergency quick-set and quick-release features of the automatic system. This is the most simplified type of emergency apparatus, requiring one-third less piping than any other emergency equipment.

## National Brake & Electric Co.

NEW YORK: 111 Broadway  
PHILADELPHIA: 1722 Westmoreland St.  
BOSTON: F. E. Huntress, 131 State St.

Milwaukee, U. S. A.

SAN FRANCISCO, CAL.: W. F. McKenny,  
526 Mission St.  
LONDON: 14 Great Smith St., Westminster

General Sales Office: 519 First National Bank Building, Chicago

# Westinghouse

## Interpole Railway Motors

reduce maintenance costs—have perfect commutation—practically eliminate flashing—greatly diminish brush wear—and are cleaner motors.

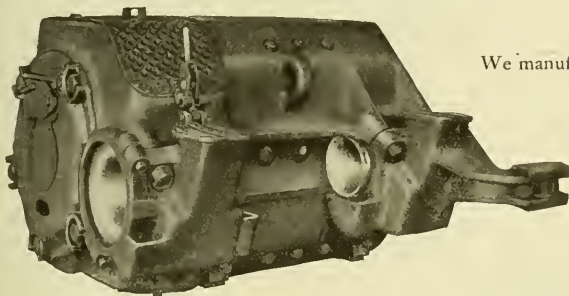

No. 300, 200 H. P.

We manufacture a complete line:

No. 300.....	200 H. P.
No. 301.....	160 "
No. 302.....	125 "
No. 303.....	100 "
No. 304.....	75 "
No. 305.....	60 "
No. 306.....	50 "
No. 307.....	40 "

## Westinghouse Electric & Mfg. Co.

Atlanta  
Baltimore  
Boston

Buffalo  
Chicago  
Cincinnati

Cleveland  
Dallas  
Denver

Detroit  
Kansas City  
Los Angeles  
Minneapolis

New Orleans  
New York  
Philadelphia

Pittsburg  
St. Louis  
Salt Lake City

San Francisco  
Seattle  
Syracuse

Canada: Canadian Westinghouse Co., Ltd., Hamilton, Ontario Mexico: G. & O. Braniff & Co., City of Mexico



### A Strictly Automatic System

The "AMM" Graduated-Release, Quick-Recharge, Quick-Service, High-Pressure Emergency Brake

Any reduction in brake-pipe pressure resulting from a break in the piping, burst hose or parting of train, causes the brakes to apply immediately with full power. The "AMM" equipment combines the flexibility of the straight-air brake with the safety of the automatic, that is the motorman has complete control of the brakes at all times, yet in the emergencies before mentioned the brakes will act automatically.

Pamphlet T-5031 fully describes the equipment.

Westinghouse Traction Brake Co., Pittsburg, Pa.

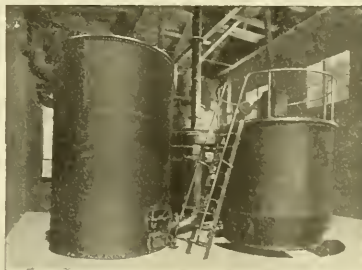

### Automatic Pressure Gas Producers

When, in addition to supplying gas engines with a clean, cool gas of uniform heat value, it is desired to use the gas for other purposes, the automatic pressure control feature of the Westinghouse producer recommends itself as a means of regulating the amount of gas made for any purpose. If the gas is intended for heating only, the producer may be installed without scrubbers, and the gas piped direct to the furnaces.

Publication 7007 gives full particulars.

### The Westinghouse Machine Co.

For particulars address nearest sales office:

New York, 10 Bridge Street  
Boston, 131 State Street  
Cleveland, New England Building  
Chicago, 111 La Salle Street  
Cincinnati, Traction Building  
Atlanta, Candler Building

St. Louis, Chemical Building  
Pittsburg, Westinghouse Bldg.  
Philadelphia, N. American Bldg.  
Denver, McPhee Building  
San Francisco, Hunt, Milk & Co.

## ALPHABETICAL INDEX TO ADVERTISEMENTS.

Acme White Lead & Color Works.....	26	Drouv, The G. Co.....	14	McGuire-Cummings Mfg. Co., Marshall, R. W., & Co.....	21	Security Register & Mfg. Co., Sheaff & Jastad.....	18
Advance Lumber Co.....	22	Drummond Detective Agency.....	14	Massachusetts Chemical Co., Newton, Fred J. Mfg. Co.....	12	Shimmons, John, Co.....	18
Albis Chalmers Co.....	24	Durkin Controller Handle Co.....	14	Middletown Car Works.....	17	Smith, Peter, Heater Co.....	25
Aluminum Co. of America.....	19	Earl, C. I.....	25	Miller Anchor Co.....	17	Speer Carbon Co.....	24
American Brake Shoe & Fdry. Co.....	27	Eclipse Railway Supply Co.....	24	Milroy Electric Co., The.....	18	Standard Brake Shoe Co.....	24
American Electrical Works.....	26	Electric Railway Equipment Co.....	24	Missouri Stoker Co., The.....	24	Standard Motor Truck Co.....	24
American Frog & Switch Co.....	26	Electric Ry. Improvement Co.....	26	Morden Frog & Crossing Wks., Co.....	21	Standard Paint Co.....	23
Anderson, Albert & J. M., Mfg. Co.....	19	Electric Service Supplies Co.....	26	National Brake & Electric Co.....	2	Standard Steel Works.....	18
Armstrong Co.....	19	Engineering Agency, The.....	24	National Carbon Co.....	18	Standard Underground Cable Co.....	12
Arnold Company.....	24	Engineers and Contractors.....	24	Nichols, Fred J. Mfg. Co.....	25	Stanton Vapour Works.....	22
Atlas Anchor Co.....	18	Fairbanks, Morse & Co.....	25	Naugle Pole & Tie Co.....	22	Star Brass Works.....	21
Babcock & Wilcox Co.....	12	Ford, Bacon & Davis.....	24	New York Switch & Crossing Co.....	21	Stone & Webster Engr. Corp.....	24
Baker, The Wm. C., Heating & Supply Co.....	21	Galena-Signal Oil Co.....	11	Niles Car & Mfg. Co.....	21	Stuart-Howland Co.....	11
Baldwin Locomotive Works.....	18	General Electric Co.....	29	Northern Engineering Works.....	26	Symington, T. H., Co.....	11
Barbour-Stockwell Co.....	15	General Storage Battery Co.....	25	Nuttall, R. D., Co.....	21	Telegraph Signal Co.....	19
Barnes, G. H., Hardwood Lumber Co.....	22	Gillette Chemical Co.....	25	Ohio Brass Co.....	18	Trolley Supply Co.....	17
Beaver Dam Malleable Iron Co.....	26	Goheen Mfg. Co.....	25	Okonite Co., Ltd.....	22	Under-Feed Stoker Co., The.....	18
Beidler, Francis, & Co.....	22	Goldschmidt Thermo Co.....	25	Pacific Coast Pole Co.....	22	United States Graphite Co., The.....	18
Bellamy Vestette Mfg. Co.....	22	Greene Engineering Co.....	25	Panfusco Co.....	22	Van Dorn & Dutton Co.....	11
Berthold & Jennings.....	22	Green Fuel Economizer Co.....	22	Patrol, F. A. B.....	22	Van Dorn, W. T. Co.....	30
Blake Signal & Mfg. Co.....	15	Griffin Wheel Co.....	25	Pay-As-You-Enter Car Co.....	9	Van Valkenburgh, E. C.....	25
Bliss, R. Mfg. Co.....	26	Grip Nut Co.....	27	Power Specialty Co.....	9	Waddell & Mahon.....	30
Bridgport Brass Co.....	20	Hagy, J. Milton, Waste Wks., Hale & Kilburn Mfg. Co.....	27	Pressed Steel Car Co.....	13	Wagner, J. J.....	30
Brill, The J. G., Co.....	28	Harrison, F. P., Elec. Mfg. Co.....	23	Queen & Co.....	23	Wallace Supply Co.....	14
Brown, Harold P.....	28	Hartshorn, Stuart, Co.....	23	Rail Joint Co.....	25	Wanted and For Sale Cards.....	21
Brown Hoisting Machy. Co.....	14	Healy Safety Boiler Co.....	22	Railway Special & Supply Co.....	25	Washburn Steel Castings & Co.....	20
Buckeye Engine Co.....	14	Henderson-Ames Co.....	25	Railway Steel-Spring Co.....	24	Watson-Stillman Co.....	17
Burnham, Williams & Co.....	18	Heywood Bros. & Wakefield Co.....	19	Recording Fare Register Co.....	25	Wendell & MacDuffie.....	17
Byllesby, H. M., & Co.....	24	Holman, D. F., Ry. Tracklayer Co.....	25	Reed, Francis, Co.....	25	Western Electric Co., Mfg. Co.....	15
Central Inspection Bureau.....	24	Hoover-Owens-Rentschler Co.....	25	Register, A. B., Co.....	24	Westinghouse Elec. & Mfg. Co.....	3
Chase-Shawmut Co.....	5	Hope Washing Co.....	25	Reiter, G. C.....	24	Westinghouse Machine Co.....	3
Churchill Cedar Co.....	22	Hunbird Lumber Co., Ltd.....	25	Ridlon, Frank, Co.....	24	Westinghouse Traction Brake Co.....	3
Cincinnati Car Co.....	22	Indestructible Fibre Co.....	17	Roberts & Abbott Co.....	3	Wharton, Wm. J., & Co.....	15
Cincinnati Frog & Switch Co.....	26	Jewett Car Co.....	13	Robertson, Wm. & Co.....	19	Wheeler Condenser & Eng'g Co.....	22
Cleveland Armature Works.....	27	Johann, F. A.....	21	Rouger Ballast Car Co.....	13	Wheel Truing Brake Shoe Co.....	24
Cleveland Frog & Cross. Co.....	27	Johns-Manville, H. W., Co.....	5	Rooke Automatic Register Co.....	30	White, J. G., & Co.....	24
Collier, Barron G., Plat Iron Co.....	24	Kalamazoo Ry. Supply Co.....	5	Rossiter, MacGovern & Co. (Inc.).....	21	Whitmore Mfg. Co., The.....	19
Columbia Construction Co.....	24	Kentucky Water Softener Co.....	5	Russell Car & Snow-Plow Co.....	23	Wilson, G. Mfg. Co.....	12
Consolidated Car Fender Co.....	19	Kinmar Manufacturing Co.....	5	S-E. Missouri Cypress Co.....	22	Wood, Guilford Co.....	12
Consolidated Car-Heating Co.....	25	Lindsay Bros. Co., The.....	22	St. Louis Car Wheel Co.....	21	Woodman, R. Mfg. & Supply Co.....	24
Contractors' Supply & Equipment Co.....	24	Lorain Steel Co.....	18	St. Louis Car Wheel Co.....	21	Worcester, C. H., Co.....	22
Cooper Heater Co.....	19	Lorain Rule Co.....	30	St. Louis Surfacers & Paint Co.....	23	Zelnicke, Walter A., Supply Co.....	21
Crane Co.....	24	Lumen Bearing Co.....	22	Sanderson & Porter.....	23		
Creaghead Engineering Co.....	24	Macallen Co.....	17	Robertson, Wm. & Co.....	19		
Curtain Supply Co.....	24			Rouger Ballast Car Co.....	13		
Davis, The John, Co.....	24			Rooke Automatic Register Co.....	30		
Detroit Graphite Co.....	26			Rossiter, MacGovern & Co. (Inc.).....	21		
Dearborn Drug & Chemical Works.....	23			Russell Car & Snow-Plow Co.....	23		
				S-E. Missouri Cypress Co.....	22		
				St. Louis Car Wheel Co.....	21		
				St. Louis Car Wheel Co.....	21		
				St. Louis Surfacers & Paint Co.....	23		
				Sanderson & Porter.....	23		
				Robertson, Wm. & Co.....	19		
				Rouger Ballast Car Co.....	13		
				Rooke Automatic Register Co.....	30		
				Rossiter, MacGovern & Co. (Inc.).....	21		
				Russell Car & Snow-Plow Co.....	23		
				S-E. Missouri Cypress Co.....	22		
				St. Louis Car Wheel Co.....	21		
				St. Louis Car Wheel Co.....	21		
				St. Louis Surfacers & Paint Co.....	23		
				Sanderson & Porter.....	23		
				Robertson, Wm. & Co.....	19		
				Rouger Ballast Car Co.....	13		
				Rooke Automatic Register Co.....	30		
				Rossiter, MacGovern & Co. (Inc.).....	21		
				Russell Car & Snow-Plow Co.....	23		
				S-E. Missouri Cypress Co.....	22		
				St. Louis Car Wheel Co.....	21		
				St. Louis Car Wheel Co.....	21		
				St. Louis Surfacers & Paint Co.....	23		
				Sanderson & Porter.....	23		
				Robertson, Wm. & Co.....	19		
				Rouger Ballast Car Co.....	13		
				Rooke Automatic Register Co.....	30		
				Rossiter, MacGovern & Co. (Inc.).....	21		
				Russell Car & Snow-Plow Co.....	23		
				S-E. Missouri Cypress Co.....	22		
				St. Louis Car Wheel Co.....	21		
				St. Louis Car Wheel Co.....	21		
				St. Louis Surfacers & Paint Co.....	23		
				Sanderson & Porter.....	23		
				Robertson, Wm. & Co.....	19		
				Rouger Ballast Car Co.....	13		
				Rooke Automatic Register Co.....	30		
				Rossiter, MacGovern & Co. (Inc.).....	21		
				Russell Car & Snow-Plow Co.....	23		
				S-E. Missouri Cypress Co.....	22		
				St. Louis Car Wheel Co.....	21		
				St. Louis Car Wheel Co.....	21		
				St. Louis Surfacers & Paint Co.....	23		
				Sanderson & Porter.....	23		
				Robertson, Wm. & Co.....	19		
				Rouger Ballast Car Co.....	13		
				Rooke Automatic Register Co.....	30		
				Rossiter, MacGovern & Co. (Inc.).....	21		
				Russell Car & Snow-Plow Co.....	23		
				S-E. Missouri Cypress Co.....	22		
				St. Louis Car Wheel Co.....	21		
				St. Louis Car Wheel Co.....	21		
				St. Louis Surfacers & Paint Co.....	23		
				Sanderson & Porter.....	23		
				Robertson, Wm. & Co.....	19		
				Rouger Ballast Car Co.....	13		
				Rooke Automatic Register Co.....	30		
				Rossiter, MacGovern & Co. (Inc.).....	21		
				Russell Car & Snow-Plow Co.....	23		
				S-E. Missouri Cypress Co.....	22		
				St. Louis Car Wheel Co.....	21		
				St. Louis Car Wheel Co.....	21		
				St. Louis Surfacers & Paint Co.....	23		
				Sanderson & Porter.....	23		
				Robertson, Wm. & Co.....	19		
				Rouger Ballast Car Co.....	13		
				Rooke Automatic Register Co.....	30		
				Rossiter, MacGovern & Co. (Inc.).....	21		
				Russell Car & Snow-Plow Co.....	23		
				S-E. Missouri Cypress Co.....	22		
				St. Louis Car Wheel Co.....	21		
				St. Louis Car Wheel Co.....	21		
				St. Louis Surfacers & Paint Co.....	23		
				Sanderson & Porter.....	23		
				Robertson, Wm. & Co.....	19		
				Rouger Ballast Car Co.....	13		
				Rooke Automatic Register Co.....	30		
				Rossiter, MacGovern & Co. (Inc.).....	21		
				Russell Car & Snow-Plow Co.....	23		
				S-E. Missouri Cypress Co.....	22		
				St. Louis Car Wheel Co.....	21		
				St. Louis Car Wheel Co.....	21		
				St. Louis Surfacers & Paint Co.....	23		
				Sanderson & Porter.....	23		
				Robertson, Wm. & Co.....	19		
				Rouger Ballast Car Co.....	13		
				Rooke Automatic Register Co.....	30		
				Rossiter, MacGovern & Co. (Inc.).....	21		
				Russell Car & Snow-Plow Co.....	23		
				S-E. Missouri Cypress Co.....	22		
				St. Louis Car Wheel Co.....	21		
				St. Louis Car Wheel Co.....	21		
				St. Louis Surfacers & Paint Co.....	23		
				Sanderson & Porter.....	23		
				Robertson, Wm. & Co.....	19		
				Rouger Ballast Car Co.....	13		
				Rooke Automatic Register Co.....	30		
				Rossiter, MacGovern & Co. (Inc.).....	21		
				Russell Car & Snow-Plow Co.....	23		
				S-E. Missouri Cypress Co.....	22		
				St. Louis Car Wheel Co.....	21		
				St. Louis Car Wheel Co.....	21		
				St. Louis Surfacers & Paint Co.....	23		
				Sanderson & Porter.....	23		
				Robertson, Wm. & Co.....	19		
				Rouger Ballast Car Co.....	13		
				Rooke Automatic Register Co.....	30		
				Rossiter, MacGovern & Co. (Inc.).....	21		
				Russell Car & Snow-Plow Co.....	23		
				S-E. Missouri Cypress Co.....	22		
				St. Louis Car Wheel Co.....	21		
				St. Louis Car Wheel Co.....	21		
				St. Louis Surfacers & Paint Co.....	23		
				Sanderson & Porter.....	23		
				Robertson, Wm. & Co.....	19		
				Rouger Ballast Car Co.....	13		
				Rooke Automatic Register Co.....	30		
				Rossiter, MacGovern & Co. (Inc.).....	21		
				Russell Car & Snow-Plow Co.....	23		
				S-E. Missouri Cypress Co.....	22		
				St. Louis Car Wheel Co.....	21		
				St. Louis Car Wheel Co.....	21		
				St. Louis Surfacers & Paint Co.....	23		
				Sanderson & Porter.....	23		
				Robertson, Wm. & Co.....	19		
				Rouger Ballast Car Co.....	13		
				Rooke Automatic Register Co.....	30		
				Rossiter, MacGovern & Co. (Inc.).....	21		
				Russell Car & Snow-Plow Co.....	23		
				S-E. Missouri Cypress Co.....	22		

# Shawmut Soldered Railbonds

Are the Original Soldered Bonds  
8 YEARS of Service Under ALL  
Conditions Prove Their RE-  
LIABILITY.

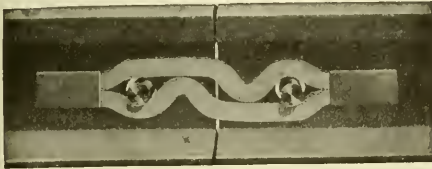

WHY Not Try a Proven Bond  
at Least

SEND FOR OUR PROPOSITION

See Bulletin No. 29

**CHASE-SHAWMUT CO.**  
Newburyport, Mass.

# ASBESTOS WOOD



AS A SUBSTITUTE FOR  
SLATE, MARBLE OR FIBRE

is without an equal, because it is absolutely fire-proof and has an electrical resistance almost equal to sheet mica. Can be worked with ordinary wood-working tools—holds screws well and can be finished in any colors desired.

AS A FIREPROOFING MATERIAL

ASBESTOS WOOD is the best fire-proof sheathing known for electric cars. Its use is indicated wherever it is desirable to protect the electrical equipment from grounds and short circuits, and also to prevent danger of fire from the same causes.

ASBESTOS WOOD can be used in almost all cases where wood, slate or marble are usually employed and where fire-proof construction is desired.

WRITE NEAREST BRANCH FOR CATALOG.

**H. W. JOHNS-MANVILLE CO.**



New York  
Milwaukee  
Chicago  
Boston  
Seattle  
Baltimore

Philadelphia  
St. Louis  
Pittsburg  
Cleveland  
Buffalo  
San Francisco

Kansas City  
Los Angeles  
Minneapolis  
New Orleans  
Dallas  
London 720

# The Root Snow Scraper No. 5

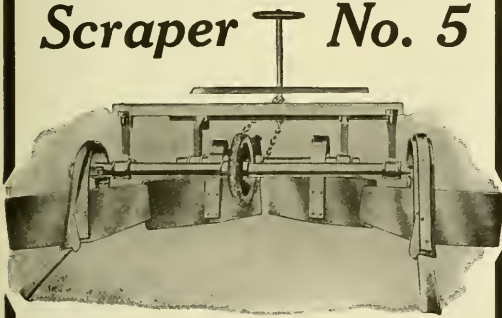

*will make you more money than any other scraper you ever bought.*

*It cleans all the snow from the center to nine inches outside of each rail, and also cleans the groove.*

*This scraper is worth the price every day that it snows.*

**Kalamazoo Railway Supply Co.**  
Kalamazoo, Mich., U. S. A.

# TUBULAR POLES IRON OR STEEL



FOR  
ELECTRIC RAILWAYS  
ELECTRIC LIGHTING CO'S  
SIGNAL TELEPHONE TELEGRAPH SERVICE  
TRANSMISSION LINE AND CATENARY SUSPENSION LINE

**ELECTRIC RAILWAY EQUIPMENT CO.**  
General Office: CINCINNATI O. U.S.A.  
Shops: READING PA. WHEELING W.VA.

## CLASSIFIED LIST OF ADVERTISERS—Continued.

- Brakeshoes—Continued.**  
 Brill, The J. G., Co., Philadelphia.  
 Kuhlman, The G. C., Car Co., Cleveland.  
 McGuire-Cummings Mfg. Co., Chicago.  
 Marshall, R. W. & Co., 95 Liberty St., New York.  
 St. Louis Car Co., St. Louis, Mo.  
 Standard Brake Shoe Co., Aurora, Ill.  
 Stephenson, John, Co., Elizabeth, N. J.  
 Wason Mfg. Co., Springfield, Mass.  
 Wharton, Wm., Jr., & Co., Philadelphia.  
 Wheel Truing Brake Shoe Co., Detroit.
- Bridges, Bascule and Concrete.**  
 Wallace-Coates Engineering Co., Chicago.  
 Johann, F. A., 1624 Pierce Bldg., St. Louis.
- Bridge Timbers.**  
 Beldier, Francis, & Co., Chgo.
- Brushes, Motors and Dyanmos.**  
 Electric Service Supplies Co., 200 Plymouth Bldg., Chicago.  
 General Electric Co., Schenectady, N. Y.  
 National Carbon Co., Cleveland, O.  
 Ridlon, Frank, Co., 200 Summer St., Boston.  
 Spear Carbon Co., St. Marys, Pa.
- Bumpers, Car.**  
 American Car Co., St. Louis.  
 Brill, The J. G., Co., Philadelphia.  
 Kuhlman, The G. C., Car Co., Cleveland.  
 St. Louis Car Co., St. Louis, Mo.  
 Stephenson, John, Co., Elizabeth, N. J.  
 Wason Mfg. Co., Springfield, Mass.
- Car Cleaner.**  
 Gillette Chemical Co., 42 Broadway, New York.
- Car House Doors.**  
 Kinnear Mfg. Co., Columbus, O.  
 Wilson, J. G., Mfg. Co., New York.
- Car Replacers.**  
 Electric Service Supplies Co., 200 Plymouth Bldg., Chicago.  
 Fairbanks, Morse & Co., Chgo.  
 Kalamazoo Railway Supply Co., Kalamazoo, Mich.  
 Ohio Brass Co., Mansfield, O.  
 Car Roof Paint, Canvas.  
 St. Louis Surfacor & Paint Co., St. Louis, Mo.
- Car Seats.**  
 American Car Co., St. Louis.  
 Brill, The J. G., Co., Philadelphia.  
 Hale & Kilburn Mfg. Co., Philadelphia.  
 Heywood Bros. & Wakefield Co., Wakefield, Mass.  
 Kuhlman, The G. C., Car Co., Cleveland.  
 St. Louis Car Co., St. Louis, Mo.  
 Stephenson, John, Co., Elizabeth, N. J.  
 Wallace Supply Co., Chicago.  
 Wason Mfg. Co., Springfield, Mass.
- Car Signs—(See Signs, Cars and Track).**
- Car Steps.**  
 Electric Service Supplies Co., 200 Plymouth Bldg., Chicago.  
 Wallace Supply Co., Chicago.
- Car Trimmings—(See Trimmings, Car).**
- Cars, Ballast.**  
 Rodger Ballast Car Co., Chgo.  
 St. Louis Car Co., St. Louis, Mo.
- Cars, Dump.**  
 Fairbanks, Morse & Co., Chgo.  
 Middletown Car Works, Middletown, Pa.  
 Rodger Ballast Car Co., Chgo.  
 Russell Car & Snow-Plow Co., Ridgway, Pa.  
 St. Louis Car Co., St. Louis, Mo.
- Cars, Passenger and Freight—Continued.**  
 American Car Co., St. Louis.  
 Brill, The J. G., Co., Philadelphia.  
 Cincinnati Car Co., Cincinnati.  
 Detroit Carbuilding & Equipment Co., Detroit, Mich.
- Cars, Passenger and Freight—Continued.**  
 Electric Railway Improvement Co., Cleveland, O.  
 Fairbanks, Morse & Co., Chgo.  
 Jewett Car Co., Newark, O.  
 Johann, F. A., 1624 Pierce Bldg., St. Louis.  
 Kuhlman, The G. C., Car Co., Cleveland.  
 McGuire-Cummings Mfg. Co., Chicago.  
 Niles Car & Mfg. Co., Niles, O.  
 Pressed Steel Car Co., Pittsburg, Pa.  
 Rodger Ballast Car Co., Chgo.  
 Russell Car & Snow-Plow Co., Ridgway, Pa.  
 St. Louis Car Co., St. Louis, Mo.  
 Standard Motor Truck Co., Pittsburg.  
 Stephenson, John, Co., Elizabeth, N. J.  
 Wason Mfg. Co., Springfield, Mass.
- Cars, Pay-As-You-Enter.**  
 Pay-As-You-Enter Car Co., 26 Cortlandt St., New York.
- Cars, Rebuilt.**  
 Detroit Carbuilding & Equipment Co., Detroit, Mich.
- Cars, Second-Hand.**  
 Detroit Carbuilding & Equipment Co., Detroit, Mich.  
 Marshall, R. W. & Co., 95 Liberty St., New York.  
 Zeinicker, Walter A., Supply Co., St. Louis.
- Cars, Steel.**  
 Middletown Car Works, Middletown, Pa.  
 Pressed Steel Car Co., Pittsburg, Pa.  
 St. Louis Car Co., St. Louis, Mo.  
 Standard Motor Truck Co., Pittsburg.
- Castings, Brass.**  
 Star Brass Works, Kalamazoo, Mich.
- Castings, Iron and Steel.**  
 American Brake Shoe & Foundry Co., Mahwah, N. J.  
 Green Engineering Co., Com'l Nat. Bk. Bldg., Chicago.  
 Lorain Steel Co., Johnstown, Pa.  
 National Brake & Electric Co., Milwaukee.
- Catchers—(See Trolley Retrievers and Catchers).**
- Cattle Guards.**  
 Fairbanks, Morse & Co., Chgo.  
 Kalamazoo Railway Supply Co., Kalamazoo, Mich.
- Cements, Cable and Transformer.**  
 Massachusetts Chemical Co., Walpole, Mass.
- Circuit-Breakers.**  
 Electric Service Supplies Co., 200 Plymouth Bldg., Chicago.  
 General Electric Co., Schenectady, N. Y.  
 Western Electric Co., Chicago.
- Coal Handling Machinery—(See Conveyors).**
- Coils—(See Armatures and Coils)**
- Commutators and Parts.**  
 Cleveland Armature Works, Cleveland.  
 Electric Service Supplies Co., 1020-24 Filbert St., Phila.  
 General Electric Co., Schenectady, N. Y.  
 Harrison Elec. & Mfg. Co., 169 South N. Y.  
 Homer Commutator Co., Cleveland, O.  
 Marshall, R. W. & Co., 95 Liberty St., New York.  
 Ohio Brass Co., Mansfield, O.  
 Stuart-Howland Co., Boston.
- Compressors, Air.**  
 Fairbanks, Morse & Co., Chgo.  
 General Electric Co., Schenectady, N. Y.  
 National Brake & Electric Co., Milwaukee.  
 Westinghouse Traction Brake Co., Pittsburg.
- Concrete Mixers.**  
 Contractors' Supply & Equip. Co., Chicago.
- Condensers.**  
 Wheeler Con. & Eng. Co., New York.
- Conduits.**  
 Electric Service Supplies Co., 200 Plymouth Bldg., Chicago.  
 Western Electric Co., Chicago.
- Contractors.**  
 Arnold Company, 131 La Salle St., Chicago.  
 Bylesby, H. M., Co., Am. Trust Bldg., Chicago.  
 Columbia Construction Co., Milwaukee, Wis.  
 Creaghead Engineering Co., Cincinnati, O.  
 Green Engineering Co., Com'l Nat. Bk. Bldg., Chicago.  
 Register, A. J., & Co., 112 N. Broad St., Philadelphia.  
 Sanderson & Porter, 52 William St., New York.  
 Saxton, E., 841 Bladensburg R., Washington, D. C.  
 Sheaff & Jaastad, 88 Broad St., Boston.  
 Stone & Webster Engineering Corp., Boston.  
 Wharton, Wm., Jr., & Co., Philadelphia.  
 White, J. G., & Co., 49 Exchange Pl., New York.
- Controllers and Attachments.**  
 Durkin Con. Handle Co., Arcade Bldg., Philadelphia.  
 Electric Service Supplies Co., 200 Plymouth Bldg., Chicago.  
 General Electric Co., Schenectady, N. Y.  
 Harrison Elec. & Mfg. Co., 169 South N. Y., New York.  
 Johns-Manville, H. W., Co., New York.  
 Marshall, R. W. & Co., 95 Liberty St., New York.  
 Western Electric Co., Chicago.  
 Westinghouse Electric & Mfg. Co., Pittsburg.
- Conveyors and Coal Handling.**  
 Green Engineering Co., Com'l Nat. Bk. Bldg., Chicago.  
 Northern Engineering Works, Detroit, Mich.
- Cord, Bell and Trolley.**  
 American Car Co., St. Louis.  
 Brill, The J. G., Co., Philadelphia.  
 Electric Service Supplies Co., 1020-24 Filbert St., Phila.  
 Kuhlman, The G. C., Car Co., Cleveland.  
 St. Louis Car Co., St. Louis, Mo.  
 Stephenson, John, Co., Elizabeth, N. J.  
 Stuart-Howland Co., Boston.  
 Wason Mfg. Co., Springfield, Mass.
- Couplers, Car.**  
 American Car Co., St. Louis.  
 Brill, The J. G., Co., Philadelphia.  
 Kuhlman, The G. C., Car Co., Cleveland.  
 McGuire-Cummings Mfg. Co., Chicago.  
 Ohio Brass Co., Mansfield, O.  
 St. Louis Car Co., St. Louis, Mo.  
 Stephenson, John, Co., Elizabeth, N. J.  
 Van Dorn W. T. Co., Paulina St., Chicago.  
 Wallace Supply Co., Chicago.  
 Washburn, E. C., Minneapolis.  
 Wason Mfg. Co., Springfield, Mass.
- Coverings, Pipe and Boiler.**  
 Johns-Manville, H. W., Co., New York.
- Cranes, Hoists and Lifts.**  
 American Car Co., St. Louis.  
 Brill, The J. G., Co., Philadelphia.  
 Brown Hoisting Machinery Co., Cleveland, O.  
 Kuhlman, The G. C., Car Co., Cleveland.  
 Northern Engineering Works, Detroit, Mich.  
 Railway Specialty & Supply Co., Chicago.  
 Stephenson, John, Co., Elizabeth, N. J.  
 Van Dorn & Dutton Co., Cleveland, O.  
 Wason Mfg. Co., Springfield, Mass.
- Cross Arms—(See Brackets and Cross Arms).**
- Crossing Gates—(See Gates and Crossings).**
- Crossings, Track—(See Switches).**
- Curtains, Fixtures and Materials—Continued.**  
 Hartmann, Stewart, Co., East Newark, N. J.  
 Kuhlman, The G. C., Car Co., Cleveland.  
 Marshall, R. W. & Co., 95 Liberty St., New York.  
 National Lock Washer Co., Newark, N. J.  
 Pantasote Co., 11 Broadway, New York.  
 St. Louis Car Co., St. Louis, Mo.  
 Stephenson, John, Co., Elizabeth, N. J.  
 Wason Mfg. Co., Springfield, Mass.
- Cylinder Oil.**  
 Power Specialty Co., 111 Broadway, N. Y.
- Derailing Devices.**  
 American Frog & Switch Co., Hamilton, O.  
 Cincinnati Frog & Switch Co., Cincinnati, O.  
 Cleveland Frog & Crossing Co., Cleveland, O.
- Detective Agency.**  
 Drummond Detective Agency, New York.
- Diaphragms.**  
 Wood, G. S., Great Northern Bldg., Chicago.
- Doors and Fixtures.**  
 American Car Co., St. Louis.  
 Brill, The J. G., Co., Philadelphia.  
 Kuhlman, The G. C., Car Co., Cleveland.  
 St. Louis Car Co., St. Louis, Mo.  
 Stephenson, John, Co., Elizabeth, N. J.  
 Wallace Supply Co., Chicago.  
 Wason Mfg. Co., Springfield, Mass.
- Doors, Steel Rolling.**  
 Kinnear Manufacturing Co., Columbus, O.  
 Wilson, J. G., Mfg. Co., New York.
- Draft, Mechanical—(See Mechanical Draft).**
- Draft Rigging.**  
 Van Dorn W. T. Co., Chgo.  
 Wallace Supply Co., Chicago.
- Drills, Trak.**  
 Brown, H. P., 120 Liberty St., New York.  
 Electric Service Supplies Co., 200 Plymouth Bldg., Chicago.  
 Fairbanks, Morse & Co., Chgo.  
 Kalamazoo Railway Supply Co., Kalamazoo, Mich.  
 Marshall, R. W. & Co., 95 Liberty St., New York.  
 Reed, Francis, Co., Worcester, Mass.  
 Ridlon, Frank, Co., 200 Summer St., Boston.
- Drying Appliances.**  
 Green Fuel Economizer Co., Matteawan, N. Y.
- Dynamas and Generators.**  
 Cleveland Armature Works, Cleveland, O.  
 Fairbanks, Morse & Co., Chgo.  
 General Electric Co., Schenectady, N. Y.  
 National Brake & Electric Co., Milwaukee, Wis.  
 Rossie & Macgovern & Co., 7 Battery Pl., New York.  
 Western Electric Co., Chicago.  
 Westinghouse Electric & Mfg. Co., Pittsburg, Pa.
- Economizers, Fuel.**  
 Green Fuel Economizer Co., Matteawan, N. Y.
- Electrical Instruments.**  
 Electric Service Supplies Co., 200 Plymouth Bldg., Chicago.  
 General Electric Co., Schenectady, N. Y.  
 Johns-Manville, H. W., Co., New York.  
 Queen & Co., Philadelphia.  
 Western Electric Co., Chicago.  
 Westinghouse Electric & Mfg. Co., Pittsburg, Pa.  
 Weston Electrical Instrument Co., Newark, N. J.
- Electric Railway Supplies, General.**  
 Cleveland Armature Works, Cleveland, O.  
 Creaghead Engineering Co., Cincinnati, O.

# ST. LOUIS CAR CO. ST. LOUIS-MO.



## Builders *of* Electric Cars

of every kind in the largest and best equipped factory in the world.

Specifications & Drawings  
furnished - on - application

## CLASSIFIED LIST OF ADVERTISERS—Continued.

- Electric Railway Supplies, General—Continued.  
Electric Service Supplies Co., 200 Plymouth Bldg., Chicago.  
Fairbanks, Morse & Co., Chgo. General Electric Co., Schenectady, N. Y.  
Harrison Elec. & Mfg. Co., 169 South St., New York.  
Johns-Manville, H. W., Co., New York.  
Marshall, R. W., & Co., 95 Liberty St., New York.  
Ohio Brass Co., Mansfield, O.  
Stuart-Howland Co., Boston.  
Wallace Supp. Co., Chicago.  
Western Electric Co., Chicago.
- Enamels.  
Acme White Lead & Color Works, Detroit, Mich.  
St. Louis Surfacor & Paint Co., St. Louis, Mo.
- Engine Apparatus.  
Green Fuel Economizer Co., Matteawan, N. Y.
- Engineers and Contractors.  
Arnold Company, Chicago.  
Byllesby, H. M., & Co., Chgo. Columbia Construction Co., Milwaukee, Wis.  
Ford, Bacon & Davis, New York.  
Register, A. L., & Co., Philadelphia.  
Roberts & Abbott Co., Cleveland, O.  
Sanderson & Porter, New York.  
Saxton, E., Washington, D. C.  
Sheaff & Jaastad, Boston.  
Stone & Webster Eng. Corporation, Boston.  
White, J. G., & Co., New York.
- Engines, Gas and Oil.  
Buckeye Engine Co., Salem, O.  
Fairbanks, Morse & Co., Chgo. Westinghouse Machine Co., Pittsburg.
- Engines, Hoisting.  
Fairbanks, Morse & Co., Chgo.
- Engines, Steam.  
Buckeye Engine Co., Salem, O.  
Hooven-Owens-Rentscher Co., Hamilton, O.  
Rossiter, MacGovern & Co., 17 Battery Pl., New York.  
Westinghouse Machine Co., Pittsburg.
- Fans, Exhaust and Ventilating.  
General Electric Co., Schenectady, N. Y.  
Green Fuel Economizer Co., Matteawan, N. Y.  
Western Electric Co., Chicago.  
Westinghouse Elec. & Mfg. Co., Pittsburg.
- Fare Boxes—(See Electric Railway Supplies).
- Fare Registers and Register Fittings.  
Electric Service Supplies Co., 200 Plymouth Bldg., Chicago.  
Recording Fare Register Co., New Haven, Conn.  
Rooke Automatic Register Co., Providence, R. I.  
Security Register & Mfg. Co., 42 Broadway, New York.
- Feedwater Apparatus.  
Green Fuel Economizer Co., Matteawan, N. Y.  
Wheeler, Condenser & Eng'g Co., New York.
- Feed Wire—(See Wire and Cables).
- Fenders and Guards.  
Consolidated Car Fender Co., Providence, R. I.  
Eclipse Railway Supply Co., Cleveland, O.  
Electric Service Supplies Co., 1020-24 Filbert St., Phila.  
McGuire-Cummings Mfg. Co., Chicago.  
Marshall, R. W., & Co., 95 Liberty St., New York.
- Flangers, Snow.  
Kalamazoo Railway Supply Co., Kalamazoo, Mich.  
McGuire-Cummings Mfg. Co., Chicago.  
Ohio Brass Co., Mansfield, O.  
Van Dorn & Dutton Co., Cleveland, O.
- Frogs—(See Switches, Frogs and Crossings).
- Fuel Economizers—(See Economizers, Fuel).
- Fuses and Fuse Devices.  
Chase-Shawmut Co., Newburyport, Mass.
- Fuses and Fuse Devices—Continued.  
Electric Service Supplies Co., 200 Plymouth Bldg., Chicago.  
General Electric Co., Schenectady, N. Y.  
Johns-Manville, H. W., Co., New York.  
Western Electric Co., Chicago.  
Westinghouse Elec. & Manufacturing Co., Pittsburg.
- Gaskets, Bronze.  
Power Specialty Co., 111 Broadway, New York.
- Gates and Guards.  
Bliss, R., Mfg. Co., Pawtucket, R. I.  
Kalamazoo Railway Supply Co., Kalamazoo, Mich.
- Gear Cases.  
Electric Service Supplies Co., 200 Plymouth Bldg., Chicago.  
General Electric Co., Schenectady, N. Y.  
Marshall, R. W., & Co., 95 Liberty St., New York.
- Gears and Pinions.  
Electric Service Supplies Co., 200 Plymouth Bldg., Chicago.  
General Electric Co., Schenectady, N. Y.  
Marshall, R. W., & Co., 95 Liberty St., New York.  
Nuttall, R. D., Co., Pittsburg.  
Van Dorn & Dutton Co., Cleveland, O.
- Generators—(See Dynamos).
- Gongs—(See Bells and Gongs).
- Graphite.  
Detroit Graphite Co., Detroit, Mich.  
U. S. Graphite Co., Saginaw, Mich.
- Graphite Paint—(See Paint).
- Grates, Chain.  
Green Engineering Co., Com'l Nat. Bk. Bldg., Chicago.
- Grease—(See Lubricants).
- Grinders.  
Brown, Harold P., 120 Liberty St., New York.
- Guy Anchors—(See Anchors).
- Harps, Trolley—(See Trolley Poles and Fittings).
- Headlights.  
Electric Service Supplies Co., 200 Plymouth Bldg., Chicago.  
Fairbanks, Morse & Co., Chgo. General Electric Co., Schenectady, N. Y.  
Ridlon, Frank Co., 200 Summer St., Boston.  
St. Louis Car Co., St. Louis, Mo.  
Schroeder Headlight Co., Evansville, Ind.  
Stuart-Howland Co., Boston.  
Trolley Supply Co., Canton, O.
- Headlinings, Passenger Car.  
Indestructible Fibre Co., 45 Broadway, New York.
- Heaters, Car, Electric.  
Consolidated Car-Heating Co., Albany, N. Y.  
Johns-Manville, H. W., Co., New York.
- Heaters, Car, Hot Water, and Stoves.  
Baker, The Wm. C., Heating & Supp. Co., New York.  
Cooper Heater Co., The Dayton, O.  
Electric Service Supplies Co., 1020-24 Filbert St., Phila.  
McGuire-Cummings Mfg. Co., Chicago.  
Smith, Peter, Heater Co., Detroit, Mich.
- Heating and Ventilating Apparatus—(See Mech. Draft).
- Hoists—(See Cranes, Hoists and Lifts).
- Hose Bridges.  
Ohio Brass Co., Mansfield, O.
- Hydraulic Machinery.  
Watson-Stillman Co., 26 Cortlandt St., New York.
- Inspection.  
Central Inspection Bureau.
- Instruments, Measuring and Testing—(See Electrical Instruments).
- Insulating Tapes.  
General Electric Co., Schenectady, N. Y.  
Harrison Elec. & Mfg. Co., 169 South St., New York.  
Massachusetts Chemical Co., Walpole, Mass.  
Okrite Co., Ltd., 253 Broadway, New York.  
Western Electric Co., Chicago.
- Insulations and Insulating Material.  
Anderson, A. & J. M., Mfg. Co., Boston.  
Creaghead Engineering Co., Cincinnati, O.  
Electric Railway Equipment Co., Cincinnati, O.  
Electric Service Supplies Co., 200 Plymouth Bldg., Chicago.  
General Electric Co., Schenectady, N. Y.  
Johns-Manville, H. W., Co., New York.  
Macallen, The Co., Boston.  
Massachusetts Chemical Co., Walpole, Mass.  
Ohio Brass Co., Mansfield, O.  
Okite Co., Ltd., 253 Broadway, New York.  
Ridlon, Frank Co., 200 Summer St., Boston.  
Standard Paint Co., 100 William St., New York.  
Standard Varnish Works, New York.  
Stuart-Howland Co., Boston.  
Western Electric Co., Chicago.
- Jacks.  
American Car Co., St. Louis.  
Brill, The J. G., Co., Philadelphia.
- Electric Service Supplies Co., 200 Plymouth Bldg., Chicago.  
Fairbanks, Morse & Co., Chgo. Kalamazoo Railway Supply Co., Kalamazoo, Mich.  
Kuhlman, The G. C., Car Co., Cleveland.  
Marshall, R. W., & Co., 95 Liberty St., New York.  
Morden Frog & Crossing Co., Chicago, Ill.  
Security Register & Mfg. Co., New York.  
Stephenson, John, Co., Elizabeth, N. J.  
Watson Mfg. Co., Springfield, Mass.  
Watson-Stillman Co., 26 Cortlandt St., New York.
- Joints, Expansion—(See Steam Fittings).
- Joints, Rail.  
Goldschmidt Thermit Co., 43 Exchange Pl., New York.  
Rail Joint Co., 29 W. 34th St., New York.
- Joints, Welded—(See Rail Joints, Welded).
- Journal Boxes.  
American Car Co., St. Louis.  
Brill, The J. G., Co., Philadelphia.  
Kuhlman, The G. C., Car Co., Cleveland.  
McGuire-Cummings Mfg. Co., Chicago.  
St. Louis Car Co., St. Louis, Mo.  
Stephenson, John, Co., Elizabeth, N. J.  
Symington, T. H., Co., Baltimore, Md.  
Watson Mfg. Co., Springfield, Mass.
- Journal Lubricators—(See Lubricants).
- Journal Packing, Steel Wool.  
Robertson, Wm., & Co., Great Northern Bldg., Chicago.
- Lamps, Arc and Incandescent.  
Anderson, A. & J. M., Mfg. Co., Boston.  
Electric Service Supplies Co., 200 Plymouth Bldg., Chicago.  
General Electric Co., Schenectady, N. Y.  
Ridlon, Frank Co., 200 Summer St., Boston.  
Stuart-Howland Co., Boston.  
Western Electric Co., Chicago.  
Westinghouse Electric & Mfg. Co., Pittsburg, Pa.
- Lamp Sockets.  
Electric Service Supplies Co., 200 Plymouth Bldg., Chicago.  
General Electric Co., Schenectady, N. Y.
- Lifts—(See Cranes, Hoist and Lift).
- Lightning Arresters.  
Electric Service Supplies Co., 200 Plymouth Bldg., Chicago.  
General Electric Co., Schenectady, N. Y.  
Stuart-Howland Co., Boston.  
Western Electric Co., Chicago.  
Westinghouse Elec. & Manufacturing Co., Pittsburg.
- Line Material.  
Anderson, A. & J. M., Mfg. Co., Boston.  
Creaghead Engineering Co., Cincinnati, O.  
Johns-Manville, H. W., Co., New York.  
Electric Ry. Equipment Co., Cincinnati, O.  
Electric Service Supplies Co., 200 Plymouth Bldg., Chicago.  
General Electric Co., Schenectady, N. Y.  
Macallen, The Co., Boston.  
Marshall, R. W., & Co., 95 Liberty St., New York.  
Recording Fare Register Co., New Haven, Conn.  
Stuart-Howland Co., Boston.  
Western Electric Co., Chicago.
- Lock and Nut Washers.  
Grip Nut Co., 152 Lake St., Chicago.  
National Lock Washer Co., Newark, N. J.
- Lockers, Metal.  
Electric Service Supplies Co., 200 Plymouth Bldg., Chicago.
- Locomotives.  
Baldwin Locomotive Works, Philadelphia.  
Johann, F. A., 1624 Pierce Bldg., St. Louis.
- Locomotives, Electric.  
American Car Co., St. Louis.  
Baldwin Locomotive Works, Philadelphia.  
Brill, The J. G., Co., Philadelphia.  
General Electric Co., Schenectady, N. Y.  
Kuhlman, The G. C., Car Co., Cleveland.  
McGuire-Cummings Mfg. Co., Chicago.  
Stephenson, John, Co., Elizabeth, N. J.  
Watson Mfg. Co., Springfield, Mass.  
Westinghouse Elec. & Manufacturing Co., Pittsburg.
- Locomotives, Gasoline.  
Fairbanks, Morse & Co., Chgo.
- Lubricants.  
Dearborn Drug & Chemical Works, Chicago.  
Detroit Graphite Co., Detroit, Mich.  
Galena-Signal Oil Co., Franklin, Pa.  
U. S. Graphite Co., Saginaw, Mich.  
Whitmore Mfg. Co., Cleveland, O.
- Lumber.  
Beave Dam Lumber Co., St. Louis, Mo.  
Beidler, Francis, & Co., Chgo.  
Berthold & Jennings, St. Louis.  
Lindsay Bros. Co., Spokane, Wash.  
S-E. Missouri Cypress Co., Campbell, Mo.
- Lumber, Asbestos.  
Johns-Manville, H. W., Co., New York.
- Malleable Iron.  
Beave Dam Lumber Co., St. Louis, Mo.  
Beaver Dam, Wis.  
St. Louis Car Co., St. Louis, Mo.
- Measuring Tapes.  
Leiford Rule Co., Saginaw, Mich.
- Mechanical Draft.  
Green Fuel Economizer Co., Matteawan, N. Y.
- Meters.  
Johns-Manville, H. W., Co., New York.  
Weston Electrical Instrument Co., Newark, N. J.



You can reap the advantages of the pay-as-you-enter plan of fare collection in one way only—by operating specially designed

## Pay-As-You-Enter Cars

built under licenses granted by the owners of the patents.

Every attempt made in any other manner is doomed to failure. If favorably impressed with the pay-as-you-enter plan, you cannot afford to prejudice the public against it by making an experiment with ordinary cars that can have no other result than absolute failure.

The success of the pay-as-you-enter plan has been established beyond question. The most recent example of successful operation is in Buffalo, where the new cars were enthusiastically received by the press and public

We license manufacturers and railways to build and use the Pay-As-You-Enter Car, the patents on which are owned by

### The Pay-As-You-Enter Car Company

DUNCAN McDONALD  
President

26 Cortlandt Street, New York

THOS. W. CASEY  
Manager

## CLASSIFIED LIST OF ADVERTISERS—Continued.

- Molded Goods.**  
Massachusetts Chemical Co., Walpole, Mass.  
Wood, G. S., Great Northern Bldg., Chicago.
- Motors, Electric.**  
Cleveland Armature Works, Cleveland, O.  
Fairbanks, Morse & Co., Chgo. General Electric Co., Schenectady, N. Y.  
National Brake & Electric Co., Milwaukee.  
Rossiter, MacGovern & Co., 17 Battery Pl., New York.  
Western Electric Co., Chicago. Westinghouse Elec. & Manufacturing Co., Pittsburg.
- Nut Locks.**  
Grip Nut Co., 152 Lake St., Chicago.  
National Lock Washer Co., Newark, N. J.  
Railway Specialty & Supply Co., Chicago.  
St. Louis Car Co., St. Louis, Mo.
- Nuts and Bolts.**  
Grip Nut Co., 152 Lake St., Chicago.  
Lorain Steel Co., Philadelphia. National Lock Washer Co., Newark, N. J.  
Railway Specialty & Supply Co., Chicago.
- Oilers.**  
Armstrong Oiler Co., 31st and Chestnut St., Philadelphia.
- Oils—(See Lubricants).**
- Overhead Equipment—(See Electric Railway Supplies).**
- Packings.**  
Electric Service Supplies Co., 200 Plymouth Bldg., Chicago.  
Johns-Manville, H. W., Co., Newark, N. J.  
Power Specialty Co., 111 Broadway, New York.
- Packing, Steel Wool Journal.**  
Robertson, Wm., & Co., Gt. Northern Bldg., Chicago.
- Paints.**  
Acme White Lead & Color Works, Detroit.  
Detroit Graphite Co., Detroit.  
Goheen Mfg. Co., Canton, O.  
Massachusetts Chemical Co., Walpole, Mass.  
Standard Paint Co., 100 William St., New York.  
St. Louis Sp. Facer & Paint Co., St. Louis, Mo.  
U. S. Graphite Co., Saginaw, Mich.
- Pay-As-You-Enter Cars.**  
Pay-As-You-Enter Car Co., 26 Cortlandt St., New York.
- Pipe Bends and Fittings—(See Steam Fittings).**
- Plumbago.**  
Detroit Graphite Co., Detroit, Mich.  
U. S. Graphite Co., Saginaw, Mich.
- Poles, Metal.**  
Creshead Engineering Co., Cincinnati, O.  
Electric Railway Equipment Co., Cincinnati, O.  
Electric Service Supplies Co., 200 Plymouth Bldg., Chicago.
- Poles and Ties, Wood.**  
Advance Lumber Co., Cleveland, O.  
Barnes, G. H., Hardwood Lumber Co., St. Louis, Mo.  
Beidler, Francis, & Co., Chgo. Berthold & Jennings, St. Louis.  
Churchill Cedar Co., Spokane, Wash.  
Humbird Lumber Co., Sand Point, Idaho.  
Lindsay Bros. Co., Spokane, Wash.  
Naugle Pole & Tie Co., 226 La Salle St., Chicago.  
Pacific Coast Pole Co., Spokane, Wash.  
S-E. Missouri Cypress Co., Campbell, Mo.  
Worcester, C. H., Co., Tribune Bldg., Chicago.
- Punches—(See Ticket Punches).**
- Rail Benders.**  
Electric Service Supplies Co., 200 Plymouth Bldg., Chicago.  
Fairbanks, Morse & Co., Chgo. Kalamazoo Railway Supply Co., Kalamazoo, Mich.
- Rail Bonds—(See Bonds, Rail).**
- Rail Brackets.**  
Beaver Dam Malleable Iron Co., Beaver Dam, Wis.
- Rail Drills—(See Drills, Track).**
- Rail Feed Wire—(See Wire and Cables).**
- Rail Joints and Chairs—(See Joints, Rail).**
- Rail Joints, Welded.**  
Goldschmidt Thermit Co., 43 Exchange Pl., New York.  
Lorain Steel Co., Philadelphia.
- Rails, New.**  
Lorain Steel Co., Philadelphia. New York Switch & Crossing Co., Hoboken, N. J.  
Wharton, Wm., Jr., & Co., Philadelphia.
- Rails, Relaying.**  
Zelnicker, Walter A., Supply Co., St. Louis.
- Railway Equipment.**  
Johann, F. A., 1624 Pierce Bldg., St. Louis.
- Railway Velocipedes.**  
Fairbanks Morse & Co., Chgo. Kalamazoo Railway Supply Co., Kalamazoo, Mich.
- Registers and Fittings—(See Fare Registers).**
- Relays.**  
Weston Electrical Instrument Co., Newark, N. J.
- Roofing.**  
Johns-Manville, H. W., Co., Newark, N. J.
- Rubber Goods, Mechanical.**  
Wood, G. S., Great Northern Bldg., Chicago.
- Rubber Preservative.**  
Wood, G. S., Great Northern Bldg., Chicago.
- Sand Apparatus.**  
American Car Co., St. Louis.  
Brill, The J. G., Co., Philadelphia.  
Electric Service Supplies Co., 200 Plymouth Bldg., Chicago.  
Kuhlman, The G. C., Car Co., Cleveland.  
Marshall, R. W., & Co., 95 Liberty St., New York.  
Ohio Brass Co., Mansfield, O.  
Ridlon, Frank, Co., 200 Summer St., Boston.  
St. Louis Car Co., St. Louis, Mo.  
Stephenson, John, Co., Elizabeth, N. J.  
Wason Mfg. Co., Springfield, Mass.
- Sash Balances and Fixtures.**  
National Lock Washer Co., Newark, N. J.
- Sash Operating Devices.**  
Drouvé, The G. Co., Bridgeport, Conn.
- Seats, Car—(See Car Seats).**
- Shade Rollers—(See Curtains, Fixtures and Materials).**
- Shutters, Steel Rolling.**  
Kinner Manufacturing Co., Columbus, O.
- Signals.**  
Blake Signal & Manufacturing Co., Boston.  
Telegraph Signal Co., Rochester, N. Y.
- Signal Supplies.**  
Railway Specialty & Supply Co., Chicago.
- Skylights.**  
Drouvé, The G. Co., Bridgeport, Conn.
- Snow Plows, Sweepers and Scrapers.**  
American Car Co., St. Louis.  
Brill, The J. G., Co., Philadelphia.  
Kalamazoo Railway Supply Co., Kalamazoo, Mich.  
Kuhlman, The G. C., Car Co., Cleveland.  
McGuire-Cummings Mfg. Co., Chicago.  
Lorain Steel Co., Philadelphia.  
Morden Frog & Crossing Co., Cleveland, O.  
Fairbanks, Morse & Co., Chgo. Lorain Steel Co., Philadelphia.  
Rookery, Chicago.  
New York Switch & Crossing Co., Hoboken, N. J.  
Railway Specialty & Supply Co., Chicago.
- Snaw Plows, Sweepers and Scrapers—Continued.**  
Stephenson, John, Co., Elizabeth, N. J.  
Wason Mfg. Co., Springfield, Mass.
- Sockets, Waterproof.**  
Johns-Manville, H. W., Co., Newark, N. J.
- Special Agents.**  
Waddell & Mahon, 1133 Broadway, New York.
- Splicing Compounds and Materials.**  
Massachusetts Chemical Co., Walpole, Mass.
- Springs.**  
American Car Co., St. Louis.  
Brill, The J. G., Co., Philadelphia.  
Kuhlman, The G. C., Car Co., Cleveland.  
McGuire-Cummings Mfg. Co., Chicago.  
Marshall, R. W., & Co., 95 Liberty St., New York.  
Railway Steel Spring Co., 71 Broadway, New York.  
St. Louis Car Co., St. Louis, Mo.  
Stephenson, John, Co., Elizabeth, N. J.  
Wason Mfg. Co., Springfield, Mass.
- Sprinkling Cars.**  
American Car Co., St. Louis.  
Brill, The J. G., Co., Philadelphia.  
Kuhlman, The G. C., Car Co., Cleveland.  
McGuire-Cummings Mfg. Co., Chicago.  
Stephenson, John, Co., Elizabeth, N. J.  
Wason Mfg. Co., Springfield, Mass.
- Steam Apparatus.**  
Great Fuel Economizer Co., Matteawan, N. Y.
- Steam Fittings, Etc.**  
Crane Co., Chicago.  
Davis, The John, Co., Chgo. Simmons, John, Co., 110 Centre St., New York.  
Power Specialty Co., 111 Broadway, New York.
- Steel Cars.**  
American Car Co., St. Louis.  
Brill, The J. G., Co., Philadelphia.  
Kuhlman, The G. C., Car Co., Cleveland.  
Stephenson, John, Co., Elizabeth, N. J.  
Wason Mfg. Co., Springfield, Mass.
- Steel Tapes.**  
Lufkin Rule Co., Saginaw, Mich.
- Stokers.**  
Babcock & Wilcox Co., 85 Liberty St., New York.  
Green Engineering Co., Com'l Nat. Bk. Bldg., Chicago.  
Model Stoker Co., Dayton, O.  
Under-Feed Stoker Co. of Am., Chicago.  
Westinghouse Machine Co., Pittsburg.
- Storage Batteries—(See Batteries).**
- "Strike-Breakers."**  
Drummond Detective Agency, 3 Ann St., New York.  
Waddell & Mahon, 1133 Broadway, New York.
- Superheaters.**  
Power Specialty Co., 111 Broadway, New York.
- Switches, Frogs and Crossings.**  
American Frog & Switch Co., Hamilton, O.  
Barbour-Stockwell Co., Cambridgeport, Mass.  
Cincinnati Frog & Switch Co., Cincinnati, O.  
Cleveland Frog & Crossing Co., Cleveland, O.  
Fairbanks, Morse & Co., Chgo. Lorain Steel Co., Philadelphia.  
Morden Frog & Crossing Co., Rookery, Chicago.  
New York Switch & Crossing Co., Hoboken, N. J.  
Railway Specialty & Supply Co., Chicago.
- Switches, Frogs and Crossings—Continued.**  
Wharton, Wm., Jr., & Co., Philadelphia.
- Switchboards and Switchboard Instruments.**  
Anderson, A. & J. M., Mfg. Co., Boston.  
Chase-Shawmut Co., Newburyport, Mass.  
General Electric Co., Schenectady, N. Y.  
Western Electric Co., Chicago. Westinghouse Electric & Mfg. Co., Pittsburg.  
Weston Electrical Instrument Co., Newark, N. J.
- Tapes and Webbing.**  
Hope Webbing Co., Providence, R. I.  
Johns-Manville, H. W., Co., Newark, N. J.  
Massachusetts Chemical Co., Walpole, Mass.  
Okonite Co., Ltd., 253 Broadway, New York.
- Testing Instruments.**  
Weston Electrical Instrument Co., Newark, N. J.
- Ticket Choppers and Destroyers.**  
Patten, Paul B., Salem, Mass.
- Ticket Punches.**  
Meyers, Fred J., Mfg. Co., Hamilton, O.  
Woodman Mfg. & Sup. Co., Boston.
- Tieplates.**  
Beaver Dam Malleable Iron Co., Beaver Dam, Wis.
- Ties and Poles, Wood—(See Poles and Ties).**
- Timber.**  
Beidler, Francis, & Co., Chgo. Lindsay Bros. Co., Spokane, Wash.  
S-E. Missouri Cypress Co., Campbell, Mo.
- Tools, Pneumatic—(See Pneumatic Tools).**
- Track Cleaners and Scrapers.**  
American Car Co., St. Louis.  
Brill, The J. G., Co., Philadelphia.  
Kalamazoo Railway & Supply Co., Kalamazoo, Mich.  
Kuhlman, The G. C., Car Co., Cleveland.  
McGuire-Cummings Mfg. Co., Chicago.  
Marshall, R. W., & Co., 95 Liberty St., New York.  
Ohio Brass Co., Mansfield, O.  
Stephenson, John, Co., Elizabeth, N. J.  
Van Dorn & Dutton Co., Cleveland, O.  
Wason Mfg. Co., Springfield, Mass.
- Track Drills—(See Drills, Track).**
- Tracklaying Machinery.**  
Holman, D. F., Ry. Tracklayer Co., 1102 Ellsworth Bldg., Chicago.
- Track Tools.**  
Electric Service Supplies Co., 200 Plymouth Bldg., Chicago.  
Kalamazoo Railway Supply Co., Kalamazoo, Mich.
- Trimlings, Car.**  
American Car Co., St. Louis.  
Brill, The J. G., Co., Philadelphia.  
Curtain Supply Co., Park Row Bldg., New York.  
Kuhlman, The G. C., Car Co., Cleveland.  
National Lock Washer Co., Newark, N. J.  
St. Louis Car Co., St. Louis, Mo.  
Stephenson, John, Co., Elizabeth, N. J.  
Wallace Supply Co., Chicago.  
Wason Mfg. Co., Springfield, Mass.  
Wood, G. S., Great Northern Bldg., Chicago.
- Trolley Guards.**  
Electric Service Supplies Co., 200 Plymouth Bldg., Chicago.
- Trolley Poles and Fittings.**  
General Electric Co., Schenectady, N. Y.  
Johns-Manville, H. W., Co., Newark, N. J.  
Marshall, R. W., & Co., 95 Liberty St., New York.

# THE SYMINGTON JOURNAL BOX

## FOR ELECTRIC TRUCKS

Now Standard on the Majority of Modern Electric Trucks of M. C. B. or Special Type

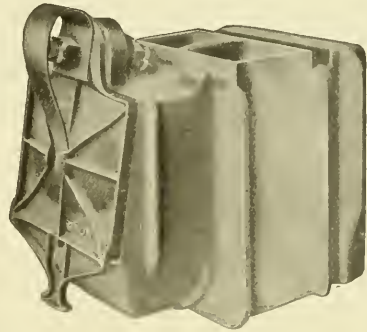
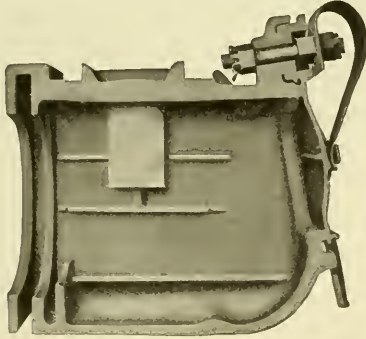

### Special Notice!

WE ARE PREPARED TO FURNISH AT ONCE  
THE STANDARD JOURNAL BOXES OF  
THE AMERICAN STREET AND INTERURBAN RAILWAY ASSOCIATION

BALTIMORE  
MD.

**THE T. H. SYMINGTON CO.**

CHICAGO  
ILL.

THE  
**Van Dorn & Dutton Co.**  
CLEVELAND, OHIO  
MANUFACTURERS OF  
**GEARS AND PINIONS**

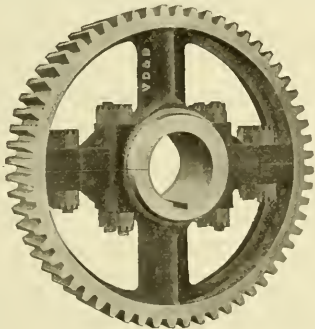

For All Types of Motors  
HIGHEST QUALITY

# Galena-Signal Oil Company

FRANKLIN, PA.

THEIR SPECIALTIES

**STREET RAILWAY LUBRICATION** including both rolling stock and power house equipment.

Same skillful *expert supervision* given in this service as in steam railway service has produced very satisfactory results. The business of our Street Railway Department has increased beyond every expectation. In 1906 this department sold ten times the number of barrels of oil sold by the same department in 1903.

We are under contract with many of the largest street and interurban railways of the country.

We guarantee cost per thousand miles in street railway service when conditions warrant it.

Write to Franklin, Pennsylvania, for further particulars.

**STEAM RAILWAY LUBRICATION** Sole manufacturers of the celebrated *Galena Cough, Engine and Car Oils* for steam railway lubrication. *Nibley's Perfection Valve Oil* for cylinder lubrication, and *Perfection Signal Oil* for use in railway signal lanterns.

**GALENA RAILWAY SAFETY OIL** Made especially for use in headlights, cab, classification and tail lights, and for switch and semaphore lamps. Burns equally well with the long time as with the one-day burner; with or without chimney as the burner requires. Is pure water white in color; high fire test, low cold test, and splendid gravity.

CHAS. MILLER, President

CLASSIFIED LIST OF ADVERTISERS Continued.

Trolley Retrievers and Catchers. Earl, C. I., Bowling Green Bldg., New York.  
Electric Service Supplies Co., 1020-24 Filbert St., Phila.  
Milloy Electric Co., Bucyrus, O.  
Ridlon, Frank, Co., 200 Summer St., Boston.  
Trolley Supply Co., Canton, O.

Trolley Wagons. Kalamazoo Railway Supply Co., Kalamazoo, Mich.

Trolley Wheels—(See Trolley Poles and Fittings).

Trolley Wire—(See Wire and Cables).

Trolleys, Track. Cleveland Armature Works, Cleveland, O.

Trucks, Car. American Car Co., St. Louis.  
Baldwin Locomotive Works, Philadelphia.  
Brill, The J. G., Co., Philadelphia.  
Kuhlman, The G. C., Car Co., Cleveland.  
McGuire-Cummings Mfg. Co., Chicago.  
St. Louis Car Co., St. Louis, Mo.  
Standard Motor Truck Co., Pittsburg, Pa.  
Standard Varnish Works, New York City.  
Stephenson, John, Co., Elizabeth, N. J.

Trucks, Car—Continued. Van Dorn & Dutton Co., Cleveland, O.  
Wason Mfg. Co., Springfield, Mass.

Turbines. General Electric Co., Schenectady, N. Y.  
Hooven-Owens-Rentschler Co., Hamilton, O.  
Westinghouse Machine Co., Pittsburg, Pa.

Uniforms. Hamilton-Ames Co., The, Kalamazoo, Mich.

Valves—(See Steam Fittings).

Varnish. Acme White Lead & Color Works, Detroit.  
Electric Service Supplies Co., 200 Plymouth Bldg., Chicago.  
Harrison Elec. & Mfg. Co., 169 South St., New York.  
Marshall, R. W., & Co., 95 Liberty St., New York.  
Massachusetts Chemical Co., Walpole, Mass.  
Milloy Electric Co., Bucyrus, O.  
Nuttall, R. D., Co., Pittsburg, Pa.  
Ridlon, Frank, Co., 200 Summer St., Boston.  
Standard Paint Co., 100 William St., New York.  
Star Brass Works, Kalamazoo, Mich.  
Trolley Supply Co., Canton, O.  
Wallace Supply Co., Chicago.  
Westinghouse Electric & Mfg. Co., Pittsburg, Pa.

Ventilators. Drouvé, The G. Co., Bridgeport, Conn.

Vestlettes. Bellamy Vestlette Mfg. Co., Cleveland, O.

Waste, Cotton and Wool. Hagy, J. Milton, Waste Wks., Philadelphia, Pa.  
Railway Specialty & Supply Co., Chicago.

Water Softening Apparatus. Dearborn Drug & Chemical Works, Chicago.  
Kennicut Water Softener Co., Chicago.

Wheels and Axles. American Car Co., St. Louis.  
Brill, The J. G., Co., Philadelphia.  
Griffin Wheel Co., Chicago.  
Kuhlman, The G. C., Car Co., Cleveland.

Lorain Steel Co., Philadelphia.  
McGuire-Cummings Mfg. Co., Chicago.  
Marshall, R. W., & Co., 95 Liberty St., New York.  
Railway Steel-Spring Co., New York.  
St. Louis Car Co., St. Louis, Mo.  
St. Louis Car Wheel Co., St. Louis.  
Standard Steel Works, Philadelphia.  
Stephenson, John, Co., Elizabeth, N. J.  
Wason Mfg. Co., Springfield, Mass.

Wheel Grinders. Wheel Truing Brake Shoe Co., Detroit, Mich.

Whitewashing Machines. Wallace Supply Co., Chicago.

Window Fixtures. Drouvé, The G. Co., Bridgeport, Conn.

Wiping Rags. Hagy, J. Milton, Waste Wks., Philadelphia, Pa.

Wire, Aluminum. Aluminum Co. of America, Pittsburg, Pa.

Wire, Insulated. Aluminum Co. of America, Pittsburg, Pa.  
American Electrical Works, Providence, R. I.  
General Electric Co., Schenectady, N. Y.  
Okonite Co., Ltd., 253 Broadway, New York.  
Standard Underground Cable Co., Pittsburg, Pa.  
Stuart-Howland Co., Boston.

Wire and Cables. Aluminum Co. of America, Pittsburg, Pa.  
American Electrical Works, Providence, R. I.  
Bridgeport Brass Co., Bridgeport, Conn.  
General Electric Co., Schenectady, N. Y.  
Okonite Co., Ltd., 253 Broadway, New York.  
Standard Underground Cable Co., Pittsburg, Pa.

**TROLLEY WIRE, BARE COPPER CABLES**  
**WEATHERPROOF WIRE AND CABLES**  
RUBBER COVERED CABLES AND LEAD COVERED UNDERGROUND CABLES FOR ANY SERVICE. WRITE US FOR SPECIAL PRICES AT THIS TIME  
**STANDARD UNDERGROUND CABLE CO.**  
Pittsburg New York Boston St. Louis San Francisco Chicago  
Philadelphia Los Angeles Atlanta

**PNEUMATIC TOOL**  
**AIR BRAKE**  
**and FIRE** **HOSE**  
**GUILFORD S. WOOD**  
ELECTRIC RAILWAY NECESSITIES  
Great Northern Bldg., Chicago

**Ring in the Old**  
**Don't Buy the New**

1	Get a can of ARMALAC and go after that rotten or burned out armature according to directions — you will save money.	1
8		9
9	Sample for the asking to street railways and manufacturing electric companies.	0
2	SEND FOR OUR BOOKLET ANYWAY.	8

**MASSACHUSETTS CHEMICAL CO.**  
Walpole, Mass.

**Motor Packing Waste**

It is free from dirt and grit, holds the oil better and is easier to pack than ordinary waste.  
One packing of the journal box will last longer than with other waste. Used by leading traction companies and electric motor manufacturers.

All grades of white and colored wiping waste, also sanitary cleaned wiping rags. Samples submitted.

**The J. Milton Hagy Waste Works**  
INCORPORATED  
433 Spruce St. Philadelphia

**THE BABCOCK & WILCOX COMPANY**  
85 Liberty Street, New York

Babcock & Wilcox — Stirling — A & T Horizontal — Cahall Vertical

**WATER TUBE STEAM BOILERS**

Works: Bayonne, N. J. Barberton, Ohio.

BRANCH OFFICES:

<b>STEAM SUPERHEATERS</b>	<b>MECHANICAL STOKERS</b>
---------------------------	---------------------------

BOSTON, Delta Bldg.  
PHILADELPHIA, 1110-1112 North American Bldg.  
SAN FRANCISCO, 63 First Street  
PITTSBURGH, Farmers Deposit Nat. Bank Bldg.  
NEW ORLEANS, 345 Baronne St.

DENVER, 410 Seventeenth St.  
SALT LAKE CITY, 313 Atlas Block  
WASHINGTON, Colorado Building  
CHICAGO, Marquette Bldg.  
ATLANTA, Ga., 112 Candler Bldg.

CLEVELAND, 706 New England Bldg.  
MEXICO CITY, 7 Avenida, Juarez  
HAVANA, CUBA, 116 1/2 Calle de la Habana  
LOS ANGELES, 321 Trust Bldg.  
CINCINNATI, O., Traction Bldg.

# Hart Convertible CONSTRUCTION BALLAST and GONDOLA **CAR**

A Center-Dump, Side-Dump and  
Flat-Bottom Gondola-All in One

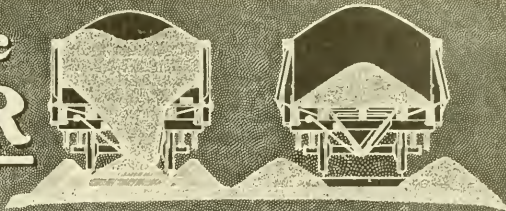

Diagonal shading shows position of ballast after being spread by the  
Rodger Distributing Car which follows the hopper cars

**Rodger Ballast Car Co. Railway Exchange, CHICAGO.**

## Steel Passenger Cars and Trucks

For Steam and Electric Railways

Steel and Composite Freight Cars for all Classes of Service

# Pressed Steel Car Co.

Offices: PITTSBURGH, NEW YORK, CHICAGO, ATLANTA, ST. LOUIS, MEXICO CITY, SYDNEY, N. S. W.

## FOR SALE. FOR QUICK DELIVERY

**6 55-ft. Passenger, Baggage  
and Smoking Car Bodies**

Main Compartment 26' 0"  
Smoking " 10' 6"  
Baggage " 10' 0"  
Seating Capacity, 54

**8 60-ft. Passenger, Baggage  
and Smoking Car Bodies**

Main Compartment 28' 6"  
Smoking " 11' 0"  
Baggage " 8' 0"  
Seating Capacity, 58

**5 52-ft. Passenger and  
Smoking Car Bodies — Double  
End**

Seating Capacity, 60

**3 52-ft. Passenger and  
Baggage Car Bodies — Double  
End**

Seating Capacity, 56

**2 50-ft. Express Car Bodies**

*Write or wire us for further information.*

**The Jewett Car Co. Newark  
Ohio**

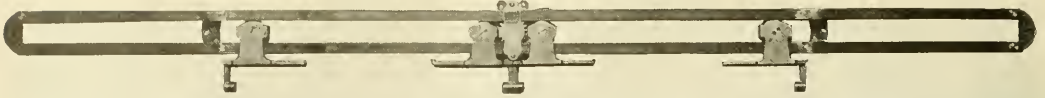

# The "WALLACE" Double Door Fixture

"The best thing that has yet been brought out for operating simultaneously two doors in opposite directions"

¶A traction man said this—and he knew just what he was talking about, for he had had experience with the "Wallace" and with others. ¶You ought to know how satisfactory the "Wallace" Fixture is to passengers and to the management. ¶Just send for Bulletin No. 3, please.

26 CORTLANDT ST.  
NEW YORK

**WALLACE SUPPLY COMPANY**

19 S. JEFFERSON ST.  
CHICAGO 3



## THE "ANTI-PLUVIUS" SKYLIGHT

Lets in all the light.  
Keeps out all rain and dust.

It has so many points of superiority that one small space cannot tell of them all.

Over 3,000,000 square feet in use is **proof** of goodness.

We would like to have the opportunity of demonstrating our claims.

☛ Anti-Pluvius Skylight as used in Train Shed of new Hoboken Terminal.

It is a pleasure to send catalogues and furnish estimates. Let us hear from you.

**G. DROUVE COMPANY, Bridgeport, Conn.**

Western Office, 40 Dearborn Street, Chicago.

# Brown Hoist Electric Locomotive

**CRANES** DO VALUABLE SERVICE IN LIFTING AROUND  
POWER STATIONS AND CAR HOUSES

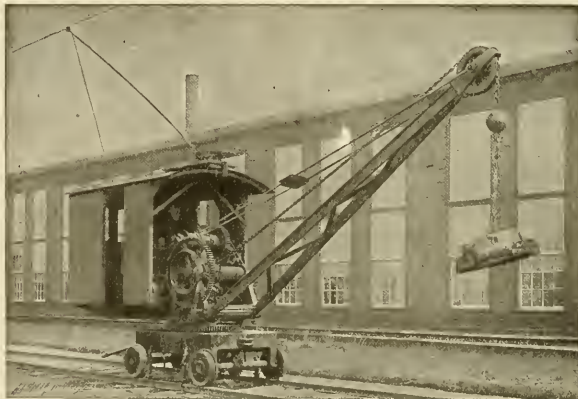

EVERY SORT OF. HOISTING APPARATUS IS SHOWN IN OUR CATALOGUE

## THE BROWN HOISTING MACHINERY CO.

HAVEMEYER BLDG., NEW YORK

CLEVELAND, OHIO

FRICK BLDG., PITTSBURG, PA.



# The Blake Signal System

## Increases Safety of Operation

It is easy to change meeting points on high-speed interurban roads using the Blake Signals, and it is not possible for train crews to run by new meeting points (except through gross and inexcusable negligence)

—because, after having given the order in the usual manner, the dispatcher sets a semaphore and red light at the meeting place.

Another strong safety point is that the dispatcher can stop a train crew at any signal point they are approaching and give them orders.

Economical to install and to operate.  
Ask for descriptive pamphlet, please.

**Blake Signal & Manufacturing Company**  
246 Summer St. Boston, Mass.



INSURE YOUR LINES  
by using our guaranteed

HIGH TENSION  
**INSULATORS**



We make them in all sizes for all classes of service.

Send for circulars and prices

# Special Work for Street Railways

Switches  
Mates  
Frogs



and Crossings  
with Hard  
Steel Centers

Cast Weld Compromise Rail

Barbour - Stockwell Co., 205 Broadway, Cambridgeport, Mass.

# WHARTON SPECIAL TRACK WORK

OF EVERY DESCRIPTION  
FOR ALL CLASSES OF SERVICE

**WM. WHARTON JR. & CO.**  
INCORPORATED.  
PHILADELPHIA, PA. JENKINTOWN, PA.

MANGANESE  
STEEL  
TRACK WORK  
IS OUR SPECIALTY

Every man who ought to know the difference between correct and incorrect operation of electric cars should have

# "The Motorman and His Duties"

BY  
LUDWIG GUTMANN  
CONSULTING ELECTRICAL ENGINEER

SIXTH EDITION REVISED AND ENLARGED BY  
LAWRENCE E. GOULD  
EDITOR ELECTRIC RAILWAY REVIEW

This is the standard handbook on the theory and practice of electric car operation. A glance at the contents, here shown, will give a slight idea of the comprehensiveness of the work.

The revised, enlarged and improved sixth edition is now ready. It has 200 pages; 138 illustrations; three folding sheets of charts and diagrams; cloth binding.

Price, \$1.50 per copy, prepaid.

*Send for 16-page pamphlet containing sample pages, etc.*

## CONTENTS

CHAPTER	PAGE
CHAPTER I	
A GLANCE OVER THE ROAD.....	1
CHAPTER II	
PRINCIPLES OF THE ELECTRIC MOTOR..	10
CHAPTER III	
GENERATING AND DISTRIBUTING POWER .....	23
CHAPTER IV	
OVERHEAD CIRCUIT AND THIRD RAIL..	39
CHAPTER V	
THE ELECTRIC RAILWAY MOTOR.....	52
CHAPTER VI	
CAR WIRING AND PARTS.....	74
CHAPTER VII	
CONTROLLERS .....	92
CHAPTER VIII	
MULTIPLE-UNIT CONTROL.....	116
CHAPTER IX	
OPERATION OF CONTROLLERS .....	129
CHAPTER X	
BRARES AND THEIR OPERATION.....	140
CHAPTER XI	
HOW TO REMEDY TROUBLES.....	175
GLOSSARY.....	187

**The Wilson Company** 160 Harrison Street  
Chicago



# The Motorman Behind This Headlight



This is the Plain Arc Headlight

Made in 14-inch. Ask about the Combination Arc and Incandescent Headlight.

can see a car approaching from the opposite direction ***much sooner*** than he would be able to see either the reflected or direct rays of an ordinary headlight.

**Reason:** Because of the peculiar construction of the *Climax Headlight* a portion of the reflected rays of light is projected upward, while its most powerful light is thrown ahead.

**Result:** Safer operation and a great reduction in the probability of accident.

WRITE TODAY FOR CATALOG

TROLLEY SUPPLY COMPANY :: :: Canton, Ohio

## Girder Rail Benders

THIS rail bender is made in two sizes and will bend any section of rail now on the market. These tools are all portable and mounted on wheels.

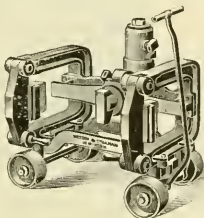

*Our tools thoroughly guaranteed*

**THE WATSON-STILLMAN CO.**

26 Cortlandt Street, New York City  
Branch Office, 453 The Rookery, Chicago, Ill.



Factory of The Milloy Electric Company  
Bucyrus, Ohio

## The Milloy Trolley Base

built in our new and specially equipped factory, insures a quality which will give excellent service under ordinary and extraordinary conditions.

The Milloy Base is unusually low, has even tension on high or low wire. Has no fulcrum, no friction, no oil, no center post. Always efficient. Particulars on request.

**THE MILLOY ELECTRIC COMPANY**  
Bucyrus, Ohio

# The Macallen Company

Formerly The W. T. C. Macallen Co.



**Electric Railway Material**



**Brass Founders**



Foundry and Division Streets, BOSTON, MASS.

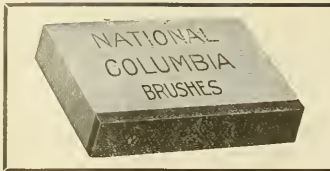

**COLUMBIA** CARBON BRUSHES wear smooth, take a high polish and will outlast any other long life brushes made, with less wear on commutator. : : :

**NATIONAL CARBON CO. Cleveland, Ohio**

**"THEY NEVER PULL UP"**

**MILLER ANCHOR CO., Norwalk, Ohio**  
ELECTRIC SERVICE SUPPLIES CO., Chicago Agents

**AS IT HOLDS**

**Jobbers who publish a new catalogue should have one of our cuts.**

**THE ATLAS ANCHOR CO., Cleveland, Ohio**



**BALDWIN LOCOMOTIVE WORKS**  
BURNHAM, WILLIAMS & CO., PHILADELPHIA, PA., U. S. A.

Builders of **LOCOMOTIVES OF EVERY DESCRIPTION**  
Including **ELECTRIC LOCOMOTIVES** and

**ELECTRIC TRUCKS**

**STANDARD STEEL WORKS, HARRISON BUILDING PHILADELPHIA, PA.**  
**SOLID FORGED ROLLED AND STEEL TIRED WHEELS** ELLIPTIC AND COIL SPRINGS  
mounted on axles and fitted with Motor Gears for Electric Railway Service

Truck built for Indianapolis, New Castle & Toledo Electric Railway Company.

**PIPE FITTINGS AND VALVES**  
FOR THE HEATING AND PLUMBING TRADE

TRADE MARK

**JOHN SIMMONS CO.**  
104-110 Centre Street, NEW YORK

**THE LORAIN STEEL COMPANY**

**Girder Rails and High Tee Rails**  
**High-Grade Special Track Work**

GENERAL OFFICE  
THE PENNSYLVANIA BUILDING, PHILADELPHIA, PA.

# STEEL WOOL JOURNAL PACKING

- saves one-half the packing
- saves one-third the oil
- saves labor and wear
- prevents hot boxes **positively**

No other packing you ever heard of can do these things!

*Send today for free sample*

**WM. ROBERTSON & COMPANY**

General Office: Grant Northern Bldg., CHICAGO  
Factory: 75 S. Jefferson St., BATTLE CREEK, MICH.

9

One road writes as follows:

"All doubts that we had in the beginning about the merits of your

## Whitmore's Gear Protective Composition

have been thoroughly removed. The results from the use of this material are far beyond our expectations. You are entitled to great success."

We are in position to do the same thing for you.

**The Whitmore Manufacturing Company**  
CLEVELAND, OHIO, U. S. A.

1

# The Signal System

that prevents accidents  
facilitates traffic and  
promotes adherence to  
schedules

is made by the

**TELEGRAPH SIGNAL COMPANY**

282 State Street, - - - Rochester, N. Y.

4



# 10c per day

will heat that car if you use  
a COOPER HEATER

Ask for descriptive matter

The Cooper Heater Co., Dayton, Ohio

9

## "Not an Experiment"

The Providence Fender has been in successful operation on hundreds of roads for 13 years, and has proved itself reliable under all conditions of Street Railway service.

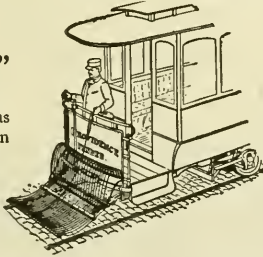

**CONSOLIDATED CAR FENDER COMPANY**

Office and Factory: PROVIDENCE, R. I.

Branch Office: 110 E. Twenty-third St., New York

European Agents: Comptoir d'Electricite, 6, Rue Boudreau, Paris, France



Established 1877.



## ALBERT & J. M. ANDERSON MFG. CO.,

Makers of

**ELECTRICAL APPLIANCES:  
SWITCHES, SWITCHBOARDS,  
TIME SWITCHES, LINE MATERIAL,  
COPPER CASTINGS (75%) CONDUCTIVITY.  
289-293 A ST., BOSTON, MASS., U. S. A.**

Branches:

New York, 135 Broadway.

Chicago, 175 Dearborn Street.

Agencies:

Boston, Pettingell-Andrews Co.

San Francisco, Eccles & Smith Co.

New York, R. W. Marshall & Co.

Atlanta, Newcomer Manry Co.

St. Louis, J. C. White.

Denver, E. M. Measiter.

Toronto, Ont., H. J. Surtees.



# ALUMINUM

## Railway Feeders

And all kinds of **Electrical Conductors**

Aluminum Feeders are less than one-half the weight of copper feeders and are of equal conductivity and strength. If insulated wire or cable is required, high grade insulation is **guaranteed**.

*Write for prices and full information.*

**Aluminum Company of America**

PITTSBURGH, PA.

Formerly The Pittsburgh Reduction Company

## WAKEFIELD CAR SEATS

We make everything necessary to seat a car of any description. Our line includes Reversible seats of both the Slideover and Turnover types for Steam and Electric service, as well as the only practical Double Revolving seat on the market.

Our Longitudinal Spring Seating is unequalled for superiority of workmanship and durability.

We also carry a large variety of Rattan Chairs for Parlor and Observation Cars.

**Heywood Brothers & Wakefield Company**

New York, N. Y.



Wakefield, Mass.

# CLASSIFIED ADVERTISEMENTS

Undisplayed advertisements are inserted under this heading at the uniform rate of one cent a word; minimum charge twenty-five cents. Replies directed to this office will be forwarded when required to any address in the United States, Canada or Mexico without extra charge. Advertisements received at the Chicago office by 9 a. m. Thursday will appear in the issue for the same week.

## POSITIONS WANTED.

A young man, 27 years of age, with ten years' experience, wants position as engineer or electrician, unmarried; habits strictly temperate; high-class references. Address "No. 710," care Electric Railway Review, Chicago.

Position wanted by a young man (23) of good habits; have been connected four years with the operating and purchasing departments of an electric street railway company; can give good references. Address "No. 528," care of Electric Railway Review, Chicago.

Position as chief electrician or superintendent; 16 years' experience lighting, power and traction work, alternating and direct current; graduate of well-known school; excellent testimonials; disengaged. Address "No. 529," Electric Railway Review, Chicago.

Auditor, experienced in electric railway and lighting and construction accounting, wants position with fair-sized company. Energetic and good systematizer. Best references. Address "No. 527," care of Electric Railway Review, Chicago.

Position by a single man, 29 years old, practical electrician and machinist, 10 years' experience, familiar with electric car and locomotive repairs, power and substation practices. Non-union man. Address "No. 630," care of Electric Railway Review, New York, N. Y.

## POSITIONS WANTED.

Graduate civil engineer, Cornell University 1902, experienced in field work and trade journalism, now engaged, desires work with technical journal or publicity department of manufacturing establishment. Address "No. 525," care of Electric Railway Review, Chicago.

Experienced and efficient engineer with power station experience (both planning and construction, as chief engineer and as superintendent of construction) desires position with operating company as engineer, assistant to manager or superintendent. Address "No. 515," care of Electric Railway Review, Chicago.

Young man, 30 years of age, who has nearly completed a course of "Electric Lighting and Railway" in the International Correspondence Schools, desires position which will give him practical experience in power house and switchboard work. Willing to start at a nominal salary. Address "No. 526," care of Electric Railway Review, Chicago.

## MISCELLANEOUS WANTS.

You can sell second-hand cars, machinery and material through advertising on this page. Ask about the special rates. Electric Railway Review, 160 Harrison Street, Chicago.

## POSITIONS OPEN.

Superintendents, street railway, machine shop, car works, power house, engineers, electrical and mechanical, draftsmen, electrical and mechanical. Salaries, \$800 to \$5,000. Other positions open. Write, HAP-GOODS, 305 Broadway, New York, or 1010 Hartford Bldg., Chicago.

## BOOKS AND PUBLICATIONS.

Ask us about any book on electric railway and allied subjects. We publish some and sell all that are in print. The Wilson Company, 160 Harrison Street, Chicago.

Wanted—Copy of the Electric Railway Review of January 12, 1907, in good condition. State price in your answer. Address "No. 530," care of Electric Railway Review, Chicago.

We want your friends to read the Electric Railway Review. You will do them—and us—a favor by sending their addresses. We will gladly mail free sample copies. Electric Railway Review, 160 Harrison Street, Chicago.

A copy of "The Motorman and His Duties," the standard handbook on the theory and practice of electric car operation, is worth many times its cost to every man interested in the subject. Send for 16-page pamphlet of sample pages. The Wilson Company, 160 Harrison Street, Chicago.

## BOOKS AND PUBLICATIONS.

If interested in any phase of steam transportation, you will find every development covered fully and accurately in The Railway Age. It is the leader and acknowledged authority in this field. Ask for free sample copies. The Railway Age, 160 Harrison Street, Chicago.

If you have copies of the Street Railway Review of February or June, 1906, or of the index for 1904, or of the Electric Railway Review of October, 1906, write us at once, stating condition and naming price for each copy. Address "No. 514," care Electric Railway Review, 160 Harrison street, Chicago.

National Legislation on Interstate Commerce to July 1, 1906, is fully covered in our reference pamphlet. It contains the full text of the act to regulate commerce as amended, including the Elkins and Hepburn acts, and of the supplementary act relating to the testimony of witnesses before the interstate commerce commission. It also contains the texts of the expedition act, the anti-trust act of 1890, the employers' liability act and the safety equipment laws. Difference in type shows the parts expunged from, and the parts added to, the interstate commerce and Elkins acts by the Hepburn act. This pamphlet is of special value to railway men and lawyers. Mailed prepaid for 25 cents in stamps or coin. Special prices for quantities. The Wilson Company, 160 Harrison St., Chicago.

## Two Kinds of Effective Advertising at Small Cost

### Want Ads

Useful in securing a position, or a man to fill it, and for many other purposes. One cent a word per insertion—minimum charge, twenty-five cents. Replies forwarded without charge to points in the United States, Canada and Mexico.

### For Sale Cards

Second-hand equipment, tools, machinery, etc., are best brought to the attention of possible buyers by using "For Sale" cards. Rates are very low, ranging from 60 cents to \$1.20 an inch per insertion, depending upon amount used.

*More publicity for less money than from any other medium!*

# ELECTRIC RAILWAY REVIEW

160 Harrison Street, Chicago

# RE-ENFORCED SPOKE WHEELS

For City and Suburban Cars

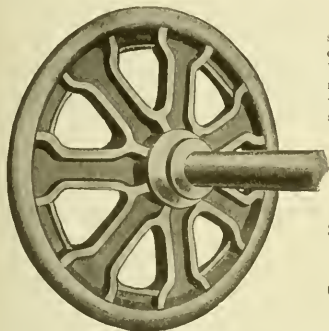

This wheel is being substituted in place of the Old Style Plate Wheel because it does not rattle and roar when on paved city streets.

The only spoke wheel for Heavy High Speed Service.

Stronger Spokes  
Stronger Flange  
Deep, Even Chill  
Greater Mileage  
Absolute Safety

A Sample Order Will Prove Its Superiority Over the Old Style Spoke Wheel

WRITE FOR BOOKLET ON WHEELS

**ST. LOUIS CAR WHEEL CO.**  
ST. LOUIS, MO.

**R.W. MARSHALL & CO.**  
95 and 97 Liberty St., New York  
Second-Hand Machinery and Equipment  
**ELECTRIC RAILWAY MATERIALS**

**RAILS**  
*Locomotives, Cars, Etc.*  
Bought & Sold  
Walter A. ZELWICKER Supply Co.  
IN ST. LOUIS

**FOR SALE CHEAP!**  
One 14x22 eight-wheel locomotive  
Ten 34-foot 50,000 capacity flat cars  
Two Greenleaf turntables  
70 box cars, 40 s'x 50,000 capacity  
80 Good Second-hand Bridges  
Specifications and Blue Prints on application  
**F. A. JOHANN**  
1624 Pierce Bldg., St. Louis, Mo.

**ROSSITER, MACGOVERN & CO. (Inc.)**  
90 West Street, New York  
**ENGINES** Boilers, Locomotives, Cars,  
**GENERATORS** 2nd Hand  
Transformers, Railway, A. C. & D. C. **MOTORS**

**SPEER HIGH GRADE BRUSH**  
St. Marys - Pa.

## THE MIGHTY MIDGET HOT WATER CAR HEATER

Adapted for Large Electric Cars and Long Distance Lines. Exclusively used on Largest Electric Systems. Ask for Catalog  
**THE WILLIAM C. BAKER HEATING & SUPPLY CO.,** 143 LIBERTY STREET NEW YORK



## NILES CARS

(The Electric Pullmans)

LARGE, FAST INTERURBANS  
OUR SPECIALTY

**Niles Car & Mfg. Co.**

Works: NILES, OHIO

Sales Office: J. A. HANNA CO.  
312 Electric Bldg., Cleveland, Ohio

Avoid Accidents

By Using This Switch

SPECIAL TRACK WORK OF EVERY DESCRIPTION

**New York Switch & Crossing Co.**

HOBOKEN, N. J.

## Anti-Straddling or Anti-Kicking Tongue Switch



It will not drive down at the heel, because it is held to either side with a spring tension and firmly down on its bed. A car can not straddle this tongue.

WRITE FOR SPECIAL CIRCULAR

# The Lindsley Brothers Company

Producers and Shippers of and Manufacturers of

## WESTERN CEDAR POLES RED FIR CROSS ARMS

Eastern Sales Office, Monadnock Bldg., CHICAGO SPOKANE, WASHINGTON

## ELECTRIC BLUE PRINTING MACHINES

J. H. WAGENHORST & CO., Youngstown, Ohio  
Largest Manufacturers of Blue Printers in the World  
WRITE FOR CIRCULAR "I"

**G. H. BARNES HARDWOOD LUMBER CO.**  
Office and Yard: Main and Warren Sts., ST. LOUIS, MO.  
Ties, Car Oak, Poplar, Ash, Cherry, Plain and Quartered Oak

**HEINE SAFETY BOILER CO.**  
421 OLIVE STREET, ST. LOUIS, MO.  
Manufacturers of WATER TUBE BOILERS

**C. H. WORCESTER CO.**

## CEDAR POLES

PRODUCERS AND WHOLESALEERS

Suite 1710 Tribune Building CHICAGO

## CHESTNUT POLES

Cedar, Oak and Chestnut Ties

FROM OUR OWN TIMBER LANDS

**THE ADVANCE LUMBER CO.**  
CLEVELAND, OHIO

**GREEN FUEL ECONOMIZER CO.**

Sole builders of the Green Fuel Economizer in the United States. Also Fans, Blowers and Exhausters, Steam Heating Coils and the Green Air Heater. Heating, Ventilating and Mechanical Draft Apparatus. Send for Book "SV" on Fuel Economy and Fan Catalogue.

GREEN FUEL ECONOMIZER CO., Matteawan, N. Y.

**40% SAVED**  
BY USING

## Lumen Bronze Axle Bearings

Cast in metal mold—require no-machine finish

**Lumen Bearing Company**  
BUFFALO — TORONTO

We have in our Chicago Yard available for **RUSH SHIPMENTS** a **SELECTED STOCK** of **POLES** and **TIES**

**NAUGLE POLE AND TIE CO.**  
Chicago Office, 226 La Salle Street

# Idaho Cedar Poles

PACIFIC COAST POLE CO. SPOKANE, WASH.

We are Producers and Wholesale Dealers in Western

## CEDAR POLES

Yards in Washington, Idaho, Montana and British Columbia  
WRITE US FOR DELIVERED PRICES

**CHURCHILL CEDAR CO.,** Box 1409, Spokane, Wash.

## POLES and PILING

20,000 35s and 40s  
Ready to Ship at Once

**S-E. Missouri Cypress Co.,** Campbell, Mo.

**BERTHOLD & JENNINGS**  
LUMBERMEN'S BLDG. SAINT LOUIS, MO.

**TIMBERS**  
L. L. Pine, Oak

**POLES**  
Cedar, Cypress, Chestnut

**TIES**  
Oak, Cypress, Chestnut

**WHITE CEDAR**

**P O L E S**

Large Stock 14 to 65 ft.  
**Prompt Shipment**

**YARDS:**  
Menominee, Mich.  
EsCANABA, Mich.  
Superior, Wis.  
Deer River, Minn.

**FRANCIS BEIDLER & CO.**  
Chicago, Ill.

# THE BOILERS WILL BE OUT OF SERVICE

a much shorter time for washing, thereby requiring very much less labor, to say nothing of the saving in fuel and the increased efficiency of the boilers, if the incrusting solids and other deleterious salts in the water are acted upon by **Dearborn Compounds** and their injurious properties destroyed. Send us gallon sample of your feed water for analysis.

## Dearborn Drug & Chemical Works

WM. H. EDGAR, FOUNDER

299 BROADWAY, NEW YORK      POSTAL TELEGRAPH BLDG., CHICAGO

### WESTON Standard Portable Direct-Reading

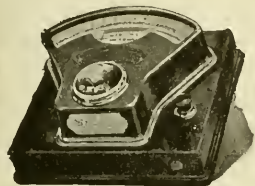

Voltmeters  
Millivoltmeters  
Voltammeters  
Ammeters  
Milliammeters  
Ohmmeters  
Ground Detectors  
and Circuit Testers

Our STATION VOLTMETERS and AMMETERS are unsurpassed in point of extreme accuracy and low-est consumption of energy.

### WESTON ELECTRICAL INSTRUMENT CO.

Main Office and Works: Waverly Park, Newark, N. J.

London Branch: Audrey House, Ely Place, Holborn, Paris, France; E. H. Cadot, 12 Rue St. Georges, New York Office: 74 Cortlandt St. Berlin: European Weston Electrical Instrument Co., Ritterstrasse, No. 88.

### Queen Testing Sets

"The Recognized Standard"

Voltmeters  
Ammeters  
Switchboard and Portable  
Alternating and Direct Current



Queen Acme Testing Set

U. S. Standard Testing Sets  
Rail Bond Testers  
Galvanometers, etc., etc.  
Electrical Instruments for All Purposes

QUEEN & CO., Inc., Philadelphia, Pa.

### Coach and Car Roof Paint

"Metal" Canvas Preserver—Priming Coat  
"Metal" Canvas Roof Paint—Other Coats



ST. LOUIS SURFACER & PAINT COMPANY  
St. Louis, U. S. A.

## HOPE TAPES AND WEBBINGS

ARE THE BEST

WRITE FOR SAMPLES AND PRICES

HOPE WEBBING CO., Providence, R. I.



### PATTEN TICKET DESTROYER

Don't burn your used tickets. Destroy them, and avoid fraud. Remember, it is difficult to get a man to destroy anything of value to him.

Sell the old stock—it will soon pay for machine. In use on the Boston & Northern R. R., Old Colony St. Ry. Co., Brockton St. Ry. Co., Waterbury El. Co., Bridgeport Traction Co., Buffalo Ry. and others. Write for circular.

PAUL B. PATTEN

78 Lafayette Street • SALEM, MASS., U. S. A.



(End View)

Has adjustable steel noses—suitable for general urban and light interurban service. The most efficient low priced electric snow-plow on the market.

### The RUSSELL Pedestal Electric Snow-Plow No. 6

Further information on request—also catalog electric snow-plows

RUSSELL CAR & SNOW-PLOW COMPANY, Ridgway, Pa.

Wendell & MacDuffie, Cortlandt St., New York—Eastero Sales Agents; Robison & Cary Co., St. Paul, Minn., C. A. Ralston, Fisher Bldg. Chicago, Ill.—Western Sales Agents; Dominion Supply Co., Winnipeg, Manitoba—Western Canada Sales Agents.

INSULATING  
VARNISHES  
(BAKING; AIR-DRYING)  
COMPOUNDS  
TAPE



Possess the Highest Insulative Efficiency.

The Standard Paint Co.  
100 William St.  
New York.

**HELP** of any kind is easily and quickly secured by advertising in the Electric Railway Review. One cent a word per insertion.

## Electric Railway Material

of every description

F. P. HARRISON ELECTRIC & MFG. CO.

169-170 South St.

(Incorporated)

NEW YORK

**THE ARNOLD COMPANY**

ENGINEERS—CONSTRUCTORS  
ELECTRICAL—CIVIL—MECHANICAL  
181 LA SALLE STREET  
CHICAGO

**H. M. Bylesby & Company**

Incorporated

ENGINEERS

American Trust Bldg., Chicago

Design, Construct and Operate  
Railway, Light, Power and  
Hydraulic Plants

EXAMINATIONS AND  
REPORTS

**J. G. WHITE & COMPANY**

INCORPORATED

**Engineers, Contractors**

43-49 Exchange Place,  
41-43 Wall Street

New York, N. Y.

Principal Philippine Office: Manila, P. I.

**Ford, Bacon & Davis,**

Engineers,

115 BROADWAY,  
NEW YORK.

**COLUMBIA CONSTRUCTION CO.**

BUILDERS OF

**Electric Railways**

Colby and Abbot Building : MILWAUKEE, Wis.

**VALVES—FITTINGS—STEAM SPECIALTIES**

**CRANE CO.**

CHICAGO

ESTABLISHED 1855

**STONE & WEBSTER ENGINEERING  
CORPORATION**

**CONSTRUCTING ENGINEERS**

147 MILK STREET, BOSTON

ELECTRIC RAILWAY, LIGHT & POWER PLANTS  
WATER POWER DEVELOPMENTS

**A. L. REGISTER & CO.**

Engineers and General Contractors—Electric Railways  
112 North Broad St. PHILADELPHIA, PA. Established 1889

**CENTRAL INSPECTION BUREAU**

Inspection of Rails, Ties, Cars, Motors, Bridges, Buildings, Etc.  
17 STATE STREET - - - - NEW YORK CITY

**SMITH CONCRETE MIXER**

does the work better, quicker, cheaper and lasts longer.  
CONTRACTORS' SUPPLY & EQUIPMENT COMPANY  
Old Colony Building, Chicago 170 Broadway, New York 9

**LINE MATERIAL**

ELECTRIC SUPPLIES FOR RAILWAYS, POWER PLANTS, ETC.  
THE CREAGHEAD ENGINEERING CO., 346 Main Street, Cincinnati, Ohio

WRITE TO **MODEL STOKER COMPANY** DAYTON OHIO

for detailed information about the best  
**AUTOMATIC SMOKELESS FURNACE**

SPRINGS—TIRES—STEEL-TIRED WHEELS

**RAILWAY STEEL-SPRING CO.**

General Offices: 71 Broadway, New York

**WHEEL TRUING BRAKE SHOES**

Repair Crippled Wheels While Running  
THE WHEEL TRUING BRAKE SHOE CO., Detroit, Mich.

**Gongs** For Street Cars **Bells**

G. C. REITER, Canton, Ohio

**THE CURTAIN SUPPLY CO.**

CAR CURTAINS  
CHICAGO, 85-93 Ohio Street 1819 Park Row Bldg., NEW YORK

**BRAKESHOOES**

STANDARD  
BRAKESHOE COMPANY  
GEN'L OFFICES & WORKS - AURORA, ILL. CHICAGO OFFICE: 315 IVY EXCH.

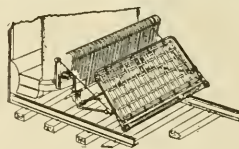

**ECLIPSE  
Life Guard**

Manufactured by the  
ECLIPSE RAILWAY SUPPLY CO.  
Cleveland, Ohio

**ENGINEERS**

who wish to be numbered among the  
elect should be represented on this page

The cost is small—ask us about it

**ELECTRIC RAILWAY REVIEW**

160 Harrison Street, Chicago



# Gasoline Motor Cars for Street Car Service

Can be used advantageously for owl car service and on branch lines of large railroads where the passenger traffic does not warrant the maintenance of a regular train schedule.

Address R. R. Dept. No. 757MS

**Fairbanks, Morse & Co.**  
CHICAGO, ILLINOIS



## THE EARLL RETRIEVERS

Perfect in design and construction. Absolute protection to poles and overhead work. Easy to maintain and convenient to operate.

Send for 20-Page Catalogue.

**C. I. EARLL**, Bowling Green Bldg., NEW YORK

## THE PETER SMITH HEATER CO.

The Pioneer Manufacturers of HOT WATER HEATERS for City and Interurban Cars. OFFICE AND WORKS: DETROIT, MICH.

## THE NATIONAL LOCK WASHER CO., NEWARK, N. J.

Curtains - Curtain Fixtures - Sash Locks - Sash Balances - Nut Locks

CHICAGO OFFICE: 419 MONADNOCK BLOCK

## TRACKLAYING BY MACHINERY

SIMPLE, RAPID AND ECONOMICAL

D. F. HOLMAN RAILWAY TRACKLAYER CO., 1102 Ellsworth Bldg., Chicago

## SHIMER & CHASE CO.

Experienced Promoters of Electrical Railway Projects  
Correspondence Solicited OMAHA, NEB.

## ELECTRIC HEATERS For All Classes of Cars

New York Consolidated Car-Heating Co. Chicago

## GRIFFIN WHEEL CO.

CHICAGO

CHILLED IRON CAR WHEELS IRON OR STEEL AXLES



## E. C. Van Valkenburgh

Promotional Advertising for Electric Railways  
2117 West 102d St.  
CHICAGO

Reduce your operating expenses by increasing your passenger mileage - ADVERTISE.



Have you our New Bulletin No. 8?  
ASK US

## GENERAL STORAGE BATTERY CO.

General Offices: 42 Broadway, N.Y.  
Works: Bannock, N. J.



## High Grade Caps

for street railway men. Our prices will interest all who wear caps. Send for Electric Railway Uniform catalog.

The Henderson-Ames Co.  
Kalamazoo, Mich.

The Recording Fare Register Company



New Haven, Conn.



CONTINUOUS JOINT

Over 25,000 miles in use



WEBER JOINT

Rolled from Best Quality Steel



WOLHAUPTER JOINT

Catalogs at Agencies  
Baltimore, Md. Portland, Ore.  
Boston, Mass. Seattle, Wash.  
Chicago, Ill. St. Paul, Minn.  
Denver, Colo. St. Louis, Mo.  
Pittsburg, Pa. Troy, N. Y.  
London, Eng. Montreal, Can.  
HIGHEST AWARDS—Paris, 1900;  
Buffalo, 1901; St. Louis, 1904

Additional safety and economy in Track Maintenance has been proved by the use of Continuous, Weber and Wolhaupter base-supported rail joints—after ten (10) years' service, having a record of over 25,000 miles in use—the extent of which is evidence of their excellence.

## THE RAIL JOINT COMPANY

General Offices: 29 West 34th Street, New York City  
Makers of Rail Joints for Standard and Special Rail Sections, also Girders, Sleep or Compromise, and Insulating Rail Joints, protected by patents in United States and Foreign Countries.

## PAINTS FOR METAL SURFACES

Elastic and water-proof. Will not crack or peel. Require no thinning. Prepared ready for application. Send for color card.

**Detroit Graphite Company**

DETROIT, MICH.

Dept. S.



## NORTHERN CRANES

Have you coal and ash handling problems? Let us help solve them. Let us also build your power station cranes.

Catalogs free

**NORTHERN ENGINEERING WORKS.** DETROIT, MICH.

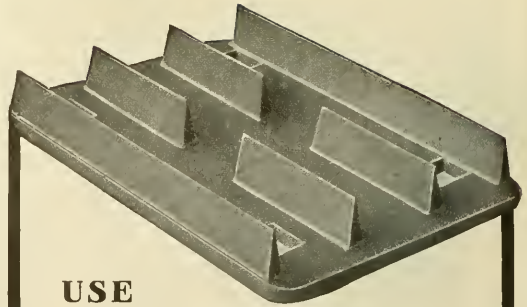

USE

## BEAVER DAM MALLEABLE IRON TIE PLATES

Best for all electric railways and so proven by years of service.

Ask us to tell you why

**Beaver Dam Malleable Iron Co.**

BEAVER DAM, WISCONSIN

5

Experience of many traction companies has proved that the average cost of rail bond installation with this car is

## 12 Cents per Bond

and that the saving in cost over installation by pressure is about \$75.00 per mile.

Furthermore, our Electric Brazed and Copper Welded bonds are *better bonds*, both mechanically and electrically.

*Don't believe it without proof—but ask us for that.*

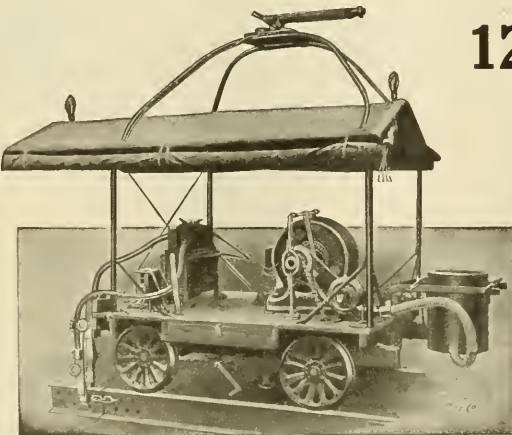

## The Electric Railway Improvement Co.

6005 Carnegie Avenue, Cleveland, Ohio

7

# Electric Railway Review

PUBLISHED EVERY SATURDAY BY THE WILSON COMPANY, CHICAGO

Entered as second-class matter January 5, 1907, at the postoffice at Chicago, Ill., under the act of March 3, 1879.

160 Harrison Street, Chicago  
150 Nassau Street, New York  
1529 Williamson Bldg., Cleveland

VOL. XIX  
No. 2

CHICAGO, JANUARY 11, 1908.

Whole No.  
246

Subscription: Domestic . . . \$2  
Foreign . . . \$5  
Canada . . . \$3.50

Interurban roads connecting large cities with a number of smaller towns may receive a valuable suggestion of a means for promoting their traffic from the Spokane & Inland Empire Railroad of Spokane, Wash. This company, whose enterprising methods of advertising and excellent service have often been described, has for a year past been operating special Saturday night theater trains leaving Spokane at 11:20 p. m., for all points on the Coeur d'Alene division. It took nearly a year to develop the traffic to make such a train pay, but the results have recently proved so satisfactory that on January 1 a similar service was instituted on the Spokane & Inland division. The trains leave the Spokane terminal at 11:30 p. m., and stop at all points south on the Colfax and Palouse branches, whose terminals are each distant about 76 miles from Spokane. The new service was announced by large illustrated postal cards containing a programme of the principal attractions to be presented at the Spokane theaters during the season. Reservations for tickets to any theater in the city may be made through the station ticket agents. The luxurious parlor car equipment used in this service was illustrated in an article in the Electric Railway Review of December 28, 1907, page 977, by Charles E. Flagg, advertising agent of the company.

Five or six years ago the third rail was heralded as the most satisfactory medium for distributing electric current to swiftly moving cars or trains. Now it has a healthy rival, the high-voltage overhead conductor. The growing sentiment for early electrification of steam trunk lines and their feeders continues the rivalry between the two methods of current distribution. Such discussions as occur between upholders of each of the two methods bring forth side lights on the art of railroading. The most recent discussion on "The Third-Rail Problem" is by A. D. Williams, Jr., in the Engineering Magazine for January. This article comprises the discussion of a list of disadvantages of the third rail and includes a terse summary of standardization conditions on steam roads. Our readers know how frequently these same standardization conditions apply to electric roads and how advisable it is to avoid them. In the article mentioned we read: "A peculiar fact in regard to many railroad standards (?) is the number of different standards, the same road having several standards for certain constructions, each in use on separate portions of the line and all out of harmony with one another. This is due to corporate consolidations which have not as yet coalesced throughout. In many cases these out-of-date standards are blindly followed in absolutely new construction, where unbiased consideration and the ability to view matters with a broad perspective would show the futility of clinging to the past and the advantages to be gained by throwing dead wood overboard. Unfortunately, there is sometimes a certain lack of co-operation between the various departments of railroads, each department and sub-department striving for its own individual record without regard for others or for the ultimate result. When such de-

partmental jealousies are rife the interests of the road suffer." As Mr. Williams points out, one of the most difficult problems a railroad about to electrify its track is called upon to solve is the adjustment of clearances.

If tickets are used on a suburban or interurban line that also collects fares according to the zone system, the question of how to devise an adequate check on the tickets sold and collected without imposing too much detail work on the conductor and auditor becomes a problem requiring careful consideration. A new method for accounting for the number of tickets and amount of cash collected by the conductor on an interurban run is described on another page of this issue by S. S. Neff, general superintendent of the Atlantic City & Shore Railroad. On this road the fares are collected by the zone system, either by a cash fare in each zone or by a ticket extending through one or more zones which must be punched in each. The conductor is provided with punching slips, one for cash and another for tickets, on which spaces for each zone are outlined, and as he collects a cash fare or punches a ticket he also punches a number in the corresponding zone on the slip, at the same time recording a fare on the register. The slips must be kept correctly so that they will check with the number of fares registered in each zone, and there is scarcely time in a round trip for a conductor to falsify his records, because he would have to count his tickets and cash in each zone. The fare registers are changed at the end of each zone and the conductor reports at the end of each round trip.

The increase in fares just placed in effect on the Blue Hill Street Railway, near Boston, illustrates a tendency of the times which must soon be dealt with by many other companies operating in purely suburban or rural territory. Every electric railway officer who follows expenditures in any department knows that in the last few years expenses have mounted steadily higher. By the extension of transfer privileges and provision of improved rolling stock the service given to the public has been greatly enlarged and bettered and patrons of the companies receive far more for their money in comfortable and longer rides than they did five or six years ago. This has been brought about by the managements, often in the face of violent and ill-advised agitation. The politicians have very generally overlooked this phase of the situation, and have carefully refrained from telling the public that the costs of electric railway, lighting and power service have been among the very few items lowered in the general cost of living in the last decade. Recent experience on certain suburban and rural lines operating in sparsely settled territory shows that in the face of present costs of maintenance, labor and materials, fares must in some manner be adjusted to the new conditions if ultimate bankruptcy is to be avoided.

The exact method of fare increase must obviously depend almost entirely upon local conditions. Many roads may find it sufficient to omit six or seven tickets for a quarter, when such a tariff obtains. In other cases a shortening of the ride may be the best course, by the reduction of transfers or the actual cutting down of the 5-cent zone. Shortening the fare limit without raising the fare brings in more nickels per mile of track and avoids the annoyance of demanding an extra cent or two from the public. Where competition exists the problem is far more difficult and may require some sort of informal or formal joint agreement before an effective raise can be brought about. There is little doubt that in the past some companies have received unduly hostile criticism because they doubled their rates at a single stroke, instead of increasing them by a cent or two. The convenience of the nickel is indisputable, but in sections of the country where copper coin is still in pretty general circulation there is little doubt that the average passenger would prefer to receive three or four cents in change to paying 10 cents for a trip which formerly cost five. In some cases the sale of four tickets for a quarter will solve the difficulty. In the introduction of higher fares a clear statement of where each part of the nickel goes at present will be helpful in satisfying the public if printed in the cars and also if presented in the newspapers. The necessity of the increase can be shown on a 5-cent basis better than in large totals.

---

#### UNDERHUNG HIGH-TENSION INSULATORS.

---

The transmission of electric currents over long distances and at high potentials is one phase of electrical engineering that recently has made most wonderful strides. It was but a few years ago when the installation of a 50-mile transmission line operating at 30,000 volts pressure was heralded as an important piece of engineering work. Lines having such characteristics are now common on nearly all interurban work, and current from nearly all the greater power undertakings is transmitted at pressures of 60,000 volts and higher.

While it is true that the necessity for higher voltages is greater than it was five or six years ago it is also true that at that time such high transmission pressures could not be utilized. This was not from a lack of desire but because the art of transmission line construction was then not far enough advanced. Generating, transforming and receiving apparatus were to be had, but line insulators were not available which could offer a large enough factor of safety to warrant the utilization of the high voltages now employed.

To those builders of transmission projects who would keep low the transmission losses, there was available suitable electrical machinery but not insulators designed and built with the same degree of scientific exactness. Today these limiting conditions do not hold.

As explained by Walter T. Goddard in a recent paper, "High Voltage Insulator Manufacture," read before the Canadian Society of Civil Engineers on December 19, 1907, it is safe to say that insulators for the heaviest mechanical strains and for the highest electrical stresses can be manufactured at moderate cost. Therefore the limitation of transmitting voltages must at the present time be looked for in other directions than in insulator design, porcelain insulator design in particular. This bold statement is only made possible by the development of the underhung type of the porcelain insulator so lately put into use.

By way of explanation the underhung insulator comprises a number of double-petioated porcelain insulators provided with metal eyes so that they may be suspended in series, one under another.

The unit formation presents a positive advantage in the matter of breakage as well as insulation. After one shell of

a pin type insulator becomes cracked or broken, the whole device is rendered worthless because it is utterly impossible to break apart the cement joint forming the bond between the nested shells of a built-up insulator. In contrast to this the breaking or cracking of one shell or one unit of a suspended type of insulator takes away the insulating value of but that one unit from the series. To illustrate: If one section of a 5-unit 100,000-volt insulator is broken the total strength of the insulator is reduced by 20 per cent, in contrast with a probably complete breakdown with the pin-supported type of insulator.

The most important reason for using the suspended type of insulator is the flexibility of the unit formation. Should it be desired to raise the line voltage, or if on account of severe local conditions, such as salt fog or smoke from railway trains or factories, it becomes desirable to increase the leakage surface, additional units can be hung from the other sections already connected with the crossarms with no additional investment except for the new sections. Were the pin-type insulator used the necessity of additional insulating qualities would require taking down the old insulators and replacing them with larger ones.

The utilization of the underhung insulator requires a special form of pole-top construction, including crossarms of sufficient length to give assurance that the line wires may not swing against the pole or steel tower to which the crossarms are fastened. This will require an extra length of crossarm, but, due to the absence of twisting strains upon the arms, its design can be enough lighter to offset the added cost for length. Another advantage which has not been mentioned is that with the insulator hanging from below the crossarms the tops of the towers act as lighting rods and serve to relieve the line of much lightning stress.

For these several reasons it is seen that the underhung system of high-tension conductor insulation works out with pleasing directness and simplicity. Added to these desirable attributes is the comparative cheapness with which it can be installed for high voltages and varying insulation conditions. These favorable characteristics should argue well for its consideration wherever high-voltage transmission lines are to be built.

---

#### THE ABBREVIATED CLASSIFICATION OF OPERATING EXPENSES.

---

Statements from representatives of state railway commissions published elsewhere in this issue show a discrepancy in opinion as to the amount of gross earnings which should determine the use by electric railways of the abbreviated or the amplified classification of operating expense accounts proposed as part of the new uniform accounting system. As shown by the accounts of the progress on the system published in the Electric Railway Review, it is proposed to adopt two classifications of operating expense accounts. The tentative classification for larger roads, provided essential agreement with the steam railway classification is necessary, contains 116 primary accounts; but it is intended, with the approval of representatives of the interstate commerce commission and various state commissions, to abbreviate the classification into 21 primary accounts in order to meet also the requirements of small roads. There is no question as to the fairness and virtual necessity of an abbreviated classification if the amplified classification is to be adopted; the divergence of opinion is upon the amount of gross earnings which should mark the division line between those companies which use the small and those which use the large classification.

At the conferences attended in Washington by representatives of many of the principal street and interurban railways of the country and by representatives of several impor-

tant public commissions, amounts ranging from \$50,000 to \$500,000 were suggested as the line of division. William O. Seymour, member of the Connecticut railroad commission, in the statement published on another page, believes that roads with gross earnings of less than \$200,000 a year should use the abbreviated classification. Thomas Yapp, assistant secretary of the Minnesota railroad commission, believes that roads with gross earnings of over \$75,000 annually should use the amplified classification.

We believe that the public officials who are promoting the uniform accounting system should be liberal to the roads in this matter. It need not and should not impair the efficiency of accounts if a small road follows an abbreviated classification of operating expenses. A road with gross earnings of \$75,000 annually cannot afford to conduct its accounting department with the detail which the management of a large road would deem essential; the road with small capital investment should not be compelled to bear the heavy expense which the amplified classification would entail. Where the auditing expense with the abbreviated classification might be say \$2,400 a year for a road with gross earnings of \$100,000, the additional yearly expense to such a road of maintaining the amplified classification is estimated at about \$3,600, or an increase of 150 per cent, making a total of \$6,000. The amplified classification on even a small road would require an additional clerk to represent the auditor in each of the following four departments: Maintenance of way, electric (line and power house), car house and store-room; and two extra clerks would probably be needed in the office of the auditor to carry the large number of accounts through the books. It would be unreasonable to expect any road to spend 6 per cent of its gross revenue for accounting expenses; the expenditure of this percentage of the gross revenue would mean that about 9 per cent of the total operating expense would be absorbed by this department, which would be out of all proportion to the value of the labor to either the company or the public.

As small roads are of great benefit to the communities through which they operate, they should be encouraged in every way. Many of the short lines are built largely in the hope of the earnings which future development of the territory will assure, and if too serious a burden in accounting expense is laid upon these small roads a number of the companies will undoubtedly be unable to meet interest on the capital investment.

The problem of making small roads profitable is a serious one. In the annual report of the Massachusetts railroad commission, which has just been issued, the important fact was brought out that many of the roads in that state, especially those serving sparsely settled communities, have reached the period when considerable sums of money are required for repairs and renewals. As many of these roads have not been able to pay dividends and also meet their operating expense and fixed charges, the problem in operation "for these, as well as for some of the larger roads, will be not only that of paying dividends, but of making renewals of track and replacements of rolling stock without impairment of capital."

Proper accounting methods are desirable, but liberality in the decisions of public officials respecting the use of abbreviated classifications is highly desirable. It need not impair in the slightest degree the efficiency or accuracy of accounts.

---

An international exposition devoted to the various applications of electricity will be opened at Marseilles, France, on April 19, 1908, and will extend until October 31. The exposition will be held at Parc du Rond-Point du Prado and will be under the patronage of the municipality and the chamber of commerce of Marseilles.

---

The Peoria (Ill.) Railway has installed a set of manually operated block signals at four points on its city lines.

# Communications

## CARS FOR CITY SERVICE.

To the Editors:

The Pittsburg Railway Company has made a signal mistake in attempting to introduce the pay-as-you-enter system in that city, without first having made some kind of preparation for it. Under such conditions how could any other result be expected? I have no interest in the pay-as-you-enter car beyond that of an ordinary citizen wishing to see more comfortable service. This certainly can be done by the introduction, perhaps not of the Montreal or Chicago form of car, but of some form that will answer the same purpose—one that will neither make it necessary for the conductor to crowd himself among the people nor the people to jostle each other in boarding and alighting from cars.

The reasons why the pay-as-you-enter car is a success are: First, because the cars are provided with an extra large platform upon which some people may stand while others are passing into the car; second, the cars are arranged so that a passenger can pass out of the car without interfering with those coming in; and, third, the forethought shown in Chicago in instructing conductors in advance how to handle the people and the cars. In Chicago the patrons were also told how they could assist in making the use of these cars a success. It undoubtedly was because of a lack of such preparation that our Pittsburg friends have failed.

As early as 1898 I introduced on the Rochester (N. Y.) street railway the system of entering cars by the rear platform and alighting from the front. The desire was to expedite the movement of traffic. The plan was a success, but, before putting the system in force, even in that city, I notified all interested that it would be done, both by posters inside the cars and by circulars instructing conductors and people how to act, and requesting their assistance. Several railway managers came to see how the plan worked, most of whom thought that we would have more accidents by reason of passengers leaving by the front platform. We did not, however, but, on the contrary, our step accidents were reduced, and the cars made better time, more comfortably.

I am not sure, but, possibly, the Montreal people may have gotten their first idea from this practice in connection with the large platforms used at Detroit.

New York, January 2, 1908.

T. J. NICHOLL.

[In explanation of the purpose of the Pittsburg Railway Company in carrying on its pay-as-you-enter experiments without specially constructed cars, we have received from John Murphy, general superintendent, a letter including the following information: "In reference to our experiments with the pay-as-you-enter idea I beg to state that in order to feel the pulse of the public as to how this plan would be received in this city, we experimented with it for two days on equipment which is not at all adapted to it; and we are convinced from this test that with the proper kind of car the pay-as-you-enter plan is perfectly practicable on some parts of our system; on others it is not."—Eds.]

---

The Boston Elevated Railway has distributed to its employees \$60,000 in the shape of rewards of \$15 each to those who during the past year have not been reported for delinquency or misconduct. It is said that this year 85 per cent of the men received the rewards. This is the fifth time the company has made New Year gifts of this kind.

---

President Theodore P. Shonts of the Interborough-Metropolitan Company, New York, has announced that negotiations are now in progress looking to the opening and operation of the Belmont tunnel under the East river at Forty-second street.



Pay-As-You-Enter Cars in Buffalo—Exit from Front Platform, Door Controlled by Motorman.

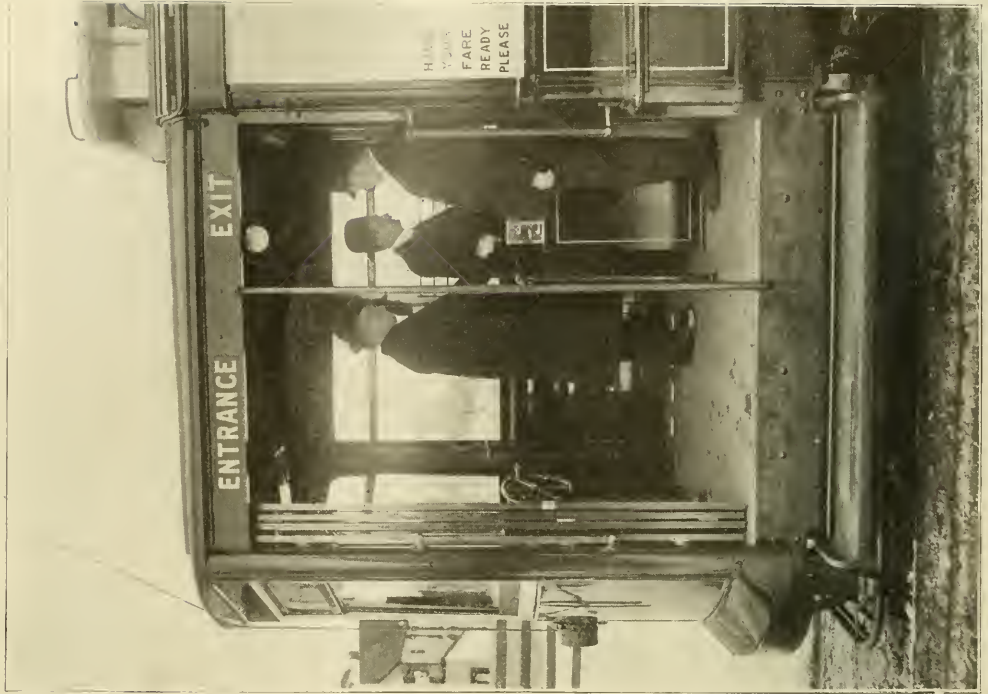

Pay-As-You-Enter Cars in Buffalo—Rear Platform, Showing Method of Entrance and Fare Collection.

**PAY-AS-YOU-ENTER CARS IN BUFFALO.**

On Sunday, January 5, the International Railway Company of Buffalo, N. Y., placed in service on its Niagara-Grace and Niagara-O'Neill lines 35 pay-as-you-enter cars of the Stephenson semi-convertible type, built by the G. C. Kuhlman Car Company of Cleveland. The full equipment of the new

first company in the United States to make use of pay-as-you-enter cars, who is also vice-president of the International Railway Company, was in Buffalo on Sunday and Monday to witness the first tests of the cars in that city. Mr. Mitten informs us that their operation was successful from every standpoint and was enthusiastically received by the press and the public. He is very much pleased with the pay-as-you-enter



**Pay-As-You-Enter Cars in Buffalo—Car Taking on Load in Shelton Square.**

cars is 50, all of which have been received and were at the disposal of the company for use during rush hours on the following day. From an operating standpoint the cars were entirely successful from the start. The first day's use demonstrated that it would be possible to reduce the running time

system, and after having operated the new cars since November 24 expresses surprise that the plan was not tried earlier.

**Special Preparations for the Service.**

Prior to the day set for opening the new service the Inter-



**Pay-As-You-Enter Cars in Buffalo—Side View of Car While Loading and Unloading.**

on the Niagara-O'Neill line, six miles long, by five minutes. On the following day, when the traffic was heavier than on Sunday, the facility of the system in handling rush-hour crowds was fully demonstrated.

national Railway Company had made careful preparations, similar to those made by the Chicago City Railway, for the purpose of insuring a favorable reception by the public. The motormen and conductors were carefully coached in their duties at the car houses before being allowed to take out

T. E. Mitten, president of the Chicago City Railway, the

the new cars and were given a booklet of instructions very much like that prepared by the Chicago company, which was described in the Electric Railway Review of November 16, 1907, page 795. A small folder, illustrated by three photographs of the cars and briefly describing the points of advantage and the methods of operation of the new system, was also distributed to the public at Shelton square, the principal downtown starting point of traffic. A small booth, shown in one of the illustrations, was established at Shelton square, where change might be obtained, and an announcer was stationed at Main and Niagara streets to tell passengers to have their fares ready. Switchmen were placed at junction points and starters at grade crossings with steam railways.

#### Fare Box.

As shown in the photograph of the rear platform, a fare box is located just inside of the conductor's railing. In general appearance the fare box is similar to the ticket chopper's box used in the New York subway and on several elevated



Pay-As-You-Enter Cars in Buffalo—Change Booth in Shelton Square.

roads. The upper part, or receiver, is of glass, so that the conductor has an opportunity to examine the coin. After the coin has been deposited the conductor pulls a lever that drops it into the cash box below. Passengers are required to deposit the exact cash fare or a ticket into the box. Transfers are to be handed to the conductor. The conductors are provided with \$25 in change, instead of \$9.00 as formerly, and will make change if necessary, but the passenger is required to drop the fare. The large amount of change supplied to the conductor is made necessary by the fact that the fares collected are not available for use as change. Conductors are not required to furnish change for bills of over \$2.00. The fare box was designed by officials of the International Railway Company and, though in an experimental state, is believed to be a success and particularly well adapted for use on cars of the pay-as-you-enter type.

The company was fortunate in the selection of a line having a downtown terminus at which probably 60 per cent of passengers bound for the residence section board the cars, and which is in the business center of Buffalo, where the methods of handling passengers could be seen by all passing through Shelton square. This enabled the general public to quickly

become familiar with the cars and what was expected of them.

In general the arrangement of the cars and their design are similar to those for the Chicago City Railway, described in the Electric Railway Review of September 21, 1907, page 332, and, as in the Chicago cars, smoking is permitted on the front platform. A few of the principal dimensions and some of the special equipment are as follows:

Length .....	48 ft. 3 in.	Width .....	8 ft. 7 in.
Length of body .....	32 ft. 5 in.	Height .....	12 ft. 3 in.
Length of platforms .....	7 ft. 9 in.		

#### Special Equipment.

Brakes, air .....	Heating system .....	Consolidated Car-Heating Co.
National Brake & Electric	Seats .....	Hale & Kilburn
Brakes, hand .....	Trucks .....	Brill No. 27
Controllers .....	Curtain fixtures .....	Trolley retrievers .....
GE K-28-E	.....Curtain Supply Co.	Destination signs .....
Curtain material .....	Pantasote	Hunter

#### CENTRAL ELECTRIC RAILWAY ASSOCIATION.

President H. A. Nicholl announces that the second annual meeting and banquet of the Central Electric Railway Association will be held at the Phillips house, Dayton, O., on Thursday, January 23. The business meeting will take place at the morning session, convening at 10:30 a. m., and the election of officers will take place at the afternoon session.

The following programme is announced:

#### Morning Session.

President's annual address.  
 "Promotion of Traffic." Paper by Charles F. Price, general passenger agent Western Ohio Railway, Lima, O.  
 "Telegraph Signal System." Paper by Chauncey P. Button, general manager Telegraph Signal Company, Rochester, N. Y.

#### Afternoon Session.

"Can Electric Interurban Railways Profitably Carry Passengers at the Present Rate of Fare?" Paper by F. W. Coen, general manager Lake Shore Electric Railway, Norwalk, O.

#### Reports of Committees.

"Report of Standardization Committee on Fundamental Brake Rigging." By R. C. Taylor, chairman.  
 "Report of Committee on Traffic Organization." By F. D. Norviel, chairman.

#### Election of officers.

It is urgently requested that every member make a special effort to be present at this meeting, as it promises to be one of great importance to all operators of electric railways in the central territory.

Traffic and executive officials of interurban railways in Indiana, Illinois, Ohio and parts of Michigan and Kentucky will meet at Dayton at this time for the purpose of organizing a traffic association as a branch of the Central Electric Railway Association and will remain over to attend the convention. This meeting will be held on Wednesday, January 22, at the Phillips house. As this is one of the important moves of the Central Electric Association, it is very essential that all roads in the states named shall be represented at this meeting.

A cordial invitation is extended to all officers of interurban railway companies to bring their private cars to Dayton on this occasion. Arrangements have been made through a special committee to take care of all private equipment. Parties intending to bring their cars are requested to correspond with T. J. Ferneding, superintendent Dayton & Xenia Transit Company, who will take charge of all such equipment while in Dayton.

The after-dinner programme will be made a special feature of entertainment. Many gentlemen of prominence, not only in railway but in municipal and state affairs, have been invited. E. C. Spring, the first president of the association, will be toastmaster and under his efficient direction an interesting and delightful programme is expected.

The dinner will be served at 7:30 p. m. Every member of the association is at liberty to bring as many friends as he desires.



**ANNUAL REPORT OF MASSACHUSETTS RAILROAD COMMISSION.**

The thirty-ninth annual report of the Massachusetts railroad commission, containing returns of electric and steam railways, has been issued. An abstract of that part of the report which relates to street railways follows:

Returns for the year ended September 30, 1907, were received from 85 street railway companies. By reason of consolidations there were at the end of the year 82 existing companies. Of this number 62 operated their railways, 17 were operated under lease or contract by other companies, and 3 had organized and paid in a portion of their capital stock, but had not commenced the construction of their railways.

There have been added during the year to the mileage of the Massachusetts companies 25,062 miles of street railway line and 7,500 miles of second track, making 32,562 miles of additional main track. There have also been added 4,515 miles of sidetrack, making a total addition of 37,077 miles of track reckoned as single track. The Massachusetts companies now own 2,233,121 miles of street railway line, 427,624 miles of second main track and 157,130 miles of sidetrack, making a total length of track reckoned as single track owned, 2,817,875 miles. This does not include the Woonsocket road (merged with the Rhode Island Company), which was in last year's return, which has 21,961 miles of main line, of which 3.195 miles is in Massachusetts and 0.863 mile of sidetrack, of which 0.103 mile is in Massachusetts. All of the track owned is surface street railway track, with the exception of 8,660 miles of elevated line and 8,484 miles of elevated second track. Of the sidings all are surface track, with the exception of 3,592 miles of elevated track. All the elevated track is located in Boston. Altogether 34,193 miles of main and second track are operated outside of the state. The total miles of main track (including trackage rights) operated is 2,745,266, an increase of 31.175 miles over the previous year.

**Assets, Capital Issues and Dividends.**

The gross assets of the companies on September 30, 1907, were \$161,297,914, an increase of \$5,383,160 over the previous year. Of the total \$79,993,550 represented construction and \$28,738,946 equipment. The gross liabilities on the same date, including capital stock, but not including sinking and other funds, were \$153,847,903, an increase of \$4,789,209.

The aggregate capital stock of the 82 companies, on September 30, 1907, was \$73,280,155, a net increase of the same companies of \$2,363,230 over the preceding year.

The total amount of dividends declared in the year was \$3,721,388.24, an increase of \$167,315 over the preceding year. Thirty-six out of the 85 companies paid dividends ranging from 1 to 10 per cent, and 49 companies declared or paid no dividends. One company paid 10 per cent, six companies paid 8 per cent, one paid 8 per cent on preferred and 7 per cent on common, one paid 7.22 per cent, one paid 7.20 per cent, one paid 7 per cent, eight paid 6 per cent, one paid 5.5 per cent, seven paid 5 per cent, two paid 4 per cent, one paid 3.75 per cent, one paid 3 per cent, one paid 2.5 per cent, three paid 2 per cent, and one paid 1 per cent.

The aggregate funded debt of the companies on September 30, 1907, was \$59,329,500, an increase of \$1,323,500 over the preceding year.

The amount of real estate mortgages outstanding on September 30, 1907, was \$84,800, an increase of \$10,400 over the preceding year. The total unfunded debt, including the mortgages, was \$21,228,249, an increase of \$1,102,479.

The gross debt, funded and unfunded, was \$80,567,749, an increase of \$2,425,979.

The net debt (the gross debt less \$5,855,412 of cash and current assets) was \$74,712,337, an increase of \$7,012,201. In computing the net debt the sum of \$7,960,720 returned as "miscellaneous assets," covering materials and supplies on hand, etc., is not included with cash and current assets in the deduction from gross debt.

The total capital investment (capital stock and net debt) of the street railway companies of the state on September 30, 1907, was \$147,992,492, an increase of \$9,375,431.

The average cost of the street railways of the state, per mile of main track (including the cost but not the length of sidetrack), as returned by the companies September 30, 1907, was \$30,064.34 for construction, \$10,801.09 for equipment, and \$14,563.32 for lands, buildings (including power plants) and other permanent property, making a total average cost of \$55,428.75 per mile of main track.

**Income, Expenditures and Traffic.**

The total income of the companies from all sources for the year ending September 30, 1907, was \$32,203,111.37, and the total expenditures (including dividends declared) were \$31,

799,314.56, making a net surplus of \$403,796.81 to be added to the surplus of previous years.

The total number of passengers carried during the last year on the railways in operation of the 85 companies making returns to the board was 600,695,816, an increase of 22,307,041 passengers over the previous year.

The total number of miles run by street cars was 117,719,203, an increase of 4,123,981 miles over the previous year.

Operating expenses were 67.71 per cent of gross earnings, as compared with 67.49 per cent in the preceding year. In the last 10 years the average has been 67.92 per cent.

Gross earnings per mile of track owned were \$11.485, as compared with \$11.156. Expenses of operation were \$7.776, as compared with \$7.529. Net earnings were \$3,709, as compared with \$3,627.

The car-mile results for three years past have been as follows:

	Average per car-mile.		
	1905.	1906.	1907.
Gross earnings .....	24.75	25.86	25.96
Expenses of operation .....	16.72	17.46	17.58
Net earnings .....	8.03	8.40	8.38

**Employees, Equipment and Accidents.**

The number of employes was 18,151, as compared with 16,909 in the previous year. The number of motors was 15,626, the number of cars was 7,539 and the number of other cars and vehicles 2,900.

The whole number of persons injured in connection with street railway operation, as returned by the companies for the year ending September 30, 1907, was 6,853, of whom 99 received fatal injuries, and 6,754 injuries not fatal.

The number of passengers injured was 4,879, of whom 23 were injured fatally. The injuries to employes were 321 in all, 13 of which were fatal. The number of injuries to travelers and others on the street was 1,653, of which 63 were fatal.

These figures include a very large number of injuries of a trivial character that have been returned by the companies.

Twelve more passengers, 2 less employes, and 21 more travelers and other persons on the street received fatal injuries than in 1906. Of those receiving injuries not fatal there were returned 291 less passengers, 42 less employes and 230 more travelers and other persons on the street than in 1906.

Altogether there appear to have been injured, fatally and otherwise, 279 less passengers, 44 less employes and 251 more travelers and other persons, making 72 less accidents returned by the companies as having occurred during the last than the preceding year.

**Electric Railroads.**

After careful inquiry and extended debates the legislature of 1906 passed an act, Chapter 516, authorizing a new type of transportation—electric railroads. Under the provisions of that act five different companies in process of formation petitioned the board for the issue of certificates that public convenience and necessity required the construction of their lines. One of these petitions is now pending, one was held to await further study and development, two were dismissed for sufficient reasons and one certificate was issued.

In rendering its decision the board stated its views as follows: "The question to be decided under each petition is whether, upon the whole, the net results of the proposed undertaking promise public gain or public loss"; and, further, that "It surely cannot be said that public necessity and convenience require the building of an additional railroad if the effect upon existing railroads is so disastrous that the service as a whole is impaired rather than improved."

**Heating and Ventilation of Cars.**

The board has recently changed its requirement with reference to the point of outside temperature at and below which companies are called upon to heat street cars, making that point 40 instead of 50 degrees above zero, the temperature to be then maintained to have a range that shall not be lower than 40 nor higher than 60 degrees. In making this radical change and certain other changes, the board has had in view a rule that companies will find it possible to obey, and that the district police can enforce under the statute which makes them responsible for its enforcement.

Obviously an attempt to always satisfy every occupant of a street car with the atmospheric conditions must be futile. Even if passengers were of the same mind, it is impracticable to constantly maintain air of a given quality and the temperature at a specific point in a car that is one moment nearly empty and the next crowded to the limit; now stationary, then in motion; with doors continually opening and shutting, and with an outside temperature varying between zero and 40 degrees above.

The day of horse cars, with straw on the floor to keep the

feet warm, and with no ventilation except that afforded through the doors, is within easy recollection. While today the electric heater exemplifies radical progress in heating, the ventilator commonly in use is about as crude as any device could be. It is true that a number of experiments have been made, that a ventilator of improved type is now found in the semi-convertible cars upon the Boston & Northern and upon the Boston Elevated lines, and that another device, which promises as good if not better results, is found in cars of the elevated trains; but that there has been, however, a too general indifference on the subject of ventilation cannot admit of question.

After all is said, however, in support of theories and devices for heating and ventilating cars, present discomfort is due fully as much to the failure to properly use means at hand for keeping the air pure and warm as to imperfection in apparatus. There is no reason why, for example, a movable ventilating window should be kept entirely open or entirely shut, or in any one position throughout a long journey, in total disregard of the temperature outside and of the changing conditions inside the car.

#### Street Car Fenders and Wheel Guards.

The board deems it necessary to reiterate its views that no particular fender or wheel guard has yet been found the adoption of which can be recommended in preference to all others, and that the greatest safeguard in street railway operation comes from having the cars at all times under such control as to avoid striking a person, rather than depending upon any device to save him from harm after having been struck by a moving car.

The board will continue to investigate and thoroughly test all meritorious fenders and wheel guards, and will insist upon the more general use of any device found to possess sufficient merit to warrant its adoption.

To assist the board in determining the efficiency of these devices, it is expected that companies will keep a record of all tests through their use.

#### Repairs and Renewals.

The physical condition of street railways in Massachusetts shows a general improvement over the previous year, large sums having been expended for repairs and renewals, and some of the larger companies having bought many new cars and replaced with more commodious cars the equipment lost or worn out in service.

Among the smaller companies, especially those serving sparsely settled communities, the period has arrived when considerable sums of money must be spent for repairs and renewals of property. Many have been unable to earn a sufficient sum above their operating expenses and fixed charges to place them in the dividend-paying class of roads, and the problem in operation for these as well as for some of the larger roads will be not only that of paying dividends, but of making renewals of track and replacements of rolling stock without impairment of capital.

The public, now so generally dependent upon local inter-urban roads, should be ever mindful that, while it is essential that service should always be adequate, the ideal conditions can only be obtained through a fair return upon money invested.

Whatever the solution of these difficulties, one thing is evident, that the conduct of street railway companies should be no different from that of other transportation or business corporations in the adoption of a far-seeing policy in the management of properties, and an element always to be commended in such management is that of proper provision in the present for the inevitable needs of the future.

#### Report of Bridge Engineer.

The report contains a statement from George F. Swain, the bridge engineer, in which he says regarding street railway bridges:

"The condition of steel bridges over steam railroads requires careful and frequent examination, as some such bridges which have been recently uncovered have shown great reduction in strength, owing to the corrosive action of the smoke and steam from the locomotives. No paint is proof against this combination of chemical and mechanical action, and the only safe and permanent plan appears to be to encase the steel in a covering of concrete or plaster or some other material which will not corrode.

"During the past year the different street railway companies have done considerable work in altering, strengthening and rebuilding bridges. A good deal of a minor character has been done, together with a good deal of work of magnitude. The most extensive strengthening that has been carried out during the year has perhaps been the rebuilding and strengthening of the steel trestle on the Old Colony Street Railway at

Raynham, 752 feet long. This work is an illustration of the short-sightedness with which some of our street railways have been constructed in the past. It was built only 10 years ago, but as the traffic increased and heavier cars were run it was soon found to be too light. Within 10 years from the time it was constructed it has been found necessary to largely rebuild it.

"The new bridges which are being constructed by street railways in the commonwealth are designed for heavy cars, and it is hoped and expected that they will prove to be more enduring."

#### AUTOMATIC INTERLOCK TO PREVENT ACCIDENTS FROM MISPLACED AIR COCKS.

On all large electric roads where heavy cars are in use, equipped with air brakes, and especially where trains of two or more cars have to be made up and moved about the yards and run into terminals, it very frequently happens that an employe will forget to cut-in the air cocks below the engineer's valve, the consequence being that when he attempts to apply the brakes they will not work and the train may run through a switch or crash into a train of cars standing on a siding or on the main track.

One of the worst accidents in electric railroading was caused by a switchman pulling out of a siding with a 5-car train and running into a 5-car train loaded with passengers standing at the foot of a slight grade. When the debris of this wreck was cleared away the cocks under the engineer's valve were found to be closed.

Where a road is operating a stub-end terminal a motorman changing ends occasionally forgets to close the cocks on the engineer's valve he has been operating, and, leaving the valve on release position, goes to the other end of the car or train and starts out with his brakes inoperative. Then when he attempts to stop he can only do so by reversing. Very frequently the reverser is stuck or the circuit-breaker blows, due to heavy rush of current, and then he is powerless to prevent an accident.

A very simple device has been perfected and patent applied for by E. T. Munger, A. H. Daus and H. A. Johnson of the Metropolitan West Side Elevated Railway Company of Chicago. The device is designed to positively prevent accidents caused by improper placing of the air cocks. The device is simple. It consists of a switch attached to the cut-out cock under the engineer's valve, to which is connected one of the control circuit wires. The protective apparatus can be applied to any control system.

Following are statements of how this device will operate with different numbers of cars in a train:

1. One car, cab in one end only; cut-out cocks under engineer's valve must be open before car can be moved.
2. One car, cab in each end; cut-out cocks in operating cab must be open, in other cab closed, before train can be started.
3. Two or more cars in train, one or more cabs in each car; cut-out cocks in operating cab must be open, and in all other cabs they must be closed, before power can be fed to motors.

With the device installed, if a passenger opens a cut-out cock in some cab of a train in motion, the power will immediately be shut off.

It is stated that the attachments necessary to afford these results can be installed on cars already operating for less than \$5.00 per car for labor and material. The installation does not require any extra wires in the train line. On roads contemplating new equipment it can easily be installed at the time cars are wired.

A number of cars on the Metropolitan West Side Elevated Railway are equipped with these devices, which are operating satisfactorily.

On the Saturday before Christmas, December 21, the lines of the Interborough Rapid Transit Company, New York City, carried 1,649,752 passengers. Of these 961,114 were carried on the elevated lines and 688,638 on the subway division.

**TICKET METHODS OF THE ATLANTIC CITY & SHORE RAILROAD.**

By S. S. NEFF, GENERAL SUPERINTENDENT.

The Atlantic City & Shore Railroad, of Atlantic City, N. J., has recently instituted on its Ocean City division a number of new ticket methods, which may be of interest, and

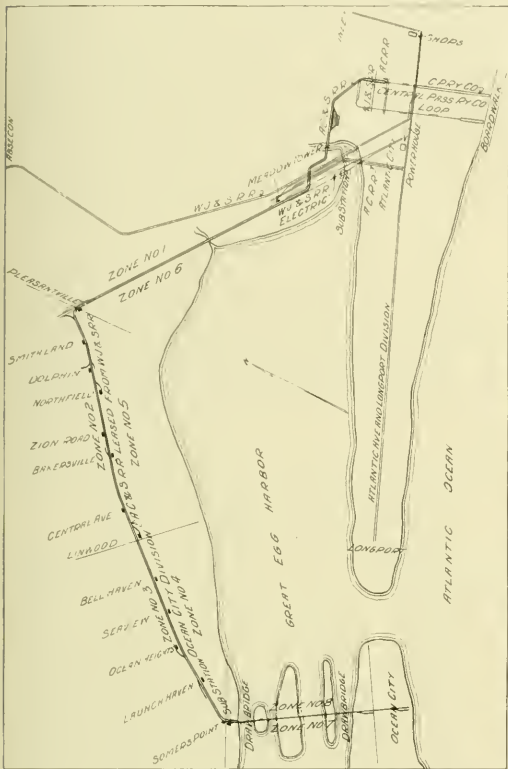

Atlantic City & Shore Railroad—Map of System.

of which we should appreciate criticisms from any member of the street railway fraternity.

The Atlantic City & Shore Railroad at present consists of three divisions: First, the Central Passenger Railway, comprising a loop in Atlantic City, on Virginia, Adriatic, and South Carolina avenues, touching the Boardwalk on the first and last named avenues; second, the Atlantic Avenue & Longport division, between Inlet and Longport, with a boat line operating between Longport and Ocean City; third, the Ocean City division, a high-speed line between Atlantic City and Ocean City, which is operated in various parts by the third rail, catenary and ordinary overhead conductors.

On August 25, 1906, the last named division was opened for traffic between Atlantic City and Somers Point, and the following 5-cent fare zones were established:

**SOUTHBOUND.**

- Atlantic City to Pleasantville.....Zone No. 1
- Pleasantville to Linwood.....Zone No. 2
- Linwood to Somers Point.....Zone No. 3

**NORTHBOUND.**

- Somers Point to Linwood.....Zone No. 4
- Linwood to Pleasantville.....Zone No. 5
- Pleasantville to Atlantic City.....Zone No. 6

On July 2, 1907, we opened for traffic an extension between Somers Point and Ocean City, making a continuous all-rail route between Atlantic City and Ocean City, and on account of the great cost of the bridge over the bay, the rate of fare in each direction between Somers Point and Ocean City was made 10 cents. Between these points the southbound zone is numbered "7," and the northbound numbered "8." In these zones in each direction the register is rung twice for each cash or ticket fare.

When the line was opened a ticket system was adopted, using a separate coupon for each zone, and tickets were placed on sale in the hands of the conductors. For several obvious reasons, chiefly on account of the inconvenience to passengers caused by requiring them to tear off a coupon in each zone, this system was discarded and the sale of tickets was taken out of the hands of conductors and given over to agents. At the same time a new style of ticket was adopted, of the form shown in the accompanying engravings. The new system consists of single and round trip tickets, printed separately for each station, good for a trip between terminals or between any two stations on the line. Northbound tickets are printed on a blue back-



Atlantic City & Shore Railroad—Single-Trip Ticket.



Round-Trip Ticket.

**CASH**

81 61 41 21 1	02 09 09 09 001
82 62 42 22 2	51 65 65 64 66
83 63 43 23 3	81 85 85 84 86
84 64 44 24 4	11 25 25 24 26
85 65 45 25 5	91 95 95 94 96
86 66 46 26 6	01 95 95 94 96
87 67 47 27 7	91 95 95 94 96
88 68 48 28 8	81 85 85 84 86
89 69 49 29 9	21 25 25 24 26
90 70 50 30 0	01 01 01 00 01
91 71 51 31 1	01 01 01 00 01
92 72 52 32 2	81 85 85 84 86
93 73 53 33 3	82 82 82 81 83
94 74 54 34 4	11 25 25 24 26
95 75 55 35 5	91 95 95 94 96
96 76 56 36 6	01 95 95 94 96
97 77 57 37 7	91 95 95 94 96
98 78 58 38 8	81 85 85 84 86
99 79 59 39 9	21 25 25 24 26
100 80 60 40 0	11 12 12 11 13

PRICE 5 CTS.

81 61 41 21 1	02 09 09 09 001
82 62 42 22 2	51 65 65 64 66
83 63 43 23 3	81 85 85 84 86
84 64 44 24 4	11 25 25 24 26
85 65 45 25 5	91 95 95 94 96
86 66 46 26 6	01 95 95 94 96
87 67 47 27 7	91 95 95 94 96
88 68 48 28 8	81 85 85 84 86
89 69 49 29 9	21 25 25 24 26
90 70 50 30 0	01 01 01 00 01
91 71 51 31 1	01 01 01 00 01
92 72 52 32 2	81 85 85 84 86
93 73 53 33 3	82 82 82 81 83
94 74 54 34 4	11 25 25 24 26
95 75 55 35 5	91 95 95 94 96
96 76 56 36 6	01 95 95 94 96
97 77 57 37 7	91 95 95 94 96
98 78 58 38 8	81 85 85 84 86
99 79 59 39 9	21 25 25 24 26
100 80 60 40 0	11 12 12 11 13

81 61 41 21 1	02 09 09 09 001
82 62 42 22 2	51 65 65 64 66
83 63 43 23 3	81 85 85 84 86
84 64 44 24 4	11 25 25 24 26
85 65 45 25 5	91 95 95 94 96
86 66 46 26 6	01 95 95 94 96
87 67 47 27 7	91 95 95 94 96
88 68 48 28 8	81 85 85 84 86
89 69 49 29 9	21 25 25 24 26
90 70 50 30 0	01 01 01 00 01
91 71 51 31 1	01 01 01 00 01
92 72 52 32 2	81 85 85 84 86
93 73 53 33 3	82 82 82 81 83
94 74 54 34 4	11 25 25 24 26
95 75 55 35 5	91 95 95 94 96
96 76 56 36 6	01 95 95 94 96
97 77 57 37 7	91 95 95 94 96
98 78 58 38 8	81 85 85 84 86
99 79 59 39 9	21 25 25 24 26
100 80 60 40 0	11 12 12 11 13

81 61 41 21 1	02 09 09 09 001
82 62 42 22 2	51 65 65 64 66
83 63 43 23 3	81 85 85 84 86
84 64 44 24 4	11 25 25 24 26
85 65 45 25 5	91 95 95 94 96
86 66 46 26 6	01 95 95 94 96
87 67 47 27 7	91 95 95 94 96
88 68 48 28 8	81 85 85 84 86
89 69 49 29 9	21 25 25 24 26
90 70 50 30 0	01 01 01 00 01
91 71 51 31 1	01 01 01 00 01
92 72 52 32 2	81 85 85 84 86
93 73 53 33 3	82 82 82 81 83
94 74 54 34 4	11 25 25 24 26
95 75 55 35 5	91 95 95 94 96
96 76 56 36 6	01 95 95 94 96
97 77 57 37 7	91 95 95 94 96
98 78 58 38 8	81 85 85 84 86
99 79 59 39 9	21 25 25 24 26
100 80 60 40 0	11 12 12 11 13

Run No. \_\_\_\_\_  
Trip No. \_\_\_\_\_  
Badge No. \_\_\_\_\_

Conductor's Punching Slip (Original 1 1/4 by 2 Inches).

ground and the southbound tickets on a yellow background. The price of each ticket is printed on one end.

At the time the new style of tickets were placed in service, a question came up as to how to check the conductor, and at the same time give him a record which would allow him to correctly ring up in each zone the fares covered by through tickets or cash fares paid through any number of zones. This we have done very satisfactorily by the use of punching slips, one of which is reproduced herewith.

The punching slips are of two forms, one, printed on a



## GOVERNMENT SUPERVISION OF RAILWAY ACCOUNTS.\*

BY PROF. HENRY C. ADAMS, IN CHARGE OF STATISTICS AND ACCOUNTS,  
INTERSTATE COMMERCE COMMISSION.

The government has recently undertaken to do something quite different from that which it has ever undertaken to do before. It has undertaken to exercise a controlling influence upon the administration of railway properties, through the agency of their accounts. The interstate commerce law always had in it a phrase, giving to the interstate commerce commission the right, within its discretion, of prescribing a uniform system of accounts, but it was not until the act which went into force a year ago last August that the commission was clothed with any effective power to exercise that right. The difficulty did not lie in the intent of congress, but in the fact that the law failed to provide the commission with adequate means of enforcing its desires in this regard. I have been with the interstate commerce commission since 1887. We have had three law suits in that time with the railways touching accounts. One of them had to do with the request for certain information which the railways did not care to furnish in their annual reports, and we were defeated. It was the care of congress, at the session before last, that this defect should be remedied. It is upon this amended act that the new activity of the government, referred to, is based.

I assume that you will not take it amiss if I place some emphasis upon the political aspect of this new step which the government has seen fit to take—political not in its party sense, but in the broad sense of political science. What do these orders of the commission relative to accounts mean for our government? What do they mean as a form of control of aggregations of capital which, under present conditions, are a menace to the stability of this nation? And I further call attention in passing to the fact that the success of what the interstate commerce commission is undertaking in this regard, aiming, as I have remarked, at the control of railway administration through the supervision of railway accounts, will serve as a model, if it succeeds, for the control of all forms or agencies of consolidated capital, which endanger the perpetuation of the principles upon which our government rests.

### Operating Accounts and Balance Sheet.

May I now ask your attention to the particular points held in mind in formulating the system of accounts which the commission has seen fit to promulgate? And of those, two are, I think, of paramount importance.

First—it is absolutely essential that a carrier should show, month by month, and year by year, the true net revenue; and,

Second—it is absolutely essential that the corporate assets and corporate liabilities shall be accurately, fully and clearly stated.

The first of these, the determination of the net revenue, is the kernel of operating accounts, as they are termed; the latter, the correct determination of the assets, is the significant feature of the balance sheet. Speaking broadly, accounts divide themselves into these two parts: operating accounts and capital accounts. The commission, during the first year of the enforcement of this act, has prescribed the operating accounts. It is these that went into effect beginning July 1.

The capital accounts, that is, the classification of assets and liabilities essential for the determination of the correct balance sheet, is the constructive work that yet lies before the commission during the coming year.

In what way do the operating accounts aim to secure a correct statement of the net revenue? This is done by the application of two principles, or rather by the application of a general principle in the operating accounts, and by setting up a separate classification of additions and betterments. The present system of accounting differs from the system of accounting that existed prior to July 1, speaking generally, in two important particulars. There was, in the old system of accounts, no formal depreciation account, nor was there any formal classification of additions and betterments. Now, it is by means of these two, the depreciation account, which is a primary account in operating expenses on the one hand, and a strict definition of what is an addition and what is a betterment on the other, that it is hoped to guarantee to the investing public that the net revenue that is stated from time to time shall be the true net revenue.

### Depreciation.

You will appreciate the significance of the depreciation account if I call your attention to the ease with which an

erroneous net revenue may be stated by a disregard of depreciation. Of course, the net revenue is the difference between the gross revenue and the operating expenses, the operating expenses being the technical name for what sometimes is called the cost of performing the service. Now, it is a well-established principle in manufacturing accounting, and, indeed, in sound accounting everywhere, that the wear and tear of the plant during the time that it is producing revenue shall be included in the cost before arriving at the full cost of producing that revenue. The depreciation account, therefore, aims by an orderly, regular method, and by a method which separates the depreciation charges from all the other charges included in operating expenses, and further by a method that permits of easy test as to whether the charge is too great or too light—I say that this depreciation account insists that there shall be put into operating expenses, month by month, and year by year, an amount equal to the wear of the property during that time. Suppose, for illustration, that in order to pay a dividend, or show a surplus, the management should refuse to set aside out of the earnings a fund to replace the cars which, during a month, had gone out of service, would that be correct accounting? The fact is that the value of all cars has disappeared up to the extent of the wear upon them, and to the extent of the wear, or to the extent of the value representing the wear, there should be carried into operating expenses a charge the purpose of which is to accumulate a fund with which to maintain the value of the original investment. To declare a revenue, without regard to that wear and tear, is for a company to state that it has a surplus, when, in fact, it may have none.

I know of a case which happened not long ago, of a manager who desired to make a good showing for a certain month. He found that the estimates of the earnings for the first week were below what he thought they should be, and if the month kept up in that way he was not going to be able to show as good a net earning as he expected. What did he do? He closed the shops and by what he saved in expense of maintaining his shops for a month he made a good showing. Of course, that is a wasteful method. But, what is worse, it is a dishonest method. The stockholders who receive dividends by methods of that sort simply had paid back to them a part of their capital. It was not a dividend at all. And the persons who bought that stock because of the payment of a dividend declared under such conditions bought the stock under false representations.

Now, there is another way in which the net revenue may be misstated. It may be that in especially prosperous times the manager of a railway desires to make certain improvements, and yet does not care to show that those improvements are made, nor does he care to borrow the money with which to make them. He issues an order that those improvements be made and called operating expenses chargeable to maintenance. Now, they are not maintenance charges. Now, in order to guard against the understatement of the net revenue, which is just as bad as the overstatement of the net revenue, there is being worked out a careful classification of additions and betterments, the design being to draw a clean-cut line between what is the cost to operate and maintain the property and what does, in reality, better the property. It is suggested that that betterment must be capitalized. That is a matter which certainly lies within the right of the board of directors to determine. There are conditions under which it is certainly wise, from a public point of view, as well as from the point of view of the stockholders, that improvements should be paid for out of current earnings; but, if they are paid for out of current earnings, it must be not in a blind charge to operating expenses; the carrier should not be at liberty to call an improvement a cost, which is a misstatement, but it must be charged to the income account.

### Supervisory Accounting.

Now, before I go on to the next point, I want to make a remark in connection with the scope and purpose of supervisory accounting. We have heard a great deal and read a great deal lately as to the embarrassment of railway corporations because they cannot borrow capital. It is true that the people seem temporarily to have lost confidence in the railway securities. The explanation of this loss of confidence by the railway management is that the state legislatures and congress are exercising too much supervision over the management, but it is also possible that such things as we have read of in connection with the Alton case, and other similar cases, is the explanation of this lack of confidence. Now, if this be true, nothing can restore that confidence and enable the railroads to secure the money that it is necessary for them to have in order to carry out the schemes of improvement that they desire to carry out, more quickly and effectually than such a scheme of accounting supervision as I am describing practically carried out. There is no reason in the

\*Abstract of an address delivered before the Association of American Government Accountants, Washington, D. C., October 11, 1907.

nature of the case why the railway securities should not be made as stable as a government bond. They are like government bonds in that they have the industry of the entire country back of them, and I hope that we may live to see the time when congress will permit the comptroller of the currency to accept railway bonds as the basis for the issue of national bank notes; and the only practicable means of attaining this most desired end is, in my opinion, the perfection of this scheme of accounting supervision upon which during the last year the interstate commerce commission has entered.

#### Joint Facilities.

The American system of railways is a very complicated system in that no one railway owns all the facilities which it operates. The railway managers of this country endeavor to do things as economically as possible, and if one line between two points will serve the traffic, or if one interlocker at a point, or one bridge, will serve the purpose of two or more carriers, or if one terminal in a city will meet the requirements of several roads, they say, let there be but one of these facilities of which all carriers may have joint use. Now, the debit and credit entries which are thus rendered necessary in accounting are the most difficult of the technical problems in the whole realm of railway accounting, a statement which will be readily appreciated when I say that the solution of the problem requires that three somewhat divergent results must be attained through the agency of a single set of operating expense accounts.

It must, in the first place, be possible to combine the revenue and expense accounts of the several carriers without danger of duplication or omission. It must, in the second place, be possible to determine the cost of maintaining the property represented by the capital investment of a carrier, quite independently of the question of the revenue that accrues from the operation of the property. It must, in the third place, be possible to assign to the traffic revenue of each carrier the expenses incurred for earning that revenue. Any one of these requirements could easily be met, but it is a difficult accounting problem to make use of the operating expense account in such a manner as to realize all three of these results. The interstate commerce commission accounting system aims to do this by means of joint facilities, debit and credit accounts, the principle of which is to permit the owning company to charge all expenses in its primary accounts, and to bill foreign carriers for their proportion of such charges. Instead, however, of crediting its primary accounts with the amount thus billed, which, on the other side, would require the foreign company to debit the same accounts with corresponding items (a practice which would result in a misstatement, so far as maintenance is concerned, of the accounts of both carriers), both companies are required to carry their debits and credits in specially provided accounts, called "joint facilities—dr." and "joint facilities—cr." By this means we arrive at a correct statement of maintenance expenses assignable to capital, a correct statement of costs of transportation assignable to revenue, and a correct result when the reports of the several carriers are combined into a single statement.

#### Balance Sheet and Capital Account.

Permit me to add a word relative to the balance sheet and capital account, for the reason that they bear very directly upon a question which is likely to come before congress at the next session. It is as essential for the exercise of administrative supervision over the carriers by the state and federal railway commission as for the determination of just and reasonable rates under existing rules laid down by the courts to know what the true value of railway property is. The balance sheet ought, and would, if it were properly kept, to tell what the true value of the property is, or, at least, it ought to be the key for determining that value. The balance sheet is the final record. It is the statement in which the corporate assets are put on the one side and the corporate liabilities on the other. It is the statement which gives the investor, in a definite figure, the result of the working of the corporation from the time that it first originated down to the time that the balance sheet is struck. Its theory is simple and its figures ought to be significant. But the query is, do they, in reality, convey any definite meaning? Among the assets we find against "cost of road," or "cost of equipment," so and so many millions of dollars. Do these figures mean what they say? In the majority of cases they do not. I would not be understood as implying that railway balance sheets are dishonest statements; what I mean is that the method of keeping the balance sheets according to current American practice is such that you cannot learn from the figures set up in the balance sheet against these captions I have named anything like a true measure of the cost of roads or the cost of equipment. It may not even be the original cost. It may be that if you take an inventory of the loco-

motives and cars actually used in the operation of this road the value of the property will stand millions of dollars higher than the book entry upon the balance sheet, or it may be that it will stand millions of dollars below. In either case, you have an erroneous statement of profit and loss as a balance between assets and liabilities.

This question of the balance sheet, as also the analysis of the property accounts, and the rules by which the property accounts should be kept, are the questions which will claim the attention of the interstate commerce commission during the current year. They are essentially different in character from the accounts that pertain to operating expenses and operating revenue. They pertain to the financial side of railway accounting. Such things as occurred in the Alton deal—I speak of that case because it is known by common report—probably would not have occurred, or, at least, could not have occurred so easily, had there been for 10 years prior to the time of this transaction a correct statement of the balance sheet. And now, I do not mean to say that there was any conscious error or conscious misdemeanor on the part of those who made that balance sheet, but I do mean to say that a great deal remains to be done before the balance sheets of the American railways are brought into such shape that they are capable of presenting with accuracy and sufficient detail the financial standing of railway properties, or furnish a true statement of the value of the property.

Such a general statement as this will show the significance and importance of this part of the accounting scheme, and will, I am sure, emphasize what I said at the outset, that control over accounting does in fact permit the government to exercise a certain degree of supervision over the management of railway property. Of course, the accounts themselves would be of little use were it not for the fact that the law also provides for examiners whose duty it shall be to examine the accounts of the carriers and determine whether or not the prescribed rules of accounting are followed. Although the analogy is not quite accurate, the relation between the interstate commerce commission and the carrier is something like the relation that exists now between the treasury department and the national banks. The purpose in both cases is administrative supervision over the corporations concerned.

#### NEW HAVEN'S PLANS FOR NEW YORK-PORT CHESTER ELECTRIC LINE.

On January 2 President C. S. Mellen of the New York New Haven & Hartford Railroad, in a communication to the board of estimate of New York City, stated that the New Haven company owns the entire capital stock of the Millbrook Company, which in turn controls the New York Westchester & Boston Railway and the New York & Port Chester Railroad. The communication was in reply to a resolution of the board asking the New Haven road to furnish information as to its relation to the Westchester and Port Chester companies and to state whether it proposed to proceed with the construction of the roads under the franchises. It is stated that the board has considered revoking the franchises on the ground that the required amount of construction work has not been completed.

Mr. Mellen states that "it is the intention of the New York New Haven & Hartford Railroad Company to cause to be constructed a railroad from the Harlem river to Port Chester, consisting of two tracks from the Harlem river to One Hundred and Seventy-seventh street, four tracks from One Hundred and Seventy-seventh street to the city line and two tracks from the city line to Port Chester, such road to be a high-speed electric railroad, in compliance with the provisions of the franchises heretofore granted by the city of New York to the Port Chester company and the Westchester company." He says further that the company desires to build the road according to the best available route and that it has no preference as to which charter shall be used, the company's only desire being to build under a charter that shall be free from legal question.

The company has arranged for practically all of the right of way between One Hundred and Seventy-seventh street and Port Chester and considerable construction work has been done, but little further progress can be made until litigation now pending can be settled. The Port Chester company has

been enjoined from crossing streets in the Bronx and the validity of the Westchester company's charter is now being attacked in the courts. As soon as possible it is the intention of the New Haven company to apply to the board of estimate and to the public service commission for permission to consolidate the two companies.

#### DECISION OF WISCONSIN RAILROAD COMMISSION ON ISSUE OF CAPITAL OBLIGATIONS.

An abstract of the decision of the Wisconsin railroad commission approving the issue of \$300,000 bonds by the Southern Wisconsin Railway of Madison, Wis., follows:

The original application in this matter was made on July 23, 1907. Various amendments which the commission considered necessary in order to comply with the terms of Chapter 576 were made by the company at different subsequent dates.

##### Application of the Company.

The chief statements of the amended application read as follows:

"The \$300,000 bonds will be secured solely by the \$450,000 bonds owned by the Madison & Interurban Traction Company. That company has for the purpose of assisting the Southern Wisconsin Railway, in effect, loaned these bonds to it and it will be provided, in the proposed trust agreement, that as the coupons on these bonds mature they shall be clipped and canceled by the trustee and returned to the company. During the period of the trust and until the \$300,000 serial bonds are paid, both as to principal and interest, the Madison & Interurban Traction Company receives no income from its bonds so loaned to this company. The \$300,000 serial bonds are not secured by mortgage and are no additional mortgage lien and never can be, on the property of the Southern Wisconsin Railway. The expectation is that the earnings of the company for the next eight years will take care of this \$300,000 bond issue, both principal and interest."

"The bonds are issued for the following purposes: (a) Rebuilding the track and overhead system at certain points at an estimated cost of \$159,000. (b) Extending the railway at an estimated cost of \$38,000. (c) Extending the railway by building along a private right of way to the Dane county fair grounds, at an estimated cost of \$18,000. (d) The purchase of 10 new cars, at \$3,500 each. (e) The erection and equipment of a power-generating plant, at an estimated cost of \$137,660. (f) The payment of the floating debt of the company. (g) The purchase of a road roller, a sprinkling car and a tower car, at a cost of \$4,500 (the road roller has already been purchased, at a cost of \$2,060)."

The itemized list of improvements to be paid for out of the proceeds of the sale of the proposed bond issue was subsequently cut down so as to bring it within the limits of \$300,000.

##### History of Capital Issues.

The history of recent capital issues is set forth as follows, by the officials of the applicant company in a statement received by the commission on September 4, 1907:

"At the time the Madison & Interurban Traction Company purchased the property of the Madison Traction Company that company had outstanding \$300,000 stock and an authorized bond issue of \$300,000, of which \$210,000 had been issued and were repurchased by the company at a premium of 10 per cent.

"The Madison & Interurban company issued \$685,000 bonds and \$50,000 stock, all of which was delivered to its predecessor company for property. The Madison Traction Company distributed the bonds thus received as part payment of its property to its stockholders. The stockholders sold the bonds to the Citizens' Savings & Trust Company of Cleveland, O. The Madison & Interurban company afterward expended upward of \$200,000 in cash for which no additional bonds or stocks were issued, leaving the capitalization of the Madison & Interurban company, at the time of the sale of its property to the Southern Wisconsin Railway, with \$685,000 par value of first mortgage bonds and \$500,000 of stock outstanding, or a total of \$1,185,000.

"The present company authorized an issue of \$2,000,000 par value of general mortgage bonds and issued \$1,185,000 of these bonds, as follows: Delivered to trustee, to be exchanged for outstanding bonds of the Madison & Interurban company, \$685,000; delivered to the Madison & Interurban company, for property purchased subject to the \$685,000 bonds, \$450,000; delivered to Southern Wisconsin Traction & Light Company, for property purchased from it, \$50,000.

"In addition the Southern Wisconsin company received all of the capital stock of the present company, \$50,000.

"Inasmuch as this company has only issued \$1,185,000 of its authorized issue of \$2,000,000 bonds, there remains in the hands of the trustee, authorized but not issued, \$815,000 par value in bonds which the management of the company deems it unwise to draw upon for any purpose in the present condition of the bond and money market. The company therefore proposes to issue its short-time bonds for \$300,000, drawing a higher rate of interest and payable as to both principal and interest, out of earnings.

"Since the old line was bought in 1905 it has been largely rebuilt; the tracks, overhead work, equipment, and many buildings were in worn-out condition and it was bought with the expectation of making the same a first-class line of railway. Since September, 1905, the work of reconstruction has been going on, new buildings have been erected and the line to South Madison has been built, in addition to which 10 new cars have been purchased and others rebuilt. All these and other improvements have been made at a time when labor and material were enormously high, and the whole work has been very expensive. All the moneys for which notes were given have been expended for the legitimate business of the company."

##### Value of the Property.

The tax commission and the railroad commission, jointly, have nearly completed a valuation of the Madison Street Railway property. When this valuation has been completed it will be possible to state definitely to what extent there is a misfit between the outstanding securities of the Southern Wisconsin Railway Company and the actual value of the property devoted to the public service of the company. Without waiting for the exact figures of this valuation, on the basis of other data in the possession of the railroad commission it may be stated that the \$685,000 par value of bonds held in trust by the Citizens' Savings & Trust Company of Cleveland, O., more than represents the full value of the Madison street railway property; and that neither the \$450,000 par value of bonds held by the Madison & Interurban company, nor the \$50,000 par value of bonds held by the Southern Wisconsin Traction & Light Company, represent any actual and necessary investment in the present Madison Street Railway system, not to speak of the \$815,000 of bonds, par value, authorized to be issued, but not yet issued by the Southern Wisconsin Railway Company. In other words, the authorized bond issue of the Southern Wisconsin Railway equals, approximately, five times the cost of reproduction new of the property upon which the bonds rest, while the outstanding stock may be regarded as a superbonus for the promoter. In round numbers, the bonded indebtedness at present outstanding amounts to \$96,000 per mile; total bonds outstanding and authorized, \$160,000 per mile; while the cost of reproduction new today is less than \$31,000 per mile.

According to the statements filed with the commission by the Southern Wisconsin Railway Company the name of the company owning the Madison street railway system has been metamorphosed in the following order of succession since the year 1905: Madison Traction Company, Madison & Interurban Traction Company, Southern Wisconsin Traction & Light Company, Southern Wisconsin Railway Company. Each change of name was apparently accompanied by a fusion of some of the old and a dilution of the new securities representing the property.

The question of the reasonableness of the rates of fare charged by the Southern Wisconsin Railway is not before the commission at this time. Hence, the relation of the outstanding stocks and bonds to such rates of fare need not be discussed in this place.

Before a just and valid judgment can be expressed upon this question a different and much more comprehensive investigation must be undertaken.

##### Power of the Commission.

We do not hesitate to say that if this commission had the right under the law to exercise the alternative power of granting or refusing to grant any applications of this kind it would deny the present application, at least until after the Southern Wisconsin Railway had submitted to an adequate financial regenerative process. In our judgment the law confers no such power upon this commission.

As we construe the act the function of this commission, in case stocks or evidences of indebtedness are to be issued for money only, is limited to ascertaining the facts essential to determining the legality of the proposed issue and the financial status of the applicant. We may ascertain whether the proposed issue is authorized either as to amount or character, whether, if an issue of stock, the same would result in the fictitious increase of the capital stock of the corporation, and any other fact bearing on the legality or illegality of the proposed issue; also whether the purposes for which the corporation proposes the issue and the terms of the same are within

the statute or are authorized by law. For the purpose of advising the public and investors of the value and security of the proposed issue we may inquire into the financial condition and affairs of the corporation, both past and present. If the corporation complies with all the requirements of the commission by furnishing such statements and evidence as the commission "may deem pertinent to the inquiry," and the commission finds no illegality in the proposed issue of stocks, bonds or other evidences of indebtedness, it must issue to the corporation a certificate authorizing it to issue such stocks, bonds or other evidences of indebtedness to the amount, of the character, for the purposes and upon the terms proposed on the part of the corporation. Unless the proposed issue of stocks, bonds or other evidences of indebtedness are unauthorized or unlawful in any of the particulars above mentioned, the commission cannot deny the granting of the certificates. It may not impose limitations not authorized by the statute nor determine the purposes, terms or conditions upon which such stocks or evidences of indebtedness are to be issued.

The law reduces the functions of this commission with respect to issues of securities of public service corporations to that of an information bureau and an automatic registering machine. This commission has not even the power to make the issuance of the \$300,000 of serial bonds conditional on the retirement of the \$450,000 par value of bonds held by the Madison & Interurban Traction Company and the \$50,000 par value of stock held by the Southern Wisconsin Traction & Light Company and the \$815,000 par value of bonds which have been authorized and have not been issued by the Southern Wisconsin Railway Company.

The suggestion has been made that if this commission authorizes the present issue of \$300,000 serial bonds it will thereby confirm all previous bond issues of the Southern Wisconsin Railway and its predecessors. This is true neither in fact nor in law. The legislature and not this commission authorizes the present issue. Inflation of the capital issues of the past, no matter how flagrant, is not recognized in the stock and bond law and cannot govern this commission in performing its duties under it. Although there is not a trace of authority for such an assumption in the law, in view of the fact that it has been contended that we would justify all previous bond issues on the part of the Southern Wisconsin Railway and its predecessors and place our official stamp of approval upon the same by issuing a certificate for the present issue, we desire expressly to state that such a construction of our present official act would do violence both to the fact and the law.

#### INSULATING VARNISHES AND COMPOUNDS.

H. S. Cooper, manager Galveston Electric Company, relates some interesting and valuable experiences with insulating varnishes and compounds in the January issue of the Stone & Webster Public Service Journal. He says:

About 10 years ago I made quite a number of experiments with insulating varnishes and materials for armature and field use for railway motors. These involved nearly all the gums, mineral, vegetable and animal, that could be used as insulators, and the results were in favor of the one animal insulating gum "lac," which, in its commercial form of thin scales common called "shellac," is well known to all those having to do with armature and field work. The peculiar quality of shellac is that its insulation increases up to its melting point and decreases very slowly from there on until it comes to its carbonization point, at which, of course, it gives away entirely. This is true of no other gum used for insulation—all of them deteriorate very rapidly as the temperature increases, and nearly all of them have a much lower carbonization or "breaking down" point than shellac. The result of these experiments determined me to use shellac entirely, and I have, therefore, done this for over 10 years with the best of results. There is (as in all other materials) shellac and shellac, and after determining the question of shellac I had to determine the question of the kind and quality to use. After a good many trials I found that it was best, in order to obtain known results, to mix our own shellac, as under no circumstances could I obtain from any one a shellac that we could make standard. I have, therefore, since that time, bought shellac from the importers, buying next to the finest quality that is imported of fine orange shellac; and I dissolve five pounds of this to the gallon in from 95 to 98 per cent grain alcohol. I have tried all other solvents, including the wood and other alcohols, and find that grain alcohol is the one that will dissolve the most of the constituents of "lac," which, in its nature, is a gum of different constituents and has no one complete solvent that can be used to make a liquid for electrical work. This proportion of five pounds of shellac to the gallon of 95 to 98 per cent alcohol, gives a mixture thick enough for any purpose desired and which, at the same time,

can be made as thin as is necessary for any purpose where a thin varnish is required, simply by the addition of more of the same alcohol.

At the above time, also, I was looking for a thick paste which could be used for the filling in of holes in commutators, burned out places in armature bodies and body insulation and for such general insulating uses. After an experiment with all sorts of compounds, such as whitening, powdered pumice stone and various other powders, I tried the sawdust from the cutting of the compound mica sheets, such as are made by the Mica Insulator Company. These sheets are made by the placing of very thin sheets of mica one upon the other, cementing with pure shellac as above, and these, when dried, are sawed into different shapes by small toothed saws, and the resulting fine "sawdust," when sifted, is a compound of very fine mica scales and shellac. By taking this dry powder and mixing it with the above shellac varnish to the consistency desired and thoroughly drying same in place, I found that I had something which adhered indefinitely to the substance to which it was attached, gave high insulation, and did not crumble, crack or disintegrate.

I have wound fields of the old type GE-16 street car motors in which the copper in the fields had fused, and the insulation around the fusing and between the fields and the shellac was so perfect that we simply had to replace the portion of wire melted. I have also used it in filling up large holes in commutators, in the bodies of armatures, etc., and at the present time am using it here absolutely, where our necessity for a good insulation is very great, and am having better results than I find are obtained elsewhere (under less exacting conditions and with other compounds). The only care that had to be taken in regard to the use of either the above shellac varnish or the mica dust paste is that the drying out must be very gradual. This is true of very nearly every kind of insulating compound, but it seems to be especially true in regard to any compounds which contain water in themselves or in their solvent. If the drying of the armature or field is too sudden at first, that is to say, if the temperature is raised too quickly, the varnish will dry on the outside and make a hard shell almost impenetrable to the moisture inside, and the result will be that either the moisture is retained in the interior or, in drying out, it is forced to the surface in the form of steam and will puncture a small hole leading from the outside to the center, through which moisture, or some conductor like copper dust or carbon dust, may find its way. Where the baking is gradually done and the temperature allowed to increase very slowly, so that the outside of the armature or field is not at any time many degrees hotter than the inside, the moisture is allowed to thoroughly escape while the varnish or compound is somewhat soft all over and, in consequence, the aperture left by it in escaping is self-closed.

My practice has been, in an ordinary street car armature, such for instance as either the GE-800 type or the 52, 54, 56 and others, to give at least two weeks' baking, not allowing the temperature for the first week to get over 150 to 200 degrees F. After this the temperature can be rapidly forced up to the point where the piece will give out a rather acid smell, which is well known to those drying shellac varnish work, and which is the point at which the baking should be stopped. One advantage of the use of the shellac is that a slight overbaking, such as might easily happen, or a mistake in temperatures, or leaving it in the oven too long, cannot in any way injure it, unless it is carried very close to the carbonization point.

I have tried every other make and kind of insulating varnish, paint and compound for over 15 years, and subject to the above conditions of quality, solution and baking I have found no other one or two or many varnishes or compounds that will give as good all-round results. This is true only of a fine quality of pure shellac dissolved in pure 95 to 98 per cent grain alcohol and treated properly in "baking out" when used.

The Compania Electrica y Ferrocarriles de Chihuahua will this month take over all the properties of the local street car company, the Chihuahua Mineral Railroad, of Chihuahua, Mexico, and the electrical department of the Compania Industrial Mexicana. This will include all the lights and electrical power in the city, the present street railway system now being converted into a trolley line, the narrow-gauge steam railroad to Santa Eulalia, which now runs four regular mixed trains a day, and the aerial tramways connecting the railroad and town of Santa Eulalia with various mines. The new corporation will open offices in Chihuahua. For the present work will be confined to the city lines, but later the entire line of the Mineral railroad will be converted into a trolley system. The city lines are expected to carry freight and the company will probably build sidings to business houses and haul cars from the Central, Chihuahua & Pacific and Orient railroads direct to consignees. A. C. Nash will be general manager of the new corporation.



### REPRESENTATIVES OF STATE COMMISSIONS EXPRESS VIEWS ON ACCOUNTING SYSTEM.

In response to requests from the Electric Railway Review the following representatives of state railway commissions have expressed themselves regarding the uniform accounting system for electric railways, which is in course of preparation:

**William O. Seymour.**

William O. Seymour, member Connecticut railroad commission: "I think a system of classification of operating expense accounts of electric railways, practically uniform with the system for steam railroads, can and will be devised, and so amplified as to be adaptable to both small and large roads, and the companies will soon become so familiar with its application as to use it with the same facility as the form heretofore used, the number of accounts to depend upon the extent and variety of the business of the company. Only certain essential accounts should be required of roads with gross earnings not exceeding \$200,000 per annum, and the complete form should be applicable to all roads the earnings of which exceed that amount. The importance of practical uniformity in the system of accounting of steam and electric roads is emphasized by the fact that today many electric roads are doing precisely the same kind of business as the steam roads, and electrical operation is rapidly being extended over lines heretofore operated by steam. From the standpoint both of the public and the manager it should be made possible to intelligently compare the cost of the two methods of operation. This cannot be done without a uniform system of operating expense accounts."

**Thomas Yapp.**

Thomas Yapp, assistant secretary Minnesota railroad commission: "I consider that the tentative classification of operating expenses recommended by the committee, consisting of 116 main accounts, would be desirable for city or interurban electric railways—first, because it conforms closely to the classification for steam railroads; second, because the principles involved in the steam classification already adopted should apply to all transportation companies alike, uniformity being the desired end; third, in view of the rapid progress being made in electric and interurban lines in this country it is desirable to have as complete a system of accounting as possible. I do not think the adoption of the classification above referred to would work any hardship upon the electric railways, as it was stated at the conference held recently that some of the big electric systems had already operating accounts in excess of 116, being in the nature of subdivision accounts. It also developed at the conference that it would work a hardship on the electric lines doing a small business if they were compelled to keep 116 main accounts of operating expenses; and in view of this fact a second tentative classification was at once prepared which embodied 21 accounts instead of 116. The dividing line between the small and large systems in my opinion should be based upon gross earnings, as follows: Roads earning \$75,000 or less per annum should use the smaller classification, and those earning in excess of the above figure should use the larger classification. No reforms were ever made without changing conditions, and I am free to state that it is the intention of the interstate commerce commission as well as all state commissions to be absolutely fair to all parties interested; and after the classifications have been promulgated and given a reasonable trial they could be somewhat modified on the showing that portions of them were unreasonable, but the principles involved must be followed out."

**William J. Meyers.**

William J. Meyers, chief division of statistics and accounts, New York public service commission, second district: "This commission has not yet expressed itself more fully upon the point concerning which you inquire than to say that it considers it advisable that the classification of accounts for electric railways should conform as closely as practicable to that provided for steam railroads. Under the circumstances you will recognize that I should not care to express any opinion upon a controverted point until after the commission itself has considered the matter. None of us is aware of any reason for thinking that such a system of accounting as is contemplated will work any hardship upon electric railways. Those who are actively engaged in the management of such properties must be relied upon to point out any objections of this character if such there are. With regard to the amount of gross earnings which should entitle an electric railway company to use the abbreviated classification of operating expense accounts agreed upon last month in

Washington for submission for the purpose of getting the opinions of those concerned, it seems to me that the amount should be placed low. The cost of stationery for keeping the more detailed accounts is not excessive and with very little thought and study given to the matter the person in charge of the accounts can readily apportion the cost of operation among the accounts proposed in the more ample scheme."

**A. F. Weber.**

A. F. Weber, chief statistician New York public service commission, first district: "The commission for the first district has as yet taken no action in regard to the accounting of street railways, and, of course, no individual is in a position to say what its action will be. So long as the matter is under consideration it would be manifestly improper for me to discuss its policy, and I can only say that so far as my own recommendations are concerned they will be given in favor of such a classification of accounts (for the fiscal year beginning July 1 next) as will be best adapted to the street railway situation in New York City. I do not consider the original tentative classification of the interstate commerce commission as having properly met this requirement, as it was too closely patterned after the steam railroad classification."

### "SEEING MEXICO" PARLOR CAR SERVICE.

For the accommodation of the large number of tourists who annually visit the City of Mexico and its surrounding points, the Mexico Electric Tramways Company, Limited, of Mexico City,



Interior of Special Cars for "Seeing Mexico" Service.

has established a special "Seeing Mexico" parlor car service. The cars used on these trips, one of which is illustrated herewith, were specially designed and constructed for the purpose, and in the elegance of their appointment and finish are said to be the handsomest street railway palace cars on the American continent.

The Mexico Electric Tramways system comprises upward of 200 miles of street railways, reaching every point within the jurisdiction of the federal district, and extending beyond the boundaries of the federal district out into the state of Mexico. Under these conditions it is possible to obtain a better idea of the city and its environs in the cars and special "Seeing Mexico" trains than by any other means.

In these special trips each party will be accompanied by a competent guide, who, speaking both English and Spanish, will briefly give a description of each interesting point passed by the car.

Two trips are made daily, one in the morning and the other in the afternoon, starting from the Plaza de la Constitucion, the central point of the city, the time required to make each trip being a trifle more than three hours. These trips have been especially established with the endeavor of acquainting visitors with all important points reached by the company's lines, and if taken advantage of will give an idea of the city, its varied industries, its people and architecture, impossible of attainment by any other means. Every foot of ground

covered in these trips is replete with a constantly changing panorama of historical interest, combined with pleasure and romance.

Special cars may be chartered for sight-seeing or excursion trips on all days except Sundays and important national holidays.

The service was started on January 2 and will continue during the tourist season, which usually lasts three or four months. Every effort possible has been made to make the trips attractive, interesting and instructive to visitors.

The company has issued a booklet, printed in both English and Spanish, describing the new service and the more important points of interest, which are illustrated by halftone engravings.

Mr. Harro Harrsen is general manager of the Mexico Electric Tramways.

#### DETROIT COUNCIL COMMITTEE RECOMMENDS T-RAIL.

The streets committee of the Detroit common council was recently appointed to visit a number of cities where T-rail is used by the street railway companies. This committee will advise the council in regard to the application of the Detroit United Railway for permission to reconstruct its tracks on Jefferson avenue, using T-rail in place of the grooved girder rail now required by ordinance. This committee after an inspection of the tracks in Grand Rapids, Milwaukee, St. Paul and Minneapolis, on December 27, submitted the following report, advising that the company be permitted to use the T-rail:

In Grand Rapids the company operating the street railway system uses a 91-pound T-rail, laid on a gravel foundation, using a special grooved granite block, which takes the place of the iron groove in the rail used by the local company. In this instance the granite block is not laid under the head of the rail, but a cement mortar is placed against the web of the rail to take up the space under the head or top of rail, and the granite grooved block is then laid next to the mortar, which is done for the purpose of not disturbing the pavement should there occur a depression of the track.

In Milwaukee the company operating the railway system uses a 97-pound T-rail, laid on a 6-inch concrete foundation. As to the pavement between the track the company uses an arched or circular section which gives a crown in the pavement nearly equal to the head or top of rail, which construction in the judgment of your committee is undesirable.

In St. Paul and Minneapolis the street railway systems are operated by one company, called the Twin City Rapid Transit Company. They use a 91-pound T-rail with a 6-inch base, 7 inches in depth, same as other cities visited. A gravel foundation is used throughout the entire systems, except in the central portions of each city, where a concrete foundation is used. Granite block is used almost entirely in both of said cities, but the same, while grooved, is laid against the web and under the head of rail instead of being laid away from rail as is done in Grand Rapids, using a flat section across tracks, so that the groove of the granite block takes the place of the steel groove of the rail used in our city.

The sum and substance of the conditions in all cities are these: The companies use a 60-foot 7-inch T-rail, weighing from 91 to 97 pounds per yard. In Grand Rapids, Milwaukee, St. Paul and Minneapolis the companies use the cast welded joint, while in Grand Rapids they also use what is called a continuous joint.

The cast welded joint is exceptionally well thought of in those cities, because of the smooth riding and continuity of the track, and also because the pavements have seldom, if ever, to be disturbed to bond the rails with copper wire for the conveyance of the electrical current and it is stated that less than 1 per cent of these joints require any further attention. The continuous joint is also held in high regard, but your committee is of the opinion that, while both of the methods employed have given good results, neither one or the other should be specified. Inasmuch as the company has taken the initiative in this matter, we believe that they will use whichever joint is best adapted to local conditions, and we therefore recommend that the commissioner of public works grant said company permission to reconstruct the tracks on Jefferson avenue, from Woodward to Beaufait avenues, on the express condition that the company use a 60-foot 7-inch T-rail, weighing from 91 to 97 pounds, using granite block between tracks and 18 inches outside.

No action has yet been taken by the council on the report. The company is favorably impressed with the T-rail and wishes to make an experiment with it, believing that it possesses the following advantages over the grooved rail:

1. It will reduce maintenance cost and require no attention in keeping clean.
2. It will reduce noise, the flanges having only one surface to grind against as opposed to two and in places three surfaces with the grooved rail.
3. It will require less attention to paving because, with the foundation material upon which the company has to build—a Canadian or blue clay of a plastic nature—it is hard to maintain the alignment even on the most solidly build subbed, and the slightest shifting causes cracks and seams or "bulges" in the paving material, requiring constant repairs.
4. It will be less damaging to rolling stock because there is no groove to become clogged, causing jars by an uneven surface.

#### DIRECTORY OF ELECTRIC RAILWAY ASSOCIATIONS.

American Street and Interurban Railway Association. Secretary, Bernard V. Swenson, 29 West Thirty-ninth street, New York.

American Street and Interurban Railway Accountants' Association. Secretary, Elmer M. White, 29 West Thirty-ninth street, New York.

American Street and Interurban Railway Claim Agents' Association. Secretary, B. B. Davis, claim adjuster Columbus Railway & Light Company, Columbus, O.

American Street and Interurban Railway Engineering Association. Secretary, J. W. Corning, electrical engineer Boston Elevated Railway, Boston, Mass.

American Street and Interurban Railway Manufacturers' Association. Secretary, George Keegan, 2321 Park Row building, New York, N. Y.

California Electric Railway Association. Secretary, L. E. W. Ploda, Oak and Broderick streets, San Francisco, Cal.

Canadian Street Railway Association. Secretary, Acton Burrows, 157 Bay street, Toronto, Ont.

Central Electric Railway Association. Secretary, W. F. Milholland, secretary and treasurer Indianapolis Traction & Terminal Company, Indianapolis, Ind. Next meeting, Dayton, O., January 23, 1908.

Colorado Electric Light Power and Railway Association. Secretary, John F. Dostal, Denver Gas & Electric Company, Denver, Colo.

Electric Railway Shop Foremen's Association. Secretary, J. R. Case, Public Service Corporation of New Jersey, Newark, N. J.

Iowa Street and Interurban Railway Association. Secretary, L. D. Mathes, general manager Union Electric Company, Dubuque, Ia.

Massachusetts Street Railway Association. Secretary, Charles S. Clark, 70 Kilby street, Boston, Mass. Meetings held in Boston on second Wednesday of each month, except July and August.

Michigan Electrical Association. Secretary, A. C. Marshall, Port Huron, Mich.

Missouri Electric Light Gas and Street Railway Association. Secretary, Charles Z. Pierson, St. Charles Electric Light & Power Company, St. Charles, Mo.

National Amusement Park Association. Secretary, C. H. Oberheide, Trenton, N. J. Annual meetings, third Tuesday of each November.

New England Street Railway Club. Secretary, John J. Lane, 12 Pearl street, Boston, Mass. Meetings held on fourth Thursday of every month.

Northwestern Electrical Association. Secretary, R. N. Kimball, Kenosha, Wis. Annual meeting, Milwaukee, Wis., January 15 and 16, 1908.

Oklahoma Electric Light, Railway and Gas Association. Secretary, Charles W. Ford, Oklahoma City, Okla.

Pennsylvania Street Railway Association. Secretary, Charles H. Smith, superintendent Lebanon Valley Street Railway, Lebanon, Pa.

Southwestern Electrical and Gas Association. Secretary, R. B. Stichter, Dallas, Tex.

Street Railway Association of the State of New York. Secretary, J. H. Pardee, 611 West One Hundred and Thirty-seventh street, New York, N. Y.

Wisconsin Electric and Interurban Railway Association. Secretary, Clement C. Smith, president Columbia Construction Company, Milwaukee, Wis.

**RECENT ELECTRIC RAILWAY LEGAL DECISIONS.**

BY J. L. ROSENBERGER, LL. B., OF THE CHICAGO BAR.

**Transfer Sufficiently Requested.**

Sullivan v. Brooklyn Heights Railroad Company, 106 New York Supplement, 378.—The supreme court of New York, appellate division, second department, holds that a passenger adequately requested a transfer from the conductor at the time he paid his fare, where it appeared that he gave to the conductor a transfer he had, and held out his hand to receive another, when the conductor, muttering something, passed on.

**No Reason to Stop When Way Seemed Clear.**

Hess v. United Railways Company, 105 Southwestern Reporter, 277.—The St. Louis court of appeals holds that there was no apparent danger of a collision which ought to have induced a motorman to stop, where the testimony went to show that as the car started to go by a wagon the pathway was clear, with nothing in the situation to suggest danger of a collision, and that the accident occurred by a sudden movement of the horse while the car was passing.

**Neighboring Property Benefits from Improving Street So That Street Railway Seeks Extension.**

In re Harvard Avenue North, 92 Pacific Reporter, 410.—The supreme court of Washington says that it was urged that the improvement for which an assessment had been approved was of little, if any, benefit to the property included within the assessment district, and that it would be of no practical benefit to any one except to the street railway company. The improvement, it was true, might afford the railway company more convenient facilities for the extension and construction of its line; but such fact did not establish that benefit did not accrue to the property in the district. The mere fact that a street is so improved that a street railway seeks to extend its line thereon may well be considered as an element of special benefit to the neighboring property.

**Liability for Assault of Conductor on Passenger Waiting for Transfer After Alighting.**

Blomness v. Puget Sound Electric Railway, 92 Pacific Reporter, 414.—The supreme court of Washington says that the testimony of the plaintiff was to the effect that at the time he paid his fare to the conductor he asked for a transfer and the conductor replied, saying: "I will give you that between Georgetown and Seattle;" that he did not see the conductor as he was issuing transfers; that he saw the conductor and asked him for a transfer just before the train stopped; that when it stopped the conductor told him to step to one side, and that another request for a transfer was followed with some words and the conductor struck him over the head with a lantern. The court thinks that, under all authority and in accordance with principles of right, the plaintiff should be deemed a passenger at the time of the assault and should be allowed to recover damages.

**Duty of Pedestrians Walking on or Near Tracks Owing to Obstructions in Streets.**

Mey v. Seattle Electric Company, 92 Pacific Reporter, 283.—The supreme court of Washington holds that where a street was more or less occupied by debris, but there was room for a pedestrian to step out of danger every few steps along such route, the motorman of a car going in the same direction might well be justified in concluding that he would step out of the way of the car, instead of remaining on the track, or so close to the track that he would be run down by it. It thinks that it was the plain duty of the pedestrian, while traveling in close proximity to the street railway track in a place where he knew that cars were passing at short intervals, to have exercised the ordinary caution of noticing, when he passed those points where there was not room enough

for both man and car, whether there was any car which was liable to injure him. Not having exercised this ordinary caution, the court thinks that the plaintiff, such a pedestrian, was undoubtedly guilty of contributory negligence, and that a judgment was properly entered in favor of the defendant.

**City Necessary Party for Settlement of Controversy Between Companies.**

Tacoma Railway & Power Company v. Pacific Traction Company, 155 Federal Reporter, 259.—The United States circuit court, in Washington, holds that in a controversy between two rival street railway companies as to the right to occupy with railway tracks the center of a public street the court cannot determine that controversy where there is an unsettled controversy between the city government and the complainant concerning the matter and the city is not made a party to the suit.

**Company's Possession of Tracks Presumed to be Exclusive.**

Jennings v. Brooklyn Heights Railroad Company, 106 New York Supplement, 279.—The supreme court of New York, appellate division, second department says that the allegation of the complaint that the defendant had an electric railroad through Thirty-ninth street for the carrying of passengers having been admitted by the defendant's answer, the court could not presume that some other railroad company also ran its cars over the defendant's tracks. It was therefore not necessary for the plaintiff to show that the car that hurt him was the defendant's. That fact followed from the fact that the railroad tracks were the defendant's. If there was evidence of the cars of another company running over the defendant's tracks, the case might be different; but that fact was not to be presumed. The presumption was to the contrary, namely, that the defendant's possession was exclusive. No other company could be running cars over the defendant's tracks except by its consent. Its right and possession must at first have been exclusive, and the presumption was of continuance, not of change.

**Inexperience of Motorman and Absence of Conductor May be Considered in Determining Whether Car was at Full Stop or Not.**

Shepherd v. Lincoln Traction Company, 113 Northwestern Reporter, 627.—The supreme court commissioners of Nebraska say that it was natural, therefore probable, that an inexperienced motorman would be more likely to mismanage the car upon which the plaintiff was riding than one of much experience. His want of acquaintance with the route and the crossings where stops were to be made, especially on a dark night, would more likely lead to his confusion and inability to handle the car with the same degree of care as one of more experience. So, also, the presence of a conductor, whose business it was to direct the halting and starting of the car by signals given the motorman, would tend greatly to increase the probability of the car being handled in the careful manner that would not otherwise obtain. This being so, these were circumstances, which the court might properly direct the jury they were at liberty to consider in determining whether the witnesses for the plaintiff or defendant were most likely to be correct upon the question of whether the car had been brought to a halt at the time the plaintiff attempted to alight therefrom, and had been suddenly started while she was in the act of getting off. The probability that an inexperienced motorman, having no assistance from a conductor in the management of his car, would be likely to mismanage the same to the injury of some of the passengers, was a circumstance which might properly be considered in support of those witnesses who testified to mismanagement, in opposition to those who testified that there was no mismanagement on the part of the motorman. There was a conflict which the jury had to determine. Any fact or circumstance which would aid them in that duty was relevant to the issue, and was for

their consideration. Any circumstance which rendered more probable the fact testified to by one set of witnesses, when opposed to that of another set, was a relevant fact proper to be considered.

#### Liability for Injury from Defective Gate as an Appliance.

*Stappers v. Interurban Street Railway Company*, 106 New York Supplement, 854.—The city court of New York, trial term, holds that if a gate upon a surface street car is within the definition of "defective machinery, imperfect cars and other conditions endangering the success of the undertaking," it is within the rule requiring "the highest degree of care which human prudence and foresight can suggest." A gate on the side of an electric surface car is an appliance. It is a part of the car attached to it by hinges, and, when shut, fixed at the other end by a hook. It is part of the machinery "availed of for the operation of the railroad." When the car is crowded a defective gate may lead to most serious injury, and its improper maintenance cause "loss of life or limb to the traveling public." The condition of travel shown required the utmost care in the maintenance of the gates on the street cars of this city. A secure gate is "essential to safety of operation." Whether the company met this obligation was properly submitted to the jury.

A passenger is not called upon to provide against a defective appliance, unless such defect is shown to have been known, or under the circumstances should have been observed, by him. The only precaution which could be taken against a concealed defect in an appliance would be to refrain from riding on the car. Lack of proof, therefore, that the plaintiff took precaution against negligent operation does not require that the complaint be dismissed, or that a verdict be directed for the defendant, where the cause of action is based upon the defendant's negligence in maintaining an appliance. The question for the jury was, as charged, whether the defendant exercised the skill, care and foresight in the maintenance of this appliance for the protection of its passengers required by law, and, if not, whether the plaintiff's injuries were caused solely by such careless maintenance.

#### Liability for Injuries from Motorman Leaving Controller and Passenger Turning on Power.

*Mooney v. Seattle, Renton & Southern Railway*, 92 Pacific Reporter, 408.—The supreme court of Washington says that the defendant's car line between the city of Seattle and the town of Renton descends from Jackson street to Dearborn street, a distance of four blocks, at a grade of 11 per cent. At Dearborn street a switch turns the south-bound cars to the right-hand track as you go south, and from that point a double track is maintained. The plaintiff became a passenger on an outgoing car. The seats were all filled, and passengers were standing in the aisle and on the front and back platforms. The plaintiff occupied a standing position on the back platform near the car door. As the car passed Jackson street, the motorman set the brakes, turned off the power, and left his post at the controller to close a gate at the side of the car. While thus engaged, one of the passengers stepped up to the controller, released the brakes, and turned on the power. As he did so, the car shot ahead and soon attained a speed of from 25 to 30 miles per hour, and as it rounded the curve onto the switch at Dearborn street, the plaintiff was hurled from the car.

At the time of the trial, some nine months after the accident, the plaintiff was seriously crippled and unable to perform labor or follow his usual occupation, that of barbering. He recovered a judgment for \$5,000 damages, from which the trial court required a remission of \$1,500. The judgment for \$3,500 is here affirmed.

In the supreme court's opinion, a motorman in charge of a car loaded with passengers, who sets his brakes, turns off his power, permits his car to descend an 11 per cent grade without

a guiding hand, leaves his controller surrounded by passengers, any one of whom may release the brakes or turn on the power at will, and goes so far from his post of duty that he cannot return thereto until the car has sped a distance of four or five blocks, without some controlling necessity for such action on his part, is guilty of gross and inexcusable neglect; and the defendant could not be prejudiced by any charge the court might give on the question of its negligence.

#### Duty of Motorman Observing a Horse or Team Manifesting Fright.

*Metropolitan Street Railway Company v. Fawcett*, 92 Pacific Reporter, 543.—The supreme court of Kansas holds that in an action brought by the driver of a carriage against a street car company for personal injuries resulting from a collision between the carriage and a car, evidence is pertinent of the management of the car and of the conduct of the driver from the time the horse manifested such fear of the approaching car as should have attracted the attention of the motorman to the time of the collision. It says that it may be asserted as a general proposition of law that whenever a motorman in charge of a swiftly running car observes, and he must constantly watch, a horse or team which is being driven in close proximity to the car track and which manifests fright, it is his duty to reduce his speed preparatory to a sudden stop, if it becomes necessary. His precaution should be proportionate to the apparent danger. If it be generally true that a single driving horse, frightened by an object approaching from the front, is more difficult to control than a double team, and more likely to wheel so suddenly around as to upset the carriage and its occupants, the motorman must recognize this fact and act accordingly.

#### Enforcement of Ordinance Requiring Stops Will Not be Enjoined.

*Georgia Railway & Electric Company v. Town of Oakland City*, 59 Southeastern Reporter, 296.—The supreme court of Georgia says that the municipal authorities passed an ordinance requiring street cars traversing a street named to be stopped at the points already in use (except one) and also at three additional points to receive passengers who might there seek to board such cars, and signal or give notice of their intention to do so. The company filed an equitable petition, seeking to enjoin the enforcement of the ordinance by frequent arrests and trials of its employes for violating it. The petition alleged that the ordinance was void on the grounds that it was unconstitutional, that the defendant had no power under its charter to enact the ordinance, and that such ordinance was unreasonable. It was claimed that to allow such arrests and prosecutions would cause a multiplicity of cases, would interfere with the running of its cars and schedules, and disarrange the schedules established by the company. The evidence was conflicting as to the necessity or convenience of making the stops at the fixed places.

Without determining whether the ordinance complained of was valid or not or whether it was in whole or in part unreasonable, the court says that the facts of this case were not such as to require the reversal of a judgment refusing an injunction. The general rule is that a court of equity has no jurisdiction to enjoin criminal prosecutions; and this rule is applicable to proceedings to punish for violations of municipal ordinances, which are quasi criminal in their nature. The cases in which proceedings to enforce such ordinances will be enjoined are exceptional in character. There was no effort to take away property or property rights, or to destroy or substantially impair a franchise. The ordinance was a police regulation of travel in the street of a municipality. It was not shown that any irreparable injury would result; but, at most, a small interference with the schedules which the company desired to maintain, while the cases made against its employes proceeded to trial when the validity of the ordinance could be tested.

# News of the Week

## Brooklyn Tunnel Opened.

The extension of the Interborough Rapid Transit subway under the East river from the Battery to the Borough hall in Brooklyn was opened for regular passenger traffic shortly after midnight on Thursday of this week. Trains had been run through the tunnel for several days to familiarize the trainmen with the situation and to allow the company's officials and prominent engineers to inspect the tunnel. The operation of the tunnel has been looked forward to by the residents of Brooklyn for several years and was received with great joy, as it is expected to relieve to a considerable extent the great congestion of traffic at the Brooklyn bridge. Plans have been made for a formal celebration of the event. General Manager Frank Hedley of the Interborough Rapid Transit Company has announced that all Lenox avenue and West Farms express trains will run through to Borough hall, while the Broadway expresses will turn at the Battery as formerly. But after the express trains are discontinued at night the Lenox avenue and West Farms locals will run to Brooklyn and the Broadway locals to the Battery only. When the express trains are in operation all local trains will turn at the City hall loop.

## Improvements at the Brooklyn Bridge Terminal.

Elevated trains on the Brooklyn bridge came 100 feet farther over Park row at the Manhattan end of the bridge on January 4 than ever before. The extension of the island platform was opened for the first time and the slips now extend across Park row. Work has been begun on new loop tracks at the Brooklyn end of the bridge and within a few days a new system of running trains and trolley cars across the bridge will be installed.

The east end of the island platform at the Manhattan end is being cut off to make room for additional switches between the island, incoming and outgoing platforms, and when the entire length of the extension across Park row is completed there will be room in the slip for an additional car and 6-car trains will be run over the bridge instead of 5-car trains.

As soon as the new trolley tracks are laid at the Brooklyn end of the bridge a trolley service similar to that on the Williamsburg bridge will be installed. There will be bridge trolleys running at about 1-minute intervals, which will go only from one end of the bridge to the other and back. These will carry all local bridge passengers for a 2½-cent fare.

When the local trolleys are started there will be no more local elevated trains. All local passengers will be carried on the trolleys and all elevated trains will be through trains during the rush hours as at other hours of the day.

## New York City Railway Receivers Protest Against Order of Commission.

Adrian H. Joline and Douglas Robinson, receivers for the New York City Railway, have sent a communication to the public service commission replying to the order of the commission that all of the company's cars shall be sent to the repair shops and completely overhauled at the rate of 10 a day. The letter states:

"We do not concede the correctness of the recital of fact contained in your order to the effect that the equipment, appliances and devices in question are unsafe or improper, or that the repairs directed by said order ought reasonably to be made to promote the security of the public, or that the time given within which to make such repairs is reasonable.

"As stated in our letter to you of December 20, we have been engaged since our appointment in pushing as vigorously as possible, with all available means at our command, the work of repair and maintenance of the rolling stock operated by us. Although laboring under great disadvantages, we have made notable progress so that by the early part of December the number of cars disabled on the road had been reduced to less than half the number disabled under similar conditions immediately prior to the receivership. While admitting that for causes entirely beyond our control the rolling stock is in many respects inadequate, we take issue with the statement that it has been at any time during the receivership, or is now, unsafe either for the public or our employees. Our entire effort has been directed (and we think successfully) toward giving the best possible service to the public consistent with the physical facilities and money which we have had at our disposal. The equipment has been rehabilitated as rapidly as was possible under the circumstances, having due consideration to the necessities and conveniences of the traveling public. We cannot promise or undertake, with the facilities and

resources at our command, a full and literal compliance with the provisions of your order."

The receivers are also ordered to notify the commission daily of the number of cars repaired and the number of cars run into the shops for repairs.

## Philadelphia Strike Averted.

The differences between the Philadelphia Rapid Transit Company and its employees, who have recently organized a branch of the carmen's union and have for several weeks been threatening a strike, were settled on Tuesday by the intervention of Mayor Reyburn. It is now stated that all possibility of a strike has been averted. The mayor, at the instance of the Central Labor Union, addressed a letter to J. B. Parsons, president of the company, asking for the reinstatement of 65 men, said to have been discharged for joining the union. He also stated what the men considered their grievances and asked that the company arrange for a settlement of the difficulties in the interests of the public. Mr. Parsons immediately replied to the mayor, agreeing to reinstate 48 of the 65 men, who, he said, had been discharged for "neglecting the interests of the company for others which they deemed more important." The other 17 men were discharged for other causes and will not be reinstated. With regard to the other grievances of the men Mr. Parsons' letter was as follows:

"We never, in a proper sense, have refused to hear an appeal from our employees, and any suggestions which they make as to schedule will receive our careful consideration. In order that this matter may be taken up regularly the company will fix one day a month, when any discharged employe or any employe with a grievance may appear before the general manager, either alone or accompanied by a committee of, say, three of his coemployees, to present any appeal or suggestions touching their relations with the company. With regard, however, to an increase in wages, I have already explained to you that the present financial conditions of the company make it impossible."

## Strike on Local Lines of the Indiana Union Traction Company.

The strike of the motormen and conductors employed on the local lines of the Indiana Union Traction Company, which was declared on January 1, as reported in last week's issue of the Electric Railway Review, has developed into such a serious situation as to require the use of the militia and practically suspend business in Muncie. The most serious trouble has occurred at Muncie, but Anderson and Marion have also been affected by the strike. As previously stated, the difficulty has been caused by the company's signing a wage contract with the Brotherhood of Interurban Trainmen, of which the majority of its employes are members, instead of with the Amalgamated Association of Street and Electric Railway Employes, to which the local trainmen belong. The company's position is that it can recognize but one association and has consequently chosen the most representative.

The developments of the first three days of the strike were reported in last week's issue. The places of the strikers in Anderson and Muncie were taken by professional strike-breakers from Chicago, whose presence so inflamed the mob of unemployed men at Muncie, where they are especially numerous, that the company found it impossible to run its cars. In the riots on Wednesday and Thursday of last week several cars were damaged and several persons were shot by the strike-breakers. It is noteworthy that the striking employes have been little in evidence and that nearly all of the violence has been at the hands of irresponsible labor enthusiasts and sympathizers.

Late Friday afternoon, when the company attempted to run cars, a mob of nearly 3,000 collected and in spite of the efforts of the local police authorities, the rioting became so serious that several companies of the Indiana National Guard, who had been stationed at Indianapolis in readiness, were required to restore order. At noon on Saturday Governor Hanly proclaimed martial law in Muncie and vicinity and the mayor ordered the saloons closed. Five hundred business men were sworn in as special deputies. With their assistance the police and the soldiers were able to prevent any serious outbreaks and the company resumed the operation of its cars. On Sunday the imported strike-breakers were returned to Chicago and regular uniformed men were placed on the cars, some of them being local men and others out-of-town men, who are said to have been permanently employed. On Monday cars were operated until 10:30 at night. This week obstructions have frequently been placed on the tracks, but nothing more serious has happened.

On Saturday 27 members of the union at Marion declared a strike, but their places were readily filled and the service was only slightly disturbed. At Anderson there has been no violence, the strike taking the form of a boycott. At the request of the citizens the strike-breakers were sent away last

week. On Monday a citizens' committee, appointed for the purpose of urging the company to arbitrate, called upon President A. W. Brady of the company. Mr. Brady informed the committee that it would be impossible to arbitrate because of the contract with the brotherhood.

The company's interurban service has not been affected by the strike. This week the authorities at Muncie have attempted to effect some sort of a settlement, as business has been partially suspended and the expense of enforcing order has been very great. On Monday A. L. Behner and Frederick Fay, officers of the Amalgamated association, were ordered to leave the city by the local authorities, who declared that the men stood in the way of a settlement and were interfering with the peace of the community. On Tuesday Governor Hanly arrived in Muncie to investigate the situation personally and the question of withdrawing a part of the soldiers was discussed.

W. D. Mahon, president of the Amalgamated association, arrived in Muncie on Tuesday to take charge of the strike. The state labor commissioners tried to arrange a compromise whereby the company should sign a contract for the local men with the Amalgamated association and apply the contract with the brotherhood to the interurban service. Mr. Mahon declined to consider a compromise.

**Design of High-Voltage Power Stations.**—On Monday, January 13, David P. Rushmore, Schenectady, N. Y., will present a paper on "The Design of High-Voltage Power Stations" before the Philadelphia section of the American Institute of Electrical Engineers.

**New Depot Route Established in Chicago.**—The Chicago Union Traction Company has obtained permission from the board of supervising engineers to operate its North State street cars as far south as the Polk street station of the Chicago & Western Indiana Railroad. The cars will run south on State street to Washington, west to Dearborn and south to Polk. Heretofore the cars have stopped at State and Lake streets.

**New Haven Road Adopts Single-Phase Equipment for Branch Line.**—The New York New Haven & Hartford Railroad has decided to change the equipment of its New Canaan branch, running from Stamford to New Canaan, Conn., 7½ miles, from 600-volt direct current to 11,000-volt single-phase. Two trains, each consisting of a 60-ton motor car equipped with four 125-horsepower motors and a 30-ton trail car, will be operated.

**British Association Considers Brakes.**—A committee of the Tramways and Light Railways Association of Great Britain, which has for nearly a year been considering the subject of brakes for electric cars, is reported to have completed its investigations and a final report may be expected in a short time. The committee has been co-operating with the board of trade in the matter and has inspected a large number of new types of brakes.

**International Electrical Exposition.**—An international exposition devoted to the various applications of electricity will be opened at Marseilles, France, on April 19, 1908, and will extend until October 31. The exposition will be held at Parc du Rond-Point du Prado and will be under the patronage of the municipality and the chamber of commerce of Marseilles. of the men received the rewards. This is the fifth year the company has made a distribution of this kind.

**Amarillo (Tex.) Electric Line Opened.**—A party composed of officials, Amarillo business men and newspaper representatives, made a trip over the line on January 2, in the first car to be operated since the road was completed. Eleven miles of track has been laid, all of which was found to be in excellent condition and, with the exception of one section which will use a crossing not yet completed under the Santa Fe tracks, was pronounced ready for the formal opening. This will take place during the Panhandle jubilee which will be held in that city on January 9, 10 and 11.

**Inspection of Interlocking Devices Required.**—The Indiana railroad commission has adopted a new set of rules which require that all companies having charge of the maintenance and operation of interlocking devices shall inspect these plants monthly, and shall report to the commission not later than the first day of the succeeding month. The rules also provide that all steam and interurban companies interested in the operation of such interlocking devices, but not charged with their maintenance and operation, shall inspect the plants once every 60 days and report the result to the commission.

**Omaha (Iowa) May Have Owl Car Service.**—The advisability of starting owl car service on several of the street railway lines of the Omaha & Council Bluffs Street Railway will be

discussed at the annual meeting of stockholders to be held on January 13, next. If this practice is decided upon hourly service following the discontinuance of frequent traffic at 1 o'clock probably will be maintained until regular day service is resumed at 5:30. The operation of owl cars is made possible by the recent installation of power storage equipment at the new Lake street substation, which will permit closing down the main power house until the day traffic is resumed.

**American Institute of Electrical Engineers, Toledo Section.**—The regular monthly meeting of the Toledo section of the American Institute of Electrical Engineers was held Friday evening, January 3, 1908, in the Builders' Exchange. Reports were submitted by H. B. Dorman for the membership committee and by George E. Kirk as to the meetings. Officers of the section for the year were elected as follows: Chairman, C. R. McKay, electrical engineer Toledo Railways & Light Company; vice-chairman of the section and chairman of the programme committee, M. W. Hanson; secretary, George E. Kirk; chairman of the membership committee, H. B. Dorman; treasurer, Emil Grah.

**Chicago Federation of Labor Advocates Regulating Ordinances.**—The Chicago Federation of Labor at its meeting on January 5 adopted resolutions advocating two ordinances which are to be recommended to the local transportation committee of the Chicago city council. The first proposed ordinance would limit the number of passengers to be carried by a street car to the number of seats provided in the car and prohibit the admission of more than 100 persons at a time to the station platforms of the elevated roads. The second provides that all lines operating under city franchises be compelled to furnish "delay checks" to passengers entitling them to transportation on another line in the event of any unforeseen delay.

**Park Improvements at Grand Rapids.**—The Grand Rapids Railway is planning a large number of improvements to be made before summer at Ramona park, located near Grand Rapids, Mich. Several new concessions will be let and it is planned to erect a "shoot the chutes." The principal improvements, however, will be made at Manhattan beach, across the lake from Ramona park, the terminal of the railway line. At this point a large pavilion will be erected which will contain a dance hall and other summer resort amusement features. Eighty new bathhouses will be erected for the use of men and 40 for women. The line of beach will be extended and new steamboat docks will be built. The company is also planning for improvements at North park, about three miles north of the city on Grand river.

**Recent Accidents.**—A head-on collision occurred between a passenger and a freight car of the Evansville & Mt. Vernon Electric Railway at Ford's station, 10 miles east of Evansville, Ind., on January 4. One passenger was killed and several injured. The accident occurred on a single track at a point near where the cars had been ordered to meet. A heavy fog is said to have caused the accident.—Twenty-two persons were injured at Savannah, Ga., on January 4, in a rear-end collision on the West Savannah line of the Savannah Electric Company. The accident was caused by the slipping of a trolley wheel on the forward car, which put out the lights and rendered it invisible to a small car crowded with passengers that was rapidly following. The front end of this car was badly damaged. None of the passengers was seriously injured.

**Discussion on New York Subway Plans.**—Comptroller Metz of New York City has announced his opposition to the plans of the public service commission for the Broadway-Lexington avenue subway route, which was described in last week's issue of the Electric Railway Review. Mr. Metz says the city has no money to build any more subways at present and that new plans should not be considered until the Brooklyn Fourth avenue route, for which plans have been approved and money appropriated, has been built. Chairman Willcox of the commission states that the new route will in no way interfere with the Brooklyn subway; that the plans for the latter are being revised and bids will be asked for and contracts let as soon as the changes have been made. He says that as soon as the plans for the Broadway-Lexington route are prepared they will be submitted to the board of estimate for such action as it may see fit to take.

**Ordinance to Regulate San Francisco Service.**—M. I. Sullivan of the San Francisco board of supervisors has submitted to the board a draft of an ordinance to regulate the operation of street cars in the city. The proposed ordinance provides: That the company shall build a power house of sufficient capacity to insure power for the operation of sufficient cars to carry all passengers with speed and comfort; that no car shall

carry more standing than sitting passengers; that each car shall carry a destination sign at night which may be read at a distance of 300 feet and be equipped with fenders two inches above the tracks; that air brakes shall be inspected daily. Further provisions limit the speed of cars, fix a schedule showing the number of cars to be operated and provide for universal transfer rules and complete monthly reports to the board, etc.

**Officials of Central Illinois Traction Company Reindicted for Charleston Wreck.**—The grand jury at Mattoon, Ill., that last October indicted the directors and two employes of the Central Illinois Traction Company on account of the disastrous accident of August 30, met again on January 6 and reindicted those who were originally indicted. The indictments against the officials and directors were made more comprehensive than before by making them read for manslaughter and criminal negligence instead of for manslaughter alone. Those indicted are: Judge Peter S. Grosscup, Marshall E. Sampson, A. W. Underwood, F. M. Peabody and E. A. Potter of Chicago, and Fred Moore of Charleston. The two motormen were also indicted for manslaughter. The action of the grand jury has occasioned some surprise, as the various claims against the company were all settled last Saturday for \$41,000. It is stated that physicians who attended the wreck victims will sue the company for claims aggregating \$3,000.

**American Institute of Electrical Engineers.**—A meeting of the American Institute of Electrical Engineers was held in the auditorium of the Engineering Societies building, 33 West Thirty-ninth street, New York City, on Friday, January 10. The programme as announced included the following papers: "The New Haven System of Single-Phase Distribution, with Special Reference to Sectionalization," by W. S. Murray, electrical engineer New York New Haven & Hartford Railroad; "A Single-Phase Railway Motor," by E. F. Alexanderson, electrical engineer General Electric Company, Schenectady, N. Y. A special meeting of the institute will be held in the auditorium of the Engineering Societies building, on Friday, January 24. At this meeting the following papers will be presented for discussion: "Electrical Engineering Education," by Charles P. Steinmetz, chief electrician General Electric Company, Schenectady, N. Y.; "The Best Engineering Education," by Charles F. Scott, consulting engineer Westinghouse Electric & Manufacturing Company, Pittsburg, Pa.

**Consider Chicago Loop Problem.**—A meeting of the local transportation committee of the Chicago city council was held on Thursday of this week to consider steps to be taken to relieve the congestion on the Union elevated loop. It was decided to take action as soon as possible and to hold another meeting on February 1 to consider the plans of the railroad officials. President M. B. Starring of the Northwestern Elevated Railroad, President H. G. Hetzler of the Metropolitan West Side Elevated Railway and President Charles V. Weston of the South Side Elevated Railroad were present at the meeting. Mr. Starring explained that his office is working on a plan for the extension of the station platforms as one step toward solving the problem. The other officials said that their offices also were considering plans and that they would prefer to have several conferences before presenting a composite proposition to the aldermen. "Enabling legislation by the council is now all that is necessary to permit the station platforms to be extended around the loop," said Chairman Milton J. Foreman of the committee. "It is certain that the committee will not consent to any so-called solution of the loop problem which will necessitate the erection of other elevated structures in the downtown district."

**Burning Coal Smokelessly.**—Bulletin No. 15 of the Engineering Experiment Station, University of Illinois, "How to Burn Illinois Coal Without Smoke," by L. P. Breckenridge, director, has just been issued. A few pages are devoted to the principles of combustion and the losses due to smoking chimneys, but the larger part of the bulletin relates to the constructive features of those boiler settings and furnaces that have been found practically smokeless in operation at the power plant and in the experiment station at the University of Illinois. The leading dimensions of the settings and furnaces are given and sectioned cuts show the general character of the settings. With each cut is given a statement as to the range of capacity of each setting for smokeless operation. Especial emphasis is given to the importance of knowing the rate at which the coal is to be burned on each square foot of grate surface, together with the per cent of volatile combustible which the coal contains, and for which a suitable combustion space or chamber must be provided. While this bulletin discusses the smokeless burning of Illinois coals, the principles and methods explained apply equally well to the burning of all kinds of soft coal. Copies of this bulletin may be obtained gratis upon application.

# Traffic and Transportation

## Chicago Elevated Road Traffic.

The total number of passengers carried in December on the South Side Elevated Railroad, Chicago, was 3,713,415 as compared with 2,951,590 in December, 1906.

The Metropolitan West Side Elevated Railway carried 4,579,406 passengers in December as compared with 4,829,475 in December, 1906.

The Northwestern Elevated Railroad carried 3,284,711 passengers in December as compared with 2,942,028 in December, 1906.

## Fares Raised on Massachusetts Road.

Stone & Webster, general managers of the Blue Hill Street Railway of Canton, Mass., have announced that in order to preserve the road from bankruptcy, it is necessary to increase the fares from 5 to 6 cents. The increase has therefore been ordered. "The step of raising the fares is the only one left open to us at this time," said A. H. Warren of Stone & Webster. "The road is at present running at a loss. And I may say, many roads in this state are in the same position. A few are showing a surplus, some break about even and more still show a yearly deficit. There is not enough business."

The Blue Hill company operates an electric railway from Mattapan, where it connects with the Boston Elevated Railway, through Canton to Stoughton, where connection is made with the Bristol & Norfolk Street Railway and the Old Colony Street Railway.

## Round-Trip Tickets Sold at Stations by Illinois Traction System.

B. R. Stephens, general traffic manager Illinois Traction System, has sent us the following in explanation of the change in the method of selling tickets:

"Since the opening of our lines west of Champaign in August, 1904, we have followed the policy of selling tickets at the terminal stations and also at some of the larger stations on our line, the latter particularly the county seats, while for the intermediate stations and country stops round-trip tickets were sold by the conductors on the cars. Our business has gradually increased until it has reached such volume that we found it impossible for the conductors to collect all of the fares and still handle these round-trip tickets, consequently we have placed the tickets on sale at all of our stations, generally on a commission basis, and for the benefit of our rural patrons we sell a \$5.00 fare book at \$3.75 net, which gives the same rate of fare as the round-trip tickets. These books are issued only to individuals and are limited to six months. We also sell a \$10 fare book for \$7.50 net, which is unlimited as to time of use and is good for an entire family."

## New York City Railway Receivers Reply to Order for Increased Service.

A. H. Joline and Douglas Robinson, receivers for the New York City Railway, have sent a letter to the New York public service commission, first district, in reply to the order for an increase in the number of cars on the Eighth avenue line. The letter states:

"Your attention is called, for example, to the fact that the specification numbered 3, provided for running on Sundays south from One Hundred and Forty-ninth street to Thirteenth street not less than 600 cars, increases the service to an extent far in excess of the actual requirements. It is a well-known fact to all familiar with street railway management that the volume of traffic varies extremely on Sundays. The difference between rainy and pleasant Sundays as regards the number of passengers carried is often as great as 75 per cent. Under these circumstances to order a fixed number of car-miles to be operated on that day is, in our judgment, wholly unjustifiable. The proper operation of the road demands a reasonable flexibility in the service, so that the number of cars can be varied to meet its changing requirements.

"You will observe by reference to three blue prints submitted to you at your request, and showing the comparison between the seating capacity and the number of passengers riding on the Eighth avenue cars on Sunday, December 15 (which was a stormy day), that these records show that sufficient seating capacity was afforded substantially all day. Notwithstanding this fact the specification of your order above referred to would require that approximately 3,600 car-miles per day should be operated in excess of the car mileage operated on the Sunday in question. On the basis of 18 cents per car-mile this would mean an expenditure of approximately \$34,000 a year. Considering the average number of stormy

Sundays it is evident that a substantial sum of money will be practically wasted. In view of the present financial conditions and the difficulties which we are having in an endeavor to properly accommodate the public with the means at our disposal, it seems to us that such a requirement as the one in question is neither just, reasonable nor proper."

#### Explains New Transfer System in Galveston, Tex.

H. S. Cooper, manager of the Galveston (Tex.) Electric Company, had a signed statement in the Galveston News on January 1, in explanation of the new system of transfers which went into effect on that date. The statement says:

"The term 'universal transfer' does not mean that a passenger can get on a car and obtain a transfer to any and every other line at any place of intersection. The object of the transfer is to allow a passenger to ride from one portion of the city to another portion of the city—in one general direction only—for one fare. Anything further than this would not be equitable to the company, as it would allow passengers to get on a car near their residences or places of business, ask for a transfer on some other line that ran close to their residence or place of business, get off at the transfer point nearest that to which they wanted to go, transact business there and return to their residence or place of business on the transfer—having virtually obtained two complete rides in different 'general directions' for one fare, a manifest injustice to the company and a right not due the public.

"Neither is the transfer intended to give a patron the privilege of getting on a car close to his residence or place of business, obtaining a transfer to a line only a block or two away and riding from 5 to 20 blocks unnecessarily before he gets the line that will take him to his destination. No street railway system on earth will permit everybody to get on a car in front of their doors and be carried to the front door of the place to which they desire to go; this can only be done by private conveyance—and generally costs more than 5 cents! The street railway, being limited by tracks and fixed routes, can only carry its passengers on those fixed routes, and anyone who does not live directly on its lines is compelled to walk to and from them.

"The 'time limit' of the transfer has been made particularly liberal. On every line the limit of time in which the transfer must be used has been made such that the passenger will be certain to catch a car on the connecting line within the time limit of the transfer just issued to him. The time limit is also arranged to take care of any slight, ordinary delay in the schedule of the first car, and where the first car is delayed so long as to cause the time limit on a transfer, already issued to a passenger, to run out, the conductor will, upon request, issue a new transfer with proper time limit.

"Some few persons may live in such locations and desire to travel to such points that the new system may benefit them but little, but it is the belief of the company that that part of the public will be very small. The company has tried to arrange this system for the convenience and saving of money of the many and not of the few. It has not tried to specially please or accommodate any particular section or sections, but to do the best it could for the most people. It has not tried to please everybody—that would be an impossibility, and to try it would please no one.

"The company would ask of its patrons a little forbearance and patience in the matter until they and its employees are familiar with the matter. The conductors are as new to this transfer—in actual practice—as is the public, and, being human, will be liable to make errors. A very little time and some patience on the part of the public will get the system into smooth running order, and the company thinks that its patrons will fully appreciate the time and labor and expense that have been given by the company in preparing this new year gift for its patrons, a gift which is an appreciation of the patronage bestowed on it and carries with it the wish for a 'happy and prosperous New Year' for all its patrons."

**May Abolish Transfers Between Third Avenue and New York City Roads.**—As a result of the appointment of an independent receiver for the Third Avenue Railroad of New York transfers between that road and other lines in the New York City Railway system may be abolished.

**Meeting of Traffic Officials.**—In view of the proposed formation of a traffic association at Dayton, O., on January 22, the programme for the annual meeting of the Central Electric Railway Association at the same place on January 23 includes several matters of especial interest to traffic officials. The programme is published in another part of this issue.

**Large Increase in Service Ordered.**—The New York public service commission, first district, has issued orders to the Richmond Light & Railroad Company and the Staten Island Midland Railroad to increase the service to the extent of about 25 per cent, and particularly providing that not less than 20

cars should leave St. George within five minutes after the arrival of the ferry boats from Manhattan. It was also ordered that all cars designated to run to St. George should be actually run over the elevated structure to the entrance of the ferry and not stopped at Jay street.

**Will Appeal for Rehearing of Interstate Commerce Commission Case.**—The Chicago & Milwaukee Electric Railroad will make application to the interstate commerce commission for a rehearing on the petition filed by that company to compel the Illinois Central Railroad to make through routes and joint rates on cabbage from points on the electric line to points on the steam road in the south.

**Springfield (Mass.) Street Railway Reduces Service.**—On account of a noticeable decrease in travel on all lines, the Springfield (Mass.) Street Railway Company has decided to make several changes in schedule. Patrons of the Chicopee-Longmeadow line, by way of Glenwood, and the Feeding Hills line will be principally affected by the changes. While the morning, noon and early evening travel is heavy, traffic during the day and late evening is considerably lighter.

**Loss on Owl Cars.**—A. G. Maish, general manager of the Des Moines (Ia.) City Railway, is quoted as saying that the operation of the owl cars costs the company about \$25 per day above the income from them. He says that the nightly average number of patrons on the owl cars is about 200. The largest number is carried on the 1 o'clock cars. On the Highland Park line, as few as six people have been carried in a night, Mr. Maish says.

**Theater Train Service on the Spokane & Inland.**—The Spokane & Inland Empire Railroad has issued an illustrated post card announcing the establishment of a new Saturday night theater train service for the accommodation of patrons on the Spokane & Inland division. The theater train will leave the Spokane terminal every Saturday night at 11:30, stopping at all points south to Palouse and Colfax. The card contains a programme of the principal attractions to be presented at the Spokane theaters during the present season. Reservations at any Spokane theater may be made through the station ticket agents.

**Reduced Fares for Uniformed Employees to be Discontinued.**—T. K. Glenn, vice-president of the Georgia Railway & Electric Company of Atlanta, Ga., complying with the anti-pass rule of the Georgia railroad commission, has notified the postmaster of Atlanta and the Atlanta Gas Light Company that existing contracts for reduced fares for uniformed employees will not be renewed at expiration. Mail carriers and uniformed employees of the gas company have been permitted to ride upon the payment by the government and the gas company of \$3.00 per month per man to the electric company. The contract with the gas company expires on February 1, 1908. The contract with the government expires on September 1, 1908. In future there will be no reduction in rates unless the contract is approved by the railroad commission.

**Improved Service Demanded in Louisville, Ky.**—Mayor Grinstead and members of the general council of Louisville, Ky., have demanded that the Louisville Railway make improvements in its schedule and establish a universal transfer system. The city authorities demand sufficient cars to provide all passengers with seats, and that there be no greater interval between cars during the day than 10 minutes. The company was also urged to issue transfers to permit passengers, if tracks do not intersect, but are within two blocks of each other, to leave one line and ride on cars on the other without the payment of additional fare. T. J. Minary, president of the company, announced that the preparation of a new schedule will be begun at once, but told the city officials that the directors would have to be consulted before any promises concerning a universal transfer system could be made.

In accordance with an ordinance recently passed by the city council of Youngstown, O., the Mahoning & Shenango Railway & Light Company is equipping its city cars with fenders. The company has requested permission to use pilots on its interurban cars on account of their greater stability.

A new artesian well of water with medicinal qualities has been discovered on the Ft. Des Moines line of the Des Moines City Railway. The company has announced that a depot and buildings will be erected at that point and if the demand warrants it a sanitarium will be established.

The Illinois Traction System on January 1 instituted through service from Danville to Springfield, Ill., via Decatur. The cars, which are called the "Capital City Limiteds," are handsome chair cars and make the run in 4 hours and 45 minutes.



# Construction News

## FRANCHISES.

**Berkeley, Cal.**—The San Francisco Oakland & San Jose Railway Company has filed application for a 50-year franchise to build an electric line along Sacramento street from the Oakland line to the north end of Berkeley, serving that section to the north which has been donated for the proposed capital site. Work is to be started within six months and completed within two years from the date of the franchise. The extension will cost approximately \$3,000,000, including equipment, and will form part of an extensive system of lines serving the region from the Berkeley hills to the bay and reaching to Richmond and the Contra Costa towns. J. Q. Brown, assistant general manager and purchasing agent, Oakland, Cal.

**Chicago, Ill.**—An ordinance has been presented to the city council granting to the Chicago City Railway Company the right to lay tracks in Western avenue, from Thirty-eighth street and Archer avenue to Twenty-sixth street. If built the line will form a connection with the lines of the Union Traction Company.

**Dallas, Tex.**—L. Fulton, Dallas, Tex., and associates, have applied for a franchise to construct an electric railway in Dallas from Jefferson street south on Madison street and from Jefferson street south by way of Adams or Jackson street. It is stated that the line will be about  $2\frac{1}{2}$  or 3 miles long, in a section of the city at present without street railway facilities, and if built will develop a large tract of land for residence purposes. Power for operating the line will be purchased.

**Phoenix, Ariz.**—Application for a franchise to build an electric railway between Phoenix and Mesa, Ariz., by way of Tempe, has been made by Redmond Toohy and Harry J. Bennett, the line to be completed within three years. One per cent of the gross income after five years of operation is offered to the county.

**Racine, Wis.**—A conditional franchise has been granted to the Milwaukee Electric Railway & Light Company to build a track on Second street, from Main street to Lake avenue. The company asked permission to lay track on two more blocks in order that it might haul coke from the gas plant which it owns in Racine to Milwaukee. This petition was refused.

## RECENT INCORPORATIONS.

**Ft. Smith Checotah & Shawnee Interurban Railway, Checotah, Okla.**—Incorporated in Oklahoma to construct and operate an interurban railway from Ft. Smith, Ark., to Shawnee, Okla. The line when completed will be 160 miles long and will cost in the neighborhood of \$1,280,000. Capital stock, \$500,000. Incorporators: R. B. Hutchinson, R. G. Smith, L. F. Cain, R. D. Martin and W. M. Duffy, all of Checotah.

**Southern Colorado Power & Railway Company.**—Incorporated in Colorado to construct a series of power houses in Huerfano and Las Animas counties in the southern part of Colorado. Central plants will be erected in Walsenburg and Trinidad and it is stated that the Trinidad Electric Railroad will become a part of the new company's holdings. Eastern capitalists are interested in the project. Capital stock, \$1,500,000. Incorporators: W. F. Schuyler, K. C. Schuyler and C. Speiss, of Denver.

## TRACK AND ROADWAY.

**Accomac Traction & Power Company, Onancock, Va.**—It is stated that this company has awarded the contract for building its proposed electric line from Onancock, by way of Tasley and Accomac Courthouse, to Battle Point, to James D. Lalor & Co. Five per cent bonds to the amount of \$175,000 will be sold, the proceeds of which are to be used for constructing the road. S. F. Rogers, president; T. W. Taylor, secretary.

**Albia Interurban Railway, Albia, Ia.**—C. B. Judd, Des Moines, Ia., chief engineer of this company, writes that  $3\frac{1}{2}$  miles of track from Albia to Hocking have been laid during the past year, and that surveys have been completed from Hiteman to Buxton,  $16\frac{1}{2}$  miles. The cross-span type of overhead construction with No. 000 trolley is used within the city limits while on the  $2\frac{1}{2}$  miles of 60-foot private right of way the bracket type is used. Power for operating the line will be obtained from the Albia Light & Power Company. Grading from Hiteman to Buxton will be resumed in the spring. Sixty-pound rails with soldered bonds are used. There is a maximum grade of 3 per cent and a maximum curvature of 8 degrees. The road was designed principally for passenger traffic, although with the opening of a new coal shaft about a

mile from Albia, it will deliver about 400 tons of coal per month to the Albia Light & Power Company and whatever other coal traffic may develop for local use, will be handled by the company. J. C. Reese, Albia, Ia., is president; C. B. Judd, chief engineer; Calvin Manning, secretary and treasurer. (Mentioned December 21, 1907.)

**Asheville & Hendersonville Railroad, Asheville, N. C.**—The contract for the construction of this road from Asheville to Hendersonville, N. C., 22 miles, has been let to the Carolina Construction Company of Asheville. It is stated that a new survey will be made and that rails and other material will be ordered at once. The company will build its own power house and proposes to handle freight and passenger traffic. C. F. White of Skyland, N. C., is interested. C. E. Van Bibber, 60 Wall street, New York, is chief engineer. (Mentioned on November 2, 1907.)

**Boston Elevated Railway.**—The need for strengthening a bridge over the Boston & Maine Railroad tracks will delay the opening of the Boston Elevated Railway Company's newly constructed line for surface cars between the Sullivan square terminal and the Middlesex Falls reservation until the present year is far advanced. The bridge is the only thing that intervenes between the elevated's present surface tracks in Main street, Charlestown, and the beginning of the new tracks recently laid in Mystic avenue, Somerville. The structure is too weak to carry the new heavy semi-convertible cars now used by the Boston Elevated for suburban lines, and the company will not, it is understood, care to incur the expense of rebuilding that part of the bridge that would be required for its tracks until money conditions are easier.

**Cincinnati Northern Traction Company, Hamilton, O.**—Work on the reconstruction of the roadbed of this company's line between Hamilton and Cincinnati, O., the greater part of which has been done on recently acquired right of way, has been practically completed, and when a few gaps remaining have been closed up the roadbed and track covering the entire distance between these cities will have been entirely rebuilt. (Mentioned September 14, 1907.)

**City & Suburban Electric Railway, Brunswick, Ga.**—Orders are said to have been placed for rails, poles etc., for the construction of this company's electric line in Brunswick. According to the terms of the franchise work must have been started by January 1, 1908, and four miles be completed within the year. (Mentioned September 7, 1907.)

**Delaware Marion Mt. Gilead Mt. Vernon Newark & Southern Coal Tramway Company.**—Col. Albert E. Boone is promoting this new interurban project in Ohio, six divisions for which are stated to have been mapped out as follows: From Delaware to Centerburg; from Marion and Centerburg by way of Mt. Gilead; from Newark to Centerburg by way of Locks and Appleton; from Newark to Lexington by way of Mt. Perry and Sago; from Newark to Sago by way of Hanover, Gilbert and Adamsville; from Centerburg to Mt. Vernon.

**Eldorado Springs Tiffin Monegaw Springs & Lowry City Railroad, Tiffin, Mo.**—Part of the right of way for this proposed 30-mile electric line, which will connect the towns named in the title, has been secured and the contract for the surveys will be let in the near future. Dr. C. A. Edgar, president. Eldorado Springs. J. S. Harrison, secretary. (Mentioned December 14, 1907.)

**French Point Street Railway, Pittsburg, Pa.**—Announcement is made that this company will extend its present line from Merchant and Wagner streets, Ambridge, Pa., to a point on the right of way of the Economy Belt Line Railway. The company recently increased its capital stock from \$6,000 to \$31,200 for this purpose. James D. Callery, Pittsburg, president. (Mentioned November 9, 1907.)

**Fresno (Cal.) Traction Company.**—This company is now engaged in laying about  $4\frac{1}{2}$  miles of new track.

**Grand Valley Railway, Brantford, Ont.**—This company proposes to rebuild its line from Brantford to Galt, Ont., 26 miles, laying new 80-pound steel, and likewise to rebuild the Brantford Street Railway, which it controls, laying seven miles of additional track and to rehabilitate the Woodstock Thames Valley & Ingersoll Electric Railway. Extensions as follows are projected: From Brantford-Galt line, six miles to St. George; from Brantford, through the villages of Mt. Pleasant, Boston, Waterford, Bloomsburg and Simcoe to Port Dover on Lake Erie, 34.5 miles; from Brantford west through Mt. Vernon, Burford, Catheart and Eastwood to Woodstock, 25 miles, connecting at Woodstock with the Woodstock Thames Valley & Ingersoll, from Woodstock through Embro and Beachville to Ingersoll, 12 miles; from Ingersoll through Dorchester to London, 18 miles. New mileage is 90.5 and the mileage to be rebuilt 42, making a total of 132.5 miles. The

contract for grading, masonry and timber work has been awarded to Joseph Gianini, Pittsburg, Pa. Contracts for rails and electrical equipment, including cars and locomotives, it is stated, will be awarded in the spring, when the electrical system is determined upon and the result of the vote now being polled in lower Ontario on a by-law authorizing the government to construct electric transmission lines from Niagara Falls and sell power for lighting and other purposes to municipalities and corporations. The single-phase system is under favorable consideration and the Westinghouse Electric & Manufacturing Company and the Canadian General Electric Company have been asked to prepare recommendations and estimates on the power and other electrical equipment. The cars for interurban use, it is stated, will be about 52 feet long and the city cars about 23 feet long. A steel trestle about 1,200 feet long will be required on the Port Dover extension. William P. Kellett, chief engineer, Brantford, Ont. Murry A. Verner, president.

**Indianapolis & Louisville Traction Company, Louisville, Ky.**—John E. Greeley, vice-president of this company is quoted as saying that plans are being considered for the construction of an east and west line, one of which is proposed from Scottsburg to Madison, Ind., and on to Cincinnati, O. The Louisville & Northern Railway & Lighting Company also is said to be considering the construction of an extension from Charlestown to Madison, which will connect with the Indianapolis & Louisville line at the last named point.

**Joliet & Southern Traction Company, Joliet, Ill.**—The new line from Joliet to New Lenox, Ill., is now nearly completed and is expected to be opened for traffic within a few weeks.

**Kansas City Springfield & Southern Railway, Nevada, Mo.**—This company has completed surveys for its proposed interurban railway between Nevada and Springfield, Mo., with a branch line to Carthage. The length of the line, including sidings, will be about 140 miles, and will be operated by current from its power station to be located at Aroola, Mo. The company also will operate an amusement park near the Sac river. The capital stock is \$3,750,000, later to be increased to \$4,500,000. The officers are as follows: W. B. Forsyth, president; S. A. Wight, secretary; J. W. Creekman, treasurer; C. C. McFann, general manager. All communications should be addressed to the general manager at Nevada, Mo.

**Kansas Southern Electric Railway.**—F. V. Crouch, Pittsburg, Kan., president of this proposed interurban electric road, is said to have announced that final arrangements for a loan of \$5,000,000 have been concluded with French capitalists and that construction work will be started in the spring. The road will start from Pittsburg, Kan., and pass through Girard, St. Paul, Erie, Chanute and Iola, Kan. Most of the right of way has been secured and several franchises for crossing the county roads have been obtained.

**Lake Shore Electric Railway, Fremont, O.**—This company is endeavoring to secure renewals of the options it holds on private right of way for its proposed line between Fremont and Genoa, O., parallel to the Lake Shore steam road. The new line when built will shorten the distance between Fremont and Toledo, O., about 13 miles, and will form part of the project to double-track the entire line between Cleveland and Toledo.

**Los Angeles Railway.**—Regular service over the Boyle Heights and West Seventh street lines, covering two miles of city streets, was started on January 3. The cars now branch off at Fourth street continuing west to Western avenue and thence north to Melrose.

**Milwaukee Electric Railway & Light Company, Milwaukee, Wis.**—It is stated that this company is planning an extension of its interurban line from Watertown through Johnson Creek, Jefferson, Ft. Atkinson, Whitewater and Palmyra to East Troy, Wis., where it will connect with the company's existing line at that point. Surveys for the route are now in progress.

**Missoula-Bitter Root Traction Company.**—Surveys for this company's proposed route between Missoula, Stevensville, Corvallis and Hamilton, Mont., 42 miles, have been completed. More than 28 miles of right of way are said to have been donated and construction work will be started next year. Capital stock, \$85,000, of which \$40,000 is authorized and \$15,000 issued. F. O. Lewis, Stevensville, Mont., secretary and treasurer. (Mentioned April 27, 1907.)

**Mt. McKay & Kakabeka Falls Railway, Ft. William, Ont.**—This company will apply at the next session of the Ontario legislature for an extension of time to April 30, 1912, in which to complete its proposed line from Ft. William to Kakabeka Falls, about 30 miles. The company also will apply for an act defining the location of its route; giving it the right to build

its line on either or both sides of the Kaministiquia river; authorizing it to use steam motive power during construction; confirming the Ft. William franchise for the operation of its cars in the streets of that city, and approving the by-law guaranteeing the company's bonds to the extent of \$10,000 a mile for every mile constructed in the municipality of Neebing within five years from the date of its passage. W. F. Hogarth, Ft. William, Ont., is president.

**Mt. Mansfield Electric Railroad, Stowe, Vt.**—It is reported that A. H. Soden of Boston, Mass., who recently purchased this property at a foreclosure sale, plans to extend the road from Stowe to Morrisville, a distance of eight miles. The line now connects Stowe and Waterbury, Vt., a distance of 10½ miles.

**Nashville Interurban Railroad, Nashville, Tenn.**—H. H. Mayberry, president of this company, which is building from Nashville to Franklin, Tenn., has announced that a contract has been made with the Nashville Railway & Light Company, whereby that company will furnish the power for operating the road. The company proposes to build from Nashville to Mt. Pleasant, Tenn., 67 miles; the first section, to Franklin, now under construction, is 20 miles long. Mr. Mayberry states that when the line is completed to Mt. Pleasant it will build its own power house. It is expected to complete the first section during the coming spring. A trackage arrangement has also been made with the Nashville Railway & Light Company whereby the interurban cars will enter the city of Nashville over the street railway tracks and use the central transfer station of the latter company as a terminal. An hourly schedule will be maintained. Specifications are now being prepared for the rolling stock. Twelve miles of the line have been graded and tracklaying will begin the latter part of January.

**Nipissing Central Electric Railway, Ottawa, Can.**—F. R. Latchford, a director of this company, writes that contracts are to be let in May or June, 1908, for the proposed line from Cobalt to New Liskeard, Ont., 12 miles, via Argentite, North Cobalt and Haileyburg. A line from Latchford to Cobalt is also contemplated, but surveys have been completed only from Cobalt to New Liskeard. The right of way and municipal franchises are now being negotiated for. John Fitzpatrick, Ottawa, is president. (Mentioned December 28, 1907.)

**Omaha & Council Bluffs Street Railway, Omaha, Neb.**—This company on January 8 commenced active construction work on an extension of the South Tenth street car line from Bancroft street to Riverview park. The company expects to complete the greater part of the work by next spring and to have the entire line ready for traffic before the park season opens.

**Omaha & Nebraska Central Railway, Hastings, Neb.**—Contracts for grading and track material will be awarded by this company in the spring and active construction work started as soon as possible. The line will be 159 miles long and will extend from Omaha to Hastings. The officers are: H. C. Long, president, 617 Fremont building, Boston, Mass.; A. Texter, vice-president, David City, Neb.; J. H. Rogers, secretary, Hastings; E. R. Long, treasurer, David City; J. C. Baker, general manager, Hastings, Neb. (Mentioned October 12, 1907.)

**Oakland (Cal.) Traction Company.**—This company expects to place contracts for the construction of 10 miles of new track during the present year. J. Q. Brown, assistant general manager and purchasing agent.

**Oshkosh, Wis.**—It is stated that preliminary steps have been taken toward the construction of an interurban line from Oshkosh, by way of Bntes des Nortes, to Winnebconne, Wis., 11 miles. It is planned to operate the road with an engine using either gasoline or crude oil. The cost is estimated at about \$15,000 per mile. It is stated that Oshkosh capitalists are prepared to finance and build the road during the present year.

**Pacific Coast Railway, San Luis Obispo, Cal.**—James Anderson, chief engineer, writes that this company has built during 1907 an extension 2.1 miles long, from Betabel to Bonetti, Cal.

**Priest Rapids Railway, Priest Rapids, Wash.**—Construction work on this proposed interurban line from the Waterville district along the Columbia river to Kennewick, will be started in the spring. The road has been projected principally as a feeder for the transcontinental steam lines and will be equipped to handle standard freight cars. The most important right of way has been secured and the remainder is being arranged for. The line will connect with the Northern Pacific, the Great Northern, the Chicago Milwaukee & St. Paul, the North Coast and the Portland & Seattle Railway, and, when completed, will be 136 miles long. The route as

surveyed lies up the Columbia river valley from Kennewick to the new town of Hanford, where the Hanford Irrigation & Power Company's new plant is being constructed to furnish power for the operation of the line as well as for other commercial purposes. From Hanford it will cross the river at Priest Rapids and extend to the Waterville district, serving the wheat lands of Douglas county. W. R. Rust, president; M. B. Haynes, vice-president; E. H. Guie, secretary; H. K. Owens, chief engineer.

**Paducah Southern Electric Railroad, Paducah, Ky.**—Surveys for this line from Paducah to Mayfield and Hickman, Ky., have been completed and maps and estimates are now being prepared. Two routes were surveyed, one of which parallels the Illinois Central Railway. It is stated that arrangements have been concluded for disposing of the bonds and that work will be started in the near future with the intention of having a portion of the line in operation this year. H. H. Loving of Paducah is interested. (Mentioned September 21, 1907.)

**Sistersville, W. Va.**—It is stated that the Pittsburg Construction Company has offered to build an electric railway from Sistersville to Middlebourne 12½ miles, provided local interests agree to take part of the bonds. E. L. Benton, Sistersville, is engineer. (New road.)

**South Bethlehem & Sacon Street Railway, South Bethlehem, Pa.**—Official advice from this company states that track-laying has been completed from South Bethlehem to Colesville, Pa., 3½ miles, and that grading will be started toward Centre Valley, the proposed terminus, about March 1, 1908. The overhead work, which is of the single-pole bracket type, with No. 00 trolley wire, has been completed to Colesville. Power for the operation of the line is purchased. One mile of track in South Bethlehem is laid with 85-pound T-rails, the remaining 2½ miles with 70-pound rails. The company now operates two Brill semi-convertible double-truck passenger cars and one single-truck freight car. C. P. Hoffman, South Bethlehem, president; P. F. Cannon, secretary; Hugh E. Crilly, general manager and chief engineer, South Bethlehem.

**Springfield (Mass.) Street Railway.**—It is reported that this company has decided to postpone all improvement work not absolutely necessary. However new 9-inch girder rails are to be laid on Main and State streets and some new special work will be installed.

**Terre Haute & Merom Traction Company, Terre Haute, Ind.**—It is stated that the promoters of this line from Terre Haute to Merom, Ind., have decided to build the road by issuing scrip to pay the construction forces. A contract has been let to the United States Construction Company of Terre Haute, which has just been organized. Five townships through which the road is located have refused to vote subsidies in favor of the road, but it is stated that the merchants have promised to accept the scrip, which will be secured by a deposit of bonds. L. Brown, president; J. Caswell, chief engineer. (Mentioned on July 6, 1907.)

**Texas Traction Company, Dallas, Tex.**—This company, which is building a 65-mile line from Sherman to Dallas, Tex., has completed tracklaying from McKinney to the east fork of the Trinity river, about four miles, and it is expected that the work will proceed at the rate of a mile a day until the road is completed. A construction train of 1 locomotive and 15 cars is in use. Sufficient ties and rails are on the ground to keep the construction force busy for several weeks and as the contract calls for the delivery of the rest of the material within the next 60 days, it is believed that tracklaying for the entire distance will be completed by next April. Theodore Stebbins, general manager.

**United Railways, Portland, Ore.**—This company has now completed seven miles of its line in Portland, and since December 31 has been in operation, delivering freight from the North Pacific Terminal Company and other roads entering the terminal grounds. Passenger service will not be started until several extensions are completed. The line also serves as an entrance to the city for the Portland-Salem line of the Oregon Electric Railway. Rails and other material for the interurban line from Portland to Hillsboro have been delivered and construction is to be started as soon as the weather permits. W. L. Benham, president; L. B. Wickersham, chief engineer.

**United Traction Company, Reading, Pa.**—It is reported that a contract has been let to A. W. Sykes of Sykesville, Pa., for building a 7-mile extension from Sykesville to Big Run. E. W. Hess of Du Bois, Pa., is chief engineer.

**Visalia Electric Railroad, Exeter, Cal.**—James H. Cronett, Exeter, Cal., chief engineer of this company, writes that 13 miles of track have been laid since January 1, 1907, from

Exeter to Lemon Cove, Cal. The entire length of the line from Lemon Cove to Lemoore is 51 miles. From Lemon Cove to Lemoore cars will be operated over a leased track of the Southern Pacific Railroad. The following intermediate stations are served: Lemon Cove, Meryman, Exeter, Farmersville, Visalia, Goshen Junction, Hanford and Armona. There is a maximum grade of 1 per cent and no curve greater than 10 degrees. Fifty and 75 pound steel rails are used. The overhead work, which is of the catenary single-pole bracket type, has been completed from Visalia to Lemon Cove, 24 miles. Single-phase current at 3,200 volts potential will be used in the trolley. A main substation of the Westinghouse type has been completed at Exeter and two line transformer stations are under construction. The line will be for passenger and freight service. The initial equipment will consist of six electric motor cars from the American Car Company and one electric locomotive from the Baldwin Locomotive Works. William Hammond, president; B. M. Maddox, vice-president, Visalia, Cal.

**Wabash Valley Railroad.**—This company has been organized and soon will be incorporated to build an interurban electric line from Danville, Ill., to Terre Haute, Ind. As planned the line will follow the west bank of the Wabash river, passing through Clinton, Ind., and a number of small towns in Illinois and Indiana. D. C. Johnson, president, Clinton, Ind. (New road.)

**Washington Arlington & Falls Church Railway, Rosslyn, Va.**—Park Agnew and Charles Hine, receivers of the Washington Arlington & Falls Church Railway Company, have secured deeds of right of way which will enable them to extend the line from Vienna, Md., to Herndon, Pa. It is understood that the right of way from Herndon to Chantilly has been assured, and that work on the extension of the line to this point will soon be commenced.

**Washington Baltimore & Annapolis Railway, Baltimore, Md.**—This company completed on January 1, with the exception of a few details, the construction of its line in Annapolis, Md., and it is said that cars will be running between Washington and Annapolis on or about January 15. Work on the local line in Annapolis was started on October 28, 1907, and has been pushed to completion as rapidly as possible in order to comply with the terms of the \$5,000 bond filed with the city, by which work was to be finished on January 1, 1908. The track as completed makes a loop in Annapolis 1½ miles long. Connection from Annapolis to Baltimore will not be afforded for some time, considerable work yet remaining to be done on the Baltimore branch.

**Washington Westminster & Gettysburg Railroad.**—This company proposes to build an electric railroad connecting Washington, D. C., and Gettysburg, Pa., via Sandy Springs, Laytonsville and Westminster, Md., about 80 miles. Surveys have been made for most of the distance and it is stated that capitalists in New York, Philadelphia and Pittsburg are interested in the project. The officers are: President, J. B. Colgrove, Washington; first vice-president, E. P. Thomas of Sandy Springs, Md.; second vice-president, A. A. Chapin, Washington; treasurer, Robert N. Harper, Washington; chief engineer, Walter Atlee of Baltimore. (Mentioned on August 10, 1907.)

**West Penn Railways, Pittsburg, Pa.**—This company is said to be planning an extension between Hunkers, Scott Haven and West Newton, connecting at Scott Haven with the McKeesport-Scott Haven line and entering Hunkers over a bridge across the Yonghlopheny river.

#### POWER HOUSES AND SUBSTATIONS.

**Cincinnati Northern Traction Company, Hamilton, O.**—This company has recently equipped a new central power station at Lindenwald, near Hamilton, O., from which power will be furnished for the operation of its line between Hamilton and Dayton. Substations will be located at College Hill, Trenton, Franklin and Dwyer, each of which will be equipped with two 300-kilowatt rotary converters with six 100-kilowatt 33,000-volt transformers.

**Gulfport & Mississippi Coast Traction Company, Gulfport, Miss.**—This company has recently purchased the following apparatus: One 1,500-kilowatt Westinghouse turbo-generator, one 450-horsepower Babcock & Wilcox boiler and two 500-kilowatt Westinghouse rotaries. J. A. Jones, general manager.

**Lima & Honeyey Electric Light & Railroad, Lima, N. Y.**—A power station to be located in the natural gas fields about four miles south of Lima, will be erected by this company during the present year. E. D. Watkins, general manager.

**Oakland (Cal.) Traction Company.**—It is reported that this company proposes to erect a power house of 10,000 kilowatts capacity and new substations.

## Personal Mention

Mr. A. I. Breckenridge has been appointed purchasing agent of the Waterloo Cedar Falls & Northern Railway, with headquarters at Waterloo, Ia.; effective on January 1.

Mr. Charles F. Turner, chief engineer of the Columbus Delaware & Marion Railway, Delaware, O., has been appointed superintendent of motive power, effective on January 1.

Mr. James McCredie, secretary and treasurer of the United Traction Company, Albany, N. Y., has been elected to a similar office with the Hudson Valley Railway Company.

Mr. E. S. Dimmick, general superintendent of the Northern Electric Railway, Chico, Cal., has resigned and the duties of that office will be assumed by Mr. A. D. Schindler, general manager.

Mr. Louis H. Cushing has resigned as superintendent of the Taunton & Pawtucket Street Railway at Attleboro, Mass., to become associated with the Dexter Machine Company of that city.

Mr. M. W. Kirkwood, electrician and master mechanic of the Galt Preston & Hespeler Street Railway, has been appointed superintendent of the company, succeeding Mr. P. Clemens, resigned.

Mr. F. W. Whitridge, who has been appointed receiver for the Third Avenue Railroad, has appointed Mr. Edward A. Maher, president of the Union Railway Company, as manager of the Third Avenue System.

Mr. L. E. Fischer, general manager of the Illinois Traction System, with headquarters at Danville, Ill., was presented with a gold watch and chain on Christmas day by the superintendents and heads of departments.

Mr. George K. Mosser, of Noxen, Pa., has been elected president of the Slate Belt Electric Railway, of Bethlehem, Pa., succeeding Mr. G. A. Schneebeli. Mr. Dennis G. Gerberich has been elected general manager succeeding Mr. George H. Wolle.

Mr. Jack Abbott, electrical engineer of the Jackson (Miss.) Railway & Light Company, has been appointed general manager. The duties of this office heretofore have been under the jurisdiction of Mr. S. S. Bush, vice-president of the company at Louisville, Ky.

Mr. M. McCauley, heretofore assistant superintendent of the Detroit Monroe & Toledo Short Line Railway, has been appointed superintendent, effective at once, succeeding Mr. E. B. Taylor, resigned. Mr. McCauley's headquarters will be at Monroe as in the past.

Mr. J. E. North, heretofore in charge of the electrical engineering department of the Ohio Electric Railway, central division, with headquarters at Springfield, O., has resigned. He will be succeeded by Mr. H. W. Pagan, electrical engineer of the eastern division of the company.

Mr. L. W. Harrington, heretofore passenger and freight solicitor of the Columbus Delaware & Marion Railway, has resigned, effective on January 1. Henceforth he will devote his attention to the adjustment of claims, having had considerable experience along this line in the claim department of the Columbus Delaware & Marion Railway. With the resignation of Mr. Harrington the position of passenger and freight solicitor will be abolished and the matter of soliciting business will be looked after by the various agents of the company, each of whom will cover the business in his territory.

Mr. Paul H. Evans, for the past year chief engineer of the Mexico Electric Tramways, Limited, has resigned, and after traveling abroad for a few months will return to Mexico City to devote his time to private interests in that city. Mr. Evans has been connected with the Mexico Tramways Company for some time and for two years was purchasing agent as well as chief engineer. Previously to his connection with this company he was chief engineer of the Mexican General Electric Company, with which he was connected for seven years. He also at one time was identified with the Atlanta, Ga., street railway lines.

With the resignation of Mr. Arthur L. Smith, heretofore superintendent of transportation of the Central Kentucky Traction Company, Frankfort, Ky., this office will be abolished together with that of chief engineer of construction, and Mr. George Macleod, who heretofore has held the latter position, will have the title of superintendent of railroads. Other

appointments in the operating force are as follows: J. R. Pope, chief electrical and mechanical engineer; G. W. Brown, master mechanic; J. P. McKeever, superintendent of Lexington power station; C. K. Morrill, superintendent light and gas departments; J. D. Sallee, superintendent of local lines, Frankfort; Henry Bushel, superintendent of local lines, Lexington; J. H. Kearney, roadmaster. O. R. Bilbro has been appointed auditor and A. F. Woehner, claim agent.

Mr. C. F. Crane, whose portrait we present herewith, has been appointed general passenger agent of the Eastern Pennsylvania Railways, under the operating management of J. G.



C. F. Crane.

White & Co., with headquarters at Pottsville, Pa., as noted in the Electric Railway Review of January 4. Mr. Crane has been engaged in the electric railway business for the past eight years, having been associated with the Geneva Waterloo Seneca Falls & Cayuga Lake Traction Company at Seneca Falls, N. Y., the Rochester & Eastern Rapid Railway and more recently with the Rochester Railway Company at Rochester, N. Y. Mr. Crane's new duties will consist particularly in the improvement of the summer resorts on the Eastern Pennsylvania Railway's system in Schuylkill county and the building

up of the excursion business of the company.

Mr. James W. Morgan has been appointed chief engineer of the Galesburg Railway & Light Company at Galesburg, Ill., with charge of the extensive lighting and heating system which the company operates in connection with its electric lines. Mr. Morgan formerly was engineer of power station for the Springfield & Northeastern Traction Company at River-ton, Ill.

Mr. Charles V. Weston was elected president and general manager of the South Side Elevated Railroad, Chicago, at a meeting of the board of directors held on January 3, 1908. He succeeds Marcellus Hopkins, who died on December 7, 1907. Mr. Weston has served on the board of supervising engineers in charge of the rehabilitation of the traction properties of Chicago since last May, when he was appointed by Mayor Busse as the third member to represent the city of Chicago. He is about 50 years old and has been a civil engineer throughout his business career. His early experience was obtained on the various railroads in Texas and Kansas and on the Chicago & Northwestern Railroad in the north. Many of the important engineering undertakings of Chicago have been successfully completed under the supervision of Mr. Weston, among them being the building of the Lake View intake crib and water tunnel, the completion of the Van Buren street tunnel for the West Chicago Street Railroad in 1894 and the construction of the Northwestern and Lake Street elevated roads and the Union Loop. Since 1903 and until last May, when he was appointed on the board of supervising engineers, he was chief engineer of the South Side Elevated road, in which capacity he planned the various feeders and reconstructed the main line for the installation of elevated express service on the south side. Mr. Weston is a member of the American Society of Civil Engineers, the Western Society of Engineers and the American Railway Engineering and Maintenance of Way Association.



Charles V. Weston.

# Financial News

**Boston Elevated Railway.**—The pamphlet report for the year ended September 30, 1907, has been issued. The principal figures of the report were published in the Electric Railway Review of November 9, 1907, page 759. In his statement to shareholders William A. Bancroft, the president, says: "Besides its ordinary taxes the company's contribution to the public during the last fiscal year amounted to at least \$489,547.94. Since the last report the company has increased its power supply by building additions to three of its power stations, to wit, to the Lincoln station on Battery street in Boston, to the Charlestown station, and to the Harvard station in Cambridge. The 45 'easy access' elevated cars, spoken of in the last report, have been received and are in service. Only a portion of the last 100 of the 150 'easy access' semi-convertible surface cars have been received, owing to the failure of the contracting builder to deliver as agreed. About 60 bodies are here, and 30 have been equipped and are in service. The company has maintained the excellent character of its surface tracks, \$562,757.85 having been spent thereon during the year in renewals and repairs. The total length of surface tracks controlled by the company is now 145.897 miles. This, with the elevated mileage of 16.015 miles, makes a total mileage of 461.912. The company has continued its liberal policy toward its employes in respect to their wages, as well as in other matters. Compensation for learners during the year amounted to \$27,670.18. There was paid during the year \$42,821.77 as a guaranteed minimum wage for new or extra men. There was also paid as increased compensation to long-service men \$66,630.36. There was paid in pensions \$11,325.50. There was also paid in 'satisfactory service' money, in sums of \$15 to each of the employes deemed worthy thereof, \$55,320. The aggregate sum of increased payments to employes, under the provisions adopted four years ago, amounted during the year to \$203,767.51. The provisions of last year raising the rate of wages increase this amount by \$97,726.35, making a total of \$301,494.16. The company has designed extensions of its elevated station platforms for the future operation of 8-car trains in place of 5-car trains, the longest trains which it can now use. These extensions have been approved by the public authorities, and their construction is about to be undertaken. In connection with the Washington street tunnel, the station platforms of which are also designed for the ultimate operation of 8-car trains, these extensions will admit of a very great increase in the carrying capacity of the elevated division."

**Chicago & Milwaukee Electric Railroad.**—The agreement between the various interests, as a result of which the receivership was annulled, provides, it is stated, as follows: A claim for \$50,000 on a note held by one of the creditors will be paid at once by interests allied with the company. Trustees will be appointed to conserve the funds involved in other claims aggregating \$200,000, and the validity of the claims will be arbitrated out of court. Representatives of the Canadian bondholders advanced \$250,000, with which the interest on the bonds was paid on January 3. The Canadian bondholders further pledged the raising of \$500,000 to be used toward the completion of the railway from Racine to Milwaukee. The control of the company will remain as at present.

**Holyoke (Mass.) Street Railway.**—The Massachusetts railroad commission has authorized the issue of \$93,600 additional capital stock at \$125 per share to provide for payment of outstanding bonds of the Amherst & Sunderland Street Railway which were assumed.

**Interstate Railways, Philadelphia.**—Shareholders of record on December 5 have been given the privilege of subscribing at par pro rata for \$500,000 new stock. The proceeds will be used for new cars, power house equipment and track.

**Metropolitan West Side Elevated Railway, Chicago.**—To reimburse the treasury on account of the purchase of additional cars and equipment, this company has made an issue of \$100,000 of 6 per cent collateral trust bonds of which \$50,000 bonds are offered at par by the Chicago Savings Bank. The total issue is secured by deposit of \$200,000 Metropolitan Elevated extension 4 per cent bonds. The \$50,000 bonds which are offered for sale, will mature in 10 semi-annual instalments of \$5,000 each from June 1, 1908, to December 1, 1912.

**New York City Railway.**—The quarterly rentals due on January 2 on the leased lines of the Metropolitan Street Railway system were not met at maturity. A few days later the receivers, having obtained sufficient funds, paid the quarterly dividends due as rental on the stocks of the Broadway &

Seventh Avenue Railroad, the Sixth Avenue Railroad, the Eighth Avenue Railroad and the Ninth Avenue Railroad.—The January 1 coupons on the Third Avenue Railroad 4 per cent bonds are being paid by the Central Trust Company of New York on orders from Kuhn, Loeb & Co., and the January 1 coupons on the Third Avenue 5 per cent bonds are being paid by William A. Read & Co. In the case of the 4 per cent bonds it is necessary for the holders, in order to get their January 1 interest, to deposit their bonds under a form of agreement with the protective committee, of which J. N. Wallace, president of the Central Trust Company, is chairman. No such stipulation is required by William A. Read & Co. in their payment of the coupons on the 5 per cent bonds.

**Springfield (Mass.) Street Railway.**—Charles W. Bosworth has been elected a director to succeed William Skinner of Holyoke, Mass.

**Third Avenue Railroad, New York.**—Judge Lacombe of the United States circuit court, New York, appointed Frederick W. Whitbridge, a lawyer, receiver for this company on January 6, upon application of the Central Trust Company of New York and of the committee representing the majority of the Third Avenue consolidated bonds. This action is the result of the failure of the receivers of the New York City Railway and the Metropolitan Street Railway to pay the interest on the Third Avenue bonds, due on January 1. Its effect is to take the Third Avenue road out of the Metropolitan system during the pendency of the receivership. The present receivership is temporary, and theoretically is subject to the decision of a special master, whom Judge Lacombe has decided to appoint to investigate the question whether the Metropolitan receivers are able to pay the defaulted interest in the 60 days of grace which the mortgage allows. A permanent receivership, however, was forecast by Judge Lacombe in his decision appointing the receiver, in which he said: "The bondholders under this large Third Avenue mortgage are entitled to the appointment of a temporary receiver, to be made permanent when the time comes to declare the principal due and proceed with the foreclosure."

**Toledo & Indiana Railway, Toledo, O.**—An official is quoted as follows regarding the interest due on January 1 on the \$1,500,000 of 5 per cent bonds, payment of which has been deferred: "We have not the money earned on hand for the payment. We have had serious and costly accidents during the past year, which have taken our money, and we do not feel, because of that and the present financial condition, that we should borrow money."

## ELECTRIC RAILWAY EARNINGS.

Ft. Wayne & Wabash Valley Traction Company, Ft. Wayne, Ind.			
	1907.	1906.	
November—			
Gross earnings	\$115,089.50	\$93,142.64	
Operating expenses	62,619.68	54,155.77	
Net earnings	52,469.82	38,986.87	
January 1 to November 30—	1907.	1906.	
Gross earnings	\$1,167,594.55	\$991,427.03	
Operating expenses	683,503.41	602,562.60	
Net earnings	484,091.14	388,864.43	
Lexington & Interurban Railways Company, Lexington, Ky.			
	1907.	1906.	
November—			
Gross earnings	\$43,034.01	\$40,148.18	
Operating expenses	27,702.64	24,633.05	
Net earnings	15,331.37	15,515.13	
January 1 to November 30—	1907.	1906.	
Gross earnings	\$516,355.02	\$481,579.83	
Operating expenses	325,463.51	313,009.85	
Net earnings	190,891.51	168,569.98	

## Dividends Declared.

- Athens (Ga.) Electric Railway, common, 2½ per cent; preferred, 3 per cent.
- Birmingham (Ala.) Railway Light & Power Company, preferred, 3 per cent.
- Brooklyn City Railroad, quarterly, 2½ per cent.
- Cincinnati Newport & Covington Light & Traction Company, Covington, Ky., common, quarterly ¾ of 1 per cent; preferred, quarterly, 1½ per cent.
- Duluth-Superior Traction Company, Duluth, Minn., preferred, quarterly, 1 per cent.
- Jacksonville (Fla.) Electric Company, common and preferred, 3 per cent.
- New Orleans (La.) City Railway, common, 1 per cent; preferred, 2½ per cent.
- Northampton (Mass.) Street Railway, 3 per cent.
- Omaha & Council Bluffs Street Railway, Omaha, Neb., common, 2 per cent; preferred, quarterly, 1¼ per cent.
- St. Charles Street Railroad, New Orleans, La., 3 per cent.

# Manufactures and Supplies

## ROLLING STOCK.

**Yazoo City Light Water & Sewerage Plant**, Yazoo City, Miss., which is owned by the city, it is reported will purchase four new cars in the near future.

**Denver & Interurban Railway**, Denver, Colo. is in the market for 12 interurban cars. In the Electric Railway Review of March 9 it was reported that this company was preparing the preliminary specifications for a number of high-speed cars.

**Grand Valley Railway**, Brantford, Ont., will probably place orders for several 23-foot city cars and a number of 52-foot cars for use on projected extensions aggregating 90.5 miles. Several electric locomotives may also be ordered. The road has recently changed hands. Murry A. Verner, Brantford, Ont., is president.

**Gary & Interurban Railway**, Gary, Ind., has placed an order with the Danville Car Company for two double-truck closed cars for city service. Delivery is to be made before March 1. The cars will have a seating capacity of 44 passengers. The wheel base will be 4 feet 6 inches, the length over buffers 42 feet, and width, over all, 8 feet 4 inches. The height is to be 9 feet 1 1/4 inches. The body and underframe are to be of wood and metal. The cars will be equipped with Peacock hand brakes, Brill trucks and two GE-80 motors.

## TRADE NOTES.

**H. F. Sanville** has resigned his connection with Dodge & Day, engineers, Philadelphia, to join the staff of Frank R. Gilbreth, general contractor, New York.

**Habirshaw Wire Company**, 253 Broadway, New York, is the new name of the Indian Rubber & Gutta Percha Insulating Company. The company's works are at Yonkers, N. Y.

**Safety Car Coupler Company**, Chattanooga, Tenn., has been incorporated with a capital stock of \$100,000 to manufacture a patented safety car coupler. The incorporators include A. W. Boyd, M. A. Brown and John Shamotulski.

**Dossert & Co.**, New York, have received an order from the American Car & Foundry Company, Berwick, Pa., for 720 two-way solderless connectors for use on the electrically-lighted steel cars now being constructed for the Pennsylvania Railroad.

**St. Louis Surfacers & Paint Company**, St. Louis, Mo., announces the appointment of H. N. Turner as manager of sales in the railroad department. Mr. Turner was formerly a representative of the Acme White Lead & Color Works, Detroit, Mich.

**Central Inspection Bureau**, 17 State street, New York City, has received an order from the Philadelphia Rapid Transit Company for the inspection of 35,000 ties which will be furnished by the American Tie & Timber Company of 11 Broadway, New York City.

**S. Butler Keys**, who has been connected with the Consolidated Car-Heating Company, 42 Broadway, New York, for the past six years, three years as manager of the eastern territory, has been appointed to a position in the railroad department of the H. W. Johns-Manville Company of New York.

**Danville Car Company** of Danville, Ill., has just completed the first of a lot of 12 semi-steel, semi-convertible cars for the Danville Street Railway Company, purchase of which was noted in a previous issue of the Electric Railway Review. The cars are 22 feet long and the outsides are covered with steel instead of the usual wood sheathing.

**Thomas Farmer, Jr.**, has been appointed eastern representative of the Consolidated Car-Heating Company, 42 Broadway, New York City, succeeding S. Butler Keys, whose resignation is announced in this issue of the Electric Railway Review. Mr. Farmer was formerly connected with the Consolidated Car-Heating Company at Albany, N. Y.

**Myron H. Lewis and Clifford B. Moore**, editors of Waterproofing, have opened offices in the St. James building, 1133 Broadway, New York, where they will conduct a general consulting engineering business in waterproofing, foundations, hydraulics and reinforced concrete. Special attention will be given to making investigations, reports and tests and to the preparation of plans, estimates and specifications for waterproofing and dampproofing work of every description. Sam-

ples of commercial waterproofing and dampproofing products and literature and information concerning every modern process will be kept on hand for the convenience of architects, engineers and builders.

**American Equipment Company** has opened an office in the West End Trust building, Philadelphia, Pa., to deal in new and second-hand contractors' machinery and railway equipment. The company will make a specialty of renting road rollers, concrete mixers, crushing plants, hoisting engines, steam shovels, etc. It will also purchase and dismantle plants, buying machinery of every description.

**Star Brass Works**, Kalamazoo, Mich., manufacturer of Kalamazoo trolley wheels and harps, reports that it has completed more of its special machinery, increasing the capacity of its plant by half. The company now expects to be able to handle orders more promptly than has been the case during the past six months. The demand for the Kalamazoo product for the last year was larger than ever before and the prospects for this year are satisfactory.

**American Locomotive Company**, 111 Broadway, New York, announces the following changes, effective on January 1: F. J. Cole, formerly mechanical engineer, has been appointed consulting engineer with headquarters at Schenectady. The office of mechanical engineer has been abolished and the duties heretofore performed by this officer will be included in the jurisdiction of William Dalton, chief engineer, with headquarters at Schenectady. Carl J. Mellin, formerly designing engineer, has been appointed consulting engineer with headquarters at Schenectady.

**A. M. Hewlett**, president of the Western Tube Company, Kewanee, Ill., whose death from paralysis on December 20 was reported in the Electric Railway Review of January 4, was 57 years old, and had lived in Kewanee 23 years. Mr. Hewlett had been president of the Western Tube Company since 1904, having worked his way up from the position of bookkeeper. As the executive head of the company he was more than successful. He not only wisely directed the business policy, but gave much attention to the welfare of his employees. Mr. Hewlett suffered his first paralytic stroke on Wednesday, December 18, but the fatal illness dated back many months. He leaves a widow and one son.

**Robert W. Hunt & Co.**, Chicago, inspecting and consulting engineers, have decided to establish a branch office and chemical laboratory at St. Louis, Mo. This representation will be under the charge of Charles W. Gennett, Jr., as noted in the Electric Railway Review of December 21. Mr. Gennett graduated with the degree of mechanical engineer from Cornell University in 1898, following which he was employed in the drafting room of the Baldwin Locomotive Works, and later in the inspecting and testing department of the Southern Railway. During the latter part of his connection with that organization he was in charge of their inspection work in Pittsburg and the west. Since then, and up to the time of entering the service of Robert W. Hunt & Co., he has been the western sales agent of the Atha Steel Casting Company, with headquarters in Chicago.

**Preston Car & Coach Company**, Preston, Ont., has completed its temporary plant for the manufacture of passenger equipment for steam and electric lines and is rebuilding a number of passenger cars for the Temiskaming & Northern Ontario. The company has 8 1-3 acres of land with spur tracks to the Grand Trunk and Canadian Pacific railways and has laid foundation for a 3-story L-shaped building with a frontage of 200 feet and a depth of 140 feet, the three floors to be used respectively as a blacksmith and machine shop, mill and cabinet shop and by the upholstering and finishing departments. A car construction shop to be built in two sections each 37 by 200 feet will also be erected. The permanent power house of reinforced concrete to conform to construction of the other permanent buildings is 40 by 60 feet and has been completed. The machinery thus far installed is new and of modern design. The temporary building now occupied is 80 by 260 feet and will be utilized for lumber sheds or other purposes when the plant is completed. In addition to the repair work now in hand for the Temiskaming & Northern Ontario the company has contracts for a number of new cars for passenger equipment for the same road and for several cars for electric lines. The directors of the company include Martin N. Todd, president and general manager of the Galt Preston & Hespeler Street Railway, who is also president of the company. Frederick Clair, vice-president of the company and mayor of Preston; George C liar, M. P.; George Pattinson, M. P.; C. Kloeffer, ex-M. P., and C. R. Hanning, who is secretary and treasurer of the company. The active management is in the hands of Donald M. Campbell, who is general manager, and Charles S. Wright, general sales manager.

## ADVERTISING LITERATURE.

**Whitmore Manufacturing Company, Cleveland, O.**—A lesson in gear protection and economy is shown in a recently issued folder. Illustrations demonstrate the difference in wear on gears used with and without Whitmore's gear protective compound.

**Joseph Dixon Crucible Company, Jersey City, N. J.**—A neat booklet recently issued has for its subject air brake lubrication. It contains a description of the properties, uses and special advantages of Dixon's Ticonderoga graphite air brake and triple valve grease and Dixon's special graphite No. 635.

**Locke Insulator Manufacturing Company, Victor, N. Y.**—A calendar bearing a most excellent reproduction of the famous painting "Nathalie," by Alfred Schwartz, is being distributed. Attached to the calendar is a brief description of the work of the artist who painted the original from which the reproduction was made.

**Novelty News, Chicago, Ill.**—A monthly publication, containing about 70 pages in 3-column make-up. It is full of novelty advertising suggestions, premium ideas and new plans to increase sales for manufacturer, jobber, merchant, salesman and agent. All the novelties of the month are shown, many of them illustrated.

**Cortright Metal Roofing Company, Philadelphia, Pa.**—The January issue of the Cortright Metal Shingle Advocate is out in a new and attractive cover. The contents are interesting and well worth reading. They give practical suggestions that create new thoughts about roofing which are apt to be overlooked by those who are not giving their whole time to building.

**Niles-Bement-Pond Company, New York, N. Y.**—An illustrated description of what is probably the largest and heaviest metal planer ever built is contained in a recently issued publication. The huge machine weighs 845,000 pounds, or 422½ tons, and requires motors with a total of 207½ horsepower for driving table, slotter bars, lift, etc. In general this machine is of the usual planer type, but it possesses a number of unusual features.

## SEMI-STEEL CARS FOR THE AMARILLO STREET RAILWAY.

The Danville Car Company has recently built for the Amarillo Street Railway Company, Amarillo, Tex., four of its



Semi-Steel Car—Amarillo Street Railway.

new semi-steel, semi-convertible cars. They have 22-foot car bodies, 32 feet 7 inches over all; the width of car body is 8 feet 2 inches over all.

Both side sills are of yellow pine, reinforced with steel plate between them. The subsidiary sills on each side for the truck are reinforced with steel angles. Body framing is made of ash. The sides of the car are covered longitudinally

with ½-inch tongued and grooved yellow pine and from the arm rail down are covered with No. 14 sheet steel in panels. The interior sides of the car are made of No. 14 sheet steel riveted together in one length, forming an interior truss. Each car is full vestibuled with folding doors.

The interior finish is of cherry except the steel panels below the arm rail. All cars are equipped with Hale & Kilburn walkover seats and Pantasote curtains, and are lighted by 15 incandescent lamps. The cars are equipped with the Danville Car Company side vestibule sign, the Kirby-Neal headlight and are mounted on Brill No. 21-E trucks.

## VICTOR PORTABLE TESTING METER.

By ordinary methods it requires considerable effort and more than one instrument to accurately measure the voltage, amperage and wattage of a lamp circuit. For this reason it

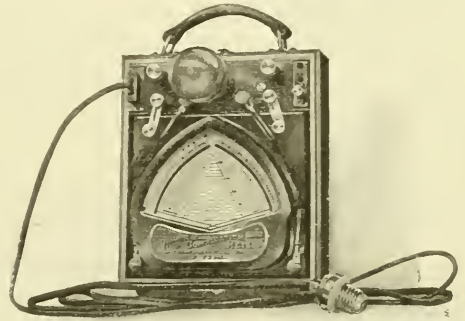

Victor Portable Testing Meter.

is interesting to learn that a new type of direct-current meter which will simultaneously exhibit all three quantities has just been placed on the market. To test a lamp it is only necessary to connect the attachment plug and cord of the portable meter to any lamp circuit, insert the lamp and read volts, amperes and watts without computation.

The movements are built on the familiar d'Arsonval pattern, and so placed with reference to each other and the scale as to render the energy consumption directly readable at the intersection of the volt and ampere indicator needles; the special feature being the design, which enables the operator to read at one glance the pressure, current and wattage on any lamp which may be inserted in a socket immediately above the meter.

The instrument is equipped with three self-contained shunts, one of 150 amperes capacity, having conveniently arranged binding posts, and a 1.5 and 0.75 ampere shunt, which is so connected within the base of the meter as to be readily thrown in circuit at will.

The different shunts may easily be placed in circuit by the adjustment of a small screw-plug at the top and right of the instrument. The two smaller shunts have universal connections.

The voltmeter may have either a 150 or a 300 volt scale or both. The most valuable feature of this instrument is the fact that accurate wattage measurement may be taken on a fluctuating load, as it is required to observe but a single point for such readings.

The instrument is entirely self-contained and weighs less than 15 pounds complete. It is being sold by the H. W. Johns-Manville Company, 100 William street, New York.

IMPROVED FORMS OF TICKETS.

Many electric railway companies are now turning their attention to the more general use of some form of ticket system instead of cash fares. While the electric railways were principally extensions of city street car lines and the conductor simply had to collect an additional 5-cent fare upon reaching the city limits the cash fare system was sufficient. However, this practice has in many cases been allowed to continue with the expansion of the road into a large number of zones until the burden on the conductor and the inconvenience to the passenger are unduly increased unless some form of ticket is used. When the roads expand still further and come into the class of railroads, basing their charges on mileage, a ticket system is absolutely necessary. Many city lines also are now using tickets to a large extent, especially where fares are sold for a reduced rate if purchased in quantities.

The use of tickets is not only a convenience to the conductor and to the passengers but provides a check on the number of fares collected. However, to be an effective check, the ticket system must be of such a form as to prevent manipulation and be easily handled in the auditor's office.

We present herewith illustrations of a number of improved forms of tickets and transfers which have been brought out by the Globe Ticket Company of Philadelphia. With its improved designs of machinery for the manufacture of tickets this company is able to furnish ticket forms which will commend themselves at once as possessing unusual advantages.

One of the latest ticket forms put on the market by the company is a mileage book which is suited to the requirements of both steam and interurban roads. This book may be furnished in units of miles or amounts of fares paid, with

The new package ticket shown herewith also presents a number of valuable features. It is furnished in strips containing any number of tickets from 6 to 24. Each ticket in the strip bears the same number instead of a number running consecutively through a sheet of tickets, a point that is of great value to the auditing department. These tickets are for both city and interurban use and have non-counterfeitable plate backs and tint faces. The tint face and the numbering may be of any color desired, the lettering being black.

The day and night transfer, samples of which are illustrated, is of an especially simple and convenient form and should commend itself at once to all managers. It gives the road an entirely different transfer for a. m. and p. m. use with no extra trouble to the conductors. As the transfers are issued for a. m. use without the coupon and for p. m. use with the coupon there is provided not only a different appearing transfer for the two parts of the day but also a

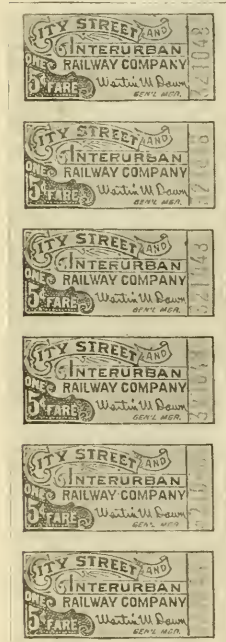

Globe Ticket Forms—Package Ticket.



Globe Ticket Forms—Strip from Mileage Book.

500, 1,000, 1,500 or 2,000 miles to a book. An especial feature is that the mileage is in one continuous strip, with no paste except for fastening to the cover. The accompanying illustrations show the appearance of both the mileage strip and the 5-cent zone strip, with the method of numbering. They are printed in four colors with non-counterfeitable tints. The book is strongly bound, with tough cardboard covers. On the inside of the front cover is a strip of celluloid which forms a straightedge for detaching mileage. The books are standard size and the printing and appearance are of a high grade.

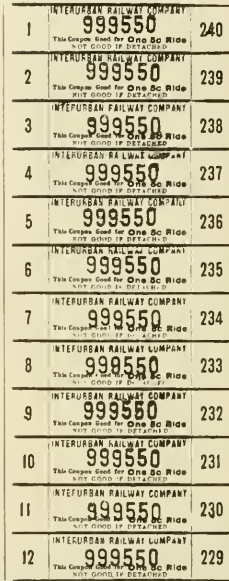

Globe Ticket Forms—Strip of 5-Cent Zone Checks.

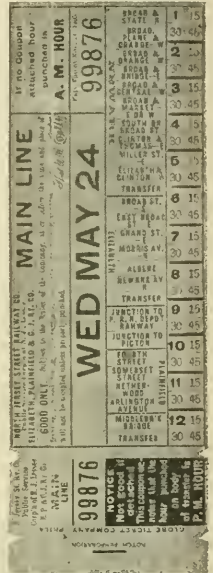

Globe Ticket Forms—Day and Night Transfer Slip.

different length transfer, thus enabling the receiving conductor to tell at a glance if the right transfer is presented. The convenience in the auditing department is also apparent. By the system of duplicate numbering an indisputable record is kept.

This form of transfer has been on the market but a short time, but it has already been adopted by about 60 roads, including the Interborough Rapid Transit Company, the Coney Island & Brooklyn Railroad and the Public Service Corporation of New Jersey, and in the cities of Birmingham, Ala., Richmond, Va., Minneapolis, Minn., Los Angeles, Cal., Spokane, Wash., Tacoma, Wash., and South Chicago, Ill.

Burns & Co., Chicago, consulting corporation specialists, announce the perfecting of their organization with offices in the Isabella building. The company offers the services of associated experts in consultation and personal examination in all matters pertaining to the promotion and preliminary work of public service and industrial projects, steam and electric railways, and all engineering undertakings. The company is fitted to give advice concerning any particular feature of the project from its organization to financing and final flotation, and during construction will give consultation service either with or without engineering advice. The staff of Burns & Co. has been brought together by J. J. Burns, manager, well known in the promotion and construction of steam and electric railroads; and affiliated financial, engineering and contracting connections will give clients every advantage consistent with a strictly consulting service.



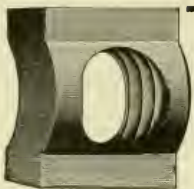

# Use GRIP NUTS on track bolts

and You Have a Better, Safer Track

GRIP NUTS never let loose under any strain, jar or vibration unless bolts break.

## GRIP NUT COMPANY

500 Fifth Avenue, NEW YORK

152 Lake Street, CHICAGO

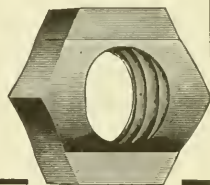

# It Pays



to buy this type of brake shoe—the kind approved by the A. S. & I. R. A. Standardization Committee.

We would like to give you figures based on facts that prove it! Write

## American Brake Shoe & Foundry Co.

New York Chicago Chattanooga MAHWAH, N. J.

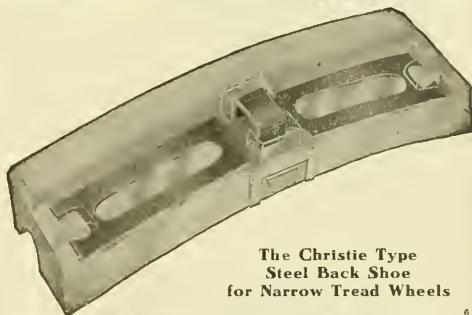

The Christie Type Steel Back Shoe for Narrow Tread Wheels

# C. A. W. Motors and Dynamos

We claim for them the advantages of perfect commutation, coolness in operation, high efficiency, substantial construction, interchangeable parts, high quality of insulation, perfect balance, and pleasing appearance.

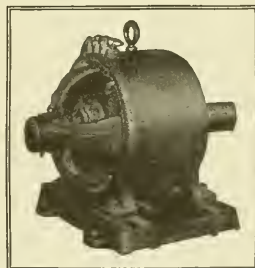

*Ask, please, for booklet and information about our offer of a 30-day free test*

## CLEVELAND ARMATURE WORKS, CLEVELAND, OHIO

*America's Greatest Armature Winding, Commutator and Field Works*

## THE J. G. BRILL COMPANY, PHILADELPHIA, PA.

AMERICAN CAR COMPANY, ST. LOUIS, MO.  
 G. C. KUHLMAN CAR COMPANY, CLEVELAND, OHIO  
 JOHN STEPHENSON COMPANY, ELIZABETH, N. J.  
 WASON MANUFACTURING CO. SPRINGFIELD, MASS.

MAIN OFFICE: PHILADELPHIA, PA.  
 LONDON OFFICE: 110 CANNON ST. E. C.  
 PACIFIC COAST AGENTS: PIERSON  
 ROEDING & CO., SAN FRANCISCO.  
 AUSTRALIAN AGENTS: NOYES  
 BROTHERS, SYDNEY. CABLES:  
 "BRILL," PHILA., "AXLES" LONDON.

*CARS TRUCKS SEATS RATTAN SPRINGS SPECIALTIES SUPPLIES*

## RATTAN SEAT COVERING

Brill rattan seat covering is woven in all widths from eighteen to thirty-six inches, the standard sizes being twenty, twenty-four and twenty-six inches, and the standard length of a roll is two hundred and twenty-five feet. For use on seat cushions it is lined with canvas, but for seat backs the unlined woven cane is amply strong for the purpose. We use the best selected hard cane, which, while it costs a little more than the soft cane often used, is well worth the difference, for it retains its clean, glossy appearance and color and is much more durable. Soft cane has very much the appearance of hard cane when new, but it discolors quickly and wears badly. Our method of weaving cane produces uniformity of texture, and the material never fails to give complete satisfaction. We manufacture seats for all types of city and interurban cars.

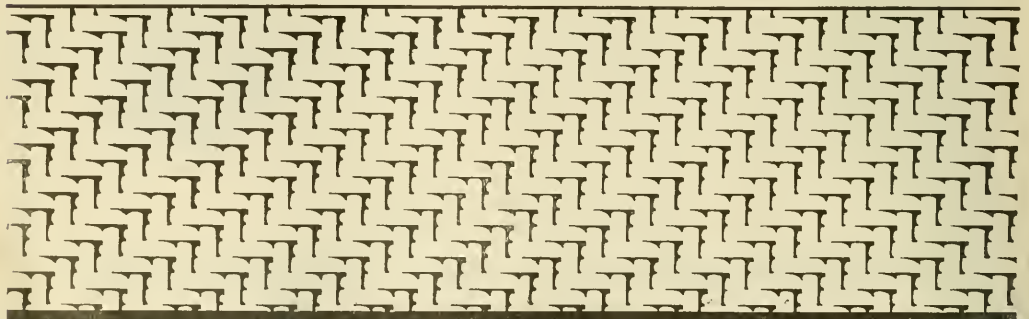

*LINED AND UNLINED TWILL WEAVE RATTAN*

# General Electric Company



## Railway Motor Gears



The Machine Shops

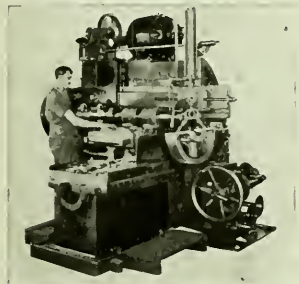

Type of Machine Employed in Joint Milling of Split Gear Castings.

The joint faces of both halves of split gears are milled simultaneously in the same jig and all bolt holes are drilled in a combination fixture which insures correct relation of holes in the two halves.

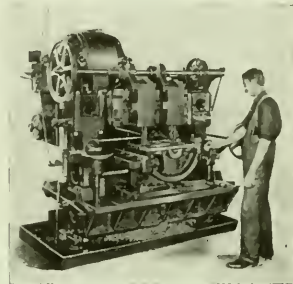

Type of Machine Employed in Drilling Four-Bolt Gears.

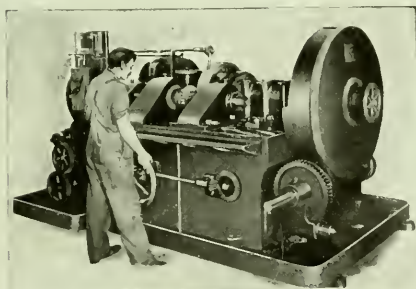

Type of Machine Employed in Circular Milling Gear Rims before Cutting Teeth.

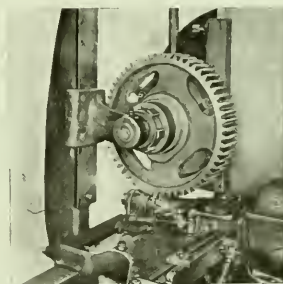

Gear Mounted in Gear Cutting Machine. Roughing and Finishing Cutter Operating Simultaneously.

Gear rims are machined on circular mill, in which operation the torque stress imposed on castings is more severe than is met in service.

Combination roughing and finishing cutters are employed in cutting teeth, insuring greater accuracy in tooth dimension than is obtainable by any other cutting method.

**“Original Equipment Quality”**

means

**“Original Equipment Service”**

*The final advertisement of this series in the Electric Railway Review will appear January 18th, entitled the “Inspection and Testing of General Electric Railway Motor Gears.”*

Chicago Office:  
Monadnock Building

Principal Office:  
**Schenectady, N. Y.**

Sales Offices in  
All Large Cities



Are you interested in trolley construction? Our "Red Booklet" is a book of facts. It tells why "Phono-Electric" trolley wire is superior to hard drawn copper wire. Mailed free.

**BRIDGEPORT BRASS CO.**  
 Postal Telegraph Building  
 Broadway and Murray Street, NEW YORK



**LUFKIN**

**MEASURING TAPES**  
 are the choice of expert electrical engineers in all quarters of the globe. Absolute accuracy and the highest possible degree of durability make them especially adapted to Electric Railway Work.

New York, London, Eng., Windsor, Can.  
**THE LUFKIN RULE CO.**  
 SAGINAW MICH., U. S. A.

For CABLE, ELECTRIC and ELEVATED CARS

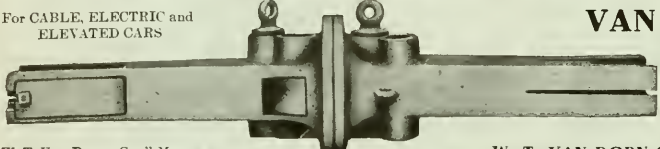

**VAN DORN AUTOMATIC COUPLERS**

The records go farther than talk. Look up the records. Send for booklet of information on Couplings.

W. T. VAN DORN, Gen'l Manager. No. 5

W. T. VAN DORN COMPANY, 1076 S. Paulina Street, CHICAGO

**Washburn "M" Type Traction Coupler** Strongest, Simplest and Cheapest Traction Coupler Ever Made

Illustration shows two "M" Type couplers on a forty-five degree curve and coupled with a short cast link as used on cars having a short wheel base. For longer cars a longer link casting is furnished, giving any amount of distance between cars, and affording the desired clearance when traveling curves.

Ask for new catalogue of traction devices.

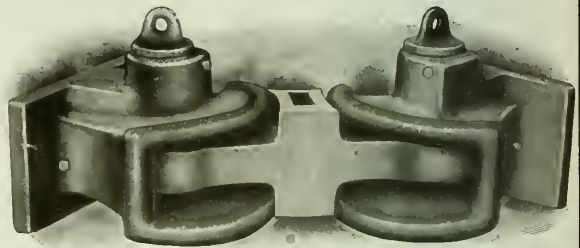

**Washburn Steel Castings & Coupler Co.**  
 MINNEAPOLIS, MINN.

Western Agents: Tweedy, Hood & Finlen, 2014 Fisher Bldg., Chicago Canadian Agent: John Taylor, Montreal



**Passenger Paying Fare**

Every nickel collected is registered before reaching the conductor's hand when you use the

**Rooke Automatic Fare Collector**

The Rooke System is a revolution in fare-collecting methods, and as far superior to old systems as the trolley car is to the horse car.

Why not ask us to prove it?

**Rooke Automatic Register Co.**  
 PROVIDENCE RHODE ISLAND

**WADDELL & MAHON**  
 Special Agents

PHILADELPHIA OFFICE Room 312 Lippincott Bldg. Long Distance Telephone 2403 Walnut

BALTIMORE OFFICE Room 406 Baltimore American Bldg. Long Distance Telephone 5347 St. Paul

BOSTON OFFICE Room 411 Post-Office Square Building Long Distance Telephone, 959 Fort Hill

**ALWAYS ON DUTY**  
 1133 BROADWAY  
 Suite 1024 and 1026 St. James Building  
 NEW YORK

Long Distance Telephone 4582 Madison Sq. Night Telephones { 2805 Melrose 2803 Melrose

**Have You Any Labor Troubles? Do You Anticipate Trouble? We Are Licensed Special Agents**

We are not a Detective Agency, but Special Agents who act for Corporations and Manufacturers in the termination of labor difficulties. We secure and furnish non-union mechanics in all trades, and skilled labor in all branches of industry, for service during strikes, and establishing the open shop. We also furnish Special Police Patrolmen, trained to their duties for the protection of non-union workmen and security of property. We establish, operate and maintain Commissaries for the maintenance of non-union workmen, performing Special Service during strikes and lockouts.

**We Are Not a Detective Agency We Are Successful We Get Results**

# Electric Railway Review

PUBLISHED EVERY SATURDAY.

FORMERLY THE STREET RAILWAY REVIEW.

THE WILSON COMPANY, CHICAGO.

160 Harrison Street, Chicago  
150 Nassau Street, New York  
1529 Williamson Bldg., Cleveland

VOL. XIX  
No. 3

CHICAGO, JANUARY 18, 1908

Whole No.  
217

Subscription: Domestic . . . \$2  
Foreign . . . \$5  
Canada . . . \$3.50

**NOW**  
is the time  
to patronize  
the optimist

---

---

*Advertisers: Remember, please,  
that the time to advertise is all  
the time you want to do business.*

You will find a large number of him represented in the advertising pages of the *Electric Railway Review*. These advertising optimists, you will note, cover every branch of the electric railway supply business. (Pessimists hardly ever or never advertise, you know).

If everybody will buy goods of optimists—of the men who have faith in their country and their business, and prove it by persistent advertising—if you will buy goods of them, the return to normal business conditions which set in with the New Year will be greatly accelerated.

Make it a point to read the advertising pages in this and following issues of the *Electric Railway Review*. Then place your orders with the men who are exerting every effort to make business what it ought to be and what it will be soon.

## Queen Testing Sets

"The Recognized Standard"

Voltmeters  
Ammeters  
Switchboard and Portable  
Alternating and Direct  
Current



Queen Acme Testing Set

U. S. Standard Testing Sets  
Rail Bond Testers  
Galvanometers, etc., etc.  
Electrical Instruments for All Purposes

**QUEEN & CO., Inc., Philadelphia, Pa.**

## WESTON Electrical Instrument Co.

Main Office and Works:  
WAVERLY PARK, NEWARK, N. J.



Weston Standard Illuminated  
Dial Station Voltmeter  
Model 11

**Illuminated  
Dial Station  
Instruments**

SEND FOR NEW CATALOGUE

Berlin—European Weston Electrical Instrument Co., Ritterstrasse, No. 88  
Paris, France—E. H. Cadot, 12 Rue St. Georges  
London—Audrey House, Ely Place, Holborn  
New York Office—74 Cortlandt St.



(End View)

Has adjustable steel noses—suitable for general urban and light interurban service. The most efficient low priced electric snow-plow on the market.

**The RUSSELL Pedestal  
Electric Snow-Plow No. 6**

Further information on request—also catalog electric snow-plows

**RUSSELL CAR & SNOW-PLOW COMPANY, Ridgway, Pa.**

Wendell & MacDuffie, Cortlandt St., New York—Eastern Sales Agents;  
Robinson & Cary Co., St. Paul, Minn., C. A. Ralston, Fisher Bldg., Chicago, Ill.—Western Sales Agents; Dominion Supply Co., Winnipeg, Manitoba—Western Canada Sales Agents.

Do away with the

## Hot Box Habit

on your road

by using STEEL WOOL JOURNAL PACKING—the perfect packing that has accomplished this result on many roads

Send now for a free sample and test it

**WM. ROBERTSON & COMPANY**

General Office: Great Northern Bldg., CHICAGO  
Factory: 75 S. Jefferson St., BATTLE CREEK, MICH.

10

# National Air Brakes

**EMERGENCY VALVES WITH QUICK-RELEASE FEATURE.**

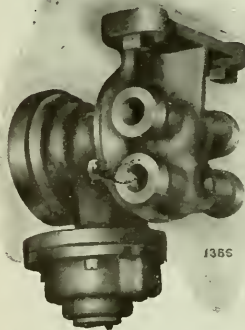

"National" Emergency Quick-Release Valve

The new "National" Emergency Valve with quick-release feature combines with the straight air brake system the emergency quick-set and quick-release features of the automatic system. This is the most simplified type of emergency apparatus, requiring one-third less piping than any other emergency equipment.

WRITE FOR DESCRIPTIVE BULLETIN.

## National Brake & Electric Co.

NEW YORK: 111 Broadway  
PHILADELPHIA: 1722 Westmoreland St.  
BOSTON: F. E. Huntress, 131 State St.

Milwaukee, U. S. A.

SAN FRANCISCO, CAL.: W. F. McKenny,  
526 Mission St.  
LONDON: 14 Great Smith St., Westminster

General Sales Office: 519 First National Bank Building, Chicago

# Westinghouse

## Protective Apparatus

### MAXIMUM PROTECTION AT MINIMUM COST

#### Some Leading Types:

- Type C Arrester** Alternating current, range 500 to 1250 volts. Has an instantaneous carrying capacity.
- Types I and J** Direct current for arc circuits up to 4000 volts. Type I mounted on marble base for station work. Type J enclosed in iron box for line use.
- Type T (Tank)** Direct current railway and power station work. 500 to 750 volts. The discharge path is through the water in the tank.

- M. P. Arrester** Alternating and direct current, range 500 to 750 volts, for railway work. Has a freedom of discharge many times greater than other low voltage arresters.
- Low Equivalent** High tension alternating current. An advance over all other types in its particular field.
- Electrolytic Arresters** High tension alternating current. The equivalent spark gap the lowest. Limits voltage to a certain critical value.

Ask for Circulars Nos. 1126 and 1146.

## Westinghouse Electric & Mfg. Co.

Atlanta  
Baltimore  
Boston

Buffalo  
Chicago  
Cincinnati

Cleveland  
Dallas  
Denver

Detroit  
Kansas City  
Los Angeles  
Minneapolis

New Orleans  
New York  
Philadelphia

Pittsburg  
St. Louis  
Salt Lake City

San Francisco  
Seattle  
Syracuse

Canada: Canadian Westinghouse Co., Ltd., Hamilton, Ontario. Mexico: G. & O. Braniff & Co., City of Mexico.



### Westinghouse Steam Turbines

#### Have No Secrets of Construction

The simple method of blade mounting; the water sealed packing glands surrounding the shaft; the automatic speed limit; the automatically controlled secondary valve, allowing enormous overloads; the oil-cushioned journals, are all details well known to the power-using public.

Steam Turbine Publication 7002 gives a detailed description; ask for it.

**The Westinghouse Machine Co.**  
Pittsburg, Pa.

### The Power Behind the Brake is the Air Compressor

Prompt and efficient brake action absolutely depends upon its reliability. Furthermore, the compressor comprises over 50 per cent of the cost of the brake equipment. The greatest care should therefore be exercised in selecting this important piece of apparatus. **YOU CAN RELY UPON WESTINGHOUSE COMPRESSORS—** they have stood the test of years in the hardest service.

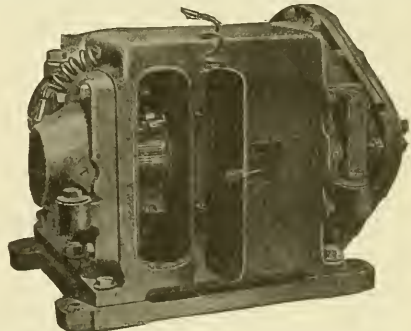

Compressor, showing accessibility of Commutator Brushes

### Westinghouse Traction Brake Co.

General Offices: Pittsburg, Pa.  
New York Chicago St. Louis  
Trinity Building Ry. Exchange Building 1932 N. Broadway.  
For Canada: Canadian Westinghouse Co., Ltd., Hamilton, Ont.

## ALPHABETICAL INDEX TO ADVERTISEMENTS.

Acme White Lead & Color Works	Drouvé, The G. Co.	Marshall, R. W., & Co.	Simmons, John, Co.
Advance Lumber Co.	Drummond Detective Agency	Massachusetts Chemical Co.	Smith, Peter, Heater Co.
Allis-Chalmers Co.	Durkin Controller Handle Co.	Meyers, Fred J., Mfg. Co.	Speer Carbon Co.
Aluminum Co. of America	Earl, C. L.	Middletown Car Works	Standard Brake Shoe Co.
American Brake Shoe & Fdry. Co.	Eclipse Railway Supply Co.	Miller Anchor Co.	Standard Motor Truck Co.
American Electrical Works	Electric Railway Equipment Co.	Milloy Electric Co., The	Standard Paint Co.
American Frog & Switch Co.	Electric Ry. Improvement Co.	Model Stoker Co., The	Standard Steel Works
Anderson, Albee & J. M., Mfg. Co.	Electric Service Supplies Co.	Morden Frog & Crossing Wks. 23	Standard Underground Cable Co.
Armstrong Oilier Co.	Engineering Agency, The	National Brake & Electric Co.	Standard Varnish Works
Arnold Company	Engineers and Contractors	National Carbon Co.	Star Brass Works
Atlas Anchor Co.	Fairbanks, Morse & Co.	National Lock Washer Co.	Stone & Webster Engr. Corp.
Babcock & Wilcox Co.	Ford, Bacon & Davis	Naugle Pole & Tie Co.	Stuart-Howland Co.
Baker, The Wm. C., Heating & Supply Co.	Galena-Signal Oil Co.	New York Switch & Crossing Co.	Symington, T. H., Co.
Baldwin Locomotive Works	General Electric Co.	Niles Car & Mfg. Co.	Telegraph Signal Co.
Barbour-Stockwell Co.	General Storage Battery Co.	Northern Engineering Works	Trolley Supply Co.
Barnes, G. H., Hardwood Lumber Co.	Gillette Chemical Co.	Nuttall, R. D., Co.	Under-Peet Stoker Co.
Beaver Dam Malleable Iron Co.	Gohen Mfg. Co.	Ohio Brass Co.	United States Graphite Co.
Beldier, Francis, & Co.	Goldschmidt Thermit Co.	Okonite Co., Ltd.	U. S. Metal & Mfg. Co.
Bentley & Mfg. Co.	Green Engineering Co.	Pacific Coast Pole Co.	Van Dorn & Dutton Co.
Berthold & Jennings	Green Fuel Economizer Co.	Pantaseo Co.	Van Dorn, W. T., Co.
Blake Signal & Mfg. Co.	Griffin Wheel Co.	Patten, Paul B.	Van Valkenburgh, E. C.
Bliss, R. Mfg. Co.	Grip Nut Co.	Ray-You-Enter Car Co.	Waddell & Mahon
Blount & Co.	Hagy, J. Milton, Waste Wks.	Power Specialty Co.	Wagenhorst, J. H., & Co.
Brill, The J. G. Co.	Haie & Kilburn Mfg. Co.	Pressed Steel Car Co.	Wallace Supply Co.
Brown, Harold P.	Harrison, F. P., Elec. Mfg. Co.	Queen & Co.	Wanton Ford Sale Cards
Buckeye Electric Co.	Hartsorn, Stewart, Co.	Rail Joint Co.	Washburn Steel Castings & Coupler Co.
Burnham, Williams & Co.	Heine Safety Boiler Co.	Railway Specialty & Supply Co.	Watson-Stillman Co.
Bylesby, H. M., & Co.	Heywood Bros. & Wakefield Co.	Recording Fare Register Co.	Wendell & MacDuffie
Central Inspection Bureau	Homan, D. F., Ry. Tracklayer	Reed, Francis, Co.	Western Electric Co.
Chase-Shawmut Co.	Homer Commutator Co.	Register, A. L., & Co.	Westinghouse Elec. & Mfg. Co.
Churchill Cedar Co.	Hooven-Owens-Rentschler Co.	Reiter, C. C., Canton, O.	Westinghouse Machine Co.
Cincinnati Car Co.	Hope Weibing Co.	Ridlon, Frank, Co., 200 Summer St., Boston	Westinghouse Traction Brake Co.
Cincinnati Frog & Switch Co.	Humbird Lumber Co., Ltd.	Roberts & Abbott Co.	Weston Electrical Instrument Co.
Cleveland Armature Works	Indestructible Fibre Co.	Robertson, Wm., & Co.	Wharton, Wm., Jr., & Co.
Cleveland Frog & Cross. Co.	Jewett Car Co.	Rohlf, Zeiss-Spring Co.	Wheeler Condenser & Eng'g Co.
Collier, Barron G.	Johann, F. A.	Rooke Automatic Register Co.	White, J. G., & Co.
Columbia Construction Co.	Johns-Manville, H. W., Co.	Rossiter, MacGovern & Co. (Inc.)	Whitmore Mfg. Co.
Consolidated Car Fender Co.	Kennicott Water Softener Co.	Russell Car & Snow-Plow Co.	Wilson, J. G., Mfg. Co.
Consolidated Car-Heating Co.	Kinnear Manufacturing Co.	S-E. Missouri Cypress Co.	Wm. Hill S. Co.
Contractors' Supply & Equipment Co.	Lindsay Bros. Co.	St. Louis Car Co.	Woodman, R., Mfg. & Supply Co.
Cooper Heating Co.	Lorain Steel Co.	St. Louis Car Wheel Co.	Worcester, C. H., Co.
Crane Co.	Lord & Burnham Co.	St. Louis Surface & Paint Co.	Zelnicke, Walter A., Supply Co.
Creshead Engineering Co.	Lufkin Rule Co.	Sanderson & Porter	
Curtain Supply Co.	Lumen Bearing Co.	Saxton, E.	
Davis, The John, Co.	Macallen Co.	Shimoda & Chase Co.	
Dearborn Drug & Chemical Works	McGuire-Cummings Mfg. Co.	Security Register & Mfg. Co.	
Detroit Graphite Co.		Sheaff & Jastaad	

## CLASSIFIED LIST OF ADVERTISERS.

<b>Advertising Service.</b> Van Valkenburgh, E. C., 2117 West One Hundred and Second St., Chicago.	<b>Armature Liffs.</b> Electric Service Supplies Co., 200 Plymouth Bldg., Chicago.	<b>Bells and Gongs—Continued.</b> Electric Service Supplies Co., 1020-24 Filbert St., Philadelphia. Kuhlman, The G. C., Car Co., Cleveland. McGuire-Cummings Mfg. Co., Chicago.	<b>Bonds, Rail—Continued.</b> General Electric Co., Schenectady, N. Y. Goldschmidt Thermit Co., 43 Exchange Pl., New York. Johns-Manville, H. W., Co., New York.
<b>Advertising, Street Car.</b> Collier, Barron G., Flat Iron Bldg., New York.	<b>Asbestos Materials.</b> Johns-Manville, H. W., Co., New York.	<b>Ohio Brass Co., Mansfield, O.</b> Reiter, C. C., Canton, O. St. Louis Car Co., St. Louis, Mo.	<b>Brackets and Cross Arms.</b> Anderson, Albert & J. M., Mfg. Co., Boston. Creshead Engineering Co., Cincinnati, O.
<b>Air Brakes—(See Brakes and Brake Parts).</b>	<b>Axles—(See Wheels and Axles).</b>	<b>Stephenson, John, Co., Elizabeth, N. J.</b> Wallace Supply Co., Chicago. Wason Mfg. Co., Springfield, Mass.	<b>Electric Railway Equipment Co., Cincinnati, O.</b> Electric Service Supplies Co., 200 Plymouth Bldg., Chicago. Lindsay Bros. Co., Spokane, Wash.
<b>Air Compressors—(See Compressors, Air).</b>	<b>Badges and Buttons.</b> Electric Service Supplies Co., 200 Plymouth Bldg., Chicago. Recording Fare Register Co., New Haven, Conn.	<b>Western Electric Co., Chicago.</b>	<b>Ohio Brass Co., Mansfield, O.</b> Ridlon, Frank, Co., 200 Summer St., Boston.
<b>Alloys and Bearing Metals.</b> Brown, H. P., 120 Liberty St., New York. General Electric Co., Schenectady, N. Y. Harrison Elec. & Mfg. Co., 169 South St., New York. Lumen Bearing Co., Buffalo, N. Y. Ohio Brass Co., Mansfield, O. Ridlon, Frank, Co., 200 Summer St., Boston. St. Louis Car Co., St. Louis, Mo.	<b>Ballast Cars—(See Cars, Ballast).</b>	<b>Block Lead.</b> Detroit Graphite Co., Detroit, Mich. U. S. Graphite Co., Saginaw, Mich.	<b>Western Electric Co., Chicago.</b>
<b>Aluminum Wire, Etc.</b> Aluminum Co. of America, Pittsburg.	<b>Ball Bearing.</b> Symington, T. H., Co., Baltimore, Md.	<b>Block System—(See Signals).</b>	<b>Blowers—(See Mechanical Draft)</b>
<b>Anchor.</b> Atlas Anchor Co., Cleveland, O. Electric Service Supplies Co., 200 Plymouth Bldg., Chicago. Miller Anchor Co., Norwalk, O. Ohio Brass Co., Mansfield, O.	<b>Bases—(See Trolley Poles and Fittings).</b>	<b>Blue Printing Machines.</b> Buckeye Engine Co., Salem, O.	<b>Boilers.</b> Babcock & Wilcox Co., N. Y. Fairbanks, Morse & Co., Chicago. Green Fuel Economizer Co., Matteawan, N. Y. Heine Safety Boiler Co., 421 Olive St., St. Louis. Lord & Burnham, Irvington-on-Hudson, New York. Rossiter, MacGovern & Co., 17 Battery Pl., New York.
<b>Armatures and Coils, Winding and Repairing.</b> Cleveland Armature Works, Cleveland, O. Electric Service Supplies Co., 200 Plymouth Bldg., Chicago. General Electric Co., Schenectady, N. Y. Harrison Elec. & Mfg. Co., 169 South St., New York. Marshall, R. W., & Co., 95 Liberty St., New York. Ridlon, Frank, Co., 200 Summer St., Boston. Stuart-Howland Co., Boston.	<b>Batteries.</b> General Storage Battery Co., 42 Broadway, New York.	<b>Boiler Cleaning Compound.</b> Dearborn Drug & Chemical Works, Chicago. Johns-Manville, H. W., Co., New York.	<b>Brakes and Brake Parts.</b> Allis-Chalmers Co., Milwaukee, Wis. American Car Co., St. Louis. Brill, The J. G., Co., Philadelphia. Electric Service Supplies Co., 200 Plymouth Bldg., Chicago. General Electric Co., Schenectady, N. Y. Kuhlman, The G. C., Car Co., Cleveland. McGuire-Cummings Mfg. Co., Chicago.
	<b>Bearings.</b> Electric Service Supplies Co., 200 Plymouth Bldg., Chicago. General Electric Co., Schenectady, N. Y. Harrison Elec. & Mfg. Co., 169 South St., New York. Lumen Bearing Co., Buffalo, N. Y. McGuire-Cummings Mfg. Co., Chicago. Marshall, R. W., & Co., 95 Liberty St., New York. Nuttall, R. D., Co., Pittsburg. Ohio Brass Co., Mansfield, O. Ridlon, Frank, Co., 200 Summer St., Boston. Symington, T. H., Co., Baltimore, Md. Van Dorn & Dutton Co., Cleveland, O.	<b>Bells and Gongs.</b> American Car Co., St. Louis. Brill, The J. G., Co., Philadelphia.	<b>National Brake &amp; Electric Co., Milwaukee.</b> Stephenson, John, Co., Elizabeth, N. J. Wason Mfg. Co., Springfield, Mass. Westinghouse Traction Brake Co., Pittsburg, Pa.
		<b>Bronze, Rail.</b> Brown, H. P., 120 Liberty St., New York. Chase-Shawmut Co., Newburyport, Mass. Electric Railway Improvement Co., Cleveland, O. Electric Service Supplies Co., 200 Plymouth Bldg., Chicago.	<b>Brakeshoes.</b> American Brake Shoe & Fdry. Co., Mahwah, N. J. American Car Co., St. Louis. Barbo-Stockwell Co., Cambridgeport, Mass.





5,000 V. Insulator  
Cat. No. 9405

# Attractive Prices

on Low-Voltage Porcelain Insulators for Telephone, Electric Light and Railway Feeder Work



Pony Double Groove Insulator  
Cat. No. 9400

We are quoting prices on low-tension insulators that *you cannot afford to overlook* Our insulators are of the highest quality and our factory facilities such that we are able to make immediate shipment on all standard types

Write for full particulars and ask for INSULATOR CATALOGUE No. 1

## THE OHIO BRASS COMPANY

MAIN OFFICE—MANSFIELD, OHIO—WORKS

New York: 43-49 Exchange Place  
Chicago: 321 Dearborn Street

Burt Gellatly, 336 Fourth Avenue, Pittsburg

St. Louis: 10 N. Fourth Street  
Atlanta: Peters Building

One of the strongest points about this car for installing rail bonds by

### Electric Brazing and Copper Welding

is its *portability*.



It can be removed from the track in one minute when necessary to meet traffic conditions. And it can be replaced in equally short time. Its use has proved profitable, without serious interruption of service, on lines running under a 2½-minute headway.

*We would like to tell you some more facts—write us, please.*

## The Electric Railway Improvement Co.

6005 Carnegie Avenue, Cleveland, Ohio

## CLASSIFIED LIST OF ADVERTISERS—Continued.

- Brakeshoes—Continued.  
Brill, The J. G., Co., Philadelphia.  
Kuhlman, The G. C., Car Co., Cleveland.  
McGuire-Cummings Mfg. Co., Chicago.  
Marshall, R. W., & Co., 95 Liberty St., New York.  
St. Louis Car Co., St. Louis, Mo.  
Standard Brake Shoe Co., Aurora, Ill.  
Stephenson, John, Co., Elizabeth, N. J.  
Wason Mfg. Co., Springfield, Mass.  
Wharton, Wm., Jr., & Co., Philadelphia.  
Wheel Truing Brake Shoe Co., Detroit.
- Bridges.  
Johann, F. A., 1624 Pierce Bldg., St. Louis.
- Bridge Timbers.  
Beider, Francis, & Co., Chgo.
- Brushes, Motors and Dynamoes.  
Electric Service Supplies Co., 200 Plymouth Bldg., Chicago.  
General Electric Co., Schenectady, N. Y.  
National Carbon Co., Cleveland, O.  
Ridlon, Frank, Co., 200 Summer St., Boston.  
Speer Carbon Co., St. Marys, Pa.
- Bumpers, Car.  
American Car Co., St. Louis.  
Brill, The J. G., Co., Philadelphia.  
Kuhlman, The G. C., Car Co., Cleveland.  
St. Louis Car Co., St. Louis, Mo.  
Stephenson, John, Co., Elizabeth, N. J.  
Wason Mfg. Co., Springfield, Mass.
- Car Cleaner.  
Gillette Chemical Co., 42 Broadway, New York.
- Car House Doors.  
Kinnear Mfg. Co., Columbus, O.  
Wilson, J. G., Mfg. Co., New York.
- Car Replacers.  
Electric Service Supplies Co., 200 Plymouth Bldg., Chicago.  
Fairbanks, Morse & Co., Chgo.  
Ohio Brass Co., Mansfield, O.  
U. S. Metal & Mfg. Co., 25 Broad St., New York.
- Car Roof Paint, Canvas.  
St. Louis Surfacor & Paint Co., St. Louis, Mo.
- Car Seats.  
American Car Co., St. Louis.  
Brill, The J. G., Co., Philadelphia.  
Hale & Kilburn Mfg. Co., Philadelphia.  
Heywood Bros. & Wakefield Co., Wakefield, Mass.  
Kuhlman, The G. C., Car Co., Cleveland.  
St. Louis Car Co., St. Louis, Mo.  
Stephenson, John, Co., Elizabeth, N. J.  
Wallace Supply Co., Chicago.  
Wason Mfg. Co., Springfield, Mass.
- Car Signs—(See Signs, Cars and Track).
- Car Steps.  
Electric Service Supplies Co., 200 Plymouth Bldg., Chicago.  
Wallace Supply Co., Chicago.
- Car Trimmings—(See Trimmings, Car).
- Cars, Ballast.  
Rodger Ballast Car Co., Chgo.  
St. Louis Car Co., St. Louis, Mo.
- Cars, Dump.  
Fairbanks, Morse & Co., Chgo.  
Midtown Car Works, Midtown, Pa.  
Rodger Ballast Car Co., Chgo.  
Russell Car & Snow-Plow Co., Ridgway, Pa.  
St. Louis Car Co., St. Louis, Mo.
- Cars, Passenger and Freight.  
American Car Co., St. Louis.  
Brill, The J. G., Co., Philadelphia.  
Cincinnati Car Co., Cincinnati.  
Detroit Carbuilding & Equipment Co., Detroit, Mich.
- Cars, Passenger and Freight—Continued.  
Electric Railway Improvement Co., Cleveland, O.  
Fairbanks, Morse & Co., Chgo.  
Jewett Car Co., Newark, O.  
Johann, F. A., 1624 Pierce Bldg., St. Louis.  
Kuhlman, The G. C., Car Co., Cleveland.  
McGuire-Cummings Mfg. Co., Chicago.  
Niles Car & Mfg. Co., Niles, O.  
Pressed Steel Car Co., Pittsburg.  
Rodger Ballast Car Co., Chgo.  
Russell Car & Snow-Plow Co., Ridgway, Pa.  
St. Louis Car Co., St. Louis, Mo.  
Standard Motor Truck Co., Pittsburg.  
Stephenson, John, Co., Elizabeth, N. J.  
Wason Mfg. Co., Springfield, Mass.
- Cars, Pay-As-You-Enter.  
Pay-As-You-Enter Car Co., 26 Cortland St., New York.
- Cars, Rebuilt.  
Detroit Carbuilding & Equipment Co., Detroit, Mich.
- Cars, Second-Hand.  
Detroit Carbuilding & Equipment Co., Detroit, Mich.  
Marshall, R. W., & Co., 95 Liberty St., New York.  
Zelnicke, Walter A., Supply Co., St. Louis.
- Cars, Steel.  
Midtown Car Works, Midtown, Pa.  
Pressed Steel Car Co., Pittsburg.  
St. Louis Car Co., St. Louis, Mo.  
Standard Motor Truck Co., Pittsburg.
- Castings, Brass.  
Star Brass Works, Kalamazoo, Mich.
- Castings, Iron and Steel.  
American Brake Shoe & Foundry Co., Mahan, N. J.  
Green Engineering Co., Com'l Nat. Bk. Bldg., Chicago.  
Lorain Steel Co., Johnstown, Pa.  
National Brake & Electric Co., Milwaukee.
- Catchers—(See Trolley Retrievers and Catchers).
- Cattle Guards.  
Fairbanks, Morse & Co., Chgo.
- Cements, Cable and Transformer.  
Massachusetts Chemical Co., Wapole, Mass.
- Circuit-Breakers.  
Electric Service Supplies Co., 200 Plymouth Bldg., Chicago.  
General Electric Co., Schenectady, N. Y.  
Western Electric Co., Chicago.
- Coal Handling Machinery—(See Conveyors).
- Coils—(See Armatures and Coils).
- Commutators and Parts.  
Cleveland Armature Works, Cleveland, O.  
Electric Service Supplies Co., 1020-24 Filbert St., Phila.  
General Electric Co., Schenectady, N. Y.  
Harrison Elec. & Mfg. Co., 169 South St., New York.  
Homer Commutator Co., Cleveland, O.  
Marshall, R. W., & Co., 95 Liberty St., New York.  
Ohio Brass Co., Mansfield, O.  
Stuart-Howland Co., Boston.
- Compressors, Air.  
Fairbanks, Morse & Co., Chgo.  
General Electric Co., Schenectady, N. Y.  
National Brake & Electric Co., Milwaukee.  
Westinghouse Traction Brake Co., Pittsburg.
- Concrete Mixers.  
Columbian Supply & Equip. Co., Chicago.
- Condensers.  
Wheeler Con. & Eng. Co., New York.
- Conduits.  
Electric Service Supplies Co., 200 Plymouth Bldg., Chicago.  
Western Electric Co., Chicago.
- Contractors.  
Arnold Company, 181 La Salle St., Chicago.  
Bylesby, H. M., Co., Am. Fairbldg., Chicago.  
Columbia Construction Co., Milwaukee, Wis.  
Cresgreah Engineering Co., Cincinnati, O.  
Green Engineering Co., Com'l Nat. Bk. Bldg., Chicago.  
Register, A. L., & Co., 112 N. Broad St., Philadelphia.  
Sanderson & Porter, 52 William St., New York.  
Saxton, E., 841 Bladensburg R., Washington, D. C.  
Sheaf & Jaastad, 83 Broad St., Boston.  
Stone & Webster Engineering Corp., Boston.  
Wharton, Wm., Jr., & Co., Philadelphia.  
White, J. G., & Co., 49 Exchange Pl., New York.
- Controllers and Attachments.  
Durkin Co., Har. Co., Arcade Bldg., Philadelphia.  
Electric Service Supplies Co., 200 Plymouth Bldg., Chicago.  
General Electric Co., Schenectady, N. Y.  
Harrison Elec. & Mfg. Co., 169 South St., New York.  
Johns-Manville, H. W., Co., New York.  
Marshall, R. W., & Co., 95 Liberty St., New York.  
Western Electric Co., Chicago.  
Westinghouse Electric & Mfg. Co., Pittsburg.
- Conveyors and Coal Handling Machinery.  
Green Engineering Co., Com'l Nat. Bk. Bldg., Chicago.  
Northern Engineering Works, Detroit, Mich.
- Cord, Bell and Trolley.  
American Car Co., St. Louis.  
Brill, The J. G., Co., Philadelphia.  
Electric Service Supplies Co., 1020-24 Filbert St., Phila.  
Kuhlman, The G. C., Car Co., Cleveland.  
St. Louis Car Co., St. Louis, Mo.  
Stephenson, John, Co., Elizabeth, N. J.  
Stuart-Howland Co., Boston.  
Wason Mfg. Co., Springfield, Mass.
- Couplers, Car.  
American Car Co., St. Louis.  
Brill, The J. G., Co., Philadelphia.  
Kuhlman, The G. C., Car Co., Cleveland.  
McGuire-Cummings Mfg. Co., Chicago.  
Ohio Brass Co., Mansfield, O.  
St. Louis Car Co., St. Louis, Mo.  
Stephenson, John, Co., Elizabeth, N. J.  
Van Dorn, W. T., Co., Paulina St., Chicago.  
Wallace Supply Co., Chicago.  
Washburn, E. C., Minneapolis.  
Wason Mfg. Co., Springfield, Mass.
- Coverings, Pipe and Boiler.  
Johns-Manville, H. W., Co., New York.
- Cranes, Hoists and Lifts.  
American Car Co., St. Louis.  
Brill, The J. G., Co., Philadelphia.  
Brown Hoisting Machinery Co., Cleveland, O.  
Kuhlman, The G. C., Car Co., Cleveland.  
Northern Engineering Works, Detroit, Mich.  
Railway Specialty & Supply Co., Chicago.  
Stephenson, John, Co., Elizabeth, N. J.  
Van Dorn & Dutton Co., Cleveland, O.  
Wason Mfg. Co., Springfield, Mass.
- Cross Arms—(See Brackets and Cross Arms).
- Crossing Gates—(See Gates and Guards).
- Crossings, Track—(See Switches).
- Curtains, Fixtures and Materials.  
American Car Co., St. Louis.  
Brill, The J. G., Co., Philadelphia.  
Curtain Supply Co., 93 Ohio St., Chicago.
- Curtains, Fixtures and Materials—Continued.  
Electric Service Supplies Co., 200 Plymouth Bldg., Chicago.  
Hartshorn Stewart, Co., East Newark, N. J.  
Kuhlman, The G. C., Car Co., Cleveland.  
Marshall, R. W., & Co., 95 Liberty St., New York.  
National Lock Washer Co., Newark, N. J.  
Pantastock Co., 11 Broadway, New York.  
St. Louis Car Co., St. Louis, Mo.  
Stephenson, John, Co., Elizabeth, N. J.  
Wason Mfg. Co., Springfield, Mass.
- Cylinder Oil.  
Power Specialty Co., 111 Broadway, N. Y.
- Derailing Devices.  
American Frog & Switch Co., Hamilton, O.  
Cincinnati Frog & Switch Co., Cincinnati, O.  
Cleveland Frog & Crossing Co., Cleveland, O.
- Detective Agency.  
Drummond Detective Agency, New York.
- Diphragms.  
Wood, G. S., Great Northern Bldg., Chicago.
- Doors and Fixtures.  
American Car Co., St. Louis.  
Brill, The J. G., Co., Philadelphia.  
Kuhlman, The G. C., Car Co., Cleveland.  
St. Louis Car Co., St. Louis, Mo.  
Stephenson, John, Co., Elizabeth, N. J.  
Wallace Supply Co., Chicago.  
Wason Mfg. Co., Springfield, Mass.
- Doors, Steel Rolling.  
Kinnear Manufacturing Co., Columbus, O.  
Wilson, J. G., Mfg. Co., New York.
- Draft, Mechanical—(See Mechanical Draft).
- Draft Rigging.  
Van Dorn, W. T., Co., Chgo.  
Wallace Supply Co., Chicago.
- Drills, Track.  
Brown, H. P., 120 Liberty St., New York.  
Electric Service Supplies Co., 200 Plymouth Bldg., Chicago.  
Fairbanks, Morse & Co., Chgo.  
Marshall, R. W., & Co., 95 Liberty St., New York.  
Reed, Francis, Co., Worcester, Mass.  
Ridlon, Frank, Co., 200 Summer St., Boston.
- Drying Appliances.  
Green Fuel Economizer Co., Matteawan, N. Y.
- Dynamos and Generators.  
Cleveland Armature Works, Cleveland, O.  
Fairbanks, Morse & Co., Chgo.  
General Electric Co., Schenectady, N. Y.  
National Brake & Electric Co., Milwaukee, Wis.  
Rossiter, MacGovern & Co., 17 Battery Pl., New York.  
Western Electric Co., Chicago.  
Westinghouse Electric & Mfg. Co., Pittsburg, Pa.
- Economizers, Fuel.  
Green Fuel Economizer Co., Matteawan, N. Y.
- Electrical Instruments.  
Electric Service Supplies Co., 200 Plymouth Bldg., Chicago.  
General Electric Co., Schenectady, N. Y.  
Johns-Manville, H. W., Co., New York.  
Queen & Co., Philadelphia.  
Western Electric Co., Chicago.  
Westinghouse Electric & Mfg. Co., Pittsburg, Pa.  
Weston Electrical Instrument Co., Newark, N. J.
- Electric Railway Supplies, General.  
Cleveland Armature Works, Cleveland, O.  
Cresgreah Engineering Co., Cincinnati, O.

# ST. LOUIS CAR CO. ST. LOUIS-MO.

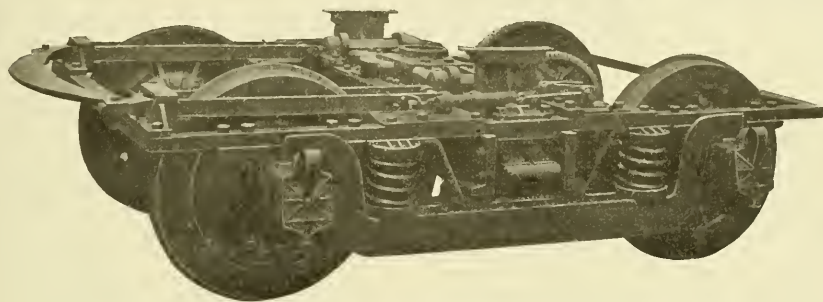

St. Louis Car Company M. C. B. Double Equalizer Type No. 62 Truck

## Details of Construction:

**T**RUCK frames are made of wrought iron forged in one piece, with a heavy fillet in each corner, and planed to receive pedestal jaws and center frames of transoms. Pedestals are of wrought iron and the upper face of each is machined so as to lip on side frame. Wearing faces are machined and provided with oil grooves. Faces which engage the pedestal tie bars are also machined.

Transoms are made of two 10" channels secured to frames by being bolted to machined cast steel side strut castings and bolted to side frame with heavy steel gusset plates.

Removable chafing plates are also provided on the transom channels. Bolsters are of cast steel and provided with end springs to

limit side motion of car body. Bolsters also are provided with removable chafing plates.

Equalizers are of wrought iron and forged with a lug to fit into recess in the journal boxes. Brakes are of the equalized type and arranged to suit cars operated around short curves.

Brake rigging is provided with suitable safety hangers. Ends of hangers and hanger pins are case hardened to reduce the wear to a minimum and prevent rattling.

All bolts used in assembling the trucks are taper finished, turned to a taper of  $\frac{3}{16}$ " per foot, and all holes for bolts are reamed to templates.

All parts of the truck when machined are made to template and all holes are drilled with a jig.

Made in the largest and best equipped  
factory of its kind in the world.

## CLASSIFIED LIST OF ADVERTISERS—Continued.

- Electric Railway Supplies, General—Continued.**  
 Electric Service Supplies Co., 200 Plymouth Bldg., Chicago.  
 Fairbanks, Morse & Co., Chgo. General Electric Co., Schenectady, N. Y.  
 Harrison Elec. & Mfg. Co., 169 South St., New York.  
 Johns-Manville, H. W., Co., New York.  
 Marshall, R. W., & Co., 95 Liberty St., New York.  
 Ohio Brass Co., Mansfield, O.  
 Stuart-Howland Co., Boston.  
 Wallace Supply Co., Chicago.  
 Western Electric Co., Chicago.
- Enamels.**  
 Acme White Lead & Color Works, Detroit, Mich.  
 St. Louis Surfact & Paint Co., St. Louis, Mo.
- Engine Apparatus.**  
 Green Fuel Economizer Co., Matteawan, N. Y.
- Engineers and Contractors.**  
 Arnold Company, Chicago.  
 Cleshey, H. C. M., Mansfield, O.  
 Columbia Construction Co., Milwaukee, Wis.  
 Ford, Bacon & Davis, New York.  
 Register, A. L., & Co., Philadelphia.  
 Roberts & Abbott Co., Cleveland, O.  
 Sanderson & Porter, New York.  
 Saxton, E., Washington, D. C.  
 Stone & Webster Eng. Corporation, Boston.  
 White, J. G., & Co., New York.
- Engines, Gas and Oil.**  
 Buckeye Engine Co., Salem, O.  
 Fairbanks, Morse & Co., Chgo. Westinghouse Machine Co., Pittsburg.
- Engines, Hoisting.**  
 Fairbanks, Morse & Co., Chgo.
- Engines, Steam.**  
 Buckeye Engine Co., Salem, O.  
 Hooven-Owens-Rentschler Co., Hamilton, O.  
 Rossiter, MacGovern & Co., 17 Battery Pl., New York.  
 Westinghouse Machine Co., Pittsburg.
- Fans, Exhaust and Ventilating.**  
 General Electric Co., Schenectady, N. Y.  
 Green Fuel Economizer Co., Matteawan, N. Y.  
 Western Electric Co., Chicago.  
 Westinghouse Elec. & Mfg. Co., Pittsburg.
- Fare Boxes—(See Electric Railway Supplies).**
- Fare Registers and Register Fittings.**  
 Electric Service Supplies Co., 200 Plymouth Bldg., Chicago.  
 Recording Fare Register Co., New Haven, Conn.  
 Rooke Automatic Register Co., Providence, R. I.  
 Security Register & Mfg. Co., 42 Broadway, New York.
- Feedwater Apparatus.**  
 Green Fuel Economizer Co., Matteawan, N. Y.  
 Wheeler Condenser & Eng'g Co., New York.
- Feed Wire—(See Wire and Cables).**
- Fenders and Guards.**  
 Consolidated Car Fender Co., Providence, R. I.  
 Eclipse Railway Supply Co., Cleveland, O.  
 Electric Service Supplies Co., 1020-24 Filbert St., Phila.  
 McGuire-Cummings Mfg. Co., Chicago.  
 Marshall, R. W., & Co., 95 Liberty St., New York.
- Flangers, Snow.**  
 McGuire-Cummings Mfg. Co., Chicago.  
 Ohio Brass Co., Mansfield, O.  
 Van Dorn & Dutton Co., Cleveland, O.
- Frogs—(See Switches, Frogs and Crossings).**
- Fuel Economizers—(See Economizers, Fuel).**
- Fuses and Fuse Devices.**  
 Chase-Shawmut Co., Newburyport, Mass.
- Fuses and Fuse Devices—Continued.**  
 Electric Service Supplies Co., 200 Plymouth Bldg., Chicago.  
 General Electric Co., Schenectady, N. Y.  
 Johns-Manville, H. W., Co., New York.  
 Western Electric Co., Chicago.  
 Westinghouse Elec. & Manufacturing Co., Pittsburg.
- Gaskets, Bronze.**  
 Power Specialty Co., 111 Broadway, New York.
- Gates and Guards.**  
 Bliss, R., Mfg. Co., Pawtucket, R. I.
- Gear Cases.**  
 Electric Service Supplies Co., 200 Plymouth Bldg., Chicago.  
 General Electric Co., Schenectady, N. Y.  
 Marshall, R. W., & Co., 95 Liberty St., New York.
- Gears and Pinions.**  
 Electric Service Supplies Co., 200 Plymouth Bldg., Chicago.  
 General Electric Co., Schenectady, N. Y.  
 Marshall, R. W., & Co., 95 Liberty St., New York.  
 Nuttall, R. D., Co., Pittsburg.  
 Van Dorn & Dutton Co., Cleveland, O.
- Generators—(See Dynamos).**
- Gongs—(See Bells and Gongs).**
- Graphite.**  
 Detroit Graphite Co., Detroit, Mich.  
 U. S. Graphite Co., Saginaw, Mich.
- Graphite Paint—(See Paint).**
- Grates, Chain.**  
 Green Engineering Co., Com'l Nat. Bk. Bldg., Chicago.
- Grease—(See Lubricants).**
- Grinders.**  
 Brown, Harold P., 120 Liberty St., New York.
- Guy Anchors—(See Anchors).**
- Harps, Trolley—(See Trolley Poles and Fittings).**
- Headlights.**  
 Electric Service Supplies Co., 200 Plymouth Bldg., Chicago.  
 Fairbanks, Morse & Co., Chgo. General Electric Co., Schenectady, N. Y.  
 Ridlon, Frank Co., 200 Summer St., Boston.  
 St. Louis Car Co., St. Louis, Mo.  
 Stuart-Howland Co., Boston.  
 Trolley Supply Co., Canton, O.
- Headlinings, Passenger Car.**  
 Indestructible Fibre Co., 46 Broadway, New York.
- Heaters, Car, Electric.**  
 Consolidated Car-Heating Co., Albany, N. Y.  
 Johns-Manville, H. W., Co., New York.
- Heaters, Car, Hot Water, and Stoves.**  
 Baker, The Wm. C., Heating & Sup. Co., New York.  
 Cooper Heater Co., The, Dayton, O.  
 Electric Service Supplies Co., 1020-24 Filbert St., Phila.  
 McGuire-Cummings Mfg. Co., Chicago.  
 Smith, Peter, Heater Co., Detroit, Mich.
- Heating and Ventilating Apparatus—(See Mech. Draft).**
- Holsts—(See Cranes, Holsts and Lifts).**
- Hose Bridges.**  
 Ohio Brass Co., Mansfield, O.
- Hydraulic Machinery.**  
 Watson-Stillman Co., 26 Cortlandt St., New York.
- Inspection.**  
 Central Inspection Bureau.  
 Inspection Cars, Gasoline. Stover Motor Car Co., Freeport, Ill.
- Instruments, Measuring and Testing—(See Electrical Instruments).**
- Insulating Tapes.**  
 General Electric Co., Schenectady, N. Y.  
 Harrison Elec. & Mfg. Co., 169 South St., New York.  
 Massachusetts Chemical Co., Walpole, Mass.  
 Okonite Co., Ltd., 253 Broadway, New York.  
 Western Electric Co., Chicago.
- Insulations and Insulating Material.**  
 Anderson, A. & J. M., Mfg. Co., Boston.  
 Craghead Engineering Co., Cincinnati, O.  
 Electric Railway Equipment Co., Cincinnati, O.  
 Electric Service Supplies Co., 200 Plymouth Bldg., Chicago.  
 General Electric Co., Schenectady, N. Y.  
 Johns-Manville, H. W., Co., New York.  
 Macallen, The Co., Boston.  
 Massachusetts Chemical Co., Walpole, Mass.  
 Ohio Brass Co., Mansfield, O.  
 Okonite Co., Ltd., 253 Broadway, New York.  
 Ridlon, Frank Co., 200 Summer St., Boston.  
 Standard Paint Co., 100 William St., New York.  
 Standard Varnish Works, New York.  
 Stuart-Howland Co., Boston.  
 Western Electric Co., Chicago.
- Jacks.**  
 American Car Co., St. Louis.  
 Brill, The J. G., Co., Philadelphia.  
 Electric Service Supplies Co., 200 Plymouth Bldg., Chicago.  
 Fairbanks, Morse & Co., Chgo. Kuhlman, The G. C., Car Co., Cleveland.  
 Marshall, R. W., & Co., 95 Liberty St., New York.  
 Morden Frog & Crossing Co., Chicago.  
 Security Register & Mfg. Co., New York.  
 Stephenson, John, Co., Elizabeth, N. J.  
 Wason Mfg. Co., Springfield, Mass.  
 Watson-Stillman Co., 26 Cortlandt St., New York.
- Joints, Expansion—(See Steam Fittings).**
- Joints, Rail.**  
 Goldschmidt Thermit Co., 43 Exchange Pl., New York.  
 Rail Joint Co., 29 W. 34th St., New York.
- Joints, Welded—(See Rail Joints, Welded).**
- Journal Boxes.**  
 American Car Co., St. Louis.  
 Brill, The J. G., Co., Philadelphia.  
 Kuhlman, The G. C., Car Co., Cleveland.  
 McGuire-Cummings Mfg. Co., Chicago.  
 St. Louis Car Co., St. Louis, Mo.  
 Stephenson, John, Co., Elizabeth, N. J.  
 Symington, T. H., Co., Baltimore, Md.  
 Wason Mfg. Co., Springfield, Mass.
- Journal Lubricators—(See Lubricants).**
- Journal Packing, Steel Wool.**  
 Robertson, Wm., & Co., Great Northern Bldg., Chicago.
- Lamps, Arc and Incandescent.**  
 Anderson, A. & J. M., Mfg. Co., Boston.  
 Electric Service Supplies Co., 200 Plymouth Bldg., Chicago.  
 General Electric Co., Schenectady, N. Y.  
 Ridlon, Frank Co., 200 Summer St., Boston.  
 Stuart-Howland Co., Boston.  
 Western Electric Co., Chicago.  
 Westinghouse Electric & Mfg. Co., Pittsburg, Pa.
- Lamp Sockets.**  
 Electric Service Supplies Co., 200 Plymouth Bldg., Chicago.  
 General Electric Co., Schenectady, N. Y.
- Lifts—(See Cranes, Hoist and Lift).**
- Lighting Arresters.**  
 Electric Service Supplies Co., 200 Plymouth Bldg., Chicago.  
 General Electric Co., Schenectady, N. Y.  
 Stuart-Howland Co., Boston.  
 Western Electric Co., Chicago.  
 Westinghouse Elec. & Manufacturing Co., Pittsburg.
- Line Material.**  
 Anderson, A. & J. M., Mfg. Co., Boston.  
 Craghead Engineering Co., Cincinnati, O.  
 Johns-Manville, H. W., Co., New York.  
 Electric Ry. Equipment Co., Cincinnati, O.  
 Electric Service Supplies Co., 200 Plymouth Bldg., Chicago.  
 General Electric Co., Schenectady, N. Y.  
 Macallen, The Co., Boston.  
 Marshall, R. W., & Co., 95 Liberty St., New York.  
 Recording Fare Register Co., Chicago, Ill., Conn.  
 Stuart-Howland Co., Boston.  
 Western Electric Co., Chicago.
- Lock and Nut Washers.**  
 Grip Nut Co., 152 Lake St., Chicago, Ill., Conn.  
 National Lock Washer Co., Newark, N. J.
- Lockers, Metal.**  
 Electric Service Supplies Co., 200 Plymouth Bldg., Chicago.
- Locomotives.**  
 Baldwin Locomotive Works, Philadelphia.  
 Johnson, F. A., 1624 Pierce Bldg., St. Louis.  
 Locomotives, Electric.  
 American Car Co., St. Louis.  
 Baldwin Locomotive Works, Philadelphia.  
 Brill, The J. G., Co., Philadelphia.  
 General Electric Co., Schenectady, N. Y.  
 Kuhlman, The G. C., Car Co., Cleveland.  
 McGuire-Cummings Mfg. Co., Chicago.  
 Stephenson, John, Co., Elizabeth, N. J.  
 Wason Mfg. Co., Springfield, Mass.  
 Westinghouse Elec. & Manufacturing Co., Pittsburg.
- Locomotives, Gasoline.**  
 Fairbanks, Morse & Co., Chgo. Stover Motor Car Co., Freeport, Ill.
- Lubricants.**  
 Dearborn Drug & Chemical Works, Chicago.  
 Detroit Graphite Co., Detroit, Mich.  
 Galena-Signal Oil Co., Franklin, Pa.  
 U. S. Graphite Co., Saginaw, Mich.  
 Whitmore Mfg. Co., Cleveland, O.
- Lumber.**  
 Barnes, G. H., Hardwood Lumber Co., St. Louis, Mo.  
 Beidler, Francis, & Co., Chgo.  
 Berthold & Jennings, St. Louis.  
 Lindsley Bros. Co., Spokane, Wash.  
 S-E, Missouri Cypress Co., Campbell, Mo.
- Lumber, Asbestos.**  
 Johns-Manville, H. W., Co., New York.
- Malleable Iron.**  
 Beaver Dam Malleable Iron Co., Beaver Dam, Wis.  
 St. Louis Car Co., St. Louis, Mo.
- Measuring Tapes.**  
 Lutfid, Rule Co., Saginaw, Mich.
- Mechanical Draft.**  
 Green Fuel Economizer Co., Matteawan, N. Y.
- Meters.**  
 Johns-Manville, H. W., Co., New York.  
 Weston Electrical Instrument Co., Newark, N. J.

# An Ex-Straphanger's Views on Pay-As-You-Enter Cars



Reprinted  
from the  
Chicago  
Daily  
News



## THOSE NEWEST CARS.

Have you ridden on the new pay-as-you-enter cars yet? They're fine. For the last year I have had to stand up all the way downtown, but when I got on the car Monday morning there were plenty of seats and cars. I think these cars are a big success. Of course, some of those people who have been getting on around Van Buren street when going home from work will kick about them. But half of the people that get on the street cars of the Cottage Grove line around Van Buren street get home half of the time without paying their fares. I know one man who told me that he paid only about one fare a week when going home. With this new system everybody will have to pay his fare, which is no more than just. The conductor was exceptionally polite to the passengers. I saw him direct several passengers to seats up in the front which were not observable from the rear. When all the seats were filled he politely told those desiring to get on to "take the next car, please." Indiana avenue has been the star line for some time, but now Cottage Grove avenue has got them all beaten, and beaten good.

EX-STRAHANGER.

"Ex-Straphanger" voices the sentiments of thousands of Chicago's street railway patrons—and those, too, of patrons in every city where Pay-As-You-Enter Cars are in operation.

Comment is unnecessary.

We license manufacturers and railways to build and use the Pay-As-You-Enter Car, the patents on which are owned by

## The Pay-As-You-Enter Car Company

DUNCAN McDONALD  
President 26 Cortlandt Street, New York

THOS. W. CASEY  
Manager

## CLASSIFIED LIST OF ADVERTISERS—Continued.

- Molded Goods.**  
Massachusetts Chemical Co., Walpole, Mass.  
Wood, G. S., Great Northern Bldg., Chicago.
- Motor Cars, Gasoline.**  
Stover Motor Car Co., Freeport, Ill.
- Motors, Electric.**  
Cleveland Armature Works, Cleveland, O.  
Fairbanks, Morse & Co., Chgo.  
General Electric Co., Schenectady, N. Y.  
National Brake & Electric Co., Milwaukee.  
Rossier, MacGovern & Co., 17 Battery Pl., New York.  
Western Electric Co., Chicago.  
Westinghouse Elec. & Manufacturing Co., Pittsburg.
- Nut Locks.**  
Grip Nut Co., 152 Lake St., Chicago.  
National Lock Washer Co., Newark, N. J.  
Railway Specialty & Supply Co., Chicago.  
St. Louis Car Co., St. Louis, Mo.  
U. S. Metal & Mfg. Co., 25 Broad St., New York.
- Nuts and Bolts.**  
Grip Nut Co., 152 Lake St., Chicago.  
Lorain Steel Co., Philadelphia.  
National Lock Washer Co., Newark, N. J.  
Railway Specialty & Supply Co., Chicago.
- Oilers.**  
Armstrong Oiler Co., 31st and Chestnut St., Philadelphia.
- Oils—(See Lubricants).**
- Overhead Equipment—(See Electric Railway Supplies).**
- Packings.**  
Electric Service Supplies Co., 200 Plymouth Bldg., Chicago.  
Johns-Manville, H. W., Co., New York.  
Power Specialty Co., 111 Broadway, New York.
- Packing, Steel Wool Journal.**  
Robertson, Wm., & Co., Gt. Northern Bldg., Chicago.
- Paints.**  
Acme White Lead & Color Works, Detroit.  
Detroit Graphite Co., Detroit.  
Goben Mfg. Co., Canton, O.  
Massachusetts Chemical Co., Walpole, Mass.  
Standard Paint Co., 100 William St., New York.  
St. Louis Surfacer & Paint Co., St. Louis, Mo.  
U. S. Graphite Co., Saginaw, Mich.
- Pay-As-You-Enter Cars.**  
Pay-As-You-Enter Car Co., 26 Cortlandt St., New York.
- Pipe Bends and Fittings—(See Steam Fittings).**
- Plumbago.**  
Detroit Graphite Co., Detroit, Mich.  
U. S. Graphite Co., Saginaw, Mich.
- Poles, Metal.**  
Creaghead Engineering Co., Cincinnati, O.  
Electric Railway Equipment Co., Cincinnati, O.  
Electric Service Supplies Co., 200 Plymouth Bldg., Chicago.
- Poles and Ties, Wood.**  
Advance Lumber Co., Cleveland, O.  
Barnes, G. H., Hardwood Lumber Co., St. Louis, Mo.  
Beidler, Francis & Co., Chgo.  
Berthold & Jennings, St. Louis.  
Churchill Cedar Co., Spokane, Wash.  
Humbird Lumber Co., Sand Point, Idaho.  
Linsley Bros. Co., Spokane, Wash.  
Nagle Pole & Tie Co., 226 La Salle St., Chicago.  
Pacific Coast Pole Co., Spokane, Wash.  
S-E. Missouri Cypress Co., Campbell, Mo.  
Worcester, C. H., Co., Tribune Bldg., Chicago.
- Punches—(See Ticket Punches).**
- Rail Benders.**  
Electric Service Supplies Co., 200 Plymouth Bldg., Chicago.  
Fairbanks, Morse & Co., Chgo.
- Rail Bonds—(See Bonds, Rail).**
- Rail Brackets.**  
Beaver Dam Malleable Iron Co., Beaver Dam, Wis.
- Rail Drills—(See Drills, Track).**
- Rail Feed Wire—(See Wire and Cables).**
- Rail Joints and Chairs—(See Joints, Rail).**
- Rail Joints, Welded.**  
Goldschmidt Thermit Co., 43 Exchange Pl., New York.  
Lorain Steel Co., Philadelphia.
- Rails, New.**  
Lorain Steel Co., Philadelphia.  
New York Switch & Crossing Co., Hoboken, N. J.  
Wharton, Wm., Jr., & Co., Philadelphia.
- Rails, Relaying.**  
Zelicker, Walter A., Supply Co., St. Louis.
- Railway Equipment.**  
Johann, F. A., 1624 Pierce Bldg., St. Louis.
- Railway Velocipedes.**  
Fairbanks Morse & Co., Chgo.
- Registers and Fittings—(See Fare Registers).**
- Relays.**  
Western Electrical Instrument Co., Newark, N. J.
- Roofing.**  
Johns-Manville, H. W., Co., New York.
- Rubber Goods, Mechanical.**  
Wood, G. S., Great Northern Bldg., Chicago.
- Rubber Preservative.**  
Wood, G. S., Great Northern Bldg., Chicago.
- Sand Apparatus.**  
American Car Co., St. Louis.  
Brill, The J. G., Co., Philadelphia.  
Electric Service Supplies Co., 200 Plymouth Bldg., Chicago.  
Kuhlman, The G. C., Car Co., Cleveland.  
Marshall, R. W., & Co., 95 Liberty St., New York.  
Ohio Brass Co., Mansfield, O.  
Ridlon, Frank Co., 200 Summer St., Boston.  
St. Louis Car Co., St. Louis, Mo.  
Stephenson, John, Co., Elizabeth, N. J.  
Wason Mfg. Co., Springfield, Mass.
- Sash Balances and Fixtures.**  
National Lock Washer Co., Newark, N. J.
- Sash Operating Devices.**  
Drouvé, The G., Co., Bridgeport, Conn.  
Lord & Burnham, Irvington-on-Hudson, New York.
- Seats, Car—(See Car Seats).**
- Shade Rollers—(See Curtains, Fixtures and Materials).**
- Shutters, Steel Rolling.**  
Kinnear Manufacturing Co., Columbus, O.
- Signals.**  
Blake Signal & Manufacturing Co., Boston.  
Telegraph Signal Co., Rochester, N. Y.
- Signal Supplies.**  
Railway Specialty & Supply Co., Chicago.
- Skylights.**  
Drouvé, The G., Co., Bridgeport, Conn.  
Lord & Burnham, Irvington-on-Hudson, New York.
- Snow Plows, Sweepers and Scrapers.**  
American Car Co., St. Louis.  
Brill, The J. G., Co., Philadelphia.  
Kalamazoo Railway Supply Co., Kalamazoo, Mich.  
Kuhlman, The G. C., Car Co., Cleveland.
- Snow Plows, Sweepers and Scrapers—Continued.**  
McGuire-Cummings Mfg. Co., Chicago.  
Russell Car & Snow-Plow Co., Chicago.  
Stephenson, John, Co., Elizabeth, N. J.  
Wason Mfg. Co., Springfield, Mass.
- Sockets, Waterproof.**  
Johns-Manville, H. W., Co., New York.
- Special Agents.**  
Waddell & Mahon, 1133 Broadway, New York.
- Splicing Compounds and Materials.**  
Massachusetts Chemical Co., Walpole, Mass.
- Springs.**  
American Car Co., St. Louis.  
Brill, The J. G., Co., Philadelphia.  
Kuhlman, The G. C., Car Co., Cleveland.  
McGuire-Cummings Mfg. Co., Chicago.  
Marshall, R. W., & Co., 95 Liberty St., New York.  
Railway Steel Spring Co., 71 Broadway, New York.  
St. Louis Car Co., St. Louis, Mo.  
Stephenson, John, Co., Elizabeth, N. J.  
Wason Mfg. Co., Springfield, Mass.
- Sprinkling Cars.**  
American Car Co., St. Louis.  
Brill, The J. G., Co., Philadelphia.  
Kuhlman, The G. C., Car Co., Cleveland.  
McGuire-Cummings Mfg. Co., Chicago.  
Stephenson, John, Co., Elizabeth, N. J.  
Wason Mfg. Co., Springfield, Mass.
- Steam Apparatus.**  
Green Fuel Economizer Co., Mattewan, N. Y.
- Steam Fittings, Etc.**  
Crane Co., Chicago.  
Davis, The John Co., Chgo.  
Simmons, John, Co., 110 Centre St., New York.  
Power Specialty Co., 111 Broadway, New York.
- Steel Cars.**  
American Car Co., St. Louis.  
Brill, The J. G., Co., Philadelphia.  
Kuhlman, The G. C., Car Co., Cleveland.  
St. Louis Car Co., St. Louis, Mo.  
Stephenson, John, Co., Elizabeth, N. J.  
Wason Mfg. Co., Springfield, Mass.
- Steel Tapes.**  
Lufkin Rule Co., Saginaw, Mich.
- Stokers.**  
Bahcock & Wilcox Co., 85 Liberty St., New York.  
Green Engineering Co., Com'l Nat. Bk. Bldg., Chicago.  
Model Stoker Co., Dayton, O.  
Under-Feed Stoker Co. of Am., Chicago.  
Westinghouse Machine Co., Pittsburg.
- Storage Batteries—(See Batteries).**
- "Strike-Breakers."**  
Drummond Detective Agency, 3 Ann St., New York.  
Waddell & Mahon, 1133 Broadway, New York.
- Superheaters.**  
Power Specialty Co., 111 Broadway, New York.
- Switches, Frogs and Crossings.**  
American Frog & Switch Co., Hamilton, O.  
Barbour-Stockwell Co., Cambridgeport, Mass.  
Cincinnati Frog & Switch Co., Cincinnati, O.  
Cleveland Frog & Crossing Co., Cleveland, O.  
Fairbanks, Morse & Co., Chgo.  
Lorain Steel Co., Philadelphia.  
Morden Frog & Crossing Co., Rookery, Chicago.
- Switches, Frogs and Crossings—Continued.**  
New York Switch & Crossing Co., Hoboken, N. J.  
Railway Specialty & Supply Co., Chicago.  
Wharton, Wm., Jr., & Co., Philadelphia.
- Switchboards and Switchboard Instruments.**  
Anderson, A. & J. M., Mfg. Co., Boston.  
Chase-Shawmut Co., Newburyport, Mass.  
General Electric Co., Schenectady, N. Y.  
Western Electric Co., Chicago.  
Westinghouse Electric & Mfg. Co., Pittsburg.  
Weston Electrical Instrument Co., Newark, N. J.
- Tapes and Webbing.**  
Hope Webbing Co., Providence, R. I.  
Johns-Manville, H. W., Co., New York.  
Massachusetts Chemical Co., Walpole, Mass.  
Okonite Co., Ltd., 253 Broadway, New York.
- Testing Instruments.**  
Weston Electrical Instrument Co., Newark, N. J.
- Ticket Choppers and Destroyers.**  
Patten, Paul B., Salem, Mass.
- Ticket Punches.**  
Meyers, Fred J., Mfg. Co., Hamilton, O.  
Woodman Mfg. & Sup. Co., Boston.
- Tieplates.**  
Beaver Dam Malleable Iron Co., Beaver Dam, Wis.
- Ties and Poles, Wood—(See Poles and Ties).**
- Timber.**  
Beidler, Francis & Co., Chgo.  
Linsley Bros. Co., Spokane, Wash.  
S-E. Missouri Cypress Co., Campbell, Mo.
- Tools, Pneumatic—(See Pneumatic Tools).**
- Track Cleaners and Scrapers.**  
American Car Co., St. Louis.  
Brill, The J. G., Co., Philadelphia.  
Kuhlman, The G. C., Car Co., Cleveland.  
McGuire-Cummings Mfg. Co., Chicago.  
Marshall, R. W., & Co., 95 Liberty St., New York.  
Ohio Brass Co., Mansfield, O.  
Stephenson, John, Co., Elizabeth, N. J.  
Van Dorn & Dutton Co., Mo.  
Wason Mfg. Co., Springfield, Mass.
- Track Drills—(See Drills, Track).**
- Tracklaying Machinery.**  
Holman, D. F., Ry. Tracklayer Co., 1102 Ellsworth Bldg., Chicago.
- Track Tools.**  
Electric Service Supplies Co., 200 Plymouth Bldg., Chicago.
- Trimmings, Car.**  
American Car Co., St. Louis.  
Brill, The J. G., Co., Philadelphia.  
Curtain Supply Co., Park Row Bldg., New York.  
Kuhlman, The G. C., Car Co., Cleveland.  
National Lock Washer Co., Newark, N. J.  
St. Louis Car Co., St. Louis, Mo.  
Stephenson, John, Co., Elizabeth, N. J.  
Wallace Supply Co., Chicago.  
Wason Mfg. Co., Springfield, Mass.  
Wood, G. S., Great Northern Bldg., Chicago.
- Trolley Guards.**  
Electric Service Supplies Co., 200 Plymouth Bldg., Chicago.
- Trolley Poles and Fittings.**  
General Electric Co., Schenectady, N. Y.  
Johns-Manville, H. W., Co., New York.  
Marshall, R. W., & Co., 95 Liberty St., New York.



**TRADE MARK**  
Registered U. S. Patent Office

# The Standard for Rubber Insulation

RAILWAY FEED WIRES insulated with OKONITE are unequalled for flexibility, durability and efficiency, and are in use by the leading Electric Street Railway Companies. OKONITE is preferred above any other insulation for Car Wiring, Telegraph and Telephone Purposes

**Okonite Wires, Okonite Tape, Manson Tape, Candee Weatherproof Wires**

SAMPLES AND ESTIMATES ON APPLICATION

## THE OKONITE CO., Ltd.,

WILLARD L. CANDEE, H. DURANT CHEEVER, Managers.  
GEORGE T. MANSON, Gen'l Supt.; W. H. HODGINS, Secretary.

253 Broadway, NEW YORK

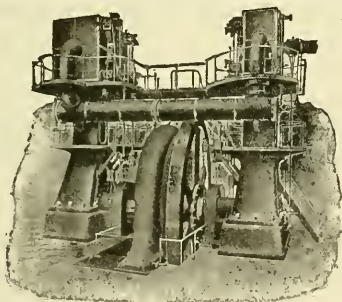

### VERTICAL CROSS-COMPOUND ENGINES

Awarded Gold Medal at World's Fair, St. Louis

Made in all sizes. We also build other types for all purposes.

A visit to our factories—which you are cordially invited to make—will prove interesting. Ask for catalog, please.

### The Hooven-Owens-Rentschler Co.

HAMILTON, OHIO, U. S. A.  
BRANCH OFFICES:

ATLANTA, GA., Equitable Bldg. BOSTON, MASS., H. E. Rundlett.  
CHICAGO, ILL., Marquette Bldg. CHARLOTTE, N. C., A. H. Washburn.  
DENVER, COLO., Stearns-Roger Mfg. Co. LOS ANGELES, CAL., Chas. C. Moore & Co. NEW YORK, N. Y., 39 Cortlandt St.  
PITTSBURG, PA., Machesney Bldg. SAN FRANCISCO, CAL., Chas. C. Moore & Co. SEATTLE, WASH., Chas. C. Moore & Co. ST. LOUIS, MO., Chemical Bldg. ST. PAUL, MINN., R. B. Whitacre & Co.  
HONOLULU, S. I., Honolulu Iron Works. DALLAS, TEX., W. R. Haynie, Wilson Bldg. NEW ORLEANS, LA., 417 Hennen Bldg. 1

## Shawmut Soldered Railbonds

Are the Original Soldered Bonds  
8 YEARS of Service Under ALL  
Conditions Prove Their RE-  
LIABILITY.



WHY Not Try a Proven Bond  
at Least

SEND FOR OUR PROPOSITION

See Bulletin No. 29

**CHASE-SHAWMUT CO.**

Newburyport, Mass.

CLASSIFIED LIST OF ADVERTISERS—Continued.

- Trolley Retrievers and Catchers. Earle, C. I., Bowling Green Bldg., New York.
- Electric Service Supplies Co., 1020-24 Filbert St., Phila.
- Milloy Electric Co., Bucyrus. O. Rldon, Frank, Co., 200 Summer St., Boston.
- Trolley Supply Co., Canton, O.
- Trolley Wheels—(See Trolley Poles and Fittings).
- Trolley Wire—(See Wire and Cables).
- Trolleys, Track. Cleveland Armature Works, Cleveland, O.
- Trucks, Car. American Car Co., St. Louis. Baldwin Locomotive Works, Philadelphia.
- Brill, The J. G., Co., Philadelphia.
- Kuhlman, The G. C., Car Co., Cleveland.
- McGuire-Cummings Mfg. Co., Chicago.
- St. Louis Car Co., St. Louis, Mo.
- Standard Motor Truck Co., Pittsburg, Pa.
- Standard Varnish Works, New York City.
- Stephenson, John, Co., Elizabeth, N. J.
- Van Dorn & Dutton Co., Cleveland, O.
- Wason Mfg. Co., Springfield, Mass.
- Turbines. General Electric Co., Schenectady, N. Y.
- Hooven-Owens-Rentschler Co., Hamilton, O.
- Westinghouse Machine Co., Pittsburg, Pa.
- Valves—(See Steam Fittings).
- Varnish. Acme White Lead & Color Works, Detroit.
- Electric Service Supplies Co., 200 Plymouth Bldg., Chicago.
- Harrison Elec. & Mfg. Co., 169 South St., New York.
- Marshall, R. W., & Co., 95 Liberty St., New York.
- Massachusetts Chemical Co., Walpole, Mass.
- Milloy Electric Co., Bucyrus, O.
- Nuttall, R. D., Co., Pittsburg.
- Rldon, Frank, Co., 200 Summer St., Boston.
- Standard Paint Co., 100 William St., New York.
- Star Brass Works, Kalamazoo, Mich.
- Troy Supply Co., Canton, O.
- Wallace Supply Co., Chicago.
- Westinghouse Electric & Mfg. Co., Pittsburg, Pa.
- Ventilators. Drouvé, The G., Co., Bridgeport, Conn.
- Lord & Burnham, Irvington-on-Hudson, New York.
- Vestlettes. Bellamy Vestlette Mfg. Co., Cleveland, O.
- Waste, Cotton and Wool. Hagy, J. Milton, Waste Wks., Philadelphia, Pa.
- Railway Specialty & Supply Co., Chicago.
- Water Softening Apparatus. Dearborn Drug & Chemical Works, Chicago.
- Kennicott Water Softener Co., Chicago.
- Wheels and Axles. American Car Co., St. Louis.
- Brill, The J. G., Co., Philadelphia.
- Griffin Wheel Co., Chicago.
- Kuhlman, The G. C., Car Co., Cleveland.
- Lorain Steel Co., Philadelphia.
- McGuire-Cummings Mfg. Co., Chicago.
- Marshall, R. W., & Co., 95 Liberty St., New York.
- Railway Steel-Spring Co., New York.
- St. Louis Car Co., St. Louis, Mo.
- St. Louis Car Wheel Co., St. Louis.
- Standard Steel Works, Philadelphia.
- Stephenson, John, Co., Elizabeth, N. J.
- Wason Mfg. Co., Springfield, Mass.
- Wheel Grinders. Wheel Trund Brake Shqe Co., Detroit, Mich.
- Whitewashing Machines. Wallace Supply Co., Chicago.
- Window Fixtures. Drouvé, The G., Co., Bridgeport, Conn.
- Wiping Rags. Hagy, J. Milton, Waste Wks., Philadelphia, Pa.
- Wire, Aluminum. Aluminum Co. of America, Pittsburg, Pa.
- Wire, Insulated. Aluminum Co. of America, Pittsburg, Pa.
- American Electrical Works, Providence, R. I.
- General Electric Co., Schenectady, N. Y.
- Okonite Co., Ltd., 253 Broadway, New York.
- Standard Underground Cable Co., Pittsburg, Pa.
- Stuart-Howland Co., Boston.
- Wire and Cables. Aluminum Co. of America, Pittsburg, Pa.
- American Electrical Works, Providence, R. I.
- Bridgeport Brass Co., Bridgeport, Conn.
- General Electric Co., Schenectady, N. Y.
- Okonite Co., Ltd., 253 Broadway, New York.
- Standard Underground Cable Co., Pittsburg, Pa.

**"METALSTEEL" PAINT**  
Best Steel Protective and Rust Preventive for all Metal Surfaces.



**ST. LOUIS SURFACER & PAINT COMPANY**  
St. Louis, U. S. A.

**Fire Extinguishers  
Fire Hose Carts and Reels**

**GUILFORD S. WOOD**  
ELECTRIC RAILWAY NECESSITIES  
Great Northern Bldg., Chicago

**ARMALAC**



passed out of the experimental stage a great many years ago.

Continued and increasing use has demonstrated it to be a permanent and plastic insulating compound of the highest efficiency.

Send for booklet "How to Insulate an Armature"

**Massachusetts Chemical Co., Walpole, Mass.**  
Operates Walpole Rubber Works and Walpole Varnish Works  
Largest manufacturers of friction tape and insulating compound in the world

"The Oasis in the Desert of Waste"

**Motor Packing Waste**

No dirt or grit  
All long strands and satisfaction

**The J. Milton Hagy Waste Works**  
433 Spruce Street, Philadelphia

**THE BABCOCK & WILCOX COMPANY**  
85 Liberty Street, New York

Babcock & Wilcox — Stirling — A & T Horizontal — Cahall Vertical

**WATER TUBE STEAM BOILERS**

Works: Bayonne, N. J. Barberton, Ohio.

BRANCH OFFICES:

STEAM SUPERHEATERS

MECHANICAL STOKERS

BOSTON, Delta Bldg.  
PHILADELPHIA, 1110-1112 North American Bldg.  
SAN FRANCISCO, 63 First Street  
PITTSBURGH, Farmers Deposit Nat. Bank Bldg.  
NEW ORLEANS, 343 Baronne St.

DENVER, 410 Seventeenth St.  
SALT LAKE CITY, 313 Atlas Block  
WASHINGTON, Colorado Building  
CHICAGO, Marquette Bldg.  
ATLANTA, GA., 1132 Candler Bldg.

CLEVELAND, 706 New England Bldg.  
MEXICO CITY, 7 Avenida, Juarez  
HAVANA, CUBA, 116 1/2 Calle de la Habana  
LOS ANGELES, 321 Trust Bldg.  
CINCINNATI, O., Traction Bldg.



NEW YORK

ST. LOUIS

# The Security Register

is the only one, both double and single, that comprehends the simplicity of the present practice, giving an absolute and legible record of results mechanically, and a universal identification of employes connected with the operation of each car, or, in other words, a watchman's clock on every car. We make both double and single, giving absolutely indelible records and of unlimited capacity and with positive identification.



Double Recorder

## Roth Universal High-Pressure JACKS

For Street Cars, Railroads and every purpose where Jacks are used.

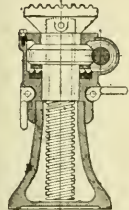

The most powerful and economical Jack made.

Ball-Bearing throughout. The One-Man Jack.

Capacity unlimited.



### The SECURITY REGISTER & MFG. CO.

For information write Gen. Office, 42 Broadway, New York

# Take It—It's Free

Will you take advantage of this opportunity to learn, without any expense to you, of a Tape without lumps or pin holes, with the greatest insulating and adhesive qualities, and with exceptional strength and durability? Then send to our nearest Branch and you will receive a liberal sample of **Jomanco Friction Tape** so that you can test it in competition with any other and satisfy yourself of its superiority.



Write nearest branch for free sample and booklet D-423

## H. W. JOHNS-MANVILLE CO.



NEW YORK  
MILWAUKEE  
CHICAGO  
BOSTON  
PHILADELPHIA  
ST. LOUIS

PITTSBURG  
CLEVELAND  
BUFFALO  
BALTIMORE  
NEW ORLEANS  
KANSAS CITY

MINNEAPOLIS  
SAN FRANCISCO  
LOS ANGELES  
SEATTLE  
DALLAS  
LONDON

704



## Sleet

causes no uneasiness to the superintendent who keeps a supply of "Nuttall" sleet scrapers and trolley wheels on hand. They can be applied in a minute.

"If in a hurry, wire us."

ASK FOR CATALOGUE NO. 10

R. D. Nuttall Company  
Pittsburg, Pa.

GEARS PINIONS TROLLEYS

# TUBULAR POLES IRON OR STEEL



FOR  
ELECTRIC RAILWAYS  
ELECTRIC LIGHTING CO'S  
SIGNAL  
TELEPHONE (SERV)  
TELEGRAPH (VICE)  
TRANSMISSION LINE  
AND CATERNARY SUSPENSION LINE

ELECTRIC RAILWAY EQUIPMENT CO.  
General Office: CINCINNATI O. U.S.A.  
Shops: READING PA - WHEELING W.VA.

# Standard "High Speed Interurban" Double Truck

Types C-60 and C-60-A, "Solid Forged", Without Welds

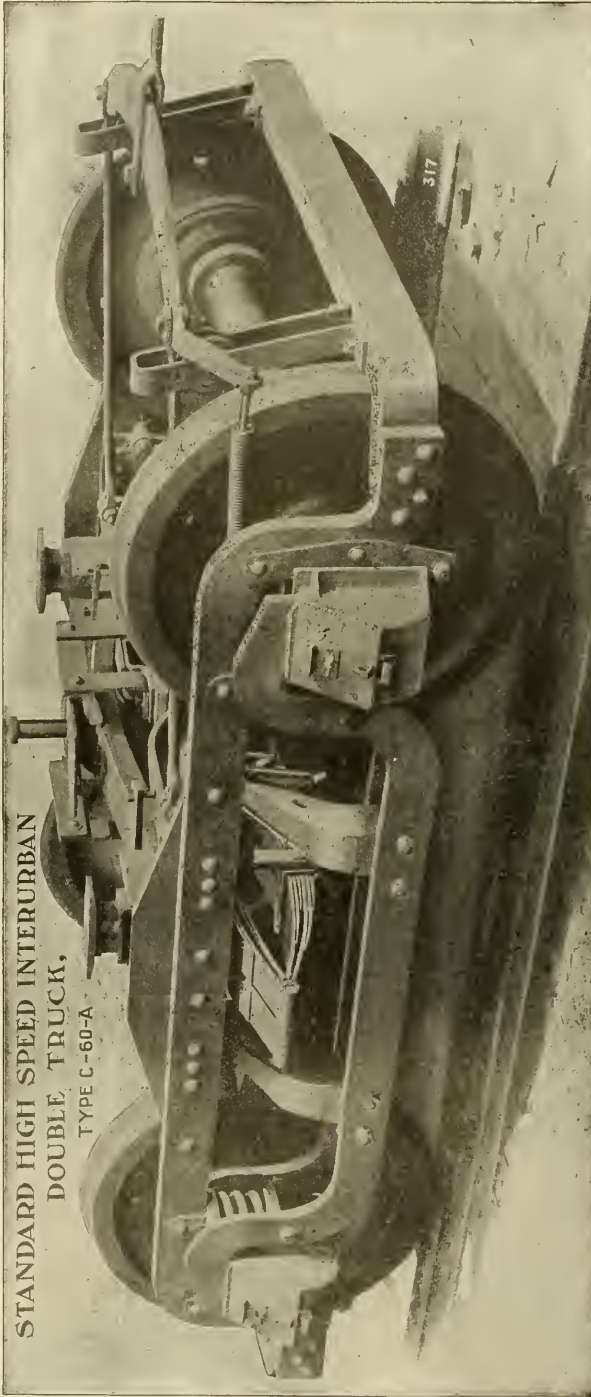

Our new plant is equipped with the most modern truck building machinery and the very best quality of material and workmanship is used in the manufacture of these trucks. M. C. B. standard principles are followed. Frames are made from rolled open hearth steel without welds. We are prepared to build trucks in accordance with purchaser's designs and specifications.

**Standard Motor Truck Company, Frick Bldg., Pittsburg, Pa.**  
 New York Office: 170 Broadway  
 Works: New Castle, Pa.  
 Chicago Office: Fisher Bldg.

# U.S. Metal & Mfg. Co.

25 Broad Street, New York

Pittsburg, 1509 Arrott Bldg. Chicago, 414 Railway Exchange

## Columbia Lock Nuts

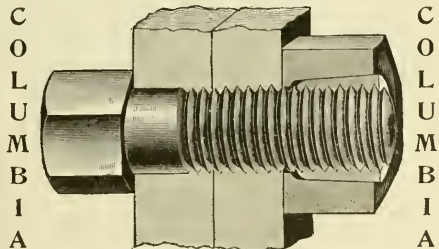

Columbia Lock Nut on Bolt

It is effective and indispensable on locomotives, pitmans, wrists, king bolts, rail joints, fish plates, piston rods, cylinder heads, steam pumps, and, in fact, all kinds of machinery. It is also invaluable on railroad cars, carriages, wagons, automobiles, axles, steam pipes, flanges, etc.

SEND FOR CATALOG AND PRICE LIST

→ 93.3% ←

# REDUCTION

in the drop over a contact carrying 1,000 amperes was the result of a recent test made in a power house of the Commonwealth Edison Company of Chicago, by the use of the

## HAROLD BROWN ALLOYS.

Contacts amalgamated with these Alloys over ten years ago by the Metropolitan West Side Elevated Ry. Co. of Chicago are *still as bright as when first applied.*

In October, 1897, the South Side Elevated R. R. Co. of Chicago amalgamated the terminals of the bonds used on the third rail and recent investigation showed the contacts to be *perfectly free from oxide and as good as when first installed.*

It is of these Alloys that the

# Plastic Rail Bond

is made.

*The bond that will transmit 3,000 amperes without the slightest injury and show but 5 per cent depreciation after eleven years' severe service.*

Consider these FACTS, or, better still,

**TRY IT.**

**HAROLD P. BROWN,** 120 Liberty Street, NEW YORK.



York Street Bridge, Toronto, Canada  
Electric Railway Bridge over Steam Railroads

# Carbonizing Coating

preserves metal where all other paints fail.

**Durability and Economy Guaranteed.**

Manufactured exclusively by

## The Goheen Manufacturing Co.

Canton, Ohio, U. S. A.

Dock House, Billiter Street, London, E. C., England

THE MAIN FEATURE of this coupler is its great strength and simplicity. In fact, it makes a coupling joint that is as strong as, if not stronger than, the cars themselves. It will be noted that the head has heavy coupling faces, and, with the great width of the link and heavy reinforcing ribs on the outside of the head, lateral breakage due to curvature strains is impossible. The heavy lock and its bearing both at the top and bottom gives the strongest kind of a locking device.

Ask for new catalogue of traction devices.

**Washburn Steel Castings & Coupler Co.**  
MINNEAPOLIS, MINN.



# Washburn "K" Type Traction Coupler

Western Agents:  
TWEEDY, HOOD & FINLEN, 204 Fisher Bldg., Chicago  
Canadian Agent: JOHN TAYLOR, Montreal

# Making Impressions That Lead To Sales

**V**ERY few of your customers, actual or prospective, will probably ever see you or your plant. They will never have that intimate personal knowledge that will enable them to judge you and your product at your actual worth to them.

There are, however, a great many things they will see and hear that will influence them for or against you and your goods. You need not fear the possible "knocks" of envious competitors, because the motive is so apparent that they fall of their own weight.

But it is imperative that what you say and do be said and done in a manner calculated to impress the customer with the idea that doing business with your house will be more advantageous to him in one way or another or in many ways than patronizing one of your competitors. (Now, that's a pretty long sentence, so read it again and let it sink in).

The effort you make to sell your goods is what the customer sees and hears most of; hence this effort is what requires a careful attention it oftentimes does not get. The way your salesmen talk and act, the way your correspondence is carried on, the manner in which your printed advertising matter is prepared and handled—all these are of prime importance, but perhaps most important of all is your *advertising*.

In advertising you have the opportunity, if you will seize it, of making *any kind of an impression you desire*. Your plant may be small, yet you can so advertise as to give customers an impression of capacity equal to that of your big competitors. Don't misunderstand—it is not the idea that you should deceive or misrepresent, but you can advertise in a manner that will impress the customer with the idea that you are capable of handling his order as satisfactorily as your biggest competitor, whom he probably knows far better than he knows you. No harm is done by impressive advertising of this sort, provided you deliver the goods.

Your advertising can be made to impress the possible buyer with the idea of *quality*. You can make him believe, if you go about it in the right way, that your goods really are better than those of your competitors—but don't try this unless you can prove your claims.

In fact, your advertising can be made to make many impressions and to do many things that will help sell your goods just as surely as you are reading these lines. And advertising (*real*, of course) will accomplish these results at far less cost than any other method.

*If you are sufficiently interested to drop us a line, we are enough interested to have a representative confer with you.*

---

## **Electric Railway Review**

160 Harrison Street, CHICAGO, U. S. A.

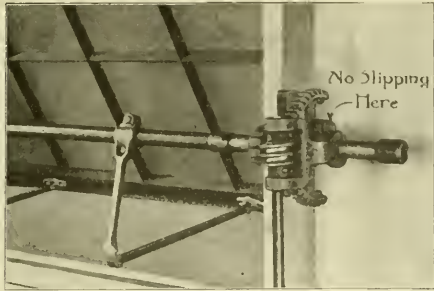

## The Ventilation

of your Shops, Foundries and Car-Barns is made especially effective by a speedy, positive and easily manipulated

## Sash Operating Apparatus

which automatically locks the sash at any position. *Let us send you our catalogue*

**LORD & BURNHAM COMPANY**

Irvington-on-Hudson, N. Y.

# Hydraulic Pumps



WE have just received from the printers Catalogue No. 71, describing Hydraulic Pumps, which we are building. This replaces our former Catalogue No. 56, and shows about 75 varieties of pumps for obtaining pressures from 300 lbs. to 10,000 lbs. to the square inch. Operated by hand, belt, steam or electric power. It is a book of about 140 pages. Do you want a copy?

**THE WATSON-STILLMAN CO.**

26 Cortlandt Street, New York City  
Branch Office, 453 The Rookery, Chicago, Ill.

## “Not an Experiment”

The Providence Fender has been in successful operation on hundreds of roads for 13 years, and has proved itself reliable under all conditions of Street Railway service.

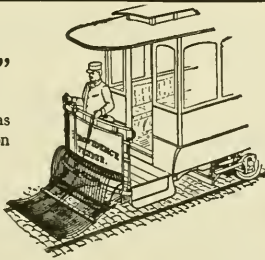

**CONSOLIDATED CAR FENDER COMPANY**

Office and Factory: PROVIDENCE, R. I.  
Branch Office: 110 E. Twenty-third St., New York  
European Agents: Comptoir d'Electricite, 6, Rue Boudreau, Paris, France

# NOW

is the time to save money

We enable you to do this by repairing your broken steel motor cases at small expense

**W**E ARE prepared to undertake the repair of broken steel motor cases at our Jersey City Works. We are equipped with exceptional facilities for doing this work quickly, efficiently and economically. Furthermore, all work of this nature done at these shops will be guaranteed in every particular; in fact, we will REFUND THE ENTIRE VALUE OF THE MOTOR CASE in any instance where it is shown that under regular service conditions and within a period of one year from the time of making the repair, our weld did not hold and that the motor case broke again in the same place as the original fracture.

### Can we do more?

Write for full details, shipping instructions and prices NOW, as this offer holds for only three months from date.

Pamphlet No. 36-Q gives full information.

**GOLDSCHMIDT THERMIT CO.**

90 West Street, New York  
432-436 Folsom Street, San Francisco

# Galena-Signal Oil Company

FRANKLIN, PA.

THEIR SPECIALTIES

**STREET RAILWAY LUBRICATION** including both rolling stock and power house equipment.

Same skillful *expert supervision* given in this service as in steam railway service has produced very satisfactory results. The business of our Street Railway Department has increased beyond every expectation. In 1906 this department sold ten times the number of barrels of oil sold by the same department in 1903.

We are under contract with many of the largest street and interurban railways of the country.

We guarantee cost per thousand miles in street railway service when conditions warrant it.

Write to Franklin, Pennsylvania, for further particulars.

**STEAM RAILWAY LUBRICATION** Sole manufacturers of the celebrated *Galena Coach, Engine and Car Oils* for steam railway lubrication.

*Sibley's Perfection Valve Oil* for cylinder lubrication, and *Perfection Signal Oil* for use in railway signal lanterns.

**GALENA RAILWAY SAFETY OIL** Made especially for use in headlights, cab, classification and tail lights, and for switch and semaphore lamps. Burns equally well with the long time as with the one-day burner; with or without chimney as the burner requires. Is pure water white in color; high fire test, low cold test, and splendid gravity.

**CHAS. MILLER, President**

CAR ADVERTISING

# Barron & Collier

ALMOST EVERYWHERE

Flat Iron Building, New York.

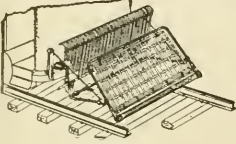

## ECLIPSE Life Guard

Manufactured by the  
ECLIPSE RAILWAY SUPPLY CO.  
Cleveland, Ohio



## Eventually Atlas Anchors

Why not now?

THE ATLAS ANCHOR CO., Cleveland, Ohio



NULLI IN OBSTACULO

# J. STOKES & SONS

THE UNDER-  
FIELD  
STOKES CO.  
OF AMERICA  
MARQUETTE BLDG.  
CHICAGO.



WE NOW MAKE 75% OF THE TROLLEY WHEELS.  
WE WANT TO MAKE THE OTHER 25%.

THE STAR BRASS WORKS  
KALAMAZOO, MICH.



## BALDWIN LOCOMOTIVE WORKS

BURNHAM, WILLIAMS & CO., PHILADELPHIA, PA., U. S. A.

Builders of LOCOMOTIVES OF EVERY DESCRIPTION  
Including ELECTRIC LOCOMOTIVES and

# ELECTRIC TRUCKS



Truck built for Indianapolis, New Castle & Toledo Electric Railway Company.

## STANDARD STEEL WORKS,

HARRISON BUILDING PHILADELPHIA, PA.

SOLID FORGED ROLLED AND STEEL TIERED WHEELS  
mounted on axles and fitted with Motor Gears for Electric Railway Service

ELLIPTIC AND COIL SPRINGS

# PIPE FITTINGS AND VALVES

FOR THE HEATING AND PLUMBING TRADE

TRADE  MARK

## JOHN SIMMONS CO.

104-110 Centre Street, NEW YORK

## THE LORAIN STEEL COMPANY

Girder Rails and High Tee Rails  
High-Grade Special Track Work

GENERAL OFFICES  
THE PENNSYLVANIA BUILDING, PHILADELPHIA, PA.



# CLASSIFIED ADVERTISEMENTS

Undisplayed advertisements are inserted under this heading at the uniform rate of one cent a word; minimum charge twenty-five cents. Replies directed to this office will be forwarded when required to any address in the United States, Canada or Mexico without extra charge. Advertisements received at the Chicago office by 9 a. m. Thursday will appear in the issue for the same week.

## POSITIONS WANTED.

A young man, 27 years of age, with ten years' experience, wants position as engineer or electrician; unmarried; habits strictly temperate; high-class references. Address "No. 710," care Electric Railway Review, Chicago.

Position wanted by a young man (23) of good habits; have been connected four years with the operating and purchasing departments of an electric street railway company; can give good references. Address "No. 528," care of Electric Railway Review, Chicago.

Position as chief electrician or superintendent 16 years' experience lighting, power and traction work, alternating and direct current; graduate of well-known school; excellent testimonials; disengaged. Address "No. 529," Electric Railway Review, Chicago.

Auditor, experienced in electric railway and lighting and construction accounting, wants position with fair-sized company. Energetic and good systematizer. Best references. Address "No. 527," care of Electric Railway Review, Chicago.

Position by a single man, 29 years old, practical electrician and machinist, 10 years' experience, familiar with electric car and locomotive repairs, power and substation practices. Non-union man. Address "No. 630," care of Electric Railway Review, New York, N. Y.

Position of chief motorman or instructor by a first-class competent man who has had 12 years' experience in that line. Thoroughly understands economy in regard to use of power and care of rolling stock; familiar with quadruple equipments and air brakes; highest references. Address "Chief Motorman," care of Electric Railway Review, Chicago.

## POSITIONS WANTED.

Graduate civil engineer, Cornell University 1902, experienced in field work and trade journalism, now engaged, desires work with technical journal or publicity department of manufacturing establishment. Address "No. 525," care of Electric Railway Review, Chicago.

Experienced and efficient engineer with power station experience (both planning and construction, as chief engineer and as superintendent of construction) desires position with operating company as engineer, assistant to manager or superintendent. Address "No. 515," care the Electric Railway Review, Chicago.

Young man, 30 years of age, who has nearly completed a course of "Electric Lighting and Railway" in the International Correspondence Schools, desires position which will give him practical experience in power house and switchboard work. Willing to start at a nominal salary. Address "No. 526," care of Electric Railway Review, Chicago.

Position wanted by unmarried man (23) with a city or suburban electric railway or with electric light and power company. Would prefer position in engineering, erection or operating department. Technical electrical graduate. Two years' experience with firm of contracting engineers in drafting room, shop work and erection work. Familiar with the design and erection of complete steam and electric plants. Am at present employed as erecting engineer by a small concern, but wish to make a change. Permanent position and good chances for advancement are of more importance than the question of salary. Best references furnished as to character and ability. Location anywhere. Address "No. 531," care of Electric Railway Review, Chicago.

## POSITIONS WANTED.

Position wanted by first-class engineer and machinist with 15 years' practical experience with compound Corliss engines, Allis-Chalmers and Westinghouse steam turbines surface condensers, A. C. and D. C. electrical apparatus. Age 35. A1 references. Address "No. 532," care of Electric Railway Review, Chicago.

## POSITIONS OPEN.

Salesmen with technical knowledge, machinery and electrical installation, also auditors and accountants. Salaries \$1,200 to \$6,000. Ambitious men write us. L'APGOODS, 305 Broadway, New York, or 1010 Hartford Bldg., Chicago.

## MISCELLANEOUS WANTS.

You can sell second-hand cars, machinery and material through advertising on this page. Ask about the special rates. Electric Railway Review, 160 Harrison Street, Chicago.

## BOOKS AND PUBLICATIONS.

If interested in any phase of steam transportation, you will find every development covered fully and accurately in The Railway Age. It is the leader and acknowledged authority in this field. Ask for free sample copies. The Railway Age, 160 Harrison Street, Chicago.

A copy of "The Motorman and His Duties," the standard handbook on the theory and practice of electric car operation, is worth many times its cost to every man interested in the subject. Send for 16-page pamphlet of sample pages. The Wilson Company, 160 Harrison Street, Chicago.

## BUSINESS OPPORTUNITIES.

WANTED—RAILWAY SPECIALTIES. WE HAVE OUR OWN MANUFACTURING AND SELLING ORGANIZATIONS, WITH FACILITIES FOR SELLING THE RAILWAY TRADE. WE DESIRE TO SECURE FOR MANUFACTURE AND SALE SOME GOOD RAILWAY SPECIALTIES. ADDRESS "H. M." CARE OF ELECTRIC RAILWAY REVIEW, CHICAGO.

## BOOKS AND PUBLICATIONS.

Wanted—Copy of the Electric Railway Review of January 12, 1907, in good condition. State price in your answer. Address "No. 536," care of Electric Railway Review, Chicago.

We want your friends to read the Electric Railway Review. You will do them—and us—a favor by sending their addresses. We will gladly mail free sample copies. Electric Railway Review, 160 Harrison Street, Chicago.

National Legislation on Interstate Commerce to July 1, 1906, is fully covered in our reference pamphlet. It contains the full text of the act to regulate commerce as amended, including the Elkins and Hepburn acts, and of the supplementary act relating to the testimony of witnesses before the interstate commerce commission. It also contains the texts of the expedition act, the anti-trust act of 1890, the employers' liability act and the safety equipment laws. Difference in type shows the parts expunged from, and the parts added to, the interstate commerce and Elkins acts by the Hepburn act. This pamphlet is of special value to railway men and lawyers. Mailed prepaid for 25 cents in stamps or coin. Special prices for quantities. The Wilson Company, 160 Harrison St., Chicago.

**The Man** —who wants a job— **The Job** —that wants a man—

can get together through the medium of a want ad in the

# Electric Railway Review

The cost is small—only one cent a word per insertion, with a minimum charge of 25 cents. Replies may come in our care, if you like, to be forwarded without charge.

Read the advertisements on this page. If you don't see what you want, ask for it!





Our Engineers Can Help You  
ASK US  
**GENERAL STORAGE BATTERY CO.**  
Works, Boonton, N. J. Offices, 42 Broadway, N. Y.



**R.W. MARSHALL & CO.**  
95 and 97 Liberty St., NEW YORK  
Second-Hand Machinery and Equipment  
**ELECTRIC RAILWAY MATERIALS**



The Fred. J. Meyers Mfg. Co. Hamilton, O.  
Largest Manufacturers in the World of TICKET and CONDUCTORS' PUNCHES  
Send for catalog of 75 different styles of punches with 1000 different dies.  
Write for special prices.

**RAILS**  
*Locomotives Cars Etc.*  
Bought & Sold  
Walter A. ZELWICKER Supply Co.  
ST. LOUIS

**FOR SALE CHEAP!**  
One 14x22 eight-wheel locomotive  
Ten 34-foot 50,000 capacity flat cars  
Two Greenleaf turntables  
70 box cars, 40 and 50,000 capacity  
80 Good Second-hand Bridges  
Specifications and Blue Prints on application  
**F. A. JOHANN**  
1624 Pierce Bldg., St. Louis, Mo.

**VOLTALAC**  
TRADE MARK  
**FOR INSULATING ARMATURE AND FIELD COILS**  
Almost Every Big Electric Railway in the U. S. and Europe uses it  
**STANDARD VARNISH WORKS**  
LONDON NEW YORK CHICAGO

**ROSSITER, MACGOVERN & CO. (Inc.)**  
90 West Street, New York  
**ENGINES** Boilers, Locomotives, Cars,  
**GENERATORS** 2nd Hand  
Transformers, Railway, A. C. & D. C. **MOTORS**

<b>P &amp; B INSULATING VARNISHES</b>	Possess the highest insulative efficiency.
Send for Literature and prices.	Meet every requirement in electrical work.
<b>P &amp; B ELECTRICAL COMPOUNDS</b>	
<b>THE STANDARD PAINT COMPANY,</b> 100 WILLIAM ST., NEW YORK.	<b>P &amp; B INSULATING TAPE</b>
BRANCHES: CHICAGO, ST. LOUIS, KANSAS CITY, PHILADELPHIA, BOSTON, NEW ORLEANS.	

The Recording Fare Register Company  
New Haven, Conn.  

THE **Bellamy Vestlette**  
For Street Railway Conductors  
**ABSOLUTELY SAFE. Money cannot be lost or stolen from these pockets OVER 150,000 IN USE**  
Saves the price of a coat yearly. Conductor's uniform always presentable. Adopted as a part of the uniform by over 300 Street Railway Companies. Price \$2.00, sent to any address prepaid, where we have no agent. Agents wanted on every line.  
**The Bellamy Vestlette Mfg. Co., Cleveland, O.**  
and A. F. JURY, 265 Yonge St., Toronto, Canada  
Patented April 27, 1897  

**\$2** pays for 52 weekly issues and 6 daily issues of the  
**Electric Railway Review**  
Costs less than some and more than others but worth more than all  
Send us the names of your friends for sample copies, please.  
**Electric Railway Review**  
160 Harrison Street Chicago

  
Factory of The Milloy Electric Company  
Bucyrus, Ohio  
**The Milloy Trolley Base**  
built in our new and specially equipped factory, insures a quality which will give excellent service under ordinary and extraordinary conditions.  
The Milloy Base is unusually low, has even tension on high or low wire. Has no fulcrum, no friction, no oil, no center post. Always efficient. Particulars on request.  
**THE MILLOY ELECTRIC COMPANY**  
Bucyrus, Ohio

# The Lindsley Brothers Company

Producers and Shippers of and Manufacturers of

## WESTERN CEDAR POLES RED FIR CROSS ARMS

Eastern Sales Office, Monadnock Bldg., CHICAGO SPOKANE, WASHINGTON

**G. H. BARNES HARDWOOD LUMBER CO.**  
Office and Yard: Main and Warren Sts., ST. LOUIS, MO.  
Ties, Car Oak, Poplar, Ash, Cherry, Plain and Quartered Oak

**For Sale** Cards produce results in the  
Electric Railway Review

**C. H. WORCESTER CO.**

## CEDAR POLES

PRODUCERS AND WHOLESALERS

Suite 1710 Tribune Building CHICAGO

**CHESTNUT POLES**

Cedar, Oak and Chestnut Ties

FROM OUR OWN TIMBER LANDS

**THE ADVANCE LUMBER CO.**

CLEVELAND, OHIO

We have in our Chicago Yard available for RUSH SHIPMENTS a SELECTED STOCK of POLES and TIES

**NAUGLE POLE AND TIE CO.**

Chicago Office, 226 La Salle Street

## POLES and PILING

20,000 35s and 40s  
Ready to Ship at Once

S-E. Missouri Cypress Co., Campbell, Mo.

We are Producers and Wholesale Dealers in Western

## CEDAR POLES

Yards in Washington, Idaho, Montana  
and British Columbia

WRITE US FOR DELIVERED PRICES

**CHURCHILL CEDAR CO.,** Box 1409, Spokane, Wash.

# Idaho Cedar Poles

PACIFIC COAST POLE CO. SPOKANE, WASH.

THE RAILWAY SPECIALTY AND SUPPLY CO. **FROGS AND SWITCHES** Great Northern Building CHICAGO

**THE PETER SMITH HEATER CO.** The Pioneer Manufacturers of HOT WATER HEATERS for City and Interurban Cars.  
OFFICE AND WORKS: DETROIT, MICH.

**ELECTRIC BLUE PRINTING MACHINES** J. H. WAGENHORST & CO., Youngstown, Ohio  
Largest Manufacturers of Blue Printers in the World  
WRITE FOR CIRCULAR "I"

**FOSTER SUPERHEATERS**

PREVENT CONDENSATION IN LONG STEAM PIPES. POWER SPECIALTY COMPANY  
111 Broadway, New York

		
Over 25,000 miles in use	Rolled from Best Quality Steel	
<b>CONTINUOUS JOINT</b>	<b>WEBER JOINT</b>	<b>WOLHAUPTER JOINT</b>

Additional safety and economy in Track Maintenance has been proved by the use of Continuous, Weber and Wolhaupter base-supported rail joints—after ten (10) years' service, having a record of over 25,000 miles in use—the extent of which is evidence of their excellence.

**THE RAIL JOINT COMPANY**  
General Offices: 29 West 34th Street, New York City  
Makers of Rail Joints for Standard and Special Rail Sections, also Girders, Sleepers or Cross-ties, and Insulating Rail Joints, protected by patents in United States and Foreign Countries.

Catalogs at Agencies

Baltimore, Md.	Portland, Ore.
Boston, Mass.	Seattle, Wash.
Chicago, Ill.	St. Paul, Minn.
Denver, Colo.	St. Louis, Mo.
Pittsburg, Pa.	Troy, N. Y.
London, Eng.	Montreal, Can.

HIGHEST AWARDS—Paris, 1900; Buffalo, 1901; St. Louis, 1904

# Dearborn Water Purifying Reagents

Increase the efficiency and the years of service of steam boilers by keeping them in good condition internally. Gallon sample of the water required for analysis before preparing treatment.

## Dearborn Drug & Chemical Works

WM. H. EDGAR, FOUNDER

299 BROADWAY, NEW YORK POSTAL TELEGRAPH BLDG., CHICAGO

### A Cooper Heater

will heat eight cars satisfactorily for the same cost of operating one car with the electric heater. It pays for itself.

*Ask us to prove it*

The Cooper Heater Co., Dayton, Ohio

10

# ALUMINUM

## Railway Feeders

And all kinds of **Electrical Conductors**

Aluminum Feeders are less than one-half the weight of copper feeders and are of equal conductivity and strength. If insulated wire or cable is required, high grade insulation is guaranteed.

*Write for prices and full information.*

## Aluminum Company of America

PITTSBURGH, PA.

Formerly The Pittsburgh Reduction Company

Specify the Genuine Roller. It is that Element that makes a Car Curtain a Success.



Special Car Rollers are made. Brackets are made for all classes of fittings. Used all over the world wherever cars are run.

Every Genuine Roller has the Name of Manufacturer

## STEWART HARTSHORN

IN SCRIPT ON LABEL

### STEWART HARTSHORN CO.

Office and Factory, E. NEWARK, N. J.  
NEW YORK, 382 Lafayette St. CHICAGO, 338-344 Wabash Ave.

# MORDEN FROG AND CROSSING WORKS

MANUFACTURERS OF

618 The Rookery, Chicago

## Street Railway Special Track Work

Works: SOUTH CHICAGO and CHICAGO HEIGHTS

"UNION" Track Jacks, Switches, Frogs, Crossings, Rail Braces, Etc.

### FOUNDRIES

CHICAGO DETROIT  
DENVER ST. PAUL  
TACOMA BOSTON  
KANSAS CITY

GENERAL OFFICES  
WESTERN UNION BLDG.  
CHICAGO

# GRIFFIN WHEEL COMPANY

CHILLED IRON

## Car Wheels

OF EVERY DESCRIPTION  
FOR ALL CLASSES OF SERVICE  
IRON OR STEEL AXLES. REFITTING A SPECIALTY

**THE ARNOLD COMPANY**

ENGINEERS-CONSTRUCTORS  
ELECTRICAL - CIVIL - MECHANICAL  
101 LA SALLE STREET  
CHICAGO

**H. M. Bylesby & Company**

Incorporated

ENGINEERS

American Trust Bldg., Chicago

Design, Construct and Operate  
Railway, Light, Power and  
Hydraulic Plants

EXAMINATIONS AND  
REPORTS

**J. G. WHITE & COMPANY**  
INCORPORATED

Engineers, Contractors

43-49 Exchange Place,  
41-43 Wall Street

New York, N. Y.

Principal Philippine Office: Manila, P. I.

**The Roberts & Abbott Co.**

E. P. ROBERTS

ENGINEERS

W. H. ABBOTT

Electric Railways, Light and Power

Complete Industrial Plants

Water Power Development

CLEVELAND

CHICAGO

PHILADELPHIA

BALTIMORE

**Surface, Jet and Barometric Condensers**

**Edwards Air Pumps**    **Centrifugal Pumps**

**Water Cooling Towers**

Wheeler Condenser & Engineering Company

West and Cedar Streets, New York

Works, CARTERET, N. J.

Monadnock Block, CHICAGO, ILL.

**Complete Plants for the Rapid  
Handling of Material**

Every Sort of Hoisting Apparatus

BROWN HOISTING MACHINERY CO.    Cleveland, Ohio

**STONE & WEBSTER ENGINEERING  
CORPORATION****CONSTRUCTING ENGINEERS**

147 MILK STREET, BOSTON

ELECTRIC RAILWAY, LIGHT & POWER PLANTS

WATER POWER DEVELOPMENTS

**A. L. REGISTER & CO.**

Engineers and General Contractors—Electric Railways

112 North Broad St.

PHILADELPHIA, PA.

Established 1889

**CENTRAL INSPECTION BUREAU**

Inspection of Rails, Ties, Cars, Motors, Bridges, Buildings, Etc.

17 STATE STREET

NEW YORK CITY

**LINE MATERIAL**

ELECTRIC SUPPLIES FOR RAILWAYS, POWER PLANTS, ETC.

THE CREGHEAD ENGINEERING CO., 346 Main Street, Cincinnati, Ohio

WRITE  
TO

**MODEL STOKER COMPANY** DAYTON  
OHIO

for detailed information about the best

**AUTOMATIC SMOKELESS FURNACE**

SPRINGS—TIRES—STEEL-TIRED WHEELS

**RAILWAY STEEL-SPRING CO.**

General Offices: 71 Broadway, New York

**WHEEL TRUING BRAKE SHOES**

Repair Crippled Wheels While Running

THE WHEEL TRUING BRAKE SHOE CO., Detroit, Mich.

**Gongs** For Street Cars **Bells**

G. C. REITER, Canton, Ohio

**THE CURTAIN SUPPLY CO.**

CAR CURTAINS

CHICAGO, 85-93 Ohio Street

1819 Park Row Bldg., NEW YORK

**BRAKESHOES**

STANDARD  
BRAKESHOE COMPANY  
GEN'L OFFICES & WORKS - AURORA, ILL. CHICAGO OFFICE - 315 IVY EXCH.

**TRACKLAYING BY MACHINERY**

SIMPLE, RAPID AND ECONOMICAL

D. F. HOLMAN RAILWAY TRACKLAYER CO., 1102 Ellsworth Bldg., Chicago

**ELECTRIC HEATERS** For All Classes  
of Cars

New York Consolidated Car-Heating Co. Chicago

**SHIMER & CHASE CO.**

Experienced Promoters of Electrical Railway Projects

Correspondence Solicited

OMAHA, NEB.

**GEARS AND PINIONS**

FOR ALL TYPES OF MOTORS

THE VAN DORN & DUTTON CO., CLEVELAND, OHIO

**RE-ENFORCED SPOKE WHEELS**

For City and Suburban Cars

ST. LOUIS CAR WHEEL CO., St. Louis, Mo.

**HART** CONVERTIBLE **CAR**

RODGER BALLAST CAR CO., Railway Exchange, CHICAGO

**HEINE SAFETY BOILER CO.**

421 OLIVE STREET, ST. LOUIS, MO.

Manufacturers of WATER TUBE BOILERS

# FOR SALE. FOR QUICK DELIVERY

## 6 55-ft. Passenger, Baggage and Smoking Car Bodies

Main Compartment 26' 0"  
 Smoking " 10' 6"  
 Baggage " 10' 0"  
 Seating Capacity, 54

## 8 60-ft. Passenger, Baggage and Smoking Car Bodies

Main Compartment 28' 6"  
 Smoking " 11' 0"  
 Baggage " 8' 0"  
 Seating Capacity, 58

## 5 52-ft. Passenger and Smoking Car Bodies -- Double End

Seating Capacity, 60

## 3 52-ft. Passenger and Baggage Car Bodies -- Double End

Seating Capacity, 56

## 2 50-ft. Express Car Bodies

*Write or wire us for further information.*

# The Jewett Car Co. Newark Ohio

**THE MIGHTY MIDGET**

## HOT WATER CAR HEATER

Adapted for Large Electric Cars and Long Distance Lines. Exclusively used on Largest Electric Systems. Ask for Catalog

**THE WILLIAM C. BAKER HEATING & SUPPLY CO., 143 LIBERTY STREET NEW YORK**



## NILES CARS

(The Electric Pullmans)

LARGE, FAST INTERURBANS  
 OUR SPECIALTY

## Niles Car & Mfg. Co.

Works: NILES, OHIO

Sales Office: J. A. HANNA CO.  
 312 Electric Bldg., Cleveland, Ohio

## CAR BODIES

Of All Types

## TRUCKS

To Suit

## CINCINNATI CAR COMPANY

CINCINNATI, OHIO

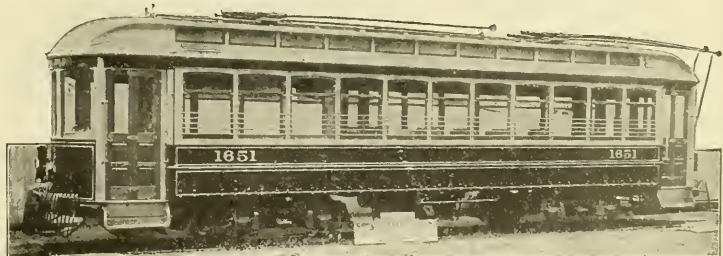

STANDARD SEMI-CONVERTIBLE—For Use All the Year

## How to Paint Canvas Car Roofs

Let us send you simple directions for waterproofing canvas. Economical and durable.

**Detroit Graphite Company**  
DETROIT, MICH.  
Dept. S.

## ROLLING DOORS

In Steel, Wood or Bronze

FOR CAR BARNs, FREIGHT SHEDS, ETC.

Made by the

**JAS. G. WILSON MFG. CO.**

New York Office: 3 W. 29th Street

ESTABLISHED 1876

Incorporated 1903

# Kinnear

STEEL  
Rolling Doors  
FOR CAR HOUSES



Operate Easily, Speedily, Satisfactorily  
and are very durable. Write for Catalog

**The Kinnear Manfg. Co.**

BOSTON 85 WATER ST. CHICAGO 112 CLARK ST. PHILADELPHIA 1011 CHESTNUT ST.  
COLUMBUS, OHIO

# Baltimore Center and Side Bearings

FOR ELECTRIC TRUCKS

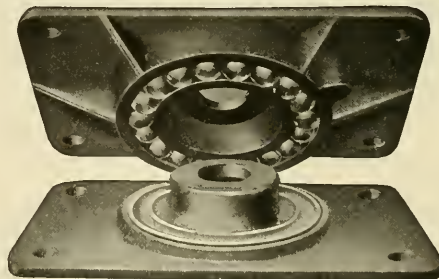

Impossible  
to Clog  
Balls

No  
Lubrication  
Necessary

**SAVES:** { FLANGE WEAR  
RAIL WEAR  
TRUCK REPAIRS

**DURABILITY:** { PROVEN  
UNDER  
HEAVIEST  
LOADS

BALTIMORE  
MD.

**THE T. H. SYMINGTON CO.**

CHICAGO  
ILL.

# Electric Railway Review

PUBLISHED EVERY SATURDAY BY THE WILSON COMPANY, CHICAGO

Entered as second-class matter January 5, 1907, at the postoffice at Chicago, Ill., under the act of March 3, 1879.

160 Harrison Street, Chicago  
150 Nassau Street, New York  
1529 Williamson Bldg., Cleveland

VOL. XIX  
No. 3

CHICAGO, JANUARY 18, 1908.

Whole No.  
247

Subscription: Domestic . . . \$2  
Foreign . . . \$5  
Canada . . . \$3.50

In a letter to the Electric Railway Review, which is published in this issue, Commissioner James S. Harlan of the Interstate Commerce Commission makes plain the attitude of that body with respect to electric railways. The Hepburn act makes no distinction between roads which rely upon electricity for their motive power and steam roads; and the commission has adopted this attitude in its informal correspondence concerning electric railways. Mr. Harlan gives further expression to the statement in the annual report of the commission, which has just been made to congress, that "according to the test of location of the physical property, not more than 20 per cent" of the electric urban and interurban lines comes within the jurisdiction of the commission. This statement is not clear, but Mr. Harlan explains that 20 per cent of the entire mileage is regarded as under the commission's jurisdiction. As this is a rough estimate, the figures are open to question. As the position of the commission will undoubtedly be that the Hepburn act applies in all its phases to electric railways engaged in interstate commerce, it is apparent that if the present designs of the commission are carried out the same strict supervision over accounting methods and rates that is exercised with steam railways will in time be extended also to electric railways. Mr. Harlan's communication is one of the foremost authoritative expressions which has been issued concerning the attitude of this most important of public commissions toward electric railways.

In accordance with a resolution passed at the Atlantic City convention of the American Street and Interurban Railway Association, the committee on organization has issued a call for a meeting to arrange for a fourth affiliated association to be devoted to the operating and traffic departments of street and interurban railway properties. This action is probably the most important step taken by the association since the reorganization of the Street Railway Association in 1905. As previously stated in these columns, the object is to bring together the managers, superintendents, traffic managers and advertising managers for the consideration of purely operating and traffic questions, and to turn over to the new association all of the general convention and committee work heretofore handled by the American association, which should go to such an affiliated association. This will relieve the presidents, general managers and other executive officials, who it is desirable should be most active in the work of the parent association, of the consideration of details with which they are not especially familiar, leaving them free to take up general questions relating to national, state and municipal legislation, and questions of broad general policy, such as public relations, municipal ownership and depreciation. The natural result will be that most of the convention work of the American association in the future will be done in executive session, while the consideration of details properly relating to the operating department will be placed in the hands of those whose daily experience is with those details. And it may be expected that the discussions

at future conventions on many operating subjects which have been too much neglected heretofore will be fuller and freer.

The Metropolitan West Side Elevated Railway Company of Chicago has just equipped for operation some new motor cars for elevated service. The wiring details of these cars are especially well carried out with a view to the prevention of electrical troubles and the localizing of any faults that might develop. One of the special features of the electrical equipment arrangement is that of utilizing the space under the seats for several of the controlling valves and governors. Each of these cars has in its floor construction a 1/8-inch steel plate completely covering the under side of the car. Above this plate is an insulating filler of asbestos wool and above this is the wooden floor. To provide for ready access the air compressor governor, motor cut-out, triple valve, feed valve and auxiliary storage battery charging switch are each one placed under a seat cushion. On the deck rail above these seats are lettered in gold initials which will show a motorman the proper location of each of these pieces of apparatus, thus relieving him from the necessity of removing the cushions of the various seats until he finds the particular switch for which he may be looking. There is another desirable feature in connection with utilizing the under-the-seat space for these valves and switches. It is that an electric heater may be confined within the same space under the seat and thereby serve in a large measure to prevent any possibility of the sluggish action of the device on account of cold weather affecting either oil or condensation that may be in the moving parts.

An unusual condition exists in Detroit which is unlike that in any other large city in the country and which makes the adoption of the T-rail for street railway use of more than ordinary importance. The soil is of an unstable character, which makes it impossible to construct at reasonable cost a rigid subgrade such as is necessary to the satisfactory employment of the grooved girder rail where the paving material is laid flush with the head of the rail. The soil, a blue clay of a plastic nature, will not hold even a carefully constructed concrete bed in place through several years of heavy traffic and alternate freezing and thawing, so that where the grooved girder rail is used the paving after short use usually requires frequent repairs because of the slight lateral motion of the rail, which it is impossible to correct. With a view to lessening this difficulty the Detroit United Railway Company has determined upon the adoption of the T-rail on one of its principal lines. The change in the type of rail promises to reduce the maintenance cost for the railway company and also to remove what has been considered a nuisance by the public, an unnecessary amount of noise from the cars. The grooved girder rail has always given an unusual amount of trouble by collecting and holding dirt, sweepings, snow and ice, which results in an

## Transportation Association to be Formed.

## Use of T-Rail in Detroit.

uneven rail surface, but which it is believed will not be present at all with the T-rail. The defect has been noted in many places where the girder rail is used, but so far little general attention has been attracted to it and the generally accepted and traditional advantages of the girder rail have many times weighed heavily against the more logical practice of using the T-rail.

---

The Indiana Union Traction Company and those of its officials and employes who have to do with the construction, maintenance and repair of rolling stock are to be congratulated. This company has in excellent working condition a purely interurban repair shop of the highest type. We offer our congratulations because we believe that no other interurban railway system has yet been favored with such complete repair facilities. The new shops are well located at Anderson, Ind., the junction point of several of the Indiana Union Traction Company's important lines. This location was also thought desirable because the shop buildings could be built within a stone's throw of the large central generating station for the Union Traction Company's power transmission network. We feel certain that the benefits from this centralization will be realized in both shop and power station costs; the shops will have available a most economical supply of heat and power; the generating station will have handy a fully equipped repair shop which can handle any and all of its emergency repair work. The general offices of the Indiana Union Traction Company are also in Anderson, so that it may safely be said that this town is the heart of the great interurban system which has been such a magnificent example and model for interurban construction the world over.

---

#### A RESULT FROM NON-STANDARD BUMPER HEIGHTS.

An appellate division of the supreme court of New York recently rendered a decision with regard to the height of car bumpers, which should be of particular interest to roads operating both local and interurban cars over the same tracks. The court was called upon to decide whether or not a railroad company was furnishing suitable cars when its equipments were so constructed that in case of collision the bumper of one car would not strike that of another and would break or demolish the vestibule of one of the cars.

The court held that it was a fair question for the jury whether the defendant was not negligent in furnishing its employes cars so constructed. The conclusion of the jury was that the railroad company was negligent in furnishing cars having such a variation in the height of bumpers and that such negligence had been the cause of the death of the motorman, on account of which the electric railroad had been sued for damages.

The accident occurred at a siding where a local car was supposed to await the passage of a large interurban car. The interurban car, however, arrived at the switch before the local car and stood partly covering the point of the switch, so that it obstructed the passage of the local car onto the sidetrack. The result was a head-on collision of the cars, causing the death of the motorman on the local car. The court did not hold the company liable for negligence in its servants placing the interurban car so that the local car would not clear it—this was the act of a fellow servant. But the question submitted to the jury tended to show negligence of the railroad company in the manner in which the bumpers of the two colliding cars were placed with reference to each other.

The bumper of the interurban car was built around the ends of the car sills and was constructed of oak timber, 6 by 8 inches in section, bound in heavy iron. The bumper of the local car was not so strongly built and did not stand so high

above the rails. In case the cars were pushed against each other the bumpers would not meet; but that of the interurban car, on account of its greater height, would lap over the bumper of the local car and strike against the vestibule. This was the existing condition at the time of the collision and the bumper of the interurban car passed entirely over that of the local car. It broke through and crushed the vestibule and the controller at which the motorman was stationed. The interurban car was not damaged.

A lesson in this regrettable case is that particular attention should, in the future, be given the standardizing of bumper and coupler heights, as well as to other parts of rolling stock equipments which must be renewed on account of wear.

---

#### DENIAL OF TRAFFIC ARRANGEMENT WITH STEAM ROADS.

The denial by the interstate commerce commission of the petition of the Chicago & Milwaukee Electric Railroad for through routes and joint rates with the Illinois Central Railroad and its subsidiary does not settle the question of the right of electric roads to secure joint arrangements with steam railways. The decision, however, is unfortunate because, unless the position of the commission shall be amended in this case or a more favorable position indicated in a decision affecting another electric road, the ruling will discourage electric railways in their efforts to make traffic arrangements with steam roads. An abstract of the decision of the commission was published in the issue of the Electric Railway Review for January 4, page 24.

It will be understood that the Chicago & Milwaukee Electric Railroad runs within a short distance of and parallel to the Chicago & Northwestern Railway and the Chicago Milwaukee & St. Paul Railway. The evidence makes it plain that these two steam railways influenced the Illinois Central road to withdraw traffic arrangements with the Chicago & Milwaukee Electric Railroad for the hauling of cabbages in carlots. The Chicago & Northwestern Railway, in intervening in the hearing before the commission, took the position that the territory was adequately served by the existing steam roads. Concerning the adequacy of the steam railway service there was marked disagreement in the evidence. Officials of the Chicago & Milwaukee Electric Railroad claimed that the service afforded by the steam railroads was not adequate; officials of both of the steam railways testified that they furnished all the facilities which were required. Outside of this evidence the only testimony which was given on this point appears to have been that of William J. Hansche and August J. Piper, large shippers of cabbages, who were introduced as witnesses by the Chicago & Milwaukee Electric road. These shippers complained of the steam railway service and charged that the roads did not provide the proper equipment when requested and did not route the cars as asked. Mr. Hansche, who testified more at length than Mr. Piper, said that if he desired to ship to points in Texas he was often compelled by the Chicago & Northwestern road to ship via Omaha instead of by way of Chicago. He also declared that when he had cabbages loaded, for instance, in Illinois Central refrigerator cars and wanted to ship them to Omaha, the Chicago & Northwestern line would not permit him to do so for the reason that Omaha is a competing point.

The decision of the interstate commerce commission appears to have been based largely on that clause of Section 15 of the Hepburn act which provides that the commission may establish through routes and joint rates, "provided no reasonable or satisfactory through route exists." The contention of counsel for the electric road was that this clause meant that the commission might establish such routes and rates, provided no reasonable or satisfactory through route exists for the carrier which files a complaint; but the



commission interprets this clause as assuming that the proviso applies to the existence of reasonable or satisfactory through routes so far as the neighborhood for which the through routes and rates are desired is concerned. If the neighborhood already had satisfactory through routes and rates, the commission, in accordance with its ruling, would afford no relief to an existing or a new carrier which desired to offer the same facilities as its competitors.

Application for a rehearing will be made by the Chicago & Milwaukee Electric road, and it is desirable that complete evidence be introduced on the subject of the adequacy of the service afforded by the two steam roads. The question of joint arrangements between an electric road and a steam railway where the issue of the adequacy of steam railway service cannot be raised, is before the commission on the petition of the Cedar Rapids & Iowa City Railway of Cedar Rapids, Ia., for through routes and joint rates with the Chicago & Northwestern Railway. This electric road extends through a territory which is not served by any steam railway.

---

### TWO-CENT STEAM RAILWAY FARES.

---

Elsewhere in this issue we publish letters from officials of a number of interurban electric railways concerning the effect of 2-cents-per-mile passenger fare laws upon their traffic. In states from which expressions of opinion and information on this subject were requested by us the reduced passenger fare laws imposed upon steam railways have gone into effect.

These letters show that in many instances reductions in steam railway fares have not caused perceptible declines in traffic and earnings of electric railways; but in numerous other cases the effect of cheaper rates and resultant changes in schedules on steam roads has been felt more or less sharply. One interurban road which parallels a steam railway charges 2 cents a mile for single-trip tickets, 1½ cents per mile for round-trip tickets and 1½ cents per mile for mileage books; but even with these rates this road feels the competition of the steam railway. That the existence of this competition is realized by the electric road is due to the fact that while the steam railway, prior to the adoption of 2-cent fares, did not stop its trains at points between the two terminals of the competing electric road, it now stops all trains at the intervening stations.

It seems assured that steam railways will not find it permanently profitable to make all the stops required to furnish a local service approaching the desirable service of competing electric railways. Many interurban roads withstood for years the severest competition which steam railways brought to bear. The construction of electric roads which offered fares of two cents per mile or less was frequently met at the outset by corresponding or lower rates by steam roads; still the electric railways secured and held the business because of advantages which the steam railways could not offer—frequency of service, freedom from smoke, dust and cinders, and accessibility of terminals. With these factors interurban electric railways have permanent claims upon public patronage.

Electric railways which have experienced losses on account of the narrower margin between their rates and those of competing steam lines may find that litigation started by the steam railways will result in decisions by the courts that 2-cent fare laws are unconstitutional. While the question is being tested in the courts electric roads which parallel steam roads should lay more stress than ever before on the possession of advantages which it is impossible for the steam roads to afford.

It seems inevitable that the obliteration of the margin between the fares of the two classes of roads will work some hardship. If electric railways lose in density of traffic, the natural result will be curtailment of service. The proper tendency of fares should be upward rather than to a lower

level and it will be unfortunate if electric railways, already offering reduced rates, should experience now a decline in density of passenger traffic.

---

### MEETING CALLED TO FORM TRANSPORTATION ASSOCIATION.

---

The committee on organization of the American Street and Interurban Railway Association, acting in accordance with a resolution passed at the Atlantic City convention, on January 14 issued a circular letter to general managers announcing a meeting of representatives of member companies to be held in New York on January 30, to organize a fourth affiliated association, for the operating and transportation departments. The letter reads as follows:

At the Friday (October 18, 1907) session of the Atlantic City convention, the American Street and Interurban Railway Association unanimously adopted the following resolution:

"Whereas, Experience has demonstrated the desirability and usefulness of our existing affiliated organizations, and

"Whereas, It has appeared from discussion that another organization of similar character should be created, to which should be committed lines of work pertaining to transportation, traffic and general operation. Now, therefore, be it

"Resolved, That the executive committee be and hereby is requested to take such steps as it may deem desirable to encourage the formation of such an organization."

The executive committee of the American Association at its meeting held in the city of New York, Saturday, October 19, 1907, voted to proceed with the organization of a fourth affiliated association in accordance with the above resolution, and the undersigned committee on organization was appointed.

The committee has given careful consideration to this entire matter and is of the opinion that the new association should bring together general managers, managers, passenger agents, advertising managers, superintendents and other operating officials, for the consideration of problems of interest to those engaged in the actual operation of street and interurban railway properties. The exact name of the new association will be determined at the organization meeting.

The annual meeting of the executive committee of the American association will be held on Friday, January 31, and it is the desire of the undersigned to have the organization of the new association completed, so that the action thus taken may be ratified at that meeting; including the adoption of the constitution and by-laws, the election of officers, the appointment of committees, and the general outline of the program for the 1908 convention.

We, therefore, give notice that a meeting for the purpose of organizing a fourth association to be affiliated with the American Street and Interurban Railway Association will be held at the office of the association, 29 West Thirty-ninth street, Engineering Societies building, New York City, on Thursday, January 30, 1908, at 10 o'clock in the forenoon. You are respectfully urged to have one or more representatives of your company present at this meeting, fully authorized to participate in the organization of such a fourth affiliated association.

This is a very important meeting and a full attendance of representatives of member companies of the American association is earnestly requested.

CALVIN G. GOODRICH (Chairman).  
W. CARYL ELY,  
JAMES F. SHAW,  
Committee on Organization.

Secretary Swenson's office has just issued the annual report of the Engineering association meetings held at Atlantic City on October 14, 15 and 16, 1907. This issue of the American Street and Interurban Railway Engineering Association annual exceeds its predecessors in the value of its contents and in the manner in which the vast amount of valuable matter has been compiled in book form. An excellent portrait of President H. H. Adams, superintendent of shops United Railways & Electric Company, Baltimore, Md., appears as the frontispiece. Included in the reports of the "Standardization" committee are double-page inserts on firm paper bearing the accepted standards for electric railway equipment. A useful addition to this year's Engineering association annual is a summary index of previous reports detailing the references to important events and papers of earlier conventions.

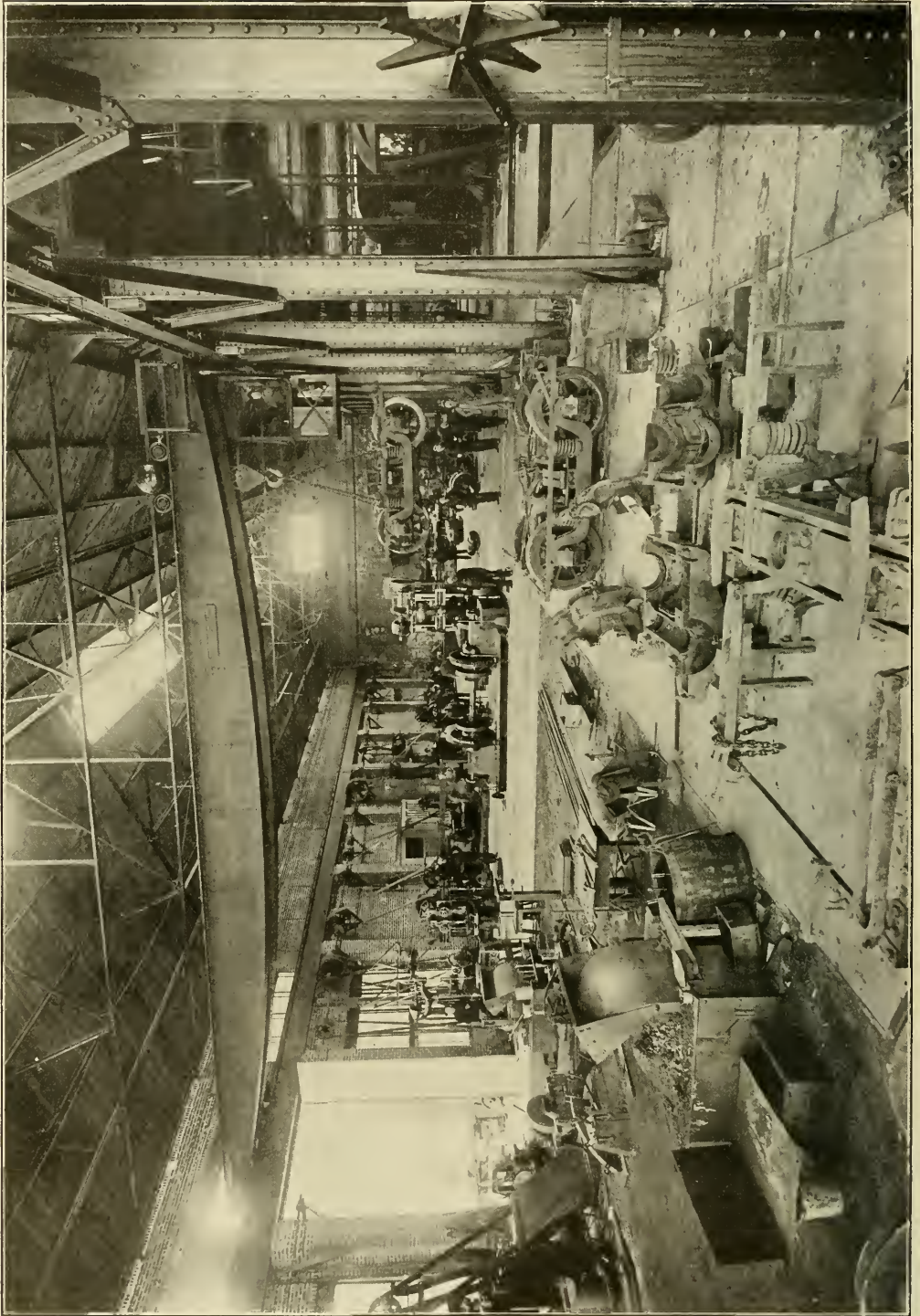

Anderson Shops Indiana Union Traction Company—Blacksmith, Machine and Armature Shops, Looking West.

**ANDERSON SHOPS OF THE INDIANA UNION TRACTION COMPANY.**

BY E. C. TAYLOR, SUPERINTENDENT OF MOTIVE POWER.

In a former issue of the Electric Railway Review plans were shown of the new shops of the Indiana Union Traction Company. These shops have just been completed and it is

system and as the company owned the property adjacent to the power house it was decided to locate the shops at this point.

The site selected was of triangular shape, of ample size for the shops, storage yards and tracks necessary to serve the shop requirements, with ample provisions for future extensions. It will be observed from the accompanying plan that the general outline includes a building practically under



Anderson Shops Indiana Union Traction Company—North and West Elevation.

now possible to present some interesting features of their construction.

The lines of the Indiana Union Traction Company comprise a group of divisions in Indiana:

- Indianapolis via Marion to Wabash, Ind.
- Indianapolis via Anderson to Muncie, Ind.
- Indianapolis via Kokomo to Peru, Ind.
- Indianapolis via Peru to Ft. Wayne, Ind.
- Muncie via Hartford City to Bluffton, Ind.

one roof, but subdivided into various departments so as to form a series of adjoining buildings designed for various purposes. The buildings cover an area of 76,920 square feet.

**Track Arrangement.**

It will be noted on the plan that the track arrangement provides a combination of stub and through tracks in the various departments of the shop, each shop department being



Anderson Shops Indiana Union Traction Company—South End, Exterior.

Muncie via Winchester to Union City, Ind.  
Anderson to Middletown.  
Connecting lines from Alexandria via Elwood to Tipton, Ind.

This company also operates the city lines of Anderson, Muncie, Marion, Elwood, Alexandria and Indianapolis to Broad Ripple. This group of divisions includes a system of 314 miles of interurban track and 47 miles of city track, making a total mileage of 361. The total number of cars owned is 351.

The main power house of the company is located at North Anderson. This is very nearly the geographical center of the

provided with one or more through tracks. At the north end of the shop is a ladder track with necessary switches for the 18 tracks entering the building. Thirteen of the tracks are stub tracks and five are through tracks. On the west side of the building is the main line double track of the Anderson and Wabash division. The north end ladder track is connected to this by two curves and a crossover, making it possible for a car to enter or leave the yard on either track headed in either direction.

The north end ladder track being located 102 feet from the building allows the longest interurban cars to be entirely

squared around, entering the buildings parallel with the track. The north end ladder track at the east end curves into a ladder track. Running diagonally along the east side of the property into this diagonal ladder track are the switches connecting all the through tracks in the shops and also the switches for the storage tracks in the yard. Continuing, this diagonal track joins the southbound track of the Anderson and Wabash division at a point 400 feet south of the south end of the building. This arrangement of tracks permits a car to enter or leave the yards either at the north or south end of the buildings and has proved very flexible and convenient. The special track work was furnished by the Buda Foundry & Manufacturing Company.

**Car Repair Shop.**

The car repair shop occupies a section of a room 140 feet 6 inches by 192 feet 6 inches. In this room are located the car repair shop, armature room, machine shop and blacksmith shop.

The car repair section is 60 feet by 192 feet 6 inches and has 12 tracks, the tracks in this section extending through the car repair shop, the "truck aisle" and into the machine shop. Each track in the car repair shop has a pit 67 feet long, 3 feet 11 inches wide and 4 feet 6 inches deep, provision being made for drainage at one end. The walls and floors of the pits are of concrete. The walls are 18 inches at the bottom and 12 inches at the top and reinforced by 3/4-inch rods. The walls are capped by 10 by 12 inch pine stringers, held by anchor bolts embedded in the concrete. To these stringers are attached 60-pound rails. The pits on one side are recessed at intervals of 6 feet 8 inches for pit lights; on the opposite wall 4 by 4 inch oak strips 10 feet apart are embedded, to which are attached the heating coils. At each end of the pits are located iron steps. The floor of the car repair shops between pits is depressed 18 inches below the rail to facilitate work on car trucks. Provision also is made for the drainage of this depression at one end and concrete steps are provided at each end of the depression.

In the car repair shop section the roof trusses have been designed to safely sustain the weight of the largest interurban car body and the cars are raised off their trucks by two electric hoists which travel on 12-inch I-beams supported on the

lower chord of the roof trusses. One of the photographs shows an interurban car raised high enough so that the trucks may be rolled out clear of the pilot. Four of these electric hoists are provided and electric traveling bridges traveling at right angles to the car repair shop tracks serve to transfer the electric hoists to any of the 12 tracks.

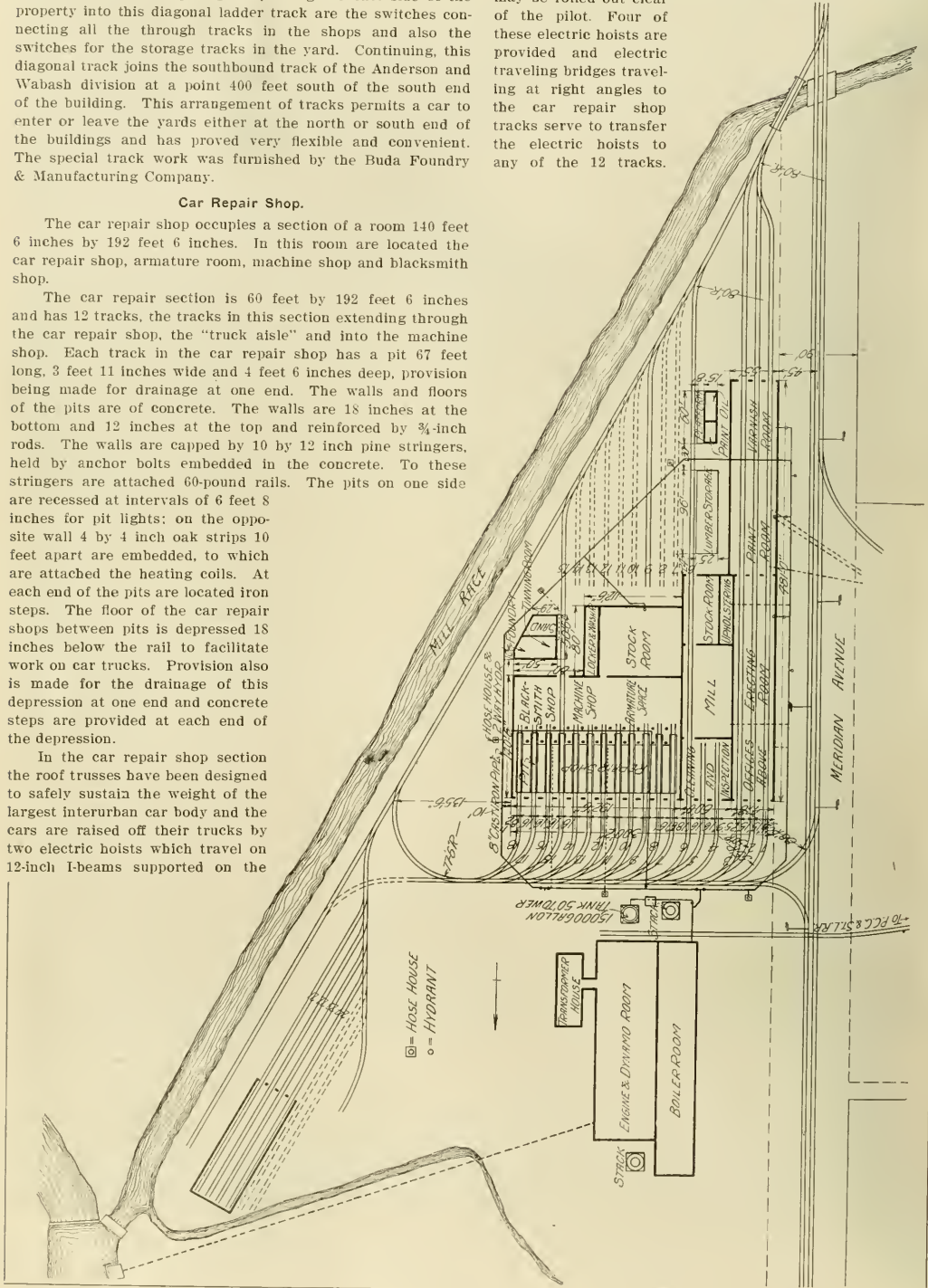

Anderson Shops Indiana Union Traction Company—Ground Plan of Shops and Yards.



Anderson Shops Indiana Union Traction Company—Truck Aisle with Traveling Cranes.



Anderson Shops Indiana Union Traction Company—Depressed Track Through Storeroom.



Anderson Shops Indiana Union Traction Company—Paint Shop with Three Through Tracks, a Concrete Floor and a Generous Window Illumination.

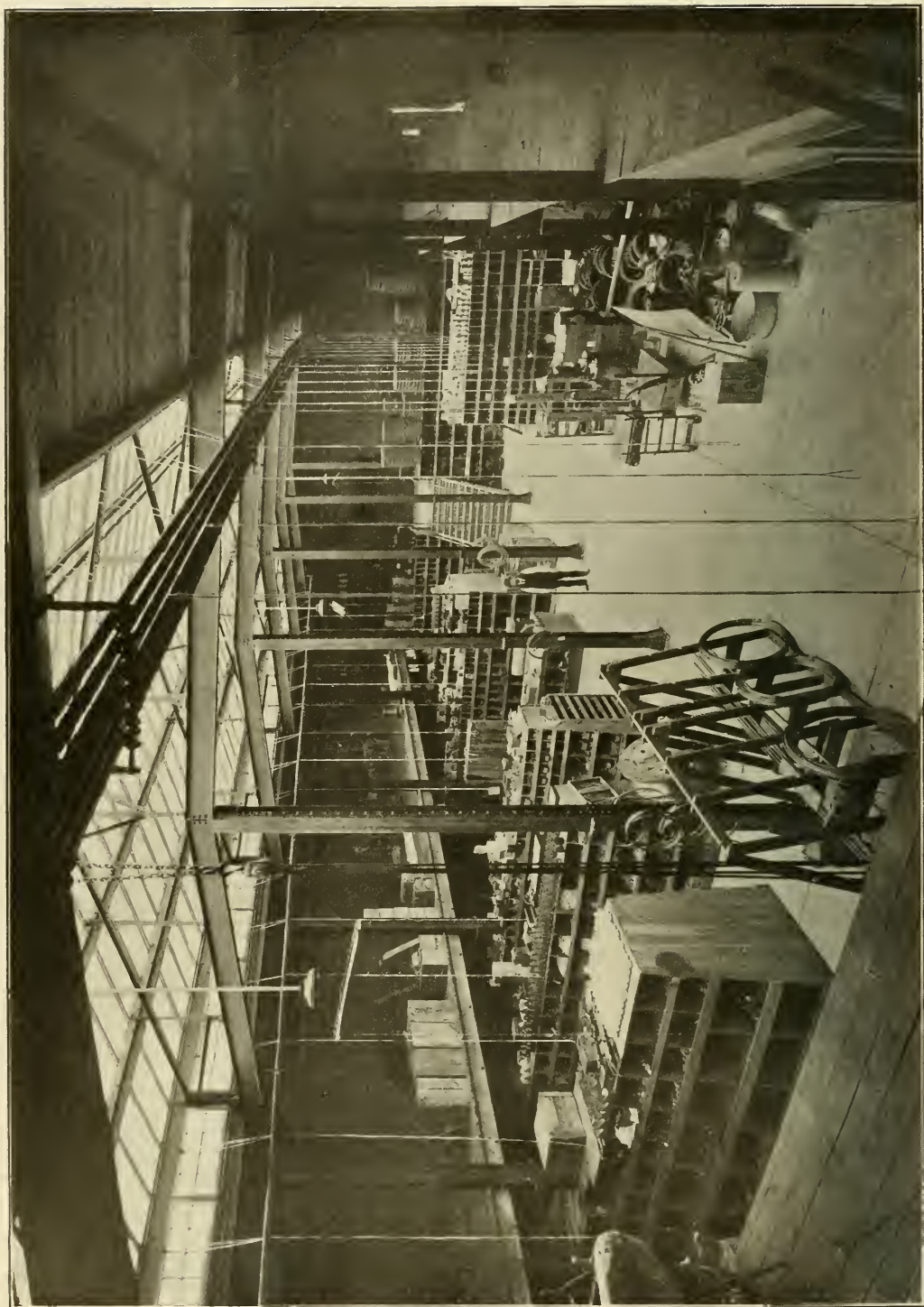

Anderson Shops Indiana Union Traction Company—General Storeroom.

These electric hoists in connection with the bridges are also used as traveling cranes to do any work in the "truck aisle"

permitting the use of the hoists on any of the 12 tracks or anywhere in the truck aisle with a range of movement of 2,016 lineal feet.

**Truck Repair Aisle.**

The truck repair aisle, 16 feet by 192 feet 6 inches, as already indicated, is adjacent to and at right angles with the repair shop section. When trucks are removed from cars they may be repaired in this aisle, which is served by three 5-ton 16-foot span traveling cranes, or they may be rolled out in the shop still further and come under the 15-ton traveling crane which covers the machine shop, armature room and blacksmith shop.

**Machine Shop.**

The section occupied by the machine shop, blacksmith shop and armature room is 60 feet by 192 feet 6 inches. In this section there are three separate sections of motor-driven line shafts arranged along two walls just under the traveling crane girder. As many of the tools as may be arranged are driven from these line shafts and the balance of the machine tools by individual motors.

The machine tool equipment consists of:

- One 32 by 32 by 120 inch heavy Cincinnati planer, 12-horsepower motor.
- One 36-inch by 10-foot Bradford lathe, belted.
- One 24-inch by 8-foot Bradford lathe, belted.
- One 14 by 6 inch Lodge & Shipley lathe, belted.
- One 24-inch Cincinnati shaper, belted.
- One 42-inch Niles wheel lathe, 12-horsepower, motor-driven.
- One 200 Niles wheel press, belted.
- One 36-inch Niles boring mill, belted.
- One 24-inch Cincinnati drill, belted.
- One 20-inch Cincinnati drill, belted.
- One Barr sensitive drill, belted.
- One Barnes sensitive drill, belted.
- One 2 1/4-inch Acme bolt cutter, belted.
- One power metal saw, belted.
- One power hack saw, belted.
- One coil taping machine, belted.
- One field taping machine, belted.
- One banding machine, belted.
- One Beaudry power hammer, belted.
- One exhaust fan, belted.
- One blower, belted.
- Four Buffalo down draft forges, belted.
- One 15-ton traveling crane.

Three 5-ton traveling cranes which were furnished by the General Pneumatic Tool Company, Montour Falls, N. Y.

The arrangement of several departments in one room under the range of traveling cranes has proved very satisfactory, as any part of an equipment may be readily transferred to any department or to any of the tools of any department at the minimum cost.

In a separate room, 16 by 80 feet, is provided a convenience room for the employes of the main shop. This includes toilet facilities, washstands, shower baths and steel lockers.

**Cleaning and Inspection Room.**

This room is 60 by 70 feet in floor area and has three tracks. Two of the tracks have pits 60 feet long, of the same general dimensions and description as the pits in the car repair shop, with the exception that the rails in this room are laid directly on the concrete walls of the pits. This room was especially arranged for the cleaning and sterilizing of interurban cars and the care of the Anderson city cars. There is an installation of a combined air pressure and vacuum cleaning device for cleaning the interior of cars, seats and cushions and for washing the exterior of cars. This installation was supplied by the General Compressed Air & Vacuum Machinery Company, St. Louis, Mo.

**Woodworking or Mill Room.**

The wood mill is 60 feet by 103 feet 6 inches and has a through track on one side from which lumber may be handled directly from the company's own cars or from steam railroad cars. The arrangement of woodworking tools has been care-

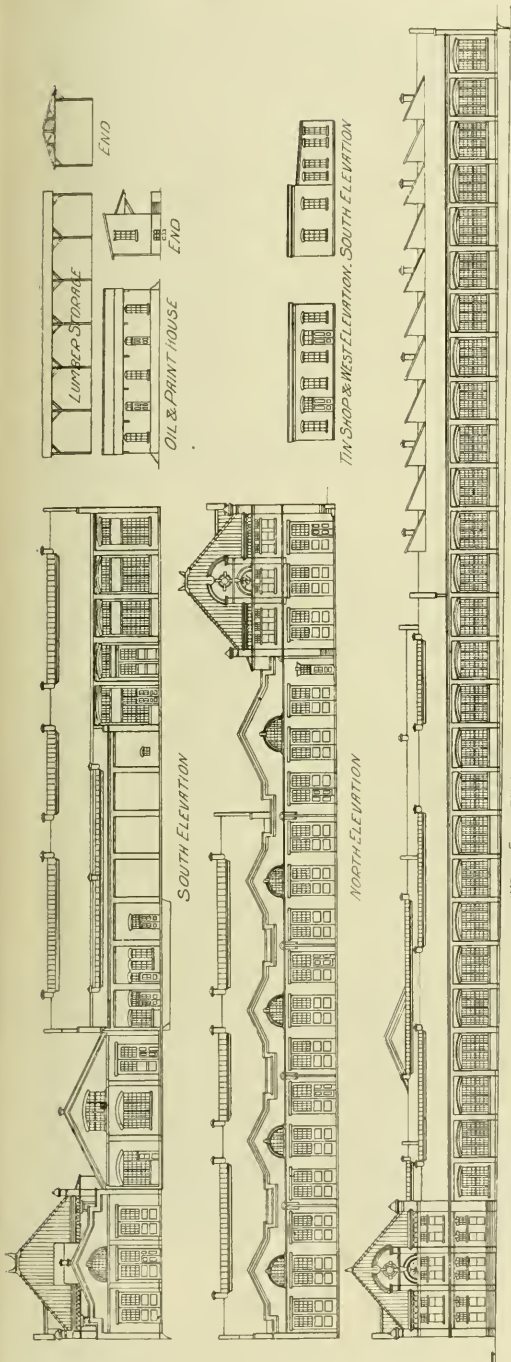

after the trucks have been removed from the cars. This design provides a very convenient and flexible arrangement,

fully laid out so that timbers of the longest dimensions may be handled on any of the machines without interference. In this room the following machines have been installed:

- One 8 by 24 inch 4-cylinder surfacer.
- One 4 by 8 inch molding machine.
- One 2-spindle shaper
- One 4-head tenoner.
- One combined mortising and boring machine.
- One combined jig saw and single-spindle shaper.
- One brand saw.

storeroom. A loading platform also is arranged to facilitate the delivery of material to the storeroom by team.

Car Construction Shop.

This shop is 54 by 260 feet and has three through tracks, which pass directly from this shop to the paint shop in the same bay. This shop is arranged to accommodate 12 of the largest interurban cars.

The paint shop is 221 by 54 feet and has three tracks. It

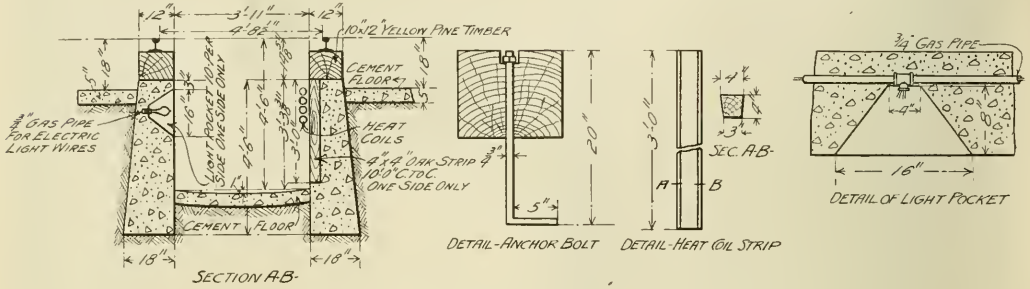

Anderson Shops Indiana Union Traction Company—Details of Repair Pits.

- One cross-cut saw.
  - One rip saw.
  - One universal woodworker.
  - One wood lathe.
  - One automatic knife grinder.
- These machines are driven by Westinghouse induction motor.

Storeroom.

The storeroom is divided into two rooms. One room, 80 feet by 96 feet 6 inches, where general supplies are stored,

is separated from the car construction shop by a brick fire wall, the openings being fitted with three self-closing Kinnear rolling doors. Special attention has been given to the lighting of the paint shop, light being admitted from both sides and by saw-tooth monitors to the middle track. The interiors of all shops have been painted white, giving the benefit of the reflective effect of whitened walls.

A separate brick building, 15 by 60 feet, has been provided for the storage of inflammable fluids, the oil and paint storage



Anderson Shops Indiana Union Traction Company—Details of Repair Pits.

has a mezzanine gallery around its four sides for the storage of lighter material. This room is located adjacent to the car repair room and supplies are issued through one door on requisition only. The other storeroom, 81 feet 6 inches by 60 feet, is adjacent to the main storeroom and is intended for the storage of heavy material, such as track and line material. A through track, depressed so that the floors of loaded cars are level with the storeroom floors, passes through this building and supplies may be handled from this track to either

rooms being separated by a solid fire wall. It is planned to transfer journal and motor oil from the oil house to the car repair shop by air pressure, so that oil may be tapped from faucets located in the car repair shops.

Brass Foundry and Sandhouse.

In a building separate from the main building is located the brass foundry and babbit room, tinsmith shop and sandhouse. The brass foundry has two furnaces and a full equip-



ment of brass foundry tools. The sandhouse is located with one through track on the west side and one stub track on the

necessarily accumulate around a shop. Over this cast-iron pipe is placed a sand hopper which holds 25 yards of wet

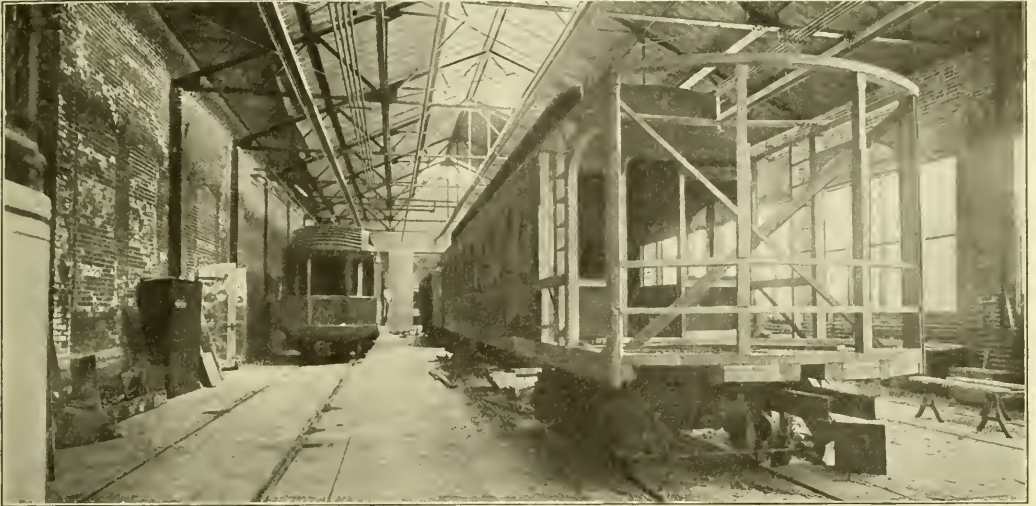

Anderson Shops Indiana Union Traction Company—Car Construction Shop.



Anderson Shops Indiana Union Traction Company—Car Repair Shops, Showing Car Body Being Raised by Two Electric Hoists.

east side, so that the wet sand may be handled from freight or work cars and dry sand furnished to the cars conveniently. The scheme of drying sand is very simple and inexpensive. A 20-inch cast-iron pipe is arranged as a rubbish furnace for the purpose of burning up all refuse, chips and rubbish which

sand. The refuse is fired in the inside of the cast-iron pipe and the sand is dried by the heat thus generated.

At the northwest corner of the buildings a second story, 54 by 64 feet, provides accommodation for six office rooms and an instruction room. The roof of this second story is of orna-

mental tile, which adds to the architectural appearance of the buildings. The offices are occupied by the superintendent of power, division electrician, superintendent of motive power and master mechanic. The instruction room will be fitted with samples of the equipment used on the system, necessary charts, drawings, etc., for the proper instruction of trainmen regarding the important parts of an equipment handled by them in service.

**Heating System.**

The shops are heated by the Evans-Almiral system of hot-water heating. This system employs a forced circulation of hot water. The apparatus consists of a 20-horsepower induction motor directly connected to a centrifugal pump, a live steam heater and the pipe coils in the various buildings. The suction of the pump is connected to the return side of the system and the discharge of the pump to the pressure side. The reheater is connected on the circuit on the pressure side of the system. The pump and reheater are located in the

pendent system of fire protection. The shops have been surrounded by a 6-inch water main with two and three way hydrants located at convenient points outside the building and a sufficient number of hose connections located in the various departments of the shops. Hydrants and hose connections are each furnished with a line of fire hose. Pressure is supplied by an underwriters' fire pump located in the power house.

The design and construction of the shops were under the general supervision of H. A. Nicholl, general manager of the Indiana Union Traction Company, and carried out in detail by W. C. Sparks, superintendent of roadway and buildings, and R. C. Taylor, superintendent of motive power.

**CLEARANCE CHART FOR INTERURBAN CARS.**

A clearance table and explanatory diagram from which the accompanying illustration was prepared were used during the construction of the Ocean Shore Railway. This interesting

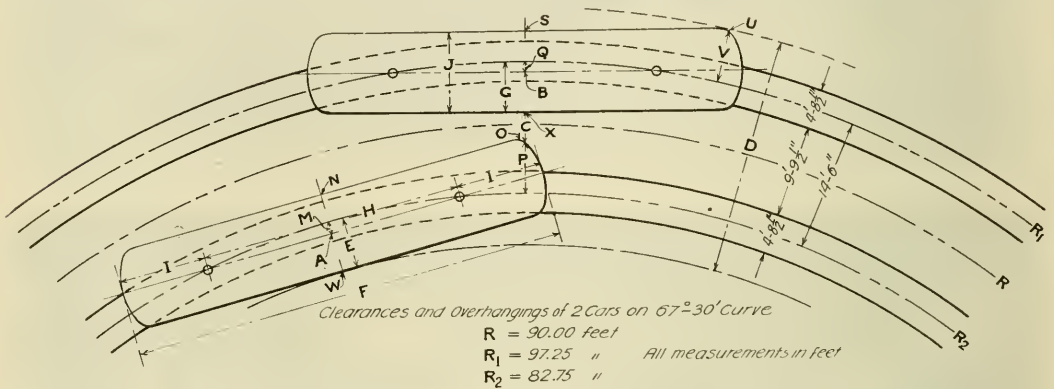

F	J	Inside Track						Outside Track						C	D	E	G	H	I	Remarks
		M	P	R <sub>A</sub>	R <sub>N</sub>	R <sub>W</sub>	R <sub>O</sub>	Q	V	R <sub>B</sub>	R <sub>S</sub>	R <sub>X</sub>	R <sub>U</sub>							
50'-0"	9'-0"	1.37	6.22	81.38	85.88	76.88	88.97	1.16	5.99	96.09	100.59	91.59	103.24	2.62	26.36	5.87	5.66	30.00	10.00	
60'-0"	"	2.45	6.63	80.30	84.80	75.80	89.38	2.08	6.35	95.17	99.67	90.67	103.60	1.29	27.80	6.95	6.58	40.00	10.00	
70'-0"	"	3.37	7.01	78.88	83.88	74.38	89.76	3.27	6.69	93.98	98.48	89.48	103.94	-2.8	29.56	8.37	7.77	50.00	10.00	
70'-0"	9'-8"	3.51	7.66	79.24	84.07	74.90	90.41	2.96	7.30	94.29	99.12	89.45	104.53	-9.6	30.15	8.35	7.80	47.66	11.16	Wagner Sleeper

**Table and Sketch Showing Clearances and Overhangings of Two Cars on 90-Foot Center Radius Curve.**

power house, the water of condensation from the reheater being returned to the hot-water heater. It has been found that the pressure required to circulate the water in the system is 20 pounds and that the hot water loses but 20 degrees during the circuit in the coldest weather.

**Lighting.**

All departments of the shop with one exception are lighted with Cooper-Hewitt mercury-vapor lamps. These lamps are placed above the roof trusses in all rooms and give a soft, well-diffused light with very little shadow. They are arranged to burn six in series, on a 600-volt railway circuit, and thus arranged have given splendid service. Should any lamp in the circuit fail, the others may burn without loss of efficiency. On account of the rays in this light distorting colors the paint shop was lighted with incandescent arc lamps.

Although the shops have been built almost entirely of fire-proof materials it was considered advisable to install an inde-

double-track railway from San Francisco to Vera Cruz, Cal., was described in the Electric Railway Review on page 124 of the issue of August 3, 1907. The chart and table become especially useful to construction engineers when the track work is complicated and close to permanent obstructions. It will be noted that this chart shows two cars on a double-track curve with a 90-foot center radius and 14-foot 6-inch track centers. The cars are placed in such a position that the clearance is at a minimum. The table includes the various assumed and desired dimensions of cars—50, 60 and 70 feet long, and 9 feet and 9 feet 8 inches wide.

Frank L. Dye, a conductor on the Springfield-East St. Louis line of the Illinois Traction System, is reported to have invented a new form of sleet cutter which was recently given a trial with good results. The device consists of an extra trolley wheel placed in front of the ordinary wheel and having a corrugated groove which engages the ice on the wire.

### EFFECT OF 2-CENT PASSENGER FARE LAWS ON INTER-URBAN ELECTRIC TRAFFIC.

The Electric Railway Review has received replies to letters addressed to officials of electric interurban railways inquiring about the effect upon their traffic of the introduction of 2-cents-per-mile passenger fares on steam roads. These replies follow:

#### Ft. Wayne & Wabash Valley Traction Company.

C. D. Emmons, general manager Ft. Wayne & Wabash Valley Traction Company, Ft. Wayne, Ind.: "We do not think that the 2-cents-per-mile passenger fare law will have any effect upon our traffic, as our competing roads have already made a rate of practically 1½ cents per mile in their competition with us, by placing on sale what is known as a twin ticket, which is good for two persons going in the same direction, good for a round trip or for two single trips in the same direction. This ticket is purchased almost exclusively by those using the steam roads, so that their fare is constantly nominally 1½ cents per mile where they compete with us. The more frequent service of the trolley, which passes through the business districts of the various towns and is dependable as to closeness of schedule, will keep the traffic with us."

#### Kokomo Marion & Western Traction Company.

Thomas C. McReynolds, secretary and treasurer Kokomo Marion & Western Traction Company, Kokomo, Ind.: "The effect the 2-cent passenger fare laws will have upon the passenger traffic of the electric railways very much depends upon the distance the steam and electric roads are in competition and the facilities afforded by such roads in the handling of passengers. We operate between Kokomo and Marion alongside the Toledo St. Louis & Western Railroad Company. The steam road has made a material reduction in the fares charged between these points. It may be possible that we lose a very few passengers who are convenient to the railroad station and ready to go when the train goes, but outside of this I do not believe that we have felt the effects of the reduction in fares by steam roads. If the distances were greater between our two terminals and the service on the steam road superior to ours, we might feel the effect more. It is going to be difficult for the steam roads to attract much traffic from the interurbans so long as people can go and come at such frequent intervals as the service of the electric roads now permits."

#### Indianapolis Crawfordsville & Western Traction Company.

George E. Morine, general superintendent Indianapolis Crawfordsville & Western Traction Company, Crawfordsville, Ind.: "The 2-cent fares on steam roads had been in operation some little time when we started to operate our road, consequently it would be nothing but guesswork on my part to try and say what effect the 2-cent rate had on our traffic. We are competing from Crawfordsville to Indianapolis with both the Cleveland Cincinnati Chicago & St. Louis Railway and the Northwestern branch of the Terre Haute Indianapolis & Eastern Traction Company, but in the face of this competition we are building up a very fine business. I do not think the decrease in steam railroad fares to two cents will cause any reduction in fares on interurban electric roads, as most roads are now selling round-trip tickets for less than two cents per mile."

#### Indianapolis Columbus & Southern Traction Company.

A. A. Anderson, general manager Indianapolis Columbus & Southern Traction Company, Seymour, Ind.: "In my judgment the adoption of the 2-cents-per-mile fares by steam railways will affect the traffic of interurban roads on long hauls where the interurban rates are close to 2 cents per mile, but when rates of competing interurban roads average 1½ cents per mile or less the local hauls will not be materially affected. I am quite sure the decrease in steam railroad fares to 2 cents per mile will not cause any reduction in the average fares of interurban electric roads."

#### De Kalb-Sycamore & Interurban Traction Company.

D. Thomson, general manager De Kalb-Sycamore & Interurban Traction Company, De Kalb, Ill.: "I do not think the 2-cent fare law will have any detrimental effect on our traffic whatever; we think it will help us because the increased traffic on the steam roads will bring in more people who can use our line to advantage. The writer is of the opinion that the 2-cent fare law will benefit interurban roads wherever it is adopted: (1) for the reasons mentioned above; (2) cheaper fares mean more passengers or that the same passengers will ride oftener, and the better the people become educated to

ride (by steam or electric) the more benefit will the traction companies derive therefrom. With fares even between electric roads and steam roads, the advantage to the passenger is decidedly in favor of electric roads, not only on account of the frequent service and the ability to take the car at nearly every street corner, but principally on account of the lack of smoke, soot and cinders and because of the general cleanliness of the journey as compared with a trip on steam roads. Of course, this applies only to the electric roads that maintain good and frequent service and good speed. It is the writer's opinion that it is only a matter of time (and that time is very close at hand) when steam roads will be used for long-haul passengers entirely, the local business all passing to the electric roads wherever they are in successful operation."

#### Illinois Traction System.

L. E. Fischer, vice-president and general manager Illinois Traction System, Springfield, Ill.: "There is no doubt that the reduction of fare from three cents to two cents by competing steam railroad lines tends to decrease the earnings of interurban lines—how much we cannot now tell, because our properties have been generally increasing and therefore no comparison is possible. The effect is probably at a maximum now, as the development of interurban traffic will lead to the establishing of service equal in all respects to steam railway service."

#### Evansville Suburban & Newburg Railway.

Gus. Mulhausen, manager Evansville Suburban & Newburg Railway, Evansville, Ind.: "As to the effect of the 2-cent rate law governing steam roads I am in a position to speak from experience, as we already have the 2-cent fare law for steam railways in effect in this state. On July 3, 1906, this company began operating an electric line on an hourly schedule between Evansville and Boonville, 18 miles. The rate of fare was based, as on our other lines, at two cents per mile, and rather than use pennies the 1-way fare was put at 35 cents and the round-trip fare at 70 cents. A steam line operating three trains in each direction per day between Evansville and Boonville was at that time charging three cents per mile on a mileage of 17 miles, the 1-way fare being 51 cents. Of course, we secured practically all of the business between Evansville and Boonville. The steam line operates two local freight trains per day on its line and our road operates two electric express cars in each direction per day. The rates on freight are identical on both lines, still we are handling 85 per cent of the less than car lot freight business between these points. When the new 2-cent rate law became effective the steam line, in order to conform with the same, changed its rate to 34 cents. We have never changed our rate and are still charging 35 cents, or one cent more than the steam line, and still continue to do practically all of the business between Evansville and Boonville. I do not believe that the 2-cent law will greatly injure electric lines because of the fact of their frequent operation, cleanliness and the advantage of their usual downtown terminals. I believe, with courteous treatment and the proper energy on the part of the electric railways, together with the advantage they have over steam lines in the way of accommodation, that their receipts will not be greatly decreased on account of a 2-cent rate law. I assume, of course, that the electric lines will not charge more than two cents per mile."

#### Cleveland Southwestern & Columbus Railway.

C. N. Wilcox, general manager Cleveland Southwestern & Columbus Railway, Cleveland, O.: "We do not find that the 2-cents-per-mile fare on steam roads has affected our earnings to any appreciable extent. We have made no changes in our rates of fare on account of the reduction in rates on the steam roads."

#### Cambridge (O.) Power Light & Traction Company.

D. W. Cameron, manager Cambridge (O.) Power Light & Traction Company: "The 2-cent fare law has not affected our passenger traffic. We changed our rate to the 2-cent rate when the law went into effect. Our line is about one and one-half miles longer to the point we reach than the steam line is, but we take care of practically all the traffic with hourly service."

#### Winnebago Traction Company.

J. P. Pulliam, superintendent Winnebago Traction Company, Oshkosh, Wis.: "The effect of the application of the 2-cents-per-mile rate by the steam lines on interurban traffic, in my opinion, will be determined largely by the frequency of the service given by the steam lines. The success of interurban lines has been due to the frequency of the service, together, of course, with the reduced rates as against the steam lines. The big factor, however, is the fact that interurban

cars run usually every hour, and in a great many cases oftener, whereas the steam line service will consist of two to four trains per day. With us one of our interurban roads has had opposition from two steam roads which provide practically a 2-hour service as against one hour on our part. The steam line, of course, covers the distance more quickly, and, as under the new law the rate is the same, we have noticed a small decrease in our business as a result thereof. A factor that favors interurban roads, however, is the opportunity that passengers have to board the cars on the main streets and the fact that with most lines passengers can transfer to city roads without additional expense. I do not believe our loss will be permanent; on the contrary, the reduced fare will tend to increase the general traffic and we will secure our portion. We are considering a slight reduction in our interurban fares, but not entirely as a result of the change with steam lines, as we have thought for some time that a reduction would be advisable. With the constantly improving conditions surrounding the interurban service, the interurban road is the natural channel for local traffic, even if there is no difference in the rate."

#### Cleveland Painesville & Eastern Railroad.

J. Jordan, general manager Cleveland Painesville & Eastern Railroad, Willoughby, O.: "We have not noticed that 2-cents-per-mile fares on steam roads have taken any of our business, as our increase in traffic has been as great since the 2-cent law went into effect as it has been in years previous. The decrease in steam railway fares has not made any change in the fares on our road. We parallel the New York Chicago & St. Louis Railroad and the Lake Shore & Michigan Southern Railway from Cleveland to Ashtabula, and have very strong competition; if the 2-cents-per-mile rate on steam roads affected the interurban roads it would certainly show very plainly on our traffic."

#### Saginaw Valley Traction Company.

S. E. Wolff, vice-president and general manager Saginaw Valley Traction Company, Saginaw, Mich.: "We do not anticipate any adverse effect from the 2-cent passenger fare laws recently enforced against steam roads."

#### Detroit United Railway.

F. W. Brooks, general manager Detroit (Mich.) United Railway: "I do not believe the effect of 2-cent passenger fare laws upon our traffic will be to our disadvantage, because we have been and are now charging lower fares, the average being about 1½ cents per mile. The frequency of the electric service is a convenience to the public, and if the reduction of the rates of steam railroads to two cents per mile stimulates travel for them, it is likely also to stimulate travel for the electric railroads. The wisdom of establishing such low rates for both steam and electric railways may be seriously questioned in the years to come, because it may unnecessarily result in an impairment of the service."

#### Cedar Rapids & Iowa City Railway.

William G. Dows, president and general manager Cedar Rapids & Iowa City Railway, Cedar Rapids, Ia.: "I do not believe the 2-cent passenger fare law will affect our road in any other than a beneficial way. Under the statutes of Iowa electric interurban railroads are under exactly the same laws as the steam railroads. They report to the board of railroad commissioners, are assessed by the executive council, have the right of eminent domain and have the right to secure perpetual franchises in all cities and towns. The roads are classified in this state according to their earnings per mile per year; those earning \$4,000 and over are obliged to charge two cents per mile. By reason of the fact that our railroad serves a territory not served by any other railroad, we will not be affected by any competition. The distance from Iowa City to Cedar Rapids via the Chicago Rock Island & Pacific Railway by either route is eight miles farther than the distance by our line and passengers are obliged to change cars, so that on a 2-cent basis we would still have the lowest fare. I do not believe that the decrease of steam railway fares to two cents per mile will cause any reduction in the earnings of electric railroads. It is the frequency of service and the stopping to take on and off passengers almost anywhere that counts. The steam railroads would not be able to meet this condition, and consequently will not affect to an appreciable extent the traffic of electric railways."

#### Toledo & Indiana Railway.

H. C. Warren, general manager Toledo & Indiana Railway, Toledo, O.: "I can see no particular decrease in our earnings since the 2-cent fare law became effective. We parallel the air line division of the Lake Shore & Michigan Southern Rail-

way the entire distance from Toledo to Bryan. I think that this law is a serious handicap to steam railroads, but on account of our hourly service and country stops we do not consider that the law is any particular detriment to us."

#### Toledo Urban & Interurban Railway.

Charles F. Smith, general manager Toledo Urban & Interurban Railway, Findlay, O.: "While 2-cents-per-mile fares have had some effect upon our through traffic, the effect is very slight for the reason that the service we give, namely, limited service every two hours and local service every hour, and the fact that people can go to and from Toledo considerably later in the night by electric roads than by steam roads, lead the travel to the electric lines."

#### Alton Granite & St. Louis Traction Company.

L. C. Haynes, president Alton Granite & St. Louis Traction Company, East St. Louis, Ill.: "I am not in a position to answer the question as to the possible effect of 2-cent fare laws for steam railways on interurban electric railway business from the point of view of actual experience, because our system will not be affected particularly one way or the other by the 2-cent steam rate. Only lines which are strictly interurban and operate for considerable distances will be affected, it seems to me, by this narrowing of margin between rates formerly charged by steam and electric lines. The accepted basis of local rates on interurban lines is, I think, very generally two cents a mile, and it goes without saying that if the steam roads carry passengers at the same rate the advantages of electric service will not include a lower rate of fare. The frequent service of electric lines, affording in almost all cases not more than hourly intervals between trains, and the superior conveniences offered by electric cars, which traverse in all cases the central business and residence portion of cities and villages through which they pass, will, I think, continue to give the bulk of local traffic, at least for distances inside of 50 miles, to the electric interurban lines, regardless of the fact that steam transportation may be had at the same price."

#### Indiana Union Traction Company.

H. A. Nicholl, general manager Indiana Union Traction Company, Anderson, Ind.: "We do not believe that the adoption of 2-cents-per-mile fares by steam railways will affect to any appreciable extent the traffic on electric railways. Electric railways will not reduce their fares on account of the 2-cent law; but, on the contrary, I believe that those charging under two cents per mile at the present time will increase their fares to as near two cents per mile as they consistently can."

#### Galesburg & Kewanee Electric Railway.

R. H. Hayward, general manager Galesburg & Kewanee Electric Railway, Kewanee, Ill.: "Prior to July 1, 1907, we had charged 20 cents one way and 30 cents for the round trip on our 9-mile interurban road between Kewanee and Galva, paralleling the main line of the Chicago Burlington & Quincy Railroad. On July 1, when the Burlington put into effect the reduced 2-cents-per-mile rate, which made its fare between Kewanee and Galva 16 cents, instead of 25 cents, we reduced our 1-way rate from 20 to 18 cents and discontinued the 30-cent round-trip rate. Since July 1 we have therefore been charging 2 cents more than the steam railroad, whereas before that time we had charged 5 cents less. Our earnings since July 1 have shown a normal increase and we believe that in our case, at least, the reduction in the steam railroad rate has had no appreciable effect on our earnings. We make 15 round trips daily between Kewanee and Galva, whereas the Burlington has but three trains one way and two the other between these two points. Whatever inclination the public might have to patronize the steam road on account of a lower rate is overcome by the superior service which we offer. In cases where the steam road offers service more nearly equal to that of the electric line the result might be different."

#### Grand Rapids Grand Haven & Muskegon Railway.

W. K. Morley, vice-president and general manager Grand Rapids Grand Haven & Muskegon Railway, Grand Rapids, Mich.: "I do not think the adoption of the 2-cents-per-mile rate by steam roads will affect to any appreciable extent the volume of traffic of electric railways; the frequent and convenient service of the electric roads will enable them to hold the business."

#### Dayton & Troy Electric Railway.

C. M. Paxton, general manager Dayton & Troy Electric Railway, Tippecanoe City, O.: "In answering your questions I can give you the experience of our line only and am not prepared to say what the effect has been on electric railways

generally. Our line is paralleled for its entire length by the Cincinnati Hamilton & Dayton Railway, which operates six or seven passenger trains each way daily and caters particularly to local travel, nearly all of its trains making local stops. Our rates of fare were met by this railway a long time prior to the passage of the 2-cent law and we did not feel the effect of the law when it was passed as a line might feel it which had been competing with a steam railway having a 3-cent rate in effect. I understand that a number of electric railways have found it necessary to readjust fares on account of the cheaper rates by steam, but in our case our loss, if any, was due to the fact that the law had the effect of advertising, in a most effectual manner, the equalization of steam and electric rates, whereas in the past the electric railways have enjoyed the benefit of the assumption on the part of nearly all travelers that electric railway rates were universally less than the rates in effect on steam lines."

#### Chicago & Joliet Electric Railway.

J. R. Blackhall, general manager Chicago & Joliet Electric Railway, Joliet, Ill.: "I do not know what effect the 2-cent passenger fare law will have upon the traffic of interurban electric railways in other parts of the state. So far as our road is concerned, the new law has had no effect on our traffic, as the fare on our interurban line between Joliet and Chicago was so much lower than the railroad fare that reducing the latter fare to two cents per mile still leaves the steam rate between Joliet and Chicago more than double our rate. Joliet is within the Chicago commutation zone, and the railroads have not changed the commutation rate since the new law went into effect, so we still have the same competition that we had in the past."

#### NORTHWESTERN ELECTRICAL ASSOCIATION.

The sixteenth annual convention of the Northwestern Electrical Association was held at the Hotel Pfister, Milwaukee, Wis., on January 15 and 16. There were about 75 members and guests in attendance. A meeting of the Wisconsin Electric and Interurban Railway Association was called at the same time and place for the purpose of appointing a committee to meet the railroad commissioners of the state of Wisconsin for a consideration of the subjects of a standard form of accounting and rate regulation. At this meeting a committee of two was also appointed to consider a revision of the constitution of the Wisconsin Interurban Railway Association so that it might be united in its work with the Northwestern Electric Association.

During the Wednesday afternoon session of the Electrical association the president appointed a committee of three to work with a similar committee of the Interurban association and the Wisconsin Gas Association in discussing with the state railroad commission the questions of uniform accounting and rate regulation. The other business of the association was of a formal nature.

The following papers and addresses were presented on Wednesday afternoon and Thursday: "Depreciation," by C. N. Duffy, comptroller Milwaukee Electric Railway & Light Company, Milwaukee, Wis.; "Central Station Load That Pays," by E. L. Callahan, electrical engineer, Chicago; "The Public's Debt to the Public Service Corporation," by W. R. Putnam, manager Red Wing Gas Light & Power Company, Red Wing, Minn.; "The Wisconsin Utility Law," by Neil Brown, member of the Wisconsin legislature; "Steam Notes on Small Turbine Plants," by J. L. Hetch, mechanical engineer North Shore Electric Company, Evanston, Ill.; "Electrical Notes on Small Turbine Plants," by C. W. Pen Dell, electrical engineer North Shore Electric Company, Evanston, Ill.; "Electric Lighting in Cities and Villages of 3,000 and Under," by Irving P. Lord, general manager Waupaca Electric Light & Railway Company, Waupaca, Wis.; "Single-Phase Alternating-Current Motors," by F. L. Kaufman.

Those of the papers of particular interest to the electric railway field are presented elsewhere in this issue. At the close of the Thursday afternoon session the members adjourned to visit the electrical show which is now being held at the Coliseum in Chicago.

## Communications

### JURISDICTION OF THE INTERSTATE COMMERCE COMMISSION OVER ELECTRIC RAILWAYS.

To the Editors:

I beg to acknowledge the receipt of your letter, in which you make some inquiries touching the jurisdiction of the interstate commerce commission over the electric railway interurban mileage of the country and also as to the application of the act to such carriers.

The act to regulate commerce as amended makes no distinction between roads operated by electricity and those operated by steam power. Nor has this commission at any time sought to make any such distinction. Section 1 of the act in express terms brings within its provisions all common carriers engaged in the interstate carriage of passengers or property by rail. And it has been uniformly the view of the commission that the act applies to electric roads as clearly and as fully as to those operated by steam when they are engaged in such interstate transportation. This question, in fact, came before the commission more than 10 years ago. In *Willson v. Rock Creek Railway Company*, decided on March 12, 1897, and reported in 8 I. C. Rep., 83, you will find the question fully discussed. In that case the defendant railroad company was operated by electricity. Its line ran partly in the District of Columbia and partly in the state of Maryland. The record showed that it was essentially a street surface road for the conveyance of urban and suburban passengers. The commission held, Commissioners Yeomans and Prouty dissenting, that it was subject to the provisions of the act to regulate commerce. So far as I now recall the commission has never departed from the principles there announced. Since the act was amended on June 29, 1906, the question has come before us informally on the correspondence of the commission and the same view has again been expressed. I do not understand that under the amended act there is any difference of opinion in the commission as to our jurisdiction over such companies when they are engaged in the interstate transportation of either passengers or of property.

The statement of your correspondent that the commission has jurisdiction over only about 20 per cent of the electric mileage of the country is probably based upon a misunderstanding by him of what is said on page 142 of the annual report of the commission just made to the congress. [An abstract of that part of the report which relates to electric railways is published elsewhere in this issue.—Eds.] An examination of our records had been made in the division of statistics and accounts in order to arrive at a rough estimate of the mileage of electric railways, the lines of which lie in more than one state. It was thought that about 20 per cent of the entire mileage belonged to such companies. You will observe, however, that the report at the point in question expressly states that the location of the physical property is not the final test of the jurisdiction of this commission. The test to be applied to electric railways in order to ascertain whether they are subject to the provisions of the act to regulate commerce differs in no respect from the test commonly applied to steam railroads in order to ascertain whether this commission has jurisdiction over them. Regardless of the physical location of either electric or steam railroads and whether their lines begin and end in the same state or not, if either is engaged in the transportation of property from a point in one state to a point in another wholly by rail or in connection with a water carrier under some arrangement for a continuous movement, the act applies in all its phases. That has been my view of the matter and I am quite confident that the same view is entertained by my colleagues.

Many interesting and important questions have arisen touching the question of the jurisdiction of the commission

over electric lines, all of which are having careful consideration. But the fact that the motive power is electricity has no relation to or any bearing upon the proper solution of these problems. Their solution will depend, as would be the case were the roads in question operated by steam, upon the manner in which the transportation is actually conducted and whether it is in fact interstate transportation within the meaning of the act.

You make inquiries about the purpose of the commission with respect to prescribing a system of accounts for electric lines. The law contemplates that the commission will establish accounting systems for all the agencies of interstate transportation. And it is the purpose of the commission to promulgate systems of accounts for electric railways, similar, so far as may be, to the system prescribed for the steam railways. A comparison of the reports of steam railways, electric railways, water carriers, express companies and other agencies for transporting the commerce of the country, so far as the commercial and special physical conditions surrounding each form of transportation will permit such comparison, cannot fail to be of value. The basis of such comparison would not be complete if electric lines were omitted from the general accounting scheme which the commission has in mind. This becomes more important in the case of electric railways because their tendency is more and more to serve and become branch lines or feeders of the trunk line railways. Two cases are now on the docket of the commission in which electric lines seek the aid of the commission to compel steam roads to join with them in establishing through routes and joint rates. Lines heretofore operated by steam are now being electrified. Many electric roads are carrying freight not only in carloads but in trainloads, and are otherwise conducting exactly the same kind of transportation that is done by steam railroads. Obviously an accounting system that affords a basis of comparison between lines operated by steam and lines operated by electricity ought to be available, and this cannot be done without a uniform system of expense accounts for the electric lines.

JAMES S. HARLAN,

Commissioner Interstate Commerce Commission.

Washington, D. C., January 9, 1908.

#### Suggests Running Railroad Trains in New York Subways.

In applying to the board of estimate for permission to increase the dimensions in the original plans for the Brooklyn Fourth avenue and the bridge loop subways, the New York public service commission suggests that the subways be built so as to accommodate the trains of the New York Central and New York New Haven & Hartford railroads, in case it should be found desirable to run such trains through the subways at any time in the future. It is proposed to increase the headroom from 13 feet 6 inches to 14 feet and also to do away with several grades which exist in the original plans. It is thus evident that the commission has in mind the possibility of the railroads becoming bidders for subway routes in competition with the Belmont interests, who are now the only logical bidders. The new subway route on the east side which the commission proposes to build could easily be made to connect with the New Haven road at Mott Haven, so that the latter's electric trains could be run over to Brooklyn or through the bridge loop to the Brooklyn bridge.

On January 1 the Cape Fear Power Company began the distribution of electric power to Fayetteville, N. C., from its water power electrical plant at Buckhorn Falls, on the Cape Fear river, 35 miles distant. This plant represents an expenditure of about \$500,000, and is prepared to furnish about 4,000 horsepower, 3,000 of this being guaranteed for 24 hours every day of the year. It is stated that surveys of the river three miles below the present plant indicate a possible development of 18,000 horsepower.

#### A SINGLE-PHASE RAILWAY MOTOR.\*

BY E. F. ALEXANDERSON, ELECTRICAL ENGINEER GENERAL ELECTRIC COMPANY.

The various single-phase railway motors which have been developed during the past few years have been styled in general as either repulsion or as series motors.

The most prominent types of single-phase railway motors which have found commercial application are:

1. The compensated repulsion motor (Latour-Winter-Eichberg). This motor has a short-circuited armature and an extra set of brushes for producing compensation, with a view to obtaining a higher power factor.

2. The compensated series motor (Eickmeyer-Stanley-Lamme).

3. The compensated series motor with shunt excited commutating poles (Milch-Richter). In this motor a commutating field is produced locally by coils in the stator.

The motor to be discussed in this paper is neither a series nor a repulsion motor in the generally accepted sense, but embodies the best features of both. For lack of a better name it may be called a "series-repulsion" motor. The windings resemble those of a series motor and the armature and stator are permanently connected in series. A general diagram of the motor is shown in Figure 1. The terminal voltage of the series-repulsion motor can be selected with greater liberty

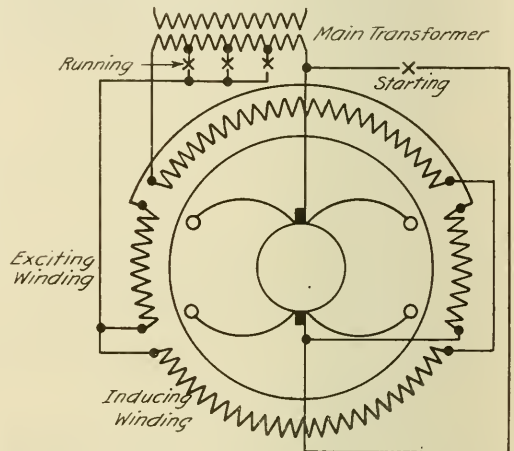

The Series-Repulsion Motor—Figure 1.

than in a series motor, but not so arbitrarily as in the case of a repulsion motor.

Its advantages over the straight compensated series motor are very marked. The commutation is so radically improved that resistance leads are unnecessary and it is feasible to build the motors in larger capacities.

In its performance it resembles the series motors with commutating poles, but offers several distinct advantages over the same. Instead of producing a commutating flux locally by coils on the stator, the conductors in the armature are located in places where the desired flux will naturally exist. This arrangement simplifies the stator winding considerably. The compensating winding of the series motor is replaced by an inducing winding with twice as many turns, and the energy is introduced either in the stator alone or in the stator and rotor together. By this arrangement the starting torque is doubled for the same commutation and the same supply of current.

In the compensated repulsion motor the commutating field becomes too strong as soon as the speed appreciably exceeds synchronous, unless special arrangements are made to suppress this field locally. The motor under consideration is not limited by the synchronous speed, as the repulsion motor feature is reduced at the high speeds, and its action follows more closely the performance of a series motor; the number of poles can therefore be selected with the same liberty as in a series motor. This is of great importance for the motor characteristics, particularly in regard to weight and starting

\*Abstract of paper presented before the American Institute of Electrical Engineers, New York, January 10, 1908.

torque. Furthermore, no extra set of brushes, nor any series transformer, is required, which makes the motor equally well adapted for direct and alternating current.

**Starting.**

The starting of a single-phase motor is materially handicapped by the fact that the alternating nature of the main field sets up currents in the armature coils which are short-circuited by the brushes. This same difficulty is experienced in all known types of single-phase commutator motors. Although the principle involved is the same in the motor under consideration, the practical result gained by the arrangement employed is a starting torque twice as high as would be possible in a corresponding series motor for the same commutation and the same supply of current.

This double starting torque is obtained by winding the stator with twice as many turns as the armature. The motor starts as a repulsion motor with the armature short-circuited, as shown in Figure 2. The current as it enters the stator has only half the strength of that in the rotor, owing to the ratio of stator to rotor turns. The short-circuiting switch of the rotor

upon the inducing and exciting windings. The current flowing through the stator continues through the armature, but due to the ratio of turns of inducing winding and armature winding, an additional current of equal strength to the stator current flows through the local circuit of the armature and the short-circuited connection. In the running connection part of the power is introduced in the stator and part in the rotor, and the field winding carries the same current as the armature; that is, twice the stator current, thus giving a relatively greater field strength than in the starting condition, just as it would be produced by a series-multiple connection of the field winding.

Although the total potential impressed upon the stator and rotor is the same for starting and running, the result of changing the connection so as to transfer the energy input from the stator to the rotor has the effect of increasing the resulting voltage of the motor. This is due to the ratio of transformation between stator and rotor. In this manner a higher speed is obtained by impressing a higher resulting voltage, and the same change of connections makes the motor adapted for a higher speed by changing the ratio of series and repulsion motor action.

The only motor that has an inherent claim on unity power factor is the direct-current motor. In every alternating-current motor a certain amount of wattless volt-amperes is consumed in magnetizing the field, and in leakage, so that the maximum torque is limited to a lower value than it is with the direct-current motors. An alternating-current motor with inherently good power factor is one with high overload capacity, and this must be due to a comparatively small proportion of volt-amperes being consumed for magnetization. There are, however, artificial methods of bringing the power factor of the alternating-current motor up to unity.

**Resistance Leads.**

The use of resistance leads, which has been so much discussed, has been found to be unnecessary in motors of the type described. Certain motors which have been operated for a considerable time as series motors, and then rewound so as to embody the features described in this paper, have shown an increased life of brushes and commutator up to the standard of good direct-current practice. The improvement in commutation was so great that it was possible at the same time to increase the thickness of the brush and the output of the motor.

**Selection of Frequency.**

In regard to choice of frequency the series-repulsion motor again gives greater liberty. Whereas the starting torque can be doubled on either 15 or 25 cycles, it may be mentioned that a series motor which was almost inoperative at a certain load at 25 cycles, after rewinding, as described, was tested as a series-repulsion motor and found to give excellent commutation at 40 cycles at the same load. It can therefore be said in general that 25 cycles is entirely satisfactory for all geared motor work; it is preferable in that the combination of motor and transformer weighs less at 25 than at 15 cycles.

**Economy of Material.**

The motor described can be built in larger capacities than the series motor. The principal reason for this is the inherently good commutation and increased starting torque which make resistance leads unnecessary, thereby eliminating the heat generated by the resistance leads, and also gaining space in the slots, which can be used for copper. Furthermore, it is possible to increase the flux per pole without impairing the commutation.

The fractional pitch winding which is used primarily for the sake of commutation is also advantageous from the point of view of economy of material. The fact that the number of poles in the series-repulsion motor can be selected without regard to the synchronous speed is an important consideration.

In summing up the preceding the particular advantages of the motor described may be claimed to be:

1. Good commutation at all speeds without the use of resistance leads.
2. Larger capacities possible than with the series motor.
3. High tractive effort possible, due to the liberty of selecting the number of poles.
4. Increased starting torque, possible because of the inherent ratio of winding turns, without supplying an increased current from the main transformer.
5. Simplicity of construction. The stator is the same as in the series motor, in fact easier to construct due to the greater liberty of placing the field winding in slots. The armature is constructed according to standard direct-current practice with the conductors soldered into the commutator bars.
6. Equally applicable to direct and alternating current.

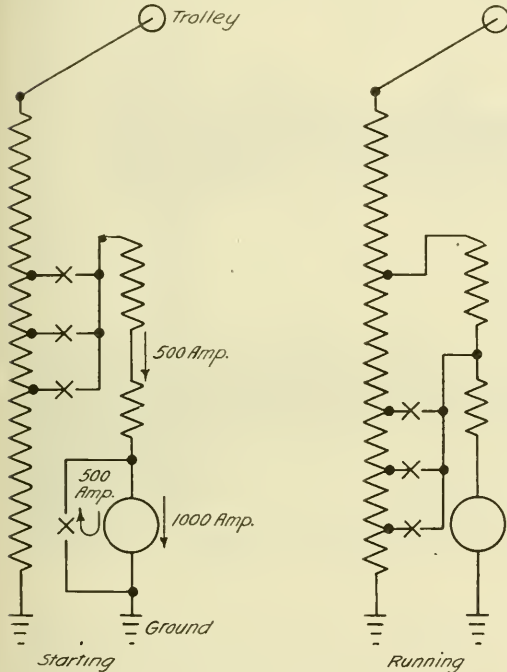

The Series-Repulsion Motor—Figures 1 and 2.

carries only half as much current as the rotor itself, because the current in the short-circuited connection is only the difference between the stator and the rotor current. The inducing winding, the field and the armature are connected permanently in series; but with the connections shown the field is in series with the stator circuit at starting and with the rotor circuit when running. In starting the rotor carries twice as much current as when running, in order to give the same field strength—in this manner doubling the starting torque.

**Features of Operation.**

In regard to the practical application of the system it may be mentioned that several 4-motor equipments for alternating and direct current have been in operation for some time. The alternating-current control equipment has a total of seven contactors and a reversing switch. This gives four points on the controller, which seems quite satisfactory for motor car operation, though any number of steps can be added to take care of locomotive operating conditions.

The preferred method of control is the one shown in Figures 2 and 3. In starting the armature is short-circuited and the full secondary voltage of the transformer is impressed

THE NEW HAVEN SYSTEM OF SINGLE-PHASE DISTRIBUTION WITH SPECIAL REFERENCE TO SECTIONALIZATION.\*

BY W. S. MURRAY, ELECTRICAL ENGINEER NEW YORK NEW HAVEN & HARTFORD RAILWAY.

The method and distance chosen for sectionalizing the high-tension wires supplying power for alternating-current traction is worthy of careful consideration.

There is shown diagrammatically the actual scheme of single-phase distribution which was adopted and is now in service on the New York New Haven & Hartford Railroad. It comprises 11,000-volt three-phase generation transmission along the right of way at this voltage, only one phase being applied to all sectionalized trolley wires throughout the zone of electrification. The three phases are also carried through-

polyphase power, it is difficult to escape the conclusion that it is a desirable and necessary adjunct to the system. In connection with its application to the New Haven electrification, it may be said that synchronous motors will be shortly substituted for steam engines in one of our lighting plants. Such arrangements will bring about the centralization of power generation, and by proper field adjustment of the synchronous motors the general power factor of the single-phase system will be raised.

Sectionalization.

An examination of the electrical connections made in and on the power house, line and locomotives would bring out the strong similarity of the New Haven system to the well standardized, direct-current (not alternating-current-direct-current) system. In either case the path is from one busbar of the station to the feeder and trolley, thence to the locomotive and from there to the rail and return to the other station busbar.



New York New Haven & Hartford Single-Phase System—Anchor Bridge and Catenary Construction.

out the electrification zone, and are at all points available for polyphase motors, such as would be used in railway machine shops and for the operation of motor-driven generators in local direct-current railway plants owned by the railroad company.

A modification of this arrangement which was considered may be mentioned; namely, 11,000-volt three-phase generation, single-phase distribution for traction with step-down transformers distributed along the line, their secondaries furnishing 3,300 or 6,600 volts to the sectionalized trolleys. For the reason that the life hazard in using 11,000 volts was not considered to be greatly increased over that of 3,300 or 6,600 volts, and in view of the higher efficiency, lesser currents to be collected by locomotive shoe contacts, greater reliability and the lower operating costs (no transformer substations), the advantages of the 11,000-volt direct transmission to the sectionalized trolleys was immediately apparent, and the problem became simply one of insulation.

As concerns the choice of three-phase generators in connection with single-phase distribution for traction purposes, again local conditions were the real factors that framed this conclusion. Single-phase or balanced polyphase voltages are undeniably more desirable than unbalanced ones; at the same time when proper allowance and arrangement are made for the unbalanced voltages, and there is a decided market for

Single-phase distribution offers an excellent opportunity for sectionalizing. As may be seen in the diagram the system consists simply of the track trolleys, two auxiliary wires immediately adjacent, and the necessary switching complement. Although these auxiliary wires have been called feeder wires, and while, as a matter of fact, they do serve to increase the capacity of the overhead system, this is not their principal function, as the amount of copper included in the trolleys would suffice to be within the economic figures of copper loss. The auxiliary wires are installed to serve as by-passes, in the event of it being desired to cut dead any or all of the trolley wires in any section. Thus by this system of auxiliary by-passes any degree of sectionalizing can be used, and any or all trolley voltages in sections can be removed without interrupting the continuity of the voltages throughout the zone.

The lengths of sections are governed entirely by local conditions. No two sections of the 14 that exist in the 21 miles of New Haven electrification are the same. It is seen, however, from these figures that the average length of sections is 1.68 miles, that none of these is over 2.19 miles or less than 1.07 miles.

The best reason that can be assigned for the use of sections is in order that line troubles may be localized. There are many others, and some of a most important character. Indeed, it may be said that were the line absolutely immune from trouble, such as grounding, mechanical failures, etc., there would still be many good reasons for sectionalizing it, and these will develop as the subject is further studied.

\*Abstract of a paper presented before the American Institute of Electrical Engineers, New York, January 10, 1908.



It will be noted that of the 14 electrical sections between Woodlawn and Stamford nine of these are co-terminous with the signal towers. In each of these towers there is installed a small panel containing the pilot switches controlling the trolley (and by-pass) circuit-breakers installed on the anchor bridges. Aside from the economical features of this scheme of control, as no operators other than our present signal operators are required, the value of placing the distribution in the hands of this class of men is most important, their constant attention to matters pertaining to the operation of trains brings about the attention which should be accorded to the distribution of current; their thorough understanding of the conditions of traffic on the various tracks permitting the most intelligent handling of electrified and de-electrified trolleys, assuring at once prompt and reliable service in the matter of

therefore, instead of specifying the length of sections, to specify the number to be used over a given total distance; their individual length varying in accordance with the local conditions peculiarly related to them. Upon this basis it will be interesting to enumerate the following advantages and disadvantages peculiar to a choice of a "small number" and a "large number" of sections over a given distance. In this table it should be remembered that usually the items of advantage for the "small number" of sections will be items of disadvantage for the "larger number," and vice versa. Also it is assumed that the signal towers along the right of way average about 1½ miles apart and that electrical sections of this length, or longer, will be classed as a "small number" and sections shorter than this will be classed as a "large number." A tabulation of the advantages and disadvantages of the

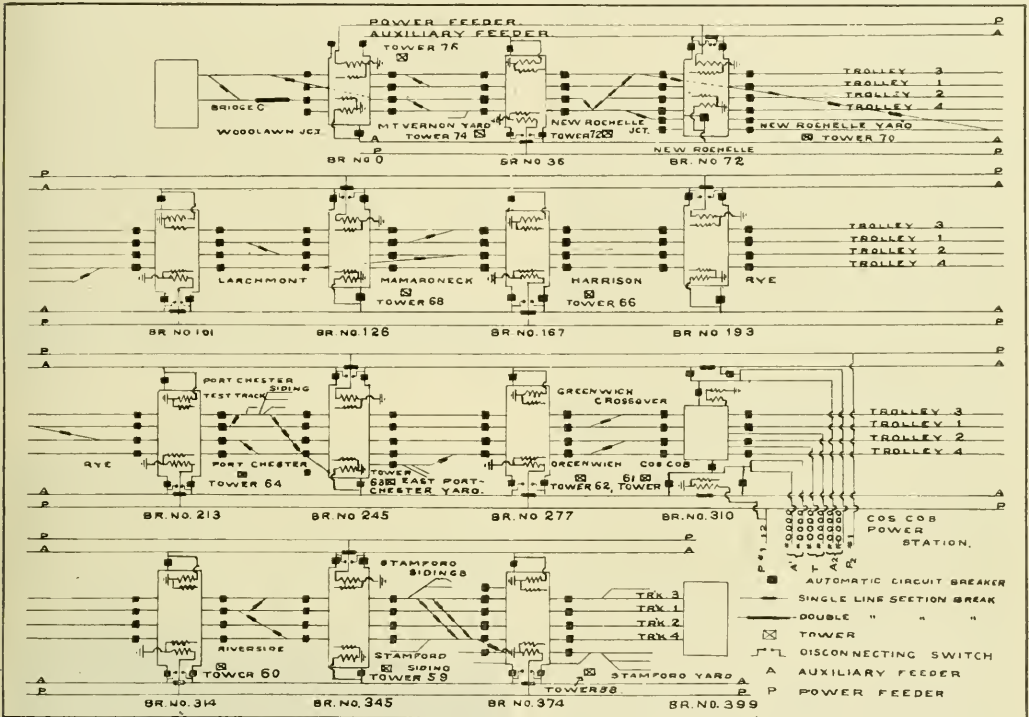

New York New Haven & Hartford Single-Phase System—Diagram of Distribution System, Woodlawn Junction to Stamford.

handling a situation when crossovers have to be made on electrified tracks, and while repairs are being made on others from which the voltage has been removed. The value of placing the distribution system in the hands of the signal operators may be again illustrated by saying that should an electric train run past a stop signal set by the operator, or should the operator desire to stop a train in his block he has only to trip the pilot switch controlling the trolley circuit-breaker, from which the train is drawing its power, and signal the operator in the adjacent tower to do likewise. The individual value of this protective requisite is an illustration of the use of sectionalizing outside of the question of line troubles.

As before stated, it is impossible to elect some standard distance for sectionalizing the line and then apply it to a steam road undergoing electrification. It is possible to conceive of an entirely new electric line subjected to this hypothetical course of procedure, but even in this extreme case it is difficult to escape the exceptions that could be taken to it; for example, what a strange coincidence it would be to find 50 towns just two miles apart along a railroad's right of way. On the other hand, how important each town would be whereat to locate a signal tower with its complement of electrical equipment.

In the discussion of sectionalization it would seem proper,

use of a "small number" as against a "large number" of sections is as follows:

- |  |  |
|--|--|
| <p>Advantages.</p> <ol style="list-style-type: none"> <li>1. Co-terminous tower scheme more easily arranged.</li> <li>2. Less switches to maintain.</li> <li>3. More reliable, due to less frequent grounding of line.</li> <li>4. Less cost.</li> </ol> | <p>Disadvantages.</p> <ol style="list-style-type: none"> <li>1. Difficulty of locating grounds increased.</li> <li>2. Greater section of track cut dead in case of ground or other trouble. Disadvantage, however, related to crossovers.</li> <li>3. Larger section breakers required.</li> </ol> |
|--|--|

In advance of a discussion of the items in the above table it is fair to assume that convenience of construction of the apparatus required for either the long or short sections may be equated. That is to say, the work train service, in either case, would be about the same, and the structures to be put up of a character which would require much the same general superintendence and engineering.

In the case of the long sections it would, of course, be necessary to splice the messenger cables, as they could hardly be manufactured on single reels greater than two miles in length, but the splicing process would not be a matter of great inconvenience, and would not detract from the value of the cables. On the other hand, in the case of the shorter sections a

greater number of anchor bridges would be required for the supply of sectionalizing switches, but this form of structure would not increase, to any extent, the difficulties of erection, or would the placing of apparatus upon them interfere with regular traffic.

Taking up the discussion of the above tabulation of advantages and disadvantages for the small number of sections versus the larger number, or, stated in another way, sections of greater length versus sections of shorter length, we note that under "advantages."

It would be a strange state of affairs if it were impossible to improve upon any principle or form of construction adopted. In regard to principles which have governed in the electrification and sectionalization as adopted by the New Haven road, I have found by careful inquiry into the opinion of those who are responsible for the operation of our electric trains and the distribution of currents to them, that if any change were to be made, possibly some advantages would accrue in the use of a longer section.

In regard to form of construction. It is fair to say that there are many changes that can be and are being made, which will greatly increase the efficacy of distribution. It is my observation that the New Haven electrification has been looked upon as a radical departure from engineering practice. There is no question about the justice of such a remark when viewing the matter as a whole. If, however, we segregate each link in the chain which forms the whole I believe it will be found that no one link is a particular departure from a practice that has existed many years. It has simply been the putting together of old principles into a new form. One exception can be made to this statement. The alternating-current railway motor is new, and yet an exposition of its characteristics, such as in its speed and torque curves, shows that within it the old underlying principles prevail. Its complements, the power house and line, involve no new principles that have not been tried out under various forms and conditions. A high-tension moving contact has nothing new or of a disturbing nature about it.

The last six months of operation have offered the opportunity for a collection of valuable data, and the following observations and recommendations are offered in the hope that they may be of some value to other engineers interested in the electrification of steam roads:

1. In one, two, three or four track railroads the single-phase distribution should include, besides the trolley wires, by-passes or feeders.
2. Electrical sections should not average less than 1.5 miles in length; greater averages are entirely acceptable and individual lengths should be governed by local conditions.
3. Twenty-two feet is a safe general working distance of trolley from rail.
4. The de-insulating effect of steam locomotive stack discharges is a most important consideration to be kept in mind in the matter of properly insulating high-tension wires from ground.
5. High-insulation factors should be used where high-tension construction due to low bridges is brought nearer the rails than the normal height of 22 feet. Strong mechanical shields should be used to deflect locomotive blasts from messenger insulators at low bridges. Care should be exercised in the installation of these shields so that high-tension conductors and ground are at safe working distance. Wherever possible insulators should be installed away from the direct line of the locomotive blast.
6. Auxiliary wires in connection with the electrification, if they cannot be carried over highway bridges as aerial conductors, should not be carried under, unless they are inclosed in lead-covered cables, with end bells properly inclosed in suitable housings at points where the conductors change from aerial to lead-covered cables.
7. All circuit-breakers connecting feed wires (or by-passes) to the trolley busbars should be equipped with time relays, so that any short-circuit will immediately open the trolley breakers, thus locating the trolley section grounded. Equipping the feeder breakers with time relays insures continuity of voltage on wires not affected by the short-circuit. Each trolley breaker pilot switch should be provided with a light to indicate when it opens, and an announcer bell should ring in the signal tower at the same time so that the operator is promptly notified.
8. On account of deleterious influences of weather and locomotive stack discharges, together with general inconvenience of getting at busbars and switches when installed on anchor bridges, all section oil switches should be installed in switch houses erected at the side of the tracks, with lead-covered cable connections between trolley and switches.
9. Signaling should be arranged so that the operator can prevent the engineer from spanning two sections by his loco-

motive shoes in the event of the advance section being grounded.

10. All signal towers should be interconnected with a reliable telephone service. Immunity from electromagnetic and electrostatic disturbance in the telephone system can be secured by using twisted wire pairs inclosed in lead-covered sheath, the sheath being grounded frequently. This suggestion is more particularly applicable to the interrupted or tower-to-tower telephone system. In this case the distance of exposures of the telephone wires is not great, and thus the summated effect of electromagnetic induction is negligible. In the case of the through telephone line where the circuit is uninterrupted throughout the zone of electrification, again the lead sheath and twisted pair are respectively effective in removing all static charges, and electromagnetically balancing the circuit; but on account of the cumulative action of the electromagnetic induction, either compensating transformers or a system of impedance coils (installed across the telephone circuits at intervals of two miles (this distance may be less, depending on the electromagnetic density) with their central points grounded should be used. Either method will satisfactorily remove the impressed voltage due to electromagnetic induction. The importance of reliable telephone service between operating towers cannot be too greatly emphasized.

The above-mentioned are some of the fundamental requisites which design and practice have brought out in connection with the New Haven electrification. Design and practice are many times good friends, but if a difference of opinion arises practice will, in nine times out of ten, have the better of the argument. Experience, the great teacher, has brought out either the efficacy of the original design or the proper modification of it.

The observations and recommendations above cited are those that have been impressed upon the writer during the period of operation so far attained. Except for certain minor and easily remedied details, experience to date with the New Haven arrangement of single-phase distribution would indicate that the fundamental principles involved have been correctly applied.

#### A SIMPLE DIRT CONVEYOR.

About a year ago the San Francisco Oakland & San Jose Railway at Oakland, Cal., added a 1,000-horsepower unit to its Yerba Buena power station. To accommodate the new unit it



Key Route Power Station—A Simple Conveyor for Removing Dirt.

was necessary to make a considerable excavation in order that the engine room might be extended and a basement provided. In making this excavation a considerable economy was effected by the use of the simple dirt conveyor shown in the accompanying illustration. This conveyor comprised a V-shaped trough of wood in which operated an endless chain carrying scrapers. The chain was moved by a gear wheel driven through a belt connection with a railway motor installed in a sheet steel house under the high end of the conveyor. As the dirt was excavated it was dumped into the lower end of the home-made conveyor and carried by means of the chain scrapers in the trough to a waste pile 150 feet distant and entirely clear of the power station work.

**DEPRECIATION.\***

BY C. N. DUFFY, COMPTROLLER MILWAUKEE ELECTRIC RAILWAY & LIGHT COMPANY.

The public utility law of Wisconsin provides: "Every public utility shall carry a proper and adequate depreciation account whenever the commission, after investigation, shall determine that such depreciation account can be reasonably required. The commission shall ascertain and determine what are the proper and adequate rates of depreciation of the several classes of property of each public utility. The rates shall be such as will provide the amounts required, over and above the expense of maintenance, to keep such property in a state of efficiency corresponding to the progress of the industry. Each public utility shall conform its depreciation accounts to such rates so ascertained and determined by the commission. The commission may make changes in such rates of depreciation from time to time as it may find to be necessary."

What is "depreciation"? Webster's dictionary defines depreciation as: (1) The act of lessening, or seeking to lessen, price, value or reputation. (2) The falling of value; reduction of worth. (3) The state of being depreciated.

For the purposes of this paper depreciation will be defined as a "lessening of value," and the treatment of the subject confined to broad general questions, briefly touched upon, as applicable to the electric lighting business.

This "lessening of value" may be brought about, in so far as the physical property is concerned, from the following causes: (1) Deterioration due to the ravages of time and the effects of the elements. (2) Wear and tear incident to use. (3) Displacement by reason of obsolescence or supersession, resulting from the development of the art or the evolution of the business.

**Deterioration.**

Unquestionably the ravages of time and the effects of the elements will eventually cause physical property to deteriorate or disintegrate to such an extent as to render it valueless and unfit for use. From this there is no escape; it is as certain to come as the rising and setting of the sun, therefore it must be reckoned with in considering "lessening of value."

**Wear and Tear.**

"Wear and tear" of physical property resulting from use, sooner or later, in spite of "maintenance," unless maintenance is understood to include replacements and renewals, as well as repairs, will be followed by the "state of being depreciated," that imperceptible deterioration constantly going on, in addition to wear and tear incident to use. This will ultimately necessitate "replacements and renewals," the throwing away of the old and the installation of new, as a condition will be reached when "repairs" are no longer possible. In its relation to depreciation the whole question of maintenance, whether understood to cover "replacements and renewals," large or small, or restricted only to "repairs," is a most important factor for consideration. The measure and extent of depreciation of physical property are dependent, in so far as "wear and tear incident to use" is concerned, on the amount of "maintenance" expended in the physical upkeep of the property. This must be taken into account in providing for "lessening of value."

**Displacement.**

The "displacement" of physical property rendered obsolete because of the development of the art or the evolution of the business is a contingency that must be recognized and provided for.

Let us look backward, for a few years only, if you please, and consider the marvelous changes that have taken place in the types of generating station apparatus. The high-speed direct-belted units adopted as standards in early days in central station installations, notably New York Edison Company and Philadelphia Edison Company, were superseded by slow-speed multipolar generators, direct belted to Corliss engines. These in turn were superseded by generators direct connected to either horizontal or vertical engines, generating low potential direct current. The introduction of steam turbines developed high-speed alternating generators direct connected to turbines, supplanting all other types of generating apparatus and recognized as the standard of today. This standard of today may be superseded by the gas engine, as engineers recognize the possibilities of that prime mover supplanting all that have preceded it. Nor has the development of the art been confined to changes in types of generating station apparatus. For instance, open arc lamps have been superseded by inclosed arc

lamps and various other changes and improvements have been introduced and developed.

The evolution of the business, with respect not only to the extent but to the varying character of the demands made for service, and likely to be made in the future, in this rapid age, is a feature that adds to the complications of the question, a feature most difficult indeed to forecast or provide for, and a most important element to consider in dealing with "displacement."

Mr. Gibbs, an eminent engineer who needs no introduction to this audience, in the case of "The People of the State of New York ex rel. the Third Avenue Railroad Company against State Board of Tax Commissioners," testifying as to radical changes that may be expected in the type of property requisite to the successful operation of electric railways of the future, said: "I never yet did a piece of work that extended over any considerable time but that when I got it done it was rather antiquated and had to be done over again; it is a new science."

Is anyone so bold as to say that the possibilities of the development, of the art or the evolution of the business, as applicable to an electric lighting system, have been reached? This must be dealt with in covering "lessening of value."

**Determination of the Measure of Depreciation to be Provided For.**

It is a difficult matter to lay down a fixed rule that will determine the measure of depreciation to be provided for and cover in a practical and satisfactory manner differences in conditions and the various factors to be considered.

The different types of apparatus installed and the methods of construction and installation followed, as well as the varying conditions surrounding the operation of different systems, make the problem an exceedingly hard one to solve, even if confined only to providing for depreciation resulting from the effects of "deterioration" and "wear and tear," independent of "obsolescence" or "supersession."

The determination of the measure of depreciation necessary to provide, by reason of "deterioration" and "wear and tear," can possibly, with some degree of accuracy and satisfaction, be arrived at; the effects of obsolescence and supersession, practically unknown quantities, judging by the history of the past, present a most complex question of the greatest importance and most far-reaching in its consequences.

The most correct and sound method to pursue would be to arrive at the estimated average life of the different kinds of physical property dealt with, determining this life on the basis of type, methods of construction and installation, as well as the character and extent of its use and the conditions under which it is used; climatic conditions, the character of the soil, as well as other similar factors, should be taken into consideration in arriving at this determination of average life. For example, the conditions of soil and climate would materially affect the life of pole lines, whether the poles were iron or wood, and likewise buildings, especially if of frame construction. Temperature and weather conditions have a direct bearing on the life of feeders, if exposed to the elements. The kind of water used for the generation of steam is an important element to be considered in determining the life of boiler tubes, and the same is true with reference to boiler furnaces, as to the effects of different kinds of coal burned. Conditions of operation with respect to the generation of electric current are reflected to a very considerable extent by the fluctuating load on the station, as well as the average load factor.

These varying conditions, as pointed out, should be taken into account, in addition to the consideration of the question of types of apparatus, methods of construction and installation, etc., previously referred to.

The different kinds of physical property of an electric lighting system to be dealt with, in considering "depreciation," may be broadly classified as follows: (1) Buildings and fixtures. (2) Generating station equipment. (3) Transmission system. (4) Substation equipment. (5) Distribution system. (6) Transformer installation. (7) Meter installation. (8) Lamp installation. (9) Tools and appliances. (10) Miscellaneous equipment.

**Application of the Measure of Depreciation to be Provided for, as Finally Determined.**

The measure of "depreciation" to be provided for, as finally determined on the basis previously outlined and suggested, reduced to or expressed in dollars and cents, worked out in detail for each class of physical property, on the kilowatt-hour unit, should be taken up in the accounts monthly. This may be done, as a matter of detail, by one of the following methods:

(1) "Operating expenses," in the appropriate accounts, should be debited and "depreciation reserve" credited, with

\*Abstract of an address before the convention of the Northwestern Electrical Association, Milwaukee, Wis., January 15 and 16, 1908.

the monthly proportion of the total annual depreciation charge, based on the kilowatt-hour unit cost.

(2) The monthly proportion of the total annual depreciation charge, based on the kilowatt-hour unit cost, could be treated as a deduction from "net earnings from operation," and the amount so deducted credited to "depreciation reserve."

(3) The monthly proportion of the total annual depreciation charge, regardless of what the charge may be, based on the kilowatt-hour unit cost, could be treated as a deduction from "net earnings from operation," based on the percentage said charge is of the estimated gross earnings for the year, and the amount so deducted credited to "depreciation reserve."

If the "depreciation reserve," so created, is to be something more than a mere "hookkeeping" reserve, and the amounts thus set aside actually invested in interest-bearing securities, the interest earned on such securities should be credited to "depreciation reserve."

It should be understood, of course, that when replacements and renewals of physical property are made, the cost should be charged against "depreciation reserve."

If the first method suggested is followed, the depreciation charge should be specifically stated and shown in the appropriate operating expense accounts. If this is not done there will be no way of showing ordinary maintenance charges separate and distinct from depreciation charges, and operating expenses will not clearly show actual results. Unquestionably the first method proposed is more scientific than the second or third, but the two latter will be found easier to work out and apply. Either of the three suggested will accomplish the same results, ascertaining what the "net income" is, applicable to "return on investment." The "measure of depreciation to be provided for" is the vital question; the method of its application, if sound and correct, is of secondary importance.

The Milwaukee Electric Railway & Light Company has, since January 1, 1898, down to the present date, followed the third method suggested. John I. Beggs, president and general manager of our company, is a pioneer in recognizing and providing for "depreciation." He not only had the wisdom and foresight 10 years ago to recognize "depreciation," but the courage of his convictions, in the administration of our property, to carry out the policy of providing for it in our accounts and finances.

#### Amortization.

In addition to providing for "depreciation," as previously defined and treated, provision should be made for a shrinkage in the value of the physical property, if, through necessity, it is disposed of as junk or scrap, at the expiration of limited term franchises. The amortization of capital liabilities, for which there may be no tangible assets, should also be provided for, or sufficient "return on investment" be assured, to justify capital assuming the risks attendant on the business.

"Depreciation" and "amortization" must be reckoned with in determining the cost of furnishing electric current, together with interest on investment, as well as the cost of generation and regeneration, the cost of distribution, the general expenses incident to the conduct of the business and taxes. Indeed, to this cost should be added adequate charges to cover reserves for unliquidated damage claims and provision for contingencies before the true cost of electric current, delivered to the consumer, can be fully and absolutely determined.

The subtraction of ordinary or current "operating expenses" and "taxes" from "gross earnings" does not represent "net earnings," available either for interest on bonds or dividends on stock.

It is high time that the electric lighting interests of the country awakened to the full realization of this fact.

The report of the twenty-sixth annual convention of the American Street and Interurban Railway Association is ready for distribution from the office of Secretary Swenson. This report comprises 408 pages, 6 by 9 inches, printed on heavy paper. Its style follows that of former reports. An excellent portrait engraving of President John I. Beggs appears as the frontispiece. Included in the report are lists of present and past officers of the association, registration at the Atlantic City convention, addresses, annual reports and papers presented at the last meeting and also a list of the member companies and associate members of the American association. An important part of the annual volume is the summary index of previous reports, which includes a carefully made compilation of the papers read and discussed before earlier meetings, exhibiting for each the year and the number of the page on which the article appeared in the earlier volume.

## MEETING OF THE INSTITUTE OF ELECTRICAL ENGINEERS—CATENARY SECTIONALIZATION AND SINGLE-PHASE RAILWAY MOTOR.

The two hundred and twenty-fourth meeting of the American Institute of Electrical Engineers was held at the Engineering building, New York City, on January 10.

W. S. Murray, electrical engineer of the New York New Haven & Hartford, read a paper on "The New Haven System of Single-Phase Distribution with Special Reference to Sectionalization." This paper will be found elsewhere. Preceding the reading of the printed paper Mr. Murray stated that it was his intention to deal with experience rather than with theory. Referring to the electrical and mechanical specifications, he said that several snow, ice and wind storms and combinations of these had demonstrated that the iron structures, messenger, trolley and feeder wires had been designed with adequate factors of safety for weather conditions.

Mr. Murray stated that a discussion of double or single catenary construction on main line electrification had been intentionally omitted from his paper. A choice of one or the other must be a compromise of a great many considerations, the principal ones being the number of tracks to be electrified and local conditions, but there had been conclusively demonstrated to him the fact that either the trolley wire or the trolley shoe must be flexible whether the construction be for main or branch lines. In the single catenary construction a flexible contact conductor is provided, whereas in the triangular construction the contact conductor is rigid, requiring a flexible shoe which is in a degree secured by the spring pantagraph arrangement. Experience had shown the speaker that the pantagraph collector must be supplemented by a light but strong mechanism, which would insure flexible contact between the shoe and trolley wire.

#### Single-Phase Railway Motor.

E. F. Alexanderson read a paper entitled "A Single-Phase Railway Motor," an abstract of which appears elsewhere.

L. B. Stillwell, consulting engineer, opened the general discussion calling attention to the importance of the announcement of a new motor and in particular a single-phase alternating-current motor, possessing apparently the feature of marked originality and practical value in the elimination of the idle resistance in the armature winding.

#### The Choice of Frequency.

Mr. Stillwell then reviewed briefly the discussion at the two hundred and thirteenth meeting of the institute in connection with the paper presented by H. S. Putnam and himself on "The Substitution of the Electric Motor for the Steam Locomotive" (Electric Railway Review, February 2, 1907, pages 150 to 160) relative to the matter of frequency and to his written conclusions at that time that the increase in cost of power house equipment consequent upon a reduction in frequency to 15 cycles is more than offset by the reduction in the cost of electrical equipment of rolling stock. In this connection he called attention to the fact that little was said in Mr. Alexanderson's paper relative to the performance of the new motor at frequencies lower than 25 cycles per second beyond the statement that it "is equally well applicable to 15 or 25 cycles," and that "it can, therefore, be stated in general that 25 cycles is entirely satisfactory for all geared motor work; it is preferable in that the combination of motor and transformer weighs less at 25 than at 15 cycles."

He said that it was obvious that commutation would be improved at 15 cycles and that there was no reason to believe why this improvement expressed in percentage should not be as great in the case of this motor as in that of the series-compensated motor. He thought one of the principal advantages of the lower frequency had been entirely ignored. The relative aggregate weight of motor and transformer un-

questionably was important and particularly so in multiple-unit work, but much more important, at least in the field of heavy electric traction, was the power of the motor that could be placed in a given space on a truck. The factor of cost, Mr. Stillwell said, was also against the 25-cycle motor, and as far as he was able to judge from the facts given the new motor would gain as much in the ratio of output to weight at a given speed by the reduction of frequency from 25 to 15 cycles, as would the series-compensated motor. He found nothing in the paper to indicate that the motor was an exception to the general rule that alternating-current motors will gain approximately 30 per cent in torque and will also gain materially in sustained power by reduction of frequency from 25 to 15 cycles per second.

#### Discussion by B. G. Lamme.

A discussion of Mr. Alexanderson's paper by B. G. Lamme (Westinghouse Electric & Manufacturing Company) was read by F. H. Shepard. The following is an abstract of Mr. Lamme's discussion:

It is intimated that this motor accomplishes what the series-compensated motor cannot do, and it appears to be that successful commutation of alternating current has at last been obtained.

I am free to state that I do not see that this motor does or can accomplish more than has already been accomplished successfully by a properly designed series-compensated motor.

Considering first the starting conditions and characteristics, the general scheme of starting is based on the use of a relatively weak field at start, the field induction being increased, for the same torque, after sufficient speed has been obtained to make the commutating poles effective. The object of this relatively weaker field at start is to lower the voltage in the coils short-circuited by the brushes.

Referring to the commutating motor in general the author admits that it is either necessary to keep below a critical voltage or to use resistance leads. This is the parting of the ways. Apparently the author does not believe that preventive leads, or resistance leads as he calls them, permit sufficient increase in the short-circuit voltage to represent any great gain in the operation.

To take up the question of the currents flowing in the armature windings of single-phase commutator motors, two currents should be considered: First, the working current which is fed into the brush and which passes in through the commutator bars through the connections or leads into the main armature winding. Second, a local or short-circuit current which passes from the short-circuited coil out through the lead, or connection to one commutator bar, then through the brush to the adjacent bar and back through the lead to the coil. This local current is dependent upon the voltage generated in the short-circuited coil and upon the resistance in the closed circuit. If the local current could be limited to values approximately the same as the working current in the coils, then it could be taken care of very readily by the ordinary resistance of the brush, brush contact, etc., but, unfortunately, a short-circuit voltage low enough to give this condition would give absurd proportions in the motor.

In order to obtain a reasonable capacity from these single-phase motors it is necessary to work at an induction giving a short-circuit voltage so high that this local current would usually be many times greater than the normal working current in the coils. It is for this purpose of reducing this short-circuit current to a more moderate value that preventive leads are added. It has been assumed that the addition of these leads means an increase in loss. However, as the purpose of the leads is to actually reduce the excessive local current, the result is a very considerable decrease in loss by the use of the leads.

With the high normal induction per pole on the New Haven motors, our tests have shown that it was utterly impracticable to start with normal induction in the field without preventive leads in the armature, for the short-circuit or local current was excessive and caused vicious and destructive sparking.

The total current to be handled by the brushes and commutator in the compensated-series motor would be approximately one-third that which would be required if the scheme described in the paper were used. It is evident that in order to accommodate the starting conditions the normal induction must be sacrificed somewhat, and with the highest permissible field at start the normal induction would be considerably lower than if preventive leads were used.

There is also indicated clearly the disadvantage of trying

to improve the condition by the use of high resistance brushes. Necessarily the life of such brushes would be considerably shortened by the excessive currents.

This method of considering the current flowing in the armature shows very clearly why 15 cycles is decidedly more advantageous than 25 cycles in the alternating-current commutating motor. As the short-circuit voltage is a direct function of the frequency, as well as of the induction, it is evident that with the same limiting short-circuit voltage the induction could be increased in the ratio of 25 to 15, or 66 per cent. It is evident, therefore, that the limit of induction at start is thus raised enormously. In practice, however, unless the motor is worked at extremely low saturation we cannot get the full gain of 66 per cent either at start or at speed, for in order to obtain the greatest economy in weight and in dimensions we could naturally work the material at as high saturation as permissible and in practice we could get only about 30 per cent gain. As we could work 66 per cent higher with the same short-circuit voltage this increase of only 30 per cent means that our short-circuit voltage is thus less than 80 per cent of that of the 25-cycle motor of corresponding design.

It is intimated in this paper that even if the losses were excessive in the armature winding at start yet the quick starting and acceleration would greatly reduce the danger from this source. This may be true of small equipments where light torques are required and where quick acceleration is always possible. However, for heavy work there are occasions where it is necessary to start very slowly and run at a slow speed for a considerable time.

#### Tests of Heavy Locomotive.

I will cite some of the tests which were made with the locomotive equipped with two 500-horsepower motors which were exhibited at Atlantic City at the street railway convention last October. This machine was given some very severe tests last summer at East Pittsburg in the presence of prominent railroad engineers. For example, in some of these tests the locomotive was operated for five minutes at speeds of two to three miles per hour and this while exerting more than double torque. This represents less than one-tenth the normal or rated speed of the motor. This motor was also held at standstill for a considerable period, developing excessive torques in attempting to start trains with brakes set. Under this condition a motor without preventive leads would unquestionably have been ruined. This condition of the motors at standstill with a heavy current flowing is particularly liable to be met with in freight service, especially if two or more locomotives are working independently with a very heavy train.

Under the selection of frequency it is stated broadly, but without argument, that there is little or no field for the 15-cycle motor. The only basis for this statement apparent is that good commutation is now possible at 25 cycles. In the discussion of the paper by Messrs. Stillwell and Putnam last January it was not a question of commutation which was advanced as the reason for the adoption of 15 cycles, for it was stated plainly that 25-cycle motors could be made to commute well. But it was the greatly increased output in a given space which was given as the principal reason for the adoption of the lower frequency. I see absolutely nothing in this paper to change that conclusion.

If the commutation at speed were the only limit in the 25-cycle motor then it would be correct to say that with this limit raised sufficiently there would be no necessity for the lower frequency, but as the present limits in design of large 25-cycle motors lie in the excitation permissible with good power factor and in the short-circuit voltage at start it does not seem to me that the problem is solved by simply applying a different method of obtaining commutation when running. The real limits which affect capacity still remain and I do not see wherein the motor described this evening changes the broad problem in any way.

#### Remarks of W. B. Potter.

Speaking of Mr. Murray's paper, W. B. Potter (General Electric Company) said in part:

The ordinary 600-volt trolley has been little criterion for the 11,000-volt catenary under steam railroad conditions. Considered as an example of good construction work, I have never seen the equal of the catenary line to which he has referred. As to the relative reliability of such an overhead high-voltage trolley as compared to a third rail under conditions necessitating joint operation with steam, I believe this to be a debatable question. The experience thus far appears to me rather in favor of the third rail.

As to the points noted by Mr. Murray:

First—I agree with him as to the desirability of a through feeder in parallel with the different sections. I do not see

the need, however, of two such feeders on the same phase as the trolley wires.

Second—As to the length of the main line sections, I should favor three to five miles rather than less. This is a question affecting reliability of operation and it would seem that a reduction in the number of switching appliances would be favorable in this regard. Five-mile sections have proved satisfactory in third-rail operation and there would seem to be no reason for shorter sections with the high-voltage trolley unless by reason of greater liability to breakdown. It would seem desirable, however, that at track crossovers there should be a short section controlling the main line and crossover tracks, to better insure crossover movements in the event of interruption on the main line sections.

Third—Twenty-two feet seems to be a generally recognized standard height for the trolley wire. It is unfortunate that this height cannot be maintained throughout, as it would then be possible to use a much lighter form of pantagraph.

Fourth—Depreciation of the catenary insulation, due to smoke from the steam locomotive, would naturally be expected. The measure of trouble from this cause would seem to have a bearing on the permissible trolley voltage. Conditions might well arise where copper or efficiency would have to be sacrificed for reliability.

Sixth—So far as it can be avoided, I do not think that overhead wires subject to lightning should be run through lead cables.

Seventh and Eighth—The suggestion with regard to time relays and switch indication are in line with well-established practice. As to the method of operating the circuit-breakers, I understand they are at present controlled from the main power circuit. Should not some means be provided for operating these switches in the event of failure of power? Lever connection would provide certainty of operation and would not interfere with the automatic tripping.

Ninth—While there is no question as to the desirability of guarding against spanning two sections in the event of one of them being grounded if two pantagraphs or trolley poles are far enough apart to span the section insulator it is as sure to happen as that grounds will occur. The only safeguard seems to be a fuse between the two collectors.

#### Single-Phase Motor for Locomotives.

The single-phase motor described by Mr. Alexanderson possesses a number of novel features, but the essence of the improvement is the better inherent commutation. By reason of this it is possible to modify other features affecting the performance of the motors which have heretofore been subordinate to commutation, with the natural result of greater reliability, decreased maintenance and greater capacity output for a given amount of active material.

It is very desirable that the motor equipment of a motor car should be able to develop sufficient torque to slip the driving wheels, and for an electric locomotive this is particularly true.

An electric locomotive is essentially a draft horse and its value as such should be proportional to the weight on the drivers. In whatever degree the drawbar pull is limited by the motors to that extent is the useful cost of the locomotive increased. In the handling of any service sufficient drawbar pull to start a train is absolutely essential, the horsepower rating for maintaining the schedule being subordinate and depending upon the degree of continuous service. On this point as affecting reliability the motors are liable to injury from overload unless the limitation is slipping the wheels rather than commutation or current capacity.

With any probable design of motor car or locomotive the geared series-repulsion motor will be able to slip the wheels even if geared for maximum speeds as high as 75 miles an hour. In the light of our present knowledge the problem is rather more difficult with the gearless series-repulsion motor.

#### Single-Phase Motor.

In discussing Mr. Alexanderson's paper, W. I. Slichter said in part:

In explaining the motor it is necessary to consider the conditions of starting and running separately, as certain features are introduced simply to assist in starting and other features are employed only to function when running.

In the motor under discussion the compensating or inducing winding and its inductive relation to the armature turns are made to act as a series transformer. Under running conditions we find in this motor three very important new features contributing to good operation:

First—The proper field strength at all speeds, as just mentioned.

Second—By means of the fractional pitch in the armature the coil undergoing commutation is placed in a position under the pole piece where it is very strongly influenced by any magneto-motive force in the compensating winding so that the latter winding is able to act as a commutating pole in the true sense of the word as well as a compensating winding.

Third—The compensating winding is made to carry two components of current, a series and a shunt (or repulsion motor) current, and it may be likened to a commutating pole having two coils—the one a series coil serving very effectively, due to the favorable position of the coil undergoing commutation (brought about by the fractional pitch) to produce the good effects on commutation that a commutating pole does in a direct-current motor. In other words, to correct for the harmful electromotive forces of self-induction and armature reaction.

One of the immediate results of the development of this motor is the fact that it makes the need of 15 cycles for a single-phase railway work a great deal less important than with either the plain repulsion or the plain series motor.

#### Sectionalizing for Single Tracks.

In speaking of Mr. Murray's paper, O. S. Lyford, Jr., thought that the standpoint of single-track operation had been overlooked. Referring to sectionalization he said there were three objects: First, to minimize the interference with the operation of the road in case of line trouble; second, to locate the fault quickly; and, third, to reach the fault with the work train. He thought that in order to reach a fault the work train should be operated by an independent unit, either a steam locomotive or a gasoline car, preferably the latter, because it was more easily put into service.

Dr. C. P. Steinmetz called attention to the fact that in the discussion of Mr. Alexanderson's work the investigation of the distribution of the magnetic field had not been considered.

Before replying to the comments upon his paper, W. S. Murray made a few remarks regarding the paper presented by Mr. Alexanderson. There was a question whether heavy induction with resistance leads was better than light induction without resistance leads. Any opinion should be held in reservation until practical results had demonstrated which of the theories was correct. He called attention to the changes in high-power electric locomotives of gearless construction, also to the high ratio in this construction of weight on drivers to tractive effort developed. In consequence of this unfortunate relation of the entire electric locomotive weight being on drivers, it was impossible to design the motor equipment of sufficient capacity to slip the wheels of the locomotive, and as the transference action was a maximum at starting unless the locomotive engineer shut off power promptly upon finding the locomotive incapable of moving its trailing load the resistance leads would burn out.

The feature of producing double torque by short-circuiting the armature and without increasing the line current was a characteristic that lent itself in much value to traction necessities. He thought it would be of interest to know what change of relation took place between time and temperature of the motor when developing double torque. Another feature of interest would be knowledge as to the weight per axle horsepower (1-hour rating) with direct-current motors of the same size.

Speaking of the points brought up in connection with his own paper, Mr. Murray said he thought that on long-distance traction work the question of operating expenses would be the paramount feature and hold the overhead construction and alternating-current transmission to the motor a necessity. He believed Mr. Potter's suggestion that the sections be longer a wise one, and that from three to five miles would become the standard. He agreed with Mr. Lyford's remarks about single-track feeder arrangement, but would qualify them for longer distances. In its application to long distances he believed a feeder arrangement for single track would be quite necessary.

**CO-OPERATION BETWEEN INTERSTATE COMMERCE COMMISSION AND STATE COMMISSIONS ON UNIFORM ACCOUNTS.**

The interstate commerce commission gives, in its report for 1907, a synopsis of replies of state railway commissions to its letter of November 13, 1907, asking for an expression of opinion as to the desirability of accounts for electric railways being in substantial agreement with those already prescribed by the interstate commerce commission for steam roads. In introducing these replies the commission says:

The desire to provide a uniform system of accounts for all transportation agencies, coupled with the fact of divided jurisdiction, has forced the question of co-operation between federal and state commissions into the foreground as a question of practical administration. As an extreme illustration, mention may be made of the manner in which an accounting system for electric urban and interurban lines is being worked out. According to the test of location of the physical property (which, of course, is not the final test), not more than 20 per cent of this class of railways comes within the jurisdiction of the federal commission, an amount not sufficient to warrant this commission in prescribing a system of accounts in conformity with that prescribed for other transportation agencies, except upon the approval and co-operation of the various states whose laws give to their respective commissions jurisdiction over the operation of electric lines. Such approval and co-operation have been readily granted. A conference was recently held for the consideration of this entire subject, and so significant is the attitude of the states, as expressed in letters in response to a request for an expression of opinion as to the feasibility of co-operation, that a condensed statement of the replies is here submitted.

**Replies of State Commissions.**

- Alabama.—Will co-operate with interstate commerce commission to the fullest extent practicable.
- Arizona.—Has no railroad commission.
- Arkansas.—Uniformity between electric and steam railway accounts very desirable. Will co-operate with interstate commerce commission to any reasonable limit.
- California.—No reply to letter.
- Colorado.—Uniformity between electric and steam accounts desirable. Will assist interstate commerce commission as far as possible.
- Connecticut.—Uniformity between electric and steam accounts necessary. Will co-operate with interstate commerce commission to that end.
- Delaware.—Has no railroad commission.
- Florida.—Action of interstate commerce commission will be satisfactory.
- Georgia.—Approves idea for uniform classification of accounts between steam and electric roads.
- Idaho.—Has no railroad commission.
- Illinois.—Will co-operate with interstate commerce commission as far as possible. Electric and steam accounts should be in substantial agreement.
- Indiana.—Entirely willing to abide by result of conference, and will co-operate with interstate commerce commission.
- Iowa.—No objection to classification submitted by interstate commerce commission.
- Kansas.—Classification submitted by interstate commerce commission thoroughly applicable to Kansas conditions.
- Kentucky.—Will heartily co-operate with interstate commerce commission. (Verbal statement of chairman of commission.)
- Louisiana.—No jurisdiction; but, should occasion require, will accept recommendations of interstate commerce commission.
- Maine.—Classification proposed by interstate commerce commission great improvement over present system.
- Maryland.—Has no railroad commission.
- Massachusetts.—Waiting action of interstate commerce commission on system of accounts. Will act in accord with interstate commerce commission as far as possible.
- Michigan.—Have perfect confidence in judgment of interstate commerce commission and will heartily co-operate.
- Mississippi.—No reply to letter. Probably has no jurisdiction.
- Missouri.—Will adopt system of accounting recommended by interstate commerce commission.
- Montana.—Will be pleased to co-operate with interstate commerce commission and use forms prescribed by the commission.
- Minnesota.—Will cordially indorse system approved by interstate commerce commission.
- Nebraska.—In hearty sympathy with interstate commerce

- commission. Steam and electric accounts should be uniform.
- Nevada.—No reply to letter.
- New Hampshire.—Will adopt system of accounts used by adjoining states and interstate commerce commission.
- New Jersey.—Approves system of uniform accounts recommended by conference. Has no jurisdiction over trolley lines.
- New Mexico.—Has no railroad commission.
- New York, first.—Was represented at conference and will probably co-operate with interstate commerce commission.
- New York, second.—Will adopt system of accounts prescribed by interstate commerce commission, as far as possible.
- North Carolina.—Approves classification prepared by interstate commerce commission, and will adopt same for North Carolina.
- North Dakota.—Will be pleased to co-operate with interstate commerce commission.
- Ohio.—Will co-operate with interstate commerce commission as far as possible.
- Oklahoma.—Railroad commission not appointed at date of letter.
- Oregon.—Steam and electric roads should have same system of accounts. Will co-operate with interstate commerce commission.
- Pennsylvania.—Railroad commission to be appointed January 1, 1908.
- Rhode Island.—Did not receive letter; probably misdirected.
- South Carolina.—No jurisdiction over electric railways.
- South Dakota.—No jurisdiction over electric railways.
- Tennessee.—No jurisdiction over electric railways.
- Texas.—No jurisdiction over electric railways.
- Utah.—Has no railroad commission.
- Vermont.—Will probably adopt form of accounts prescribed by interstate commerce commission.
- Virginia.—Steam and electric accounts should be uniform. Will adopt system recommended by conference.
- Washington.—Classification proposed by interstate commerce commission meets all requirements of the state.
- West Virginia.—Has no railroad commission.
- Wisconsin.—Will co-operate with interstate commerce commission. Steam and electric accounts should be uniform.
- Wyoming.—Has no railroad commission.
- It is evident from the above that the states are not only willing, but anxious, that the federal commission should assume the responsibility of prescribing a uniform system of accounts for electric lines, and offer not only co-operation for the attainment of this result, but agree, so far as practicable in view of local requirements, to accept whatever rules and classifications may be promulgated.
- The proposed accounting system for electric railways will be issued to take effect on July 1, 1908. Concerning the system prescribed for steam railways, the commission says:
- For the completion of a general system of accounts, authoritative rules relative to the financial accounts must be issued. This involves a classification of the debit and credit items that appear on the income account, and a classification of the assets and liabilities that appear on the balance sheet. The analysis of these accounts is well under way, and when completed appropriate rules will be promulgated under order of the commission, to take effect July 1, 1908. The commission interprets the twentieth section of the act to regulate commerce as imposing upon it the duty of protecting the integrity of the net revenue statements published by the carriers, and it believes that formal depreciation charges, conservatively administered, are essential for the attainment of this end. If this can be done through supervision over the operating accounts, and if, through the medium of a standard balance sheet, the commission is able to protect also the integrity of statements rendered by the carriers relative to their accumulated surplus, the most important single purpose of congress in conferring upon this commission authority to prescribe and supervise a uniform system of railway accounts will have been accomplished.
- Every warrant covering revenue, every voucher covering expenses, every entry of an asset or a liability, must be carried into the accounts according to prescribed rules, and it is certainly a step in advance, because it is a means of localizing responsibility, that the commission should select from among the officials of each of the carriers one whose duty it is to certify to the legality of the acts which the accounts record.

**Attitude of Pennsylvania Association.**

Charles H. Smith of Lebanon, Pa., secretary of the newly organized Pennsylvania Street Railway Association, refers to the uniform accounting system in a circular letter issued on

January 10 urging companies in Pennsylvania to join the organization. Mr. Smith refers to the fundamental principles laid down by the interstate commerce commission as follows:

That the form of accounts to be used by electric carriers must conform as closely as possible to the form prescribed for the steam carriers, and must be fully analyzed; that compensation or rentals for joint facilities must be accounted for in detail; that compensation for power purchased or sold must be accounted for in detail; that depreciation must be recognized and accounted for.

"These, if enforced," Mr. Smith adds, "would impose grave burdens on the companies, and we should all unite to present our side of the case to the commission; this can be better done by an association speaking for the whole industry working on broad lines rather than by each company voicing its own views. The working of the commission, unless it is properly advised by the companies, will undoubtedly result in the imposing of burdens which will reduce earnings in many cases to the vanishing point."

#### THE PUBLIC'S DEBT TO THE PUBLIC SERVICE CORPORATION.\*

BY W. R. PUTNAM, MANAGER RED WING GAS LIGHT & POWER COMPANY, RED WING, MINN.

The American people are often characterized as an overgrown child and from this point of view it is interesting to observe the present changes in the economic ideas and conditions of our country. Our business has grown and developed so rapidly that the men actually engaged in its management have with difficulty invented and applied new methods and larger schemes for the handling of its now immense and constantly growing volume and much less have our legislative bodies been able to devise proper means for the control of the corporations, large and small, which have been the outgrowth of the new condition.

In the past few years the people's representatives in their various legislative bodies have attacked this problem with a determination to solve it; but, unfortunately for the general business world as well as for the private investor in many of the corporate securities, their aim has been to secure action; to pass legislation of only a few weeks or months consideration, whose object is to regulate systems of transacting business which have taken years to develop. What has proved more disturbing to security values has been the oftentimes apparent object to pass one-sided legislation; that is, legislation which will please and appease the body politic without taking into consideration the interests of the capital involved.

The public service corporation has been given its amount of attention in the legislative attempts at corporation regulation; its obligations to the public have all been prominently brought to the notice of the people, without, however, in most instances, any attention being called to obligations that might be due the corporation. It would seem proper, at this time, to point out in what ways these corporations have benefited the people and what the people owe them in return.

Some of our public utilities have been serving the people less than a quarter of a century. The public, through its official representatives, has granted to organizations of capital permission to occupy portions of the streets of the municipality for the purpose of furnishing it and its inhabitants light, heat, power, water, the quick methods of communication and transportation. For the most part these franchises, when first given, were so granted because the people were as eager or more so to have the service as capital was willing to supply it. Such being the condition the larger portion of the franchises did not contain provisions which properly safeguarded the rights of either party interested; with the result that there has been almost constant wrangling between both parties involved over some or all of the questions of service, rates, taxes, and various rights covered by the franchise.

Meanwhile the communities supplied have been rapidly growing in population and oftentimes in area and the people's desire for all of these conveniences and necessities has even more rapidly grown; for the most part the franchise owner has kept pace with this growth, by the investment of immense sums of money in both the manufacturing and distributing departments of his plant. At the same time he has been obliged to keep up with the rapid improvement of appliances by the replacing, oftentimes again and again, of obsolete machinery. This has been done, it is true, with the purpose of en-

hancing the value of the property and of securing a fair return on the investment; at the same time it has been done in response to the people's demand.

Unfortunately and possibly because of the apparent ease with which funds have been secured for the immense development of our plants, the public have become firmly convinced that, of necessity, there must be immense profits in our business; they have not studied the question thoroughly or they would have soon learned that, for every dollar we receive in gross earnings each year, we have from three to ten dollars invested in our business; in other words from 20 to 50, or in some cases 60, per cent of our total receipts, the amount depending upon the nature and condition of the particular kind of service, must be used to pay interest on our investment; that the majority of our investment is represented by bonds earning five or six per cent; that the United States census returns show that the net earnings of all gas and electric plants in this country, before providing a depreciation fund and before paying interest charges, are only 8 per cent on the capital invested; while the similar earnings of the street railway companies are only 5 per cent.

The public has taken it for granted that it has been unfairly and in some cases dishonestly dealt with by the owners of franchises and, now that it has wakened to the possibilities of regulation, it not only insists on a regulation which will give the public immensely cheaper service but which will at the same time penalize the franchise owner for his unfair and dishonest acts of the past; wherever this unfairness and dishonesty have existed has not the public been as much to blame as the franchise owner, in that it has elected men to office who have been the means of this unfairness and dishonesty? The public service manager is human and if he ascertains that the only way he can secure legislation or even a permit, necessary for the carrying on of his business, is by dealing dishonestly with a dishonest representative of the people, too often, in the past, has he followed the line of least resistance. Should not the people's fairness accede to eliminating entirely, from the subject of regulation, the question of penalty?

Again the public must awaken to the fact that the business management of the public service corporation is today more alive and more progressive than that of almost any other line of business.

The two largest associations of public utility corporations in this country have both gone on record as strongly in favor of reasonable regulation by the people. If the people will come to a realization of the immense good they derive from our service; will give us credit for new attempts to conduct our business honestly; will drop all ideas of penalty; will concede that our efforts to develop our business are entitled to a fair return; will drop the tendency to regulate rates by competition; and will approach the subject in a fair, conservative way; then, and only then, will regulation be secured which will establish, with the investor, the feeling of security necessary for the further enlargement of our business.

#### Improvements at Mobile During 1907.

The Mobile Light & Railroad Company, Mobile, Ala., has made a number of substantial improvements to its property and equipment during the past year, the most important of which is a new power house which is now nearing completion. New boiler equipment has been added and a 1,200-kilowatt General Electric Railway generator and an 1,800-horsepower Allis-Chalmers engine have been installed. A telfer system for handling coal from the cars to the overhead bunkers has also been erected. Eight miles of track have been laid with 70, 80 and 90 pound rails and 12 new cars have been purchased. Six of these are 40-foot double-truck cars and six are single-truck cars of the semi-convertible type. Several new features were added during the year at Monroe Park and more are contemplated for the coming season.

The New York public service commission of the second district has approved plans for a hydro-electric power plant on the Sacandaga river, including a storage dam, power dam and power plant, and in addition electric transmission lines to Saratoga, Ballston, Mechanicville, Troy, Albany, Watervliet, Schenectady and Amsterdam, to be built by the Hudson River Electric Power Company. The approval is conditioned on the state having authority to buy the proposed storage dam near Conklingville, N. Y., within 3½ years at the actual cost to the company, and also on the company filing with the commission statements as to the manner and proceeds of the sale of the \$2,000,000 of bonds authorized by the commission, and also detailed half-yearly statements of the expenditure of the proceeds of the sale of the bonds.

\*Abstract of paper read before the Northwestern Electrical Association, Milwaukee, Wis., January 15, 1907.



## RECENT ELECTRIC RAILWAY LEGAL DECISIONS.

BY J. L. ROSENBERGER, LL. B., OF THE CHICAGO BAR.

## Risk from Use of Derrick to Remove Motors Assumed.

*Raven v. Seattle Electric Company*, 92 Pacific Reporter, 451.—The supreme court of Washington says that the plaintiff was employed by the defendant in its car barns, a portion of his work consisting in removing to and from the trucks of its cars electric motors used thereon. This was done with the aid of a derrick by the side of the car track. After he had been working at this kind of work for about two months, while engaged with two other men in handling one of the largest motors used by the company, he was struck by the handle of the crank of the derrick. While working there another workman had been injured in the same manner as he. He also admitted that about two weeks before he had talked with the foreman with regard to this appliance being a dangerous one, and admitted that he had heard the foreman caution another workman about the dangers thereof. He obtained a judgment for damages, but that is reversed and the cause remanded, with instructions to dismiss the action, it being held that under the circumstance he assumed the risk.

## Ejection by Conductor of Trailer of Passenger Paying Fare on Motor Car—Reasonableness of Rule.

*Birmingham Railway Light & Power Company v. McDonough*, 44 Southern Reporter, 960.—The supreme court of Alabama says that this was a suit by a passenger to recover damages for an alleged unlawful ejection from a car by the conductor. The defendant company filed a plea the defense attempted to be made by which was that at the time the wrongs and injuries complained of occurred the defendant was running or operating two cars, the front one a motor car, and the rear one a "trailer," which was attached to the motor; that the defendant had a separate conductor in charge of each of said cars; that the plaintiff first took passage on the motor car, and, while thereon, paid his fare to the conductor of that car; that thereafter the plaintiff got off the motor car, and boarded and took passage on the trailer car; that the conductor on the trailer demanded fare of the plaintiff, and that the plaintiff refused and failed to pay the conductor a fare entitling him to be carried as a passenger, whereupon the conductor, on account of the plaintiff's refusal to pay the fare, ejected him, using no more force than was necessary. In the plea it was further averred that at the time the defendant had in force a rule which required the conductor in charge of the motor car to collect a fare from each passenger on that car, and the conductor of the trailer to collect a fare from each passenger on that car, and that said rule or regulation did not permit a passenger who had already paid fare on one of the cars to ride on the other without also paying his fare on that car. The plea averred, further, that the rule was a reasonable one, and that the plaintiff was advised of its existence before he was ejected; that the plaintiff, without the payment of an additional fare, could have resumed his journey by again getting on board the motor car, but that he refused to do this. It is held that the rule pleaded was a reasonable one, in the proper conduct of the business of the defendant, and necessary to protect it against imposition, and that it was error to sustain a demurrer to this plea.

In support of this the court states that it may be said to be common knowledge that street cars in the city of Birmingham are usually crowded—at least they are frequently so. Therefore the conductor is not presumed to know all of his passengers. He must necessarily be a stranger to a large portion of them, and not acquainted with their character for truthfulness. If passengers are allowed the privilege of boarding one car and moving from that to another car—the two being coupled together, as the plea in this instance

showed the cars were joined—it would be a very easy matter for a passenger to board one car and move to the other, and claim, when called upon for his fare, that he had paid on the other car, when in truth he had not; and the different conductor could have no means of knowing that the moving passenger had paid fare. The court recognizes the fact that this attributes to men an evil design; but at the same time observation and common knowledge will bear out the truthfulness of the statement that such characters are not too few. And the rule, in one phase, is for the protection of the carrier against such as would impose on it in this way; and as it would be impracticable to limit such a rule, in its terms, to such persons as would intentionally practice a fraud, it must cover all—good and bad—alike. Again, as was suggested in brief of the appellant's counsel, it is common knowledge that conductors are required to "register up" each fare collected in their proper cars, and are required to collect from and register each passenger on each car. This check on the conductors would be rendered valueless if passengers were allowed to change from one car to another—each car having a separate conductor—without paying fare.

In view of the averment that the plaintiff was advised of the rule before he was ejected and that he might return to the motor car, it was not necessary that he should have had knowledge of the rule before he boarded the car.

The contention that the plea should have shown that reasonable accommodations were furnished the plaintiff was not tenable. Construing the plea in connection with the complaint, this was manifestly matter for a replication, if it was available to the plaintiff.

But, notwithstanding that the rule was a reasonable one, the defendant, as a matter of course, would be responsible for an unjust application of it, or for enforcing it with undue severity.

## Going from Platform to Step of Moving Car Preparatory to Alighting.

*Bendekovick v. Omaha & Council Bluffs Street Railway Company*, 113 Northwestern Reporter, 988.—The supreme court commissioners of Nebraska say that this was not a case of intentionally and voluntarily standing upon a car step or running board for the purpose of continuous riding, which several courts have held to be negligence per se (by itself), but it was an instance of going down upon the step or board in anticipation of almost immediately leaving the same by alighting upon the ground when the car should have stopped or nearly so. Now, this is an act that men of all grades of intelligence, experience and prudence are frequently and constantly committing. The commissioners suppose it is done thousands of times every day in all the considerable cities of the United States, so that its frequency must be regarded as a matter of common knowledge of which the courts take judicial notice, and to hold that such an act is at all times and in all circumstances negligence per se, or in law, would be to say that the universal custom of intelligent and prudent men is such, which, as it seems to the commissioners, would be to utter an absurdity. But an act which is prudent in some or in most circumstances may be negligence or criminal in others; and the question calling for decision is: Who shall discriminate the circumstances, the court or the jury? Applying the inquiry concretely to the facts of this case, considering the speed of the car and the character of the locality, and the fact that the passenger had repeatedly notified the conductor of the place at which he desired to get off, and the known duty of the latter to give a signal to stop, and the knowledge of the passenger, if he had knowledge of the subject, whether the signal had been given, was not the question of negligence one of fact for the jury, rather than one of law for the court? In the commissioners' opinion it was, and the supreme court so holds.

# News of the Week

## Indiana Commission Investigates Operating Conditions.

The Indiana railroad commission has instituted an inquiry into operating conditions on interurban roads in the state and has issued a letter to the electric railways calling a meeting for February 10 to discuss the subject and for the purpose of formulating a uniform code of rules. The letter reads in part as follows:

"It being the duty of the railroad commission to keep informed as to the conditions of railroads and railways, and the manner in which they are operated with reference to the security and accommodation of the public, an inquiry and investigation is hereby instituted as to the rules of operating and dispatching cars, and as to the qualifications of motormen and conductors on the traction lines of this state.

"The managers, superintendents and dispatchers of such railroads are, therefore, requested and directed to appear before this commission at its public hearing room on Monday, February 10, 1908, for conference and information on these subjects, and for the purpose of formulating and adopting uniform operating rules and practices and for providing for the instruction of conductors and motormen in their rules, and to take such other steps for safe operation and the prevention of accidents as may be agreed on or ordered."

## Public Service Commission for Chicago Proposed.

At a meeting of the Chicago city council on January 13, Alderman Race presented a resolution asking that the corporation council prepare a bill, to be submitted to the state legislature, providing for the creation of a public service commission for Chicago similar to the New York public service commission. The resolution was referred to the committee on legislation. It reads as follows:

"That the corporation counsel be and he is hereby directed to prepare and submit to this council a bill to be submitted to the legislature establishing a commission in the city of Chicago to be known as "the public service commission." Said bill to be drafted along the lines of the bill now in force in New York City, and giving the commission the following powers and duties:

1. The regulation and control of all common carriers, gas and electric companies and express companies doing business in Chicago.

2. Fixing of rates for transportation of freight and passengers, and for gas and electricity.

3. The safeguarding of life, limb and the protection of public interests in the operation of all public service corporations.

4. The prevention of unlawful mergers of corporations at the expense of the people.

5. The supervision of traffic and the laying out of new transit facilities in Chicago.

6. The investigation and regulation of corporations doing public work.

## Negotiations for Purchase of Belmont Tunnel.

Preliminary negotiations have been in progress for some time past for the purchase of the Belmont tunnel under the East river at Forty-second street, by the city of New York. The negotiations were started by President Theodore P. Shonts of the Interborough Metropolitan Company and several conferences have been held by the Belmont interests and Nelson P. Lewis, chief engineer of the board of estimate, Corporation Counsel Pendleton and William Barclay Parsons, chief engineer. The tunnel is completed, the rolling stock is on hand and operation could be started at once, but the company's franchise is in litigation and the company does not yet know its status. The city claims that the old Steinway franchise, which was purchased by August Belmont, has expired and that the charter of the New York & Long Island Tunnel Company required the completion of the tunnel by December 31, 1906. When the work was not completed by that time, the city tried to enjoin further construction, but the company went ahead with the work and completed it during the summer. The city further contends that the company cannot operate without a franchise and yearly payments to the city and during the doubt as to the status of the charter the Belmont interests have declined to apply to the public service commission for a franchise. In order to put an end to the difficulty, Mr. Belmont offered recently to sell the tunnel to the city and to make a contract to operate it for a term of years. E. P. Bryan, president of the Interborough Rapid Transit Company, which owns the tunnel, stated before the public service commission that it was proposed to operate the tunnel with 3-cent

fares and it is understood that the negotiations now in progress hinge chiefly on the question of the rate of fare. The city officials contend that the tunnel should be operated in connection with the trolley lines in the borough of Queens without an additional fare.

## Legislation Affecting Electric Railways.

**New York.**—Senator Travis of Brooklyn has introduced a bill into the legislature at the instance of the Republican League of Brooklyn, which increases from 20 to 50 years the period for which subways may be leased to railroad corporations for operation.

**Ohio.**—Representative Metzger has introduced into the legislature a bill which was originally introduced at the instance of Tom L. Johnson, mayor of Cleveland, two years ago, and which bears directly on the Cleveland franchise controversy. It abolishes the necessity of securing property owners' consents for the construction of a street railway and provides that all franchise grants must be submitted to a vote of the people in the municipality affected. To make "straw bids" impossible the bill eliminates the necessity of bids and prior applications to city councils. The routing and all the terms of the franchise are to be included in the granting ordinance without any preliminary procedure.—A bill introduced by Representative Stockwell gives cities the power to own and operate street railways, to grant and control security franchises and to purchase and operate any public utility as a going concern. A companion bill, introduced by Mr. Stockwell, gives cities the right to own street railway tracks, but not to operate cars, and is intended to enable the city of Cleveland to control the loops in and around the public square and on bridges and viaducts.—A bill introduced by Senator Schmidt provides that when a grant is made by the council of a municipal corporation for the construction of a street railway, either as a new route or as an extension of an existing route over and along any street or part thereof, upon which a street railway has been previously operated, and the grant for which has expired, or is about to expire, it shall not be necessary to produce to such council any written consents from the owners of the lands abutting such streets.—Representative Lehman has introduced a bill providing that street railway companies shall pave 12 feet of the width of the streets where they have single tracks and 23 feet where they have double tracks.

## The Cleveland Situation.

The principal efforts of the representatives of the city and of the Cleveland Electric Railway, who are endeavoring to fix a valuation of the Cleveland Electric property as the basis of a lease to a holding company, have been directed toward determining the value of the franchises. No agreement has yet been reached on many of the items comprising the physical property but the appraisers are still at work trying to bring their estimates into harmony with each other. Newton D. Baker, city solicitor, and S. H. Tolles, representing the Cleveland Electric Railway, reported at the council meeting on Monday, January 13, that they had been unable to agree on the dates of expiration of many of the principal franchises, on which the valuation of course depends, although they had agreed on some of them. The two men differed widely on the principles to be applied in determining the dates and upon the effect of various court decisions on the life of franchises.

Consequently F. H. Goff, the mediator for the Cleveland Electric Railway, and Mayor Johnson for the city decided to settle the question of franchise values themselves, with the assistance of A. B. du Pont and H. J. Davies. The principal disagreement was on the outlying franchises and their effect on the value of the city franchises. Most of the sessions on Monday was devoted to hearing reports and arguments of the two lawyers in regard to the different franchises.

At the meeting on Tuesday the franchise negotiations were resumed. One of the cases discussed at length was the Euclid avenue grant. Mr. Goff and Mr. Tolles claimed that a franchise for the outlying Euclid Heights line, running until 1914, extended all of the Euclid avenue grants until 1914 because it required the company to carry passengers from Euclid Heights to the public square for a 5-cent fare. Mr. Goff and Mr. Johnson reached an agreement on several points of law affecting the grants and it was stated that substantial progress had been made.

Horace E. Andrews and A. B. du Pont have reported an estimate on the value of the Cleveland Electric's stores of \$305,882, which is \$29,278 less than Mr. du Pont's estimate of last spring.

## Proposed Subway Improvement at Ninety-sixth Street.

In view of the approval by the public service commission of New York City of measures looking to the relief of interference between Broadway and Lenox avenue subway trains at the point of junction just north of Ninety-sixth street, plans

have been prepared by the Rapid Transit Subway Construction Company which, if fully carried out, will entirely remove the present difficulty and greatly improve the service. The benefit will be felt chiefly by express trains from above Ninety-sixth street. It is understood that as the plans have been approved the only question remaining to be settled is the one of finances. The cost is estimated at about \$850,000.

The present conflict of trains is between Ninety-sixth and One Hundred and Fourth streets, the two lines diverging near the latter point. Lenox avenue locals are constantly, during the rush hours, in the way of Broadway trains running as expresses from points above Ninety-sixth street, and the enforced wait seriously impairs the efficiency of the service. It is proposed to construct two new tracks on each side of the existing tracks, those on the west being one each for Lenox and Broadway southbound locals and those on the east one each for northbound trains of the two lines. The grades will be adjusted so that at One Hundredth street the Lenox avenue tracks may be carried directly under those of the Broadway line, coming again to a common grade at Ninety-sixth street. The present Lenox avenue lines are nearly on a level.

An important feature of the new arrangement is involved in the location of the Broadway northbound local track. The local trains of both the Lenox and Broadway lines will use the same track from Ninety-sixth street station to a point just beyond Ninety-eighth street, where the Lenox line diverges to the west to enter upon the lower level. The Broadway line continues on a tangent to One Hundred and Second street, where the separation of grades has reached such a difference that the Broadway local can pass over the Lenox tracks, thus avoiding interference, and enabling the service of the One Hundred and Third street station by those trains.

In order to make room for the two new tracks in each direction it will be necessary to build new retaining walls on each side. These will be located just inside the curb line, the width of Broadway at this point being 60 feet within the building lines, and 40 feet from curb to curb. Naturally, also, a complete change of signal arrangement for the distance covered by the improvement will be involved.

#### Pleasing the Public in Baltimore.

The Baltimore News of January 8 publishes an interview with William A. House, president of the United Railways & Electric Company of that city. The article states that the reporter was prompted to ask Mr. House what led to the change in the policy of the company "because of the many expressions of approval heard during the past year" on the new policy. An abstract of the article follows:

"Mr. House answered the question briefly and to the point: 'The United company is a public service corporation, and we realize that the most valuable asset a public service corporation can have is the good will of the public. This is what we have been striving for, and if we succeed the directors, as well as the operating officials, will be happy. We have tried to be frank with the public and frank with the city in all our dealings. I have always felt that we have nothing to conceal, and therefore should deal openly with the public.'

"When we get complaints we make a thorough investigation, and if we are at fault the cause is rectified at once. We let the complainant know what we have done in his or her case, and in nearly every case make friends. When we get suggestions we look into them; if they are practicable they are adopted. I feel that a man who takes the trouble to write us or call us up over the telephone to make a suggestion is interested in our welfare.

"Where there is a wide difference between men representing two interests the best way to settle such difference is for those interested to get together, sit down and talk over the question involved. Each side should be given credit for an honest difference of opinion, and if there is any disposition on the part of both to reach a settlement it seldom fails that this is done.'

"In addition to the removal of tracks from Charles street in response to a public request, the United company took up two of the four tracks on North avenue at Madison avenue when some of the residents of that section of the city suggested their removal, though the removal involved considerable expense and necessitated the extension of a line which formerly had its terminus at the intersection of the two streets.

"Mr. House has several times made the statement that the United company is not in politics, and in this connection a case might be cited. Last spring two employees of the company who had been in the city council for some time were re-elected. Naturally, many supposed that the company was interested in keeping them there. Before election—several months previous, in fact—the directors adopted a resolution to the effect that its employees were not to hold outside positions, but exempted the two councilmen for the terms they

were then serving. They went into the next election with a full knowledge of the company's rules, and, while each had to his credit an enviable record, the management decided that no exceptions could be made, and their resignations were accepted."

#### To Consider Proposed Changes in New York Rapid Transit Law.

The New York public service commission of the first district has called a public meeting to be held on Friday of this week, to discuss proposed changes in the rapid transit law which will make contracts for the construction and operation of subways more attractive to private capital. The necessity for making some changes in the law is explained by Chairman Willcox as follows:

"The difficulties of the situation are well known. The present law contemplates that the city shall build its own subways and lease them for operation without alienating the franchise or to equip and operate them itself. Under the terms of this law, the so-called Elsborg statute, any lease to an operating company is limited to 20 years, with the privilege of renewal for a like period. It has not proved effective in bringing private capital into the field. The rapid transit commission failed to get a single bid for construction or operation of the Seventh and Eighth avenues, Lexington avenue and Jerome avenue routes when those contracts were advertised last year.

"Owing to the fact that the city of New York is so close to its constitutional debt limit, there has been very little margin of the city's credit to draw upon to enable the city itself to undertake construction. The board of estimate has appropriated the amount needed to build the Fourth avenue subway in Brooklyn, but if that is furnished there is very little prospect, so I am told by the city officials, of any further appropriation of any size for another subway.

"The only way to achieve the desired result, in the opinion of many who have studied the problem, is by a constitutional amendment which will place outside the calculation of the debt limit bond issues for subway construction. Such an amendment must be passed by two sessions of the legislature and then adopted by the people at a general election—a process that will take at least two years and a half. What we want is a law which will enable us to begin work at once. We have received all sorts of suggestions as to the amendment of the Elsborg rapid transit law, mainly in regard to the length of the term for which the city may lease its subways. The consensus of opinion among those favoring the change is that a longer term would make attractive to private capital contracts which now go abegging. On this subject, as well as upon the desirability of a constitutional amendment, together with any other changes in the law which may be deemed advisable, the commission desires to hear from the people of New York and has invited them to the hearing next Friday to ascertain their views."

Mr. Willcox urged the necessity of constructing additional interborough roads and insisted that the traffic demands of the city made it urgent that such a development of the city's subway system should be begun as speedily as possible. He said that the contract for building the Fourth avenue (Brooklyn) subway would shortly be advertised and that with that matter out of hand there would then come up the question of building an east side subway and other lines in Manhattan and The Bronx.

**American Institute of Electrical Engineers.**—The next meeting of the Minnesota section of the American Institute of Electrical Engineers will be held on Monday, January 20, at Minneapolis. Samuel B. Green, professor of forestry at the University of Minnesota, will speak on "The Effect of Forest Destruction on Water Power."

**Des Moines Franchise Cases Postponed.**—Attorneys for the Des Moines City Railway and for the Des Moines Civic League have agreed to a postponement of the hearing in district court to test the franchises of the company until after the United States supreme court has passed upon the decision rendered last spring by Judge McPherson in which the company's claim to a perpetual franchise was upheld.

**Interurban Rules of the New York Association.**—Secretary J. H. Pardee of the Street Railway Association of the State of New York has issued in pamphlet form, pocket size, the interurban rules which were approved at the meeting of the association at Kingston, N. Y., on September 19. The pamphlet shows forms of blanks and diagrams of hand, flag and lamp signals, together with diagrams of train signals and special rules.

**Pensacola Carmen Ask Wage Increase.**—The employees of the Pensacola Electric Company, Pensacola, Fla., have presented a demand to the company for a new wage contract for

1908 at an increase of two cents per hour. The increase was refused and the men offered to sign a contract at the present rate if the company would promise a 2-cent increase when conditions became more settled. This offer was also rejected. The old contract expired on January 14.

**To Connect Brooklyn Subway with Elevated Lines.**—The Brooklyn Union Elevated Railroad has applied to the New York public service commission for permission to abandon the Court street and Boerum place stations on the Fulton street line and to erect a new station midway between those points in order to facilitate the transfer of passengers between the elevated line and the new Brooklyn tunnel station at Borough Hall. The company promises that the new station will have a platform space equal to that of the two stations replaced, and will be adequate for the traffic.

**Chicago Traction Adviser to Inspect Eastern Roads.**—M. B. Herey, superintendent of local transportation for the city of Chicago, will begin next week a trip to New York, Boston, Philadelphia and Washington for the purpose of investigating the city transportation systems for Chicago's benefit. The especial purpose of the trip is to examine the subways in New York and Boston for the purpose of advising the Chicago city council when it takes up the question of a subway for Chicago in the near future, and to study the operation of the elevated roads with reference to Chicago's loop problem.

**American Institute of Electrical Engineers, Purdue Branch.**—At a meeting held on January 8, Prof. J. Walter Esterline, Purdue University, spoke on the subject, "Specifications and Contracts for Electrical Work." The speaker discussed the various features that make contracts valid or invalid. According to law the parties must be competent, corporations are only liable as far as their charters extend, the subject matter must be lawful and a consideration must be provided for. Particular stress was laid upon the fact that a contract was a means of bringing contractor and client to mutual agreements.

**Philadelphia Strike Vote Rescinded.**—The union motormen and conductors of the Philadelphia Rapid Transit Company, at a meeting on January 8, rescinded the strike vote taken several weeks ago and endorsed the action of Mayor Reyburn in inducing the company to make certain concessions to the men. As reported in last week's issue, John B. Parsons, president of the Philadelphia Rapid Transit Company, agreed to set apart one day a month on which individuals or committees of three might confer with the general manager in regard to grievances and also agreed to receive suggestions from the men in regard to the improvement of working conditions. He said it would be absolutely impossible to consider any increase of wages.

**Portland Council Adopts Fender.**—A committee of the city council of Portland, Ore., after conducting a number of tests of various makes of fenders on the lines of the Portland Railway Light & Power Company, has decided that the Lambert fender is best suited to the conditions, and an ordinance will be adopted at once requiring the company to use that fender on all of its cars. The present ordinance requires another make of fender, but as it is claimed that that fender is not entirely suitable, the ordinance has not been strictly enforced. The Lambert fender has withstood severe tests. It extends about three feet in front of the car and is operated automatically. A complete description of the fender will be incorporated in the ordinance.

**Programme Annual Meeting Central Electric Railway Association.**—The secretary of the Central Electric Railway Association has issued an attractive 4-page programme and invitation for the annual meeting which will be held at the Phillips hotel, Dayton, O., Thursday, January 23. The first page of the invitation bears a half-tone engraving of one of the large Indianapolis-Ft. Wayne limited cars. An excellent programme of interest to both transportation and mechanical men will be presented. The annual dinner, which, in the past, has been such a successful event, will be held on the evening of the twenty-third. It is expected that a number of inter-urban managers will bring their private cars to Dayton so that an exhibit may be held similar to that given at Indianapolis a year ago.

**Western Society of Engineers.**—At the annual meeting of the Western Society of Engineers held in the banquet hall of the Chicago Athletic Club on January 7, the following officers were elected for the year 1908: President, C. F. Lowth, engineer and superintendent bridges and buildings, Chicago; Milwaukee & St. Paul Railway, Chicago, Ill.; first vice-president, J. W. Alvord, 140 Dearborn street, Chicago; second vice-president, P. Junkersfeld, electrical engineer Commonwealth Edison Company, Chicago; third vice-president, D. W.

Mead, University of Wisconsin, Madison, Wis.; treasurer, A. Reichmann, American Bridge Company. The annual meeting of the electrical section of the society was held on January 10. J. D. Ihlder of New York presented the paper of the evening on "Electric Elevators for High Buildings." An extra meeting of the society will be held in the society rooms on Wednesday, January 22. A paper on "The Wrought Compressive Member for Bridge Trusses," previously read by H. E. Horton, will be discussed.

**Fire in New York Skyscraper Ties Up Subway Service.**—The service in the New York subway was seriously interfered with on Saturday and Sunday, January 11 and 12, by the disastrous fire in the Parker building at Fourth avenue and Nineteenth street. The building was badly injured by the fire and was so far out of plumb that it was feared that the vibration caused by the trains might cause the walls to fall. At that point the roof of the subway is only 12 feet below the surface of the street and the tracks are only about two feet from the building line. Twice on Saturday the trains were stopped for some time by the orders of the building commissioner, and at 11 p. m. it was decided not to run any more trains north of Fourteenth street and South of Forty-second street. It was also necessary to cut down the number of trains somewhat on account of the inadequate switching facilities at those stations. The elevated and surface lines were badly congested because of the crowds that ordinarily use the subway. On Sunday many trains were run past the building slowly without stopping at the Eighteenth street station, but the service was reduced 40 per cent. On Monday trains were run on a regular schedule but not so frequently as usual.

**Los Angeles-Pacific Company.**—That Epes Randolph, representing E. H. Harriman, is expected to come to Los Angeles to reorganize the Los Angeles-Pacific Company is made evident by a statement made by R. C. Gillis, chairman of the executive committee of that corporation. When asked concerning the changes contemplated by the company, including the reduction in force, Mr. Gillis replied: "We will have no material changes except a minor consolidation of offices. Our road is financed, and any future plans of reorganization that we have in view will await the arrival of Colonel Randolph." The rumors that General Manager T. R. Gabel would leave the company were denied at the offices in the Los Angeles-Pacific building and also by Mr. Gabel himself. He says: "The Los Angeles-Pacific will not be operated from the Pacific Electric building nor by any one other than its own officers. The financial condition of the company is the same as that of other large organizations throughout the country—thoroughly solvent, but hard up for cash. We just reduced expenses for the time being, but none of the improvements heretofore decided upon will be abandoned for plans changed, except that there will be a temporary curtailment of construction."

**Philadelphia Rapid Transit Company Sued for Electrolysis Damages.**—The North Springfield Water Company has brought suit at Norristown, Pa., against the Philadelphia Rapid Transit Company for damages to its water pipes caused by electrolysis. The company is charged with "operating its electric street railway in such an unskilful, wrongful and negligent manner that the mains and pipes are greatly damaged by currents of electricity that escape from its cars and tracks, disintegrating, weakening and shortening their life, and causing a continuing damage to the complainant." The water company states that it maintains water pipes in portions of the city of Philadelphia and in surrounding towns in territory served by the Philadelphia Rapid Transit Company, and that its property is being destroyed by currents escaping from the company's rails. The complainant avers that this injury to its property by the escaping currents is progressive and accumulative, and if not stopped will result in the total destruction of the mains and pipes and prevent the complainant from performing its chartered duties to the public, and possibly cause great damage to the public by water from its leaking or bursting pipes. It is complained that this injury is not confined to the mains and pipes that are located along the streets over which the trolley tracks run, but that the corrosive currents attack and destroy the mains and pipes laid under streets that intersect such main streets and involve all their property in the entire region. Claiming that it is without adequate remedy for the damages inflicted, at law, the water company asks the court to issue an injunction, operative after a reasonable time, which will prevent the defendants from running either their cars on their power houses at Ogontz, Willow Grove and Chestnut Hill until the defendants shall put into operation "such modern and effective devices and appliances as will prevent further injury to the water pipes." The complainant also asks the court to fix heavy damages sustained by it and require the defendant to pay them and the costs of the suit.

# Traffic and Transportation

## Connections of Chicago Subway.

The Illinois Tunnel Company, the operating corporation of the Chicago Subway Company, has made public certain information concerning the present status of its affairs. It has completed connections with 11 of the steam railway companies with which contracts have been made, and has now under construction connections with 7 additional roads. Connections are either completed or under construction with 14 wholesale or retail mercantile houses. There are also under construction connections with 8 warehouses. Negotiations for connections are under way with 12 additional mercantile houses. Connections have been completed with 6 large downtown buildings for the delivery of coal. The company is now operating daily 2,000 cars, of which 1,200 cars are required for the delivery of mail to and from the postoffice and 800 cars are used in the transportation of coal and merchandise. When connections are completed with 10 additional freight houses of steam railways by April 1, the company anticipates that 5,000 cars a day will be needed. The officials of the company estimate that by July 1, 1908, about 10,000 cars will be required to handle the business.

## Payments to City of Indianapolis.

The Indianapolis Traction & Terminal Company has paid to the city of Indianapolis \$3,969.70 under the provision in its ordinance that the city shall receive four cents for each round trip of an interurban car. During 1907 the total of such round trips in the city was 99,212½, divided as follows:

Company—	Number of trips.
Indiana Union Traction Company—	
Muncie division .....	9,443
Logansport division .....	8,226½
Broad Ripple division .....	14,148
Army post division .....	2,000
Indianapolis & Cincinnati Traction Company.....	15,447½
Indianapolis Columbus & Southern Company.....	10,160
Indianapolis Crawfordsville & Western.....	2,859
Terre Haute Indianapolis & Eastern—	
Northwestern division .....	8,539
Eastern division .....	8,162½
Martinsville division .....	7,996
Brazil .....	6,738½
Danville .....	5,522½
<b>Total .....</b>	<b>99,212½</b>

The total paid for 1907 exceeded that paid for 1906 by \$460.48. To the amount paid by the Traction & Terminal company will be added \$992.43, as each interurban company must pay to the city one cent for each round trip its cars make in the city. These amounts are in addition to the \$30,000 which the Traction & Terminal company annually makes to the city under its franchise for park purposes.

## Hearing on Petition for Reduced Fares in Springfield, Mass.

The Massachusetts railroad commission held a hearing on January 10 on petitions urging that the Springfield (Mass.) Street Railway be obliged to sell six tickets for 25 cents, or 25 tickets for \$1.00, and to run more cars in Springfield. A hearing also took place on a petition that the company be obliged to issue 3-cent tickets for workmen in Chicopee, good in the morning and evening. The company was represented by H. C. Page, vice-president and general manager, and Bentley W. Warren, counsel.

City Solicitor Wooden of Springfield introduced H. A. Booth, who said that in the last four years the gross earnings of the company had increased 37 per cent, its operating expenses 59 per cent and the number of passengers carried 37 per cent. Mr. Booth said that when he rode on a crowded car from Chicopee to Springfield on one day the conductor was mable to collect 75 cents or \$1.00 in fares because the car was so crowded. The hearing was continued until February 4.

The Springfield (Mass.) Street Railway, as a retrenchment measure, has abandoned the half-rate tickets for evening school pupils and students at commercial schools. The value of unused tickets was refunded on presentation at the office of the company. Heretofore pupils of the night schools have had a 2½-cent fare just as the day school pupils have had, the same books being supplied on presentation of certificates, but stamped to indicate that they were for evening use. H. C. Page, vice-president and general manager of the company, said that the cutting off of evening school and commercial

school tickets was not confined to Springfield, but that it was general throughout Massachusetts, not only on the lines in which the New York New Haven & Hartford Railroad has been interested, but on others as well. The action, he said, had been made possible by the supreme court decision in the Amherst case. This suit was brought by F. H. Chapin of Amherst, a student at the Northampton commercial high school, against the Connecticut Valley street railway company to enforce the penal clause of the statute for the failure of the company to accept a half-fare ticket from Chapin. A jury found the company guilty, but the decision was a mere form to allow the case to go to the supreme court, which ruled in October that the commercial high school of Northampton is not a school within the meaning of the statute.

## Improvements in Service of Louisville Railway.

R. S. Smith, traffic manager of the Louisville (Ky.) Railway, has submitted to the mayor and general council of Louisville the reply of that company to the request for improvements in the service. In his letter Mr. Smith states:

"By reason of circumstances, we have been compelled to employ a considerable number of conductors and motormen, some of whom have not yet had opportunity to gain full experience. This condition is being rendered less serious every day, and we have no reason to doubt that within 30 days substantially all grounds for complaint of this kind will cease to exist.

"There are many things which disarrange a schedule of street car operation that are entirely beyond the control of the company. The rails of our line cross the rails of steam railroads at 34 places. It is within bounds to say that the cars of the Louisville Railway cross the tracks of steam railroads 12,000 times a day. At these crossings safety requires gates or other appliances, which stop the street cars until the engines or engines and trains of the steam railroads have passed over the intersection. Sometimes these trains are very long and take considerable time in passing, and in many instances a certain amount of switching is done backward and forward over the intersection. Our cars are delayed at these crossings an average of 600 times daily.

"In regard to arrangement of schedules wherever possible with due regard to connections with cars on other lines for the purpose of transfer, this is an obvious duty upon the part of the company, and we will make every effort to comply with your suggestion in this regard. Here again a moment's consideration will show the importance of regulating the above mentioned causes of delay, which are beyond our control.

"In reference to the matter of transfers, we have a system which includes about 500 different transfers. We do not think that any system of transfer should be provided by which a passenger can be taken from a given point and returned to the same, or nearly the same, point for one fare. After going over the matter, however, with your committee, we have determined to put in a number of additional transfers, being all the special ones suggested, and some others which we had added thereto. These added transfers are not in accordance with the practice which we have heretofore adopted of excluding transfers from one parallel line to another, but as there seems to be a special desire for them, we have concluded to yield to your request and to add them to the transfers now in force.

"In regard to heating cars according to the provisions of the ordinance, we make the best effort in our power to do this. The fact is, however, that we have very many more complaints from passengers wanting fresh air, that the cars are close and overheated, than that they are too cold, and you can well appreciate the difficulty there is in satisfying a carload of passengers on this point—some asking for one temperature and some for another.

"We believe that if the service on the Louisville Railway is compared with that in other cities of the size of Louisville and greater, it cannot be said that we do not possess a modern and convenient system of travel.

"No rules are made governing the conduct of such a company as ours that are not believed to be in the interest of the general public. In some instances the reasons for these rules are not always apparent, and seem to bear hard in individual cases; but they are not adopted without careful consideration, and we are always more than willing to give the reason for them, and to change them if these reasons do not justify them."

**Mounted Police Expedite Traffic in Chicago.**—T. E. Mitten, president of the Chicago City Railway, has written a letter to Mayor Busse praising the work of the mounted police, who have expedited traffic in the central business district. Mr. Mitten cited several specific instances showing that cars make better time through the congested district, and added: "There is also a much greater regularity of service, which, of

course, tends to reduce overcrowding. I feel that you ought to know what the result has been and at the same time desire to express to you my very great appreciation of your co-operation, a continuation of which will make the real solution of the traction question—i. e., reducing overcrowding—very much easier of accomplishment."

**Limited Service Extended by Ohio Electric Railway.**—Effective on January 19 the Ohio Electric Railway will extend the limited service inaugurated on December 15 between Columbus and Dayton, O., to Richmond, Ind. The distance from Columbus to Richmond is 112 miles.

**Five-Cent Fare Sought Between Council Bluffs and Omaha.**—At the meeting of the West End Improvement Club of Council Bluffs, Ia., on January 7, steps were taken to secure the establishment of a 5-cent fare between Council Bluffs and Omaha on the lines of the Omaha & Council Bluffs Street Railway. A hearing on the subject will be held by the interstate commerce commission in Omaha on January 20.

**Electric Express Company Service.**—The desire of the Electric Express Company to start express service between Springfield, Mass., and Hartford, Conn., is indicated by a petition to the selectmen of Longmeadow, Mass., by the Springfield Street Railway for permission to use its lines and cars as a common carrier of newspapers, baggage, express and freight. A hearing on the subject will be held on January 29.

**Fares Raised in Massachusetts.**—Directors of the Medfield & Medway Street Railway and the Dedham & Franklin Street Railway of Westwood, Mass., have decided to raise fares. The fares for rides between Franklin, Medway, Millis and Medfield will be 7 cents instead of 5. From Medfield to Dedham the fare will be doubled to 20 cents. The Lexington & Boston Street Railway, which is controlled by the Boston Suburban Electric Companies, will probably increase its fares.

**To Investigate Schedules in Savannah, Ga.**—After a conference between representatives of the Savannah (Ga.) Electric Company and city officials of Savannah, it was announced that the company has agreed to have an expert investigate the schedules concerning which complaint has been made. This expert is employed by the firm of Stone & Webster and he will make a detailed inspection of the situation in Savannah and report to the company.

**Orders Increased Service on Brooklyn Rapid Transit Line.**—The New York public service commission, first district, has ordered the Brooklyn Rapid Transit Company to add at least 25 cars to its service on the Brighton Beach line. Complaint has been made to the commission that on this line the company has been operating trains of only two and three cars. The order issued by the commission is that the trains shall have more cars and that in the rush hours more trains should be operated.

**Increased Fares or Reduced Service.**—James L. Richards, president of the Newton & Boston Street Railway of Newton, Mass., and other roads, made an address before the Newton Club on January 11 in which he spoke of the necessity for roads which are not profitable of increasing fares or reducing the service. Mr. Richards said that one reason for the decline in earnings was the failure of the old management to allow for the depreciation of the property. He favored a reduction in the number of trains on the line between Framingham and Newton.

**New Transfer System in New Orleans.**—The new transfer system of the New Orleans (La.) Railway & Light Company was introduced on January 15. Transfers will be issued to any line except the St. Charles-Tulane and the Esplanade-Canal belt, and at any point along the various lines. Transfers will be issued on the payment of cash fares only and only upon request as fares are paid. Passengers are urged to tell the conductor at the time of paying fare at which point they wish to transfer to another line. The company has issued booklets showing the extent of the system.

**Express Company Contract with Pittsburg & Butler Street Railway.**—By making a contract with the Pittsburg & Butler Street Railway, Wells Fargo & Company's Express has secured entrance to Pittsburg. It is now using wagons for handling the traffic at the Pittsburg end of the electric road, but is planning to replace them with automobile trucks. It is expected that the contract with the express company will afford considerable traffic to the electric road. The other principal express companies reach Pittsburg over the steam railways. The Adams Express Company is on the Pennsylvania Railroad, the American Express Company enters on the Lake Erie & Western Railroad, and the United States Express Company secures entrance by the Baltimore & Ohio Railroad.

# Construction News

## FRANCHISES.

**Augusta, Ga.**—The Atlanta & Carolina Construction Company has applied for a franchise to build its line through the streets of Augusta and to erect terminal stations. Trackage and terminal rights in Atlanta and Athens already have been secured; the entire survey has been completed, and the contract let for part of the construction work. Matthew Mason, vice-president and general manager, Atlanta, Ga.

**Calgary, Alberta.**—An English capitalist has applied to the city council of Calgary for a 15-year franchise for the construction and operation of an electric railway in that city. A similar application by the same interests was made to the Edmonton, Alberta, council. At the expiration of the franchise the company may sell its holdings to the city.

**East St. Louis, Ill.**—A franchise has been granted to the East St. Louis & Suburban Railway Company to lay tracks on 7<sup>th</sup> street, between St. Clair and Illinois avenues. The company applied for the franchise about a year ago, but on account of the opposition of residents along the line favorable action has been delayed. It is stated that work will be started immediately.

**Monongahela, Pa.**—The council has approved the application of the Monongahela & Carroll Street Railway for the construction of its line in Monongahela. The road will be continued to Bentleyville and later to Washington, Pa., and must be completed and in operation within three years. A bond of \$5,000 to insure the early beginning of the work must be deposited with the city inside of 30 days. Nominal capital stock, \$12,000. E. B. Hartman, Jr., W. D. McBryar, E. W. Marshall, W. S. Walsh and W. E. Walsh, all of Pittsburg, are interested.

**Niles, Mich.**—The franchise granted to the Niles & Buchanan Railway Company about two years ago has been forfeited on account of the inability of the company to secure capital for the completion of the line. The company was formed to build an electric railway from Niles to Buchanan, as a tributary to the Southern Michigan Railway, operating between St. Joseph, Mich., and South Bend, Ind. The promoters, however, have purchased the abandoned roadbed of the Michigan Central Railway between Niles and Buchanan and tracks have been laid to the city limits of Niles. It is stated that as soon as the financial stringency is relieved the company will seek another franchise and complete the road.

**Washington, D. C.**—The senate district committee has reported favorably on a bill authorizing the Washington Railway & Electric Company, the Capital Traction Company, the City & Suburban Railway and the Anacosta & Potomac River Railroad to extend their tracks to the new Union station. Construction is to begin within 30 days and be completed within 12 months from the date of the passage of the act. Amendments providing for universal transfers and a franchise tax were defeated.

## RECENT INCORPORATIONS.

**Southern Street Railroad.**—Incorporated in Illinois to operate street railways in Cook county. Capital stock, \$10,000. Incorporators: James C. Cleary, John A. Early and E. G. Stevens.

**St. Paul Minneapolis & Seattle Electric Railway, St. Paul, Minn.**—Incorporated in Minnesota to build an electric railway from St. Paul and Minneapolis, Minn., to the Pacific coast, with branches extending to Fargo, N. D., and Aberdeen, S. D. Capital stock, \$500,000,000. Incorporators: William C. Weber, Rochester, Minn.; David Phillips, Mazonia, Minn.; Samuel A. Phillips, James Mosop, St. Paul; Glenn W. Martens, Pierre, S. D. The headquarters of the new company will be at St. Paul.

## TRACK AND ROADWAY.

**Ashtabula (O.) Electric Street Railroad.**—This company has been organized by C. G. Nelson, J. E. Anderson, J. V. Paulson and others of Ashtabula, O., to build an electric line about five miles long from Ashtabula to Ashtabula Harbor. A small power house is to be built.

**Atlanta Norcross & Gainesville Electric Railway.**—This company, which was formed to build and operate an electric railway from Atlanta to Gainesville, Ga., by way of Chamblee, Doraville, Norcross and Buford, 50 miles, has applied for a charter. The company also will operate an electric plant and

sell electric light and power. Capital stock, \$15,000. Incorporators: H. D. Jaquish, C. C. Sanders, W. B. Smith, M. M. Ham, J. W. Bailey, H. H. Dean and I. L. B. Stevens.

**Bayou Teche Railway & Light Company, New Iberia, La.**—An inspection of the route of this company's proposed line between New Iberia and Jeannette, La., has been made by H. H. Fine, superintendent of construction for the company, and R. E. Huston of the Huston Engineering Company, and it is stated that construction will be started in January. (Noted November 16, 1907.)

**Beaver Falls & Koppel Electric Railway, Pittsburg, Pa.**—This company is reported to have started work on its proposed line between Beaver Falls and Ellwood, Pa. S. L. Tone of Pittsburg is interested. (Noted December 21, 1907.)

**Buffalo Lockport & Rochester Railway, Buffalo, N. Y.**—This company expects to have its cars running from Rochester to Albion, N. Y., on April 15 and into Lockport by July 1, connecting at this point with the Buffalo cars of the International Railway. With the completion of these sections of the Buffalo Rochester & Lockport line it will be possible to make a cross-state trip by trolley from Buffalo to Albany with the exception of a 30-mile break from Little Falls to Fonda, which cities are connected only by the New York Central steam road. (Noted August 31, 1907.)

**Calumet & Lac La Belle Traction Company, Calumet, Mich.**—It is reported that this company, which was formed to build an electric railway between Calumet and Mohawk, will begin work on the line this month. Sidney M. Weil is financial agent of the company.

**Chicago Lake Shore & South Bend Railway, South Bend, Ind.**—The construction work on this line from South Bend, Ind., to Kensington, Ill., is progressing rapidly. A total of 48 miles of track has been laid to date and grading is so far advanced that it is stated that rails will be laid on an additional 13 miles within 30 days. The engines for the power house at Michigan City are now on the ground ready to be installed. J. B. Hanna is president and J. W. S. Reigle, chief engineer. (Noted December 21, 1907.)

**Cleveland Alliance & Mahoning Valley Railway, Cleveland, O.**—J. W. Holcomb, who is promoting this interurban line between Ravenna and Warren, O., announces that construction work will be started about March or April 1. In addition to electrifying the track from Ravenna to Newton Falls, which was purchased from the Baltimore & Ohio Railroad Company, nine miles of grading and tracklaying must be done. It is believed that the road will be in operation by September 1, 1908. When completed it will form a connecting link between the Northern Ohio Traction & Light Company line at Akron, O., and the Mahoning & Shenango Railway & Light Company at New Castle, Pa. (Noted August 3, 1907.)

**Granger, Wash.**—Several business men and property owners in the Sunnyside valley are planning to form a company for the construction of an electric railway which will serve this section of Washington. Walter Granger, who has charge of the government reclamation work in the Sunnyside valley, is said to be the leader in the movement.

**Hanover & McSherrystown Street Railway, Hanover, Pa.**—An extension of this line from North and Church streets in McSherrystown, to the southwestern limits of Littletown, 5.7 miles, has been authorized. The company also is permitted to build an extension in Queen street, Littletown, a little over half a mile. Robert E. Manley, general manager, Hanover, Pa.

**Hanover & York Street Railway, York, Pa.**—The opening of the extension from Hanover to York, Pa., which this company has had under construction since last fall, will probably take place on February 1, instead of January 1, as earlier expected. Tracklaying was completed on January 9, most of the overhead work has been finished and the work on the viaduct, which has caused the principal delay, is now said to be far enough advanced to permit opening the line on the first day of February. The extension is 18 $\frac{1}{4}$  miles long and has been built by Dodge & Day, New York City, and John H. Dobbins of York, Pa.

**Johnstown Passenger Railway, Johnstown, Pa.**—Improvements for the coming year to the amount of \$100,000 were voted for at a recent meeting of the directors of this company. Of this amount about \$62,000 will be expended on the new system in the Morrellville district, for which a franchise was recently granted by the city councils. The main line of the system between the eighth ward transfer station and the Moxham bridge will also be rebuilt. No action was taken on the proposed extension of the line from Walnut Grove to Geistown, as the company will not build the line unless the right of way is secured without cost to the corporation. S. E. Young, secretary and manager, Johnstown, Pa.

**Lake City, Ia.**—A corps of engineers is working southeast from this city surveying for a proposed interurban electric line between Lake City and Lanesboro. The enterprise is backed by local capitalists, who propose later to extend the line to Des Moines by way of Jefferson and possibly to Sac City, Ia., by way of Yetter.

**Little Rock & Pine Bluff Traction Company, Little Rock, Ark.**—The contract for the electrical supplies for building this company's 50-mile interurban line between Little Rock and Pine Bluff has been awarded to the Westinghouse Electric Company for \$115,000. The Arkansas Corrugated Metal Culvert Company, Little Rock, Ark., has secured the contract for all culverts and conduits. Considerable progress on the grading is reported and it is stated that a further extension to Stuttgart, Ark., may be built by the company. (Noted August 31, 1907.)

**Milwaukee, Wis.**—It is reported that a number of Milwaukee business men are considering a project for a subway from the corner of Third and Grand avenues to the south side and that some sort of a proposition regarding it will be made to the city council in a short time.

**Milner & Northside Railroad, Milner, Idaho.**—About eight miles of this proposed 65-mile line has been graded and work, which has been suspended on account of the bad weather, will be resumed as soon as possible. All of the steel for the bridge across the Snake river has arrived at Milner and work upon the structure will begin shortly. It is estimated that the road will cost \$25,000 per mile or about \$500,000, exclusive of the cost of maintenance. D. C. McWatters, president, Milner, Idaho. (Noted December 14.)

**Minneapolis St. Paul Rochester & Dubuque Traction Company, Minneapolis, Minn.**—Contracts for building this line probably will be let some time during February or March. All surveys and 21 miles of grading have been completed and it is stated that practically all of the right of way has been secured. The road will connect Minneapolis and St. Paul with Northfield, Owatonna and Rochester, Minn.; Cresco, Decorah and Dubuque, Ia.; a total distance of 265 miles. M. W. Savage, president, Minneapolis; F. G. L. Hunt, International building, Minneapolis, chief engineer. (Noted November 30, 1907.)

**Moorhead, Minn.**—The Northwestern Interurban Railway has applied for a 20-year franchise to construct its line over a portion of First avenue north from Front street north to the eastern limits of the city. The franchise also calls for a terminal in Moorhead on the bank of the Red river about half a block from the north bridge. Access will be afforded to the river for "Soo" freight for Fargo and Moorhead and the freight facilities of that section will be greatly improved. It is stated that as soon as navigation has ceased a bridge will be built over the river for the use of both the interurban and "Soo" cars, provided congress takes action on the matter. The interurban company, through an arrangement with the Fargo & Moorhead Street Railway Company, will run its cars from Dilworth and beyond to the business district of Fargo. The road must be built within a year from the date of the franchise. (Noted November 2, 1907.)

**Nashville Interurban Railway, Nashville, Tenn.**—It is stated that this company will suspend grading on its interurban road from Nashville to Franklin on January 15, resuming as soon as the worst of the winter weather has passed, or about April 1. By that time all bridges will be ready to be placed and the work pushed to completion. About two-thirds of the grading has been completed. President H. H. Mayberry is quoted as saying that in the meantime the contracts for the bridge and track materials and equipment will be awarded and all unfinished work of that kind completed by spring. (Noted January 11.)

**Ohio & Southern Traction Company, Columbus, O.**—It is reported that surveys are being made for an extension of this line, which now runs from Columbus to the Hartman stock farm south of the city, to Washington Court House.

**Pasadena, Cal.**—Plans for incorporating a company to build an electric line on Lincoln avenue out to the foothills to the north are being considered by the North Lincoln Avenue Improvement Association of this city. It is stated that the company will be incorporated for \$75,000, which it is believed represents more than the cost of constructing the road. A meeting will be held in the near future and a franchise applied for. A. J. Toolen, Gowan D. Francis and W. M. Mason, all of Pasadena, are president, secretary and treasurer, respectively, of the temporary organization.

**Philadelphia Rapid Transit Company.**—It is reported that more rapid progress was made on the construction of the eastern section of the Market street subway during December

than during any month since the contract was undertaken in May, 1906. Within the last 30 days the Millard Construction Company, which has the contract, has added 500 new men to the construction force, in the effort to have the subway completed by August 15. Of these 300 are assigned to the night shift.

**People's Railway, Dayton, O.**—It is stated that this company proposes to extend its line from Fairview park down Salem pike to Catalpa drive. It will then cross over to Covington pike, thus forming a loop. George C. Towle, general manager, Dayton, O.

**Portland Eugene & Eastern Railway, Portland, Ore.**—Work on this line, which was suspended during December on account of the tightness of the money market, will be resumed between Eugene and Springfield, Ore., some time this month. The franchise covering crossing of the county roads expired on December 6, but an extension of 90 days has been granted by the county court. A. Welch and others of Portland are interested. (Noted December 14, 1907.)

**Portland Gray & Lewiston Electric Railway.**—Surveys have been completed between Portland and Lewiston for this proposed line and plans for the permanent location of the route are now being made with a view to starting work early in the spring. John A. Jones, Lewiston, Me., chief engineer. (Noted August 17, 1907.)

**Pueblo & Arkansas Valley Electric Railway, Pueblo, Colo.**—N. C. Van Natta, chief engineer of this company, writes that the line will extend from Pueblo to Fowler, Colo., and that surveys have been completed for the entire distance, 36 miles. Contracts will be let as soon as estimates have been prepared and additional right of way secured. The road will be built for high-speed freight and passenger service. Ninety-one per cent of the route will be tangent and 65-pound rails will be used.

**Shreveport, La.**—It is stated that an interurban line from Shreveport, La., to Marshall, Tex., is being promoted by John Lorenz, formerly of Jackson, Miss., and S. A. Guy of Shreveport, La. The road will be financed with eastern capital, although residents along the proposed route will be solicited for subscriptions. It is announced that preliminary work will be started soon.

**South Bend-Raymond Electric Company, Raymond, Wash.**—It is expected that as soon as this company has completed the extension of its transmission line to South Bend, 3.9 miles, it will undertake the construction of an electric railway connecting the two towns at a cost of \$150,000, including equipment. J. H. Marshall, engineer.

**Southern Michigan Railway, South Bend, Ind.**—It is stated that this company is planning to build an interurban line between Kalamazoo and Niles, Mich. The company operates an interurban line from St. Joseph to South Bend by way of Niles. J. McM. Smith, general manager, South Bend, Ind.

**Topeka Railway, Topeka, Kan.**—It is stated that this company is planning to build a viaduct over the Santa Fe tracks at Topeka to cost about \$50,000 and be completed some time during the present year.

**Ventura Terminal Railway, Los Angeles, Cal.**—This company proposes to build an electric railway to the cement rock quarry at Tidewater, where a cement factory will be built, a distance of 25 miles, and a 5-mile branch to Nordhoff and the Ojai valley. Preliminary surveys have been made and most of the right of way secured. Part of the capital has been obtained and contracts are to be let as soon as the money market becomes easier. These enterprises will be owned and financed by the Ventura Industrial & Securities Company, which will sell bonds. William A. Ramsey, chief engineer, I. W. Hellman building, Los Angeles, Cal. (New road.)

#### POWER HOUSES AND SUBSTATIONS.

**Coney Island & Brooklyn Railroad, Brooklyn, N. Y.**—The Raymond Concrete Pile Company has the contract for placing the piles for the foundation of the new Smith street power house. Ford, Bacon & Davis are the engineers and A. Pasquini, New York, is the general contractor.

**Lewiston Augusta & Waterville Street Railway, Lewiston, Me.**—This company expects to place contracts during the next two months for the construction of two substations. E. D. Reed, general manager.

**Torrington & Winchester Street Railway, Burrville, Conn.**—It is reported that this company, which is owned by the Connecticut Company, is contemplating abandoning its present power house at Burrville and building a new one at Torrington, Conn.

## Personal Mention

Mr. J. C. Kilpatrick, claim agent and paymaster of the Illinois Traction System, has resigned to engage in business in California.

Mr. W. B. Sutherland, Rochester, N. Y., has been appointed counsel for the public service commission of New York, second district.

Mr. G. E. Miller, superintendent of the Union Electric Company, Dubuque, Ia., has resigned to accept a similar position with the Chattanooga Railways at Chattanooga, Tenn.

Mr. W. P. Lacey, heretofore superintendent of the Evansville & Southern Indiana Traction Company at Princeton, Ind., has resigned to become associated with the Louisville (Ky.) Railway.

Mr. W. H. Tarrant, for the past three years chief engineer of construction for the Illinois Traction System, has resigned. His duties will be assumed by Mr. R. McCalman, engineer of maintenance of way.

Mr. Louis E. Cushing having resigned as superintendent of the Taunton & Pawtucket Street Railway of Attleboro, Mass., the duties of the office of superintendent will for the present be performed by Mr. A. C. Ralph, general manager.

Mr. A. J. Brown has been appointed superintendent of the Cincinnati Northern Traction Company, succeeding Mr. C. E. Palmer, resigned. Mr. Brown has been superintendent of the Dayton & Western Traction Company at Dayton, O.

Mr. Lawrence Manning has resigned as general manager of the Owosso & Corunna Electric Company, Owosso, Mich., effective on January 1. Mr. Robert Gale and Mr. Eugene Bremer have been appointed local managers to succeed Mr. Manning.

Mr. A. L. Neereamer, general superintendent of the Columbus Delaware & Marion Railway, has resigned, effective at once. With Mr. Neereamer's resignation the office will be abolished and its duties distributed among other members of the operating force.

Mr. R. R. Hayes, trainmaster of the Western Ohio Railway at Wapakoneta, O., has been appointed superintendent of the Chicago South Bend & Northern Indiana Railway, with headquarters at South Bend, Ind. Mr. Hayes' former associates on the Western Ohio Railway presented him last week with a fine diamond ring.

Mr. G. W. Wattles, for the past year vice-president of the Omaha & Council Bluffs Street Railway, was elected president of the company at a meeting of the board of directors on January 13. He succeeds Mr. Guy C. Barton, who has retired from active business affairs. Mr. Wattles will be succeeded as vice-president by Mr. Frank T. Hamilton.

Mr. W. A. McWhorter has resigned as master mechanic of the Birmingham Railway Light & Power Company, Birmingham, Ala., to become associated with the Galena-Signal Oil Company as expert on street railway lubrication, with headquarters at the Atlanta office of the company. He will be succeeded at Birmingham by Mr. A. Y. Evans.

Mr. R. M. Howard, formerly general manager of the Clinton (Ia.) Street Railway, has been appointed general manager and superintendent of the Green Bay Traction Company and the Green Bay Gas & Electric Company, Green Bay, Wis. The management of these properties heretofore has been under the direction of Mr. George W. Knox of Chicago, vice-president, and Mr. Melvin J. Kinch, superintendent.

Mr. J. H. Handlon has been appointed claim agent of the United Railroads of San Francisco, succeeding Mr. A. K. Stevens, recently retired after 25 years of service with the company. Mr. Handlon formerly was chief clerk of the operating department, and will be succeeded by Mr. C. I. Kephart, formerly assistant chief clerk. Another appointment announced is that of Mr. Thomas Finegan, who will become purchasing agent of the company.

Mr. George Weston has been appointed a member of the board of supervising engineers, which has charge of the rehabilitation of the properties of the traction properties in Chicago. Mr. Weston has been heretofore assistant chief engineer of the board, in charge of track reconstruction, reporting to Mr. Bion J. Arnold, chief engineer. Mr. Weston will represent the city on the board and succeeds Mr. Charles V. Weston, resigned to become president of the South Side Elevated Railway. A portrait and biographical sketch of Mr. Weston



were published in the Electric Railway Review of May 11, 1907, page 618.

Mr. J. F. Wessel has been appointed electrical engineer of the Apperson traction properties located at Lynchburg and Roanoke, Va., and Montgomery, Ala., of which Mr. R. D. Apperson is president. Mr. Wessel's jurisdiction also extends over the Lynchburg Water Power Company and the Petersburg Gas Company, which are owned by the Apperson interests. Mr. Wessel was for a number of years with the General Electric Company at its Baltimore office.

Mr. Thomas Pinigan, formerly connected with the North Jersey Street Railway Company of New Jersey (now the Public Service Corporation) and who has been assistant purchasing agent of the United Railroads of San Francisco for the past three years, has been appointed purchasing agent of that company, vice Mr. C. D. Baldwin, resigned. Mr. Joseph H. Handlon has been appointed claims agent, vice Mr. A. K. Stevens, resigned. Mr. Handlon has been connected with the United Railroads of San Francisco as chief clerk to the late general manager, G. F. Chapman, for about five years. Previous to this time he held various positions with the North Jersey Street Railway Company of New Jersey, both in the claims department and with the general superintendent, the Brooklyn Heights Railroad Company of Brooklyn, N. Y., and the Metropolitan Street Railway Company of New York City.

Mr. A. W. Jordan, who has recently been appointed traffic agent of the Chicago & Joliet Electric Railway and superintendent of Dellwood Park at Joliet, Ill., has had a number of years of experience in this line of work. He obtained his public school education in Kalamazoo, Mich., and began his business career as a stenographer in the legal department of the Grand Rapids Railway. Since that time he has been connected continuously with electric railways. For eight years he was confidential secretary to G. Stewart Johnson, former manager of the Grand Rapids Railway, and in that capacity was closely identified with Reed's Lake Park. After the death of Mr. Johnson, Mr. Jordan became passenger agent under Mr. Theodore Stebbins, general manager for the receivers of the Appleyard lines in Ohio. When these lines were sold to the Schoepf syndicate Mr. Jordan was made general passenger agent and later general freight and passenger agent of that division of the Schoepf roads. When the consolidation of all the divisions of those properties, first as the Indiana Columbus & Eastern Traction Company and afterward as the Ohio Electric Railway, he was made assistant general passenger and freight agent for all the lines in Ohio, which position he retained until November 1, 1907. Mr. Jordan began active work for the Chicago & Joliet Electric Railway on January 1 of this year and is now engaged in showing Chicago people what a delightful place Dellwood Park is for summer picnics and excursions. He reports that prospects are good for a successful season.



A. W. Jordan.

#### Obituary.

Alexander L. Crawford, well known in the local street railway circles of Philadelphia, died at his home on North Sixth street, Northern Liberties, Pa., aged 85 years. At the time of his death he was a director of the Second & Third Streets Passenger Railway and had been connected for many years with the street railway lines of that section.

William H. Patterson, president of the Grand Rapids & Kalamazoo Valley Traction Company, died at Battle Creek, Mich., on January 10, aged 49 years. He was at one time at the head of the street railway system in Bloomington, Ill., removing from that city about ten years ago to Chicago and later to Michigan, to become identified with electric traction development in that state. During his residence in Illinois he served at one time as president of the Illinois Street Railway Association.

## Financial News

**Brooklyn Rapid Transit Company.**—The New York stock exchange has listed \$375,000 additional 50-year mortgage bonds due in 1945, making a total of \$7,000,000 listed; \$629,000 additional Brooklyn Queens County & Suburban Railroad first consolidated guaranteed 5 per cent bonds due in 1941, making a total of \$2,884,000 listed; \$3,500,000 Brooklyn Queens County & Suburban road first mortgage 5 per cent bonds due in 1941; and \$1,860,000 additional Brooklyn City Railroad first mortgage 5 per cent bonds due in 1941, making a total of \$6,000,000 listed.

**Chicago Union Traction Company.**—Charles H. Aldrich has appealed to the United States supreme court concerning the reorganization plan. A hearing will be held in Washington on January 22. Mr. Aldrich, representing various security holders, charges that his clients are not being treated fairly by those in charge of reorganization; that Judge Grosscup has exceeded his authority in recognizing the reorganized company and has "extrajudicially approved and associated himself with the scheme and has ever since, out of court and personally, advocated such scheme and actively co-operated with the promoters thereof." As the Chicago Railways Company ordinance must be accepted by February 1 the success of the reorganization plan is endangered once more.

**Grand Valley Railway Company, Brantford, Ont.**—This company, control of which passed to a syndicate of Pittsburgh and Buffalo capitalists a short time ago, has acquired control of the Brantford Street Railway and the Woodstock Thames Valley & Ingersoll Electric Railway Company, and proposes to rehabilitate the three properties and build 90 miles additional track, including seven additional miles in Brantford. The company holds a Dominion charter authorizing it to build and operate vessels, construct telegraph or telephone lines, operate an express business and granting other broad privileges. The company is authorized to issue bonds at the rate of not exceeding \$30,000 per mile of completed electric railway. The financial interests are represented by the Traction Securities Development Company and bonds to be issued as fast as the new work has been completed are reported fully subscribed. Murry A. Verner of Brantford, Ont., is president of the company.

**Lehigh Valley Transit Company, Allentown, Pa.**—At the annual meeting of stockholders on January 13 John C. Dawson and C. E. Ingersoll of Philadelphia were elected directors to succeed John C. Newbold and David Young. Mr. Dawson was elected vice-president. The annual report showed gross earnings of \$926,799 by the railway lines and \$104,761 net earnings from electric light properties and other sources. The gain in railway gross earnings was 4 per cent. Gross earnings from the electric lighting department increased 15 per cent. There was a surplus of \$5,264 after payment of fixed charges.

**Lynchburg (Va.) Traction & Light Company.**—An offering of \$200,000 out of an authorized issue of \$250,000 of 6 per cent convertible bonds, secured by the general mortgage executed recently to the Logan Trust Company of Philadelphia as trustee, has been made by Bioren & Co., of Philadelphia. The bonds are convertible into stock at par at any time until maturity, on December 1, 1917. The bonds are dated December 1, 1907, and are subject to call on any interest date at 103 and interest.

**Newtown (Pa.) Railway.**—A certificate has been filed at Harrisburg showing the creation of \$375,000 indebtedness as part of the plan for the sale of the property of the Newtown Railway and the Newtown Langhorn & Bristol Street Railway to the Bucks County Electric Railway.

**New York City Railway.**—In an opinion delivered by Justice Peckham the United States supreme court has denied the petition for the issuance of a writ of mandamus against Judge Lacombe of the United States circuit court of New York, directing him to vacate orders for the appointment of a receiver for the New York City Railway and the Metropolitan Street Railway. In his opinion Justice Peckham said: "Jurisdiction to appoint a receiver by a circuit court of the United States in cases of railroads engaged in interstate commerce has existed by reason of diversity of citizenship in various cases between the parties to the litigation, and not because the railroads were engaged in interstate commerce. The necessary diversity of citizenship is alleged to exist in the cases before the circuit court, and there is no suspicion as to the truth of the averment. \* \* \* While so holding we are not unmindful of the fact that a court is a very unsatisfactory body to administer the affairs of a railroad as a going concern,

and we feel that the possession of such property by the court, through its receivers, should not be unnecessarily delayed. There are cases—and the one in question seems a very strong instance—where, in order to preserve the property for all interests, it is a necessity to resort to such a remedy. A refusal to appoint a receiver would have led in this instance almost inevitably to a very large and useless sacrifice in value of a great property."

**North Jacksonville Street Railway Town & Improvement Company, Jacksonville, Fla.**—The property of this company was sold under foreclosure on January 6 to Henry M. Endicott, Jr., of Boston, Mass., for \$70,000. This road had been controlled by colored people and was built with capital raised by their efforts. The property was sold under decree of foreclosure of the United States circuit court in the suit wherein Mr. Endicott was complainant and the company and others defendants.

**Rochester (N. Y.) Railway & Light Company.**—An initial dividend of 5 per cent has been declared on the \$6,500,000 common stock.

**Springfield (Mass.) Street Railway.**—At the annual meeting of stockholders on January 6 Henry C. Page, vice-president and general manager, was elected a director.

**Underground Electric Railways, London.**—Holders of over \$16,000,000 of the American issue of \$16,550,000 of 5 per cent profit sharing notes have accepted the offer of Speyer & Co., and have sold the December coupons to that firm.

**West End Street Railway, Boston.**—It is announced that shareholders subscribed for about \$920,000 of the \$1,010,900 new stock offered recently for subscription.

**Western Ohio Railway, Lima, O.**—The \$400,000 of preferred stock has been listed on the Cleveland stock exchange.

**ELECTRIC RAILWAY EARNINGS.**

**American Railways Company, Philadelphia (Subsidiary Companies).**

Gross earnings—	1907.	1906.
December .....	\$ 231,561.55	\$ 234,798.76
July 1 to December 31.....	1,571,486.39	1,490,715.99

The Lackawanna avenue bridge, the principal thoroughfare in Scranton, Pa., was closed to all traffic (including street cars), affecting receipts there for about 10 days in December.

**Norfolk & Portsmouth Traction Company, Norfolk, Va.**

November—	1907.	1906.
Gross earnings .....	\$202,006.99	\$145,950.21
Operating expenses .....	144,252.60	86,910.14
Net earnings .....	57,754.39	59,040.07
January 1 to November 20—	1907.	1906.
Gross earnings .....	\$2,436,819.09	\$1,562,853.74
Operating expenses .....	1,503,875.08	1,013,192.59
Net earnings .....	932,944.01	550,663.15

**United Railways of St. Louis.**

December—	1907.	1906.
Gross earnings and other income.....	\$870,002	\$875,126
Expenses, taxes and depreciation.....	557,907	545,313
Net earnings .....	312,095	329,813
Charges .....	231,494	232,199
Net income .....	80,601	97,614
January 1 to December 31—	1907.	1906.
Gross earnings and other income.....	\$10,828,737	\$10,287,889
Expenses, taxes and depreciation .....	7,043,882	6,400,989
Net earnings .....	3,784,855	3,886,900
Charges .....	2,778,023	2,782,249
Net income .....	1,006,832	1,104,651

**Dividends Declared.**

- Charleston (S. C.) Consolidated Railway Gas & Electric Company, preferred, quarterly, 1½ per cent.
- Columbus (O.) Railway, preferred, quarterly, 1¼ per cent.
- East St. Louis & Suburban Company, East St. Louis, Ill., preferred, quarterly, 1¼ per cent.
- Georgia Railway & Electric Company, Atlanta, Ga., preferred, quarterly, 1¼ per cent.
- Milwaukee Electric Railway & Light Company, preferred, quarterly, 1½ per cent.
- Montreal Street Railway, quarterly, 2½ per cent
- Peeckskill (N. Y.) Lighting & Railroad Company common, quarterly, 1 per cent.
- Philadelphia Company, Pittsburg, common, quarterly, 1½ per cent.
- Rochester (N. Y.) Railway & Light Company common 5 per cent.
- Syracuse (N. Y.) Rapid Transit Company, common 3 per cent.

# Manufactures and Supplies

**ROLLING STOCK.**

**Topeka Southwestern Railway, Topeka, Kan.,** is asking prices on a number of cars.

**Newell Street Railway, Newell, W. Va.,** it is reported, will purchase a number of cars to be used as trailers.

**Northern Ohio Traction & Light Company, Akron, O.,** it is reported, will soon place an order for four interurban cars.

**Westchester Traction Company, Ossining, N. Y.,** expects to make a considerable increase in its equipment during 1908.

**Syracuse & Suburban Railroad, Syracuse, N. Y.,** is reported to have placed an order with the Jewett Car Company for a number of cars.

**Jacobs Welding Company, Chicago, Ill.,** has ordered from the McGuire-Cummings Manufacturing Company one 34-foot closed car body with steel underframe and McGuire-Cummings 39A trucks.

**Indiana Union Traction Company, Anderson, Ind.,** is preparing the specifications for a number of cars, to replace those lost in the destruction of the Tipton, Ind., car house, reported in the Electric Railway Review of November 9.

**SHOPS AND BUILDINGS.**

**Washington & Canonsburg Railway, Washington, Pa.**—The company's car house and repair shops were badly damaged by fire recently. The loss will reach several thousand dollars. Two cars were damaged.

**TRADE NOTES.**

**R. C. Hallett** has been appointed manager of the railway department of the Vacuum Cleaner Company, with headquarters in the main office, 72 Trinity place, New York.

**Clark Manufacturing Company, Grand Rapids, Mich.,** has been organized for the manufacture of a lightning arrester, the invention of George W. Clark. The company will be incorporated with a capital stock of \$10,000. The officers are: George W. Clark, president; J. B. Doyle, treasurer; L. L. Ronan, secretary.

**Western Tube Company, Kewanee, Ill.,** on January 13 elected the following officers: William B. Schiller, president; Edward Worcester, vice-president; and John D. Culbertson, secretary and treasurer. These three with Taylor Allderice and J. C. Bannister constitute the board of directors. Mr. Bannister is manager of the company.

**F. K. Rhines, engineer,** has become assistant to the treasurer and general manager of the General Fireproofing Company of Youngstown, O., having assumed the new position January 1. Mr. Rhines formerly was engineer with the East Iron & Machine Company, bridge builder, at Lima, O., and more recently has been chief engineer and general manager of the Dixon Engineering & Construction Company of Toledo, O.

**Lord Electric Company** announces that W. R. Garton, formerly president and treasurer of the W. R. Garton Company of Chicago, whose resignation from the Garton company and association with the Lord Electric Company was mentioned in the Electric Railway Review of December 28, has been appointed general manager of its manufacturing department and will be located at the company's general offices, 213 West Fortieth street, New York City.

**B. S. Barnard & Co.,** manufacturers of electrical clay conduits, 39 Cortlandt street, New York, have opened a western office at 429 and 430 Monadnock block, Chicago, in charge of E. F. Kirkpatrick, who has recently formed a partnership with B. S. Barnard, and is vice-president of the company. Mr. Kirkpatrick has been identified with the electrical business in Chicago and the middle west for 20 years, and has a wide circle of acquaintance. For the past seven years he has been connected with the McRoy Clay Works.

**Glidden Varnish Company, Cleveland, O.,** announces that its new factory at Cleveland is entirely completed and in full operation, after having been in course of construction for a year and a half. The old factory, which has been the home of the company since it was organized in 1874 as Glidden, Brackett & Co., is idle for the first time in its history. The magnificent new plant, which has cost over a half million dollars, occupies 17 acres and is built entirely of brick, concrete and steel, is the largest and most perfectly appointed exclusive varnish factory in the world both in capacity for

making and for storing varnish. It also has a very large and complete grinding department, where the celebrated Jap-a-Lac is made. The company is naturally proud of its new home and extends a cordial invitation to visitors to Cleveland, who are interested, to call and inspect its works.

**Wheel Truing Brake Shoe Company, Detroit, Mich.**, is one of the companies that report no great decrease in business as a result of the late financial stringency. Electric railway managements have found the wheel truing device so economical in extending the safe operating period of wheels that the demand has been maintained through the lethargic period. By the use of the truing brake shoe many companies have been able to take wheels, partially worn through the chill, from the scrap pile and obtain a large mileage from them.

**American National Corporation** has been incorporated with a capital stock of \$50,000 to succeed the American Engineering Company of Indianapolis, Ind. It has the same officers as the old company, with the exception of the secretary, W. H. Kirshner, taking the place of E. W. Barrows. Charles N. Wilson, whose resignation as president of the American Engineering Company was announced in a recent issue of the Electric Railway Review, heads the new corporation. W. W. Critchlow is vice-president, and the officers, together with Charles N. Van Cleve and F. S. Hines, form the board of directors. The corporation will build electric railways and audit the accounts and appraise electric lines.

**Railway Specialty & Supply Company, Great Northern Building, Chicago**, has been appointed agent for the Hayes Track Appliance Company, Geneva, N. Y., in the Chicago district. The company is prepared to furnish catalogues and issue descriptive matter and all information desired in connection with the Hayes derail. The company has also been appointed agent in Chicago for the sale of Kopp signal glass manufactured by the Pittsburg Lamp Brass & Glass Company. This glass has been used for a number of years on almost every railroad in the country. It was the first solid color glass manufactured on a commercial scale. The company will furnish promptly all styles of lenses, roundels and lantern globes or any information regarding them.

**Lord Electric Company** of New York, Boston and Chicago has very recently made a marked change and improvement in its manufacturing department. It is greatly broadening the field of its activities and the scope of this department, having acquired valuable patent rights, and it is preparing to manufacture the devices covered by those patents. The company has been actively engaged in the electrical field manufacturing and supplying rail bonds, lightning arresters, kindred devices and appliances. The thoroughness with which the company has undertaken and prosecuted its work has been demonstrated by the broad field which has been covered and the amount of trade developed. The success attained in bringing out and developing its line has encouraged the company to take on additional patented specialties, which, it is expected, will appeal to the operator because of their superior character and the fact that they effect a saving, thus insuring increased dividends. The Lord Electric Company, through this extension of its business, will be given greater prominence in the electrical field than it has before assumed.

**National Tube Company, Pittsburg, Pa.**, announces that on January 1, 1908, the sales departments of the Western Tube Company of Illinois and the Shelby Steel Tube Company of New Jersey were consolidated with the sales department of the National Tube Company and hereafter all business will be done under this name. While it has been well known to the trade that the Western and Shelby companies were constituents of the National Tube Company, these concerns have hitherto maintained separate sales departments. The personnel of the new sales organization of the National Tube Company is as follows: Edward Worcester, first vice-president and general manager of sales; James W. Downer, assistant general manager of sales; John Duncan, assistant general manager of sales; H. S. White, assistant general manager of sales. All these officers will be stationed at the general office of the company at Pittsburg. For the greater convenience of the trade nine local sales offices will be maintained instead of five, and will be located as follows, in charge of the following managers: New York, Battery Park building, Clifton Wharton, Jr., manager of sales; suboffice, Pennsylvania building, Philadelphia; Pittsburg, sixteenth floor Frick building, A. M. Lally, manager of sales; Chicago, Commercial National Bank building, H. S. Raymond, manager of sales; St. Louis, Chemical building, E. A. Downey, manager of sales; San Francisco, Crocker building, George S. Garritt, manager of sales; Thomas W. Brooks, assistant manager of sales; Portland, Ore., R. R. Hoge, manager of sales; suboffice, Seattle, Wash.; Denver, Majestic building, Edwin H. Fowle, manager of sales; New Orleans, Hugo Weidmann, manager of sales; Atlanta, Ga., Candler building, Edward Worcester, Jr., manager of sales.

## ADVERTISING LITERATURE.

**Samson Cordage Works, Boston, Mass.**—A calendar of handy size and unique design directs attention to the merits of Samson spot cord.

**Worcester Polytechnic Institute, Worcester, Mass.**—The thirty-eighth annual catalogue of the Worcester Polytechnic Institute is a pamphlet of 232 pages, 5¼ by 8¾ inches.

**Arlington Manufacturing Company, Canton, O.**—A booklet describes various paint products especially made for railways, builders, contractors, manufacturers and industrial plants.

**Gulick-Henderson & Co., 439 Third Avenue, Pittsburg, Pa.**—Results of tests made by this company are contained in recently issued bulletins, one devoted to "Cupola Melting" and the others to "Iron Melted per Pound of Coke."

**Railway Specialty & Supply Company, Great Northern Building, Chicago, Ill.**—Bulletin S1127 describes a new bond wire protector, which is designed to prevent vibration in bond wires and to hold them out of the way of tools used in track work. The device has been approved by the signal board of one of the largest railway systems.

**Murray Iron Works Company, Burlington, Ia.**—An interesting and instructive publication is devoted to the nomenclature of various types of Corliss engines, built by this company. Each type is first illustrated by a large halftone, followed by cuts from detail line drawings in which each part is named individually. Three halftone views are included to show the extent of the company's plant.

**Allis-Chalmers Company, Milwaukee, Wis.**—The hydraulic transmission pump, described in Bulletin No. 1604, is built for any capacity desired up to 400 gallons per minute, and pressures as high as 6,000 pounds per square inch. Pumps of this type are particularly adapted for apparatus of all kinds which depends for its successful operation upon the delivery of water or other liquids under heavy pressure.

**Taft-Pierce Manufacturing Company, Woonsocket, R. I.**—A pamphlet entitled "A Modern Specialty Factory," by James B. Griffith, a series of three articles reprinted from the Business Man's Magazine, is being distributed. This company specializes in manufacturing machinery, or mechanical appliances for inventors, owners of patents, etc. The catalogue is well illustrated with views of the machine shop and reproductions of blanks used in the factory records.

**Massachusetts Fan Company, Watertown, Mass.**—This company has now in press an additional section of its perpetual catalogue. This section, which comprises 16 pages, and is entitled "Vertical and Horizontal Engines for Fan Driving," includes illustrations, descriptions, dimensions and horsepower tables. The entire catalogue is thus brought up to a total of 116 pages of matter relating to blowers and exhausters, heating, ventilating, drying and mechanical draft apparatus, etc.

**Westinghouse Electric & Manufacturing Company, Pittsburg, Pa.**—Circular No. 1137 comprises 54 pages which are of especial value as a permanent reference for those who have to do with integrating wattmeters. The publication includes accurate and detailed descriptions of the meters for single-phase and polyphase alternating-current circuits and for direct-current circuits. The instruments described are suitable for all classes of service, including switchboard, house and portable meters. Each class of meters has the fundamental principles on which it operates described and plentifully illustrated. There are 62 engravings serving this purpose and the book includes a number of useful tables of standard capacities. Sixteen pages of the pamphlet comprise diagrams of connections for the various types of meters described.

**James G. Wilson Manufacturing Company, 3 West Twenty-ninth Street, New York, N. Y.**—Catalogue No. 34, which has just been issued, is a complete handbook of various types of rolling shutters and apparatus in bronze, steel and wood. The publication is prepared with a view to presenting useful and valuable information to engineers and architects in preparing building plans and specifications and contains not only working drawings of the various types of doors and partitions but also presents a large number of halftones showing the types of doors installed in different classes of buildings. These serve to indicate the door peculiarly adapted to any particular class of structure. The features to be considered in specifying a particular type of door are also fully covered. Features of convenience, such as wire glass panels for furnishing light and wicket doors in large rolling doors, are also shown. The working drawings showing the device peculiarly adapted for bridging the space occupied by rolling steel shutters in the car house of electric lines, as well as a continuous-current device, are features of the catalogue.

## DANVILLE CARS FOR MEXICO.

The Danville Car Company, Danville, Ill., has recently built for the street railway system of Parral, Mexico, four of its semi-steel semi-convertible motor car bodies for first-class service. The length of the body of each car over corner posts is 19 feet  $5\frac{1}{2}$  inches; total length over bumpers, 28 feet  $5\frac{1}{2}$  inches. The width over all is 8 feet 2 inches. Two second-

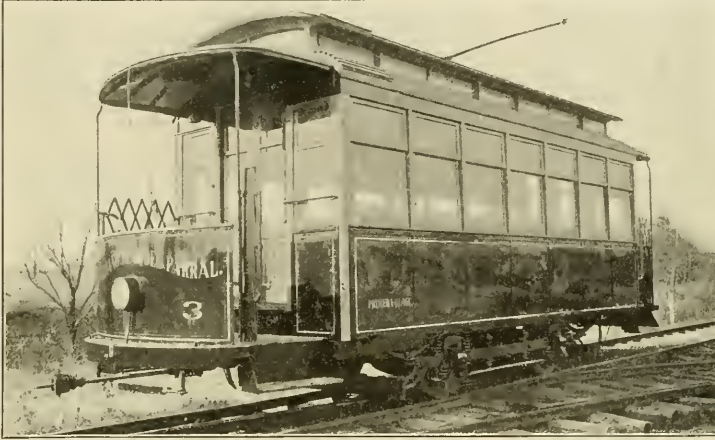

Danville Semi-Steel Cars for Mexico—First-Class Passenger Car.

class closed trailer car bodies of the same dimensions were also built at Danville for this street railway system.

The interior finish of the cars, including doors, sashes and moldings, is of ash. The side sills are of yellow pine with a steel plate between. Subsidiary sills on each side for the truck are also framed of yellow pine, while the end and cross sills are of oak. The body framing is of ash and the longitudinal rails and plates of yellow pine. The sides of the cars are covered longitudinally with tongued and grooved yellow pine and from the arm rail down are covered with No. 14 sheet steel in panels. The interior sides of the car are of No. 14 sheet steel riveted together in one length and forming an interior truss. The roof is of the monitor deck type, extending the entire length of the body.

The first-class motor cars have five cross seats on each side and four longitudinal seats in the corners, of Hale & Kilburn manufacture. The second-class trailers are equipped with longitudinal seats made of ash plate. The curtains are of printed duck mounted on Hartshorn rollers with Forsythe No. 26 bottom fixtures.

In addition to the above equipments the Danville Car Company has also built for the same company one 24-foot motor gondola car, 8 feet in width, and four 24-foot trailer gondola cars of the same width as the motor cars. The bottom framing of the trailer gondola cars is of yellow pine. The side sills of the motor gondolas are plated with steel, the subsidiary sills on each side for the trucks being of yellow pine. Each motor car is equipped with a brake staff on each platform provided with a malleable iron ratchet brake handle. The drawbars are of plain wrought iron with link-and-pin couplers. Sand boxes, worked by a pedal, are located at diagonal corners of the cars. One 12-inch pedal alarm gong is placed on each platform.

Austria has 292 miles of electric railways, of which about 50 per cent is double track.

## WESTINGHOUSE COMPANY REORGANIZATION.

The reorganization committee of the Westinghouse Electric & Manufacturing Company, at a meeting held in New York on January 10, practically perfected its plan for the reorganization of the company. The appointment of this committee was noted in the Electric Railway Review of December 28, 1907. The plan, in its general outlines, has been adopted by unanimous vote of the members of the committee, but is subject before final adoption to the consent of noteholders and bondholders and to the subscription of \$7,000,000 by George Westinghouse and his associates for new stock. The plan will be printed in detail and sent to security-holders and creditors next week. The principal provision contemplates the creation of a first mortgage bond issue of \$45,000,000 to bear interest at 5 per cent. Of the entire issue \$18,500,000 will be convertible bonds and will be offered in exchange for the \$18,500,000 outstanding convertible 5 per cent bonds. The proceeds of the remainder will be utilized to pay off the floating indebtedness and outstanding short-term notes and debentures. According to the report of Haskins and Sells, certified accountants, the company had on the date of the report a floating indebtedness of \$14,000,000. It is proposed to fund most of this indebtedness by offering to creditors the new bonds, dollar for dollar, for their claims. Holders of the \$1,969,000 debenture

certificates of the \$6,000,000 6 per cent collateral notes, due on August 1, 1910, and the French loan, due on October 1, 1917, are to be asked to exchange their securities, dollar for dollar, for the new bonds. The floating and funded indebtedness of the company amounts to between \$43,000,000 and \$44,000,000.

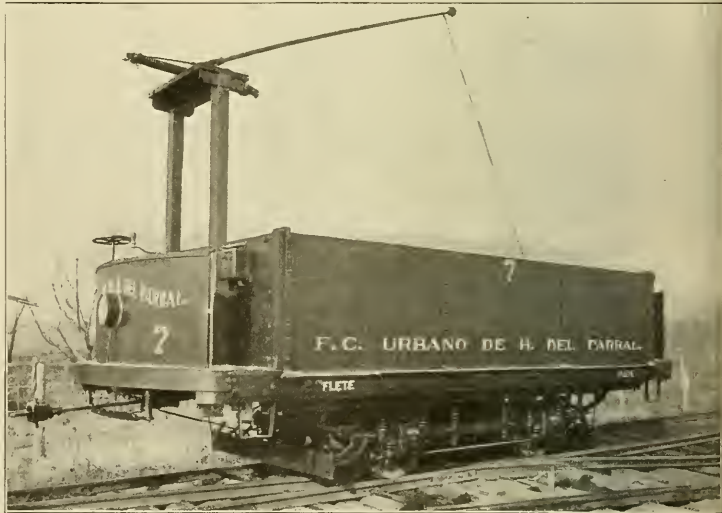

Danville Semi-Steel Cars for Mexico—Motor Gondola.

In order to provide working capital the plan provides for the sale of \$7,000,000 stock at par. It is understood that George Westinghouse and his associates have agreed to take this stock or at least such portion of it as is not desired by stockholders. There is now outstanding \$4,000,000 preferred stock and \$24,000,000 assenting stock. The new stock will be of the latter class.

Economy of private power plants equipped with Western Electric generators is the subject of a recent circular.

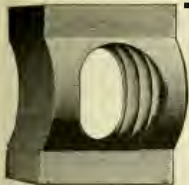

## Use GRIP NUTS on track bolts

and You Have a Better, Safer Track

GRIP NUTS never let loose under any strain, jar or vibration unless bolts break.

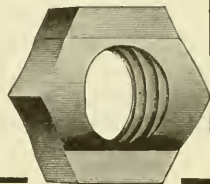

### GRIP NUT COMPANY

500 Fifth Avenue, NEW YORK

152 Lake Street, CHICAGO

## Approved

by the A. S. & I. R. A. Standardization Committee and by the management of progressive traction companies generally —because its adoption means an interchangeable standard, and the safest, most economical brake shoe practice.

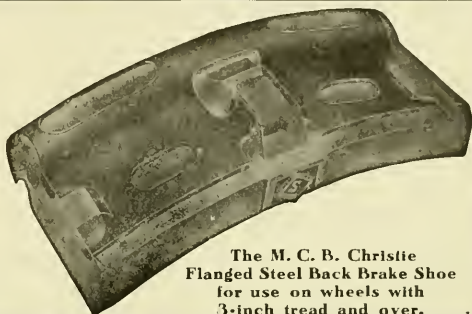

The M. C. B. Christie Flanged Steel Back Brake Shoe for use on wheels with 3-inch tread and over.

**American Brake Shoe & Foundry Co.**  
New York Chicago Chattanooga MAHWAH, N. J.

We buy for spot cash anything you may have for sale in the way of

**Railway Motors  
Armatures  
Commutators  
Scrap Copper, Etc.**

➡ No deal too large for us to handle ←

We refer to Bradstreet, Dun or any Cleveland bank.

## Cleveland Armature Works

4732 St. Clair Avenue : : CLEVELAND, OHIO

America's Greatest Armature Winding, Commutator and Field Works

## THE J. G. BRILL COMPANY, PHILADELPHIA, PA.

AMERICAN CAR COMPANY, ST. LOUIS, MO.  
 G. C. KUHLMAN CAR COMPANY, CLEVELAND, OHIO  
 JOHN STEPHENSON COMPANY, ELIZABETH, N. J.  
 WASON MANUFACTURING CO. SPRINGFIELD, MASS.

MAIN OFFICE: PHILADELPHIA, PA.  
 LONDON OFFICE: 110 CANNON ST. E. C.  
 PACIFIC COAST AGENTS: PIERSON  
 ROEDING & CO., SAN FRANCISCO.  
 AUSTRALIAN AGENTS: NOYES  
 BROTHERS, SYDNEY. CABLES:  
 "BRILL," PHILA., "AXLES" LONDON.

*CARS TRUCKS SEATS RATTAN SPRINGS SPECIALTIES SUPPLIES*

## NON-OSCILLATING FRAME

In spite of the fact that the Brill No. 27-GE<sub>1</sub> Truck has three sets of springs (one set more than any other truck of its class) working in series, and is the smoothest, easy-riding and most elastic truck in use to-day, it has that essential quality of a truck with outside-hung motors—a non-oscillating frame. The objectionable oscillation common to most trucks when running at a fair rate of speed, is entirely overcome in the Brill truck by the spring-link suspension of the load on the frame at wide-apart points and close to the yokes, enabling it to run steadily and smoothly at thirty miles an hour. There is no dangerous kicking-up of the frame under violent brake action, and, having a stable frame, the brake adjustment is reduced to the minimum. The non-oscillating frame is one of the best features of this truck.

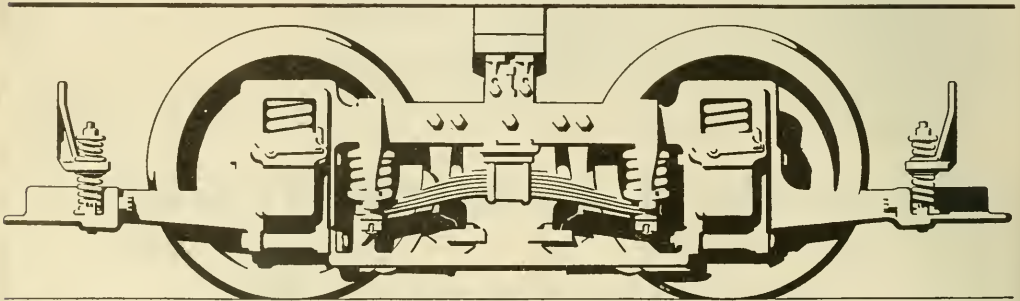

*THE BRILL NUMBER 27-GE<sub>1</sub> TRUCK (PATENTED)*

# General Electric Company



## Railway Motor Gears



Inspection and Testing

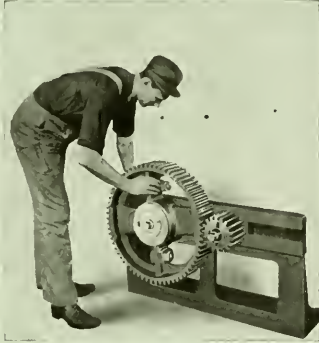

Inspection of Gears

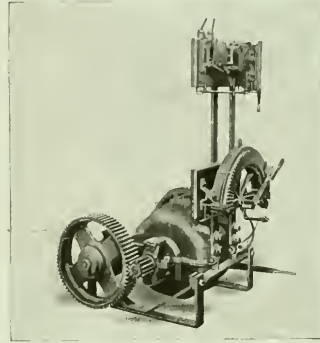

Testing of Gears

All gears are inspected and tested before shipment. Every bore, keyway, face, hub and each individual tooth is carefully and rigidly inspected with special gauges made for this purpose, and every gear is operated in both directions in a testing machine, to insure perfect meshing of teeth.

Before shipment all finished surfaces of gears are coated with white lead, to prevent rusting.

Let us submit to you a proposition covering your estimated requirements for the next year.

“Original Equipment Quality”

means

“Original Equipment Service”

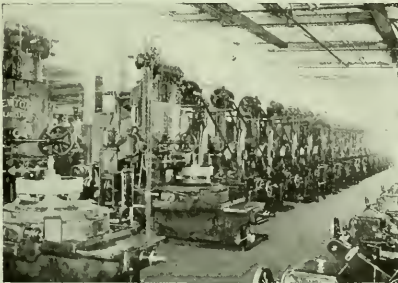

Portion of Gear Cutting Department Showing Vertical Gear Cutting Machines in Foreground



View of Stock Room in Gear Department

Chicago Office:  
Monadnock Bldg.

Principal Office:  
**Schenectady, N. Y.**

Sales Offices in All  
Large Cities

**Electric Railway Material**  
of every description  
**F. P. HARRISON ELECTRIC & MFG. CO.**  
(Incorporated) NEW YORK  
169-170 South St.

**LUFKIN**  
**MEASURING TAPES**  
are the choice of expert electrical engineers in all quarters of the globe. Absolute accuracy and the highest possible degree of durability make them especially adapted to Electric Railway Work.  
New York, London, Eng., Windsor, Can.  
**THE LUFKIN RULE CO.**  
SAGINAW MICH., U. S. A.



**VALVES—FITTINGS—STEAM SPECIALTIES**  
**CRANE CO.**  
CHICAGO  
ESTABLISHED 1855



**40% SAVED**  
BY USING  
**Lumen Bronze Axle Bearings**  
Cast in metal mold—require no machine finish  
**Lumen Bearing Company**  
BUFFALO — TORONTO

**The Dispatcher Knows** that his stop order has been executed by  
**the Telegraph Signal System**

—because, after the order has been completed, the number of the station to which it was sent is automatically recorded on the dispatcher's tape register.

That's a mighty important point. You know a system that does not provide positive evidence of the execution of a stop order is fatally defective!  
*OUR SYSTEM HAS PROVED ITS WORTH IN ACTUAL USE.* WRITE US.

**Telegraph Signal Company, 282 State Street, Rochester, N. Y.**

**Passenger Paying Fare**

Every nickel collected is registered before reaching the conductor's hand when you use the

**Rooke Automatic Fare Collector**

The Rooke System is a revolution in fare-collecting methods, and as far superior to old systems as the trolley car is to the horse car.

Why not ask us to prove it?

**Rooke Automatic Register Co.**  
PROVIDENCE RHODE ISLAND

**WADDELL & MAHON**  
Special Agents

PHILADELPHIA OFFICE Room 312 Lippincott Bldg.  
Long Distance Telephone 2408 Walnut

BALTIMORE OFFICE Room 406 Baltimore American Bldg.  
Long Distance Telephone 5347 St. Paul

BOSTON OFFICE Room 411 Post-Office Square Building  
Long Distance Telephone, 959 Fort Hill

**ALWAYS ON DUTY**  
1133 BROADWAY  
Suite 1024 and 1026 St. James Building  
NEW YORK

Long Distance Telephone 4382 Madison Sq. Night { 2'05 Melrose  
Telephones } 2903 Melrose

**Have You Any Labor Troubles?  
Do You Anticipate Trouble?  
We Are Licensed Special Agents**

We are not a Detective Agency, but Special Agents who act for Corporations and Manufacturers in the termination of labor difficulties. We secure and furnish non-union mechanics in all trades, and skilled labor in all branches of industry, for service during strikes, and establishing the open shop. We also furnish Special Police Patrolmen, trained to their duties for the protection of non-union workmen and security of property. We establish, operate and maintain Commissaries for the maintenance of non-union workmen, performing Special Service during strikes and lockouts.

**We Are Not a Detective Agency  
We Are Successful  
We Get Results**



# Electric Railway Review

PUBLISHED EVERY SATURDAY. FORMERLY THE STREET RAILWAY REVIEW. THE WILSON COMPANY, CHICAGO.

160 Harrison Street, Chicago  
150 Nassau Street, New York  
1529 Williamson Bldg., Cleveland

Vol. XIX  
No. 4

CHICAGO, JANUARY 25, 1908

Whole No. 248  
Subscription: Domestic . . . \$2  
Foreign . . . \$5  
Canada . . . \$3.50

## Save Time, Money, Lives

Instantly the dispatcher can set a stop signal against any car or train, IF your line is equipped with the

## Telegraph Signal System

Accidents  
Prevented  
Traffic  
Facilitated

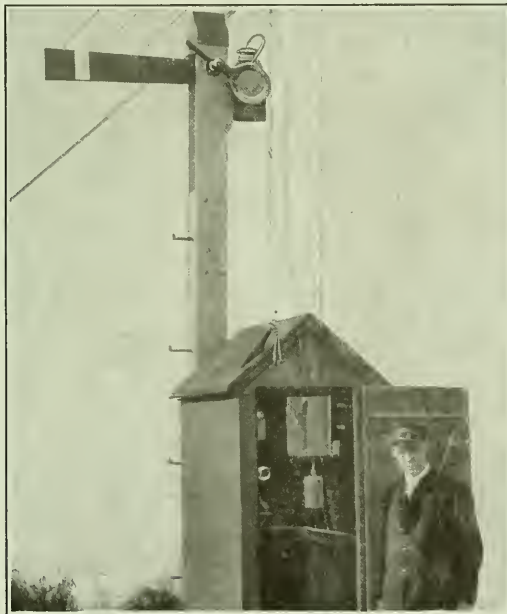

Schedule  
Adhered  
to More  
Closely

The dispatcher knows that his order has been executed—because, after its completion, the number of the station to which it was sent is automatically recorded on the dispatcher's tape register.

*One Line Wire—Installation Cost Extremely Low—Write for Descriptive Literature.*

**TELEGRAPH SIGNAL COMPANY** 282 STATE STREET  
ROCHESTER, N. Y.

# ARMATURE AND FIELD COILS

of a Special Manufacture and High Quality

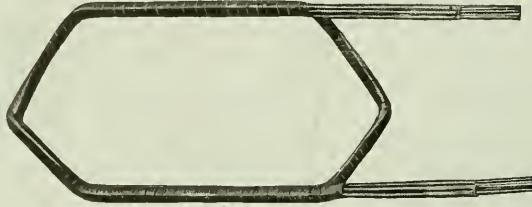

Armature Coils furnished by this Company have a special form of mica insulation. All coils are made to fit perfectly in slots without hammering and are thoroughly tested before leaving the factory.

Field Coils are placed under a vacuum, which removes all objectionable moisture. They are then impregnated with a solid compound which gives them high insulation and high heat resistance.

## ELECTRIC SERVICE SUPPLIES Co.

"Supplies for Every Electric Service"

MAYER & ENGLUND DEPT.  
PHILADELPHIA

NEW YORK

GARTON-DANIELS DEPT.  
KEOKUK

PITTSBURG

SAINT LOUIS

PORTER & BERG DEPT.  
CHICAGO

ATLANTA

# National Air Brakes

## EMERGENCY VALVES WITH QUICK-RELEASE FEATURE.

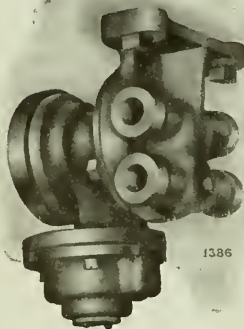

"National" Emergency Quick-Release Valve

WRITE FOR DESCRIPTIVE BULLETIN.

The new "National" Emergency Valve with quick-release feature combines with the straight air brake system the emergency quick-set and quick-release features of the automatic system. This is the most simplified type of emergency apparatus, requiring one-third less piping than any other emergency equipment.

## National Brake & Electric Co.

NEW YORK: 111 Broadway  
PHILADELPHIA: 1722 Westmoreland St.  
BOSTON: F. E. Huntress, 131 State St.

Milwaukee, U. S. A.

SAN FRANCISCO, CAL.: W. F. McKenny,  
526 Mission St.  
LONDON: 14 Great Smith St., Westminster

General Sales Office: 519 First National Bank Building, Chicago

# Westinghouse

## Steam Turbines



Have No Secrets of Construction

The simple method of blade mounting; the water sealed packing glands surrounding the shaft; the automatic speed limit; the automatically controlled secondary valve, allowing enormous overloads; the oil cushioned journals, are all details well known to the power using public.

Steam Turbine Publication 7002 gives a detailed description; ask for it.

### The Westinghouse Machine Co.

Steam Turbines, Steam Engines, Gas Engines, Gas Producers, Storage Batteries and The Roney Stoker

New York, 10 Bridge Street  
 Boston, 131 State Street  
 Atlanta, Candler Building  
 St. Louis, Chemical Building

Pittsburg, Westinghouse Building  
 Cleveland, New England Building  
 Chicago, 171 La Salle Street  
 Cincinnati, Traction Building

Philadelphia, North American Building  
 Denver, McPhee Building  
 San Francisco, Hunt, Mirk & Co.

## Type "J" Electric Pump Governor



The Type "J" Electric Pump Governor automatically controls the action of motor-driven air compressors so that they work only when required to maintain pressure in the air reservoir. It thus automatically keeps the air pressure within certain predetermined limits, and effects a considerable saving in current. It may be placed on either the positive or negative side of the circuit, and can be used on either alternating or direct current.

The Type "J" Governor is positive in action, definite in range, and easily maintained.

Fully described in Pamphlet T-5042

Westinghouse Traction Brake Co., Pittsburg, Pa.

## Westinghouse

### No. 101-B2 Railway Motor

A Modern Motor for Modern Traffic



A double equipment is suitable, under usual conditions, for single- or double-truck cars weighing not over 18,000 lbs. without equipment. A quadruple equipment is best for double-truck cars weighing not to exceed 35,000 lbs. without equipment.

Full particulars in Circular 1089.

### Westinghouse Electric & Mfg. Co.

Atlanta	Cincinnati	Kansas City	New York	Salt Lake City
Baltimore	Cleveland	Los Angeles	Philadelphia	San Francisco
Boston	Dallas	Minneapolis	Pittsburg	Seattle
Buffalo	Denver	New Orleans	St. Louis	Syracuse
Chicago	Detroit	Mexico	G. & O. Braniff & Co.	City of Mexico

Canada: Canadian Westinghouse Co., Ltd., Hamilton, Ont.

## ALPHABETICAL INDEX TO ADVERTISEMENTS.

Aeae White Lead & Color Works.....13	Detroit Graphite Co.....26	Marshall, R. W., & Co.....21	Sheaff & Jostaad.....18
Advance Lumber Co.....23	Drouvé, The G., Co.....30	Massachusetts Chemical Co.....12	Simmons, John.....18
Allis-Chalmers Co.....23	Drummond Detective Agency.....13	Meyers, Fred J., Mfg. Co.....25	Smith, Peter, Heater Co.....25
Aluminum Co. of America.....5	Durkin Controller Handle Co.....13	Middletown Car Works.....21	Speer Carbon Co.....21
American Brake Shoe & Fdry. Co.....27	Earll, C. I.....18	Miller Anchor Co.....22	Standard Brake Shoe Co.....22
American Electrical Works.....30	Eclipse Railway Supply Co.....18	Milloy Electric Co., The.....17	Standard Motor Truck Co.....22
American Frog & Switch Co.....25	Electric Railway Equipment Co.....13	Model Stoker Co., The.....22	Standard Paint Co.....17
Anderson, Albert & J. M., Mfg. Co.....11	Electric Service Supplies Co.....2	Morden Frog & Crossing Wks.....14	Standard Steel Works.....18
Armstrong Oilier Co.....21	Engineers and Contractors.....22	National Brake & Electric Co.....2	Standard Underground Cable Co.....12
Arnold Company.....22	Fairbanks, Morse & Co.....11	National Carbon Co.....25	Standard Varnish Works.....12
Atlas Anchor Co.....18	Ford, Bacon & Davis.....11	National Lock Washer Co.....25	Star Brass Works.....18
Babeock & Wilcox Co.....12	Galena-Signal Oil Co.....30	Naugle Pole & Tie Co.....25	Stone & Webster Engr. Corp.....22
Baker, The Wm. C., Heating & Supply Co.....15	General Electric Co.....23	New York Switch & Crossing Co.....14	Stowland Co.....26
Baldwin Locomotive Works.....18	General Storage Battery Co.....21	Niles Car & Mfg. Co.....15	Symington, T. H., Co.....26
Barbour-Stockwell Co.....13	Gillette Chemical Co.....23	Northern Engineering Works.....17	Telegraph Signal Co.....25
Barnes, G. H., Hardwood Lumber Co.....23	Goheen Mfg. Co.....17	Nuttall, R. D., Co.....23	Trolley Supply Co.....11
Beaver Dam Malleable Iron Co.....26	Goldschmidt Thermit Co.....17	Ohio Brass Co.....23	Under-Feed Stoker Co.....18
Beidler, Francis, & Co.....23	Green Engineering Co.....23	Okonite Co., Ltd.....23	United States Graphite Co., The.....25
Bellamy Vestlette Mfg. Co.....23	Green Fuel Economizer Co.....23	Pacific Coast Pole Co.....23	U. S. Metal & Mfg. Co.....21
Belthold & Co.....23	Griffin Wheel Co.....23	Pantaso Co.....23	Van Dorn & Dutton Co.....22
Blake Signal & Mfg. Co.....23	Grip Nut Co.....27	Patten, Paul B.....23	Van Dorn, W. T., Co.....25
Bliss, R. Mfg. Co.....15	Hagy, J., Milton, Waste Wks.....12	Pay-As-You-Enter Car Co.....9	Van Valkenburgh, E. C.....21
Bridgport Brass Co.....28	Hale & Kilburn Mfg. Co.....14	Power Specialty Co.....23	Wallace Supply Co.....20
Bruce, The J. G., Co.....28	Harrison, F. P., Elec. Mfg. Co.....30	Pressed Steel Car Co.....24	Wanted and For Sale Cards.....20
Brown, Harold P.....22	Hartshorn, Stewart, Co.....21	Queen & Co.....24	Watson Steel Castings & Coupler Co.....30
Brown Hoisting Machy. Co.....22	Heine Safety Boiler Co.....21	Rail Joint Co.....25	Watson-Stillman Co.....17
Buckeye Engine Co.....23	Heywood Bros. & Wakeland Co.....21	Railway Specialty & Supply Co.....24	Wendell & MacDuffie.....17
Burnham, Williams & Co.....18	Holman, D. F., Ry. Tracklayer Co.....17	Recording Fare Register Co.....21	Western Electric Co.....5
Bylesby, H. M., & Co.....22	Homer Conmutator Co.....17	Reed, Francis, & Co.....22	Westinghouse Elec. & Mfg. Co.....3
Central Inspection Bureau.....22	Hooven-Owens-Rentschler Co.....17	Reiter, G. C.....22	Westinghouse Machine Co.....3
Chase-Shawmut Co.....11	Hope Webbing Co.....23	Ridlon, Frank, Co.....22	Westinghouse Traction Brake Co.....3
Cherchill Cedar Co.....23	Humbird Lumber Co., Ltd.....23	Robert & Abbott Co.....22	Weston Electrical Instrument Co.....24
Cincinnati Car Co.....23	Indestructible Fibre Co.....23	Robertson, Wm., & Co.....5	Wharton, Wm., Jr., & Co.....24
Cincinnati Frog & Switch Co.....23	Jewett Car Co.....15	Rodger Ballast Car Co.....22	Wheeler Condenser & Eng'g Co.....24
Cleveland Armature Works.....11	Johann, F. A.....21	Rooke Automatic Register Co.....13	Whitmore Mfg. Co., The.....24
Cleveland Frog & Cross Co.....14	Johns-Manville, H. W., Co.....5	Reed, Francis, & Co. (Inc.).....21	Wilson, J. G., Mfg. Co.....12
Collier, Barron G.....22	Kinmar Manufacturing Co.....22	Russell Car & Snow-Plow Co.....26	Wood, Guilford S.....12
Columbia Construction Co.....22	Lindsay Bros. Co., The.....23	S. E. Missouri Cypress Co.....22	Woodman, R., Mfg. & Supply Co.....23
Consolidated Car Heater Co.....5	Lorain Steel Co.....18	St. Louis Car Wheel Co.....22	Worcester, C. H., Co.....23
Consolidated Car-Heater Co.....5	Lord & Burnham Co.....17	St. Louis Surfacar & Paint Co.....23	Zelnicer, Walter A., Supply Co.....21
Contractors' Supply & Equipment Co.....22	Luffkin Rule Co.....30	Sanderson, J. Porter.....22	
Cooper Heater Co.....5	Lumen Bearing Co.....23	Saxton, E.....22	
Craeghead Engineering Co.....22	Macallen Co.....23	Shimer & Chase Co.....22	
Curtain Supply Co.....22	McGuire-Cummings Mfg. Co.....18	Security Register & Mfg. Co.....22	
Davis, The John, Co.....13			
Dearborn Drug & Chemical Works.....17			

## CLASSIFIED LIST OF ADVERTISERS.

<b>Advertising Service.</b> Van Valkenburgh, E. C., 2117 West One Hundred and Second St., Chicago.	<b>Armature Lifts.</b> Electric Service Supplies Co., 200 Plymouth Bldg., Chicago.	<b>Bells and Gongs—Continued.</b> Electric Service Supplies Co., 1020-24 Filbert St., Phila., Cleveland. McGuire-Cummings Mfg. Co., Chicago. Ohio Brass Co., Mansfield, O. Reiter, G. C., Canton, O. St. Louis Car Co., St. Louis, Mo. Stephenson, John, Co., Elizabeth, N. J. Wallace Supply Co., Chicago. Wason Mfg. Co., Springfield, Mass. Western Electric Co., Chicago.	<b>Bonds, Rail—Continued.</b> General Electric Co., Schenectady, N. Y. Goldschmidt Thermit Co., 43 Exchange Pl., New York. Johns-Manville, H. W., Co., New York. Ohio Brass Co., Mansfield, O.
<b>Advertising, Street Car.</b> Collier, Barron G., Flat Iron Bldg., New York.	<b>Asbestos Materials.</b> Johns-Manville, H. W., Co., New York.	<b>Black Lead.</b> Detroit Graphite Co., Detroit, Mich. U. S. Graphite Co., Saginaw, Mich.	<b>Brackets and Cross Arms.</b> Anderson, Albert & J. M., Mfg. Co., Boston. Craeghead Engineering Co., Cincinnati, O. Electric Railway Equipment Co., Cincinnati, O. Electric Service Supplies Co., 200 Plymouth Bldg., Chicago. Lindsay Bros. Co., Spokane, Wash. Ohio Brass Co., Mansfield, O. Ridlon, Frank, Co., 200 Summer St., Boston. Stuart-Howland Co., Boston. Western Electric Co., Chicago.
<b>Air Brakes—(See Brakes and Brake Parts).</b>	<b>Axles—(See Wheels and Axles).</b>	<b>Block System—(See Signals).</b>	<b>Blowers—(See Mechanical Draft).</b>
<b>Air Compressors—(See Compressors, Air).</b>	<b>Babbitt Metals—(See Alloys and Bearing Metals).</b>	<b>Block System—(See Signals).</b>	<b>Blue Printing Machines.</b> Buckeye Engine Co., Salem, O.
<b>Alloys and Bearing Metals.</b> Brown, H. P., 120 Liberty St., New York. General Electric Co., Schenectady, N. Y. Harrison Elec. & Mfg. Co., 169 South St., New York. Lumen Bearing Co., Buffalo, N. Y. Ohio Brass Co., Mansfield, O. Ridlon, Frank, Co., 200 Summer St., Boston. St. Louis Car Co., St. Louis, Mo.	<b>Badges and Buttons.</b> Electric Service Supplies Co., 200 Plymouth Bldg., Chicago. Recording Fare Register Co., New Haven, Conn.	<b>Blowers—(See Mechanical Draft).</b>	<b>Bolers.</b> Babeock & Wilcox Co., N. Y. Fairbanks, Morse & Co., Chicago. Green Fuel Economizer Co., Matteawan, N. Y. Heine Safety Boiler Co., 421 Olive St., St. Louis. Lord & Burnham, Irvington-on-Hudson, New York. Rossiter, MacGovern & Co., 17 Battery Pl., New York.
<b>Aluminum Wire, Etc.</b> Aluminum Co. of America, Pittsburg.	<b>Ballast Cars—(See Cars, Ballast).</b>	<b>Block System—(See Signals).</b>	<b>Boiler Cleaning Compound.</b> Dearborn Drug & Chemical Works, Chicago. Johns-Manville, H. W., Co., New York.
<b>Anchors.</b> Atlas Anchor Co., Cleveland, O. Electric Service Supplies Co., 200 Plymouth Bldg., Chicago. Miller Anchor Co., Norwalk, O. Ohio Brass Co., Mansfield, O.	<b>Ball Bearings.</b> Symington, T. H., Co., Baltimore, Md.	<b>Blowers—(See Mechanical Draft).</b>	<b>Bonds, Rail.</b> Brown, H. P., 120 Liberty St., New York. Chase-Shawmut Co., Newburyport, Mass. Electric Railway Improvement Co., Cleveland, O. Electric Service Supplies Co., 200 Plymouth Bldg., Chicago.
<b>Armatures and Coils, Winding and Repairing.</b> Cleveland Armature Works, Cleveland, O. Electric Service Supplies Co., 200 Plymouth Bldg., Chicago. General Electric Co., Schenectady, N. Y. Harrison Elec. & Mfg. Co., 169 South St., New York. Marshall, R. W., & Co., 95 Liberty St., New York. Ridlon, Frank, Co., 200 Summer St., Boston. Stuart-Howland Co., Boston.	<b>Batteries.</b> General Storage Battery Co., 42 Broadway, New York.	<b>Blowers—(See Mechanical Draft).</b>	<b>Brakes and Brake Parts.</b> Allis-Chalmers Co., Milwaukee, Wis. American Car Co., St. Louis. Brill, The J. G., Co., Philadelphia. Electric Service Supplies Co., 200 Plymouth Bldg., Chicago. General Electric Co., Schenectady, N. Y. Kuhlman, The G. C., Car Co., Cleveland. McGuire-Cummings Mfg. Co., Chicago. National Brake & Electric Co., Milwaukee. Stephenson, John, Co., Elizabeth, N. J. Wason Mfg. Co., Springfield, Mass. Westinghouse Traction Brake Co., Pittsburg, Pa.
	<b>Bearings.</b> Electric Service Supplies Co., 200 Plymouth Bldg., Chicago. General Electric Co., Schenectady, N. Y. Harrison Elec. & Mfg. Co., 169 South St., New York. Lumen Bearing Co., Buffalo, N. Y. McGuire-Cummings Mfg. Co., Chicago. Marshall, R. W., & Co., 95 Liberty St., New York. Nuttall, R. D., Co., Pittsburg. Ohio Brass Co., Mansfield, O. Ridlon, Frank, Co., 200 Summer St., Boston. Symington, T. H., Co., Baltimore, Md. Van Dorn & Dutton Co., Cleveland, O.	<b>Blowers—(See Mechanical Draft).</b>	<b>Brakesoes.</b> American Brake Shoe & Fdry. Co., Mahwah, N. J. American Car Co., St. Louis. Barbour-Stockwell Co., Cambridgeport, Mass.



## All Strains Act as Crushing-Strains in the J-M Giant Strain Insulator

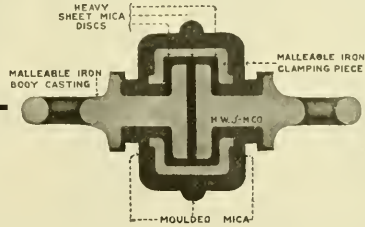

All crushing stress due to heavy strains are borne by Heavy Sheet Mica Discs, as illustration shows. The moulded compound bears none of this strain—it acts simply as an outer insulating covering.

This explains why J-M GIANT STRAIN INSULATORS will withstand 5,000 lbs. strain in the 2" size and 8,000 lbs. strain in the 2 3/8" size.

The outer surface, from eye to eye, is completely covered with Moulded Mica—insuring maximum surface insulation.

A trial order will demonstrate the truth of these claims.

Write nearest branch for Booklet D-431.

### H. W. JOHNS-MANVILLE CO.

- |           |              |               |             |
|-----------|--------------|---------------|-------------|
| NEW YORK  | PHILADELPHIA | BALTIMORE     | LOS ANGELES |
| MILWAUKEE | ST. LOUIS    | NEW ORLEANS   | SEATTLE     |
| CHICAGO   | PITTSBURG    | KANSAS CITY   | DALLAS      |
| BOSTON    | CLEVELAND    | MINNEAPOLIS   | LONDON      |
|           | BUFFALO      | SAN FRANCISCO |             |

698



Insulation is like good insurance — it pays.

### Electro Insulated

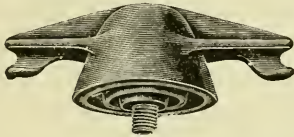

electric railway line material will positively insure your lines against insulation troubles. Write for our catalogue today.



It costs just two 5c fares

to heat a car 24 hours if you use a COOPER HEATER

Send for interesting pamphlet

The Cooper Heater Co., Dayton, Ohio

11

# ALUMINUM

## Railway Feeders

And all kinds of **Electrical Conductors**

Aluminum Feeders are less than one-half the weight of copper feeders and are of equal conductivity and strength. If insulated wire or cable is required, high grade insulation is guaranteed.

Write for prices and full information.

### Aluminum Company of America

PITTSBURGH, PA.

Formerly The Pittsburgh Reduction Company

## "Not an Experiment"

The Providence Fender has been in successful operation on hundreds of roads for 13 years, and has proved itself reliable under all conditions of Street Railway service.

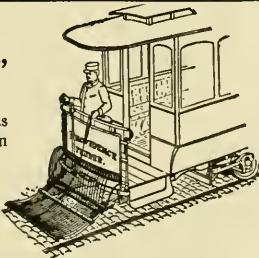

### CONSOLIDATED CAR FENDER COMPANY

Office and Factory: PROVIDENCE, R. I.

Branch Office: 110 E. Twenty-third St., New York

European Agents: Comptoir d'Electricite, 6, Rue Boudreau, Paris, France

# STEEL WOOL JOURNAL PACKING

really is superior to and far more economical than all other kinds of packing. A comparative test under hard service will prove this to your complete satisfaction.

We will gladly furnish a liberal sample

### WM. ROBERTSON & COMPANY

General Office: Great Northern Bldg., CHICAGO  
Factory: 75 S. Jefferson St., BATTLE CREEK, MICH.

11

## CLASSIFIED LIST OF ADVERTISERS—Continued.

- Brakeshoes—Continued.**  
Brill, The J. G., Co., Philadelphia.  
Kuhlman, The G. C., Car Co., Cleveland.  
McGuire-Cummings Mfg. Co., Chicago.  
Marshall, R. W. & Co., 95 Liberty St., New York.  
St. Louis Car Co., St. Louis, Mo.  
Standard Brake Shoe Co., Aurora, Ill.  
Stephenson, John, Co., Elizabeth, N. J.  
Wason Mfg. Co., Springfield, Mass.  
Wharton, Wm., Jr., & Co., Philadelphia.  
Wheel Truing Brake Shoe Co., Detroit.
- Bridges.**  
Johann, F. A., 1624 Pierce Bldg., St. Louis.
- Bridge Timbers.**  
Beldier, Francis, & Co., Chgo.
- Brushes, Motors and Dyanmos.**  
Electric Service Supplies Co., 200 Plymouth Bldg., Chicago.  
General Electric Co., Schenectady, N. Y.  
National Carbon Co., Cleveland, O.  
Ridlon, Frank, Co., 200 Summer St., Boston.  
Speer Carbon Co., St. Marys, Pa.
- Bumpers, Car.**  
American Car Co., St. Louis.  
Brill, The J. G., Co., Philadelphia.  
Kuhlman, The G. C., Car Co., Cleveland.  
St. Louis Car Co., St. Louis, Mo.  
Stephenson, John, Co., Elizabeth, N. J.  
Wason Mfg. Co., Springfield, Mass.
- Car Cleaner.**  
Gillette Chemical Co., 42 Broadway, New York.
- Car House Doors.**  
Kinnear Mfg. Co., Columbus, O.  
Wilson, J. G., Mfg. Co., New York.
- Car Replacers.**  
Electric Service Supplies Co., 200 Plymouth Bldg., Chicago.  
Fairbanks, Morse & Co., Chgo. Ohio Brass Co., Mansfield, O.  
U. S. Metal & Mfg. Co., 25 Broad St., New York.
- Car Roof Paint, Canvas.**  
St. Louis Surfacter & Paint Co., St. Louis, Mo.
- Car Seats.**  
American Car Co., St. Louis.  
Brill, The J. G., Co., Philadelphia.  
Hale & Kilburn Mfg. Co., Philadelphia.  
Heywood Bros. & Wakefield Co., Wakefield, Mass.  
Kuhlman, The G. C., Car Co., Cleveland.  
St. Louis Car Co., St. Louis, Mo.  
Stephenson, John, Co., Elizabeth, N. J.  
Wallace Supply Co., Chicago.  
Wason Mfg. Co., Springfield, Mass.
- Car Signs—(See Signs, Cars and Track).**
- Car Steps.**  
Electric Service Supplies Co., 200 Plymouth Bldg., Chicago.  
Wallace Supply Co., Chicago.
- Car Trimmings—(See Trimmings, Car).**
- Cars, Ballast.**  
Rodger Ballast Car Co., Chgo. St. Louis Car Co., St. Louis, Mo.
- Cars, Dump.**  
Fairbanks, Morse & Co., Chgo. Middletown Car Works, Middletown, Pa.  
Rodger Ballast Car Co., Chgo. Russell Car & Snow-Plow Co., Ridgway, Pa.  
St. Louis Car Co., St. Louis, Mo.
- Cars, Passenger and Freight—Continued.**  
Electric Railway Improvement Co., Cleveland, O.  
Fairbanks, Morse & Co., Chgo. Jewett Car Co., Newark, O.  
Johann, F. A., 1624 Pierce Bldg., St. Louis.  
Kuhlman, The G. C., Car Co., Cleveland.  
McGuire-Cummings Mfg. Co., Chicago.  
Niles Car & Mfg. Co., Niles, O.  
Pressed Steel Car Co., Pittsburg, Pa.  
Rodger Ballast Car Co., Chgo. Russell Car & Snow-Plow Co., Ridgway, Pa.  
St. Louis Car Co., St. Louis, Mo.  
Standard Motor Truck Co., Pittsburg.  
Stephenson, John, Co., Elizabeth, N. J.  
Wason Mfg. Co., Springfield, Mass.
- Cars, Pay-As-You-Enter.**  
Pay-As-You-Enter Car Co., 26 Cortlandt St., New York.
- Cars, Rebuilt.**  
Detroit Carbuilding & Equipment Co., Detroit, Mich.
- Cars, Second-Hand.**  
Detroit Carbuilding & Equipment Co., Detroit, Mich.  
Marshall, R. W. & Co., 95 Liberty St., New York.  
Zeinicker, Walter A., Supply Co., St. Louis.
- Cars, Steel.**  
Middletown Car Works, Middletown, Pa.  
Pressed Steel Car Co., Pittsburg, Pa.  
St. Louis Car Co., St. Louis, Mo.  
Standard Motor Truck Co., Pittsburg.
- Castings, Brass.**  
Star Brass Works, Kalamazoo, Mich.
- Castings, Iron and Steel.**  
American Brake Shoe & Foundry Co., Mahwah, N. J.  
Green Engineering Co., Com'l Nat. Bk. Bldg., Chicago.  
Lorain Steel Co., Johnstown, Pa.  
National Brake & Electric Co., Milwaukee.
- Catchers—(See Trolley Retrievers and Catchers).**
- Cattle Guards.**  
Fairbanks, Morse & Co., Chgo.
- Cements, Cable and Transformer.**  
Massachusetts Chemical Co., Walpole, Mass.
- Circuit-Breakers.**  
Electric Service Supplies Co., 200 Plymouth Bldg., Chicago.  
General Electric Co., Schenectady, N. Y.  
Western Electric Co., Chicago.
- Coal Handling Machinery—(See Conveyors).**
- Coils—(See Armatures and Coils).**
- Commutators and Parts.**  
Cleveland Armature Works, Cleveland.  
Electric Service Supplies Co., 1020-24 Filbert St., Phila.  
General Electric Co., Schenectady, N. Y.  
Harrison Elec. & Mfg. Co., 169 South St., New York.  
Horn Commutator Co., Cleveland, O.  
Marshall, R. W. & Co., 95 Liberty St., New York.  
Ohio Brass Co., Mansfield, O.  
Stuart-Howland Co., Boston.
- Compressors, Air.**  
Fairbanks, Morse & Co., Chgo. General Electric Co., Schenectady, N. Y.  
National Brake & Electric Co., Milwaukee.  
Westinghouse Tractor Brake Co., Pittsburg.
- Concrete Mixers.**  
Contractors' Supply & Equip. Co., Chicago.
- Condensers.**  
Wheeler Con. & Eng. Co., New York.
- Conduits.**  
Electric Service Supplies Co., 200 Plymouth Bldg., Chicago.  
Western Electric Co., Chicago.
- Contractors.**  
Arnold Company, 181 La Salle St., Chicago.  
Bylesby, H. M., Co., Am. Trust Bldg., Chicago.  
Columbia Construction Co., Milwaukee, Wis.  
Creaghead Engineering Co., Cincinnati, O.  
Green Engineering Co., Com'l Nat. Bk. Bldg., Chicago.  
Register, A. L. & Co., 112 N. Broad St., Philadelphia.  
Sanderson & Co., 52 Willam St., New York.  
Saxton, E., 841 Bladenburg R., Washington, D. C.  
Sheaf & Jaastad, 88 Broad St., Boston.  
Stone & Webster Engineering Corp., Boston.  
Wharton, Wm., Jr., & Co., Philadelphia.  
White, J. G., & Co., 49 Exchange Pl., New York.
- Controllers and Attachments.**  
Durkin Con. Handle Co., Arcade Bldg., Philadelphia.  
Electric Service Supplies Co., 200 Plymouth Bldg., Chicago.  
General Electric Co., Schenectady, N. Y.  
Harrison Elec. & Mfg. Co., 169 South St., New York.  
Johns-Manville, H. W. Co., New York.  
Marshall, R. W. & Co., 95 Liberty St., New York.  
Western Electric Co., Chicago.  
Westinghouse Electric & Mfg. Co., Pittsburg.
- Conveyors and Coal Handling Machinery.**  
Green Engineering Co., Com'l Nat. Bk. Bldg., Chicago.  
Northern Engineering Works, Detroit, Mich.
- Cord, Bell and Trolley.**  
American Car Co., St. Louis.  
Brill, The J. G., Co., Philadelphia.  
Electric Service Supplies Co., 1020-24 Filbert St., Phila.  
Kuhlman, The G. C., Car Co., Cleveland.  
St. Louis Car Co., St. Louis, Mo.  
Stephenson, John, Co., Elizabeth, N. J.  
Stuart-Howland Co., Boston.  
Wason Mfg. Co., Springfield, Mass.
- Couplers, Car.**  
American Car Co., St. Louis.  
Brill, The J. G., Co., Philadelphia.  
Kuhlman, The G. C., Car Co., Cleveland.  
McGuire-Cummings Mfg. Co., Chicago.  
Ohio Brass Co., Mansfield, O.  
St. Louis Car Co., St. Louis, Mo.  
Stephenson, John, Co., Elizabeth, N. J.  
Van Dorn, W. T., Co., Paulina St., Chicago.  
Wallace Supply Co., Chicago.  
Washburn, E. C., Minneapolis.  
Wason Mfg. Co., Springfield, Mass.
- Coverings, Pipe and Boiler.**  
Johns-Manville, H. W. Co., New York.
- Cranes, Hoists and Lifts.**  
American Car Co., St. Louis.  
Brill, The J. G., Co., Philadelphia.  
Brown Hoisting Machinery Co., Cleveland, O.  
Kuhlman, The G. C., Car Co., Cleveland.  
Northern Engineering Works, Detroit, Mich.  
Railway Specialty & Supply Co., Chicago.  
Stephenson, John, Co., Elizabeth, N. J.  
Van Dorn, W. T. & Dutton Co., Cleveland, O.  
Wason Mfg. Co., Springfield, Mass.
- Cross Arms—(See Brackets and Cross Arms).**
- Crossing Gates—(See Gates and Guards).**
- Crossings, Track—(See Switches).**
- Curtains, Fixtures and Materials—Continued.**  
American Car Co., St. Louis.  
Brill, The J. G., Co., Philadelphia.  
Curtain Supply Co., 93 Ohio St., Chicago.
- Curtains, Fixtures and Materials—Continued.**  
Electric Service Supplies Co., 200 Plymouth Bldg., Chicago.  
Hartman, Stewart, Co., East Newark, N. J.  
Kuhlman, The G. C., Car Co., Cleveland.  
Marshall, R. W. & Co., 95 Liberty St., New York.  
National Lock Washer Co., Newark, N. J.  
Fantaso, Co., 11 Broadway, New York.  
St. Louis Car Co., St. Louis, Mo.  
Stephenson, John, Co., Elizabeth, N. J.  
Wason Mfg. Co., Springfield, Mass.
- Cylinder Oil.**  
Power Specialty Co., 111 Broadway, N. Y.
- Derailing Devices.**  
American Frog & Switch Co., Hamilton, O.  
Cincinnati Frog & Switch Co., Cincinnati, O.  
Cleveland Frog & Crossing Co., Cleveland, O.
- Detective Agency.**  
Drummond Detective Agency, New York.
- Diaphragms.**  
New G. S., Great Northern Bldg., Chicago.
- Doors and Fixtures.**  
American Car Co., St. Louis.  
Brill, The J. G., Co., Philadelphia.  
Kuhlman, The G. C., Car Co., Cleveland.  
St. Louis Car Co., St. Louis, Mo.  
Stephenson, John, Co., Elizabeth, N. J.  
Wallace Supply Co., Chicago.  
Wason Mfg. Co., Springfield, Mass.
- Doors, Steel Rolling.**  
Kinnear Manufacturing Co., Columbus, O.  
Wilson, J. G., Mfg. Co., New York.
- Draft, Mechanical—(See Mechanical Draft).**
- Draft Rigging.**  
Van Dorn, W. T., Co., Chgo. Wallace Supply Co., Chicago.
- Drills, Track.**  
Brown, H. P., 120 Liberty St., New York.  
Electric Service Supplies Co., 200 Plymouth Bldg., Chicago.  
Fairbanks, Morse & Co., Chgo. Marshall, R. W. & Co., 95 Liberty St., New York.  
Reed, Francis, Co., Worcester, Mass.
- Ridlon, Frank, Co., 200 Summer St., Boston.**
- Drying Appliances.**  
Green Fuel Economizer Co., Matteawan, N. Y.
- Dynamos and Generators.**  
Cleveland Armature Works, Cleveland, O.  
Fairbanks, Morse & Co., Chgo. General Electric Co., Schenectady, N. Y.  
National Brake & Electric Co., Milwaukee, Wis.  
Rossiter, MacGovern & Co., U. S. Battery Pl., New York.  
Western Electric Co., Chicago.  
Westinghouse Electric & Mfg. Co., Pittsburg, Pa.
- Economizers, Fuel.**  
Green Fuel Economizer Co., Matteawan, N. Y.
- Electrical Instruments.**  
Electric Service Supplies Co., 200 Plymouth Bldg., Chicago.  
General Electric Co., Schenectady, N. Y.  
Johns-Manville, H. W., Co., New York.  
Queen & Co., Philadelphia.  
Western Electric Co., Chicago.  
Westinghouse Electric & Mfg. Co., Pittsburg, Pa.  
Weston Electrical Instrument Co., Newark, N. J.
- Electric Railway Supplies, General.**  
Cleveland Armature Works, Cleveland, O.  
Creaghead Engineering Co., Cincinnati, O.

# ST. LOUIS CAR CO. ST. LOUIS-MO.

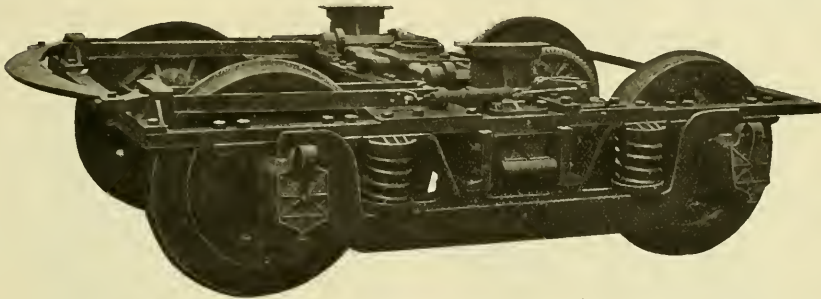

St. Louis Car Company M. C. B. Double Equalizer Type No. 62 Truck

## Details of Construction:

**T**RUCK frames are made of wrought iron forged in one piece, with a heavy fillet in each corner, and planed to receive pedestal jaws and center frames of transoms. Pedestals are of wrought iron and the upper face of each is machined so as to lip on side frame. Wearing faces are machined and provided with oil grooves. Faces which engage the pedestal tie bars are also machined.

Transoms are made of two 10" channels secured to frames by being bolted to machined cast steel side strut castings and bolted to side frame with heavy steel gusset plates.

Removable chafing plates are also provided on the transom channels. Bolsters are of cast steel and provided with end springs to

limit side motion of car body. Bolsters also are provided with removable chafing plates.

Equalizers are of wrought iron and forged with a lug to fit into recess in the journal boxes. Brakes are of the equalized type and arranged to suit cars operated around short curves.

Brake rigging is provided with suitable safety hangers. Ends of hangers and hanger pins are case hardened to reduce the wear to a minimum and prevent rattling.

All bolts used in assembling the trucks are taper finished, turned to a taper of  $\frac{1}{8}$ " per foot, and all holes for bolts are reamed to templates.

All parts of the truck when machined are made to template and all holes are drilled with a jig.

Made in the largest and best equipped  
factory of its kind in the world.

## CLASSIFIED LIST OF ADVERTISERS—Continued.

- Electric Railway Supplies, General—Continued.  
Electric Service Supplies Co., 200 Plymouth Bldg., Chicago.  
Fairbanks, Morse & Co., Chgo.  
General Electric Co., Schenectady, N. Y.  
Harrison Elec. & Mfg. Co., 109 South St., New York.  
Johns-Manville, H. W., Co., New York.  
Marshall, R. W., & Co., 95 Liberty St., New York.  
Ohio Brass Co., Mansfield, O.  
Stuart-Howland Co., Boston.  
Wallace Supply Co., Chicago.  
Western Electric Co., Chicago.
- Enamels.  
Acme White Lead & Color Works, Detroit, Mich.  
St. Louis Surfer & Paint Co., St. Louis, Mo.
- Engine Apparatus.  
Green Fuel Economizer Co., Matteawan, N. Y.
- Engineers and Contractors.  
Arlond Company, Chicago.  
Bylesby, H. M., & Co., Chgo.  
Columbia Construction Co., Milwaukee, Wis.  
Ford, Bacon & Davis, New York.  
Register, A. L., & Co., Philadelphia.  
Roberts & Abbott Co., Cleveland, O.  
Sanderson & Porter, New York.  
Saxton, E., Washington, D. C.  
Sheaff & Jaastad, Boston.  
Stone & Webster Eng. Corporation, Boston.  
White, J. G., & Co., New York.
- Engines, Gas and Oil.  
Buckeye Engine Co., Salem, O.  
Fairbanks, Morse & Co., Chgo.  
Westinghouse Machine Co., Pittsburg.
- Engines, Hoisting.  
Fairbanks, Morse & Co., Chgo.
- Engines, Steam.  
Buckeye Engine Co., Salem, O.  
Hooven-Owens-Rentschler Co., Hamilton, O.  
Rossiter, MacGovern & Co., 17 Battery Pl., New York.  
Westinghouse Machine Co., Pittsburg.
- Fans, Exhaust and Ventilating.  
General Electric Co., Schenectady, N. Y.  
Green Fuel Economizer Co., Matteawan, N. Y.  
Western Electric Co., Chicago.  
Westinghouse Elec. & Mfg. Co., Pittsburg.
- Fare Boxes—(See Electric Railway Supplies).
- Fare Registers and Register Fittings.  
Electric Service Supplies Co., 200 Plymouth Bldg., Chicago.  
Recording Fare Register Co., New Haven, Conn.  
Rooke Automatic Register Co., Providence, R. I.  
Security Register & Mfg. Co., 42 Broadway, New York.
- Feedwater Apparatus.  
Green Fuel Economizer Co., Matteawan, N. Y.  
Wheeler Condenser & Eng'g Co., New York.
- Feed Wire—(See Wire and Cables).
- Fenders and Guards.  
Consolidated Car Fender Co., Providence, R. I.  
Eclipse Railway Supply Co., Cleveland, O.  
Electric Service Supplies Co., 1020-24 Filbert St., Phila.  
McGuire-Cummings Mfg. Co., Chicago.  
Marshall, R. W., & Co., 95 Liberty St., New York.
- Flangers, Snow.  
McGuire-Cummings Mfg. Co., Chicago.  
Ohio Brass Co., Mansfield, O.  
Van Dorn & Dutton Co., Cleveland, O.
- Frogs—(See Switches, Frogs and Crossings).
- Fuel Economizers—(See Economizers, Fuel).
- Fuses and Fuse Devices.  
Chase-Shawmut Co., Newburyport, Mass.
- Fuses and Fuse Devices—Continued.  
Electric Service Supplies Co., 200 Plymouth Bldg., Chicago.  
General Electric Co., Schenectady, N. Y.  
Johns-Manville, H. W., Co., New York.  
Western Electric Co., Chicago.  
Westinghouse Elec. & Manufacturing Co., Pittsburg.
- Gaskets, Bronze.  
Power Specialty Co., 111 Broadway, New York.
- Gates and Guards.  
Blisa, R., Mfg. Co., Pawtucket, R. I.
- Gear Cases.  
Electric Service Supplies Co., 200 Plymouth Bldg., Chicago.  
General Electric Co., Schenectady, N. Y.  
Marshall, R. W., & Co., 95 Liberty St., New York.
- Gears and Pinions.  
Electric Service Supplies Co., 200 Plymouth Bldg., Chicago.  
General Electric Co., Schenectady, N. Y.  
Marshall, R. W., & Co., 95 Liberty St., New York.  
Nuttall, R. D., Co., Pittsburg.  
Van Dorn & Dutton Co., Cleveland, O.
- Generators—(See Dynamos).
- Gongs—(See Bells and Gongs).
- Graphite.  
Detroit Graphite Co., Detroit, Mich.  
U. S. Graphite Co., Saginaw, Mich.
- Graphite Paint—(See Paint).
- Grates, Chain.  
Green Engineering Co., Com'l Nat. Bk. Bldg., Chicago.
- Grease—(See Lubricants).
- Grinders.  
Brown, Harold P., 120 Liberty St., New York.
- Guy Anchors—(See Anchors).
- Harps, Trolley—(See Trolley Poles and Fittings).
- Headlights.  
Electric Service Supplies Co., 200 Plymouth Bldg., Chicago.  
Fairbanks, Morse & Co., Chgo.  
General Electric Co., Schenectady, N. Y.  
Ridlon, Frank, Co., 200 Summer St., Boston.  
St. Louis Car Co., St. Louis, Mo.  
Stuart-Howland Co., Boston.  
Trolley Supply Co., Canton, O.
- Headlinings, Passenger Car.  
Indestructible Fibre Co., 45 Broadway, New York.
- Heaters, Car, Electric.  
Consolidated Car-Heating Co., Albany, N. Y.  
Johns-Manville, H. W., Co., New York.
- Heaters, Car, Hot Water, and Stoves.  
Baker, The Wm. C., Heating & Sup. Co., New York.  
Cooper Heater Co., The, Dayton, Ohio.  
Electric Service Supplies Co., 1020-24 Filbert St., Phila.  
McGuire-Cummings Mfg. Co., Chicago.  
Smith, Peter, Heater Co., Detroit, Mich.
- Heating and Ventilating Apparatus—(See Mech. Draft).
- Holsts—(See Cranes, Hoists and Lifts).
- Hose Bridges.  
Ohio Brass Co., Mansfield, O.
- Hydraulic Machinery.  
Watson-Stillman Co., 26 Cortland St., New York.
- Inspection.  
Central Inspection Bureau.
- Inspection Cars, Gasoline.  
Stover Motor Car Co., Freeport, Ill.
- Instruments, Measuring and Testing—(See Electrical Instruments).
- Insulating Tapes.  
General Electric Co., Schenectady, N. Y.  
Harrison Elec. & Mfg. Co., 169 South St., New York.  
Massachusetts Chemical Co., Walpole, Mass.  
Okonite Co., Ltd., 253 Broadway, New York.  
Western Electric Co., Chicago.
- Insulations and Insulating Material.  
Anderson, A. & J. M., Mfg. Co., Boston.  
Craghead Engineering Co., Cincinnati, O.  
Electric Railway Equipment Co., Cincinnati, O.  
Electric Service Supplies Co., 200 Plymouth Bldg., Chicago.  
General Electric Co., Schenectady, N. Y.  
Johns-Manville, H. W., Co., New York.  
Macallen, The, Co., Boston.  
Massachusetts Chemical Co., Walpole, Mass.  
Ohio Brass Co., Mansfield, O.  
Arlond Co., Ltd., 253 Broadway, New York.  
Ridlon, Frank, Co., 200 Summer St., Boston.  
Stuart-Howland Co., 100 William St., New York.  
Standard Varnish Works, New York.  
Stuart-Howland Co., Boston.  
Western Electric Co., Chicago.
- Jacks.  
American Car Co., St. Louis.  
Brill, The J. G., Co., Philadelphia.  
Electric Service Supplies Co., 200 Plymouth Bldg., Chicago.  
Fairbanks, Morse & Co., Chgo.  
Kuhlman, The G. C., Car Co., Cleveland.  
Marshall, R. W., & Co., 95 Liberty St., New York.  
Morden Frog & Crossing Co., Chicago.  
Security Register & Mfg. Co., New York.  
Stephenson, John, Co., Elizabeth, N. J.  
Wason Mfg. Co., Springfield, Mass.  
Watson-Stillman Co., 26 Cortland St., New York.
- Joints, Expansion—(See Steam Fittings).
- Joints, Rail.  
Goldschmidt Thermit Co., 43 Exchange Pl., New York.  
Rail Joint Co., 29 W. 34th St., New York.
- Joints, Welded—(See Rail Joints, Welded).
- Journal Boxes.  
American Car Co., St. Louis.  
Brill, The J. G., Co., Philadelphia.  
Kuhlman, The G. C., Car Co., Cleveland.  
McGuire-Cummings Mfg. Co., Chicago.  
St. Louis Car Co., St. Louis, Mo.  
Stephenson, John, Co., Elizabeth, N. J.  
Symington, T. H., Co., Baltimore, Md.  
Wason Mfg. Co., Springfield, Mass.
- Journal Lubricants—(See Lubricants).
- Journal Packing, Steel Wool.  
Robertson, Wm., & Co., Great Northern Bldg., Chicago.
- Lamps, Arc and Incandescent.  
Anderson, A. & J. M., Mfg. Co., Boston.  
Electric Service Supplies Co., 200 Plymouth Bldg., Chicago.  
General Electric Co., Schenectady, N. Y.  
Ridlon, Frank, Co., 200 Summer St., Boston.  
Stuart-Howland Co., Boston.  
Western Electric Co., Chicago.  
Westinghouse Electric & Mfg. Co., Pittsburg, Pa.
- Lamp Sockets.  
Electric Service Supplies Co., 200 Plymouth Bldg., Chicago.  
General Electric Co., Schenectady, N. Y.
- Lantern Globes.  
Railway Specialty & Supply Co., Chicago.
- Lifts—(See Cranes, Hoist and Lift).
- Lighting Arresters.  
Electric Service Supplies Co., 200 Plymouth Bldg., Chicago.  
General Electric Co., Schenectady, N. Y.  
Stuart-Howland Co., Boston.  
Western Electric Co., Chicago.  
Westinghouse Elec. & Manufacturing Co., Pittsburg.
- Line Material.  
Anderson, A. & J. M., Mfg. Co., Boston.  
Craghead Engineering Co., Cincinnati, O.  
Johns-Manville, H. W., Co., New York.  
Electric Railway Equipment Co., Cincinnati, O.  
Electric Service Supplies Co., 200 Plymouth Bldg., Chicago.  
General Electric Co., Schenectady, N. Y.  
Macallen, The, Co., Boston.  
Marshall, R. W., & Co., 95 Liberty St., New York.  
Recording Fare Register Co., New Haven, Conn.  
Stuart-Howland Co., Boston.  
Western Electric Co., Chicago.
- Lock and Nut Washers.  
Grip Nut Co., 152 Lake St., Chicago.  
National Lock Washer Co., Newark, N. J.
- Lockers, Metal.  
Electric Service Supplies Co., 200 Plymouth Bldg., Chicago.
- Locomotives.  
Baldwin Locomotive Works, Philadelphia.  
Johann, F. A., 1624 Pierce Bldg., St. Louis.
- Locomotives, Electric.  
American Car Co., St. Louis.  
Baldwin Locomotive Works, Philadelphia.  
Brill, The J. G., Co., Philadelphia.  
General Electric Co., Schenectady, N. Y.  
Kuhlman, The G. C., Car Co., Chicago.  
McGuire-Cummings Mfg. Co., Chicago.  
Stephenson, John, Co., Elizabeth, N. J.  
Wason Mfg. Co., Springfield, Mass.  
Westinghouse Elec. & Manufacturing Co., Pittsburg.
- Locomotives, Gasoline.  
Fairbanks, Morse & Co., Chgo.  
Stover Motor Car Co., Freeport, Ill.
- Lubricants.  
Dearborn Drug & Chemical Works, Chicago.  
Detroit Graphite Co., Detroit, Mich.  
Gallen-Signal Oil Co., Franklin, Pa.  
U. S. Graphite Co., Saginaw, Mich.  
Whitman Mfg. Co., Cleveland, O.
- Lumber.  
Barnes, G. H., Hardwood Lumber Co., St. Louis, Mo.  
Beidler, Francis, & Co., Chgo.  
Berthold & Jennings, St. Louis.  
Lindsay Bros. Co., Spokane, Wash.  
S-E. Missouri Cypress Co., Campbell, Mo.
- Lumber, Asbestos.  
Johns-Manville, H. W., Co., New York.
- Malleable Iron.  
Beaver Dam Malleable Iron Co., Beaver Dam, Wis.  
St. Louis Car Co., St. Louis, Mo.
- Measuring Tapes.  
Lufkin Rule Co., Saginaw, Mich.
- Mechanical Draft.  
Green Fuel Economizer Co., Matteawan, N. Y.
- Meters.  
Johns-Manville, H. W., Co., New York.  
Weston Electrical Instrument Co., Newark, N. J.



The line on which your company  
loses the most nickels—

that's the first one you should operate with modern

# Pay-As-You-Enter Cars

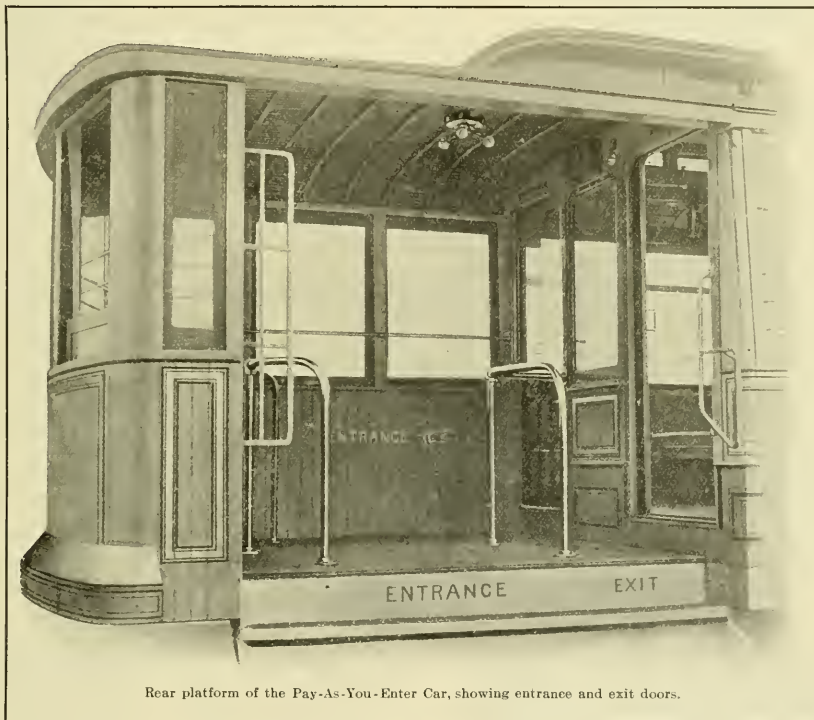

Rear platform of the Pay-As-You-Enter Car, showing entrance and exit doors.

**They are Nickel-Savers and Dividend-Payers**

We license manufacturers and railways to build and use the  
Pay-As-You-Enter Car, the patents of which are owned by

## The Pay-As-You-Enter Car Company

DUNCAN McDONALD

President

26 Cortlandt Street, New York

THOS. W. CASEY

Manager

## CLASSIFIED LIST OF ADVERTISERS—Continued.

- Molded Goods.**  
Massachusetts Chemical Co., Walpole, Mass.  
Wood, G. S., Great Northern Bldg., Chicago.
- Motor Cars, Gasoline.**  
Stover Motor Car Co., Freeport, Ill.
- Motors, Electric.**  
Cleveland Armature Works, Cleveland, O.  
Fairbanks, Morse & Co., Chgo.  
General Electric Co., Schenectady, N. Y.  
National Brake & Electric Co., Milwaukee.  
Rossiter, MacGovern & Co., 17 Battery Pl., New York.  
Western Electric Co., Chicago.  
Wetnghouse Elec. & Manufacturing Co., Pittsburg.
- Nut Locks.**  
Grip Nut Co., 152 Lake St., Chicago.  
National Lock Washer Co., Newark, N. J.  
Railway Specialty & Supply Co., Chicago.  
St. Louis Car Co., St. Louis, Mo.  
U. S. Metal & Mfg. Co., 25 Broad St., New York.
- Nuts and Bolts.**  
Grip Nut Co., 152 Lake St., Chicago.  
Lorain Steel Co., Philadelphia.  
National Lock Washer Co., Newark, N. J.  
Railway Specialty & Supply Co., Chicago.
- Oilers.**  
Armstrong Oiler Co., 31st and Chestnut St., Philadelphia.
- Oils—(See Lubricants).**
- Overhead Equipment—(See Electric Railway Supplies).**
- Packings.**  
Electric Service Supplies Co., 200 Plymouth Bldg., Chicago.  
Johns-Manville, H. W., Co., New York.  
Power Specialty Co., 111 Broadway, New York.
- Packing, Steel Wool Journal.**  
Robertson, Wm., & Co., Gt. Northern Bldg., Chicago.
- Paints.**  
Acme White Lead & Color Works, Detroit.  
Detroit Graphite Co., Detroit.  
Gohen Mfg. Co., Canton, O.  
Massachusetts Chemical Co., Walpole, Mass.  
Standard Paint Co., 100 William St., New York.  
St. Louis Surface & Paint Co., St. Louis, Mo.  
U. S. Graphite Co., Saginaw, Mich.
- Pay-As-You-Enter Cars.**  
Pay-As-You-Enter Car Co., 26 Cortlandt St., New York.
- Pipe Bends and Fittings—(See Steam Fittings).**
- Plumbago.**  
Detroit Graphite Co., Detroit, Mich.  
U. S. Graphite Co., Saginaw, Mich.
- Poles, Metal.**  
Creaghead Engineering Co., Cincinnati, O.  
Electric Railway Equipment Co., Cincinnati, O.  
Electric Service Supplies Co., 200 Plymouth Bldg., Chicago.
- Poles and Ties, Wood.**  
Advance Lumber Co., Cleveland, O.  
Barnes, G. H., Hardwood Lumber Co., St. Louis, Mo.  
Beidler, Francis & Co., Chgo.  
Berthold & Jennings, St. Louis.  
Churchill Cedar Co., Spokane, Wash.  
Hurnbird Lumber Co., Sand Point, Idaho.  
Lindsay Bros. Co., Spokane, Wash.  
Naugle Pole & Tie Co., 226 La Salle St., Chicago.  
Pacific Coast Pole Co., Spokane, Wash.  
S-E. Missouri Cypress Co., Campbell, Mo.  
Worcester, C. H., Co., Tribune Bldg., Chicago.
- Punches—(See Ticket Punches).**
- Rail Benders.**  
Electric Service Supplies Co., 200 Plymouth Bldg., Chicago.  
Fairbanks, Morse & Co., Chgo.
- Rail Bonds—(See Bonds, Rail).**
- Rail Brackets.**  
Beaver Dam Malleable Iron Co., Beaver Dam, Wis.
- Rail Drills—(See Drills, Track).**
- Rail Feed Wire—(See Wire and Cables).**
- Rail Joints and Chairs—(See Joints, Rail).**
- Rail Joints, Welded.**  
Goldschmidt Thermit Co., 43 Exchange Pl., New York.  
Lorain Steel Co., Philadelphia.
- Rails, New.**  
Lorain Steel Co., Philadelphia.  
New York Switch & Crossing Co., Hoboken, N. J.  
Wharton, Wm., Jr., & Co., Philadelphia.
- Rails, Relaying.**  
Zelnicker, Walter A., Supply Co., St. Louis.
- Railway Equipment.**  
Johann, F. A., 1624 Pierce Bldg., St. Louis.
- Railway Velocpedes.**  
Fairbanks Morse & Co., Chgo.
- Registers and Fittings—(See Fare Registers).**
- Relays.**  
Weston Electrical Instrument Co., Newark, N. J.
- Roofing.**  
Johns-Manville, H. W., Co., New York.
- Rubber Goods, Mechanical.**  
Wood, G. S., Great Northern Bldg., Chicago.
- Rubber Preservative.**  
Wood, G. S., Great Northern Bldg., Chicago.
- Sand Apparatus.**  
American Car Co., St. Louis.  
Brill, The J. G., Co., Philadelphia.  
Electric Service Supplies Co., 200 Plymouth Bldg., Chicago.  
Kuhlman, The G. C., Car Co., Cleveland.  
Marshall, R. W., & Co., 95 Liberty St., New York.  
Ohio Brass Co., Mansfield, O.  
Ridion, Frank, Co., 200 Summer St., Boston.  
St. Louis Car Co., St. Louis, Mo.  
Stephenson, John, Co., Elizabeth, N. J.  
Wason Mfg. Co., Springfield, Mass.
- Sash Balances and Fixtures.**  
National Lock Washer Co., Newark, N. J.
- Sash Operating Devices.**  
Drouvé, The G. Co., Bridgeport, Conn.  
Lord & Burnham, Irvington-on-Hudson, New York.
- Seats, Car—(See Car Seats).**
- Shade Rollers—(See Curtains, Fixtures and Materials).**
- Shutters, Steel Rolling.**  
Kinnear Manufacturing Co., Columbus, O.
- Signals.**  
Blake Signal & Manufacturing Co., Boston.  
Telegraph Signal Co., Rochester, N. Y.
- Signal Supplies.**  
Railway Specialty & Supply Co., Chicago.
- Skylights.**  
Drouvé, The G. Co., Bridgeport, Conn.  
Lord & Burnham, Irvington-on-Hudson, New York.
- Snow Plows, Sweepers and Scrapers.**  
American Car Co., St. Louis.  
Brill, The J. G., Co., Philadelphia.  
Kalamazoo Railway Supply Co., Kalamazoo, Mich.  
Kuhlman, The G. C., Car Co., Cleveland.
- Snow Plows, Sweepers and Scrapers—Continued.**  
McGuire-Cummings Mfg. Co., Chicago.  
Russell Car & Snow-Plow Co., Ridgway, Pa.  
Stephenson, John, Co., Elizabeth, N. J.  
Wason Mfg. Co., Springfield, Mass.
- Sockets, Waterproof.**  
Johns-Manville, H. W., Co., New York.
- Splicing Compounds and Materials.**  
Massachusetts Chemical Co., Walpole, Mass.
- Springs.**  
American Car Co., St. Louis.  
Brill, The J. G., Co., Philadelphia.  
Kuhlman, The G. C., Car Co., Cleveland.  
McGuire-Cummings Mfg. Co., Chicago.  
Marshall, R. W., & Co., 95 Liberty St., New York.  
Railway Steel Spring Co., 71 Broadway, New York.  
St. Louis Car Co., St. Louis, Mo.  
Stephenson, John, Co., Elizabeth, N. J.  
Wason Mfg. Co., Springfield, Mass.
- Sprinkling Cars.**  
American Car Co., St. Louis.  
Brill, The J. G., Co., Philadelphia.  
Kuhlman, The G. C., Car Co., Cleveland.  
McGuire-Cummings Mfg. Co., Chicago.  
Stephenson, John, Co., Elizabeth, N. J.  
Wason Mfg. Co., Springfield, Mass.
- Steam Apparatus.**  
Green Fuel Economizer Co., Matteawan, N. Y.
- Steam Fittings, Etc.**  
Crane Co., Chicago.  
Davis, The John, Co., Chgo.  
Simmons, John, Co., 110 Centre St., New York.  
Power Specialty Co., 111 Broadway, New York.
- Steel Cars.**  
American Car Co., St. Louis.  
Brill, The J. G., Co., Philadelphia.  
Kuhlman, The G. C., Car Co., Cleveland.  
St. Louis Car Co., St. Louis, Mo.  
Stephenson, John, Co., Elizabeth, N. J.  
Wason Mfg. Co., Springfield, Mass.
- Steel Tapes.**  
Luffin Rule Co., Saginaw, Mich.
- Stokers.**  
Babcock & Wilcox Co., 85 Liberty St., New York.  
Green Engineering Co., Com'l Nat. Bk. Bldg., Chicago.  
Model Stoker Co., Dayton, O.  
Under-Peep Stoker Co. of Am., Chicago.  
Westinghouse Machine Co., Pittsburg.
- Storage Batteries—(See Batteries).**
- "Strike-Breakers."**  
Drummond Detective Agency, 3 Ann St., New York.
- Superheaters.**  
Power Specialty Co., 111 Broadway, New York.
- Switches, Frogs and Crossings—Continued.**  
American Frog & Switch Co., Hamilton, O.  
Barbour-Stockwell Co., Cambridgeport, Mass.  
Cincinnati Frog & Switch Co., Cincinnati, O.  
Cleveland Frog & Crossing Co., Cleveland, O.  
Fairbanks, Morse & Co., Chgo.  
Lorain Steel Co., Philadelphia.  
Morden Frog & Crossing Co., Rookery, Chicago.
- Switches, Frogs and Crossings—Continued.**  
New York Switch & Crossing Co., Hoboken, N. J.  
Railway Specialty & Supply Co., Chicago.  
Wharton, Wm., Jr., & Co., Philadelphia.
- Switchboards and Switchboard Instruments.**  
Anderson, A. & J. M., Mfg. Co., Boston.  
Chase-Shawmut Co., Newburyport, Mass.  
General Electric Co., Schenectady, N. Y.  
Western Electric Co., Chicago.  
Wetnghouse Electric & Mfg. Co., Htsburg.  
Weston Electrical Instrument Co., Newark, N. J.
- Tapes and Webbing.**  
Hope Webbing Co., Providence, R. I.  
Johns-Manville, H. W., Co., New York.  
Massachusetts Chemical Co., Walpole, Mass.  
Okonite Co., Ltd., 263 Broadway, New York.
- Testing Instruments.**  
Weston Electrical Instrument Co., Newark, N. J.
- Ticket Choppers and Destroyers.**  
Patten, Paul B., Salem, Mass.
- Ticket Punches.**  
Meyers, Fred J., Mfg. Co., Hamilton, O.  
Woodman Mfg. & Sup. Co., Boston.
- Tieplates.**  
Beaver Dam Malleable Iron Co., Beaver Dam, Wis.
- Ties and Poles, Wood—(See Poles and Ties).**
- Timber.**  
Beidler, Francis & Co., Chgo.  
Lindsay Bros. Co., Spokane, Wash.  
S-E. Missouri Cypress Co., Campbell, Mo.
- Tools, Pneumatic—(See Pneumatic Tools).**
- Track Cleaners and Scrapers.**  
American Car Co., St. Louis.  
Brill, The J. G., Co., Philadelphia.  
Kuhlman, The G. C., Car Co., Cleveland.  
McGuire-Cummings Mfg. Co., Chicago.  
Marshall, R. W., & Co., 95 Liberty St., New York.  
Ohio Brass Co., Mansfield, O.  
Stephenson, John, Co., Elizabeth, N. J.  
Van Horn & Dutton Co., Cleveland, O.  
Wason Mfg. Co., Springfield, Mass.
- Track Drills—(See Drills, Track).**
- Tracklaying Machinery.**  
Holman, D. F., Ry. Tracklayer Co., 1102 Ellsworth Bldg., Chicago.
- Track Tools.**  
Electric Service Supplies Co., 200 Plymouth Bldg., Chicago.
- Trimming, Car.**  
American Car Co., St. Louis.  
Brill, The J. G., Co., Philadelphia.  
Curtain Supply Co., Park Row Bldg., New York.  
Kuhlman, The G. C., Car Co., Cleveland.  
National Lock Washer Co., Newark, N. J.  
St. Louis Car Co., St. Louis, Mo.  
Stephenson, John, Co., Elizabeth, N. J.  
Wallace Supply Co., Chicago.  
Wason Mfg. Co., Springfield, Mass.  
Wood, G. S., Great Northern Bldg., Chicago.
- Trolley Guards.**  
Electric Service Supplies Co., 200 Plymouth Bldg., Chicago.
- Trolley Poles and Fittings.**  
General Electric Co., Schenectady, N. Y.  
Johns-Manville, H. W., Co., New York.  
Marshall, R. W., & Co., 95 Liberty St., New York.

**THIS**

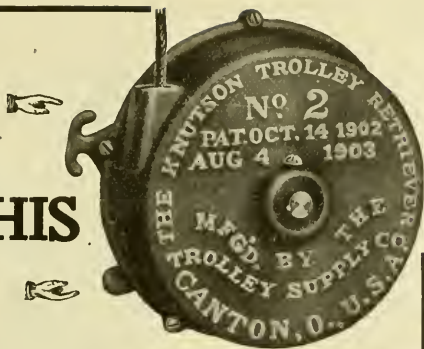

**Is Absolute Insurance Against Damage by Wild Trolley Poles**

Compare the cost of the Knutson Trolley Retriever with the cost of damage caused to poles, overhead, car tops, etc., by wild trolley poles in one year. You will find, as many other traction men have, that the comparison is very much in favor of the Retriever.

And the Knutson is the Retriever, for no other is as reliable—no other is unconditionally guaranteed for one year.

We would be pleased to tell you about an offer of 30 days' free trial.

**THE TROLLEY SUPPLY CO.**  
CANTON, OHIO

**Gasoline Motor Cars for Street Car Service**

Can be used advantageously for owl car service and on branch lines of large railroads where the passenger traffic does not warrant the maintenance of a regular train schedule.

Address R. R. Dept. No. 757 MS

**Fairbanks, Morse & Co.**  
CHICAGO, ILLINOIS

**A Generally Useful Portable Motor**

**\$65**

It will pay for itself quickly.

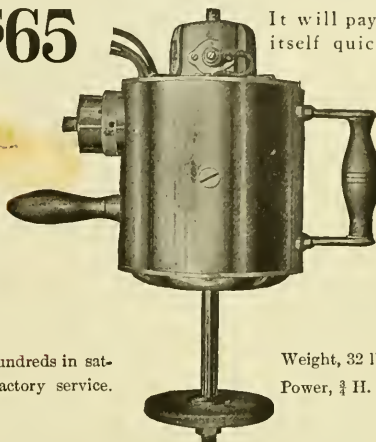

Hundreds in satisfactory service.

Weight, 32 lbs.  
Power, 3/4 H. P.

Order now for early delivery

**Cleveland Armature Works**  
Cleveland, Ohio

28

**Shawmut Soldered Railbonds**

Are the Original Soldered Bonds 8 YEARS of Service Under ALL Conditions Prove Their RELIABILITY.

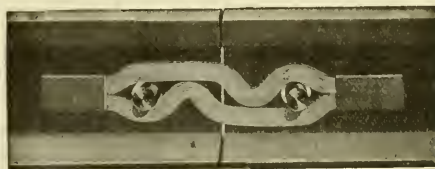

WHY Not Try a Proven Bond at Least

**SEND FOR OUR PROPOSITION**

See Bulletin No. 29

**CHASE-SHAWMUT CO.**  
Newburyport, Mass.

CLASSIFIED LIST OF ADVERTISERS—Continued.

Trolley Retrievers and Catchers.  
Earl, C. L., Bowling Green Bldg., New York.  
Electric Service Supplies Co., 1020-24 Pilbert St., Phila.  
Milloy Electric Co., Bucyrus, O.  
Ridlon, Frank, Co., 200 Summer St., Boston.  
Trolley Supply Co., Canton, O.

Trolley Wheels—(See Trolley Poles and Fittings).

Trolley Wire—(See Wire and Cables).

Trolleys, Track.  
Cleveland Armature Works, Cleveland, O.

Trucks, Car.  
American Car Co., St. Louis.  
Baldwin Locomotive Works, Philadelphia.  
Brill, The J. G., Co., Philadelphia.  
Kuhlman, The G. C., Car Co., Cleveland.  
McGuire-Cummings Mfg. Co., Chicago.  
St. Louis Car Co., St. Louis, Mo.  
Standard Motor Truck Co., Pittsburg, Pa.  
Standard Varnish Works, New York City.  
Stephenson, John, Co., Elizabeth, N. J.  
Van Dorn & Dutton Co., Cleveland, O.

Trucks, Car—Continued.  
Wason Mfg. Co., Springfield, Mass.

Turbines.  
General Electric Co., Schenectady, N. Y.  
Hooven-Owens-Rentschler Co., Hamilton, O.  
Westinghouse Machine Co., Pittsburg, Pa.

Valves—(See Steam Fittings).

Varnish.  
Acme White Lead & Color Works, Detroit.  
Electric Service Supplies Co., 200 Plymouth Bldg., Chicago.  
Harrison Elec. & Mfg. Co., 169 South St., New York.  
Marshall, R. W., & Co., 95 Liberty St., New York.  
Massachusetts Chemical Co., Walpole, Mass.  
Milloy Electric Co., Bucyrus, O.  
Nuttall, R. D., Co., Pittsburg.  
Ridlon, Frank, Co., 200 Summer St., Boston.  
Standard Paint Co., 100 William St., New York.  
Star Brass Works, Kalamazoo, Mich.  
Trolley Supply Co., Canton, O.  
Wallace Supply Co., Chicago.  
Westinghouse Electric & Mfg. Co., Pittsburg, Pa.

Ventilators.  
Drouvé, The G. Co., Bridgeport, Conn.  
Lord & Burnham, Irvington-Hudson, New York.

Vestlettes.  
Bellamy Vestlette Mfg. Co., Cleveland, O.

Waste, Cotton and Wool.  
Hagy, J. Milton, Waste Wks., Philadelphia, Pa.  
Railway Specialty & Supply Co., Chicago.

Water Softening Apparatus.  
Dearborn Drug & Chemical Works, Chicago.

Wheels and Axles.  
American Car Co., St. Louis.  
Brill, The J. G., Co., Philadelphia.  
Griffin Wheel Co., Chicago.  
Kuhlman, The G. C., Car Co., Cleveland.  
Lorain Steel Co., Philadelphia.  
McGuire-Cummings Mfg. Co., Chicago.  
Marshall, R. W., & Co., 95 Liberty St., New York.  
Railway Steel-Spring Co., New York.  
St. Louis Car Co., St. Louis, Mo.  
St. Louis Car Wheel Co., St. Louis.  
Standard Steel Works, Philadelphia.  
Stephenson, John, Co., Elizabeth, N. J.  
Wason Mfg. Co., Springfield, Mass.

Wheel Trinders.  
Wheel Grinding Brake Shoe Co., Detroit, Mich.

Whitewashing Machines.  
Wallace Supply Co., Chicago.

Window Fixtures.  
Drouvé, The G. Co., Bridgeport, Conn.

Wiping Rags.  
Hagy, J. Milton, Waste Wks., Philadelphia, Pa.

Wire, Aluminum.  
Aluminum Co. of America, Pittsburg, Pa.

Wire, Insulated.  
Aluminum Co. of America, Pittsburg, Pa.  
American Electrical Works, Providence, R. I.  
General Electric Co., Schenectady, N. Y.  
Okonite Co., Ltd., 253 Broadway, New York.  
Standard Underground Cable Co., Pittsburg, Pa.  
Stuart-Howland Co., Boston.

Wire and Cables.  
Aluminum Co. of America, Pittsburg, Pa.  
American Electrical Works, Providence, R. I.  
Bridgeport Brass Co., Bridgeport, Conn.  
General Electric Co., Schenectady, N. Y.  
Okonite Co., Ltd., 253 Broadway, New York.  
Standard Underground Cable Co., Pittsburg, Pa.

**TROLLEY WIRE, BARE COPPER CABLES**  
**WEATHERPROOF WIRE AND CABLES**  
RUBBER COVERED CABLES AND LEAD COVERED UNDERGROUND CABLES FOR ANY SERVICE. WRITE US FOR SPECIAL PRICES AT THIS TIME  
**STANDARD UNDERGROUND CABLE CO.**  
Pittsburg New York Boston St. Louis San Francisco Chicago  
Philadelphia Los Angeles Atlanta

**RUBBER and COCOA MATTING**  
**GUILFORD S. WOOD**  
ELECTRIC RAILWAY NECESSITIES  
Great Northern Bldg., Chicago

**Your Wife Will Laugh**  
if you tell her that you purchase electric tape by the pound. When she goes shopping yardage and quality direct her. Our No. 264 tape is the highest quality obtainable and the greatest yardage per pound. But don't lose sight of the yardage. Your jobber will supply you if you insist.  
*Write for quotations.*  
**MASSACHUSETTS CHEMICAL COMPANY**  
Operates  
Walpole Varnish Works  
Walpole Rubber Works  
PLANT: WALPOLE, MASS.

**In Buying Waste It is Important to Know—**  
FIRST—That it is free from dirt and grit.  
SECOND—That it is easy to pack.  
THIRD—That it is made up of all long strands.  
FOURTH—That it will absorb the oil in a manner insuring a free and even lubrication.  
*Hagy Waste meets specific conditions and ordinary ones*  
**The J. Milton Hagy Waste Works**  
433 Spruce Street  
Philadelphia

**THE BABCOCK & WILCOX COMPANY**  
85 Liberty Street, New York  
Babcock & Wilcox — Stirling — A & T Horizontal — Cahall Vertical  
**WATER TUBE STEAM BOILERS**  
Works: Bayonne, N. J. Barberton, Ohio.  
BRANCH OFFICES:  
BOSTON, Delta Bldg.  
PHILADELPHIA, 1110-1112 North American Bldg.  
SAN FRANCISCO, 63 First Street  
PITTSBURGH, Farmers Deposit Nat. Bank Bldg.  
NEW ORLEANS, 343 Baronne St.  
DENVER, 410 Seventeenth St.  
SALT LAKE CITY, 313 Atlas Block  
WASHINGTON, Colorado Building  
CHICAGO, Marquette Bldg.  
ATLANTA, GA., 1132 Candler Bldg.  
CLEVELAND, 706 New England Bldg.  
MEXICO CITY, 7 Avenida, Juarez  
HAVANA, CUBA, 116 1/2 Calle de la Habana  
LOS ANGELES, 321 Trust Bldg.  
CINCINNATI, O., Traction Bldg.



Passenger  
Paying  
Fare

Every nickel collected is registered before reaching the conductor's hand when you use the

# Rooke Automatic Fare Collector

The Rooke System is a revolution in fare-collecting methods, and as far superior to old systems as the trolley car is to the horse car.

Why not ask us to prove it?

**Rooke Automatic Register Co.**  
PROVIDENCE RHODE ISLAND  
3



Paints  
Enamels  
Colors  
Varnishes

for the  
Traction  
Trade

ACME WHITE LEAD & COLOR WORKS, Detroit, Mich.



Established 1877.



**ALBERT & J. M. ANDERSON MFG. CO.,**  
Makers of



**ELECTRICAL APPLIANCES:**  
SWITCHES, SWITCHBOARDS,  
TIME SWITCHES, LINE MATERIAL,  
COPPER CASTINGS (75% CONDUCTIVITY.  
289-293 A ST., BOSTON, MASS., U. S. A.

Branches:

New York, 135 Broadway. Chicago, 175 Dearborn Street.

Agencies:

Boston, Pettingell-Andrews Co. San Francisco, Eccles & Smith Co.  
New York, R. W. Marshall & Co. Atlanta, Newcomer-Manry Co.  
St. Louis, J. C. White. Denver, E. M. Messiter.  
Toronto, Ont., H. J. Surtees.

Save  
Your  
Armatures



No. 3  
Ball  
Check

Regulator open

**Durkin Controller Handle Co.**

Main Office, 1515 Sanson St.  
Treas. Office, 811 Arcade Bldg.  
**PHILADELPHIA**

SOUTHERN AGENT  
**UNIVERSAL RAILWAY SUPPLY COMPANY**  
BALTIMORE

## TUBULAR POLES

### IRON OR STEEL



FOR

**ELECTRIC RAILWAYS**

**ELECTRIC LIGHTING CO'S**

**SIGNAL** (SER)

**TELEPHONE** (VICE)

**TELEGRAPH**

**TRANSMISSION LINE**

**AND CATEANARY SUSPENSION LINE**

**ELECTRIC RAILWAY EQUIPMENT CO.**  
General Office. CINCINNATI, O. U.S.A.  
Shops: READING PA - WHEELING W.VA.

TRADE **WALKOVER** MARK  
**Car Seat**

Gives more room,  
 more comfort, and  
 more money value  
 than any other  
 seat made.

No. 99A  
 In Rattan



Notice its superior  
 construction and sub-  
 stantial appearance.  
 Specify and insist on our seats  
 for your new Electric Cars;  
 they cost less, in the end, than  
 the worthless imitations some-  
 times offered instead.

**The Hale & Kilburn Mfg. Co.**  
 PHILADELPHIA

NEW YORK

CHICAGO

WASHINGTON

**"TWO GOOD THINGS"**



"Hughson"  
 High Pressure  
 Reducing  
 Valve

"Hochfeldt  
 Eclipse"  
 Back Pressure  
 and  
 Relief Valve

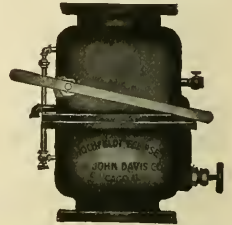

**"ARE THE BEST OF THEIR KIND"**

Manufactured by

**THE JOHN DAVIS COMPANY**  
 HALSTED 22<sup>ND</sup> AND UNION STS - CHICAGO

Walter G. Ruggles Co., 54 High St., Boston, Mass., New England Agent

Send for Catalogue and Prices

We furnish material for power plants to sketch ready for erection

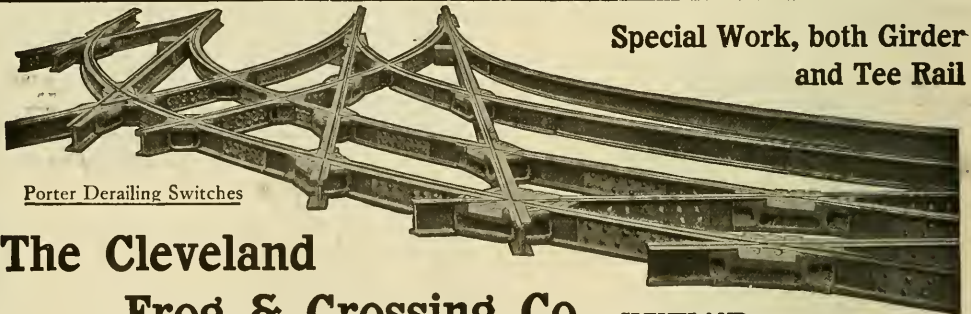

**Special Work, both Girder  
 and Tee Rail**

Porter Derailing Switches

**The Cleveland  
 Frog & Crossing Co., CLEVELAND**

**Avoid  
 Accidents**

By Using  
 This  
 Switch

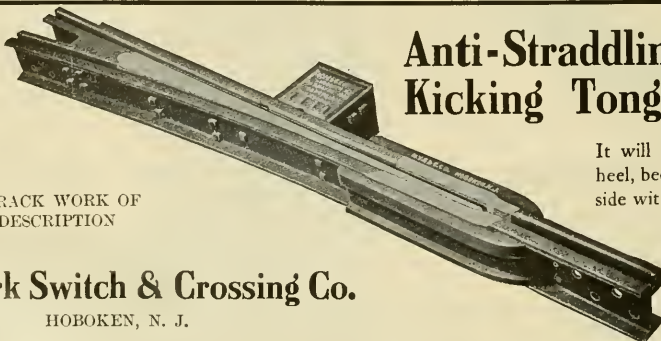

**Anti-Straddling or Anti-  
 Kicking Tongue Switch**

It will not drive down at the  
 heel, because it is held to either  
 side with a spring tension and  
 firmly down on its  
 bed. A car can not  
 straddle this tongue.

**WRITE FOR SPECIAL  
 CIRCULAR**

**New York Switch & Crossing Co.**

HOBOKEN, N. J.

SPECIAL TRACK WORK OF  
 EVERY DESCRIPTION

# FOR SALE. FOR QUICK DELIVERY

## 6 55-ft. Passenger, Baggage and Smoking Car Bodies

Main Compartment 26' 0"  
 Smoking " 10' 6"  
 Baggage " 10' 0"  
 Seating Capacity, 54

## 8 60-ft. Passenger, Baggage and Smoking Car Bodies

Main Compartment 28' 6"  
 Smoking " 11' 0"  
 Baggage " 8' 0"  
 Seating Capacity, 58

## 5 52-ft. Passenger and Smoking Car Bodies — Double End

Seating Capacity, 60

## 3 52-ft. Passenger and Baggage Car Bodies — Double End

Seating Capacity, 56

## 2 50-ft. Express Car Bodies

*Write or wire us for further information.*

**The Jewett Car Co.** Newark Ohio

### THE MIGHTY MIDGET HOT WATER CAR HEATER

Adapted for Large Electric Cars and Long Distance Lines. Exclusively used on Largest Electric Systems. Ask for Catalog

**THE WILLIAM C. BAKER HEATING & SUPPLY CO.,** 143 LIBERTY STREET NEW YORK



## NILES CARS

(The Electric Pullmans)

LARGE, FAST INTERURBANS  
 OUR SPECIALTY

### Niles Car & Mfg. Co.

Works: NILES, OHIO

Sales Office: J. A. HANNA CO.  
 312 Electric Bldg., Cleveland, Ohio

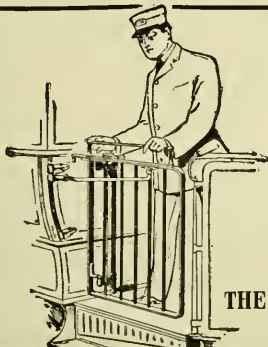

## Over 46,500 of Wood's Car Gate

Patented U. S. and Canada

### Equipments Now in Use

Do not bother passengers. Easy to operate. Light, strong, serviceable. Simple to apply on all styles of cars.

Ask for Prices

**THE R. BLISS MFG. CO.,** Pawtucket, R.I., U.S.A.

New York Office, National Novelty Corporation, 826 Broadway

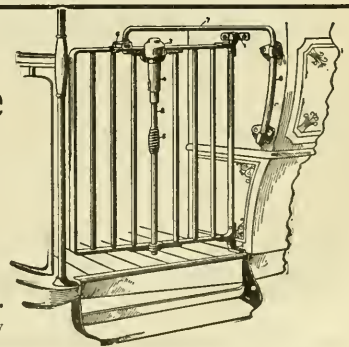

---

# Some Advertising Food for Serious Thought

---

The kind of advertising you have done in the past may not have paid, but there is a kind—a particular kind for your particular business—that will pay.

It is wholly unfair to conclude that advertising doesn't pay, just because a certain kind of advertising not adapted to your business, or not suited to the electric railway field, did not produce results worth paying for. We repeat—there is a kind of real advertising for your particular business that will pay.

The facts in the case are these:

1. Advertising rightly used is a most efficient aid in securing new business and in holding old business.

2. Real advertising will help any sales force do a bigger business.

3. It will sell or help sell goods direct and it will aid greatly in selling goods through the jobbing trade—and all at a cost far below any other method.

The whole problem of advertising resolves itself into just this:

What is the particular kind of advertising to be done to help sell your goods?

The question cannot be answered off-hand in detail, for it requires careful study, and usually considerable experimenting, to reach the correct solution. There are, however, certain well-defined principles governing advertising which may not safely be ignored.

**Advertising, to be productive of satisfactory results, must be done**

**sensibly** (which means telling the facts back of your goods in a manner to interest the buyer)

**attractively** (which means correct use of illustrations and display lines and the selection of proper spaces and positions)

**persistently** (which means "keeping everlasting at it"—and that, coupled with the foregoing, brings success)

---

The co-operation of our Advertisers' Copy Service will produce the kind of advertising you will be glad to pay for, because it will help sell your goods. Write

**Electric Railway Review** 160 Harrison St.  
CHICAGO, U. S. A.

---



# THE BOILERS WILL BE OUT OF SERVICE

a much shorter time for washing, thereby requiring very much less labor, to say nothing of the saving in fuel and the increased efficiency of the boilers, if the incrusting solids and other deleterious salts in the water are acted upon by **Dearborn Compounds** and their injurious properties destroyed. Send us gallon sample of your feed water for analysis.

## Dearborn Drug & Chemical Works

WM. H. EDGAR, FOUNDER

299 BROADWAY, NEW YORK      POSTAL TELEGRAPH BLDG., CHICAGO



Factory of The Milloy Electric Company  
Bucyrus, Ohio

### The Milloy Trolley Base

built in our new and specially equipped factory, insures a quality which will give excellent service under ordinary and extraordinary conditions.

The Milloy Base is unusually low, has even tension on high or low wire. Has no fulcrum, no friction, no oil, no center post. Always efficient. Particulars on request.

**THE MILLOY ELECTRIC COMPANY**  
Bucyrus, Ohio

### Hydraulic Motor Lifts

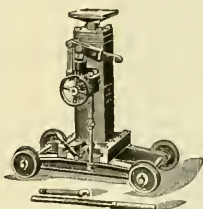

WE have different types of Hydraulic Motor Lifts for Street Railway use. Each one is thoroughly guaranteed.

SEND FOR SPECIAL RAILROAD CATALOGUE

### The Watson-Stillman Co.

26 Cortlandt St.  
NEW YORK CITY

Branch } 453 The Rookery  
Office } CHICAGO, ILL.



### RAIL WELDING

100 per cent Electrical Conductivity. No interruption of traffic. No Equipment Cars. All appliances simple and portable. Work done by contract or we will furnish supervision under guarantee.

Write for Pamphlet No. 13-Q.

**GOLDSCHMIDT THERMIT COMPANY**  
90 West St., NEW YORK      432-436 Folsom St., SAN FRANCISCO

INSULATING  
VARNISHES  
(BAKING; AIR-DRYING)  
COMPOUNDS  
TAPE



Possess the  
Highest Insulative  
Efficiency.  
The Standard Paint Co.  
100 William St.  
New York.

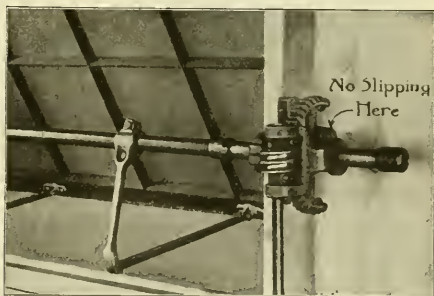

### The Ventilation

of your Shops, Foundries and Car-Barns is made especially effective by a speedy, positive and easily manipulated

### Sash Operating Apparatus

which automatically locks the sash at any position. Let us send you our catalogue

**LORD & BURNHAM COMPANY**  
Irvington-on-Hudson, N. Y.

**HOMER OF CLEVELAND  
COMMUTATORS**  
NOTHING ELSE  
**THE HOMER COMMUTATOR CO.**  
CLEVELAND, O., U. S. A.

**Mc GUIRE-CUMMINGS MFG. CO.**  
**SPECIALITIES IN RAILWAY EQUIPMENT**  
**CARS, TRUCKS, SPRINKLERS, SNOW SWEEPERS, ETC.**  
**CHICAGO**



**ECLIPSE  
Life Guard**

Manufactured by the  
**ECLIPSE RAILWAY SUPPLY CO.**  
 Cleveland, Ohio



**Time is Money**  
 That is one reason why the  
 Atlas Anchor is so popular.  
 Get a Working Model Free.  
**THE ATLAS ANCHOR CO.,** Cleveland, Ohio

**AS IT  
HOLDS**



**"NULLI SECUNDUS"**  
**J  
STOKES  
P  
S**  
 THE UNDER-  
 FEED  
 STOKES CO  
 OF AMERICA  
 WABUETTE BLDG  
 CHICAGO.



WE NOW MAKE 75% OF THE TROLLEY WHEELS.  
 WE WANT TO MAKE THE OTHER 25%.  
**THE STAR BRASS WORKS**  
 KALAMAZOO, MICH.



**BALDWIN LOCOMOTIVE WORKS**  
 BURNHAM, WILLIAMS & CO., PHILADELPHIA, PA., U. S. A.  
 Builders of **LOCOMOTIVES OF EVERY DESCRIPTION**  
 Including **ELECTRIC LOCOMOTIVES** and  
**ELECTRIC TRUCKS**

Truck built for Indianapolis, New Castle & Toledo Electric Railway Company.

**STANDARD STEEL WORKS,** HARRISON BUILDING  
 PHILADELPHIA, PA.  
**SOLID FORGED ROLLED AND STEEL TIRED WHEELS** ELLIPTIC AND  
 mounted on axles and fitted with Motor Gears for Electric Railway Service **COIL SPRINGS**



**PIPE FITTINGS  
AND VALVES**  
 FOR THE  
**HEATING AND PLUMBING TRADE**  
 TRADE  MARK  
**JOHN SIMMONS Co.**  
 104-110 Centre Street, NEW YORK

**THE LORAIN STEEL COMPANY**  
**Girder Rails and High Tee Rails**  
**High-Grade Special Track Work**  
 GENERAL OFFICES  
**THE PENNSYLVANIA BUILDING, PHILADELPHIA, PA.**

## DO YOU KNOW how completely, concisely and practically *The Railway Age* covers all steam railway topics of interest?

Most railway men know, because more of them read **The Railway Age** than any other journal, and it has subscribers wherever there are railways.

If you would like to know, ask for sample copies, which will gladly be sent on your request.

Then you will find these to be the facts:

**The Railway Age** is the authority on every question pertaining to the construction, maintenance, operation, traffic, accounting and administration of steam railways.

**The Railway Age** is an invaluable reference to every development and every improvement in every branch of railway service.

Published every Friday in the year and seven times daily during the annual mechanical conventions—fifty-nine issues, \$4.00.

*Ask for the samples now—while you think of it.*

**The Railway Age, 160 Harrison Street, Chicago**

# How to Secure a Position Through Advertising:

**First**, tell exactly the kind of position you want.

**Second**, tell in detail why you believe you can fill the position satisfactorily.

**Third**, give such other facts as you would care to know if you were in your prospective employer's place and considering an advertisement

making application for a position.

**Fourth**, don't expect one insertion of an ad to bring you the best job you ever had. Order your ad inserted several times. If you secure a position before all insertions have been made, the amount paid for the unused space will be refunded on request.

*At the top of the following page you will find complete information about classified advertisements in the ELECTRIC RAILWAY REVIEW. Your order will receive careful attention. Send it to*

**Electric Railway Review** 160 Harrison St. **Chicago**

# CLASSIFIED ADVERTISEMENTS

Undisplayed advertisements are inserted under this heading at the uniform rate of one cent a word; minimum charge twenty-five cents. Replies directed to this office will be forwarded when required to any address in the United States, Canada or Mexico without extra charge. Advertisements received at the Chicago office by 9 a. m. Thursday will appear in the issue for the same week.

## POSITIONS WANTED.

A young man, 27 years of age, with ten years' experience, wants position as engineer or electrician; unmarried; habits strictly temperate; high-class references. Address "No. 710," care Electric Railway Review, Chicago.

Storeroom man wishes to make change. At present employed; can furnish first-class reference from present employers. Able to do any kind of office work. Address "Storeroom," care of Electric Railway Review, Chicago.

Position wanted by a young man (23) of good habits; have been connected four years with the operating and purchasing departments of an electric street railway company; can give good references. Address "No. 528," care of Electric Railway Review, Chicago.

Position as chief electrician or superintendent; 16 years' experience lighting, power and traction work, alternating and direct current; graduate of well-known school; excellent testimonials; disengaged. Address "No. 529," Electric Railway Review, Chicago.

Auditor, experienced in electric railway and lighting and construction accounting, wants position with fair-sized company. Energetic and good systematizer. Best references. Address "No. 527," care of Electric Railway Review, Chicago.

Position by a single man, 29 years old, practical electrician and machinist, 10 years' experience, familiar with electric car and locomotive repairs, power and substitution practices. Non-union man. Address "No. 630," care of Electric Railway Review, New York, N. Y.

Position of chief motorman or instructor by a first-class competent man who has had 12 years' experience in that line. Thoroughly understands economy in regard to use of power and care of rolling stock; familiar with quadruple equipments and air brakes; highest references. Address "Chief Motorman," care of Electric Railway Review, Chicago.

## POSITIONS WANTED.

Graduate civil engineer, Cornell University 1902, experienced in field work and trade journalism, now engaged, desires work with technical journal or publicity department of manufacturing establishment. Address "No. 525," care of Electric Railway Review, Chicago.

Position wanted by first-class engineer and machinist with 18 years' practical experience with compound Corliss engines, Allis-Chalmers and Westinghouse steam turbines, surface condensers, A. C. and D. C. electrical apparatus. Age 35. All references. Address "No. 532," care of Electric Railway Review, Chicago.

Experienced and efficient engineer with power station experience (both planning and construction, as chief engineer and as superintendent of construction) desires position with operating company as engineer, assistant to manager or superintendent. Address "No. 515," care of Electric Railway Review, Chicago.

Young man, 30 years of age, who has nearly completed a course of "Electric Lighting and Railway" in the International Correspondence Schools, desires position which will give him practical experience in power house and switchboard work. Willing to start at a nominal salary. Address "No. 526," care of Electric Railway Review, Chicago.

Position wanted by unmarried man (23) with a city or interurban electric railway or with electric light and power company. Would prefer position in engineering, erection or operating department. Technical electrical graduate. Two years' experience with firm of contracting engineers in drafting room, shop work and erection work. Familiar with the design and erection of complete steam and electric plants. Am at present employed as erecting engineer by a small concern, but wish to make a change. Permanent position and good chances for advancement are of more importance than the question of salary. Best references furnished as to character and ability. Location anywhere. Address "No. 531," care of Electric Railway Review, Chicago.

## POSITIONS WANTED.

Wanted—Position with interurban road by an engineer having eight years' experience in power station and general railway design and construction work. Age 33; best references furnished. Prefer position with road now under construction. Address "No. 534," care of Electric Railway Review, Chicago.

Position Wanted—Have had wide experience in all kinds of street railway work, estimating, specifications, superintending and directing, overhead, underground and power station construction. Have for three years been superintendent of lines for large Massachusetts railway company. Technical education. Nine years' experience. Age 30 years. Wide acquaintance. Best of references. Address "No. 533," care of Electric Railway Review, Chicago.

## POSITIONS OPEN.

Twelve offices, covering the entire street railway and manufacturing world. Positions open everywhere; office, sales and technical. Write today, HAP-GOODS, 305 Broadway, New York, or 1010 Hartford Bldg., Chicago.

## MISCELLANEOUS WANTS.

Want to buy second-hand equipment, machinery or material? A card inserted in the Electric Railway Review, stating just what you want, will bring immediate response. The cost is small—only \$1.20 an inch (measuring 1 inch deep by 1½ inches wide) per insertion. Send orders to Electric Railway Review, 160 Harrison St., Chicago.

What have you to sell in the way of second-hand equipment, machinery or material? Buyers read the "For Sale" cards on the following page and there is the place to tell your story. "For Sale" cards are inexpensive—only \$1.20 an inch (measuring 1 inch deep by 1½ inches wide) per insertion. Special rates on contracts for 100 inches or more to be used within one year. Now is the time to send your order to Electric Railway Review, 160 Harrison St., Chicago.

## BUSINESS OPPORTUNITIES.

WANTED—RAILWAY SPECIALTIES. WE HAVE OUR OWN MANUFACTURING AND SELLING ORGANIZATIONS, WITH FACILITIES FOR SELLING THE RAILWAY TRADE. WE DESIRE TO SECURE FOR MANUFACTURE AND SALE SOME GOOD RAILWAY SPECIALTIES. ADDRESS "H. M.," CARE OF ELECTRIC RAILWAY REVIEW, CHICAGO.

## BOOKS AND PUBLICATIONS.

Copies of the Street Railway Review of January and February, 1906, are wanted. Name condition and price. Address "No. 535," care of Electric Railway Review, Chicago.

Wanted—Copy of the Electric Railway Review of January 12, 1907, in good condition. State price in your answer. Address "No. 530," care of Electric Railway Review, Chicago.

A copy of "The Motorman and His Duties," the standard handbook on the theory and practice of electric car operation, is worth many times its cost to every man interested in the subject. Send for 16-page pamphlet of sample pages. The Wilson Company, 160 Harrison Street, Chicago.

Interstate commerce national legislation to July 1, 1906, is fully covered in our reference pamphlet. It contains the full text of the act to regulate commerce as amended, including the Elkins and Hepburn acts, and of the supplementary act relating to the testimony of witnesses before the interstate commerce commission. It also contains the texts of the expedition act, the anti-trust act of 1890, the employers' liability act and the safety equipment laws. Difference in type shows the parts expunged from, and the parts added to, the interstate commerce and Elkins acts by the Hepburn act. This pamphlet is of special value to railway men and lawyers. Mailed prepaid for 25 cents in stamps or coin. Special prices for quantities. The Wilson Company, 160 Harrison St., Chicago.

## If You Have a Position for a High Grade Man

you can quickly secure his services in one of two ways

- by answering "Positions Wanted" advertisements on this page, or
- by advertising on this page under the heading, "Positions Open"

*Either plan will prove a winner—try it now*

# "Wanted" and "For Sale" Cards

especially for the marketing of second-hand equipment, machinery, material, etc., are carried on this page at a uniform rate of **\$1.20 an inch** (measuring 1 inch deep by 1 1/4 inches wide) **per insertion.**

Special rates made on contracts covering 100 inches or more.

Send orders to

**Electric Railway Review**  
160 Harrison Street - CHICAGO

**R.W. MARSHALL & CO.**  
95 and 97 Liberty St., NEW YORK  
Second-Hand Machinery and Equipment  
**ELECTRIC RAILWAY MATERIALS**

**RAILS**  
*Locomotives, Cars, Etc.*  
Bought & Sold  
Walter A. ZELWICKER Supply Co.  
ST. LOUIS

**FOR SALE CHEAP!**  
One 14x22 eight-wheel locomotive  
Ten 34-foot 50,000 capacity flat cars  
Two Greenleaf turntables  
70 box cars, 40 x 50, 50,000 capacity  
80 Good Second-hand Bridges  
Specifications and Blue Prints on application  
**F. A. JOHANN**  
1624 Pierce Bldg., St. Louis, Mo.

**HEINE SAFETY BOILER CO.**  
421 OLIVE STREET, ST. LOUIS, MO.  
Manufacturers of WATER TUBE BOILERS

**WANTED:**  
About 200 feet of light, second-hand trolley bridges to use for wharf purposes in Maine.  
MUST BE CHEAP FOR CASH.  
Address Lock Box 335,  
**GREENFIELD, MASS.**

**ROSSITER, MACGOVERN & CO. (Inc.)**  
90 West Street, New York  
**ENGINES** Boilers, Locomotives, Cars,  
New and **GENERATORS** 2nd Hand  
Transformers, Railway, A. C. & D. C. **MOTORS**

## Armstrong Journal Oiler

SAVES OIL SAVES MONEY  
PREVENTS HOT BOXES

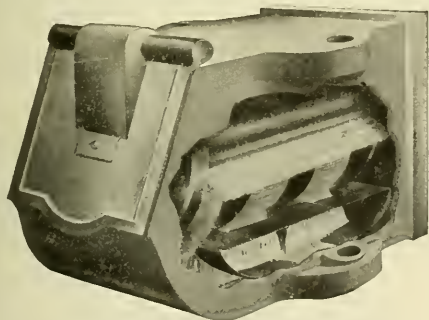

A Perfect Journal Lubricator

Will last several seasons without renewal, like waste; and can not shake away from the journal. Catalogue and trial sample for the asking.

**Armstrong Oiler Co.**  
31st and Chestnut Streets - PHILADELPHIA  
**OHIO BRASS COMPANY**  
MANSFIELD, OHIO Agents West of Pennsylvania

**GENERAL STORAGE BATTERY CO.**  
NEW YORK  
Our New Catalogue is nearly ready  
Get on our Mailing List  
**GENERAL STORAGE BATTERY CO.**  
Works, Boonton, N.J. Offices, 42 Broadway, N.Y.

The Recording Fare Register Company  
New Haven, Conn.

**SPEER HIGH GRADE BRUSH**  
ST. MARYS - PA.

**E. C. Van Valkenburgh**  
Promotional Advertising for Electric Railways  
2117 West 102d St.  
CHICAGO  
Reduce your operating expenses by increasing your passenger mileage—ADVERTISE.

**THE ARNOLD COMPANY**  
 ENGINEERS-CONSTRUCTORS  
 ELECTRICAL - CIVIL - MECHANICAL  
 101 LA SALLE STREET  
 CHICAGO

**A. L. REGISTER & CO.**  
 Engineers and General Contractors—Electric Railways  
 112 North Broad St. PHILADELPHIA, PA. Established 1889

**H. M. Bylesby & Company**  
 Incorporated  
 ENGINEERS  
 American Trust Bldg., Chicago  
 Design, Construct and Operate  
 Railway, Light, Power and  
 Hydraulic Plants  
 EXAMINATIONS AND  
 REPORTS

**SHIMER & CHASE CO.**  
 Experienced Promoters of Electrical Railway Projects  
 Correspondence Solicited  
 OMAHA, NEB.

**CENTRAL INSPECTION BUREAU**  
 Inspection of Rails, Ties, Cars, Motors, Bridges, Buildings, Etc.  
 17 STATE STREET - - - NEW YORK CITY

**LINE MATERIAL**  
 ELECTRIC SUPPLIES FOR RAILWAYS, POWER PLANTS, ETC.  
 THE CREAGHEAD ENGINEERING CO., 346 Main Street, Cincinnati, Ohio

**J. G. WHITE & COMPANY**  
 INCORPORATED  
**Engineers, Contractors**  
 43-49 Exchange Place,  
 41-43 Wall Street  
 New York, N. Y.  
 Principal Philippine Office: Manila, P. I.

WRITE TO **MODEL STOKER COMPANY** DAYTON OHIO  
 for detailed information about the best  
**AUTOMATIC SMOKELESS FURNACE**

**Gongs** For Street Cars **Bells**  
 G. C. REITER, Canton, Ohio

**Complete Plants for the Rapid  
 Handling of Material**  
 Every Sort of Hoisting Apparatus  
 BROWN HOISTING MACHINERY CO. Cleveland, Ohio

**THE CURTAIN SUPPLY CO.**  
 CAR CURTAINS  
 CHICAGO, 85-93 Ohio Street 1819 Park Row Bldg., NEW YORK

**BRAKESHOES**  
 STANDARD  
 BRAKESHOE COMPANY  
 GEN'L OFFICES & WORKS - AURORA, ILL. - CHICAGO OFFICE 315 RY EXCH.

**VALVES—FITTINGS—STEAM SPECIALTIES**  
**CRANE CO.**  
 CHICAGO  
 ESTABLISHED 1855

**SMITH CONCRETE MIXER**  
 does the work better, quicker, cheaper and lasts longer.  
**CONTRACTORS' SUPPLY & EQUIPMENT COMPANY**  
 Old Colony Building, Chicago 170 Broadway, New York 9

**HART** CONVERTIBLE **CAR**  
 BALLAST, GONDOLA AND CONSTRUCTION  
 RODGER BALLAST CAR CO., Railway Exchange, CHICAGO

**GREEN FUEL ECONOMIZER CO.**  
 Sole builders of the Green Fuel Economizer in the United States. Also Fans, Blowers and Exhausters, Steam Heating Coils and the Green Air Heater. Heating, Ventilating and Mechanical Draft Apparatus. Send for Book "SV" on Fuel Economy and Fan Catalogue.  
 GREEN FUEL ECONOMIZER CO., Matteawan, N. Y.

**RE-ENFORCED SPOKE WHEELS**  
 For City and Suburban Cars  
 ST. LOUIS CAR WHEEL CO., St. Louis, Mo.

**GEARS AND PINIONS**  
 FOR ALL TYPES OF MOTORS  
 THE VAN DORN & DUTTON CO., CLEVELAND, OHIO

**STONE & WEBSTER ENGINEERING CORPORATION**  
**CONSTRUCTING ENGINEERS**  
 147 MILK STREET, BOSTON  
 ELECTRIC RAILWAY, LIGHT & POWER PLANTS  
 WATER POWER DEVELOPMENTS

**E. SAXTON CONTRACTOR**  
 SPECIALTIES:  
 CONDUIT ELECTRIC RAILWAYS  
 TROLLEY LINES  
 CITY AND SUBURBAN  
 CONDUIT SYSTEMS, ETC.  
 OFFICE, 841 BLADENSBURG ROAD, WASHINGTON, D. C.  
 Long Distance Telephone, East 887

**The Lindsley Brothers Company**  
 Producers and Shippers of and Manufacturers of  
**WESTERN CEDAR POLES** **RED FIR CROSS ARMS**  
 Eastern Sales Office, Monadnock Bldg., CHICAGO SPOKANE, WASHINGTON

**POLES and PILING** 20,000 35s and 40s, Ready to Ship at Once  
 S-E. MISSOURI CYPRESS CO., CAMPBELL, MO.

**G. H. BARNES HARDWOOD LUMBER CO.**  
 Office and Yard: Main and Warren Sts., ST. LOUIS, MO.  
 Ties, Car Oak, Poplar, Ash, Cherry, Plain and Quartered Oak

**GRIFFIN WHEEL CO.**  
 CHICAGO  
 CHILLED IRON CAR WHEELS IRON OR STEEL AXLES

**C. H. WORCESTER CO.**  
**CEDAR POLES**  
 PRODUCERS AND WHOLESALERS  
 Suite 1710 Tribune Building CHICAGO

**Idaho Cedar Poles**  
 PACIFIC COAST POLE CO. SPOKANE, WASH.

We have in our Chicago Yard available for **RUSH SHIPMENTS** a **SELECTED STOCK** of **POLES** and **TIES**  
**NAUGLE POLE AND TIE CO.**  
 Chicago Office, 226 La Salle Street

We are Producers and Wholesale Dealers in Western  
**CEDAR POLES**  
 Yards in Washington, Idaho, Montana and British Columbia  
 WRITE US FOR DELIVERED PRICES  
**CHURCHILL CEDAR CO.,** Box 1409, Spokane, Wash.

**CHESTNUT POLES**  
 Cedar, Oak and Chestnut Ties  
 FROM OUR OWN TIMBER LANDS  
**THE ADVANCE LUMBER CO.**  
 CLEVELAND, OHIO

**HUMBIRD LUMBER CO., LTD.**  
**Cedar Poles and Piling**  
 SANDPOINT, IDAHO.

**40% SAVED**  
 BY USING  
**Lumen Bronze Axle Bearings**  
 Cast in metal mold—require no-machine finish  
**Lumen Bearing Company**  
 BUFFALO — TORONTO

**Coach and Car (Metal) Surfacers**  
 Elastic — Durable — Economical  
 **ST. LOUIS SURFACER & PAINT COMPANY**  
 St. Louis, U. S. A.

<b>WHITE CEDAR</b>	<b>P O L E S</b>	Large Stock 14 to 65 ft.
<b>P O L E S</b>		Prompt Shipment
<b>YARDS:</b> Menominee, Mich. Escanaba, Mich. Superior, Wis. Deer River, Minn.		<b>FRANCIS BEIDLER &amp; CO.</b> Chicago, Ill.

**BERTHOLD & JENNINGS**  
 LUMBERMEN'S BLDG. SAINT LOUIS, MO.

**TIMBERS**  
 L. L. Pine, Oak

**POLES**  
 Cedar, Cypress, Chestnut

**TIES**  
 Oak, Cypress, Chestnut

## Whitmore's Gear Protective Composition

produces everything that we guarantee it to do. Ask for the names of those who have had experience with it. They will have no other.

The Whitmore Manufacturing Company  
Cleveland, Ohio, U. S. A. 3

## WESTON Standard Portable Direct-Reading

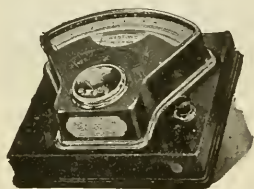

**Voltmeters  
Millivoltmeters  
Voltammeters  
Ammeters  
Milliammeters  
Ohmmeters  
Ground Detectors  
and Circuit Testers**

OUR STATION VOLTMETERS and AMMETERS are unsurpassed in point of extreme accuracy and lowest consumption of energy.

## WESTON ELECTRICAL INSTRUMENT CO.

Main Office and Works: Waverly Park, Newark, N. J.

London Branch: Audrey House, Ely Place, Holborn, Paris, France: E. H. Cadot, 12 Rue St. Georges, New York Office: 74 Cortlandt St., Berlin: European Weston Electrical Instrument Co., Ritterstrasse, No. 88.

## Queen Testing Sets

"The Recognized Standard"

Voltmeters  
Ammeters  
Switchboard  
and Portable  
Alternating  
and Direct  
Current



Queen Acme Testing Set

U. S. Standard Testing Sets

Rail Bond Testers

Galvanometers, etc., etc.  
Electrical Instruments for All Purposes

QUEEN & CO., Inc., Philadelphia, Pa.

## Railway Steel-Spring Co.

GENERAL OFFICES: 71 Broadway, NEW YORK

Springs  
Steel-tired Wheels  
Latrobe Motor Wheel Tires

BRANCHES: Chicago, Detroit, Louisville, Mexico City, St. Louis, St. Paul, Washington

# Ever pay an advertising bill with a smile?

Some men pay advertising bills with the same joyous, buoyant spirit with which they cough up for back taxes.

Others, who do real advertising, feel that they can afford to smile when paying the bills, because they know they have gotten their money's worth.

If you feel bad when you pay an advertising bill, there's something wrong, because you really ought to feel happy. You will find the wrong in your advertising copy or your advertising methods if you look for it. As sure as you're a foot high, you'll find one or both of these:

**Your copy doesn't make buyers sit up and take notice because you say the same old thing in the same old way.**

**Your advertisement is so small that nobody ever sees it except by accident.**

If you want to smile every time you pay your bill, do real advertising in the

**Electric Railway Review**  
160 Harrison St.  
CHICAGO





**COLUMBIA** CARBON BRUSHES wear smooth, take a high polish and will outlast any other long life brushes made, with less wear on commutator.

**NATIONAL CARBON CO.** Cleveland, Ohio

**THE NATIONAL LOCK WASHER CO.,** NEWARK, N. J.

Curtains - Curtain Fixtures - Sash Locks - Sash Balances - Nut Locks  
CHICAGO OFFICE: 419 MONADNOCK BLOCK

**THE AMERICAN FROG & SWITCH CO.,** HAMILTON, OHIO

SPECIAL TRACK WORK FOR ELECTRIC RAILWAYS

**HOT WATER HEATERS for Cars**

THE PETER SMITH HEATER CO., Detroit, Mich.

**CONSOLIDATED CAR-HEATING COMPANY**

NEW YORK

CHICAGO

Office and Station Heaters

**ELECTRIC HEATERS**  
For All Classes of Cars

Independent Vestibule Heaters

For CABLE, ELECTRIC and ELEVATED CARS

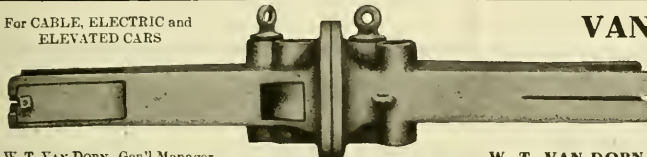

**VAN DORN AUTOMATIC COUPLERS**

The records go farther than talk.  
Look up the records.  
Send for booklet of information on Couplings.

W. T. VAN DORN, Gen'l Manager.

No. 5

W. T. VAN DORN COMPANY, 1076 S. Paulina Street, CHICAGO



CONTINUOUS JOINT

Over 25,000 miles in use



WEBER JOINT

Rolled from Best Quality Steel



WOLHAUPTER JOINT

Catalogs at Agencies

- Baltimore, Md.
- Boston, Mass.
- Chicago, Ill.
- Denver, Colo.
- Pittsburg, Pa.
- London, Eng.
- Portland, Ore.
- Seattle, Wash.
- St. Paul, Minn.
- St. Louis, Mo.
- Troy, N. Y.
- Montreal, Can.

HIGHEST AWARDS—Paris, 1900; Buffalo, 1901; St. Louis, 1904

Additional safety and economy in Track Maintenance has been proved by the use of Continuous, Weber and Wolhaupter base-supported rail joints—after ten (10) years' service, having a record of over 25,000 miles in use—the extent of which is evidence of their excellence.

**THE RAIL JOINT COMPANY**

General Offices: 29 West 34th Street, New York City  
Makers of Rail Joints for Standard and special Rail Sections, also Girder, Step or Compromise, and Insulating Rail Joints, protected by patents in United States and Foreign Countries.



**THE WHEEL TRUING BRAKE SHOE**

quickly repairs the crippled wheel and does it while the wheel is running. No argument is needed. Practical railroad men take in the situation at a glance. That is why we sell so many. Best material. Best workmanship. Great experience in this line of work. Low prices.

The Wheel Truing Brake Shoe Co.  
DETROIT, MICHIGAN

**The Signal System**

that prevents accidents  
facilitates traffic and  
promotes adherence to  
schedules

is made by the

**TELEGRAPH SIGNAL COMPANY**

282 State Street, Rochester, N. Y.

# PAINTS FOR DAMP PLACES

Especially adapted for water-power plants where the conditions are severe.

**Detroit Graphite Company**  
DETROIT, MICH.  
Dept. A.

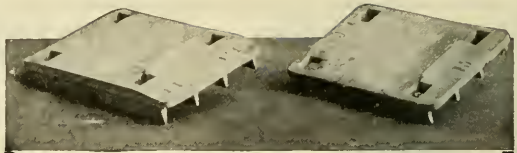

This kind for curves.

This kind for tangents.

## USE

# Beaver Dam Malleable Iron Tie Plates

They increase the life of ties by eliminating unnecessary wear, reduce cost of maintenance and make a safe track for high speeds and heavy loads.

Ask us to tell you why they are best for electric roads

**Beaver Dam Malleable Iron Co.**  
BEAVER DAM, WISCONSIN

6



(End View)

Has adjustable steel noses—suitable for general urban and light interurban service. The most efficient low priced electric snow-plow on the market.

### The RUSSELL Pedestal Electric Snow-Plow No. 6

Further information on request—also catalog electric snow-plows

**RUSSELL CAR & SNOW-PLOW COMPANY, Ridgway, Pa.**

Wendell & MacDuffie, Cortlandt St., New York—Eastern Sales Agents; Robinson & Cary Co., St. Paul, Minn., C. A. Ralston, Fisher Bldg., Chicago, Ill.—Western Sales Agents; Dominion Supply Co., Winnipeg, Manitoba—Western Canada Sales Agents.

# THE SYMINGTON JOURNAL BOX FOR ELECTRIC TRUCKS

Now Standard on the Majority of Modern Electric Trucks of M. C. B. or Special Type

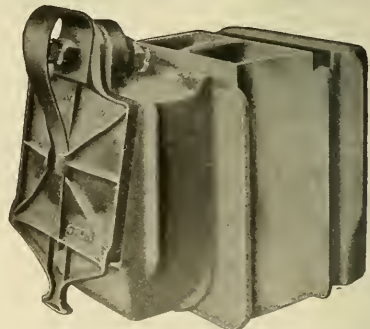
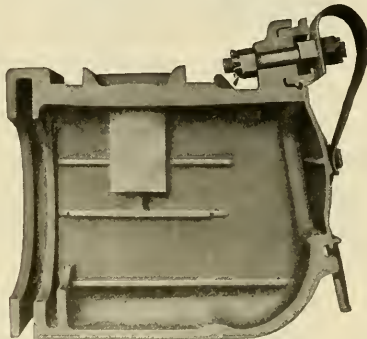

## Special Notice!

WE ARE PREPARED TO FURNISH AT ONCE THE **STANDARD JOURNAL BOXES** OF THE AMERICAN STREET AND INTERURBAN RAILWAY ASSOCIATION

BALTIMORE MD.

**THE T. H. SYMINGTON CO.**

CHICAGO ILL.

# Electric Railway Review

PUBLISHED EVERY SATURDAY BY THE WILSON COMPANY, CHICAGO

Entered as second-class matter January 5, 1907, at the postoffice at Chicago, Ill., under the act of March 3, 1879.

160 Harrison Street, Chicago  
150 Nassau Street, New York  
1529 Williamson Bldg., Cleveland

VOL. XIX  
No. 4

CHICAGO, JANUARY 25, 1908.

Whole No.  
248

Subscription: Domestic . . . \$2  
Foreign . . . \$5  
Canada . . . \$3.50

The electric railways of the north central states have a most excellent organization in the Central Electric Railway Association. This body has just completed its second year, and, as clearly stated in the annual address of the retiring president, H. A. Nicholl, general manager of the Indiana Union Traction Company, a large amount of valuable work has been accomplished. At the meeting held on Thursday of this week an auxiliary association, known as the Central Electric Traffic Association, was formed. This new organization will hold its meetings at the same place and one day earlier than its parent, the Central Electric Railway Association. As outlined by its organizers elsewhere in this issue, there are a great number of problems of traffic and interline business which demand the attention of this new organization. It will have for a leader and valuable assistant the Central Electric Railway Association, which has done so much for its individual and company members.

The New York Evening Post recently published a summary of an experimental "trolley trip" from New York City to Chicago which presents some interesting figures. According to this report the journey required traveling a distance of 1,497 miles, of which two were covered on foot, two by stage and 230 by steam railroad to fill six gaps still existing between the electric railways. Four of the uncompleted connections were in the state of New York and two in Indiana. While the value of such figures is very small as far as any practical consideration is concerned, the facts are exceedingly interesting as an illustration of the extent of the interurban development. It is very probable that within the next year or two the remaining gaps will be closed up and that it will be possible to make a continuous journey by electric railway between these cities and also to extend it to St. Louis. However, the fact that the distance traversed, 1,497 miles, is about twice the air line distance from New York to Chicago is a sufficient indication of its unpractical character and of the fact that the interurban electric roads are not being developed with this end in view.

Comparatively little attention appears to be given to the location of motors in repair shops, except in cases where the machines are individually driven. Space is often ample to allow a shop motor to be placed almost anywhere out of the way of the movement of the shop employes, and, as the amount of power involved is seldom large, it is considered that it does not pay to spend much time in the location of the motor itself. At the same time a few points ought not to be overlooked in each case that bear directly upon low cost of installation and operation. It is seldom realized that the mechanical side of a group drive deserves far more attention than is usually given to it, but it is easy for the friction of the shafting and pulleys to consume as much power as the shop machines themselves. A well-lined and lubricated shaft, on the other hand, can sometimes be found which will run with its idle machinery four or

five minutes after the power is shut off, and such an installation can in a small shop compete in operating economy with an individually driven arrangement of motors and tools. The location of the shop motor so as to provide a direct or belted shaft connection at a middle point is mechanically advantageous, and if couplings are provided in the shaft repairs can be made without shutting down all the tools. An even distribution of the strains on the shafting and bearings tends to reduce friction losses, and, while this can doubtless be obtained by a carefully installed end drive, it can be better maintained by a center drive and with less chance of misalignment.

The location of shop motors on the floor has the advantages of decreased cost of installation, greater speed of erection, less danger of accident through the breaking of mechanical adjuncts and better accessibility. In a railway shop, however, space is valuable for working purposes, even if the cost of real estate is low, and the suspension of the motor from the ceiling or preferably its attachment to an overhead platform gives a freedom of movement below that is impossible with the motor on the floor of the main repair shop. The wiring is more readily kept out of the way in such a case, and with intelligent inspection of a regular character the motor and its driving connections with the shaft need not suffer in point of maintenance. The location of repair shop motors in places free from extreme heat and dirt is worth taking some trouble to secure, and in this connection the blacksmith shop is not a favorable site even for blower motors, unless care is taken to inclose them so that flying particles of metal and dust cannot get into the moving parts. On the whole, a location on an overhead platform near the center of the machine shop is probably the most desirable place for the small motors used in driving machine tools in street railway car maintenance.

Last year the New York State Association devoted considerable attention to the discussion of the use of T-rail in city track construction. A paper on this subject was presented by C. Gordon Reel, general manager Kingston (N. Y.) Consolidated Railway. This important contribution was founded on the extended experience of the author and his conclusions were substantiated by favorable reports regarding the use of T-rail in a large number of cities scattered broadcast from coast to coast. Since Mr. Reel's paper was read and published (Electric Railway Review, January 26, page 111) other papers on the same subject have followed, having been read before railway and civil engineering, civic and municipal associations. With these reliable statements of approval and the favorable results from experience wherever the standard rail section has been used, a foundation has been laid that should greatly assist railway companies in their endeavors to obtain consent for the use of T-rail within municipal limits. When municipal authorities are convinced of the practicability of the T-rail tracks, the next problem confronting the engineering department of a

railway is the choosing of a type of substructure which is best adapted to local conditions. H. L. Weber, chief engineer of the Ft. Wayne & Wabash Valley Traction Company, has had a wide experience in designing track foundations for use in the larger cities of northern Indiana, over the tracks in which cities operate some of many heavy interurban equipments. In this issue Mr. Weber describes, illustrates and exhibits detail costs of construction for several types of rail foundations. Especial attention is called to the use of a steel reinforcement in the concrete under rail joints. This article should be of particular interest to those who have so staunchly upheld the merits of concrete girders for supporting track rails.

#### PRELIMINARY POWER STATION PLANS.

One of the most troublesome questions that is liable to come up in connection with the development of a new power station or the extension of an existing plant is the matter of preliminary plans. In order to obtain close bids upon equipment the railway company must know accurately the capacity of the installation required and the position which each class of apparatus will probably occupy when the plant is completed. If preliminary plans are prepared in detail the chances are ordinarily that important changes will be made in the subsequent layout, and the expense of engineering in such a case may easily run too high. On the other hand, unless the limiting dimensions of the plant can be approximated closely, accurate cost estimates are exceedingly difficult to realize; the manufacturers of the different machines and equipments may have to bid higher to cover contingencies, and there tends to develop a general uncertainty as to the final correct assembly of the station.

Perhaps there is no point where an experienced consulting engineer can be of greater help to his clients than in these preliminary stages. A skilled designing organization, with a sense of proportion developed by the intimate study of hundreds of installation data, will strip the superfluities from a problem in design very quickly if the requirements are made plain by the client. The assembly of a great variety of apparatus under a single roof on plan and in elevation is merely a matter of finesse to the experienced engineer. The cost of drawing up detailed schemes can generally be avoided in the preliminary work of a large engineering organization, accustomed as it is to close fits of equipment and approximately accurate methods of assembling apparatus of different makes according to various schemes of arrangement. This kind of work can be handled in a rough way by the engineers of an operating company in cases where there is no outside advice retained, but great care is necessary to avoid going too much into detail. For the early work pencil sketches and cardboard templates are generally good enough to make clear to executive officers and bidders the probable shape and tentative make-up of the completed plant.

To secure bids upon apparatus it is not, of course, absolutely necessary to make up any sketches of the completed plant, but it is highly desirable to do this to the extent of showing several arrangement schemes in outline. Total capacities may be determined without plans, but the subdivision of these capacities often hinges on the possible arrangement to a very large degree. It is an easy matter to procure the over-all dimensions of all sizes of standard apparatus from the nearest district offices of their manufacturers, and these over-all dimensions are all that are necessary in the preparation of preliminary sketches. Seldom do the final plans of a new station appear clear to the designers at first, and excessive attention paid to filling in details of apparatus is largely wasted before the contracts are awarded. If the general arrangement schemes, however, are worked out with considerable care, the adjustment of subsequent details becomes easier; the proper size of machinery for different locations can be more readily settled; the manufacturer can more easily suggest desirable

modifications in the original scheme; the purchaser stands closer to accurate cost estimates, and the final assembly of the apparatus of the successful bidder becomes more certain in its mutual adaptation.

#### THE BOSTON ELEVATED RAILWAY.

The pamphlet report issued by the Boston Elevated Railway under date of December 31, 1907, is the tenth annual report of the directors of that company. It contains statistics and facts which stamp this company as an unusual public service corporation. The principal figures for the fiscal year ended September 30 last, which is covered by the pamphlet report, were published in the Electric Railway Review of November 9, 1907, while an abstract of the statement of President William A. Bancroft was given in our issue of January 11.

The Boston Elevated Railway does not include in its report the details of the operating revenue and operating expense accounts, but its information is so much fuller than that given by most companies that a valuable analysis of the sources of revenue and the charges for expenses can be made. As the operating expenses are divided under the principal headings of maintenance, transportation and general expenses, it is possible to show what proportion of the gross earnings and of the operating expenses was absorbed by each of these departments. The comparison becomes more interesting if shown on a revenue car-mile basis, a reduction which is possible because the company includes car-mile figures in its report. The car-mile results for the last fiscal year as compared with the previous fiscal year show the following:

	1907.	1906.
Per revenue car-mile, cents—		
Gross earnings from operation.....	26.80	26.90
Transportation expenses.....	12.66	11.72
General expenses.....	1.89	1.95
Maintenance roadway and buildings.....	2.04	2.41
Maintenance equipment.....	1.94	2.43
Total operating expenses.....	18.53	18.51
Net earnings from operation.....	8.27	8.39

From the foregoing it will be observed that while there was a slight decline in car-mile gross earnings a slight increase in operating expenses took place. This is due to an increase of 0.94 cent in transportation expenses, reflecting the high costs of wages and materials which have been felt by substantially all railways. Had the general expenses and the expenditures for maintenance of roadway and buildings and of equipment continued at the same rate as in the previous year the net earnings from operation would have been appreciably reduced, but reductions in expenditures of these departments made the total operating expense per car-mile but slightly above that of the preceding year.

In the report for the year ended September 30, 1903, President Bancroft announced a revision of wages. Under this plan young men who spent the time required to learn enough of the business to perform regular duties were to be paid at the rate of \$1.00 a day. After men were accepted for service on the surface lines they were to be paid minimum wages of \$1.50 a day, if they reported for duty at the car houses and remained there during the prescribed hours even without working. This latter arrangement applied also to extra men. It was also decided to allow an increased compensation of five cents a day for every five years of continuous service up to 15 years of such service, and any employe who in the judgment of the management should be unfit to perform any duty in the service of the company, and had been continuously employed by the company for 25 years, or had reached the age of 60 years and had been continuously employed by the company for 15 years, was to receive a sum not exceeding \$25 per month during the rest of his lifetime. These provisions applied also to elevated carmen and to various others connected with the operation of cars. To induce meritorious service it was decided to pay \$15 at the end of each calendar year to each car service man who had rendered

continuous and satisfactory service throughout the preceding 12 months.

In the report which is just issued the details of these payments in the last fiscal year are given. Learners received \$27,670 and new or extra men received, as guaranteed minimum wages, \$42,822. Long-service men received as increased compensation under the plan \$66,630, while the company paid in pensions \$11,326. For satisfactory service the company paid \$55,320, or \$15 each to 3,688 men. The aggregate sum of these increased payments was \$203,768. Beginning with 1907 the company made further provision for an increase in the pay of its car service men and those directly connected with the operation of cars. Under this provision the railway paid out in increased wages \$97,726, making with the \$203,768 a total of \$301,494.

ANNUAL REPORT.

Toledo Railways & Light Company.

Operating expenses and taxes of the Toledo (O.) Railways & Light Company in the year ended December 31, 1907, required 58.67 per cent of gross earnings, as compared with 52.34 per cent in the previous year and 50.85 per cent in 1905. The operations in three years compare as follows:

	1907.	1906.	1905.
Gross earnings .....	\$2,362,976	\$2,047,611	\$1,913,456
Operating expenses and taxes	1,386,427	1,071,773	972,994
Net earnings .....	\$ 976,549	\$ 975,838	\$ 940,462
Interest .....	653,372	509,607	510,307
Divisible income .....	\$ 323,177	\$ 466,231	\$ 430,155
Dividends .....	120,000	240,000	240,000
Surplus .....	\$ 203,177	\$ 226,231	\$ 190,155

The figures for 1907 include the operations of the Toledo Gas Electric & Heating Company from June 1, 1907. Henry A. Everett, the president, states that this property "will be of great value to the Toledo Railways & Light Company, which now owns and operates the entire street railway system of the city of Toledo, furnishes electricity for light and power, owns and operates the only artificial gas plant furnishing gas for light and fuel, and furnishes hot water heating."

The company also acquired during the year the entire capital stock of the Toledo Ottawa Beach & Northern Railway and the Toledo & Western Railroad. In addition to these holdings, it owns the entire stock of the Maumee Valley Railways & Light Company, operating entirely in Ohio, and of the Adrian (Mich.) Street Railway. These four roads operate a total of 126 miles of track.

In his statement to stockholders Mr. Everett states:

The franchises of this company are being operated under something more than 100 ordinances of the city of Toledo and proceedings of the Lucas county commissioners, all favorable in their terms. Those relating to gas, electricity, power, light, heating and the underground conduit system are perpetual, subject only to the ordinary police regulations, and to the statutory requirements of the state of Ohio that the prices to be charged shall be regulated at intervals of not exceeding 10 years. The rights of the company to operate its street railway in certain streets will expire on November 9, 1910, but the larger part of the system is being operated under ordinances which expire in 1914, 1915 and 1916, and the demand for transfers from one part of the system to the other makes it practically certain that no considerable change in the present operation or in fares will be made until about 1914.

Extensive betterments have been made on the electric, gas, heating and railway plants so that the capital requirements for 1908 will be small. The buildings on Central avenue, consisting of general shops and car storage building, have been equipped with a sprinkling system, and a 50,000-gallon tank erected. This reduces the insurance rate at this station on buildings and cars from an average of 1.35 to 0.30.

Mr. Everett states that the discontinuance of dividends was decided upon by the directors on account of the financial conditions, which made it impossible to dispose of any of the treasury assets, and the large expenditures for betterments.

# Communications

## PRACTICAL VIEWS ON TRUCKS FOR ELECTRIC MOTOR SERVICE.

To the Editors:

In an article in the Electric Railway Review for October 19, 1907, page 679, entitled "Practical Views on Trucks for Electric Motor Service," by Franklyn M. Nicholl, a number of points in relation to the M. C. B. type of truck are brought up and discussed. It very wisely presents the subject for discussion at this time when efforts are being centralized on the standardization of the various parts of electric motor trucks.

Before considering a few points in the article, let me ask the author for his authority when he states that the type of the steam passenger coach truck, known as the M. C. B., was designed and adopted by the Master Car Builders' Association? In other words, has the association ever adopted a standard type of truck?

In the analysis of the M. C. B. type of electric motor truck the author finds that two separate and distinct frames constitute its principal parts, one being the main truck frame and the other consisting of the axle and equalizing bars. Between these two frames the motors are suspended, and, because of the propelling force of the motors and the independent movements of the frames, the author infers that the frames are made antagonistic to each other, resulting in excessive wear between the parts in contact, and inability to maintain squareness. Unquestionably his inference would be correct if the motors were rigidly connected to both frames, but he has overlooked the fact that provision is made against interference between the independent movements of the two frames by a flexible connection of the motors to the main frame. I agree with the author's statement generally that there would be advantage in truck construction and operation if the motors could be so mounted on a truck that their propelling force and resistance thereto would be involved by only one frame, or, more properly speaking, by the frame composed of equalizing bars and axles. Such an arrangement is a mechanical impossibility in connection with the so-called M. C. B. design. There is on the market at the present time, has been for eight years past, and will undoubtedly remain for a long time in the future, a truck which to my mind is more properly and thoroughly equalized than the so-called M. C. B. It has for one of its basic principles the mounting of the motors on the axles on one side and on a frame on the other side which constitutes and performs the same functions as the equalizing bar in M. C. B. trucks. I refer to the Brill No. 27-E truck.

The paper does not discuss the defects in the basic principles of the truck in question, but it is evident that the writer realizes the defects and that they are inherent, for he suggests a form of truck from which he eliminates the swing bolster and the equalizing bar principles. While it is true that the type of swing bolster used in this (the so-called M. C. B.) truck is inadequate for the speeds and curves of modern electric practice, yet I do not believe that the compensation for undue lateral motion to the car at curves can be met in a practical manner by truck construction. The inadequacy of the type of swing bolster used in the M. C. B. type of truck is due, I am convinced, to the lack of elasticity in this motion. The defect, according to my knowledge and experience, is completely overcome in the other truck referred to—the Brill No. 27-E—by what is called the spring link suspension device.

The reasons given by the author for eliminating the equalizing bar principle and reducing the truck to a single frame are, first, that the position of the brakeshoes in relation to the wheels will remain normal at all times; secondly, that each motor will receive its equal share of the load. Both

of the advantages named can be secured in a properly designed truck without the sacrifice of principles which have proved to be essential to safety and to easy riding, which a single frame construction would entail. In suggesting a single-frame truck the author reverts to a type of construction long since discarded in this country but still used in Europe, where the trucks are notoriously hard riders, and where, within the last two years, three serious cases of derailment with consequent loss of life have occurred.

There are few engineers or operators who will agree to an advantage in the elimination of the active principles involved and performed by equalizing bars. The very object which the author seeks to accomplish, viz., "squareness," would be most certainly defeated by the elimination of the equalizing bar principles, for the reason that no road is mathematically perfect; the only way possible for the four wheels and frames with a load sustained at a normal center to follow the irregularities in the roadway is to shift the load from one pair to the other pair of wheels diagonally across the truck, which throws all the torsional strains on the side frames at their junctions with transoms and end bars, loosening the fitting in time, and really helping the truck "out of square," followed with useless and unnecessary flange wear and more serious possibilities of derailment.

The lack of sufficient flexibility to accommodate itself to every track condition and the lack of stability of the main frame are the principal defects of the M. C. B. type of truck. I fail to see how the M. C. B. type of truck can be modified to suit the present and future requirements of both electric and steam operation. I should like very much to see a thorough and far-reaching investigation of the merits of this truck question, and suggest further discussion.

It would be interesting to have the experience and practice of electric railway engineers and operating men made known at this time on this subject.

C. LOOMIS ALLEN,

Vice-President and General Manager Utica & Mohawk Valley Railway.

Utica, N. Y., January 17, 1908.

[The Electric Railway Review will be pleased to receive with a view to publication the discussions requested by Mr. Allen from electric railway engineers and operating men interested in truck development.—Eds.]

#### CANADIAN ELECTRIC RAILWAY STATISTICS.

Statistics compiled by J. Lambert Payne, comptroller of railway statistics of the department of railways, Dominion of Canada, include the following figures for electric railways for the year ended June 30, 1907, according to the Montreal Gazette:

The paid-up capital was increased by \$11,337,505, bringing the total amount up to \$75,195,475. The mileage, however, remained almost stationary, and stands at 814.52. The gross earnings were \$12,630,430, showing an increase of \$1,663,559 over the preceding year. The operating expenses, which aggregated \$7,737,251, were larger by \$1,062,214, leaving a favorable balance of \$4,971,624. The proportion of operating expenses to gross earnings was 61.25. The total number of passengers carried was 273,999,404, a gain of 36,344,330 over 1906.

A special effort was made to ascertain the total amount of capital invested in the construction and equipment of electric railways in Canada, but the difficulties were for the time being insurmountable. The returns received showed a total cost of roads and rolling stock amounting to \$52,299,818, but it was not practicable to obtain reliable figures with respect to the primary outlay on seven systems which were either in process of construction or had been purchased at forced sale.

The officers and employes of the Canadian electric roads are classified as follows: Staff officers, 190; clerks, 483; conductors, 2,294; motormen, 2,252; other employes, 3,712; total employes, 9,031; total pay list, \$5,291,585. It will be seen that the total pay list represents 68.26 of the total operating expenses.

With respect to equipment it was ascertained that 207

cars were added during the year, of which 162 were of Canadian manufacture.

Mileage has increased since 1902 by 46.0 per cent. Within six years other important increases by percentages are: Paid-up capital, 88.2; gross earnings, 118.9; net earnings, 113.0; operating expenses, 125.2; passengers carried, 126.5; and tons of freight carried, 66.3. While the volume of freight traffic is not relatively large, it nevertheless indicates the possibilities in that regard. There has been a small decline during the past two years, but on lines equipped for that class of transportation, and following an enterprising policy, the growth has been satisfactory.

The record of accidents shows that 71 persons were killed and 1,736 injured. Out of 71 fatal accidents, 22 took place in Montreal and 20 in Toronto. Singularly, however, not a single passenger was killed in Montreal, while nine lost their lives in Toronto. Of the 1,736 non-fatal accidents, many of which were of a minor character, 400 occurred in Montreal and 696 in Toronto.

#### REPORT OF THE NEW YORK PUBLIC SERVICE COMMISSION, FIRST DISTRICT.

The New York public service commission, first district, transmitted on January 20 its report to the New York legislature for the six months ending December 31, 1907. An abstract of the report follows:

##### Subways.

Upon entering office the commission found the Manhattan-Bronx subway almost completed. The Manhattan-Brooklyn subway had also been completed as far as the Battery and was being operated. Work was progressing upon an extension from Two Hundred and Thirtieth street to Van Cortlandt park, which will cost about \$700,000 when finished. A ventilating system was being installed in the subway, at an expense of \$500,000. Actual work was just beginning on the Brooklyn subway loop. The tunnel portion of the Manhattan-Brooklyn subway, extending from the Battery to Borough hall, Brooklyn, was nearing completion. The rapid transit board had authorized the drawing of a contract for certain changes in the subway at Ninety-sixth street whereby grade crossings would be eliminated. The commission secured the approval of the corporation counsel and the board of estimate and apportionment, which set aside \$850,000 for the work. The requisite number of consents of property owners has nearly been secured.

After full discussion of the advisability of the so-called Fourth avenue subway in Brooklyn the commission determined that the plans should be continued. The commission changed the plans so as to eliminate certain heavy grades, and also to increase the headroom in the subway from 13½ to 14½ feet. This latter change will make it possible to operate steel cars used by suburban lines through the tunnel, and if found desirable, to run it in connection with suburban roads, and thus bring suburbanites from Long Island into the heart of Manhattan. The alterations are a decided improvement and it is expected that the commission will be ready to invite bidders toward the close of January.

As planned the subway loop, which is to connect the three bridges on the Manhattan side, contained a number of grades ranging from 4 to 5.5 per cent. In some instances they were so related as to increase the risk of collision unless the trains should be run at considerable distances apart. The headroom was not sufficient to permit cars used in the suburban service upon electrified steam roads to be operated through the loop. A revised scheme had nearly been perfected at the close of the year whereby the steep grades would be eliminated in all but one instance, the headroom increased so as to allow for every possible use of the subway in the future, and a rearrangement of the tracks would increase the facility of operation. These changes would increase the safety of operation and the carrying capacity of the loop, for 25 per cent more trains could be run through it in a given time. The cost of operation would be reduced materially, and less expensive equipment could be used.

The commission has directed that plans be prepared for a subway from the Manhattan bridge through Canal street to West street, there connecting with the ferries. The estimated cost of this Canal street line complete is \$7,000,000.

This commission has determined upon a new rapid transit route in Manhattan and the Bronx. The estimated cost of this line, including two branches in the Bronx, is \$60,000,000.

##### Rapid Transit Law.

Bonds issued for subway construction are reckoned as part of the debt of the city, although the bonds so far issued

are entirely for a self-supporting undertaking; that is, the contractor has undertaken and given security to pay the interest and a per cent each year toward a sinking fund to retire the bonds. The taxpayers will not be called upon to pay a dollar, either as interest upon these bonds, or to secure their retirement upon maturity. Because of the financial condition of the city, and the present limitation upon the power of the commission to secure the use of private capital in the construction of rapid transit routes within New York City, the commission makes the following recommendations as to legislation:

(1) A constitutional amendment exempting from the 10 per cent debt limit bonds for the construction of rapid transit lines, when, so far and so long as such rapid transit lines shall be self-supporting.

(2) An amendment to the rapid transit law providing that leases of extensions of rapid transit lines may terminate at the same time as the original lease, this commission having the power, in conjunction with the board of estimate and apportionment, to fix terms, conditions and compensation and to readjust the same each 20 or 25 years thereafter.

(3) An amendment to the rapid transit law which shall give the local authorities and this commission the power to allow the construction and operation of rapid transit lines by private companies upon the payment of part of the earnings to the city or other proper terms, and with a reservation to the city of the privilege to purchase at any time after a certain period of not more than 20 or 25 years and without any payment for the franchise itself; and

(4) An amendment to the rapid transit law making it possible for the local authorities and this commission to let contracts for operation for a longer period than 20 years, or else to make the lease terminable at any time after a certain period of not more than 20 years, with a provision that the equipment shall be purchased at a fair price by the city upon the termination of the lease.

#### Financial and Traffic Statistics.

The assets of the street surface, elevated and subway railroads under the jurisdiction of the commission as of June 30, 1907, were \$624,076,226.15. The total liabilities were \$617,676,278.18; excess of assets, \$6,399,947.97. The earnings from operation of these companies in the year ended June 30, 1907, were: From passenger transportation, \$65,568,031.89; from freight transportation, \$290,515.04; from express transportation, \$132,559.10; from mail transportation, \$60,227.01; from miscellaneous sources, \$42,443.25; gross earnings, \$66,093,776.29.

The operating expenses were: Maintenance of way and structures, \$4,303,898.20; maintenance of equipment, \$5,625,603.02; maintenance of power plant, \$6,107,673.39; operation of cars, \$15,830,593.89; general expense, \$6,145,293.99; total operating expense, \$37,013,062.49; net earnings from operation, \$29,080,713.80; income from other sources, \$2,757,281.60; net income, \$31,837,995.40.

For the year ending June 30, 1906, the total number of passengers carried by all the railroads of the state was 1,630,775,156, of which 1,535,017,181 were carried by the street surface, elevated and underground railroads. Of this number, 1,249,829,568 were carried by the railroads now operating under the jurisdiction of this commission. From the reports for the year ending June 30, 1907, it appears that the increase in passengers on these roads within the first district over the preceding year is 73,338,898, making a total of 1,323,273,368, a daily average of upward of 3,560,000. A large proportion of this traffic—conservatively estimated at 60 per cent, or something more than 2,000,000—travels within the limits of four hours, 7:30 to 9:30 in the morning and 5 to 7 at night. When this commission came into office these corporations were thus carrying 500,000 passengers an hour—more than 10 per cent of the entire population of the city—during some portions of the day, yet the service given was greatly below that required for a decent handling of the traffic.

#### Improvements in Present Rapid Transit Facilities.

All told, 179 hearings were held between July 18 and December 31, 1907. As a result of these hearings the commission has issued 186 orders. Of these 84 were complaint orders, i. e., orders transmitting a complaint with notice to satisfy or reply within 10 days; 46 were orders for hearings; 42 were final orders; and 14 were general orders calling for information.

#### General Investigation of Transit Lines.

The investigation of the Interborough-Metropolitan Company, the Brooklyn Rapid Transit Company and their subsidiary and controlled companies had not been completed at the end of the year.

Upon the evidence and subsequent observations, the commission ordered changes in the service rendered in the sub-

way and on the elevated roads of Manhattan that called for increase in facilities of between 20 and 25 per cent. Later it appeared that the service as rendered in obedience to this order was not sufficient, and other observations were taken which were made the basis for further orders.

So far as the surface lines of Manhattan are concerned, the commission has required increases in service on Broadway, on Madison and Fourth avenues, and on Eighth avenue. In addition the commission had a careful examination made of 1,600 cars belonging to the New York City Railway. Upon the results of this examination a final order has been issued requiring that all cars be overhauled and put in condition, at the rate of 10 cars a day after February 15, 1908. The financial condition of the New York City Railway Company, which resulted in the appointment of receivers by the federal court, has retarded to some extent the plans of the commission for improvement of surface transportation in Manhattan, but the commission has issued orders upon the receivers and expects them to be obeyed.

The congestion on the Brooklyn bridge has received constant attention. The bridge structure, including the Manhattan terminal, is under the complete charge of the bridge department of the city. The result, therefore, has been that this commission has not found it possible to require or even recommend radical changes as to bridge operation. Reports show that the cars of the Coney Island & Brooklyn Railroad, although numbering one-ninth of the total surface cars operating over the bridge, were producing over one-half of the breakdowns. Orders have been issued accordingly, requiring this company to overhaul its cars and place them in first-class condition. The statistics taken on October 17, 1907, show that 426,364 persons crossed the bridge, requiring 15,263 elevated and surface cars to transport them, and that in the heaviest hour of travel 54,726 persons crossed the bridge in one direction.

A conservative estimate of the increases required of all the operating companies indicates that over 15,000,000 additional seats per annum have been added to the service in this city under orders of the commission.

#### Accidents.

The total number of accidents reported by transportation companies for the six months was 24,209. The total number of deaths occurring in connection with such accidents was 288. This is appalling! The commission believes that no more important work could be undertaken than the reduction of this death list; and a departmental committee, consisting of the electrical engineer, chief of the division of transit inspection and the chief clerk of accidents, has been directed to make a thorough investigation to ascertain whether it will be possible to adopt any method that will result in fewer persons being killed. Judicial processes in the nature of criminal prosecutions and civil suits for damages, partially because of the length of court calendars and the skill of counsel employed by the companies, have not been adequate; and regulative requirements by public officials are all the more necessary.

#### Franchises and Capital Issues.

All companies have been required to file documents showing their franchise histories, and the compilation of the data as thus obtained is expected to be of the utmost value in determining the duties as well as the rights of the companies. Preparatory to the preparation of uniform forms of accounts, the companies have filed data showing the present method of keeping their accounts, and so far as steam railroads are concerned the form of accounts has been prescribed by the commission in conformity with the form of the interstate commerce commission and the public service commission for the second district.

No applications have been received for the approval of additional issues of stock. Three applications have been considered for approval of bonds, but no determination was reached before the end of the year.

The commission deemed it necessary to require sworn statements as of July 1, 1907, showing the amount of stock held in other companies. No applications have been made for approval of the transfer of franchises.

The new car shops of the Indiana Union Traction Company at Anderson, Ind., of which a complete description with illustrations was published in the Electric Railway Review of January 18, page 67, were formally opened on January 15. Members of the Anderson Commercial Club and prominent city and county officials were taken to the shops in a special car as the guests of President Brady and General Manager Nicholl of the company. Upon entering the shops the members of the party had the novel experience of having the car in which they were seated picked up by a large traveling crane and carried from one end of the building to the other.

### ANNUAL MEETING OF THE CENTRAL ELECTRIC RAILWAY ASSOCIATION.

H. A. Nicholl, president of the Central Electric Railway Association, called the annual meeting to order at 10:30 o'clock on Thursday morning of the present week at the Phillips House, Dayton, O. Mr. Nicholl read the annual address of the president, which appears elsewhere.

A standing vote of thanks was given to the Indianapolis Traction & Terminal Company for giving the Central Electric Railway Association the free use of an office for headquarters. The report of W. F. Milholland, secretary and treasurer, was read and approved.

Charles F. Price, general passenger agent Western Ohio Railway, then read his address on the "Promotion of Traffic," which will be found in another part of this issue. This address contained many interesting views on advertising problems, which were quite freely discussed by the various traffic officials present.

F. W. Brown (Michigan United Railways) said that he had had successful results from the use of unique advertising cards that merchants would willingly display in their windows.

Mr. Price thought that the payment of cash for newspaper advertising assured better space and better results than if transportation had been given.

E. C. Van Valkenburgh said that where a definite scheme of advertising was followed out it was seldom, if ever, that satisfactory results were not obtained. Advertising had failed where it was not suited to the territory or to the character of the traffic. He thought magazine advertising would greatly help a large system. If timetables of interurban roads were buried in newspapers as steam railway timetables are, the advertisements would not be of any particular value, but the time of trains could be presented in small space and do interurban roads good. He believed in a picture that would attract the eye, and thought that trademarks which could be shown every day were of great value.

W. P. Cospser (Lord Electric Company) suggested that interurban roads place better information concerning movements of trains with hotel clerks and in hotels.

F. A. Burkhardt (Ohio Electric Railway) showed a small 8-page timetable which contained information desirable for travelers. The booklet cost \$2.50 per thousand.

#### Afternoon Session—Telegraph Signal.

At the opening of the afternoon session, Chauncey P. Burton, general manager Telegraph Signal Company, Rochester, N. Y., read a paper entitled "The Telegraph Signal System." (To be found elsewhere.)

After a detailed description and illustration of the signal by the aid of a working installation of two semaphores, H. A.

Nicholl (Indiana Union Traction Company) opened the discussion. He related how his company had installed the telegraph signal system on one division 54 miles long and had ordered additional equipment for the Muncie-Indianapolis division, 57 miles long.

G. A. Kelsay, superintendent of power Indiana Union Traction Company, under whose jurisdiction the installation mentioned by Mr. Nicholl had been placed, outlined its many desirable qualities. He emphasized the valuable feature of repeating to the dispatcher a record that the semaphore blade had fallen to "Danger" and that that record in permanent form showed the number of the particular blade which had fallen. The dispatcher on the Union Traction lines had found the signals to be of great assistance in advancing trains.

Mr. Kelsay then described the method of lighting the semaphore targets. The semaphores are installed at double-ended sidings, on the opposite side of the track from the switchstands. Each semaphore is lighted by two 300-volt incandescent lamps connected with a feeding circuit controlled from a nearby substation. There are installed 14 semaphores so lighted and 12 which are lighted with long-burning oil lamps. The two incandescent lamps on the semaphore post are not on one circuit. One of the lamps is wired in series with a switch light at one end of the siding and the second semaphore light is connected in series with the lamp on the switchstand at the other end of the turnout. In this way it is hardly possible to have both semaphore lights out at one time, because, should there be a failure on one circuit, that failure will be indicated by there being no light at one of the switchstands, and will immediately be noted by a train crew. On tangent track in clear weather the lights behind the semaphore glass could be seen clearly for four miles.

Mr. Kelsay had in mind an improvement of the semaphore lighting which comprised the use of two glasses in front of the lamps—one of red to indicate danger, and one of green to indicate clear. Should either glass be broken a white light would show. This could be considered as a danger indication.

While the signals on the Union Traction line had been connected to take their source of current through the dispatcher's office from a trolley circuit, Mr. Kelsay thought that on the score of reliability it would be more advisable to have an independent source of current supply, say from a storage battery equipment already installed nearby. Then, in event of a trolley circuit-breaker opening, there would be no interruption on the signal system.

#### Brake Rigging.

R. C. Taylor, superintendent of motive power Indiana Union Traction Company, chairman of the "Standardization" committee, presented a report on "Fundamental Brake Rig-



F. D. Carpenter, President-Elect.



ging for High-Speed Electric Railway Cars." This report, which is to be found elsewhere, was discussed and accepted as presented with the instruction of the association that the committee confer on the same subject with the "Standardization" committee of the American Street and Interurban Railway Association.

In discussing brake rigging, Carl Peterson (Baldwin Locomotive Works) said that the truck manufacturers would gladly welcome the assistance of the operating men in the common desire to improve existing types of trucks.

S. D. Hutchins (Westinghouse Traction Brake Company) emphasized how desirable it was for the purchasers of cars to supply the air brake manufacturers with accurate weights of those cars if they expected the best braking results. The tendency was to require shorter stops and this the brake manufacturers were endeavoring to meet. Pressures as high as 95 pounds could be used in the brake cylinder when cars were running at 60 miles per hour. As outlined by Mr. Taylor, with such pressures, mechanical means must be provided to

been made on the Chicago Burlington & Quincy Railroad.

F. D. Norvell, chairman of the "Traffic Organization" committee, told of the formation of the new traffic association. In addition to the announcement, which is given elsewhere in this issue, of the formation of the association, Mr. Norvell spoke of the committees which will be formed and of the vice-chairmen who may be appointed in different districts.

#### Officers.

The following officers were elected for the year 1908: President, F. D. Carpenter, general manager Western Ohio Railway, Lima, O.; first vice-president, A. A. Anderson, general manager Indianapolis Columbus & Southern Traction Company, Columbus, Ind.; second vice-president, F. J. J. Sloat, district manager Cincinnati Northern Traction Company, Cincinnati, O.; treasurer, W. F. Mitholland, Indianapolis, Ind.; executive committee (members from Indiana), H. A. Nicholl, general manager Indiana Union Traction Company, Anderson; C. D. Emmons, general manager Ft. Wayne & Wabash Valley



Central Electric Railway Association—Group of Members and Guests at Dayton Meeting.

reduce the brake pressure as the co-efficient of friction increased; with steam railroad brakes the pressure was reduced as the speed decreased. Probably the brake which came nearest to meeting the desired requirements was the magnetic traction brake, which provided that when the wheels skidded the braking power was lessened until the wheels revolved again and the brakes likewise set.

Ordinarily with a 4-motor car the braking force was designed to be applied at 100 per cent of the light weight on all axles. If there were idle axles they would be braked at 90 per cent of their load. The higher braking power applied to axles carrying motors than to idle axles was necessary for absorbing the momentum of the rapidly revolving armature. The ideal braking equipment of the automatic type for a high-speed interurban car carried 50 pounds air pressure in the cylinder, and the leverage was designed on this basis. For emergency stops 60 pounds pressure could be admitted to the cylinder and thus a 20 per cent greater braking power be obtained. This was then braking the car to 120 per cent of its light load.

W. T. Van Dorn described some brake tests which had

Traction Company, Ft. Wayne; Charles G. Lohman, superintendent Chicago South Bend & Northern Indiana Railway, South Bend; H. S. Dickey, general superintendent Winona Interurban Railway, Warsaw; T. F. Grover, general manager Terre Haute division Terre Haute Indianapolis & Eastern Traction Company, Terre Haute; executive committee (members from Ohio), C. N. Wilcoxon, general manager Cleveland Southwestern & Columbus Railway, Cleveland; E. C. Spring, manager Dayton Covington & Piqua Traction Company, West Milton; F. W. Coen, general manager Lake Shore Electric Railway, Cleveland; George Whysall, general manager Columbus Delaware & Marion Railway, Marion, O.; Irwin Fullerton, auditor Detroit Union Railway, Detroit, Mich.

In accepting the office of president, Mr. Carpenter made a strong argument for standardization of equipment and operating methods.

The annual banquet was held at the Phillips House on the evening of the last day's session, Thursday, January 23. This was an especially pleasant affair, the arrangements for which had been under the charge of the following committee: John F. Ohmer, E. C. Spring, F. J. J. Sloat and T. A. Ferned-

ing. Mr. Spring acted as toastmaster. The association was welcomed to Dayton by Mayor Edward C. Brnkhart. The evening programme included addresses by H. A. Nicholl, F. D. Carpenter, B. V. Swenson, J. Sprague McMahon, Judge Dennis Dwyer, E. B. Grimes, Dr. D. Riley and Edward Hanley. Elsewhere in this issue will be found abstracts of the addresses by Messrs. Grimes and Dwyer. The attendance at the banquet and meetings was 130.

#### ORGANIZATION OF CENTRAL ELECTRIC TRAFFIC ASSOCIATION.

The Central Electric Traffic Association was organized at meetings held at the Phillips house, Dayton, O., on January 22 and 23. This association will be allied with the Central Electric Railway Association, which held its annual meeting at the same place on January 23.

After articles of association had been drafted and accepted the most serious business which remained was the selection of a permanent chairman. It was finally decided that the permanent chairman should be a salaried official, expert in matters relating to freight and passenger tariffs. After a conference with representatives of the Central Electric Railway Association it was decided to select one man to fill the offices of chairman of the Central Electric Traffic Association and secretary and treasurer of the Central Electric Railway Association.

The meeting of traffic officials was called to order at 11 a. m. on Wednesday, January 22, by F. D. Norvell, general passenger and freight agent Indiana Union Traction Company. John H. Crall, general passenger and freight agent Terre Haute Indianapolis & Eastern Traction Company, was elected temporary chairman and R. A. Crume, auditor and purchasing agent Dayton & Troy Electric Railway, temporary secretary. An adjournment was then taken until 2:30 o'clock in order to give the committee appointed at the preliminary meeting in Indianapolis an opportunity to consider articles of association. In the afternoon this committee, of which W. S. Whitney, general passenger and freight agent Ohio Electric Railway and Cincinnati Northern Traction Company, was chairman, reported articles of association. These articles are similar to those adopted by the Central Passenger Association and the Central Freight Association, the steam railway organizations.

#### Purposes of the Association.

As adopted the articles state that the objects of the organization are:

The purposes of this organization are to promptly secure to each of the parties authentic information in relation to the tariffs, rate sheets and ticket regulations of the respective parties, and changes therein, and the due filing and publication thereof; to aid in securing compliance with the federal and state laws relating to and regulating commerce; and to enable the parties hereto to mutually confer, advise and act in relation to the subjects above stated, and the proper methods to secure the purposes aforesaid.

An abstract of the principal other features follows:

The Central Electric Traffic Association is to comprise roads located within the area bounded as follows: Illinois, Indiana, Ohio, southern peninsula of Michigan, thence on the line from Buffalo to Pittsburg, south through Wheeling, W. Va., southern bank of Ohio river to Ashland, Ky., direct to Richmond, Nicholasville, Versailles, Frankfort, Shelbyville, Louisville and southern bank of Ohio river through Paducah, Ky., to East Cairo, Ill. Connecting railway and transportation companies not in this territory may become members by a majority vote of members of the association.

The members agree to submit questions of common interest upon which action is desired to the association, to be considered promptly under its rules; and to arbitrate all differences upon questions coming within the scope of this agreement which are not otherwise properly reconciled. Each member agrees that it will send to the chairman copies of each local and joint state and interstate tariff of rates and of charges therein, also classification and rules at the time of making, issuing or filing the same with the interstate commerce commission; also of all agreements or arrangements

with other common carriers in relation to the rates coming in whole or in part under this agreement.

The association shall meet on the Wednesday before the fourth Thursday of January, March, May, September and November, or at other times upon five days' notice at the request of five members of the association or of the chairman.

Nothing shall be so construed as to confer on the majority the power to make rates for any member, but as regards the fixing, maintenance and changing of rates and the relations of the members as common carriers to the public, each member reserves to itself the right at all times to take separate and independent action.

#### Provision for Arbitration.

The executive officer of the association shall be a chairman. The chairman shall construe this agreement and all resolutions adopted thereunder. His decisions shall be subject to appeal to the association or to arbitration, but shall be conformed to until such appeals are decided. He may suspend the interim action of committees which he finds to be in conflict with these articles or rules connected therewith, or he may reconvene them to reconsider their action.

In case of disagreement on any subject on which any of the committees are authorized to act, and upon which prompt action is required, the question at issue shall be submitted to the chairman for decision. In case the subject is one which, in the judgment of the chairman, does not require immediate decision, or which requires further investigation and consideration, it shall be further considered at a meeting of the association, to be called by the association at the earliest practicable day after the necessary information has been obtained. If no agreement can then be reached, the question shall be decided by arbitration. If any member of this association objects to the decision of the chairman the case shall at once be reported to the association for its action.

If any case is submitted to arbitration, it shall go to the decision of one or three arbitrators, experienced in traffic matters, as may be decided by the parties at issue in each instance. The decision of a majority of said three shall be final. If either or both parties to an issue fail to appoint their arbitrators within 10 days after appeal to arbitration, the chairman may designate the arbitrators for the delinquent party or parties, and the two so chosen shall select a third. The chairman shall in no case act as an arbitrator. The expenses of arbitration shall be shared equally by the parties to the submission, unless otherwise agreed.

A "Standard Auditing" committee, to consist of accounting officers of three companies, shall be appointed annually, said committee to have charge of the accounting of this association and conduct the periodical examination of its accounts.

This organization shall continue for one year and thereafter until dissolved by majority vote; but any member of the association may withdraw therefrom after said year by giving 30 days' notice.

#### Co-operation of Two Associations.

When the foregoing articles had been reviewed the following committee was appointed to take up with a committee of the Central Electric Railway Association some of the questions concerning the relations of the two organizations: A. G. Kelly, auditor and general passenger and freight agent Ft. Wayne & Springfield Railway, chairman; Charles G. Lohman, general superintendent Chicago South Bend & Northern Indiana Traction Company; W. S. Whitney, F. D. Norvell and Charles F. Price, general passenger agent Western Ohio Railway. The meeting was then adjourned until January 23.

The foregoing committee met the following committee, appointed by H. A. Nicholl, president Central Electric Railway Association: F. J. J. Sloat, district manager Cincinnati Northern Traction Company; C. N. Wilcox, general manager Cleveland Southwestern & Columbus Railway; F. D. Carpenter, general manager Western Ohio Railway; R. T. Gunn, superintendent of transportation Ft. Wayne & Wabash Valley Traction Company; and J. F. Starkey, division passenger and freight agent Indiana Union Traction Company.

The meeting was called to order at 10 a. m. on January 23 and the committee reported that it had been unanimously decided that the two associations should act together, and that the election of a secretary and treasurer for the Central Electric Railway Association would be postponed until a suitable man to fill that office and the chairmanship of the traffic association is secured. Members were requested to endeavor

to locate a desirable man for the position. Applications are to be addressed to the president of the Central Electric Railway Association, who will refer them to the traffic association, the members of which will confer with the executive committee of the railway association. The traffic association will have the dominating influence in the choice of this man inasmuch as its interest in the matter is vital. The report of the committee was adopted. To further the selection of a chairman the following committee was appointed: W. S. Whitney, Charles G. Lohman and Charles F. Price. The articles of association will be published and mailed to all members and any others that might join on presentation of the advantages to be derived from membership.

The meeting then adjourned to meet on March 25.

#### Those Who Attended.

The following attended the meeting of traffic officials:

Indianapolis & Cincinnati Traction Company—George S. Henry, traffic manager.

Pt. Wayne & Springfield Railway Company—W. H. Flederjohann, president; and A. G. Kelly, auditor and general passenger and freight agent. Representing also Marion Bluffton & Eastern Traction Company.

Indianapolis & Louisville Traction Company and Indianapolis Columbus & Southern Traction Company—R. J. Thompson, assistant secretary and treasurer.

Chicago South Bend & Northern Indiana Traction Company—C. G. Lohman, general superintendent; and C. H. Walter, traffic agent.

Ohio Electric Railway Company and Cincinnati Northern Traction Company—W. S. Whitney, general passenger and freight agent.

Pt. Wayne & Wabash Valley Traction Company—R. T. Gunn, superintendent of transportation; and H. E. Vorde-mark, auditor.

Cleveland Painesville & Eastern Railroad and Cleveland Painesville & Ashtabula Railroad—R. S. Schmock, general passenger agent.

Terre Haute Indianapolis & Eastern Traction Company—C. S. Kitch, district passenger and freight agent; and J. H. Crall, general passenger and freight agent.

Dayton & Troy Electric Railway—H. P. Clegg, president; R. A. Crume, auditor and purchasing agent; O. H. Merlin, general passenger agent; L. J. Johnson, general freight agent; and C. M. Paxton, general manager.

Louisville & Southern Indiana Traction Company and Louisville & Northern Railway & Lighting Company—F. E. Cole, superintendent.

Springfield Troy & Piqua Railway—J. M. Brick, general passenger agent.

Indiana Union Traction Company—J. F. Starkey, division passenger and freight agent; and F. D. Norvell, general passenger and freight agent.

Michigan United Railways—F. W. Brown, general passenger and freight agent.

Western Ohio Railway Company—F. D. Carpenter, general manager; Charles F. Price, general passenger agent; and C. C. Collins, general freight agent.

Dayton Covington & Piqua Traction Company—M. M. Smith, local auditor; and John J. White, general freight agent. Toledo Urban & Interurban Railway—C. J. Laney, assistant general freight agent.

Dayton & Xenia Transit Company—R. J. Wells, general passenger and freight agent and auditor.

Kokomo Marion & Western.  
Muncie & Portland.

#### Improvements of the Seattle Electric Company.

During the year 1907 the Seattle Electric Company, Seattle, Wash., increased its single-track mileage from 102.29 to 141.66. The car equipment was increased by 63 double-truck single-end motor cars and 14 double-truck trail cars, built by the St. Louis Car Company, and by 8 cable cars, two box cars and 8 flat cars, built in the company's shops. New shops and a power house were also erected at Georgetown. These were described in the Electric Railway Review for June 22, 1907, page 806, and for June 29, 1907, page 845. Generating equipment of 11,000 kilowatts capacity is now on order and will be installed during the year. A large amount of new track construction is also proposed.

It is reported that all records for subway traffic in New York were broken on Monday, January 20, when 704,879 passengers were carried 910,215 passenger-miles.

#### CHANGES IN THE WASHINGTON RAILWAY & ELECTRIC COMPANY.

The contest for control of the Washington (D. C.) Railway & Electric Company was settled by the election of new directors representing Washington interests at the annual meeting of the stockholders on January 18. William Loeb, Jr., secretary to President Roosevelt, was elected a director with the understanding that he may be made president later. Allan L. McDermott of Jersey City, N. J., accepted re-election at the request of the board of directors with the understanding that he will resign when the directors decide on the best man for permanent president. The directors elected were as follows: Woodbury Blair, Allan L. McDermott, Clarence F. Norment, George H. Harries, William Loeb, Jr., George Truesdell, Ward Thoron. Messrs. Norment, Thoron, Blair and Truesdell will constitute the executive committee. The board organized by electing the following officers:

President—Allan L. McDermott.

First Vice-President—Clarence F. Norment.

Second Vice-President and General Manager—George H. Harries.

Comptroller and Treasurer—W. F. Ham.

Secretary—F. J. Whitehead.

More than 118,000 shares of stock out of about 150,000 outstanding were voted. The proxy committee, representing the Washington interests, voted nearly 100,000 shares. The former directors who were not re-elected were James B. Lackey of Washington, John C. Dorson of Philadelphia, R. T. W. Duke, Jr., of Charlottesville, N. Y., and George W. Young of New York.

#### BUREAU OF INSPECTION INDIANA RAILROAD COMMISSION.

The second annual report of the railroad commission of Indiana includes a report to the commission by Alexander Shane, chief inspector of the bureau of inspection, which was established June 1. That part of the report dealing with electric railways states that 499.35 miles of electric lines have been inspected, on which eight defects on bridges were found, 50 defects on signals and 25 defects on roadway and track. There are yet 1,039.55 miles of electric line to be inspected.

While making inspection of electric lines quite a number of test stops were made to determine the efficiency of the braking power and the minimum distance in which cars could be stopped. It was found that more satisfactory results could be obtained on cars equipped with straight air and that the application of sand very materially assisted in making a stop on a dry rail and especially so on a bad one. It was found also that the sanding arrangement on these cars was not at all satisfactory. If the sand box is located on the body of the car and the sand pipes lead from the car to the rail they do not sand the track on a curve. To overcome this a rubber hose is sometimes used to lead from the sandbox to the pipes which are fastened to the truck. Pneumatic sanders are generally used, and it was found that when the air was put on full force it would not deliver sand but would blow through, and was not at all satisfactory. It is the opinion of the inspector that these defects can be overcome, however.

The report states that the railroad and traction officials have co-operated with the inspectors and have afforded them every facility for making these inspections with a view to making travel safer.

The Indiana appellate court, in affirming a judgment against the Louisville & Southern Indiana Traction Company for running over a 6-year-old child in a street of New Albany, took occasion to suggest that the company use more cars and less speed in congested districts. The court said that parents are not necessarily negligent in failing to anticipate the negligent operation of a car at a high rate of speed in connection with the attempt of a child to cross the track.

### GENERAL ELECTRIC GAS-ELECTRIC CAR FOR RAILWAY SERVICE.

On February 3, 1906, occurred the first trial run of a gasoline-electric car built for the Delaware & Hudson Company by the General Electric Company and the American Locomotive Works. This car was described and illustrated in the Street Railway Review for February 15, 1906, page 79. The car was 65 feet long, seated 40 passengers and weighed complete 65 tons.

The General Electric Company has just designed and built complete except for the car body and trucks another gas-electric equipment, which is described and illustrated herewith. By way of contrast with its prototype the latest car, having about the same service characteristics, is 50 feet long, seats 44 passengers and weighs fully equipped but 31.4 tons.

#### Car Body.

The car body is of the combination type, and comprises one ordinary passenger compartment, a smoking room, a baggage room, an engine room, a toilet and an observation compartment. The car is single ended, with the controlling apparatus situated in the engine room.

The principal dimensions are as follows: Length over all, 50 feet; length of engine room, 9 feet 6 inches; length of

ranged so that the bottom one folds up automatically as the vestibule door is closed.

The car body was built by the Wason Manufacturing Company, Springfield, Mass., in accordance with the designs of the General Electric Company.

#### General Scheme of Operation.

The gasoline engine is direct coupled to a 90-kilowatt direct-current generator, which furnishes current at a variable potential. This current is fed to the motors through the medium of the control system, by which the voltage of the generator may be governed according to the requirements. The two motors are of the GE-72-A type, each rated at 60 horsepower.

#### Engine.

The engine was designed and built by the General Electric Company, with special reference to the requirements peculiar to gasoline-electric cars, special attention being given to simplicity and the reduction of the number of parts and the weight to a minimum.

When running at 550 revolutions per minute the engine develops 100 horsepower and has a greater capacity at increased speeds. There are eight cylinders, each of which is 8 inches in diameter and has a stroke of 7 inches. The cylinders are placed at 90 degrees to one another and at an angle

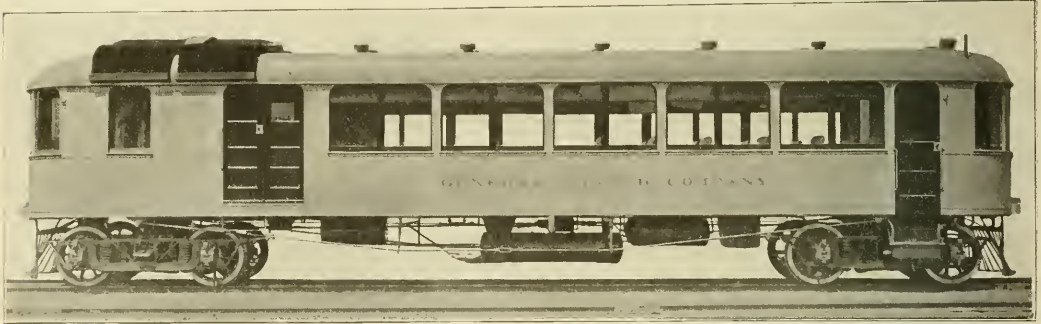

General Electric Gas-Electric Car for Railway Service.

baggage room, 5 feet 8 inches; length of smoker, 7 feet 11 inches; length of passenger compartment, 18 feet 6 inches; width over all, 8 feet 8 inches; height over all, 12 feet 10½ inches; seating capacity, 44; total weight of car and trucks fully equipped, 31 tons.

This car was designed throughout with special reference to the service required, the main object in view being to secure the maximum carrying capacity, with a minimum weight, and at the same time to have a car of great strength. The shape of the ends is semi-circular in order to reduce the air resistance to a minimum when traveling at high speed. The frame for the roof and sides is of T-sections bent to the required shape and braced diagonally. The exterior of the car is of steel plate, while the interior is finished with selected Mexican mahogany. No wood is used in the engine compartment. The floors of the passenger and baggage compartments are of two layers of wood with paper between, armored on the under side with steel plates. The roof, which is fireproof, is of a plain oval shape; the monitor construction was not used because it would have added needlessly to the weight. Special attention has been paid to ventilation, 12 ventilators of the globe suction pattern being furnished in the roof. The center sills consist of 6-inch I-beams, and the outside sills are 6-inch channels, and these are braced diagonally.

The seats are upholstered in green leather. The interior is lighted with individual lamps, there being one light for each seat. A headlight is also provided. The steps are ar-

of 45 degrees with the vertical. Each cylinder is composed of one piece, a casting of soft fine grain cast iron. There is one admission and one exhaust valve for each cylinder, which are arranged in such a manner as to permit the inspection of both valves by the removal of two nuts. The pistons are of the trunk type; they are made of cast iron and are rendered gas tight in the cylinders by the provision of three split piston rings. The connecting rods, which are made of chrome nickel steel, are connected to the pistons by means of hollow pins shrunk into the body of the connecting rods. The crankshaft is made in one forging of 0.40 carbon steel; it is a 4-throw crank having an angle of 180 degrees. All of the crank pins lie in the same plane, the two center pins occupying the same angular position, while the two outside crankpins are set at 180 degrees to the center crankpins. This arrangement of cranks with cylinders set at 90 degrees to one another gives a very satisfactory system for balancing purposes. Two connecting rods are coupled to each crankpin.

Each cylinder is fastened to the engine base by six bolts. The engine base proper is made of one casting of Parsons manganese bronze. The crank casing, which is made oil tight, is of aluminum.

All of the valves, both admission and exhaust, are actuated by one cam shaft, which is driven from the main engine shaft by two gear wheels with 2 to 1 reduction, which greatly simplifies the design of the engine. This cam shaft is entirely inclosed in a circular tunnel, which runs the

entire length of the engine base, the tunnel being formed in the main casting.

There are two carburetors of the float feed type. The ignition system is of the high-tension type, a separate coil being provided for each cylinder. The coils are energized by means of a small accumulator. Sparking at the proper instant in each cylinder is secured by means of a roller commutator.

For starting a special breech block mechanism has been provided, which fires a charge of black powder into one of the cylinders.

The cooling system for the cylinders operates on a thermo-siphon principle. The radiator, which is situated on

in transit from the tank to the pump. The gasoline is fed by gravity to the carburetor.

Forced lubrication is used and for this purpose there is a nest of pumps operated from the main shaft. All of the oil used for lubricating purposes similarly flows to the crank chamber, whence it can be drained. The big ends of the connecting rods are lubricated by scoops, which dip into the oil in the bottom of the crank chamber, the oil being forced to the crankpin as the crankshaft revolves.

#### Generator.

The generator is a General Electric 90-kilowatt 8-pole separately excited unit, specially designed with a view to pro-

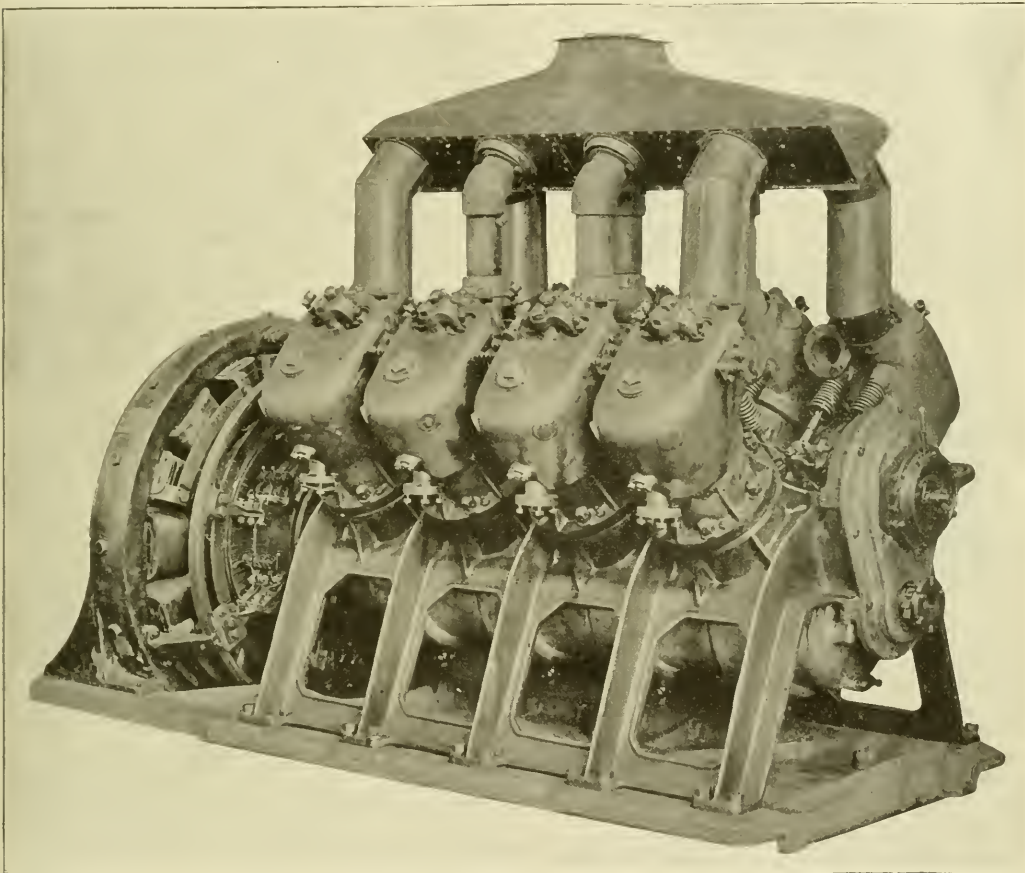

General Electric Gas-Electric Car for Railway Service—Engine and Generator.

the roof of the car, is divided into four separate nests of radiating tubes, which are of the spiral-finn pattern to give a maximum cooling area per unit length.

The total cooling surface is approximately 1,300 square feet. Each pair of engine cylinders is connected to one nest of tubes and the four nests are in turn connected by means of three copper pipes. The system is simple and eliminates the necessity of using pumps or cooling fans; also, it is easily drained and may be filled from the side of the car.

The gasoline is stored beneath the car in a steel tank having a capacity of 90 gallons, and is raised to a small auxiliary tank in the cab by a diaphragm pump, being filtered

curing the lightest possible machine for the necessary output, and at the same time keeping the temperature rise to within a reasonable figure. It is provided with commutating poles, which, in conjunction with the potential type of control, gives great flexibility of current output.

The normal pressure when running at 550 revolutions per minute is 250 volts, at which time the current will amount to 360 amperes, but at starting a current of 800 amperes can be secured at a corresponding decrease in voltage. It would be impossible to commutate so large a current in a machine with so great a capacity per pound without the use of commutating poles. The total weight of the generator, including exciter, is

2,740 pounds, while a standard machine of this output weighs 8,800 pounds. As is only natural in a machine where the weight has been so materially reduced, the temperature rise is higher and the efficiency lower than in standard apparatus of the same output. The higher temperatures are provided for by the type of insulation employed, no paper or muslin being used in the machine. The armature coils are insulated with mica, the interpolated pole coils with asbestos and the field coils are wound with enameled wire. The armature leads to the commutator are riveted as well as soldered, although the precaution has been taken to use pure tin for soldering, which has a melting point of over 200 degrees C. Air ducts are provided to insure a large volume of air being circulated through the core. The efficiency is 88 per cent, being only about 3 per cent lower than a standard machine having a temperature rise of 35 degrees C.

The exciter is a 3-kilowatt 70-volt shunt-wound machine, with its armature mounted directly on the armature shaft of the main generator and its field yoke supported by the bearing

which permits the lights being supplied directly from the exciting circuit or from the storage battery, according to the voltage of the exciter circuit. A Tirrill regulator is used for regulating the voltage on the lighting circuit. These arrangements enable the car lights being used when the engine is at rest.

The master controller, which has some unique features, is of type C-44, and gives seven steps with the two motors connected in series and eight steps with the two motors connected in parallel. It is provided with four handles, three of which are mounted one above the other on concentric shafts. The function of the top handle is to advance and retard the ignition of the engine, the second controls the throttle of the engine, while the third handle controls the generator field resistances and the contactors, which establish the circuit for the motors, besides transposing the motor connections from series to parallel. The fourth handle operates the reversing switch and controls the direction of rotation of the motors.

The car is heated by passing part of the exhaust gases through pipes suitably located in the car body.

A straight air brake equipment is provided and the air is supplied by means of a compressor, which is direct connected to the engine. The working pressure is 60 pounds per square inch and this is kept constant in the storage tank by a mechanical governor. Hand brakes are also provided.

The trucks were built by the American Locomotive Company. They are of the swing bolster type, and have wheels 36 inches in diameter. One motor is mounted on each truck. The journals are of the M. C. B. standard pattern.

The interior of the cars can, of course, be designed to suit the requirements or service, making this type available for use as private cars, with sleeping and dining accommodation, as inspection cars, wrecking cars, baggage cars, etc.

This car made a satisfactory test run of 78 miles over the tracks of the Delaware & Hudson Company on January 15, 1908, carrying a party of officials of the General Electric Company, American Locomotive Company, Delaware & Hudson Company and several electric railways.

On the test run the car carried its full capacity of passengers. Twenty-three stops were made, the average length of a stop being slightly less than one minute. The engine, however, ran continuously during the trip. The speed of the car varied from 23 miles per hour on a + 1.3 per cent grade, to 56 miles per hour on a - 0.25 per cent grade. Where traffic conditions permitted a speed of 50 miles per hour was recorded on level track and from Albany to Mechanicsville a speed of 47 miles per hour was sustained on a steadily rising grade.

The operation of the equipment was in every way satisfactory, neither vibration nor sound of the engine reaching the passengers. The car heated readily from the exhaust system, though the day was cold and the air keen. The 8-cylinder gas engine developed at times 150 horsepower and the two 60-horsepower motors were under such perfect control of the operator that the acceleration was noticeably smooth and free from jerks. The relatively small space occupied on the car by the power plant and its control by one man are worthy of note.

#### Plans for Elevated Road in Cincinnati.

Judge Rufus R. Smith of Cincinnati, O., representing the Cincinnati Traction Company, recently announced before the City Club of that city that the interests represented by W. Kesley Schoepf, president of the Cincinnati Traction Company, would finance the project of J. G. Schmidlapp for an elevated railway. The plans for the road have been considered for several years, but no active steps have been taken because there is no Ohio law favorable to the construction of elevated roads. A movement is now on foot to secure the passage of a law which will place the construction of elevated roads on the same basis as surface roads.

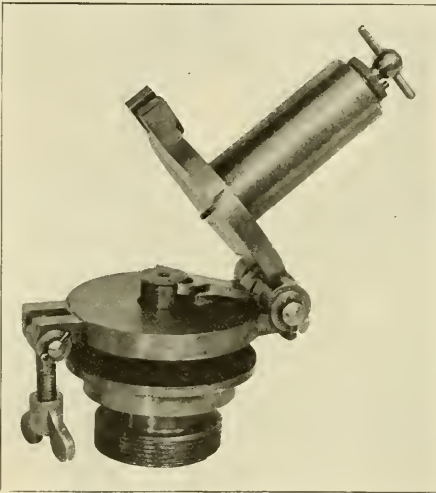

General Electric Gas-Electric Car for Railway Service.—  
Breech Block for Starting.

brackets, enabling it to fit under the back ends of the generator armature windings.

#### Control System.

The speed of the motors is governed by a potential control, the generator being separately excited and the terminal voltage of the motors being varied by means of a rheostat in series with the exciting circuit. The simplest explanation of the controlling system is arrived at by considering the circuits separately. The armature circuit of the main generator comprises the armature, fuse, two contactors in series, reverser and two motors. The motors are connected in series or in parallel, according to the position of the controller handle, and they are grounded to the truck framework, while the solenoid coils for operating the contactors are energized by a storage battery floating across the field circuit. The reverser is operated as usual by a separate reverser handle on the controller.

The current from the exciter passes around the field of the main generator and through the rheostat, the function of the controller being to cut in and out this rheostat as occasion demands.

A storage battery which floats on the exciter circuit is used for supplying the lighting circuits and its charging and discharging are controlled by means of a reverse current relay,

## ELECTRIC RAILWAY PROGRESS AND CONDITIONS IN THE CENTRAL STATES.\*

BY H. A. NICHOLI, GENERAL MANAGER INDIANA UNION TRACTION COMPANY.

Prior to two years ago the electric railways in Indiana and Ohio each maintained a separate organization—the Ohio organization known as the Ohio Electric Railway Association and the Indiana organization known as the Indiana Electric Railway Association.

Recognizing the similarity of conditions and the value of co-operation, the two organizations amalgamated under the title of the Central Electric Railway Association. We are now on a stronger and more substantial footing than ever before.

### Standardization.

Our "Standardization" committee has favorably reported standards for wheels, brakeshoes, rails and axles, and these recommendations have been unanimously adopted by this association. These standards were considered of such importance that they were practically all adopted by the American Street and Interurban Railway Association. This speaks well for our "Standardization" committee and the work done by this association.

Our committee on "Rules" has also reported on a standard code of rules for interurban railways, which has been adopted. Copies of these rules have been requested by railways located in various districts, all over the central states, and all emphatically pronounce them practical and complete.

We must not stop at merely adopting these standards by the association itself, but each individual member must see that the standards are put into actual use on his system.

We have only just begun our task. Other essential features must be standardized, such as brake rigging, couplers, drawbars, height and width of cars; also our tickets, accounting and track and bridge construction, and through the connecting of all the roads together it will be possible for longer hauls to be made and heavier and greater traffic transacted. This will enable us to more thoroughly compete with the steam roads for both long and short distance travel.

### Traffic.

At the present time a person can buy a through ticket from almost any point in one central state to almost any other point in Indiana, Ohio, Illinois, Michigan, northern Kentucky and parts of Pennsylvania and New York, and in soliciting and encouraging this business more commodious and faster service has been put on our electric railways.

Our freight and express has been thoroughly exploited with good results. Quite a few of the leading lines are now handling express matter through the "old line" express companies, and we must look forward for an extension of this portion of our business, as no doubt it will prove most profitable for us to work in conjunction with these express companies. They can and will turn over to us business from far and remote sections of our country, which we could not hope to get through any express department which we would inaugurate ourselves, and which latter service usually does not contemplate the collecting or delivery of express matter.

### United States Mail.

The carrying of United States mail on trains of the electric railways has not been entirely satisfactory. The compensation allowed by the federal government for this purpose not being considered adequate for the service rendered, and, according to a report made by the committee appointed by the American Street and Interurban Railway Association, it was apparent that no satisfactory results had been obtained by them, either through application to the postoffice authorities in charge of these matters or the house committee on postoffices and post roads; therefore it would seem wise that this association should well consider the advisability of the appointment of a committee to confer with the American association committee to see if we could render them any assistance looking toward the enactment of proper legislation through which we could secure a greater volume of this class of business at rates that would compensate us for its handling.

At the present time there is a wide variation in the rates of fare per mile charged by electric railways in our territory. An equalization of the rates should be made, so that all roads will have practically the same basic rate of fare.

Our interchangeable coupon book, which has been in use on some 24 of our properties, aggregating a mileage of 2,363

\*Abstract of president's annual address before the Central Electric Railway Association, Dayton, O., January 23, 1908.

for this last three years, does not seem to meet with the same degree of favor that it enjoyed in its earlier use, and I believe this association should take steps either to modify the conditions under which it is sold or to adopt some other form of mileage book similar and corresponding to the \$15 1,000-mile book now sold by some companies.

It has been thought well that the traffic officials of our various lines should act more nearly as a unit, and therefore a traffic association, auxiliary to but a part of the Central Electric Railway Association, has been formed.

### Growth in the Central Territory.

We must not lose our identity entirely in advancement. We must still retain our individuality and the distinctive appearance of electric railways, and should not attempt, at any time, to approach the operation of the heavy freight and passenger trains entirely distinctive of the steam railroads.

We now have in operation four distinct systems of electric transmission for the propulsion of cars. Each apparently is giving satisfaction in its locality. However, it would appear that some uniform system should be adopted in the future after it has been clearly demonstrated which system is the best for universal use.

During the last year the electric railways of Indiana have been extended and new ones put in operation to the extent of 400 miles, thereby increasing the total mileage in operation in that state from approximately 1,350 miles to 1,750 miles, and at this time there are approximately 200 miles under construction. In Ohio there have been put in operation approximately 35 miles, which has increased the mileage in operation in that state from 2,359 miles to 2,395 miles, and there are approximately 135 miles under construction. In southern Michigan there have been constructed and put in operation during the year about 60 miles of road, increasing the total from 700 to 760 miles. This same increase in mileage and consequent increase in new business may be expected from year to year in the same or greater ratio.

### Two-Cent Fares.

We have all met the 2-cent fare law, which has unquestionably operated against us, in favor of our steam road competitors. How far-reaching the effect of this law on our earnings will be is yet to be seen, but we are of the opinion that it will require superior service on our lines, for both long and short hauls, to permit us to hold the major percentage of the business which we now enjoy.

In this connection I wish to state that there seems to be a growing opinion among leading electric railway managers that in certain localities the electric railways have been carrying passengers at a rate not commensurate with the service given and that a readjustment and increase in the rate of fare must soon be made, so as to more nearly approach the 2-cent legal rate charged by steam roads.

### Fraudulent Claims.

In view of the fact that street and interurban railway corporations are made victims of fraudulent claims and at times are required to pay such claims, and believing that each of the member companies ought to be, as far as possible, protected against this class of claims, I would suggest that we seriously consider the appointment of a committee to devise a plan of exchange through our secretary's office of certain information regarding claimants for substantial amounts, the claim department of each member company to report upon blanks for the purpose such information for the benefit of any or all of the other member companies who may desire to make inquiry.

### The Association.

We have 22 companies contributing to the success of the secretary's office, and 392 individual members in the association.

The supply men have taken an unusual interest in our meetings and have been of great assistance to us, not only in a financial way but in aiding our committees to secure valuable information from the companies they represent; also by the exhibition of their wares and appliances and through the zeal and vim which they have injected into our conventions.

I wish to publicly thank Hugh J. McGowan, the president of the Indianapolis Traction & Terminal Company, for his liberality and great kindness to this association. He has for the last two years given the room which we now occupy in the traction terminal building free to this association, and if rent were paid for it at the usual rate it would amount to approximately \$500 per year.

I assure you that your president feels the high honor you conferred upon him at this time last year, and he wishes to thank you all for the able support you have given him.

## FUNDAMENTAL BRAKE RIGGING FOR HIGH-SPEED ELECTRIC RAILWAY CARS.\*

BY R. C. TAYLOR, SUPERINTENDENT MOTIVE POWER INDIANA UNION  
TRACTION COMPANY, CHAIRMAN "STANDARDIZATION" COMMITTEE.

Supplementing the very excellent paper on brake rigging prepared by Fred Heckler (Lake Shore Electric Railway) and read at the November meeting of this association (Electric Railway Review, November 23, page 817), the "Standardization" committee has continued its work of considering and investigating the question of the proper standards for foundation brake apparatus. This subject for the present purpose will be confined to the consideration of foundation gear for high-speed interurbans and include only that part of the apparatus from the air brake cylinder to the wheels under the car.

### Present Practice.

The foundation brake gear, as at present usually employed, consists of a series of lever, rods and pins of various proportions, ratios and designs for transmitting the pressure from the air brake cylinder to the shoes. The usual practice of stopping a car is by pressure applied to the brakeshoes, producing a friction between the shoe and the revolving periphery of the car wheels. The usual maximum pressure applied to the shoes is from 70 to 100 per cent of the light weight of the car.

Before submitting recommendations as to the standard brake gear the committee has deemed it advisable to inquire whether this practice of braking to 70 to 100 per cent of the light weight is the best practice. Before proceeding to design or recommend for adoption a standard form of brake gear it seems proper to consider what are the requirements of a perfect brake for stopping a high-speed interurban car.

### Requirements of Brake Rigging.

Summarizing these requirements very briefly:

After a car has attained the maximum speed there may be two reasons for bringing it to a stop. (1) At some pre-arranged station for convenience in ordinary course of transportation business. (2) For the purpose of avoiding accident and possible injury to person or property.

To stop a car for the first reason requires a certain force which may be applied in any convenient manner to accomplish the purpose. To stop a car in the shortest possible distance, however, requires the instantaneous application of the greatest possible amount of retarding force and the continuous action of this force at its maximum until the energy of the car is entirely destroyed.

The maximum retarding force that may be applied in any given case is that due to the friction resulting from the pressure applied to the brakes against the tires of the wheel. This friction between the brakeshoes and wheels tends to impede the rotation of the wheels and through the adhesion of the wheels to the rail tends to destroy the energy of the car. The maximum retarding force, therefore, is limited to the adhesion between the wheels and the rail.

### Retarding Force.

The maximum retarding force to stop a car can thus be obtained by applying a pressure to every wheel on the car and continuing the pressure necessary to produce sufficient friction to the rotation of the wheel just equal to the friction between the wheel and the rail. This maximum retarding force, if continued beyond this point, stops the rotation of the wheel, causing it to slide on the rail, very greatly reducing the efficiency of the stop.

Therefore, to determine the maximum retarding force that must be transmitted through the brake levers it is necessary to determine the coefficient of friction between wheels and rails. This will obviously vary with the weather conditions and conditions of the rail, but it has been found from a large number of experiments to average 0.18 per cent of the weight on the rail.

It has also been determined by experiment that while the same frictional resistance between the shoe and the wheel will skid the wheel at any speed, the pressure required on the brakeshoe to produce this same frictional resistance varies inversely as the speed of the car. Consequently a higher brakeshoe pressure is required to skid wheels at high speed and a lower brakeshoe pressure at low speed.

With a coefficient of adhesion of 0.18 per cent between the wheels and rails there is required to skid the wheels a ratio of brakeshoe pressure to total weight on braked wheels at  $\frac{1}{2}$  miles per hour of 0.70 per cent, at 20 miles per hour

of 0.95 per cent, at 40 miles per hour of 1.20 per cent, at 60 miles per hour of 2.40 per cent.

Consequently the foundation brake rigging throughout should be so designed as to sustain without distortion or undue wear a pressure of 2.4 times the total weight of the car to which it is attached. It was the intention of your committee to submit detailed dimensions of the car body levers and truck levers which it recommended as standards, but on investigation it was found that the arrangement of the electrical apparatus under the car, the design of the trucks themselves and the electrical apparatus mounted thereon made it quite impracticable at this time to do so, and therefore it submits for your consideration the following fundamentals of recommended practice for foundation brake gear.

### Fundamentals of Design.

1. Total lever ratio, 10 to 1.
2. Maximum braking pressure, 2.4 per cent of car weight.
3. Maximum pressure in brake cylinder, 90 pounds.
4. Maximum stress in all brake levers, 23,000 pounds per square inch.
5. Maximum stress in all brake rods, 15,000 pounds per square inch.
6. Maximum stress in all brake rod jaws, 10,000 pounds per square inch.
7. Maximum shear on all pins, 10,000 pounds per square inch.
8. Diameter of pins to provide a bearing value, 23,000 pounds per square inch.
9. Maximum hand brake power, 2.4 per cent of weight of car.
10. Equalized brake levers.
11. Inside-hung brakes.
12. Brake hangers on part of truck not spring supported.
13. Brake lever to bring a straight-line bearing on shoes.
14. Brake hangers and heads designed for maximum shoe wear.
15. Central Electric Railway Association standard brake head and shoes.
16. Automatic slack adjuster.

### Friction Regulation.

Lastly, but not the least important, there should be provided an automatic friction regulator so that a high-speed interurban car may be equipped to get the maximum possible retarding force on the shoes without skidding the wheels. If the above recommendations are adopted it is quite certain that the apparatus will be free from many of the objections of present designs, that the brake rigging will be reliable and free from failures and that a high-speed car may be reduced from maximum speed to a stop in the very shortest possible distance and in the shortest length of time.

### EMPLOYEES' CLUB ILLINOIS TRACTION SYSTEM.

The employees of the Illinois Traction System have recently organized the Interurban Club at Springfield, the object of which is to promote a closer fellowship between the officers and employees of the company as well as to provide a place where the men may meet and spend their idle time pleasantly and profitably. The club is composed of all classes of employees and anyone connected with the company is eligible to membership.

At 613½ Monroe street, Springfield, the club maintains four rooms, nicely furnished in mission style, consisting of a parlor, reception room, poolroom and cardroom. The parlor contains a piano and a music box and the reception room has a large library table on which are kept a number of papers and books which are of interest to the electric railway men.

The expenditure of money is controlled by a board of governors, consisting of two officials and two employees.

Each member carries a membership card which entitles the holder not only to the privileges of the home organization but also to those of the branch clubs now being formed at Decatur, Champaign, Danville, East St. Louis, Staunton and other cities served by the Illinois Traction System. The dues are \$1.00 per month and the payment of each month's dues is recorded on the back of the membership card, which thus indicates whether the man is in good standing.

V. C. Gourly, ticket agent at Springfield, is the organizer and first president of the club.

\*Abstract of report presented before the Central Electric Railway Association, Dayton, O., January 23, 1908.



### THE PROMOTION OF TRAFFIC.\*

BY CHARLES F. PRICE, GENERAL PASSENGER AGENT, WESTERN OHIO RAILWAY.

The question of traffic, and its promotion, is an important one to the interurban railways. This has been the subject of reports from committees at the meetings of the American Street and Interurban Railway Association conventions, both at Columbus, O., and at the more recent one at Atlantic City last October.

Traffic is the means by which the interurban and street railways receive the revenue to operate and keep up their equipment and pay dividends to their stockholders, and, as a traffic official, I desire to state here, and I know that I voice the sentiment of every interurban railway traffic official, that I am pleased to see the Central Electric Railway Association allot at least a portion of its time to a discussion of this subject.

The name "Traffic" covers all the business done by a railway, and my capacity being in the passenger department of the line I represent, I presume that it is the desire to hear something about the promotion of passenger traffic.

The steam roads long ago conceded to their electric rivals the local business, but still dispute the long haul. The local business rightfully belongs to the electric railway, and, with the right kind of service, it will always have it. The advantage of being taken from the center of one town and landed in the center of another is offered by no other means of interurban transportation. In this connection I do not believe that the rates of fare should be lower than those of the steam road, to obtain and hold this travel, except for the round trip. The accommodation, which includes not only the advantage of being landed "up town" but the frequency of service as well, appeals to the traveler and secures him, with anything like reasonable and comfortable service.

However, while this traffic belongs to the electric railways, it must not be conceded that any kind of accommodations for local business will suffice. The local business should be encouraged and fostered, for it is a valuable asset and should be accommodated with comfortable waiting sheds at all stopping points in the rural districts, frequent service, clean cars, fast time and, in the winter time, the cars should be warm.

Changes in schedules, in my opinion, should be avoided as much as possible. People living in the country become accustomed to a regular time for their car. Then there is a change and it takes some time to get them accustomed to the new order of things and, no matter how well you advertise the change before it goes into effect, there will be a loss of business for a while, and after it goes into effect it may be that complaints begin to come in about the service not being so satisfactory as it used to be, and the result is that some of your former patrons may, for a while, use some other means of transportation, although not quite so handy as the trolley. They will, however, come back gradually, but a regular schedule the year round can be handled much better by the electric lines than the steam roads, because the short days do not necessitate running trains later in the morning or earlier in the evening, for the electric cars run every hour.

The development of the country along electric lines for suburban residences should be encouraged. Commuters' rates should be reasonably low and the service such as to encourage the every-day travel. Secret societies, lodges, theatrical parties, basket ball, foot and base ball do much toward increasing the revenue. Along our line the members of the various I. O. O. F. lodges are now making trips every week or ten days to some other town, carrying on their work and contesting for a prize which will be awarded the latter part of February. They never go in less than carloads and return early at night, always before the time arrives for shutting down the power. Any suggestions that might be given here for rates for theaters, parks, etc. would probably be out of place, as those matters are governed entirely by the local situation and conditions and I only intend to touch upon the subject of "Promotion of Traffic" as a general proposition.

#### Handling Baggage.

The commercial business of the electric lines is constantly increasing. When I say this, I do so in regard to our line, which handles baggage on every car and checks 150 pounds free with every ticket costing over 20 cents. We are handicapped on interline business, however, by the variance in which baggage is handled. Some lines still charge 25 cents per piece for baggage and only have two or three cars during the day that baggage can be hauled on. This service is no

inducement to the traveling man. Other lines charge a different rate per hundred because their rate of fare is lower. The baggage matter should be uniform and I think that the line which charges 25 cents per piece for baggage should accept the prorate of the revenue received when it receives baggage from a line that charges excess.

When the question of handling 150 pounds of baggage free came up after the legislature of Ohio passed the 2-cent bill for steam roads, making their rates the same as those on the Western Ohio, we considered the advisability of making the change very seriously at first and had some doubt about it, but we are more than pleased with the result since we adopted the baggage rate in effect on steam roads. Our rates of fare and baggage rates are the same as our steam road competitors' and our baggage receipts from excess baggage are larger than we received before and we are hauling the 1-trunk passengers going on a visit that we did not get before. The careful handling of baggage is a feature not to be overlooked in the effort to promote traffic. It is just as important to deliver a piece of baggage at its destination as it is the passenger. Records by checking and receiving agents, as well as conductors, are a great help in tracing lost baggage. Employees handling baggage ought to be impressed with the importance of prompt forwarding and sure delivery of all baggage.

#### Excursion Business.

Last season we ventured into the excursion business on a much larger scale than usual, having for several years sold excursion boat tickets from connecting points as far south as Dayton on the Dayton & Troy. I believe there is a great future for the summer boat business, judging from our experience last summer. On two different occasions we joined the Detroit & Cleveland and Cleveland & Buffalo boat lines in cheap excursions to Niagara Falls. We had one just before the steam lines had theirs and one immediately afterward. We made the same rate as the steam roads and had two carloads the first time and three the last, every passenger on the first one being a living advertisement of the excellent service. We had nearly a carload from one town on our line where they took the car at 4 o'clock in the morning and made 131 miles to reach the boat. In both instances the excursion party was landed in Toledo by 9 o'clock in the morning, before the heat of the day, making a cool, clean and pleasant trip.

We consider the success of the Niagara Falls excursions the very best kind of an advertisement for our lines and in addition to the advertisement we made a nice profit on the business. Excursions of this kind, where they can be run, help in the work of educating the public to the use of the electric roads.

We run several excursions each season to Cleveland, issuing an exchange order on the Nickel Plate road, good at Mortimer. I am a believer in the most liberal form of advertising. For our Niagara Falls business we occupied half pages in the daily papers along the line, using a large cut of the City of Erie, one of the Cleveland & Buffalo steamers, and large display type; we also got out bills in two colors. We reserved berths upon application, and after the excursionists returned took the pains to inquire as to how the trip was enjoyed and did not have a complaint from a single one of the several hundred persons. Everyone in the two parties was a talking advertisement for our service, and hereafter we can be relieved of the expense of a large amount of advertising we were compelled to do last season to induce the public to try the "electric way" for business which had heretofore been monopolized entirely by the steam roads.

We have also stimulated travel by getting business men in the various towns along our line to run "shopping" excursions, and they have been very satisfactory revenue getters.

#### Week End Excursion Rates.

The roads which constitute the "Lima Route," the Toledo Urban & Interurban, the Western Ohio and the Dayton & Troy, have in effect what are termed "Week End Rates" to Dayton, Toledo and Springfield, from all stations on the Western Ohio, and from Dayton, Springfield and Toledo to all points on the Western Ohio. These rates are a fare and a third for the round trip, good going every Saturday and Sunday and returning including the Monday following date of sale. Prior to putting these rates into effect we had a 1-fare rate for the round trip, good going and returning on Sundays only, but we tried the experiment of increasing the rate and making a more liberal time limit, and not only did our revenue increase, but more tickets are sold than under the former arrangement. We also check baggage on these tickets.

For the long haul, I believe that a reduction, if only a slight one, will bring additional business, provided the road giving it is prepared to give the passenger an easy, comfortable ride, free from delays and annoyance. The time need not be as fast as the steam line, but the equipment should be

\*Abstract of paper read before the Central Electric Railway Association, Dayton, O., January 23, 1908.

such that he can enjoy just as easy a trip. In this connection I desire to state the fact that the keeping of trains on time is an important item to be taken into consideration, in local as well as in limited service. The time should be fast, but with enough time to enable the cars to make the schedule should they be held up from any unavoidable cause. A schedule that is so fast that cars cannot be kept reasonably on time should be changed.

Party rates are a means of developing a considerable amount of business. The rates differ greatly. Some lines give a rate for 10 or more passengers going on regular cars. Others have 25 the minimum number to secure reduced rates. Our line has always withheld making any reduced rates, except to parties of 50 or more, which includes special car service if desired. I am of the opinion that granting a reduced rate of fare to a small number of passengers is unwise from the fact that I have noticed that they usually go anyhow. If the party lacks in numbers, my observation has been that the revenue to the company amounts to more, and I think an electric railway with hourly service should value that as an inducement, together with the fact that parties can return home earlier at night and in closer proximity to their homes, than by steam road. The argument is all in favor of the electric lines; then why disturb the rate except for an unusual number?

The long haul business will never be successfully handled, in my opinion, until cars for this business are run in trains, and I believe that the time is not far distant when all of the through business will be handled in this manner. The great drawback to the present manner of handling through business over foreign lines is that the motor cars, like the steam engines of the other railroads, have to be at their own barns to be gone over each day. This sometimes necessitates passengers changing cars, which results in anything but satisfactory service. Trailers would obviate all that annoyance and I venture the prediction that the time is approaching when motor cars will haul trains of several cars from as many different points to junction points, where they will be transferred to as many destinations several hundred miles from the starting point. When this is accomplished it will be common for passengers to go to and from Buffalo, Cleveland, Toledo, Detroit, Dayton, Columbus, Cincinnati, Indianapolis, Chicago, Louisville, St. Louis and intermediate points. The public does not patronize the electric lines because of its greater love for them, but because of the convenience.

#### Treatment of Passengers.

Agents and conductors should be courteous and accommodating, patient and considerate. If an excited individual rushes up to the ticket window and asks what time the 11 o'clock train goes, the agent should not give way to his feelings, but should tell him. When cars are late, they should keep those waiting informed. They should be posted on the time of the steam roads, location of hotels at the different towns, and other things of which the traveling public requires knowledge. Our line supplies conductors with a schedule giving the time of every steam road at every station we connect with, so that he is prepared to answer questions of that nature which come to him dozens of times daily. This schedule contains the time of our competing steam roads also. I believe the traveling public should have any information desired, and you will make a friend of the traveler by giving help sooner than by letting the conductor or agent say to him, "I don't know."

I believe the public is entitled to every confidence in reference to the matters which concern them, some of which I have mentioned above. The closer this relationship is drawn between the public and railways the more considerate the former will be and the more pleasant and enjoyable will be that relationship. The public should be made to feel that the patronage is appreciated and sought, and the more of this spirit that can be infused through courteous and painstaking employes the better will be the showing in receipts.

For the information of the traveling public, we have placed in all of our ticket offices large bulletin boards with a blackboard in the center, and rows of boxes on each side for the time folders and advertising matter of our own and other electric lines. On the blackboard we make announcements of excursions, attractions and other matters of interest to the public. We find this way, and the hanging of bills in our cars, the best way to reach our regular patrons, but for any extra occasion we use the newspapers liberally.

Electric lines can do a good business in handling theatrical companies, and that class of business is increasing each year. We are probably better equipped to handle this kind of business than some roads, from the fact that we do a heavy freight business and have freight motors and trailers and we press them into use whenever occasion demands for handling the scenery and baggage.

In the matter of interline or through business I do not

believe it is justifiable to make a rate much below the steam road, the frequency of the service being worth something. On the line of the "Lima Route," we meet the steam road rate between Toledo and Dayton and from all stations to either of these places. The Lake Shore Electric has put in a 30-day rate of \$1.50 from Toledo to Cleveland. This is considerably below the steam road rate and the result will be interesting to traffic officials.

In the promotion of through or interline business I am of the opinion that more of this business might be obtained, even though the electric mileage is much longer in some instances, if the rate were made to meet the steam road or short line, and the revenue prorated per rate where there was a different rate per mile, than by the roads holding out for their local, as some do. The sooner electric lines get out of the rut of doing business on street car line methods and follow the steam road plan, which is the result of years of experience, I believe they will add more to their revenue. In this connection, the recent movement to organize a traffic association among the electric railway traffic officials, I am of the opinion, will solve this question in a manner that will be satisfactory.

I believe it timely and proper to speak a word to the executive officers. I know you will soon see the good results obtained from the formation of the Central Electric Traffic Association. We are all working for the same end. We believe in a distinct organization, one before which only traffic will be discussed. Matters of issuing tariffs, etc., can thus be more economically handled. At the short session held in this room yesterday afternoon more traffic was discussed and more done toward promoting traffic than at any previous meetings of the association.

#### Advertising.

In advertising too wide a circulation cannot be given timecards, maps, etc., bills, attractive posters or billboard advertisements and the newspapers. In the newspapers you reach all classes. You reach the regular patron of your road who is also reached by your bills. You reach the occasional traveler who may or may not see your bills. You reach the person who has never patronized you and never sees your bills, and he is the individual you want to reach. The newspapers go into the private offices, storerooms, shops and homes, and reach daily thousands of people who have not been educated to use the electric railways. Anything with the name of your road on it is a good advertisement and a promoter of traffic. During the past two years the roads constituting the "Lima Route" have several times covered the states of Ohio, Indiana and Michigan with advertising matter, placing large timecards, maps, etc., in every depot and hotel and other public places. It is true that all of the matter put out does not stay permanently, but some of it does, and that which does not stay remains long enough to do some good, and we have absolute knowledge that a great deal of business has been brought to our lines through the means I have mentioned. The public needs to be educated to use the electric railways. True, they have been in operation for a number of years, but so have the steam roads, and they advertise more and more each year.

#### Equipment.

Not all, however, depends on the advertising matter you may put out. Your road ought to give better service than it advertises and never give poorer. Have something in your equipment that will cause passengers to speak favorably of your line. The service should always keep ahead of the patronage. The Lake Shore and Pennsylvania railroads did not wait to see if their New York-Chicago limiteds would pay by first putting ordinary trains in the service and then put on the luxurious trains they now have. They built the trains first and put them into service and offered them to the public for approval, and the result is that when one of the lines recently announced its intention of lengthening the time, the public raised such a clamor that the road abandoned the idea. Why? Because the public had been educated to use the trains.

So it is with the electric railway. People have become educated to the advantages of its local service and attention must now be turned to the development of the through business, the handling of which now confronts them.

In handling this subject I have done so with a realization of the fact that it will be impossible for me to cover all phases of the question. A traffic man, either passenger or freight, stands between the public and the company. He is the one who hears the complaints and has the rough places to smooth over so the figures will appear on the ledger in the right color of ink. The man who brushes up against the exacting public is the one capable of giving suggestions as to the "Promotion of Traffic." Now that this association has taken up the important matter of traffic, I hope to hear some phase of it discussed at future meetings, that we may all profit by it.

### THE TELEGRAPH SIGNAL SYSTEM.\*

BY CHAUNCEY P. BUTTON, GENERAL MANAGER TELEGRAPH SIGNAL COMPANY.

The development of our electric railways for interurban service has been so wonderfully rapid as to cause astonishment not only at home but abroad. In fact, Germany and other foreign countries send representatives here for enlightenment in this particular field.

It must have been gratifying to you gentlemen of the central west to hear the real good things these representatives have said about the systems which your enterprise has made possible. Such prestige as this deserves to be carefully safeguarded, and in pursuance of such a course would it not be wise and timely to take a careful inventory of every single feature which is a part of your operating system?

#### Requisites of a Good Road.

There are a great many requisites. You possess practically all. Why not make it all? Then when you hear these good things said about you as a whole what an added

cents, 4,108 killed, is due, in a large measure, to 10 accidents which caused the death of 291 persons. The larger part of this loss of life and property could have been avoided and at nominal cost. For the sake of all interests, humanitarian and financial, and keeping in mind the great responsibility that rests upon the shoulders of the different railway officials, should not this lesson of the past year's losses cause a united effort toward putting a stop to it?

There are accidents occurring on the electric railways in the central west as well as other parts of the country that are costing hundreds of lives and thousands of dollars. These accidents could be averted by expending \$1.00 per month per station for insurance against such a happening by adopting a signal system. I cannot consistently advocate an automatic block signal, for on many of the single-track lines the traffic is so heavy as to make such a system wholly impracticable, if not an impossibility, inasmuch as it is not of sufficient flexibility to meet the conditions on such a line. On the other hand, the lines where the traffic is light and conditions possibly favorable to such a system, the revenues are not such as to make its adoption possible, for it must be borne in mind that only about 20 per cent of the electric roads in the United States are dividend earners.

This very fact has been an incentive to inventors to perfect a signal for use on interurban lines which is of sufficient flexibility to permit of its successful use on the heavy traffic line and sufficiently low in cost of adoption to bring it within the reach of all.

#### Steam Road Comparisons.

From the train dispatchers' standpoint let us consider the conditions that obtain on the steam road and compare them with the electric road. The dispatcher on the electric road has, as a rule, a great many more trains under his watchful care than has the dispatcher on the steam road and issues about twice or three times as many orders. More brief, to be sure, but every one has the same stamp of importance on it. The dispatcher on the steam road has a means of getting in touch with the train crew at practically every switch on his line by instructing the telegraph operator to throw a semaphore signal against the train and then issuing the orders through the medium mentioned. The dispatcher on the electric road has no such advantage and should have just as reliable a means of getting in touch with his trains, for schedules are disarranged here as on the steam roads and traffic fluctuates to an even greater extent.

To be sure the electric road has a telephone which enables the train crew to communicate with the dispatcher. But what a one-sided arrangement! The dispatcher should by all means have as great or greater power to stop any train in his district and issue such instructions to it as conditions might necessitate.

The movement of neither people nor cars is regular on interurban lines and some little mishap on the line may shatter the best dispatcher's best built castle to be quickly shattered, and it must be as quickly rebuilt. The method of having reporting stations is not adequate to the needs on such occasions, therefore the dispatcher should have a means of throwing a semaphore signal to danger at any selected point.

#### Overrunning Orders.

Experience has shown that the greatest danger of collisions between opposing trains is due to the motorman overrunning his orders, that is to say, running beyond the siding which the dispatcher, by special order, has named as the meeting point for the two trains.

Man is not infallible and it is not a reflection on the railroad official that his men frequently overrun their meeting points, for very often it is the most reliable man in the service who thus errs; however, it is a reflection on the railroad official who does not provide a means to avert such occurrences when the consequences of forgetfulness are brought to his attention almost daily.

It can consistently be held that a signal system is an essential safeguard in handling trains with a telegraph or telephone dispatching system. It should be within the power and the duty of the dispatcher to set the signal to danger at the siding at which the trains are to meet the moment he fixes a meeting point other than the regular meeting point provided for on the timetable. Then when the motorman forgets his order, as he does frequently, and the conductor fails to check him, as he does frequently, the dispatcher's signal stands at danger at the meeting point, a preventive against accident.

The first car of the two to arrive at the meeting point finds the signal set in a horizontal position, indicating danger. The conductor or motorman quickly communicates with the dispatcher by telephone as follows: "Stanley and Thompson

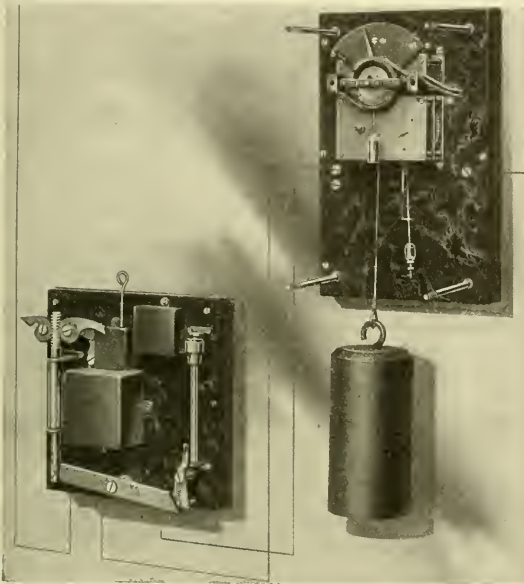

Telegraph Signal System—View of Semaphore Control Device Opened.

satisfaction it would be to you to know that you have taken advantage of every available means in providing for the safe and efficient handling of the lives and property entrusted to your care.

Your roadbeds are excellent, likewise your equipment. Your electrical and mechanical departments show evidence of skillful guidance and generous expenditures. The personnel in your train service is, as a rule, excellent. I have observed many instances of courtesy on the part of your trainmen to your patrons which bespeak credit to your discipline and to the intelligence of your employes. Your system of train dispatching could be improved by standardization. This accomplished, you have little left to gain from the steam railroads as to operation, notwithstanding their many years of dearly bought experience, except to profit by their mistakes.

#### Accidents.

During the year ending June 30, 1907, the railroads in the United States killed 5,000 and maimed 76,286 passengers and employes, an increase of 775 killed and 9,577 injured over the corresponding period for the previous year. The disastrous record of casualties to passengers in train acci-

\*Read before the Central Electric Railway Association, Dayton, O., January 23, 1908.

at No. 3 or Troy," the dispatcher in turn reminding them of their order to meet a certain train at that point and further instructing them as to restoring the signal to clear or otherwise.

Here is provided a means of enforcing obedience to your dispatcher's orders. The American Railway Association rules require the placing of the "middle order" in the hands of the operator at the meeting point when practicable as a means of reminding the crews and enforcing obedience to orders. This, of course, is not possible with a telephone dispatching system with no operators at the meeting point, but by having your dispatcher place the signal at danger at the meeting point you are taking a step in advance of the American Railway Association which should cause them to sit up and take notice.

#### Value of Signal Control.

A telephone dispatching system with a reliable signal under the control of the dispatcher is the best, safest and quickest means of dispatching trains. Compared to the actual need, but little thought has been given to this branch of the service, but during the past year the Central Electric Railway Association, aided by the electric railway press, has stimulated thought upon the subject; indeed it was the well-known need of an adjunct to your telephone dispatching system, together with the encouragement and active aid of the members of this association, that caused this signal to be perfected to meet your practical requirements.

About two months ago an electric road in the state of Illinois suffered a head-on collision which caused the death of 17 persons and injury of many more. The damage claims filed thus far amount to \$219,000. It might be timely to say the Telegraph Signal Company's signaling apparatus, for preventing head-on collisions, could have been rented and operated for a period of 1,500 years for that sum.

Not long ago a general manager in New York state, upon whose line several head-on collisions had occurred, accompanied by the usual fatalities and property loss, offered in extenuation for his not taking means to avoid a recurrence that it was pretty handy to throw the current off the line when advice was at hand that a collision was imminent. This is a most unsatisfactory manner in coping with the dangers of forgetfulness. In the great majority of cases the first information you obtain from a crew overrunning its order is in the accident report which almost invariably follows.

Without a safeguard every meeting point fixed by special order has an element of danger lurking about it which should be eliminated.

With the telegraph signal system to throw a signal to danger at some point on the line the dispatcher simply turns a 2-point switch to connect with a 200-volt circuit, this being brought from the trolley line if desirable, and reduced by resistance coils from 500 or 600 volts. He then inserts a plug, in hole No. 3, for instance, throws the 2-point switch and a few seconds later semaphore No. 3 on the line is released and gravitates to danger. Immediately following this the device records the number of the signal that has operated by cutting the same number of holes in a tape as corresponds with the number of the semaphore that has operated.

The response is given, not by the operation of the master machine in the dispatcher's office or the line machine at the distant station or the releasing trip at the distant station, but by the semaphore actually gravitating to the full danger point, this in turn causing the device to automatically record the fact by wire.

As it is physically impossible for the main office to get the indication until the semaphore blade has reached the full danger point, danger of false indication is eliminated, and if other than the desired signal has operated from any error of the dispatcher in inserting the plug in the wrong hole, no deceptive response is given, for the number of the particular signal which has operated is received and none other.

This signal is operated from central energy. There are no local batteries along the line to depend upon. The lamps use oil or electric lights on the semaphores as desired. We use one bare galvanized iron line wire. There can be an unlimited number of signals on a circuit, 50 if desired. Such signals have been in use for quite a few months on the Indiana Union Traction Company's line, Anderson to Wabash, and that they have satisfactorily acquitted themselves I think can be vouched for by the president of your association, H. A. Nicholl.

A rolling mill engine of 25,000 horsepower capacity, said to be the largest in the world, has been built by the Allis-Chalmers Company for the Carnegie Steel Company plant at Sharon, Pa.

## ELECTRIC RAILWAYS AND THE GENERAL PUBLIC.\*

BY E. B. GRIMES, OHMER FARE REGISTER COMPANY.

The value of the electric railway to the general public is incalculable. It is the modern means to the rapid transaction of business in cities and in rural regions. In short, it carries the general public to the farmhouse gate and to the very doors of the humble cottage and of the stately mansion of the city, and is, therefore, nearer to the people in all respects than the steam lines.

### The "General Public."

All sorts of passengers are included under the broad and familiar title of "General Public":

The man who wants the door ajar, and for "his rights" will fight;

The other man across the aisle, who wants the door kept tight;

The man who wants a window up, the man who wants it down;

The woman who can't find her fare until she's 'way up town.

The mother with her baby boy, close cuddled in her lap, Who, when he tries to stretch himself receives a gentle slap, Which is to show, to all aboard, that he's not nearly three, And must behave himself—the dear—while he is riding free.

The man who plays the porker's part, and takes up all the space

That would accommodate, at least, two others of his race.

The women who cannot decide just which will pay their fare, Until they almost tempt—but, no—conductors never swear.

The man who has imbued too much, and swings his heavy load

Upon the people's knees and feet, and tries to run the road. The "gent" who says, "You've got my fare," and when he's told, "Nay, nay,"

Declares that he'll be put off first before he's made to pay.

The "chappie" who ne'er makes a move to offer up his seat Unless the female passenger is pretty, young and sweet. The woman who will ne'er get off with face toward the fore, But leaves the car in crawfish style—and picks herself up sore.

The fussy man with bundles, which he pokes into your eyes; The market basket patron, who, for cheek, should take the prize.

The "lady" who insists that she should ride hack in the place Where rude and thoughtless men and boys blow smoke right in her face.

Indulgent mothers who permit their darlings' little feet To wipe their muddy shoes upon the newest, softest seat. And various other types there are, for you have seen them, too,

You'll find them everywhere you go—from Dayton to Peru.

There is a disposition on the part of certain representatives of the public to find fault with corporations in general, and with street and interurban railroads in particular. Nothing pleases them. They are displeased with themselves. Cars are either too hot or too cold. The schedule of operation is unsatisfactory and the service is poor in all respects. If the car is only partly filled they remark about the road losing its business, and they wisely shake their heads, as much as to say "they know why"; if it is well filled they maintain that it is uncomfortably crowded and the road is doing too much business.

This is an unfortunate and regrettable condition. In these later years of exposure, condemnation and punishment of the big as well as of the petty grafters, much has been done to relieve corporations from paying tribute to municipal and county highwaymen, and much has been done, also, to improve the standard of official public service. The people are aroused at last and are taking a more active interest in all municipal, county and state affairs.

General Public is not a sordid, mean, retrogressive old grafter. He is hereabouts, and in the wide territory we have indicated, a notably intelligent, fair-minded and progressive exponent of American enterprise. In his dealings with the electric railway managements he is met by men of the highest character; men who are accustomed to do business on a large scale; men who know what they want and who are able to solve perplexing problems on the spur of the moment; men who, along with their own interests, are seeking to give the

\*Abstract of address delivered at annual banquet Central Electric Railway Association, Dayton, O., January 23, 1908.

public the best possible service that can be evolved from the wonderful development of electrical transportation.

Old General Public, he must yield  
A point or two to 'lectric roads,  
If he expects that they will come  
And haul his various kinds of loads.

And 'lectric lines must give and take—  
The latter knockers say they do.  
But who can know how much is spent  
Before the roads can earn a sou?

When interests are so closely knit,  
As public weal and railway line,  
It's meet for each to form a trust  
And merge them into one combine.

There is no class of men who work a greater number of hours, or who are called upon to render more prompt and decisive action, or to exercise brighter or keener faculties, than the active, operating railway officials. They are constantly on the alert. In the service and in the protection they give the general public, they sacrifice their rest, their comfort, their health and their lives.

#### PUBLIC TAXATION.\*

BY JUDGE DENNIS DWYER, PRESIDENT DAYTON COVINGTON & PIQUA TRACTION COMPANY.

I may picture the bright and scientific side of your work and that of others, and the influence it is exerting along the lines of human progress, but there is another side to this subject, and that is, to make the properties you manage and control, if possible, make dividends for your stockholders. This feature of the work admonishes me to call your attention to the subject of public taxation.

In this state the most recent discussion of the question leads in the direction of relieving all real and personal property of individuals from all forms of state taxation, except inheritance taxes, and outside of the latter of raising sufficient revenue for state purposes from licenses, taxes on intoxicating beverages and on public utility and other corporations in the forms of franchise and excise taxes.

According to the scheme contemplated, each county and municipality would be free to levy and collect taxes for its needs without any partnership with the state, either in assessment or distribution. The plan suggested is more simple in its operation than the one at present in force; the only objection is the danger that such a method of raising the entire revenue for the state, in such a manner, will lead to reckless extravagance in legislative appropriations. For when the taxes to be raised do not directly affect the individual citizen, when he does not see the money come out of his pocket, and besides as it mostly affects public utility and other corporations, he is liable to become indifferent as to the amount to be levied and collected, and this situation affords the best opportunity for vultures and schemers who are anxious to fatten on liberal legislative appropriation to put in their work.

We hear every day of new suggestions as to how more revenue can be raised from corporations. At the present time there is a bill before the legislature whose author boasts that if it passes \$12,000,000 will be raised annually from excise, franchise and other taxes on public utility and other corporations.

I am not now, never have been, and never will be in favor of shielding corporations in the slightest particular from a full discharge of their public duties, neither am I in favor of holding up any man or corporation unjustly who puts money into a public enterprise. Corporations are composed of individual stockholders who invest their money, it may be true, in the expectation of profit, but in a great many cases they are unfortunately disappointed. This brings me in this connection to the interurban electric railways of Ohio as showing how disappointing they have been so far to their stockholders.

The report of the Ohio railroad commission just issued for the year 1907 gives the names of 58 interurban electric roads within the state with an aggregate capitalization of \$114,326,903, with gross earnings of \$12,256,659, and with operating expenses of \$7,403,396, about \$4,000,000 of which had been paid out for labor, leaving for interest on bonds, insurance, taxes, maintenance, betterments and dividends on stock, \$3,984,558, and of this only \$628,570 was available for dividends. Three of the roads reported show a deficit, making them practically insolvent, and only eight out of the 58 roads paid any dividend, and these only from 2 to 5 per cent. If

the aggregate of dividends paid should be estimated in the capital stock of \$114,326,903 it would amount to only three-fifths of 1 per cent. It may be said, however, that the capitalization of the electric railroads is too high, that there is too much water in the stock. That may be true as to some who were compelled to sell their bonds and stocks in advance of construction at considerable loss par, but conceding for the sake of argument that the capitalization is too high and that we cut it down one-half, which is far below the actual cash cost of the roads, even then the dividends declared would not be over 1½ per cent on the dollar in the entire capital stock so reduced.

The foregoing facts should be brought home to all fair-minded people, for there is danger that the present tax rate of nearly 6 per cent, as the railroad report shows, on the gross earnings of the interurban street railroads, will be greatly increased if the new scheme of legislation becomes a law. It is to be regretted that the people who had the public spirit to invest their money in interurban street railroads, which have done so much for the prosperity of the towns and cities through which they run, and for the farmers along their lines in enhancing the value of their real estate, and in furnishing them such modern convenience for travel and traffic, should be the only sufferers. Yet such is the case, and from the statistics shown it is evident that any further increase of taxes will result in forcing many of the interurban street railroads into the hands of the receivers, thereby ruining their stockholders and lessening the efficiency of the roads to the public as carriers of passengers and freight.

Does the public want this condition of the interurban electric railroads to happen which means lowering of wages to employes, ruin to stockholders, no further building of new or extensions of present roads, for nobody under the circumstances will take their bonds or stock, and what is true of interurban electric roads is no doubt equally true of steam railroads, so that it is up to the public to determine whether such legislation shall be enacted as will practically wreck the entire railroad system of the state.

There is not today a trunk line of steam railroad but needs, in the interest of its stockholders and of the public welfare, that is, for the protection of life and limb against accidents and for the dispatch of business, to be double-tracked, and many of them were proceeding to do this when the present panic began, but all double-tracking, which would afford employment to many thousands of people, has stopped, because money could not be had to go on with the work, and it is certain that if the legislation sought to be passed of cutting down rates of transportation at one end and increasing the burdens of taxation at the other end should be enacted, that no bonds or stock can be sold, and therefore it will be a long day before the work of double-tracking or building new extensions will be again begun.

I am no idle dreamer, nor do I want to create any false alarm, I speak only of what I know and of what should be patent to every observing person when I admonish the public of the danger of following the advice of demagogues in hostile legislation against public utility corporations. Let them be punished, and severely, too, for discrimination in rates whenever they occur. Let them be compelled to obey the law as to equal and just treatment to all their patrons and to the public, but permit them to conduct their business so that their stockholders will have some chance and the era of railroad building which has been stopped will return when money matters are again adjusted.

If, therefore, a prudent conservative course of legislative action is adopted by the law-making power, in dealing not only with electric and steam railways, but with all other public service corporations and enterprises with a view to their regulations, not destruction, and the bright anticipations for the future pictured by me in the first part of this address will be more than realized, redounding to the prosperity, honor and glory of the American people. If the contrary action is taken at the behest of demagogues, I draw the veil.

#### Ticket Selling on London Underground Railways.

A consular report states that the underground electric railway companies of London are about to try the experiment of employing women ticket sellers or "booking clerks" at stations. It is stated that the principal reason for doubt as to the success of the plan rests in the hours of duty, which range from 5 a. m. to 12:30 a. m. Moreover, the employment of women restricts the opportunity for training young men who may pass into other branches of the service. In addition to women ticket sellers the underground electric railway companies are about to enlarge on an experiment, which already promises success, in the use at station entrances of automatic ticket machines with slots for half pennies and multiples thereof.

\*Abstract of address delivered at annual banquet Central Electric Railway Association, Dayton, O., January 23, 1908.

## ELECTRIC NOTES ON SMALL STEAM TURBINE PLANTS.\*

BY C. W. PEN DELL.

We shall consider a small plant as being one that requires two 500-kilowatt generators to start with and the ultimate capacity of which will not exceed 3,000 kilowatts, the probable final layout being 500 kilowatts and two 1,000-kilowatt units.

On account of characteristic efficiency curve of the engine it has become common practice to connect to reciprocating engines electrical generators which will deliver their rated capacity, with maximum generator efficiency, at the time when the engine is operating most economically.

When turbines were first put on the market it was natural that experience gained with engine-driven units should be considered when determining the size of generator to attach to a turbine. What was supposed to be the maximum load the turbine would carry with satisfactory speed regulation and permissible steam consumption was taken as the overload capacity of the generator. Standard practice being to allow a 50 per cent overload capacity in generators, two-thirds of the capacity assumed as the maximum for the turbine was called the rated capacity and a generator of corresponding size attached. Subsequent tests have shown, however, that the point assumed as the full load rating of the turbine is not its point of highest efficiency and the question of whether the relative turbine and generator capacities should be connected together is one that is receiving attention at present.

### Heating.

On account of their high speed the cubical contents and heat radiating surface of turbo-generators are small, which tends to give high operating temperatures. The fields, wherein most of the machine losses are converted into heat, are extremely compact and are not cooled except by the air they draw into their center by centrifugal fan action and discharge outward into the armature winding. The cooling of the armature must be effected by the air, whose temperature is already quite high. The excitation must be higher with inductive load than with non-inductive load, consequently the field losses and machine temperature will be higher with a certain kilo-volt-ampere load at 80 per cent power factor than a unity power factor. Tests have shown that the temperature of a turbo-generator will follow very closely the amount of load on the unit. When with an engine-driven unit it would take the generator a couple of hours to attain the maximum temperature on overload, the turbine-driven generator will reach its maximum temperature corresponding to a definite load in from 15 minutes to half an hour. This being the case, we must evidently take the 2-hour overload rating off such generator and connect to the turbine a machine which is capable of carrying indefinitely the maximum load we wish to put upon it. In other words, if a turbine will carry 750 kilowatts with satisfactory speed regulation and steam consumption connect to it a 750-kilowatt flat generator. Specifications covering the generator should guarantee a rise in temperature with 750-kilowatt load at 80 per cent or lower power factor and should also state excitation current at the power factor.

The maximum efficiency of a turbine occurs at about 25 per cent beyond the point originally assumed as the rated capacity. When operating below this point the efficiency falls off rapidly, but the drop on overload is very slow. This being the case, it is often more economical, when investment and fixed charges on a plant are taken into consideration, to operate the turbines at heavy overload, even with reduced economy in steam consumption, and get as great an output as possible from each unit. This is another argument in favor of putting larger generators on turbines than has been the practice.

### Frequency.

Modern alternating-current practice dictates that a three-phase system is one to install for all except very special conditions.

At present there are only two frequencies that can be considered as standard in the United States, that is 25 cycles and 60 cycles. The speed of 60-cycle turbo-generators is higher than that of 25-cycle units, but this difference affects the electrical operation of the plant very little, except at times when generators are being synchronized; it being somewhat easier to synchronize 25-cycle generators than it is 60-cycle generators. Synchronizing turbo-generators is accomplished more readily than with engine-driven units on

account of the uniformity of turbine speed and there being no periodic fluctuations of frequency due to unequal angular velocity at different parts of the revolution as with engine-driven units. Lamps should never be used, except in cases of emergency, in synchronizing turbo-generators. A synchronism indicator, with a dial of such size as to be easily seen by attendant from a position in front of generator switches, should be installed on switchboards in all cases. In synchronizing operators should be careful to bring speed of the incoming machine very closely to that of other machines already on the bus. It is preferable to bring incoming machine up to a speed slightly below that of other machines and then close generator switch with a slightly increasing speed on incoming machine. This method of synchronizing should be adopted to maintain the mechanical balance of turbine unit; it is somewhat difficult to maintain the mechanical balance of turbine units with the best of care and sudden jars due to careless synchronizing have been known to throw them out of balance. The jar is the least, of course, if switch is closed with incoming machine in exact speed and phase synchronism with the bus, but this condition is somewhat difficult to attain and there is less liability of trouble if generators are synchronized as given above.

In a 60-cycle plant there should be an automatic voltage regulator which could be made to maintain the bus voltage constant at all times or it could be compounded to raise the voltage as the load comes on. There would then be hand-operated induction regulators on the lighting feeders leaving the plant.

On account of the high voltage all switches about the plant must be of a type that have their make and break contacts immersed in oil and great care should be exercised in the selection of such switches. The voltage on which such switches are to be operated is not the only thing to be considered, the kilowatt capacity behind the switch when it is opening the circuit under short-circuit conditions being one of the main things to be taken into account; that is, switches leading from the main station bus must be of such design that they will open connections to a short-circuited feeder when backed up by the full overload capacity of all generators that can be connected to the bus at one time. From the above we can see that the ultimate capacity of the station must be considered when selecting the oil switches to be used. On account of the high momentary overload capacities being specified on turbine units the switches, as well as other parts of the plant, must be designated to take care of these high overload capacities.

The matter of whether there shall be one or two buses in a station is one on which there is a great diversity of opinion. Some claim that the installation of two buses needlessly complicates the station layout and renders trouble and shutdowns more liable; others claim that, although two buses do complicate the station somewhat and render first cost higher, such duplication of buses gives them a greater flexibility of operation which more than offsets the added complication of the plant and extra first cost.

With the buses at top and back of switchboard the wire runs to switches will be short and simple. From the switches wires can be carried on porcelain insulators and iron pins supported on iron pipe work to a suitable point where they will go up through the floor to feeder regulators, lightning arresters and wire tower. The feeder regulators would be operated by means of chain and sprocket wheels from hand wheels on the switchboard. If there is room to do so the station buses should have sectionalizing switches somewhere near their middle points so that one half of the bus could be killed and the other half kept alive; the use of sectionalizing switches at various points in the plant will facilitate greatly the work of any necessary repairs or changes.

On account of the voltage all switchboard instruments would be operated by means of current and potential transformers; the potential transformers stepping the voltage down to 110 volts for voltmeters and wattmeters and current transformers would all be of such ratio that full scale deflection would be obtained on ammeters with five amperes flowing in transformer secondaries. This protects the switchboard attendant from coming in contact with high voltage and renders the switchboard wiring very much more simple. The design of the station would include all the necessary instruments for getting the instantaneous load on generators and circuits and for recording the kilowatts generated and output to the various feeders.

There would be two exciters for the plant; one motor-driven for regular operation and a steam-driven unit for starting the plant and for use when the motor-driven unit is out of commission for any reason. These exciters should be designated to operate in multiple when being controlled by the bus voltage regulator.

\*Abstract of paper presented before the Northwestern Electric Association, Milwaukee, Wis., January 16, 1907.

**A COMPARISON OF SUBSTRUCTURES FOR TRACKS IN STREETS.**

BY H. L. WEBER, CHIEF ENGINEER FT. WAYNE & WABASH VALLEY TRACTION COMPANY.

Until the last few years the low cost of wood ties made it possible to meet at a comparatively small expense the severe conditions imposed on the track substructure by the heavier types of rolling stock. With the steady increase in the cost, ties now costing about \$1.00 each, f. o. b., it has become necessary to find a substitute which will have a longer life and cost less. That portion of the track, therefore, which performs the function of transmitting the load from the rails to the subgrade must, by reason of this consideration alone, receive the serious attention of those who have this department of a railway in charge.

**Good Track.**

Increasing the weight of the rail sections will help, but it will not fully meet the requirements. For all track foundations must be provided, and only a permanent way will meet

and foundation are to be considered in the order just mentioned when determining what duties the ties will have to perform. In a permanent way, where the tie and foundation are integral, they may be considered first.

In one locality a certain type of construction will afford a permanent foundation, and show a great saving in cost over any others, while in another locality, on account of various conditions, this same construction may be an absolute failure. Many failures of concrete girders for supporting track rails have been due to adverse subgrade conditions, such as a wet, poorly drained subgrade, the presence of quicksand, or of a soft, spongy soil. Wherever subgrades of this character are encountered a sheet foundation of concrete with ample drainage and plenty of bearing surface should be used to support the permanent way.

**Using Old Boulder Paving.**

In the early days of the horse car many tracks were paved with boulders. Today these stones are found to be as good as when they were first laid. They may not have been worth much when laid, and their value has not increased with age, but they were the best form of paving that could then be had.

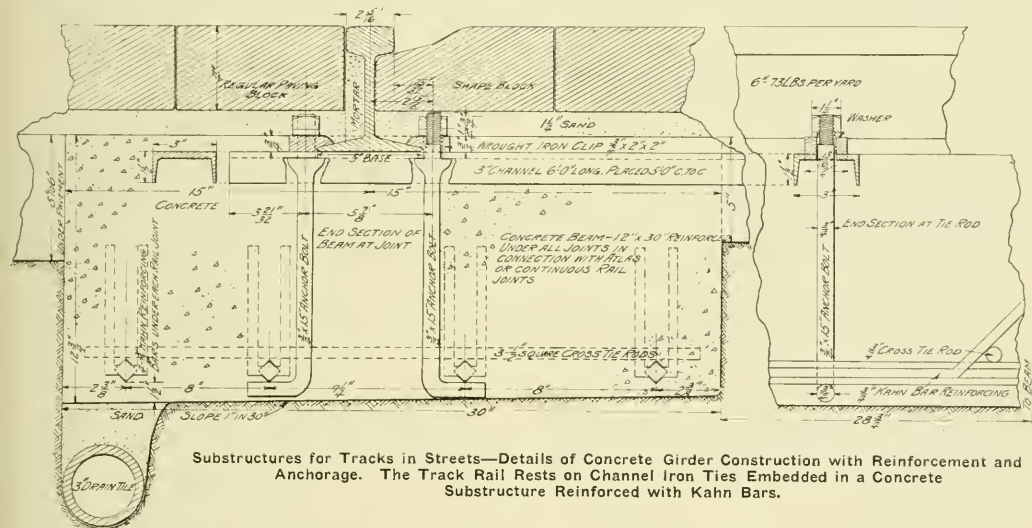

**Substructures for Tracks in Streets—Details of Concrete Girder Construction with Reinforcement and Anchorage. The Track Rail Rests on Channel Iron Ties Embedded in a Concrete Substructure Reinforced with Kahn Bars.**

the demands, provided, of course, that in the end a financial saving is effected. This saving in money may, perhaps, not be obtained in the track alone. There is still to be reckoned the comparative effect on the patrons' nerves. If a passenger can ride over the road without being jarred into a state of nervousness, then it is safe to assume that the roadbed has been well built. Nerves, therefore, as well as the obvious saving to rolling stock by attention to track conditions, are assets that all companies should rate liberally.

Convenient service, the maintaining of regular schedules, the proper handling of the car by the motorman around curves, over switches and special work—all help to increase the value of a road to its patrons and are dependent in great measure on a well-kept roadbed. This factor of the railroad problem thus warrants much study.

**Foundation.**

The selection of too heavy a rail section is poor economy when it brings about a reduction in the quality of the ties and the foundation. My experience has been that consideration should first be given to the tie, second to the foundation, and last of all to the rail. As a matter of fact, the load, rail, tie

When heavy equipment makes it necessary to reconstruct these old tracks a very good rubble-concrete foundation may be made from these old boulders. In some instances this old material has amounted to 25 or 33 per cent of the aggregate. If it is used in the track foundation it need not be hauled away and it also saves hauling new material, thereby halving the cost of the concrete. If the work is properly done the results are very satisfactory. As an example, the East Washington street paving in Ft. Wayne, Ind., as illustrated herewith, which thus constructed cost but \$3.07 per cubic yard, as against \$5.50, which would have been the cost had the old material not been used.

**Reliance on Concrete.**

It generally lies with the engineer to determine how he can utilize what is furnished him. He is governed by conditions and cannot follow out a theory. Each job has its governing factors, which must receive due consideration.

In either the concrete beam or sheet concrete types of foundation reliance must be placed on the concrete to support the rails and their loads. In my opinion it is practicable to rely on the concrete also to hold the rails in position if

anchor bolts are used, as illustrated, and properly designed fittings, including joints such as the Atlas or Continuous, with or without reinforcement under the joints, as the conditions may demand. In one of the illustrations a method is shown for placing Kahn reinforcing bars in the concrete girder under each joint.

**Cost of Construction.**

With these ideas in mind I offer the accompanying track schemes as suggestions. Estimates of the cost are shown. In constructing a foundation according to either plan the subgrade is first prepared, the drainage arranged, the track assembled and placed to the proper grade and line before the concrete foundation is put in place. The costs shown are for a single track, exclusive of rails, rail joints, bolts and bonds.

**Concrete Beam Construction.**

In this concrete beam track there are required as fittings channel iron cross-ties weighing five pounds per foot, with anchor bolts and clips on 5-foot centers, and tieplates spaced

structure, exclusive of rail, joints, bolts and bonds:

	Per lineal foot.
Taking up and relaying track to line and grade, wood ties, 30-inch centers, and spikes .....	\$0.42
Excavation .....	.72
Concrete foundation, \$3.07 per cubic yard.....	.74
Brick paving .....	.88
<b>Total cost .....</b>	<b>\$2.76</b>

**Rubble Concrete and Carnegie Ties.**

If Carnegie steel ties or old steel rails for ties had been used in place of wood, and the other details not been changed, the cost would have been as follows:

	Per lineal foot.
Tracklaying, including ties, necessary fastenings and labor .....	\$0.60
Excavation, 18 inches deep .....	.19
Concrete, \$3.07 per cubic yard.....	.74
Brick paving .....	.88
<b>Total cost .....</b>	<b>\$2.31</b>

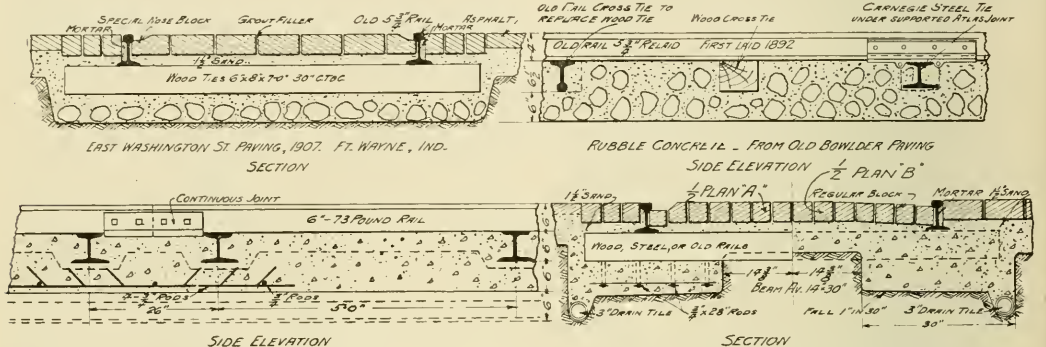

Substructures for Tracks in Streets—Sections Above Showing Rails, Wood and Carnegie Steel; Sections Below Showing Beam Construction with Kahn Reinforcement Under Joint and Drainage.

midway between ties with anchor bolts and clips, thus spacing the anchorages on 2½-foot centers. The costs in detail are:

	Per lineal foot.
Ties, anchor bolts, clips and tieplates (as above).....	\$0.55
Excavation for track 18 inches deep.....	.47
Concrete .....	1.35
Brick paving .....	.88
<b>Total cost .....</b>	<b>\$2.95</b>

**Carnegie Steel Ties with Concrete Beams.**

To lay the single track with Carnegie steel ties weighing 14½ pounds per foot of tie, and spaced in concrete beams on 5-foot centers, the cost will be:

	Per lineal foot.
Ties, bolts, clips and joint reinforcement.....	\$0.60
Excavation .....	.22
Concrete .....	1.35
Brick paving .....	.88
<b>Total cost .....</b>	<b>\$3.05</b>

**Rubble Sheet Concrete.**

The actual cost of rubble sheet concrete on the East Washington street improvement in Ft. Wayne will next be given. This piece of track was relaid with the old 5¼-inch steel that had been in service on this street for 14 years. The rails were reversed, placing the outside of the rail heads to the gauge side. The base was so badly eaten away with rust that it was necessary to place the ties on 30-inch centers. The excavation was exceedingly deep, ranging from 18 inches to 48 inches. The following statement gives the cost for con-

struction of the accompanying track sections will show three plans for laying bricks between the rails:

Plan A, of which a half section is shown, requires a special block with the corner clipped off. The brick next the rails is laid on its side under the ball. Against it is the special block, and this in turn is followed by the regular blocks in their order.

Plan B requires none but the regular blocks. Both plans contemplate laying the blocks parallel with the rails.

The East Washington street track earlier referred to was laid, as shown in the illustration, with the Weber nose block manufactured by the Metropolitan Paving Brick Company of Canton, O. This style of paving has proved to be popular with the city engineers and very satisfactory to the traveling public. By its use street railroad companies can make and maintain a very neat appearing street and one which will meet with the general approval of city authorities in connection with the T-rail.

The improvements completed by the Northern Texas Traction Company of Ft. Worth, Tex., during the year 1907, according to a statement given out by the company, include the enlargement of the substation located near the city limits, the erection of a portable substation for the Ft. Worth-Dallas interurban line and an additional exciter in the power station. Contracts were let for a new engine and generator and a new system of coal handling apparatus was installed. A large amount of city track extensions was completed and several lines were relaid with heavier rails.



INDIANA ENGINEERING SOCIETY ANNUAL CONVENTION.

The Indiana Engineering Society held its twenty-eighth annual convention at Indianapolis on January 16, 17 and 18. This society is composed of engineers of the various classes and heads of engineering departments in Purdue University and other colleges of the state. There are now about 75 members, 9 new members being admitted during the year.

A report of the committee on electric railways was read by Robert P. Woods, chairman, Indianapolis. An abstract of this report follows:

Report of the Committee on Electric Railways.

The state of Indiana may take just pride in her interurban railways. The substantial character of the construction, the excellent operating service given and the large increase warrant it. The greater the mileage the more people benefited. On January 1, 1908, there were in Indiana 30 separate systems in operation, with a total mileage, exclusive of city street car lines, of 1,539. The smallest, the French Lick & West Baden Railway, is but 1.09 miles long, while the largest, the Terre Haute Indianapolis & Eastern Traction Company, has 351.40 miles of road. During the last four years 835 miles of lines have been built. The following new mileage, classified as to method of power distribution, was constructed during the last year:

Three-Phase Alternating-Current-Direct-Current Systems.

	Miles.
Evansville & Eastern Electric Company—Newburg to Rockport .....	21.00
Ft. Wayne & Wabash Valley Traction Company—Logansport to Lafayette .....	38.10
Indianapolis Columbus & Southern—Columbus to Seymour .....	23.35
Indianapolis Crawfordsville & Western Traction Company—Indianapolis to Crawfordsville .....	45.00
Terre Haute Indianapolis & Eastern Traction Company—Plainfield to Harmony .....	39.31
St. Marys to Illinois state line .....	6.00
Winona Interurban Railway Company—Peru to Chili .....	9.21

Single-Phase Alternating-Current System.

	Miles.
Ft. Wayne & Springfield Railroad—Ft. Wayne to Decatur .....	21.50
Indianapolis & Cincinnati Traction Company—Shelbyville to Greensburg .....	21.07
Toledo & Chicago Interurban Railway Company—Garrett to Kendallville .....	12.00
Auburn to Waterloo .....	6.00

Direct-Current System (600-Volt).

	Miles.
Louisville & Northern Railway & Light Company—Watson to Sellersburg .....	4.15

Direct-Current System (1,200-Volt).

	Miles.
Indianapolis & Louisville Traction Company—Seymour to Sellersburg .....	40.92
Total .....	286.71

It is safe to state that the record for 1907 will not be beaten for some time to come. Should the 41 miles between Crawfordsville and Danville, Ill., be constructed, Indianapolis will then be connected by interurban lines with St. Louis, Mo., a distance of 300 miles, via Danville, Champaign, Decatur and Springfield. It seems likely that the short gaps connecting Indianapolis with Buffalo, N. Y., via Cleveland, will be closed before another year. Through service between Indianapolis and Louisville was inaugurated November 6, 1907.

Mention should be made of the new electrical equipment of the Ft. Wayne & Wabash Valley Traction Company at the Spy Run power station, which was put in operation in March, 1907. This consisted of five 1,500-kilowatt, one 500-kilowatt and one 400-kilowatt Westinghouse turbines. From this station power for electric car service is transmitted to Lafayette, 114.10 miles distant.

Mergers.

In March, 1907, the Terre Haute Indianapolis & Eastern Traction Company was incorporated. It absorbed the Terre Haute and Brazil city lines and light properties and 10 interurban lines, to wit: The Indianapolis & Northwestern Traction Company, Indianapolis & Western Traction Company, Indianapolis Coal Traction Company, Indianapolis & Martins-

ville Traction Company, Indianapolis & Eastern Traction Company, Richmond Street & Interurban Company, Terre Haute & Clinton Traction Company, Terre Haute & Harmony Traction line, Terre Haute & Paris line and Terre Haute & Sullivan line, an aggregate of 351.40 miles of interurban railways.

Traffic.

There are now 11 interurban lines entering Indianapolis. During the year a total of 99,242 passenger car round trips were made by these roads. Probably upward of 5,500,000 people were carried.

The express and freight business is showing a marked increase. Probably 12 to 15 per cent of the general gross earnings of interurbans are from this class of service. The express branch is attracting the attention of the steam road express companies. On September 17, 1907, the United States Express Company began a regular express car run out of Indianapolis to Lafayette, via Lebanon, and from Lafayette east to Ft. Wayne.

Legislation.

The last Indiana legislature gave the state railroad commissioners broad jurisdiction over the interurban railways and their activity in this direction, as shown in 1907, will be beneficial to the traveling public. They have ordered the attorney-general to file suit against an interurban company for the alleged violation of the new safety appliance law, and have sent warning notices of the penalty attached for failure on part of motormen to signal at grade crossings and failure on part of traction companies to keep crossings in proper repair.

Outside of Indiana the general character of interurban development has been along lines similar to our own.

The increasing demand for reliable scientific data on matters pertaining to the technical side of electrical railway operation prompts a leading technical journal to suggest that investigations and tests ought to be made covering such subjects as train movements, studies of trucks, brakes, energy consumption of cars, electrical characteristics of rails, bending moments of poles, transmission losses, energy values of fuel, ways of improving operating features, protective devices, electrolytic corrosion, and like subjects. The theme is a worthy one, but who will pay the expenses? The answer probably is, joint work by federal and state governments, technical universities, traction companies and electric railway and engineering associations. The idea is a worthy one.

Papers Presented.

An excellent paper on 1,200-volt direct-current power for electric railways was presented by J. P. Moore, Indianapolis.

Charles H. Heron, assistant engineer Indianapolis Traction Terminal Company, Indianapolis, presented a paper on "Types of Traction Cars." Mr. Heron described the many types of traction cars now in use and pointed out necessary improvements and changes, which in his opinion could be satisfactorily made. He recited the many difficulties that the manufacturers of interurban cars had to encounter, and also the provisions of the Indiana law regarding the operation of cars relative to over and under crossings. Mr. Heron exhibited a number of blue prints showing the dimensions of various types of cars and criticized the various types.

Mr. Heron's paper was followed by the reading of a paper on "Track Construction in Streets for Interurban Service," by Thomas B. McMath, engineer and track superintendent Indianapolis Traction & Terminal Company. The author described the method of construction of the city lines of Indianapolis, which he stated were carrying more interurban cars than any other system in the country.

An interesting report was made by the committee on "Materials of Construction." This report called attention to the fact that electric railway companies are using vast amounts of cement and concrete in the construction of tracks, bridges, viaducts, etc. Several interesting lectures were illustrated by lantern slides, showing the tests of reinforced concrete in the multiplying positions in which it is now being used.

Prof. G. A. Young, Purdue University, gave an interesting illustrated lecture on gas engines and gas producers.

"Smoke Abatement" was a subject that was given considerable attention and the methods of employing mechanical stokers were described. This question is of interest to the

managers of the various electric railway power houses, because of city ordinances with a view to smoke abatement.

At the closing session Prof. W. K. Hatt, professor civil engineering Purdue University, was re-elected president; Charles C. Brown, editor Municipal Engineering, vice-president; and J. S. Brossman, mechanical engineer, Indianapolis, secretary.

#### TWO-CENT STEAM RAILWAY FARES AND INTERURBAN ELECTRIC RAILWAY TRAFFIC.

Since the publication in the Electric Railway Review of last week of a number of interesting letters concerning the effect of 2-cent steam railway fares on interurban electric railway traffic the following additional communications have been received:

##### Eastern Wisconsin Railway & Light Company.

N. C. Draper, vice-president and general manager Eastern Wisconsin Railway & Light Company, Fond du Lac, Wis.: "A strictly modern electric railway, with a run of not exceeding four hours, need not fear competition with any steam railway, even should the rates of fare be the same on both lines."

##### Benton Harbor-St. Joe Railway & Light Company.

H. C. Mason, general manager Benton Harbor-St. Joe Railway & Light Company, Benton Harbor, Mich.: "Changes in steam railway fares have not affected our traffic or our rates of fare."

##### Columbus Magnetic Springs & Northern Railway.

H. E. Buck, general manager Columbus Magnetic Springs & Northern Railway, Delaware, O.: "The adoption of 2-cents-per-mile fares by steam railways has affected the traffic of electric railways; but I believe that such fares have not caused changes in interurban electric railway fares. We receive 2-cents-per-mile fares on our 19-mile road."

##### West Penn Railways Company.

G. R. Folds, general manager West Penn Railways Company, Connellsville, Pa.: "Our lines operate in many instances in direct competition with steam roads which charge only 2 cents per mile and our business on all lines has ever been steadily increasing. How much greater this increase would have been had the steam road fares remained on the 3-cent basis it is difficult to estimate. Questions of speed, comfort and frequency of schedule, besides convenience of points of boarding and alighting, are very important factors in the transportation problem. Aside from this, local conditions often greatly affect a situation."

##### Northampton Traction Company, Easton, Pa.

Thomas A. H. Hay, president Northampton Traction Company, Easton, Pa.: "My opinion is that the reductions to 2 cents per mile will increase the earnings of both steam and electric railways. The people will travel on the steam road for 2 cents where they would not have gone if they had had to pay 3 or 3½ cents per mile, and, having gone from larger points to larger points, they will utilize the interurban roads to go to the smaller ones. I am speaking now of our own section, where we have hilly roads, and where our street railways and interurban roads penetrate by direct routes into the towns that the steam roads can only reach by the most circuitous routes. Steam railways cannot hope to 'compete,' as you have put it, with the electric roads, and the narrowing of the margin between steam and electric railroad fares, in the middle west, may be a matter of moment to roads there; here it is not. Besides, the one particular fundamental principle seems to be overlooked by so many, and that is, that steam roads run at infrequent and irregular intervals between towns and cities. Trolley roads run at intervals of from 10 minutes to 1 hour from 5 o'clock in the morning until after midnight, and the people learn to rely upon them. Most of the interurban roads run directly into the heart of the cities, and save either a long walk at the termini or the necessity of hiring a cab or bus to take passengers home. This last point is a matter of great moment to most people. In our own territory we can successfully compete with the steam roads, for these last two reasons. Personally, the writer is clearly of the opinion that the reduction of railroad fares will result in increased travel, both for the electric roads and the steam roads. There is only one thing that the writer fears more than anything else, and that is that ultimately the railroads themselves will electrify one or two tracks, and avoid the dust, and smoke, and cinder nuisance, which deter many passengers from going on the steam

roads, regardless of fare or time. I have been actively engaged in the business of our community for 10 years and in close personal contact with many people, and the managers of the great roads would be surprised to know how many passengers prefer the trolley, with its slow progress and small cars, to the handsome cars and fast travel of the steam road, accompanied as they are by soot, dust and sulphurous fumes, which are generally connected with the burning of coal. The electrification of the steam roads is the only thing that trolley roads need ever fear."

##### Grand Rapids Holland & Chicago Railway.

Charles A. Floyd, general passenger and freight agent Grand Rapids Holland & Chicago Railway, Grand Rapids, Mich.: "Judging from the experiences of several Michigan roads the 2-cent fare law has caused the steam railroads to raise their low competing rates to a straight 2-cent fare basis. The competing rate of fare on the steam railroad between the two principal points of this line was 35 cents, as against our 50 cents. On September 28 last the steam railroad rate was raised to 50 cents. However, in cases where the steam railroads have reduced their rates to comply with 2-cent laws, it cannot help but affect the electric railway business. Still, this will not be serious, as the frequent service offered by the electric lines and the fact that interurban cars take the passengers from their homes directly to the very doors they wish to reach, are features most attractive and popular."

##### Michigan United Railways Company.

J. M. Bramlette, general manager Michigan United Railways, Jackson, Mich.: "I cannot see, to the present time, that the recent reduction of steam railroad fares to two cents per mile has affected us in the least."

##### York Railways Company.

David Young, Jr., general manager York (Pa.) Railways Company: "In my opinion the 2-cents-per-mile fare law does not affect in any way the receipts of competing trolley lines. The only advantage that steam railroads have over electric lines is in the use of commutation tickets, which in many cases cost an average of only a little over one-half of 1 cent per mile. The railroad companies are able to make this low rate by merely adding cars for certain stops which would have to be made anyway, while the electric lines, unless multiple control is used, have to send out a crew with each car."

##### Scioto Valley Traction Company.

Frank A. Davis, president and general manager Scioto Valley Traction Company, Columbus, O.: "I do not think the adoption of the 2-cents-per-mile fare by steam railroads has affected the traffic of this company to any appreciable extent, and the passage of the 2-cent fare bill has not caused us, in any way, to change our passenger tariff. This road, however, is possibly situated differently from most electric railroads, in that we operate with a third rail, and plenty of power, and maintain pretty fair schedules, our time between terminals on both divisions being substantially the same as is made by the competing steam roads. On one division we have as a competitor the Hocking Valley Railroad Company. Shortly after we went into operation this company reduced its fares between competitive points to substantially one and one-fifth cents per mile, and has been operating on that basis for something over two years. We seem, however, to be able to hold the business, even against this extremely low rate, and are carrying not less than 75 per cent of the local business on this line, on a tariff of 2 cents per mile one way, with a reduction of 10 per cent on round-trip tickets. I have no positive knowledge, but I have been informed that the 2-cent law did seriously affect the earnings of some of the electric railroads which are operating on slower schedules, and I believe some of the roads in this locality did reduce their fares to some extent after the passage of the 2-cent bill, although I do not think there was any material or general reduction of fares."

##### Iowa & Illinois Railway.

P. P. Crafts, general manager Iowa & Illinois Railway, Clinton, Ia.: "Regarding the effect which reduction in steam railroad fares may have on electric lines, I believe that this is a matter governed considerably by local conditions. Speaking from my personal experience, the reduction in fares has not affected either of the roads of which I am manager, and we have steam railroad competition. Generally speaking, the frequent headway and good service given by interurban roads prevent steam railroad competition, even at the same rate of fare, from having any great effect upon the business, admitting, of course, good service on the part of the interurban road."

## STEAM NOTES ON A TURBINE PLANT.\*

BY J. L. HECHT.

In order to confine ourselves to certain definite limits we shall assume that the steam turbine plant in question shall contain 500-kilowatt and 1,000-kilowatt turbo-alternators of the vertical shaft Curtis type. We shall not confine ourselves to either the design or to the operation of this plant but shall try to point out the effect of a few details of design on the operation of such a plant.

**Superheating.**

The type of turbine engines being assumed, let us direct our attention, for the time being, to the boilers. Of course we want superheaters in connection with the boilers. Some may ask, Why superheat the steam? For several reasons, the principal and most easily explained one of which is that the internal friction of the steam traveling at high velocities through the turbine has a very important effect on the efficiency of the turbine and it is more or less definitely known that the internal friction in the steam varies with the per cent of moisture carried in suspension in the steam. Now, we know that ordinary dry saturated steam in expanding and doing work, as it would in expanding through a turbine, would tend to become very moist before leaving the turbine, therefore it becomes evident that the proper degree of superheat is such that the steam will be at the point of priming as it leaves the turbine. Unfortunately, however, we reach the practical limits of superheat, to wit, from 100 to 200 degrees F., long before we reach the desired degree of superheat.

In some of the earlier superheated steam installations, the usual specifications for high pressure steam piping, valves and fittings were followed, but soon trouble developed. It was found that the usual bronze valve stems, discs and seats would not stand the superheat and after some experimenting nickel steel was adopted for this work. It was observed that in a short time cast-iron fittings and even ferro-steel fittings when exposed to a temperature of more than 500 degrees F. would change in form as well as in length and the more webs and lugs there are on the fitting the greater the distortion will be. The webs instead of giving strength tend to set up unequal strains in the fittings which under the high temperature take on a permanent set, probably because of molecular action taking place in the iron. This trouble has been overcome by use of cast-steel fittings. It has frequently been stated that the objection to using superheated steam is that the superheater tubes burn out. This has not been our experience. We know of superheaters which have been in service continuously for seven years, without loosening a tube, and, in fact, in our experience we have never lost a superheater tube.

**Condensers.**

The question is very frequently asked, Why is it of advantage to use high vacuums with steam turbines when there is no advantage in having more than 27 inches of vacuum for a reciprocating engine? The reason is, that the steam does its work, in a turbine, in an entirely different manner from the way in which it does its work in a reciprocating engine. In an engine the potential or pressure energy in the steam does the work by exerting a direct pressure on the piston. In a turbine the work is done by the kinetic or velocity energy in the steam.

The kinetic energy varies directly with the mass or weight of steam, also with the square of the velocity. Now considering that the turbine nozzles or buckets, at any particular section, have a certain definite area, it is evident that the velocity will increase directly with the increase in volume of steam. Now, if we will refer to the steam tables we will find that at a vacuum of 26 inches, referred to a 30-inch barometer, one pound of steam occupies 175 cubic feet. If that vacuum is increased to 28 inches, referred to a 30-inch barometer, a pound of steam occupies 350 cubic feet, or exactly double the volume that it had at 2 inches less vacuum.

Now, since this steam must flow through a certain definite area of opening it is evident that the velocity of any certain weight of steam at 28 inches of vacuum will be double the velocity of a like weight of steam at 26 inches of vacuum. The kinetic energy is quadrupled, and after passing the 28-inch vacuum point, this increase becomes even more marked. If we increase the vacuum to 29 inches, only one inch increase in vacuum, we again nearly double the volume of the steam and again quadruple the kinetic energy.

\*Abstract of paper read before the Northwestern Electrical Association, Milwaukee, Wis., January 16, 1908.

Furthermore, in a turbine high vacuums do not produce the bad effects which they produce in reciprocating engines. In a turbine, for instance, there is not the alternate heating and cooling of the cylinder walls, since a turbine has a continuous flow. Also as the vacuum is increased we do not with turbines arrive at the question of making large cumbersome cylinders and pistons to take care of the excessive volumes which are encountered with high vacuums. Looking at the above it is also apparent that the exhaust connection from a turbine to its condenser must be very large, since with the high vacuums used in the operation of turbines, the exhaust steam has five or six times the volume that the exhaust steam from a reciprocating engine has, and this is a reason for placing condensers on steam turbines as close as possible to the exhaust chamber of the turbine.

As between the jet and the surface condenser, the choice must, to a large extent, be the same as it would be in the case of a reciprocating engine plant. If there is plenty of good fresh condensing water, we would, of course, ordinarily install a jet condenser, because of its simplicity and cheapness. On the other hand, if the condensing water available is such that it would be injurious to the boilers, we would of course install a surface condenser, so that the exhaust steam could be saved and returned to the boilers, there being only a small percentage of loss. The difficulty encountered in a reciprocating engine plant when operated with surface condensers is that the boiler feedwater finally becomes very much charged with cylinder oil, and in spite of any filters or separators in existence, must be occasionally renewed. In a steam turbine plant this difficulty is not encountered, as no cylinder oil is used in these turbines, and the exhaust steam after being condensed is practically pure water. In fact, if it were not necessary to make up a certain amount of boiler feed with impure water, the feedwater in a turbine plant operated with surface condensers would become so pure that it would probably be injurious to the boilers.

In operating a plant of this kind the internal arrangement of the condenser makes a large difference. It is easily possible to build a surface condenser so that the condensation when leaving the condenser to go to the feedwater heater will have the temperature of either the exhaust steam from the turbine or the temperature of the circulating water as it leaves the condenser. In the latter case the condensation would go to the heater at a temperature as low as 45 degrees F. in winter, while in the former case the condensation will usually have a temperature of about 90 degrees F. This is an important detail and we believe that most of the condenser manufacturers now build condensers to operate with either of the above results. Where it is possible to make the expenditure for a surface condenser, instead of a jet condenser, it is advisable to do so, with this type of plant.

**Auxiliaries.**

The question very often arises as to whether the auxiliary machinery in this type of plant should be motor driven or engine driven. After going into detail, it is evident that in nearly every instance there is not only no advantage in using motor-driven auxiliaries, but in most cases a decided disadvantage. Placing motors on all the auxiliaries necessarily limits the salable output from the generator. In case of an electrical shut-down in a plant, all the auxiliaries immediately shut down, making it not only more difficult to bring the plant back into operation, but this at times might prove disastrous to the equipment. It might be interesting to state that we recently made some calculations on the comparative cost of operating a steam-driven and a motor-driven generator for furnishing field excitation to a 3,000-kilowatt plant. The figures show that with coal at \$2.00 a ton, there would be a saving of \$200 per month in operating a steam-driven generator. The reason for this was that every pound of exhaust steam from the steam-driven generators could be used to good advantage in heating the boiler feedwater.

**Step Bearings.**

Two features of a turbine plant of this kind which are novel and have not been mentioned are the step bearing pumps and the accumulator. The vertical shaft Curtis turbine runs on a film of oil, the oil being pumped into the step bearing under a pressure varying in different sized units. It would be about 300 pounds in the sizes mentioned. The usual arrangement is to have at least two step bearing pumps, one of which would be running at all times when a turbine is in operation. The other one would have in its steam line a throttle valve controlled by the oil accumulator, the accumulator being nothing more than a vertical cylinder loaded with iron weights; this cylinder floats on a plunger which is anchored to a foundation. The plunger is cored to the bottom, where a pipe connects it to the oil pressure line. In case of any fluctuation in the steam pressure or other cause for

drop in the oil pressure, the accumulator maintains a constant pressure on the oil system for a few minutes. At the same time, if the pressure in the oil system were steadily falling, the accumulator, because of the dropping of the floating cylinder, would automatically start up the second step bearing pump through the throttle valve on the second step bearing pump controlled by the accumulator as mentioned above.

Aside from the step bearing there are three guide bearings which are also supplied with oil from the step bearing pump. All of the oil after passing through these various bearings is returned to a filter, where it is filtered, cooled and again passes to the step bearing pumps, and is thus kept circulating in a closed circuit, so that it will be seen that very little oil is lost. In the operation of a system of this kind the quality of the oil used makes a considerable difference. We have found that certain oils due to the high velocity of the turbine will emulsify. Other oils which do not emulsify may not have body enough to lubricate properly. It is not difficult to find an oil of the proper kind after it is known what the necessary viscosity, gravity, volatility, etc., of the oil are.

#### TICKET FRAUD DISCOVERED.

The arrest on Saturday, January 18, 1908, of Charles F. Tabler, H. R. Wimsatt and Andrew Leo Lucas made public a very clever scheme to defraud the Washington Railway & Electric Company of Washington, D. C. The railway companies in the District of Columbia sell six tickets for a quarter. The tickets for the Washington Railway & Electric Company are made by the Hamilton Bank Note Company of New York, of which Charles F. Tabler was superintendent of the engraving department. Wimsatt is supposed to be a stock broker and Lucas is a former conductor of the railway company. Tabler, through his position with the Bank Note company, was able to admit Wimsatt at night to the Bank Note company's plant, where they abstracted tickets to the value of several thousand dollars. These tickets were shipped to Washington to Lucas, whose business it was to dispose of them, the proceeds of the conspiracy being divided among the three men.

Information came to the office of the railway company toward the end of November that counterfeit or stolen tickets were being dealt in, and the matter was placed in the hands of Drummond's, Detective Agency of New York City, of which A. L. Drummond, formerly chief of the United States secret service, is general manager. Mr. Drummond is probably one of the best qualified detectives to handle the matter of counterfeit tickets. His personal investigation speedily convinced him that the tickets were not counterfeit but were genuine and that the source of supply must have been someone in the Hamilton Bank Note Company. Further work on the case discovered Charles F. Tabler as the connecting link between the Bank Note company and the outsiders. After that the matter was very plain sailing. Tabler, who is a resident of New York City, was arrested in Washington, where he had gone. Lucas, a resident of Washington, was also arrested there, and Wimsatt, who is a resident of Washington and New York City, was arrested in New York City.

The arrest of these men nipped in the bud a big scheme for counterfeiting the bonds of a well-known railway company. When Tabler was arrested and his house and effects searched, there were found thousands of the tickets as well as finely engraved plates and dies. During the investigation of the case the associates of Tabler and Wimsatt were found to be a complete force for the turning out of an engraved bond. These included a script engraver, a title engraver, a transfer man, a geometrical lathe man, a plate cleaner and such other men as are necessary for this class of work.

Independent of the information which the railway company had, the Hamilton Bank Note Company, through its effective system of checking its work, discovered that something was wrong with these railway tickets and at once notified the Washington Railway & Electric Company and thereafter co-operated in every way that lay in its power.

Both the railway company and the Bank Note company are determined that these men shall be punished to the full extent of the law.

#### REPORT OF THE NEW YORK PUBLIC SERVICE COMMISSION, SECOND DISTRICT.

The first annual report of the New York public service commission for the second district has been submitted to the legislature. With regard to the inspection of electric roads the report says that the commission intends to cause annual inspection of each electric railroad within its jurisdiction. A summary of the inspections made during the past six months is published with the report. The inspections made include examination of track, roadbed, bridges and other permanent structures, power houses, car barns and repair shops, methods of operation, protection of grade crossings by steam roads, train dispatching, block signals, train rules, running schedules, discipline, sufficiency of service and maintenance of equipment. The inspections show general improvement in track, roadbed and equipment of the electric roads in this district. Where practicable derailing devices have been required to be installed at grade crossings of electric and steam lines. The speed of suburban and interurban roads has in recent years added greatly to the danger at highway crossings and accidents at such crossings have materially increased. Greater consideration must be given in the future to protection of the public at crossings of this character.

The part of the report devoted to electric lines also includes consideration in detail of bridges, trestles, structures, guard rails and braces, power brakes, operation of trailer cars, single-truck cars, height of car step, vestibules, the overhead trolley and third-rail systems and high-potential or alternating-current systems. The commission is giving attention to the advisability of ordering an increase in the equipment of electric cars, especially those in high-speed service, with some form of power brakes. The subject of vestibules is also receiving attention. Some special statistics of electric roads are set forth in the report.

During the year ended June 30, 1907, the report states that the electric roads expended over \$4,982,000 for permanent additions and betterments. The cost of work completed since June 30, 1907, or now in progress, amounts to \$7,279,000. For additions to rolling stock and equipment during the year ended June 30, 1907, over \$61,224,000 was expended. Additions made since June 30, 1907, or for which contracts have been placed, amount to \$1,215,000.

Since the advent of the Grand Rapids-Muskegon Power Company into the field the Grand Rapids Grand Haven & Muskegon Railway and the Grand Rapids Holland & Chicago Railway have ceased generating their own power and have purchased it from the power company's hydroelectric plant on the Muskegon river. In regard to the new arrangement W. K. Morley, president and general manager of the Grand Rapids Grand Haven & Muskegon Railway, which has been purchasing its power since April 1, 1907, says: "Aside from the saving in cost, the experiment has proven a success. We began to purchase our current from the power company on April 1 under a purely experimental contract. We find that the uncertainties of securing coal supply, especially in the winter season, the delays occasioned by tieups on railroads, other accidents which cause delays, and last, but not least, the uncertain price of coal, have all been overcome by the new arrangement. Then there is the liability of disablement of the generating plant, and other accidents which cause delay in service are overcome. Our power house and generating plant have been leased to the power company, the machinery is kept in readiness to start to forestall any possible delay and they have matters arranged so that a tieup from any reason is almost an impossibility."

# News of the Week

## The Cleveland Situation.

The Ohio supreme court, in a suit brought by a taxpayer of Cleveland against the Forest City Railway Company, upheld the validity of the 3-cent fare franchise in Dennison avenue from Twenty-fifth street to Lorain avenue. As this is the basic franchise of the low-fare line, the succeeding franchises being regarded as extensions of the original grant, this decision is regarded as a great victory for the low-fare interests and Mayor Johnson. The mayor and F. H. Goff have continued throughout the past week their negotiations in the effort to determine a valuation of the Cleveland Electric property. The principal questions discussed have been the value of paving and the amount of overhead charges to be included. The two men differ widely, not only in their total estimates, but also in their methods of attaining the final estimates. Meetings have been held twice a day, but no important developments have been reported.

## Association Meetings in New York.

F. W. Simmons, president of the American Street and Interurban Railway Engineering Association, has called a meeting of the executive committee of that association, to be held at the Engineering Societies building, New York City, on Wednesday, January 29.

A meeting of representatives of the member companies of the American Street and Interurban Railway Association will be held at the Engineering Societies building on Thursday, January 30, as previously announced, for the purpose of organizing a fourth affiliated association, to which is to be committed lines of work pertaining to transportation, traffic and general operation.

The annual meeting of the executive committee of the American association will be held on the following day, January 31, and it is desired to have the organization of the transportation association completed so that it may be ratified by the executive committee.

A meeting of the executive committee of the Accountants' association has also been announced to be held on February 1.

## Legislation Affecting Electric Railways.

**Virginia.**—A bill has been introduced into the state senate to repeal the law which prohibits the building of any railroad parallel to the line of the Richmond Fredericksburg & Potomac Railroad. The bill is introduced in the interests of the Fredericksburg & Southern Railway, which has applied for a charter to build an electric line which would parallel the steam road. The latter is owned partly by the state.

**New York.**—Senator McManus has introduced a bill into the legislature providing for a 5-cent fare from New York City to Coney Island. He has also introduced a bill to secure reduced fares for workmen going to or coming from their places of employment, by providing that a person boarding subway, elevated or surface cars between 5 and 9 a. m. and between 5 and 9 p. m. shall, upon payment of a 5-cent fare, receive a return trip ticket.

**Massachusetts.**—Two bills introduced into the legislature aim to place the regulation of heating and ventilation of street cars in the hands of the state railroad commission instead of the police. One of the bills imposes a fine of \$25 per car for each trip while the car is not properly heated.—House bill No. 224 extends employees' rights to compensation or action against the employer for injuries received through the negligence of a person in the service of the employer to cases involving street railway cars and elevated railway cars and trains, instead of being restricted as heretofore to steam railroads.—Senate bill No. 53 gives persons whose property abuts on an electric railroad location in a private way or across private land, or on premises purchased for the purposes of such location, the same right to collect damages as persons now have where their property abuts on a public way taken for an elevated railroad location. It also makes the same provisions apply to an embankment as well as to an elevated structure.—A bill to allow street railways to charge admission fees to parks and recreation grounds owned by them is offered on petition of Bentley W. Warren, attorney for the Boston & Northern, Old Colony and several other street railways.—House bill No. 75 authorizes the state highway commission to require overhead electric wires and conductors to be placed underground in conduits, the work to be done in all Massachusetts cities and towns of 25,000 inhabitants or more by January 1, 1912, and in all other cities and towns of the state by January 1, 1914.—Of several bills changing the organization of procedure of the Massachusetts railroad commission,

one offered by E. Moody Boynton would abolish the commission and establish a railroad court, with chief justice at \$7,500, two assistant justices at \$5,000 each, and two inspectors at \$2,500 each. Another bill makes it the duty of the board to give hearings in the cities or towns where cases arise, instead of only at their offices; but allows such hearings to be given by one member. A third bill provides for the election of the members of the board by the general court, for terms of three years, and the expenses to be paid from the state treasury instead of by assessment on the railroad and railway companies. Another bill gives the supreme or superior court jurisdiction in equity to review, annul, modify or amend orders, rules and regulations or the rulings of any state board or commission relative to street railway companies, both as to law and facts. Still another gives the railroad commissioners authority to revise, annul, modify or amend in accord with public interests all orders, rules and regulations relating to street railway companies made by local boards of aldermen or selectmen.—A bill to compel street railway companies to equip end doors of surface cars with dark curtains is offered by Representative Kenney of Taunton.—Bills introduced on the petition of President William A. Bancroft of the Boston Elevated Railway provide for giving that company common carrier rights in the handling of baggage, express and freight, and for allowing it to purchase or acquire other street railway or electric railroad corporations. It is suggested that this latter bill looks to the acquisition of the Boston & Providence Electric Railroad, now projected by Stone & Webster.

## Supreme Court Denies Petition for Appeal from Chicago Union Traction Reorganization Plan.

What is believed to be the last obstacle in the way of the reorganization of the Chicago Union Traction Company by the Chicago Railways Company was removed on Thursday of this week when the United States supreme court denied the petition of Charles H. Aldrich and Henry Crawford for an appeal from the order of Judge Grosscup approving the plan of reorganization. The attorneys, who represented the minority stockholders of the West Chicago Street Railroad, protested against the order of the court for a lease of the Union Traction properties to the Chicago Railways Company for a short term, pending the actual sale of the property. The supreme court dismissed the petition on the ground that no constitutional questions had been infringed upon by the city ordinance authorizing the sale of the traction properties to the Chicago Railways Company or steps taken thereunder, and consequently it had no jurisdiction.

On Saturday of this week the properties of the Chicago Union Traction Company will be sold at public auction under the decree of foreclosure. The Chicago Railways Company is expected to be the only bidder. The plan is that immediately after the sale the receivers will turn over the properties to the Railways company, making a short-term lease for the purpose if necessary. The Railways company will at once take possession and operate the lines, notifying the city that it is in undisturbed possession of the property, as required by the franchise ordinance of February 11, 1907, and that it accepts the ordinance. The new securities of the Chicago Railways Company will then be issued in exchange for the old ones and the work of rehabilitating the property in accordance with the provisions of the ordinance will be taken up as rapidly as physical conditions will admit. The universal transfer system will go into effect as soon as the company accepts the ordinance. Transfers will be exchanged between the Chicago City Railway and the Chicago Railways companies at all intersecting points except those north of Twelfth street in the business district. The through routes provided by the ordinance will be established as soon as the board of supervising engineers can make arrangements for them. This will depend chiefly upon the progress of the work of reconstruction, as many of the north side lines are not in a suitable condition for the operation of the heavy cars of the Chicago City Railway.

## Hearing on New York Rapid Transit Law.

The New York public service commission of the first district held a public meeting on Friday, January 17, for the purpose of hearing suggestions as to amendments to the rapid transit law which would make contracts for the construction and operation of additional subways more attractive to private capital. The commission is now nearly ready to advertise bids for the Brooklyn Fourth avenue route and the Broadway-Lexington route, but, remembering its experience of last spring, when no bidders were found for the Lexington avenue subway, is apprehensive lest the same condition be found to exist in regard to the new proposed routes.

Practically every civic organization of the city was represented. The sentiments expressed were almost unanimously in favor of subway construction by the city and an extension of the leasing terms, limited by the Elsberg law

to 20 years with a provision of renewal for 20 more years. Opinion was divided, however, as to the wisdom of excluding bond issues for subway building from the restrictions of the city's debt limit.

Ex-Senator Elsberg, who was one of the speakers, stated that he was convinced that the leasing term would have to be extended to allow the contractor a profit and that under the present law private capital was not likely to invest. He and other speakers thought the commission might well be given power to determine the leasing term.

B. S. Coler, president of the borough of Brooklyn, disagreed with a statement of Comptroller Metz that the city was not financially able to build any more subways at the present time. He said the city could build subways in many directions without additional burdens on the taxpayers.

J. Edward Swanson, former president of the borough of Brooklyn, who represented the Citizens' Central Committee, favored an increase of the lease term to 35 years, with a provision for a 20-year renewal. He also suggested that the period of renewal be left to the discretion of the commission. He was not in favor of exempting certain classes of bonds from the debt limit so long as the city is controlled by a political administration.

Henry C. Wright, secretary of the City Club, said that private capital should be allowed to build subways where better results could be obtained in that way. He favored a 50-year lease.

**Fined for Failure to Comply with Schedule Required by City.**—The Winnipeg Electric Railway Company has been ordered to pay \$12,000 in fines as a result of its failure to run its cars according to the schedule passed by the city council.

**American Institute of Electrical Engineers.**—H. W. Fisher, Pittsburg, Pa., chief engineer of the Standard Underground Cable Company, will, on Friday, February 7, present to the Toledo section of the institute a paper entitled "Electric Cables."

**Louisville Railway Not Considering Pay-As-You-Enter Cars.**—In regard to newspaper reports that the Louisville Railway was about to adopt the pay-as-you-enter car, R. R. Smith, traffic manager, writes that the company has not considered adopting these cars, at least within the near future.

**McAdoo Tunnel to Open in February.**—At a meeting of the Hoboken, N. J., board of trade on January 15 William G. McAdoo, president of the Hudson & Manhattan Railroad, announced that the tunnel under the Hudson river from Hoboken to Manhattan would be opened the first week in February and that the fare from Hoboken to Thirty-third street and Sixth avenue, New York, would be five cents.

**Northwestern Electrical Association.**—At the annual meeting of the Northwestern Electrical Association, which was held in Milwaukee on January 15 and 16, as reported in last week's issue of the Electric Railway Review, the following officers were elected: President, P. H. Korst of Janesville, Wis.; first vice-president, John Wright of Antigo, Wis.; second vice-president, John S. Allen of Lake Geneva, Wis.; secretary and treasurer, Thomas R. Mercein, Milwaukee, Wis.

**American Institute of Electrical Engineers, Wisconsin Branch.**—The January meeting of the Wisconsin branch of the American Institute of Electrical Engineers was held at Madison, Wis., on January 23. W. B. Crabtree, engineering salesman of the Northern Electric Manufacturing Company, read a paper on "Hydro-Electric Development in the South from a Commercial Standpoint," which was followed by abstracts of New York papers by C. L. Byron and a general discussion.

**Power of Indiana Railroad Commission.**—Judge Vincent Carter of the Indianapolis superior court has made a ruling holding that the act creating a state railroad commission is constitutional, and that said commission has power and authority to make compulsory the interchange of traffic between steam railroads and also between steam and interurban railroads. This decision will probably settle the authority of the commission in this respect, since no appeal has been taken.

**Protest Against Elevated Loop Extension.**—A meeting of the Union Loop Protective Association was held in Chicago on Thursday of this week. A committee was appointed to appear before the city council committee on local transportation and protest against any plans of the elevated roads to lengthen the station platforms or to build tracks on two levels at the crossings at the entrances to the loop. The association is getting up a petition to protest against any further development of the loop.

**Indianapolis Viaduct Declared Unsafe.**—The Indianapolis & Cincinnati Traction Company and the Indianapolis Columbus & Southern Traction Company have been compelled to suspend freight traffic out of Indianapolis. The city engineers

have reported to the board of public works that the Virginia avenue viaduct is no longer safe for interurban traffic. Passengers using these lines are compelled to transfer at the city limits. A contract will be let as soon as possible for the repair of the viaduct.

**License Tags for St. Paul Cars.**—The St. Paul (Minn.) assembly has passed an ordinance requiring the Twin City Rapid Transit Company to pay to the city a license fee of \$10 for each car operated and to post conspicuously on the outside of each car a tag bearing the car's license number in figures not less than 4½ inches high. The company has heretofore been required to pay the \$10 license fee, but the provision for posting the number on each car is an innovation intended to remove all possibility for disputes between the company and the city in regard to the number of cars on which fees should be paid.

**Through Service Indianapolis to Terre Haute, Ind.**—The Terre Haute Indianapolis & Eastern Traction Company of Indianapolis, Ind., has announced that through passenger service between Indianapolis and Terre Haute will be established on Saturday, January 25, the link from Brazil to Greencastle having been completed. Cars will be operated on a 1-hour headway and will stop at all stations. It is proposed to establish a limited service later. The running time for the 73 miles will be 3 hours and 15 minutes. The fare will be \$1.25 for a single trip, or \$2.40 for the round trip. The fare on the steam roads, the Vandalia and the Cleveland Cincinnati Chicago & St. Louis, is \$1.44 each way. The company now has a continuous line from Paris, Ill., to the Ohio-Indiana state line.

**The Indiana Strike.**—The strike on the city lines of the Indiana Union Traction Company, which was declared on January 1 by members of the Amalgamated Association of Street and Electric Railway Employees, is still in progress officially, but seems to be dying out. The company's cars have been run on schedule time for about two weeks past, but the number of passengers is reported as very small, due to the boycott by the members of labor unions and their sympathizers. There have been no disturbances of late and at Muncie the 600 special deputy sheriffs, who were sworn in at the beginning of the strike, have been dismissed. The few strikers on the local lines at Elwood returned to work on January 17, after learning that they would not receive strike benefits for the first two weeks. It is reported that an unsuccessful attempt was made last week to ground the high-tension transmission line north of Marion.

**Pennsylvania Railroad Commission Appointed.**—Governor Stuart of Pennsylvania has appointed the members of the state railroad commission, which was created under an act passed at the last session of the legislature, to take effect on January 1, 1908. The members of the commission are as follows: Chairman, Nathaniel Ewing of Uniontown, judge of the United States district court of western Pennsylvania, to serve for five years; Charles N. Mann of Philadelphia, deputy prothonotary of the courts of Philadelphia county, to serve for four years; and John Y. Boyd of Harrisburg, a retired coal dealer, to serve for three years. The commission is composed of three members at a salary of \$8,000 a year and is authorized to appoint an attorney at a salary of \$4,000 a year, a secretary at \$4,000 and a marshal at \$2,500. It is also authorized to appoint an accountant, an inspector of railroads and an inspector of electric railroads. The principal office will be at Harrisburg.

**American Railway Insurance Company.**—Henry N. Staats, vice-president and general manager of the American Railway Insurance Company, Cleveland, O., which was formed on January 10, 1907, by 27 electric railway and power companies for the purpose of carrying their own insurance, advises us that the following new companies have joined the organization within the past three months: Albany & Hudson Railroad, Hudson, N. Y.; Fairmont & Clarksburg Traction Company, Fairmont, W. Va.; Green Bay (Wis.) Traction Company; Eastern Wisconsin Railway & Light Company, Fond du Lac, Wis.; De Kalb Sycamore & Interurban Traction Company, De Kalb, Ill.; Benton Harbor-St. Joe Railway & Light Company, Benton Harbor, Mich.; Escanaba (Mich.) Electric Street Railway; People's Traction Company, Galesburg, Ill.; Choctaw Railway & Lighting Company, McAlester, Okla.; Corning (N. Y.) Gas & Electric Company; New London Gas & Electric Company; Fulton Light Heat & Power Company; Dayton Lighting Company; Rockville Gas & Electric Company; Stanford Gas & Electric Company. As previously mentioned, the purpose of the company is to carry the companies' fire insurance at actual cost, thus avoiding the necessity of paying the high rates charged by the old-line insurance companies. The company maintains an inspection and survey bureau for the purpose of inspecting the various plants and suggesting improvements that will reduce the fire risk.

# Traffic and Transportation

## Effect of New Subway on Brooklyn Rapid Transit Lines.

J. F. Calderwood, third vice-president and general manager Brooklyn Rapid Transit Company, has made a statement concerning the effect of the first week of operation of the Brooklyn subway on the lines of the Brooklyn Rapid Transit system. Receipts, he said, had held up well. The chief changes had been in the distribution of traffic, changes which are thus far more or less confusing. There has been a midday decrease in bridge traffic and a falling off in traffic to and from South, Hamilton, Wall and Fulton ferries. On the other hand, travel in the borough in midday has kept up. A 10 per cent increase in the service on the Montague street line has been found necessary, while a decrease in surface travel on the Brooklyn bridge has been shown. In conclusion Mr. Calderwood stated:

"One thing we are sure of, that there is added comfort and convenience for the traveler, and the result of the subway will be added facility to the operation of Brooklyn lines."

## Comment on New Transfer System in New Orleans.

The New Orleans Picayune of January 16 contained a long article commenting on the new transfer system of the New Orleans (La.) Railway & Light Company, which went into effect on January 15. An abstract of this article follows:

"The conductors were furnished transfer slips for the exchanges between the lines. There are altogether in the city about 900 transfer points. The conductors reported generally that there was no trouble about the transfers, the people understanding very well what was expected of them and the conductors accommodating themselves to the new arrangement. Notices posted in the cars state that the passenger must get the transfer when paying his fare so that if he forgets it until nearly at the transfer point he will not cause confusion by asking for it. In some cases where passengers forgot to do this they were given the transfers anyway, but their attention was called to the notice posted in the car.

"William H. Renaud, secretary to the president of the company, who has been designated to look after the workings of the transfer system, said that on some of the lines he went over he did not find that the number of passengers had increased very much, and on some not at all, and that everything was working well everywhere."

## Universal Transfers in District of Columbia Discussed.

The subject of universal transfers in the District of Columbia was discussed before a committee of the house of representatives at Washington, D. C., on January 16. Gen. George H. Harries, vice-president Washington Railway & Electric Company, appeared before the committee. He said in part: "I know congress has the right to require universal transfers in the district. But is it just? Think of the tremendous expenses the railroads have to bear. However, if you will allow us to charge a flat 5-cent fare instead of selling six tickets for 25 cents, we will be willing to put a universal transfer arrangement into effect."

General Harries outlined the work that the roads have accomplished in the district, and added: "Except from the standpoint of the man who wants something for nothing, the universal transfer has no defense. As it is now, a man can ride 14 miles in the district for a fare of 4½ cents."

General Harries said that it was impossible for the companies to provide seats for every one during rush hours. To do this he said it would be necessary to triple the number of cars, and the roads could not afford to do this.

Representatives of various citizens' associations asked that extensions be permitted and urged that better service and extension of facilities were needed, instead of transfers or reductions in fares.

## Plan to Haul Freight Cars of Steam Roads in Springfield, Mass.

The Springfield (Mass.) Street Railway has been developing a plan whereby the freight cars of steam railways may be operated over the various lines of the company in Springfield, Westfield, Palmer, Ware and Chicopee, in the night and early morning hours. Under this plan, if adopted, freight cars will be run from steam railways directly to manufacturing plants, where they can be unloaded. Freight cars, after being loaded at manufacturing plants, will be hauled by the street railway company to the steam roads.

Whether application is made to the city council of Springfield for permission to maintain a general freight service over the street railway tracks at such times as will not interfere with passenger traffic will depend upon the attitude of the

public. Arrangements have already been made by the Springfield Railway with a manufacturing company located at Palmer to lay a track to its plant so that freight cars can be run between the plant and another plant owned by the same company in Worcester, Mass. Tentative plans have also been made for a freight service for plants in Brightwood which desire better freight accommodations than they now have. The United States armory at Springfield desires the accommodations which a freight system on the electric road would provide.

Henry C. Page, vice-president and general manager of the company, is quoted as follows on the subject:

"The effective working out of this big scheme would be for the advantage, not only of the street railway, but of the manufacturing plants of the city, which are put to a heavy daily expense for trucking, and of the whole community. It would enable concerns which cannot afford to expand because they cannot pay the prices for land located on railroads or near the freight houses, to go into the outskirts of the city where land is cheap. Sooner or later the little available land on railroad tracks will have been used up. Then such a scheme as is planned will be demanded. We can run railroad freight cars over our lines in the night time and in the early morning, when there is little passenger traffic and when few cars are running, and discommode the public in no way at all. We will not fight to put the scheme through. If the people want it, they can have it. If not, we will not try to force it upon them. But it is bound to come, for the experience of Providence with such a system of freight car delivery is not to be ignored. We have a right, I think, under our franchise and the statutes, to build special trolley freight cars of our own and run them; but this would mean transshipping from our cars to the factories and from our cars to the railroad, which would mean a lessening of the saving to the factories because of the additional labor cost. We have proposed to the brewery that it build and operate its own cars, and we will charge for the use of our lines and our power. We figure that we can do the transfer work of the factories economically, especially as we would be able to use our power, which lies idle during a large part of the 24 hours."

**Transfers in Pittsburg.**—A committee of the city council of Pittsburg, Pa., will endeavor to arrange for a conference with the officials of the Pittsburg Railways Company on the subject of transfers.

**Ask Owl Car Service for Toledo.**—A resolution has been introduced into the city council of Toledo, O., requiring the Toledo Railways & Light Company to operate cars on all its lines from midnight until 5 a. m.

**Transfers in New York.**—Officials of the New York City Railway are quoted as stating that transfers will be given to Ft. George for the present subject to a general decision on the question of transfers between the lines of the Third Avenue Railroad and those of the Metropolitan Street Railway. This decision will not be made until the Third Avenue receivership is made permanent.

**Limited Service Between Cincinnati and Dayton, O.**—Walter A. Draper, secretary of the Cincinnati Northern Traction Company, Cincinnati, O., writes as follows regarding the establishment of a limited service between Cincinnati and Dayton, O., by this company: "The old running time between Cincinnati and Dayton was 3 hours and 5 minutes and limited service has been put in with stops only at ticket offices, reducing the running time to 2 hours and 15 minutes, while the running time for local trains has been reduced to 2 hours and 58 minutes."

**Record Run on Inland Empire System.**—The record run of an Inland Empire system train from Colfax to Spokane, Wash., was made recently by a stock train of five cars of cattle and hogs, shipped to Spokane packers from Colfax. The train was reported in at the junction at Spokane 2 hours and 45 minutes after the conductor had given the sign at Colfax, and 3 hours from the time the last animal was driven into the cars at the Inland stockyards at Colfax the last one was out of the train at Spokane. The distance traveled was 76 miles.

**Decision on Transfer Question in Shreveport, La.**—District Judge Murf rendered a decision on January 15, making perpetual an injunction restraining the city of Shreveport from enforcing an ordinance requiring the Shreveport Traction Company to issue transfers. In declaring the ordinance unconstitutional, Judge Murf said that the franchises of the company were in the nature of contracts and had no provision requiring transfers, and while the city may have been unwise in granting such franchises, that did not alter the contracts. Attorneys representing the city will appeal the case to the Louisiana supreme court.

# Construction News

## FRANCHISES.

**Acworth, Ga.**—Austyn Granville of New York and others have applied for a franchise for an electric railway which is proposed to connect Acworth, Kennesaw, Lena, Noonday, Elizabeth, Marietta, Allatoona, Barton, Hugo, Emerson and Cartersville, Ga. It is stated that a part of the tracklaying has been completed.

**Berkeley, Cal.**—The San Francisco Oakland & San Jose Railway has applied for a franchise for a new line on Sacramento street the entire length of the city.

**Bloomington, Ind.**—The city council has granted a franchise to the Grand Central Traction Company, which proposes to build from Indianapolis to Evansville, Ind.

**Cairo, Ill.**—The city council has granted a 50-year franchise to the Cairo Terminal Traction Company, which proposes to build an electric line from Cairo to Mound City, Mounds and Villa Ridge. The company is a subsidiary of the Illinois Traction System. (Noted July 6, 1907.)

**Culliacan, Mex.**—The city council has granted permission to Engineer Francis Butterfield for the construction of street railway lines in the city.

**Dallas, Tex.**—The Texas Traction Company, which is now completing its line from Sherman to Dallas, Tex., has applied for a 20-year franchise for an entrance into the city. With the application the company filed an agreement previously made with the Dallas Consolidated Electric Street Railroad and the Metropolitan Street Railway for the use of their tracks. A small additional amount of new trackage is also desired. The total trackage applied for within the city will provide adequate terminal facilities with an alternate route in case of a blockade on one line. There will be a loop in the business section east of the postoffice. It is expected to run cars into the city by May 1. (Noted January 11.)

**Enid, Okla.**—A 50-year franchise has been granted to George W. Bear for an electric line from Enid to Blackwell, Okla. It is stated that work is to be started within three months.

**Goderich, Ont.**—The by-law recently presented for passage regarding the guaranteeing of the bonds of the Ontario & West Shore Electric Railway to the extent of \$150,000, has been passed. The various guarantees now amount to \$400,000 and the company is authorized to issue bonds up to \$15,000 a mile for about 35 miles of track.

**Houston, Tex.**—David Daly, manager of the Houston Electric Company, has formally accepted the franchise granted by the commissioners of Harris county for an extension from Houston to Harrisburg.

**Mineola, N. Y.**—The New York & North Shore Traction Company has applied to the supervisors of Nassau county for a franchise to build an electric railway on the county highways from Mineola to Westbury, N. Y.

**Minden, La.**—The city council has granted a 50-year franchise to the Minden Traction Company, which proposes to build and operate an electric railway or a gasoline motor car line in the streets of Minden. It is proposed also to build an amusement park. H. A. Davis and J. B. Story are the promoters.

**Monongahela, Pa.**—The application of the Monongahela & Carroll Street Railway for a perpetual franchise in Monongahela has been denied by the city council. It is stated that an ordinance for a limited franchise will be presented at the next meeting. The company proposes to build an electric line to Bentleyville and later to Washington, Pa.

**Portland, Ore.**—The United Railways Company has applied to the city commissioners for a franchise from the city limits of Portland south on the Macadam road to the Clackamas county line. It is proposed to extend the line to Hillsboro and Forest Grove, Ore. E. E. Little, president. (Noted October 19, 1907.)

**Shelbyville, Ill.**—A 20-year franchise has been granted to the Mattoon Shelbyville Pana & Hillsboro Traction Company for the operation of its line through the main streets of Shelbyville. The line when built will form part of the proposed interurban system from Indiana to St. Louis.

**Salt Lake City, Utah.**—At a recent meeting of the board of directors of the Utah Light & Railway Company, a resolution was adopted, on the recommendation of President W. H.

Bancroft, that the franchise granted to the company on December 2 be accepted. This will mean the building of several new lines and the construction of a \$300,000 power plant at Devil's Gate, 18 miles east of Ogden.

**Washington, D. C.**—The Washington Spa Springs & Greta Electric Railway has secured a franchise within the District of Columbia for its line from H street, Washington, along the Bladensburg road to the District line, whence it will run to Bladensburg and Spa Springs, Md. It is stated that construction is to begin at once. A power house is to be erected at Beverly, Md. B. J. Stephens of Hyattsville, Md., is president; Charles D. Eldridge of Myersville, Md., is the engineer. (Noted December 14, 1907.)

**Washington, D. C.**—The bill providing for the extension of the tracks of the Anacostia & Potomac River Railroad, the Washington Railway & Electric Company, the Capital Traction Company and the City & Suburban Railway to the new union station was passed by the senate on January 20. An amendment providing for universal transfers was defeated.

## RECENT INCORPORATIONS.

**Fitzgerald & Ocella Railway & Power Company, Fitzgerald, Ga.**—Incorporated in Georgia to build an electric railway between Fitzgerald and Ocella, Ga., and also to furnish power for electric lighting and commercial purposes. Capital stock, \$50,000. Incorporators: S. T. Holzendorf, New York, N. Y.; L. C. Holzendorf, Valdosta, Ga.; C. P. Holzendorf, Atlanta, Ga.; R. I. Kirkland, Irwin county, Georgia; C. A. Holzendorf, T. M. Parsons, D. B. Jay and Clayton Jay of Fitzgerald, Ga.; and B. F. Holzendorf, Douglas, Ga.

**Red Bud & Belleville Interurban Railway, Red Bud, Ill.**—Incorporated in Illinois to construct an interurban railway from Red Bud in Randolph county, through Monroe and St. Clair counties to Smithton, Ill. Capital stock, \$2,000. Incorporators: Conrad Becker, Charles C. Smith, Herman Schryver, Red Bud; John Keller, Hecker, Ill.; B. A. Gundlach, Belleville, Ill.

## TRACK AND ROADWAY.

**Boston (Mass.) Elevated Railway.**—A bill has been introduced into the Massachusetts legislature to give this company permission for an extension from its present terminus at Sullivan square, Boston, to Medford.

**Central Crawford Traction Company, Guys Mills, Pa.**—This company has been organized by about 100 representative farmers of Crawford county, Pennsylvania, for the purpose of building or securing the building of an electric line railway from Long's Stand, four miles east of Meadville, to Clapville, a distance of 20 miles, thus completing a connection between Meadville and Titusville. A committee of six was appointed to secure the right of way, which it is believed will be readily donated. It is then proposed to tender the right of way to some company that will build the line. If no such company is found the Central Crawford Traction Company will build the line. Two separate companies two years ago proposed to build a line over this route, but although a small amount of grading was completed the projects were abandoned. Dennis Smith is president and Joseph H. Heard secretary-treasurer.

**Central Texas Traction Company, Corsicana, Tex.**—The stockholders of this company have voted an increase of capital stock and have completed the plans for beginning construction of the proposed electric railway from Corsicana to Palestine, Tex., 52 miles. Work was started on the line several months ago, but was suspended on account of a defect in a franchise. M. P. Taret, chief engineer. (Noted June 22, 1907.)

**Columbus, Miss.**—It is announced that David J. Parsons is making estimates and preparing plans for a street railway and electric lighting plant. He wishes to hear from manufacturers of all kinds of electric supplies and equipment for the power plant, railway and shops.

**Elyria Southern Railway.**—This company proposes to begin construction this spring on its line from Elyria to Columbus, O., by way of La Grange, Spencer, West Salem, Ashland and Mansfield. A power house and repair shops are to be built at Elyria. The officers of the company are as follows: Sumner B. Day, Lorain County Bank, Elyria, president; Frank H. Foster, Elyria, vice-president; W. E. Elliott, Elyria, vice-president and general manager; W. E. Moser, Elyria, secretary; J. M. Starr, La Grange, treasurer; G. A. Kagron, Elyria, engineer.

**Guelph Radial Railway, Guelph, Ont.**—This company soon will apply to the Ontario legislature for an amended act of incorporation allowing it further time in which to complete the construction of several authorized branch lines, and to increase the capital stock. The road is owned by the city of Guelph.



**Georgia Railroad, Columbus, Ga.**—This company is reported to be making surveys for an electric railway from Columbus north along the Chattahoochee river to West Point, Ga., 34 miles. F. E. Reidhead is manager.

**Illinois Traction System, Champaign, Ill.**—This company has officially accepted the 50-year franchise recently granted by the city council of Ottawa, Ill., for the Chicago Ottawa & Peoria Railway, which is to build the company's line to Chicago. According to an agreement with the cities of Peoria and Ottawa work must be started on the line between these cities by March 1 and at least \$100,000 must be expended during the year. It is stated that rails and other material have been ordered.

**Intermountain Railway, Denver, Colo.**—This company, which is to electrify the line of the old Denver & Intermountain Railroad from Denver to Lakewood and Golden, Colo., is now distributing poles along the right of way. It is stated that electric cars will be run into Golden by June 1. (Noted November 23, 1907.)

**Kalamazoo Elkhart & South Bend Traction Railroad, South Bend, Ind.**—John M. Caulfield, first vice-president, writes that this company has secured all of the right of way and franchises for an electric line to connect the cities named in the title, a distance of 73 miles. The private right of way is 50 to 100 feet wide. Surveys, maps, profiles and estimates have been completed. The company is in a position to furnish 25 per cent of the cost of construction and equipment and to begin work within 30 days after the road is financed. The following officers were elected at a meeting on January 8: President, A. D. Harris; first vice-president, J. M. Caulfield; second vice-president, H. C. Morgan; secretary, E. C. Vincent; treasurer, A. Hunsberger; auditor, J. A. Bowman; attorney, F. E. Lambert.

**Kingston (N. Y.) Consolidated Railroad Company.**—This company is reconstructing its lines with 90-pound T-rails.

**Lake Shore Electric Railway, Cleveland, O.**—This company is reported to be securing renewals of options for a private right of way between Fremont and Genoa, O., paralleling the Lake Shore & Michigan Southern Railway.

**Lake View Traction Company, Memphis, Tenn.**—H. E. Craft, vice-president of the Lake View Traction Company and its subsidiary, the Clarksdale Covington & Collierville Traction Company, which proposes to build a line from Memphis, Tenn., to Clarksville, Miss., is quoted as saying that the date for awarding contracts has not yet been determined but that capital has been secured. Surveys have been completed and the right of way has been secured. H. G. Ferree is chief engineer.

**Little Falls, N. Y.**—It is reported that surveys are to be started at once on a proposed electric railway from Little Falls to Tribes Hill, N. Y., 35 miles, and that New York capitalists are interested in the project.

**Massillon Wooster & Mansfield Traction Company, Cleveland, O.**—This company proposes to build an electric railway connecting Massillon, Orrville, Wooster, Ashland and Mansfield. The officers of the company are as follows: President, C. V. Hard; vice-president, M. L. Smyser; secretary, E. S. Landes; and treasurer, N. Amster. (Noted August 24, 1907.)

**Missoula-Bitter Root Traction Company, Hamilton, Mont.**—E. V. Lewis, secretary, writes that this company, incorporated in Montana to build an electric railway from Missoula to Hamilton, a distance of 47 miles, has completed surveys, but does not expect to begin active work until next fall. The route includes Florence, Stevensville and Corvallis. J. L. Humble of Corvallis is president and S. C. Finkelnberg is chief engineer. (Noted April 27, 1907.)

**Missouri Oklahoma & Gulf Railway, Muskogee, Okla.**—It is reported that this company intends to convert for electrical operation that portion of its steam road between Muskogee and Waggoner, Okla., about 15 miles, with the intention of extending this service should the experimental line prove successful. The location of a large packing plant at Falls City, midway between Waggoner and Muskogee and a suburb of the latter city, is said to have increased the necessity for service of this kind between the two cities. William Kenefick, president, Kansas City, Mo.

**New Orleans & Seashore Air Line Railway, New Orleans, La.**—This company has recently been organized for the purpose of building an electric railway from Algiers to Grand Isle, La.

**Prosser Traction Company, Prosser, Wash.**—This company, which was incorporated about a year ago to build a 10-mile electric line westward from Prosser and another 35-mile

line eastward from that city, intends to start construction work early in the spring. The first section will be built from Prosser west to Belma, nine miles, and later the extension south from Prosser to Paterson on the Columbia river will be undertaken. These lines will serve an immense wheat belt which at present is without transportation facilities other than wagon roads. When built the line will connect at Prosser with the North Coast Railroad now building from Prosser to North Yakima and Spokane, Wash. Frederick Finn, Prosser, Wash., is president. (Noted February 9, 1907.)

**St. Francois County Electric Railway, Farmington, Mo.**—This company expects to begin work at once on two 2,600-foot extensions to its city lines in Farmington.

**San Francisco Vallejo & Napa Valley Electric Railway, Napa, Cal.**—This company has formally opened for traffic its extension from Napa to St. Helena, Cal. L. J. Perry is general manager.

**Southern Colorado Power & Railway Company.**—This company, recently organized, which has purchased the Trinidad Electric Railroad, the Trinidad Light & Power Company and the Stonewall Valley Electric Railway, is now extending the Trinidad line to Cokedale, the coke camp of the American Smelting & Refining Company, and will build 30 miles of line to the coal mines at Stonewall. The company also proposes to build electric railways and power lines to all the towns in the vicinity of Trinidad. Joseph J. Henry of Denver, Colo., is interested in the company and represents a large syndicate. (Noted January 11.)

**Toronto, Can.**—It is reported that the Turbine Steamship Company of Toronto is negotiating with the Michigan Central Railway for the transfer or lease of the steam line on the west bank of the Niagara river connecting Ft. Erie with Niagara-on-the-Lake, the purpose being to electrify the line and operate it in connection with the Turbine Company's boats which ply between Niagara-on-the-Lake and Toronto.

**Windsor Essex & Lake Shore Rapid Railway, Kingsville, Ont.**—Grading has been completed on the section of this road between Kingsville and Leamington and tracklaying will be pushed with the expectation of having cars in operation between these two points in the near future. (Noted November 2, 1907.)

**Winona Interurban Railway, Winona Lake, Ind.**—It is reported that work on the projected line between Valparaiso and Fort Wayne, Ind., will be started at once. The line has been under consideration for two years and the surveys have been made.

#### POWER HOUSES AND SUBSTATIONS.

**Coney Island & Brooklyn Railroad, Brooklyn, N. Y.**—This company proposes to build during the present year six new substations. Plans for two of them have been prepared by Ford, Bacon & Davis, New York. They will be two stories in height and of fireproof brick and steel construction.

**Marquette County Gas & Electric Company, Ishpeming, Mich.**—This company has just completed a new boiler house and has added the following new equipment to its power station: One 500-kilowatt vertical Curtis turbine, one 200-kilowatt Buffalo Forge Company engine, direct connected to a 110-kilowatt direct-current generator, also a new storage battery.

**Missouri Water Light & Traction Company, Nevada, Mo.**—It is reported that this company will place contracts during the next few weeks for the installation of the following apparatus: Two 225-horsepower water-tube boilers, 600-horsepower exhaust steam heater, 600-horsepower live steam water purifier, and the necessary piping. Hiram Phillips, receiver.

**Portland Eugene & Eastern Railway, Portland, Ore.**—This company, which proposes to build an electric railway from Eugene to Springfield, Ore., has filed notice of an appropriation of 2,900 cubic feet of water per second from the McKenzie river at the point of its proposed hydro-electric power plant. A. Welch of Portland is interested. (Noted January 18.)

**Sydney & Glace Bay Railway, Sydney, Can.**—A. N. McLennan, manager, writes that this company is now building a new power house, 50 feet wide by 75 feet long. The equipment will consist of three 150-horsepower return tubular boilers and one 300-horsepower vertical engine, built by the Robb Engineering Company, Amherst, Nova Scotia, one Crocker-Wheeler 250-kilowatt railway generator, one 200-horsepower McKewan engine and one Westinghouse 150-kilowatt railway generator. As previously noted the contract for the power house has been let to Rhodes, Curry & Co. of Amherst, N. S.

## Personal Mention

Mr. B. M. Arnold, supervisor of terminals of the Illinois Traction System at Springfield, Ill., has been transferred to Decatur, Ill., as division superintendent, succeeding Mr. J. E. Mcneil, who has been transferred to Springfield to succeed Mr. Arnold.

Mr. Charles Fifer, formerly superintendent of the Salem Electric Railway at Salem, O., has resigned, effective on February 1, to accept a similar position with the Philadelphia Coatesville & Lancaster Passenger Railway at Parkersburg, Pa. He will be succeeded at Salem by Mr. Herman Gaver.

Mr. Allan L. McDermott of Jersey City, N. J., was re-elected president of the Washington (D. C.) Railway & Electric Company on January 18. Mr. William Loeb, Jr., secretary to President Roosevelt, who has frequently been mentioned as a candidate for the office of president of the company in connection with the proposed reorganization, was elected a member of the board of directors.

Mr. W. P. Bailey, formerly connected with the auditing department of the Terre Haute Indianapolis & Eastern Traction Company, has resigned to become superintendent of the Michigan City and Laporte lines of the Chicago South Bend & Northern Indiana Railway. Mr. Bailey began his street railway service as a conductor and has worked his way up through several intermediate positions.

Mr. Hugh T. Miller has resigned as secretary and treasurer of the Indianapolis Columbus & Southern Traction Company at Columbus, Ind., to devote his time to his campaign for the governorship of the state of Indiana. Mr. Ira E. Guthrie, formerly auditor of the company, was chosen to succeed Mr. Miller as secretary and treasurer, at a meeting of the directors held on January 21. Mr. Joseph I. Irwin, president, and Mr. A. A. Anderson, general manager, were re-elected.

Mr. Samuel Insull, president of the Commonwealth Edison Company of Chicago, and also president of the Louisville & Southern Indiana Traction Company and the Louisville & Northern Railway & Lighting Company, has been appointed a member of the honorary committee to represent the United States at the international exposition of electrical appliances, to be held in Marseilles, France, April 19 to October 31. Mr. Insull will represent the National Business League of America.

Mr. M. McAulay, heretofore assistant superintendent of the Detroit Monroe & Toledo Short Line Railway, has been appointed superintendent of the company, effective on January 1, as announced in our issue of January 11. Mr. McAulay was formerly with the Detroit United Railway, serving from 1901 to 1902 as car house foreman, and from 1903 to 1906 as assistant superintendent of its Orchard Lake division. On July 1, 1906, he was appointed assistant superintendent of the Detroit Monroe & Toledo Short Line, where he has since remained. His headquarters will be at Monroe as in the past.

Mr. A. G. Reynolds has been appointed chief clerk to Mr. William A. Bancroft, president of the Boston Elevated Railway. Mr. Reynolds has been connected with the Boston Elevated Railway since 1899, for six years in the maintenance of way department and for two years in President Bancroft's office. He was formerly treasurer of the Newburyport & Amesbury Horse Railroad, in charge of the electrical construction and equipment of the Toledo street railway for the Thomson-Houston Company, acting superintendent of the same road after its construction and superintendent of the East Side Street Railway, Brockton, Mass.

Mr. H. H. Polk, president and general manager of the Interurban Railway, Des Moines, Ia., announces that, effective on February 1, the existing positions of general freight agent, general passenger agent, superintendent and general roadmaster will be abolished and the following new positions created: Traffic manager, in charge of freight, passenger and industrial departments; general agent, in charge of the Des Moines station; and superintendent of track and motive power, in charge of track, buildings and equipment. The following appointments have been made: Traffic manager, Mr. R. A. Felding; general agent, Mr. J. F. Johnston; industrial agent, Mr. Geis Botsford; ticket auditor, Mr. E. B. Bieghler, heretofore superintendent; superintendent of track and motive power, Mr. F. S. Eberhart, heretofore general roadmaster.

The department of motive power and machinery of the Boston Elevated Railway has been divided into two new departments, the department of power stations and the department of rolling stock and shops. Mr. John Lindall, heretofore superintendent of motive power and machinery, has been

appointed superintendent of rolling stock and shops, with general supervision of cars and equipment, shop work and car house methods. Mr. James D. Andrew has been appointed superintendent of power stations, in charge of the maintenance and operation of power houses and substations, distribution of power, receiving of coal, etc. Both superintendents are under the charge of Mr. Paul Winsor, chief engineer of motive power and rolling stock, who reports to the vice-president. Mr. Andrew has heretofore been in charge of the power plants of the New York Edison Company.

Mr. J. E. North, whose portrait is presented herewith, has recently resigned as electrical engineer of the Ohio Electric Railway, with headquarters at Springfield, O., to accept a position with the Robbins & Myers Company, manufacturer of the "Standard" motors and generators, of Springfield.



J. E. North.

Mr. North came to Springfield in 1903 to become connected with the electrical department of the lines composing the Appleyard system, which was acquired in 1906 by the Indiana Columbus & Eastern Traction Company. Three months later he was appointed assistant electrical engineer, which position he held until May, 1906, when he was appointed chief electrical engineer of the Indiana Columbus & Eastern, which has recently been taken over by the Ohio Electric Railway Company.

Mr. Gurdon W. Wattles, whose portrait is presented herewith, was recently elected president of the Omaha & Council Bluffs Street Railway of Omaha, Neb., succeeding Mr. Guy C. Barton, resigned, as previously noted in the Electric Railway Review.

Mr. Wattles was born at Richford, N. Y., on May 12, 1855, and in 1867 removed to Carroll, Ia. He attended the Iowa State College at Ames, Ia. In 1880 he became president of the First National Bank of Carroll, Ia., and, after removing to Omaha in 1892, was successively vice-president and president of the Union National Bank. In 1898 he was president of the Trans-Mississippi and International exposition at Omaha. His street railway connection dates from 1902, when he became associated with the Omaha & Council Bluffs Street Railway as director. Since 1905 he has been vice-president of that company. He has been president of the Omaha Grain Exchange since its organization in 1904, and has been vice-president of the United States National Bank of Omaha for several years past.



Gurdon W. Wattles.

### Ask Investigation of Electric Railways.

A number of citizens' associations of the District of Columbia have jointly adopted a resolution petitioning congress to direct the bureau of corporations or the interstate commerce commission to make an investigation of the electric railways of the district with respect to their organization, capitalization, etc., and to ascertain whether legislation requiring the companies to render better service should be enacted. A second resolution petitions congress to grant authority to the district commissioners to regulate the service of the companies.

# Financial News

**Cleveland (O.) Electric Railway.**—At the annual meeting of stockholders on January 15 the directors were re-elected. The place of Charles L. Pack, who had retired, was not filled. Horace E. Andrews, the president, reported that the gross earnings for the year ended December 31, 1907, approximated \$5,700,000, a gain of \$100,000 over the previous year. After the meeting of stockholders the board organized by re-electing the old officers.

**Concord Maynard & Hudson Street Railway, Maynard, Mass.**—The Massachusetts railroad commission has approved the issue of \$25,000 additional stock by this company. The stock is to be sold at \$100 per share.

**Denver City Tramway Company.**—William G. Evans, the president, states: "For 1907 the total valuation placed by the assessor upon all taxable property within the city and county of Denver is \$118,921,855. No one can reasonably claim that the value of the property of the Denver City Tramway Company equals the one-hundredth part of all the property values in Denver. If the value of the property and franchises of the tramway company were the one-hundredth part of all the taxable values, it would in fairness be assessed at the one-hundredth part of \$118,921,855, or \$1,189,218.55. Yet the assessment upon the property of the company and of the subsidiary companies for 1907 is \$3,200,000. In addition to the general taxes and to the various amounts paid for paving and other public improvements, a payment of \$5,000 is made each month to the city treasury. From May 15, 1906, to December 31, 1907, there have been levied against the company and paid as they became due, the following amounts: Expended on account taxes, \$162,499.93; expended on account franchise payments to city of Denver, \$95,000; expended on account public improvements (which are in the nature of a tax, such as street paving, surfacing, grading in public improvement districts, donation of property to widen streets, etc., ornamental poles on Sixteenth street, etc.), \$19,808.95; total, \$277,308.88."

**Indianapolis & Louisville Traction Company, Louisville, Ky.**—On the advice of G. S. Payne, county attorney, the commissioners of Clay county at Brazil, Ind., have decided to refuse to give the \$36,000 voted to the Indianapolis & Louisville Traction Company by the taxpayers of Harrison township in 1906, as a bonus for building a branch line through that township. The commissioners took the position that the petition signed by 500 taxpayers and all the proceedings connected with the transaction were irregular and void. The county treasurer had already received \$20,000 of the total amount, and the commissioners directed that mandamus proceedings be started to prevent the county treasurer from paying this money to the traction company.

**Seattle (Wash.) Electric Company.**—Frank Dabney, the treasurer, has filed a statement with the city comptroller of Seattle, Wash., showing that gross earnings in 1907 were \$2,951,646. There was due to the city on account of the percentage tax \$57,397. Of this amount \$9,195 had been paid by deposits accompanying applications for franchises, leaving still due \$48,202. This amount was paid when the statement was filed. Most of the lines pay 2 per cent of gross earnings to the city.

**Schuylkill Railway Company, Girardville, Pa.**—Results of operations in the year 1907 were as follows: Gross receipts, \$207,034.96; operating expenses, including taxes and insurance, \$104,083.61; net receipts, \$102,951.35; interest charges, \$68,500; surplus, \$34,451.35.

**Spokane & Inland Empire Electric Railway, Spokane, Wash.**—Jay P. Graves, the president, has issued a circular letter to stockholders stating that the new power plant now nearing completion will effect a large saving in expenses, and that the completion of the Moscow extension will produce a heavy increase in gross earnings. It is stated that more small farms have been sold along the lines of the road in the last year than were sold in the same territory in the 10 years preceding.

**Syracuse (N. Y.) Rapid Transit Company.**—An initial dividend of 3 per cent has been declared on the \$2,750,000 common stock.

**Toledo (O.) Railways & Light Company.**—At the annual meeting of stockholders on January 16 John F. Collins and Albion E. Lang of Toledo and Charles W. Wason of Cleveland retired as directors. S. D. Carr and J. K. Secor of Toledo, R. B. Van Cortlandt of New York, J. F. Demers of Quebec and W. E. Hutton of Cincinnati have been elected new directors.

**Union Railway.**—Receivers have been appointed for two subsidiary roads of this company, which is controlled by the

New York City Railway. On January 19 Justice Mills of the New York state supreme court appointed Leslie Sutherland temporary receiver of the Yonkers Railroad and J. Addison Young of New Rochelle temporary receiver of the Westchester Electric Railroad of Mt. Vernon, N. Y. The receivers were appointed on application of the directors, who declared that the debts of the two companies aggregate about \$5,000,000, and that they have small assets. Application has also been made to the court for a receiver for the Tarrytown White Plains & Mamaroneck Railway of White Plains, N. Y. An order to show why the Union Railway Company should not be dissolved will be returnable on March 9.

**United Railways Investment Company, New York.**—Edward B. Smith of Philadelphia has been elected a director.

**West Chester (Pa.) Street Railway.**—At the annual meeting of shareholders on January 13 the following statement for the fiscal year ended June 30, 1907, was made: Gross earnings, \$100,421.67; operating expenses, \$54,521.05; net earnings, \$45,897.62; taxes and interest, \$36,711.63; net income, \$9,185.99. George D. Woodside was elected a director and treasurer to fill the vacancy left by the death of his father, John W. Woodside.

## ELECTRIC RAILWAY EARNINGS.

### Brockton & Plymouth Street Railway, Plymouth, Mass.

November—	1907.	1906.
Gross earnings .....	\$8,985.13	\$7,214.55
Expenses and taxes .....	7,258.71	5,474.36
Net earnings .....	826.42	1,740.19
Interest charges .....	1,751.69	1,813.73
Deficit .....	925.27	73.54

### Columbus (Ga.) Electric Company.

November—	1907.	1906.
Gross earnings .....	\$32,373.65	\$26,600.27
Expenses and taxes .....	16,550.30	13,979.77
Net earnings .....	15,823.35	13,520.50
Interest charges .....	10,505.73	8,868.59
Balance .....	5,317.62	4,651.91
Improvement fund .....	1,398.33	1,023.33
Balance .....	3,919.29	3,628.58

### Dallas (Tex.) Electric Corporation.

November—	1907.	1906.
Earnings, including income from securities .....	\$102,300.00	\$82,980.99
Expenses and taxes .....	66,997.13	66,149.60
Net earnings .....	35,302.87	15,931.39
Interest charges .....	20,489.40	15,883.33
Balance .....	14,813.47	48.06
Bond sinking fund .....	3,333.33	3,189.16
Balance .....	11,480.14	*3,141.10

\*Deficit.

### El Paso (Tex.) Electric Company.

November—	1907.	1906.
Gross earnings .....	\$46,430.76	\$35,671.73
Expenses and taxes .....	31,406.96	25,994.99
Net earnings .....	15,023.80	9,676.74
Interest charges .....	5,424.93	4,066.67
Balance .....	9,598.87	5,610.07

### Galveston-Houston Electric Company.

November—	1907.	1906.
Gross earnings .....	\$89,739.84	\$82,905.95
Expenses and taxes .....	57,413.67	50,347.06
Net earnings .....	32,326.17	32,558.89
Interest charges .....	13,569.04	11,558.34
Balance .....	18,766.13	20,600.55
Bond sinking fund .....	2,608.75	3,028.75
Balance .....	16,157.38	17,571.80

### Jacksonville (Fla.) Electric Company.

November—	1907.	1906.
Gross earnings .....	\$31,171.46	\$33,468.39
Operating expenses and taxes .....	22,175.67	20,239.24
Net earnings .....	8,995.79	13,229.15
Interest charges .....	4,981.85	3,475.90
Balance .....	4,013.94	9,754.15
Improvement fund .....	769.17	.....
Balance .....	3,244.77	9,754.15

### Montreal Street Railway.

December—	1907.	1906.
Total earnings .....	\$294,640.17	\$266,953.33
Operating expenses .....	192,310.26	185,571.22
Net earnings .....	102,329.91	81,382.11
Total charges .....	42,913.96	39,121.95
Surplus .....	59,416.95	42,260.16

Northern Ohio Traction & Light Company, Akron, O.

December—	1907.	1906.
Gross earnings	\$147,861.80	\$141,709.06
Operating expense	82,286.06	82,276.58
Net earnings	65,575.74	59,432.48
Fixed charges	43,361.64	41,012.33
Surplus for stock	22,214.10	18,420.15
January 1 to December 31—	1907.	1906.
Gross earnings	\$1,909,060.75	\$1,703,339.98
Operating expense	1,095,755.11	1,006,842.31
Net earnings	813,305.64	696,497.67
Fixed charges	513,241.86	483,173.85
Surplus for stock	300,063.78	213,323.82

Northern Texas Traction Company, Ft. Worth, Tex.

November—	1907.	1906.
Gross earnings	\$83,567.85	\$67,485.21
Operating expenses and taxes	49,884.87	43,763.19
Net earnings	33,682.98	23,722.02
Interest charges	11,602.35	9,941.67
Balance	22,080.63	13,780.35

Pensacola (Fla.) Electric Company.

November—	1907.	1906.
Gross earnings	\$18,279.30	\$15,195.98
Operating expenses and taxes	13,817.34	9,782.80
Net earnings	4,461.96	5,413.18
Interest charges	3,586.85	3,156.66
Balance	875.11	2,256.52

Puget Sound Electric Railway, Tacoma, Wash.

(Including earnings, expenses and interest charges of Tacoma Railway & Power Company.)

November—	1907.	1906.
Gross earnings	\$135,452.13	\$97,317.65
Operating expenses and taxes	91,915.64	76,877.33
Net earnings	43,536.49	20,440.32
Interest charges	31,247.28	25,570.84
Balance	12,289.21	*5,130.52
Bond sinking fund	5,165.84	2,872.50
Balance	7,123.37	*8,003.02

\*Deficit.

Savannah (Ga.) Electric Company.

November—	1907.	1906.
Gross earnings	\$51,120.70	\$45,049.00
Operating expenses and taxes	38,788.29	32,594.46
Net earnings	12,332.31	12,454.54
Interest charges	12,276.20	11,299.98
Balance	56.11	1,154.56
Improvement fund	1,666.66	1,666.67
Balance	*1,610.55	*512.11

\*Deficit.

Seattle (Wash.) Electric Company.

November—	1907.	1906.
Gross earnings	\$354,418.31	\$384,705.68
Operating expenses and taxes	245,695.79	191,496.45
Net earnings	108,722.52	93,209.23
Interest charges	41,255.92	27,923.79
Balance	67,466.60	65,285.44
Bond sinking fund	4,583.32	4,583.34
Balance	62,883.28	60,702.10

Tampa (Fla.) Electric Company.

November—	1907.	1906.
Gross earnings	\$45,736.05	\$48,791.27
Operating expenses and taxes	28,121.71	28,355.46
Net earnings	17,614.34	20,435.81
Interest charges	641.64	452.05
Balance	16,972.70	19,983.76

Whatcom County Railway & Light Company, Bellingham, Wash.

November—	1907.	1906.
Gross earnings	\$23,342.15	\$27,269.71
Operating expenses and taxes	19,483.07	16,014.05
Net earnings	13,859.08	11,255.66
Interest charges	6,570.94	4,105.81
Balance	7,288.14	7,149.85

Dividends Declared.

Nashville (Tenn.) Railway & Light Company, preferred, 2½ per cent.  
 Twin City Rapid Transit Company, Minneapolis, common, quarterly, 1¼ per cent.  
 West Penn Railways, Pittsburg, preferred, quarterly, 1¼ per cent.

# Manufactures and Supplies

## ROLLING STOCK.

Milwaukee Coke & Gas Company, Milwaukee, Wis., is in the market for six motor cars.

Webster Monessen Bellevorn & Fayette City Street Railway, Monessen, Pa., is in the market for two cars.

Texas Traction Company, Dallas, Tex., has placed an order with the St. Louis Car Company for 12 double-truck cars.

Chippewa Valley Electric Railroad, Eau Claire, Wis., is considering the purchase of two interurban cars. The company does not know, at present, when it will be ready to place the order.

Henry M. Warren, Grand Avenue hotel, Asbury Park, N. J., is in the market for one 4-foot 8-inch-gauge and one 3-foot gasoline or gasoline-electric car.

South Bethlehem & Saucon Street Railway, South Bethlehem, Pa., is negotiating for the purchase of two semi-convertible double-truck cars and one single-truck freight car.

Seattle Electric Company, Seattle, Wash., which was reported several months ago to be considering the purchase of from 50 to 75 cars, will probably place this order within the next few weeks.

Municipality of St. Petersburg, Russia, is reported to be in the market for 57 motor cars and 210 trailers, and it is believed that prices on this equipment will be requested from builders in the United States.

Toronto Railway, Toronto, Ont., will adopt the pay-as-you-enter type of cars during the course of the year. It is said the system is somewhat different from that originated by the Montreal Street Railway, in that the Toronto car has one entrance door only, 37 inches wide, located in the rear of the car on the left side. The exit is in front on the right side. The conductor will stand outside the car at the entrance door to collect fares. Fourteen of these cars have been completed and 11 more are under construction.

Choctaw Railway & Lighting Company, McAlester, Okla., as reported in the Electric Railway Review of November 9, 1907, has placed an order with the Niles Car & Manufacturing Company for two double-truck passenger cars. The order was placed in November, 1907, and delivery is to be made January 15, 1908. The specifications include the following details:

Seating capacity	.....	Length of body	..... 36 ft.
..... 50 passengers		Height—	
Weight	..... 54,000 lb.	Sill to trolley base	..... 9 ft.
Wheel base	..... 6 ft. 6 in.	Track to trolley base	.....
Length, over vestibule	..... 46 ft.	.....	..... 12 ft. 6 in.
Over all	..... 48 ft.	Body	..... Wood
Width, inside	..... 7 ft. 6 in.	Underframe	..... Combination
Over all	..... 8 ft. 10 in.		

## Special Equipment.

Air brakes	..... Westinghouse	Safety tread	..... Stanwood
Couplers	..... Niles	Sanders	..... Nicholls-Lintern
Curtain material	..... Pantasote	Seats	..... Hale & Kilburn
Gears and pinions	..... Nuttall	Trolley poles and attachments	..... Nuttall
Heating system	..... Consolidated Car-Heating Co.	Trucks	..... Taylor
Headlights	..... Crouse-Hinds	Varnish	..... Chicago
Motors	..... 4 GE-57		

## SHOPS AND BUILDINGS.

Columbus (O.) Railway & Light Company.—A contract has been awarded to J. E. Snyder of Columbus for the erection of a car house at Fourth and Merrit streets. The building will be of brick, 174 by 132 feet, and will cost about \$15,000. A repair shop will be installed.

Ft. Wayne & Wabash Valley Traction Company, Ft. Wayne, Ind.—Among the improvements contemplated for the present year is the erection of a modern terminal station at Logansport, Ind.

Omaha & Council Bluffs Street Railway, Omaha, Neb.—Half a block of land at Tenth and Pierce streets has been purchased for \$26,000. As soon as the lease on the buildings that now occupy it expires a new car house will be built.

## TRADE NOTES.

Central States Bridge Company, Indianapolis, Ind., has received a contract from the Winona Interurban Railway, Winona Lake, Ind., for a bridge across the Pennsylvania Rail-

road, one mile west of Warsaw, Ind. It is stated that the contract price is \$26,000.

**General Fireproofing Company**, Youngstown, O., held the annual convention of its sales agents at the plant on January 9 and 10.

**Berger Manufacturing Company**, Canton, O., has filed notice of an increase in capital stock from \$1,500,000 to \$2,000,000.

**Manning, Maxwell & Moore, Incorporated**, New York, announces the removal of its Cleveland, O., office from the Williamson building to 2 St. Clair avenue.

**St. Louis Car Company**, St. Louis, Mo., has completed an order for 24 sets of No. 62 double trucks for the Illinois Traction System. These trucks are in service, and the company reports they are giving the best of results.

**Pressed Steel Car Company**, Pittsburg, Pa., has appointed Fritz von Hiller its representative at Mexico City, succeeding D. G. Farragut, resigned. The Buenos Aires office has been moved to Calle Tucuman, No. 305, Buenos Aires, Argentine Republic.

**Vacuum Cleaner Company's** main offices are at 425 Fifth avenue, New York, and not at 72 Trinity place, as was stated in an item in the Electric Railway Review of January 18, which announced the appointment of R. C. Hallett as manager of the company's railway department.

**Pantasote Company**, 11 Broadway, New York, states that its new product, Agosote headlining, is receiving considerable attention. The company claims for it all the qualities of a perfect lining, as it is waterproof, will not warp, shrink or blister, and is homogeneous in its composition.

**Niles Car & Manufacturing Company**, Niles, O., held its annual meeting on January 22. The old board of directors and officers were re-elected and dividends declared on both common and preferred stock. The president's report was satisfactory and the sales department predicts fair business for the coming year.

**Lumen Bearing Company**, Buffalo, N. Y., on January 3 and 4 observed its fourth annual gathering of office and sales forces at the Buffalo plant. The daily sessions were devoted to discussing business methods and plans with an occasional original paper on a subject particularly relative to bearings. The meetings wound up with a banquet, given by the company, at which 16 were present.

**Lord Electric Company**, New York, has taken over all the patents, granted and pending, of W. P. Cosper, covering controller regulators. Mr. Cosper has been awarded the agency for the central western territory, with headquarters at Chicago, instead of being located at New York as originally announced. Mr. Cosper's controller regulators are very unique and cover the desirable features of a regulator designed to positively control the acceleration of motors. Many new features, it is stated, are embodied in these devices which should at once appeal to the railway manager. The Lord Electric Company is preparing to fill orders now in hand and accumulate stock for future demands.

**Maryland Railway Supply Company of Baltimore City**, 510 Continental building, Baltimore, Md., has been organized to handle various lines of steam and electric railway supplies, under exclusive territorial contracts, in the eastern and southern states. It has already made arrangements with several leading companies along these lines. The principal office of the company will be in Baltimore, but branch offices in the north, east and south will be opened as the business justifies. A general agency for the New England states will be established at once and traveling salesmen will look after southern trade. Nelson E. Perrin is president, Charles Elliott vice-president and general manager, who will have charge of the operation of the company, and Thomas W. Boykin secretary and treasurer.

**Washburn Steel Castings & Coupler Company**, Minneapolis, Minn., closed its plant on November 1, 1907, and for the past two months has been engaged in remodeling and rebuilding it from end to end. As a result the company is now in a position to turn out 25,000 freight couplers, a proportionate number of passenger and engine couplers, and 150 tons of miscellaneous steel castings a month, and still has space for a considerable tonnage for its electric railway devices. Stanley Washburn, vice-president, states that with the first of the year his company has entered on a new departure and is placing more extensively on the market its line of traction couplers, especially the widely advertised L-5 coupler for heavy railway work. For a year past this has been in the experimental stage, but the trials have been so

successful that every effort is now being used to give it general introduction. To this end J. L. Hopper, who is well known in the railway supply and steel casting business, has been appointed the company's representative in the traction belt, with headquarters at Cincinnati, O. Although actual orders during the first month of the new year have been slow, Mr. Washburn states that inquiries and requests for quotations indicate that the coming year, as a whole, will be the best the Washburn company has ever enjoyed.

**Massachusetts Chemical Company**, Walpole, Mass., reports that business shows a decided upward tendency and that orders are coming in briskly, besides many inquiries, both domestic and foreign, for Armalac and the company's other products. During the past week several large consignments of Armalac have been shipped for use in the repair departments of various electric railways. The company states that its contention that a weekly or semi-weekly bath of Armalac will save hundreds of dollars in rewinding expense on armatures, has been brought home to many large roads so forcibly that this procedure is now the practice on a number of them. Orders for its black oilproof varnish for armature finishing and frames are in gratifying volume. The company will open a branch office at 164 Monadnock block, Chicago, in charge of Arthur E. Duclos.

**Lord Electric Company**, New York and Boston, has completed arrangements with Charles I. Earl for the manufacture and sale of his trolley retriever and catcher, thereby coming into possession of one of the most useful devices in the electric railway field. The Earl retriever has long since passed the experimental stage. It is strong and durable, easy of access, free from complications, attractive in appearance and built on good engineering design. It comprises many desirable features, the weak points having been eliminated. Many of the largest and most representative electric railway properties have adopted the Earl retriever and catcher, and recent unsolicited letters show their entire satisfaction. The Lord Electric Company is increasing its line of desirable specialties, all of which are of interest because they embody principles which assure additional sources of economy.

**Westinghouse Electric & Manufacturing Company's** reorganization committee, in a circular dated January 20, has issued its final plan for the readjustment of the company's debt. The original plan, reported in the Electric Railway Review of January 18, contemplated the creation of a first mortgage bond issue of \$45,000,000, to bear interest at 5 per cent. This was designed to take up all the floating and funded indebtedness, including the \$6,000,000 notes sold through Kuhn, Loeb & Co., and the French loan, due in 1917. As the holders of the notes and the French security holders are quite satisfied with the original security, the committee has decided to make the bond issue \$35,000,000, leaving the notes as they stand. The \$35,000,000 5 per cent mortgage bonds are to mature in 25 years. Based upon statements furnished by Haskins & Sells, certified public accountants, who have been auditors of the company since 1902, the present debt, exclusive of interest, is as follows:

<b>Unsecured debt—</b>	
Convertible sinking fund 5 per cent gold bonds, due January 1, 1931.....	\$18,500,000
Five per cent gold debenture certificates, due July 1, 1913.....	1,969,000
Bills payable.....	\$9,209,766.21
Accounts payable, about.....	3,952,543.13
Indebtedness of subsidiary companies, etc.....	1,368,390.66
<b>Total floating debt, about.....</b>	<b>14,531,000</b>
<b>Total unsecured debt to be provided for, about</b>	<b>\$35,000,000</b>
<b>Debt secured by collateral—</b>	
Three-year 6 per cent collateral notes, due August 1, 1910.....	\$6,000,000
Ten-year 5 per cent collateral notes (French loan), due October 1, 1917, about.....	\$2,750,000
<b>Total secured debt, about.....</b>	<b>\$8,750,000</b>
The board of directors of the company is to be approved by the reorganization committee and a provision, satisfactory to the committee, is to be made (by voting trust or otherwise) for the future election of directors.	

**ADVERTISING LITERATURE.**

**Ohio Brass Company, Mansfield, O.**—The advantages to be gained in the use of the Collin pressure regulating valve for steam are set forth in a new catalogue. Two types, B and C, are illustrated and described.

**H. W. Johns-Manville Company, 100 William Street, New**

York, N. Y.—Linolite—"a yard of light to a yard of space"—is a modern system of lighting described and illustrated in a neat circular recently issued.

Northern Electrical Manufacturing Company, Madison, Wis.—Some interesting facts about the single voltage variable speed system are contained in a recently issued booklet entitled "Variable Speed Motors."

Eugene J. Stern, 1402 Broadway, New York City.—"Amusement Devices That Pay" are forcibly described and illustrated in a recently issued catalogue. The firm specializes in designing and building amusement parks and devices, including scenic railways, figure eights and a large number of new and attractive devices.

Consolidated Car-Heating Company, 42 Broadway, New York, N. Y.—A circular describes and illustrates a popular type of portable vestibule heater, which is also adapted for use in small ticket offices or other places where only a moderate degree of heat is required. Two types of stationary vestibule heaters are also shown.

Standard Electric Accumulator Company, 141 Broadway, New York, N. Y.—A small pamphlet has been issued calling attention to the storage batteries of this company. The special feature in the construction of the battery is the plate. The active material and its electrode is entirely inclosed in a thin strong box of unglazed pottery.

Blake & Knowles Steam Pump Works, 114-118 Liberty Street, New York, N. Y.—General catalogue K-800 is a handsome book of 176 pages and double cover, in which the complete line of Knowles pumping machinery is fully illustrated and described. A large amount of important technical information is included, making the book valuable for reference.

Western Electric Company, Hawthorne, Ill.—A bulletin soon to be distributed is devoted to Beck flaming arc lamps. It is fully descriptive of the most recent and important developments and contains complete data covering performance. These lamps as now manufactured are suitable for use on either alternating or direct currents and have been so greatly simplified in construction that but little skill is required in operating.

The J. G. Brill Company, Philadelphia, Pa.—The January number of Brill's Magazine contains a number of illustrated articles descriptive of recent car orders, including those for the Cie Municipale de Trauways, Salonica, Turkey; Visalia (Cal.) Electric; Rhode Island Company, Providence, R. I.; Boise Valley, Boise, Idaho; Mahoning & Shenango (O.) system; New York & North Shore, Roslyn, L. I.; Electric Tramway, Lisbon, Portugal.

St. Louis Car Company, St. Louis, Mo.—A comprehensive catalogue showing a complete line of supplies of this company's manufacture will soon be ready for distribution. It will be prepared in the convenient loose leaf style and so arranged that supplies may be ordered by number, thus simplifying the matter and avoiding delays and misunderstandings. The catalogue is being issued under the supervision of Abe Cook, formerly with the LaCledde Car Company, who has charge of the supply department and whose familiarity with the car business will insure prompt and efficient service.

**NUTTALL SLEET SCRAPERS AND SLEET WHEELS.**

To many street and interurban railways the problem of keeping the cars moving during sleet storms is a troublesome one. Two devices for freeing wires from sleet that are grow-



Sleet Scraper.



Sleet Wheel.

ing in popularity with trolley men are illustrated. One of these is a scraper which can be fastened to the regular trolley wheel by means of a spring. It can be attached by anybody in a moment, and as readily removed after it has served its purpose. It locks the wheel and effectively scrapes all sleet and ice from the wire. It is simple and inexpensive, and is preferred for use where only an occasional sleet storm may be expected.

The second device shown is a wheel which takes the

place of the regular one. It is intended for use in those sections where sleet storms are of frequent occurrence. If the storm comes during the night one of these wheels on the car that makes the first morning trip is sufficient to clean the wire for the day's traffic. During heavy storms cars equipped with wheels should be run every 15 or 20 minutes. By the use of these simple devices much delay and annoyance may be avoided. These scrapers and wheels are made by the R. D. Nuttall Company, Pittsburg, Pa. The scrapers are made in two sizes, 4-inch and 6-inch. The wheels are made 4 inches in diameter, 1½ inches through hubs and 5¾ inches in diameter, 1½, 2 and 3 inches through hubs.

**A NEW OHIO BRASS SECTION INSULATOR.**

A new type of section insulator has recently been put on the market by the Ohio Brass Company of Mansfield, O. It is shown in the accompanying illustrations. The device consists of two substantial end castings of bronze, with means for attachment of the ends of the trolley wire, wood members forming the insulating medium between the sections.

Great mechanical strength is obtained from the fact that the direct pull exerted by the trolley wires is borne by two wood break strain insulators, one on each side of the sus-

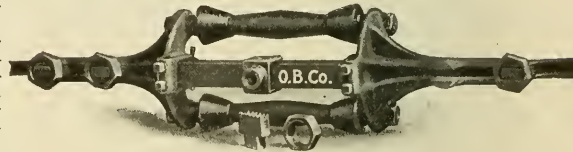

Section Insulator—Figure 1, Top View.

pension bar and runner piece, as shown in Figure 1. These wood break strains are similar in construction to the Ohio Brass Company's regular wood break strain insulator, that is, the malleable iron cap castings are compressed over the ends of the wood member by hydraulic pressure, which distributes the stresses evenly throughout the entire piece.

The malleable iron cap castings of the wood breaks are provided with internally threaded lugs and are fastened to the end castings of the section insulator by machine bolts which pass through holes in the end castings and engage the threads in the lugs. Lock washers prevent these bolts from being loosened by vibration.

Since each of the wood breaks has an approximate ultimate strength in tension of 7,000 pounds it is possible to



Section Insulator—Figure 2, Side View.

break the largest sizes of trolley wire without injury to the insulator. The wood breaks are situated in the same plane with the trolley wire and therefore are subjected to no bending moment, being subjected to direct-tension stress only.

The suspension bar and runner piece are of hard wood and are separate, as seen in Figure 2. The ends of the suspension bar, which is 1½ by 1½ by 9¼ inches in dimensions, fit into recesses in the faces of the end castings, and a top suspension is provided for attachment to a hanger with a ¾-inch threaded lug.

The runner bar is of the same dimensions as the suspension bar, the under edge being rounded to fit the groove of the trolley wheel. It is driven tightly into the recesses in the end castings beneath the suspension bar and is further held in place by cotter pins, as shown in Figure 1. This runner bar may easily be renewed.

By inspection of the illustrations it will be noted that the end castings terminate in long grooved ears for the reception of the wires. These ears are each provided on the upper edge with two threaded lugs, 1¼ inches in diameter, the lugs being bifurcated. A wedge with a grooved and serrated edge, shown in detail in Figure 1, fits into the bifurcations of each of the lugs and is clamped down upon the trolley wire, lying

at the bottom of the groove, by nuts which fit the lugs. About midway between the lugs there is a projection or hump in the bottom of the groove in the ear, so that when the wedges are clamped down the wire is given a crimp, rendering it impossible for the wire to pull away. The grooves in the ears will take round, figure 8 and grooved wires.

At the tops of the end castings  $\frac{3}{8}$ -inch holes are drilled for feeder wire fastenings and clamping bolts are provided. The length of the section insulator is  $1\frac{1}{2}$  inches over all.

**EXECUTIVE OFFICES OF STONE & WEBSTER COMPANIES.**

The executive offices of the Stone & Webster Companies have been moved into the 8-story office building at 147 Milk street, corner of Batterymarch, Boston. This entire building is occupied by different parts of the Stone & Webster organization, as follows: The fifth, sixth, seventh and eighth floors

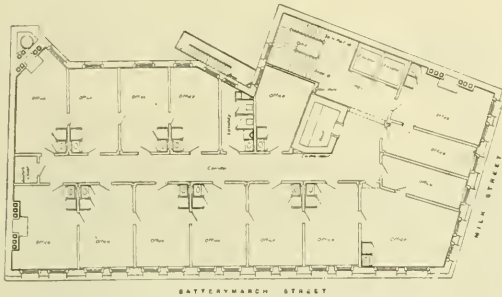

Executive Offices, Stone & Webster Companies.

are occupied by the Stone & Webster Engineering Corporation; the third and fourth floors by the newly organized Stone & Webster Management Association; and the first and second floors by the firm of Stone & Webster.

The accompanying illustration shows the typical floor plan of the building.

**THE HILLMAN LOCKED CLEVIS.**

E. D. Hillman is the patentee of an adjustable clevis or jaw that can be securely locked at any desired position, which is being placed on the market by the United States Metal & Manufacturing Company of New York.

The locking is accomplished by having a conical recess in

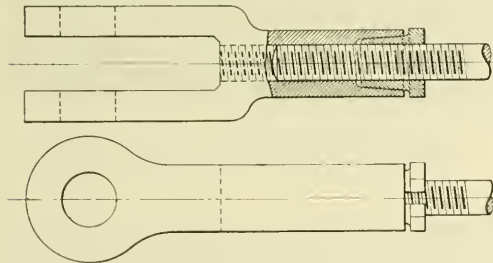

The Hillman Locked Clevis.

the shank or stem of the clevis, this recess receiving a conical split nut. The opening in the shank for the connecting rod is threaded right or left, as desired, the nut being tapped in the same manner. When the clevis is properly adjusted the nut is screwed into the recess of the shank until the wedging causes the threads of the rod and nut and the conical sides of the nut and clevis recess to bind, this giving the lock. An adjustment can be easily and rapidly made and the clevis locked against turning at any desired point, the length of the shank determining the extent of adjustment.

This device should be of value where adjustments are necessary, as in truck brakes and brake rigging for steam and electric cars, in switch and signal apparatus, cranes, bridges and rigging. The locking feature can be incorporated in

either drop-forged, malleable iron or steel clevises. Standard clevises can be treated in the same manner.

**WESTERN ELECTRIC COMPANY'S EXHIBIT AT THE CHICAGO ELECTRICAL SHOW.**

The exhibit of the Western Electric Company at the Chicago electrical show consisted of two parts: the telephone exhibit and the supply and power apparatus exhibit. The telephone exhibit included a full line of magneto and common battery switchboards, as well as all kinds of local and common battery and intercommunicating sets. A self-restoring drop board connected and in full operation was shown. In addition there was a full line of standard construction materials with cable terminals and showcases filled with all parts which go to make up the company's standard switchboard and subscribers' sets.

The power apparatus and supply exhibit included a 400-kilowatt 60-cycle three-phase 2,300-volt alternator, which was the largest that could be exhibited with safety on the floor of the Coliseum. The exhibit of small generators included a 15-kilowatt 250-volt direct-current engine type generator with a semi-steel vertical divided frame with laminated pole pieces. The smallest generator exhibited was a  $1\frac{1}{2}$ -volt 3-ampere ignition and battery charging generator. One of the Western Electric Company's latest type direct-current 250-volt motors, direct connected to a 50 KVA 60-cycle 440-volt alternator, furnished light for the booth and power to drive back-gear, continuous service, phase-wound, vertical alternating-current motors. Stators and rotors for squirrel cage and phase-wound types of machines of various classes were shown under construction. The apparatus was so arranged that the observer could see various classes and types of apparatus under construction in making his tour of inspection.

For a number of years the company has manufactured a 5-light testing regulator that can be used for testing series alternating-current lamps during the day with a maximum voltage of 440, thus eliminating the danger to lamp repair men when using a larger regulator. This regulator can also be used for lighting from 440-volt power circuits, and for this class of service the company recommends operating five series alternating-current lamps in connection with the regulator. An equipment of this kind was on exhibition and connected up so that the operation of the lamp and regulator could be demonstrated. The new Western Electric 440-volt multiple alternating-current lamp was also on exhibition and sample 110-volt alternating-current and direct-current lamps were included in the list of display lamps.

This company has recently formed a selling arrangement whereby it becomes a distributor of the Beck flaming arc lamp, and two of these lamps were on exhibition.

An interesting feature of the supply exhibition was the black enamel wire, which is said to be superior to silk and cotton, owing to the small amount of space required by the wire, the greater number of feet per pound, and the high insulating quality. A line of supplies manufactured or handled by this company was also on exhibition, including American transformers, Vulcan heating apparatus, street railway material, Electro-se insulated material, Thomas high-tension insulators, Duncan wattmeters, D. & W. fuses and Deltabeston wire.

The entire exhibition was in charge of G. H. Lounsbury.

**LUBRICATING GRAPHITE.**

Graphites as utilized for lubricating purposes are of two kinds. One is the crystalline or foliated form of graphite commonly called "flake" and the other the amorphous form of graphite, which is non-structural, exceedingly unctuous, rich in carbon and capable of very much finer pulverization. The former is imported principally from Ceylon. The latter is mined in Mexico.

Both approximate 80 per cent of carbon (graphite). Impurities said to be carried by the foliated variety consist largely of silica, which is harsh and micaceous in nature, while any slight impurities in the amorphous (or "powder") form are soft and gritless.

While the chemical make-up is the same there is considerable difference in the mechanical action of these two formations. The amorphous graphite is peculiarly adhesive—not only does it "stay put," even under heavy frictional pressure, thereby performing its function of lubrication to better advantage, but it remains suspended in oil for a long time, thus feeding through lubricator tubes without clogging. Mixed with lubricating oils in the proportion of one teaspoonful of graphite to one pint of oil this "powdered" lubricating graphite will be found to accomplish much in the way of lubrication.

The amorphous or "powdered" graphite is mined and prepared by the United States Graphite Company, Saginaw.

Mich., which company will send on request samples and an interesting booklet "About Graphite Lubrication."

#### GENERAL ELECTRIC COMPANY'S EXHIBIT AT THE ELECTRICAL SHOW.

The General Electric Company's exhibit at the third annual electrical show at the Coliseum, Chicago, occupied a space of over 700 square feet in the center of the building. The exhibit was devoted principally to cooking and heating devices, among which were shown luminous radiators, coffee percolators, chafing dishes, water heaters, complete cooking and baking outfits and flatirons. An interesting feature of the exhibit was the color booth, in which color values were compared under various electric lights, including the inclosed arc, incandescent, Nernst and Welsbach types. The exhibit also included microscope pictures of the Schenectady factory of the General Electric Company and of the West Jersey & Seashore Railroad.

#### AN INTERESTING EXHIBIT OF THE H. W. JOHNS-MANVILLE COMPANY.

One of the most interesting exhibits at the Chicago electrical show was that of the H. W. Johns-Manville Company. Last year the company exhibited for the first time its Victor combination meters, since which time these meters

material has a wide range of uses, such as for switchboards, panel boards, fireproof barriers, etc. It can be worked with ordinary woodworking tools, the same as hard wood.

A complete line of Noark fuses and fuse devices was also shown, as well as line material, electrotherms (electric heating pads), J-M friction tape, molded mica, Monarch, Phoenix, Vulcabeston and Electrobeston insulations, asbestos pipe coverings, asbestos roofings, asbestos packings and asbestos household specialties.

The company was represented by Messrs. H. M. Frantz, manager electrical department Chicago office; F. C. Frumveller and A. M. Chamberlin of the Chicago office; A. M. Erskine, manager electrical department St. Louis office; M. H. Crosswell, manager electrical department Milwaukee office; G. A. Saylor, Milwaukee office; and W. F. Little, electrical engineer New York office.

#### LARGE SHIPMENT OF SMITH HEATERS.

The Peter Smith Heater Company of Detroit, Mich., announces that it has secured an order for 100 heater equipments from the Twin City Rapid Transit Company, Minneapolis, Minn. The accompanying engraving from a photograph shows the heaters loaded on wagons in front of the Smith company's plant just before shipment. This heater is known as type C, and differs somewhat in make-up from the company's type B. This heater was made up especially to



Large Shipment of Heaters for the Twin City Rapid Transit Company.

are said to have proved all the claims made for them. This year the company showed a complete line of both stationary and portable types.

The added attraction this year was "Linolite," a new system of lighting, which has already attracted considerable attention. The company's booth was lighted by means of Linolite in such a way as to show the features of the system to excellent advantage. Linolite, which means "line o' light," has been developed especially for window, stage and showcase lighting, as well as for the illumination of desks, pictures and room interiors. It is a new departure from the ordinary bulb lamp and consists of an aluminum reflector 2¼ inches wide and approximately 1 inch deep, in which fit tubular incandescent lamps 12 inches between centers, each lamp having a filament extending its entire length. It is stated that the light furnished by this system is much more intense and evenly distributed than is possible with the ordinary form of incandescent lamps, and with the same amount of current approximately 60 per cent more light is obtained, due to the use of a straight filament and the special form of reflector employed.

Another item of interest in this exhibit was asbestos wood, a fibrous substitute for wood, marble, slate and fiber, for fireproof construction and as an electrical insulation. This

meet conditions in the Twin City cars. The main object was to have a heater that could be placed in the vestibule and would not be too high to obstruct the view of the passengers. It is but 44 inches high and 20½ inches in diameter and has ample capacity to easily heat city or interurban cars up to 40 feet inside measurement. This heater is of the magazine type and has capacity enough to run 18 hours without re-coaling.

#### Niagara Transmission Line.

Construction has been begun on the first section, 28 miles long, of the 60,000-volt transmission line which will carry Niagara Falls current to the Buffalo Lockport & Rochester Railway. This road is now being constructed as a high-speed interurban between Lockport and Rochester, through connection with Buffalo over the International Railway being contemplated. Construction is well advanced and cars will be run over a finished portion of the road within the next few weeks. The transmission line connects with the 60,000-volt lines of the Ontario Power Company near South Greece, and runs thence across country to Albion on the Buffalo Lockport & Rochester Railway; it then parallels the railway.



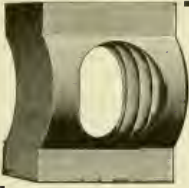

# Use GRIP NUTS on track bolts

and You Have a Better, Safer Track

GRIP NUTS never let loose under any strain, jar or vibration unless bolts break.

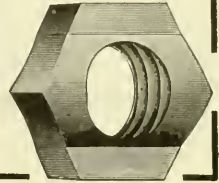

## GRIP NUT COMPANY

500 Fifth Avenue, NEW YORK

152 Lake Street, CHICAGO

# Buy this →

modern, interchangeable brake shoe, approved by the A. S. & I. R. A. Standardization Committee.

The result will be longer life for the shoes and safer operation, at smaller expense. Proof is yours for the asking.

## American Brake Shoe & Foundry Co.

New York Chicago Chattanooga MAHWAH, N. J.

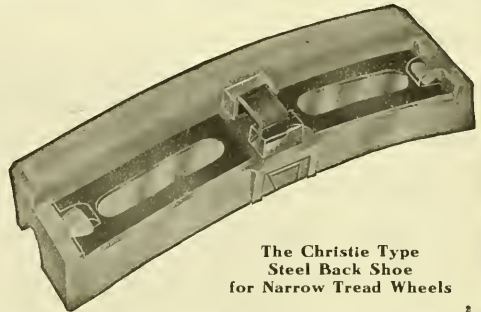

The Christie Type Steel Back Shoe for Narrow Tread Wheels

This portable car is used to excellent advantage by many traction companies for

- Bonding New Track**
- Rebonding Old Track**
- Installing Cross Bonds**
- Bonding Third Rail**



because it does the work better and cheaper by Electric Brazing and Copper Welding than is possible by any other method approaching them in results.

*Will you give us the opportunity to prove this statement?*

# The Electric Railway Improvement Co.

6005 Carnegie Avenue, Cleveland, Ohio

## THE J. G. BRILL COMPANY, PHILADELPHIA, PA.

AMERICAN CAR COMPANY, ST. LOUIS, MO.  
 G. C. KUHLMAN CAR COMPANY, CLEVELAND, OHIO  
 JOHN STEPHENSON COMPANY, ELIZABETH, N. J.  
 WASON MANUFACTURING CO. SPRINGFIELD, MASS.

MAIN OFFICE: PHILADELPHIA, PA.  
 LONDON OFFICE: 110 CANNON ST. E. C.  
 PACIFIC COAST AGENTS: PIERSON  
 ROEDING & CO., SAN FRANCISCO.  
 AUSTRALIAN AGENTS: NOYES  
 BROTHERS, SYDNEY. CABLES:  
 "BRILL," PHILA., "AXLES" LONDON.

*CARS TRUCKS SEATS RATTAN SPRINGS SPECIALTIES SUPPLIES*

## RATTAN SEAT COVERING

Brill rattan seat covering is woven in all widths from eighteen to thirty-six inches, the standard sizes being twenty, twenty-four and twenty-six inches, and the standard length of a roll is two hundred and twenty-five feet. For use on seat cushions it is lined with canvas, but for seat backs the unlined woven cane is amply strong for the purpose. We use the best selected hard cane, which, while it costs a little more than the soft cane often used, is well worth the difference, for it retains its clean, glossy appearance and color and is much more durable. Soft cane has very much the appearance of hard cane when new, but it discolors quickly and wears badly. Our method of weaving cane produces uniformity of texture, and the material never fails to give complete satisfaction. We manufacture seats for all types of city and interurban cars.

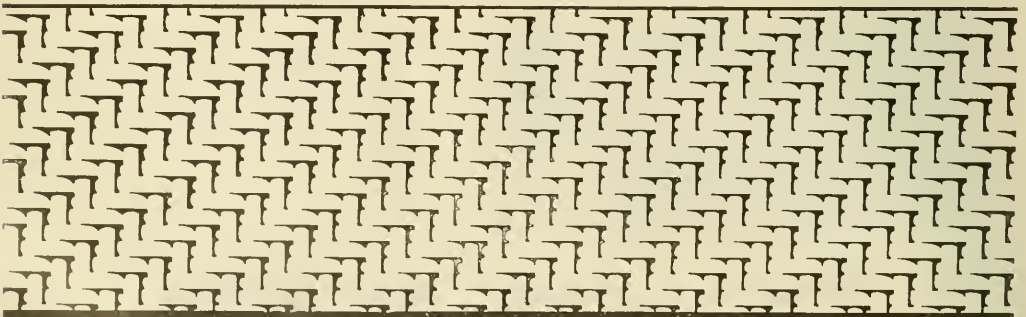

*LINED AND UNLINED TWILL WEAVE RATTAN*

# General Electric Company

## Controller Fingers and Segments

General Electric Contact Fingers are made of pure wrought copper, punched or drop forged, depending on conditions of operation. Fingers carrying heavy current have phosphor bronze springs reinforced with shunts of flexible copper strips, which insures deterioration of finger only at point of contact.

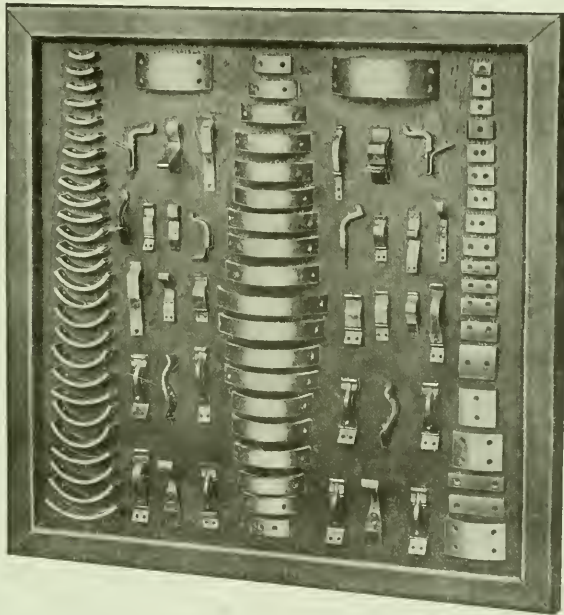

Increased thickness of shank and cold dropping prevent buckling of fingers.

All segments are made from rolled copper.

**“Original Equipment Quality”**

means

**“Original Equipment Service”**

1525

Chicago Office:  
Monadnock Bldg.

Principal Office:  
Schenectady, N. Y.

Sales Offices in  
all large cities

# AMERICAN ELECTRICAL WORKS

PROVIDENCE, R. I.

## BARE AND INSULATED ELECTRIC WIRE

New York Office, 26 Cortlandt St. Chicago Office, 135 Adams St.  
MONTREAL BRANCH: Eugene F. Phillips Electrical Works, Limited.



**LUFKIN**

**MEASURING TAPES**  
are the choice of expert electrical engineers in all quarters of the globe. Absolute accuracy and the highest possible degree of durability make them especially adapted to Electric Railway Work.

New York, London, Eng., Windsor, Can.  
**THE LUFKIN RULE CO.**  
SAGINAW MICH., U. S. A.

## Electric Railway Material

of every description

### F. P. HARRISON ELECTRIC & MFG. CO.

(Incorporated)

169-170 South St.

NEW YORK

## Washburn "K" Type Traction Coupler Complete with Draft Rigging

Simple  
Strong  
Durable

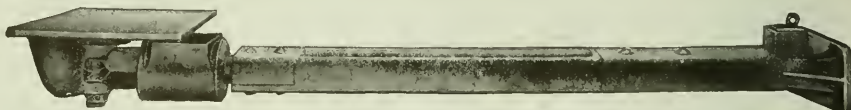

This device is composed of the "K" head—a heavy cast steel extension made in any length—and the "K" pivoted draft box spindle type. Made also in a heavier coupler and with the regulation 6 1/4 x 8 M. C. B. draft spring.

*Ask for new catalogue of traction devices.*

### Washburn Steel Castings & Coupler Co., Minneapolis, Minn.

Western Agents: Tweedy, Hood & Fulen, 204 Fisher Bldg., Chicago

Canadian Agent: John Taylor, Montreal

16

Wherever perfect ventilation is desired  
—there's the place to install

## The Lovell Window and Shutter Operating Device

With it any number of sash up to 500 feet are operated from one station. As the operating station is always placed on the wall at end or side of building, the windows may be quickly closed in case of fire, while people are leaving the building. There are many other excellent points we would like to tell you about.

Send us drawings or blue prints, or tell us the length of your runs and number of sash to be operated and height of sash from floor, and we will cheerfully furnish estimate for the apparatus f. o. b. cars, or erected complete.

### THE G. DROUVÉ CO.

BRIDGEPORT, CONN., U. S. A.

Western Office, 40 Dearborn Street, Chicago

## Galena-Signal Oil Company

FRANKLIN, PA.

THEIR SPECIALTIES

### STREET RAILWAY LUBRICATION including both rolling stock and power house equipment.

Same skillful expert supervision given in this service as in steam railway service has produced very satisfactory results. The business of our Street Railway Department has increased beyond every expectation. In 1906 this department sold ten times the number of barrels of oil sold by the same department in 1905.

We are under contract with many of the largest street and interurban railways of the country.

We guarantee cost per thousand miles in street railway service when conditions warrant it.

Write to Franklin, Pennsylvania, for further particulars.

### STEAM RAILWAY LUBRICATION Sole manufacturers of the celebrated Galena Coach, Engine and Car Oils for steam railway lubrication. Sibley's Perfection Valve Oil for cylinder lubrication, and Perfection Signal Oil for use in railway signal lanterns.

Make especially for use in headlights, cab, classification and tail lights, and for switch and semaphore lamps. Burns equally well with the long time as with the one-day burner; with or without chimney as the burner requires. Is pure water white in color; high fire test, low cold test, and splendid gravity.

### GALENA RAILWAY SAFETY OIL

Made especially for use in headlights, cab, classification and tail lights, and for switch and semaphore lamps. Burns equally well with the long time as with the one-day burner; with or without chimney as the burner requires. Is pure water white in color; high fire test, low cold test, and splendid gravity.

CHAS. MILLER, President

# Electric Railway Review

PUBLISHED EVERY SATURDAY. FORMERLY THE STREET RAILWAY REVIEW. THE WILSON COMPANY, CHICAGO.

160 Harrison Street, Chicago  
150 Nassau Street, New York  
1529 Williamson Bldg., Cleveland

Vol. XIX  
No. 5

CHICAGO, FEBRUARY 1, 1908

Whole No. 249

Subscription: Domestic . . . \$2  
Foreign . . . \$5  
Canada . . . \$3.50

## A Practical Book

*For Every Man*

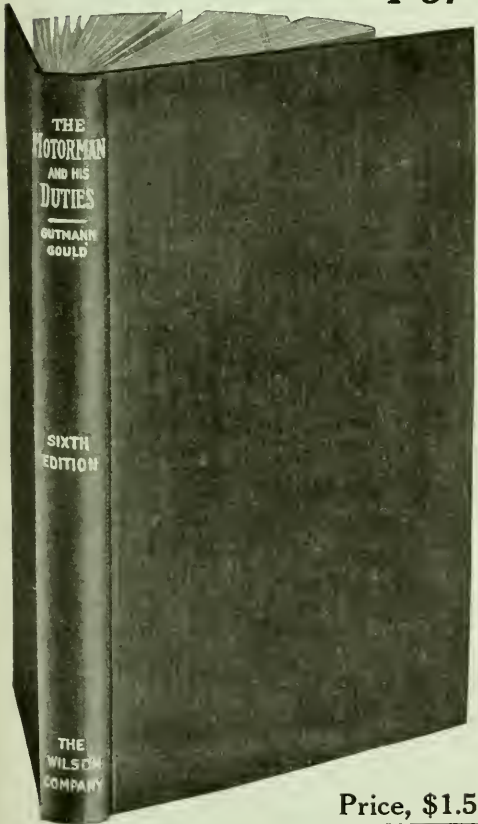

whose services will be made more valuable to himself and to his employer by acquiring intimate knowledge of the principles governing the operation of electric railway cars.

*Buy, read and study this book!* A practical application of the knowledge imparted will result in better, safer and more economical operation.

“*The Motorman and His Duties*” explains in simple language, free from mathematics and technicalities, many points not generally comprehended. It outlines clearly the relation existing between the track, overhead, power station and the car itself.

No other book completely covers the subject in a manner so easily understood!

“*The Motorman and His Duties*,” in the eleven chapters of its recently published sixth edition, comprises 198 pages, 5 by 7 inches, attractively bound in green cloth. It is illustrated by 138 halftones and zinc etchings. It includes a subject index, a glossary and three large inserts of car wiring diagrams.

**Price, \$1.50 per Copy, Prepaid**

Send your address on a postal for a 16-page pamphlet of sample pages, etc.

**The Wilson Company** 160 Harrison Street  
CHICAGO, U. S. A.

# National Air Brakes

## For Electric Railway Service

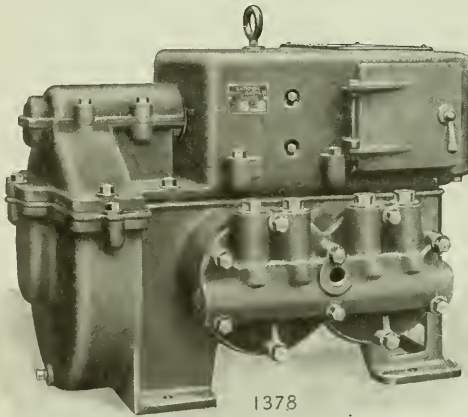

National CC 3 Type Compressor

THE compressors are built in six sizes of from 11 to 50 cubic feet of free air per minute. They are entirely enclosed and therefore dust and waterproof. Motor and compressor are two distinct units, and are separated by a half-inch air space which prevents heat communicating from compressor to motor and thus insures cool running. The gear case is cast as an integral part of the

crank chamber, reducing the number of loose parts, and making it unnecessary to remove the oil when inspecting or dismantling the compressor.

BULLETINS SENT ON REQUEST

**National Brake & Electric Co.**  
Milwaukee, U. S. A.

NEW YORK: 111 Broadway

PHILADELPHIA:

W. H. Goble, 1722 Westmoreland St.

General Sales Office

519 First National Bank Building

CHICAGO

BOSTON: F. E. Huntress, 131 State Street

SAN FRANCISCO, CAL.:

W. F. McKenny, 69-71 First Street

LONDON: 14 Great Smith St., Westminster

# Westinghouse

## There is No Uncertainty

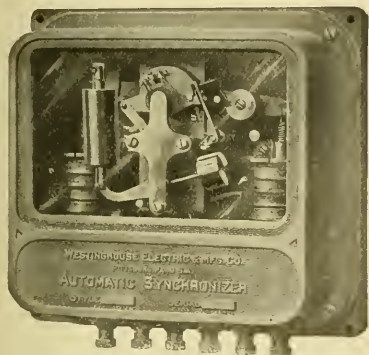

as to the exact moment when machines are running synchronously and may paralleled, if you use a *Westinghouse Automatic Synchronizer*. It entirely eliminates the personal element, does it automatically, even making allowance for the time required to close the coupling switch.

*Instruction Book 5098 tells how to use it.*

## Westinghouse Electric & Mfg. Co.

Atlanta  
Baltimore  
Boston

Buffalo  
Chicago  
Cincinnati

Cleveland  
Dallas  
Denver

Detroit  
Kansas City  
Los Angeles  
Minneapolis

New Orleans  
New York  
Philadelphia

Pittsburg  
St. Louis  
Salt Lake City

San Francisco  
Seattle  
Syracuse

Canada: Canadian Westinghouse Co., Ltd., Hamilton, Ontario Mexico: G. & O. Braniff & Co., City of Mexico

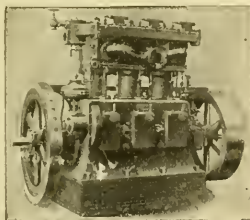

## Gas Engine Ratings

To avoid all misunderstanding concerning the maximum power as compared with their rated power, Westinghouse Vertical Gas Engines are underrated about 10 per cent, so that they are able to sustain an overload when necessary. Some builders rate their gas engines up to maximum to meet competition. If a definite overload capacity is guaranteed there is no occasion for misunderstanding.

Get a copy of Publication 7006  
"Gas Power"

The Westinghouse Machine Co.  
Pittsburg, Pa.



## Encourage Your Motormen

to become familiar with the mechanism of the automatic air brake and how and why it operates. Our pamphlet of instructions for operating Westinghouse "AMM" brake equipments gives this information in a popular way, fully illustrated with diagrams and sectional cuts. It will add to the operating efficiency of your road to see that each of your motormen has this pamphlet; it tells them exactly what they ought to know. Ask for Instruction Pamphlet T-5031. It explains the operation of Westinghouse "AMM" Graduated-Release, Quick-Recharge, Quick-Service, High-Pressure Emergency Brake for trains of 1, 2, 3, 4 and 5 cars.

Westinghouse Traction Brake Co.  
General Offices: Pittsburg, Pa.  
New York: Trinity Building  
Chicago: Ry. Exchange Building  
St. Louis: 1932 N. Broadway  
For Canada: Canadian Westinghouse Co., Ltd., Hamilton, Ont.

## ALPHABETICAL INDEX TO ADVERTISEMENTS.

Acme White Lead & Color Works	Advance Lumber Co.	Allis-Chalmers Co.	Aluminum Co. of America	American Brake Shoe & Fdry. Co.	American Electrical Works	American Frog & Switch Co.	Anderson, A. L. & J. M., Mfg. Co.	Armstrong Oiler Co.	Arnold Company	Atlas Anchor Co.	Babcock & Wilcox Co.	Baker, The Wm. C. Heating & Supply Co.	Baldwin Locomotive Works	Barbour-Stockwell Co.	Barnes, G. H., Hardwood Lumber Co.	Beidler, Francis, & Co.	Bellamy Vestelite Mfg. Co.	Berthold & Jennings	Blake Signal Mfg. Co.	Bliss, R. Mfg. Co.	Bridgeport Brass Co.	Brill, The J. G. Co.	Brown, Harold P.	Brown Hoisting Machy. Co.	Buckeye Engine Co.	Burnham, Williams & Co.	Byles, H. M., & Co.	Central Inspection Bureau	Chase-Shawmut Co.	Churchill Cedar Co.	Cincinnati Car Co.	Cincinnati Frog & Switch Co.	Cleveland Armature Works	Cleveland Frog & Cross. Co.	Collier, Barton	Columbia Construction Co.	Consolidated Car Pender Co.	Consolidated Car-Heating Co.	Contractors' Supply & Equipment Co.	Cooper Heater Co.	Crane Co.	Craghead Engineering Co.	Curtain Supply Co.	Davis, The John Co.	Dearborn Ldg. & Chemical Works	Detroit Graphite Co.	Drouvé, The G. Co.	Drummond Detective Agency	Durkin Controller Handle Co.	Earl, C. L.	Eclipse Railway Supply Co.	Electric Railway Equipment Co.	Electric Ry. Improvement Co.	Electric Service Supplies Co.	Engineers and Contractors	Fairbanks, Morse & Co.	Ford, Bacon & Davis	Galena-Signal Oil Co.	Gaston, George J.	General Electric Co.	General Storage Battery Co.	Gillette Chemical Co.	Goldschmidt Thermit Co.	Green Engineering Co.	Green Fuel Economizer Co.	Griffin Wheel Co.	Grip Nut Co.	Hagy, J. Milton, Waste Wks.	Hale & Kilburn Mfg. Co.	Harrison, F. P., Elec. Mfg. Co.	Hartom, Stewart Co.	Heine Safety Boiler Co.	Heywood Bros. & Wakefield Co.	Holman, D. E., Ry. Tracklayer Co.	Homer Commutator Co.	Hoover-Owens-Rentschler Co.	Green Engineering Co.	Humbird Lumber Co., Ltd.	Indestructible Fibre Co.	Jewett Car Co.	Johann, F. A.	Johns-Manville, H. W., Co.	Kinnear Manufacturing Co.	Lindsay Bros. Co., The	Lorain Steel Co.	Lord Burnham Co.	Lufkin Rule Co.	Lumen Bearing Co.	Macallen Co.	McGuire-Cummings Mfg. Co.	Marshall, R. W., & Co.	Massachusetts Chemical Co.	Meyers, Fred J., Mfg. Co.	Middletown Car Works	Miller Anchor Co.	Millery Electric Co., The	Model Stoker Co., The	Morden Frog & Crossing Wks.	National Brake & Electric Co.	National Carbon Co.	National Lock Washer Co.	Naugle Pole & Tie Co.	New York Switch & Crossing	Niles Car & Mfg. Co.	Northern Engineering Works	Nuttall, R. D., Co.	Ohio Brass Co.	Okonite Co., Ltd.	Pacific Coast Pole Co.	Patent Car Co.	Patten, Paul B.	Pay-As-You-Enter Car Co.	Power Specialty Co.	Pressed Steel Car Co.	Queen & Co.	Rail Joint Co.	Railway Specialty & Supply Co.	Railway Steel-Spring Co.	Recording Fare Register Co.	Read, Francis Co.	Register, A. L. & Co.	Reiter, G. C.	Ridlon, Frank Co.	Roberts & Abbott Co.	Robertson, Wm., & Co.	Rodger Ballast Car Co.	Rooke Automatic Register Co.	Rositter, MacGovern & Co.	Russell Car & Snow-Plow Co.	S-E, Missouri Cypress Co.	St. Louis Car Co.	St. Louis Car Wheel Co.	St. Louis Surfacer & Paint Co.	Sanson & Porter	Saxton, Wm., & Co.	Shimer & Chase Co.	Security Register & Mfg. Co.	Sheaff & Jastaad	Simmons, John Co.	Smith, Peter, Heater Co.	Speer Carbon Co.	Standard Brake Engr. Corp.	Standard Motor Truck Co.	Standard Paint Co.	Standard Steel Works	Standard Underground Cable Co.	Standard Varnish Works	Star Brass Works	Stuart & Webster Engr. Corp.	Stuart-Howland Co.	Symington, T. H., Co.	Telegraph Signal Co.	Trolley Supply Co.	Under-Feed Stoker Co.	United States Graphite Co.	U. S. Metal & Mfg. Co.	Van Dorn & Dutton Co.	Van Dorn, W. T. Co.	Van Valkenburgh, E. C.	Wallace Supply Co.	Wanted and For Sale Cards	Washburn Steel Castings & Coupler Co.	Watson-Stilman Co.	Wendell & MacDuffie	Western Electric Co.	Westinghouse Elec. & Mfg. Co.	Westinghouse Machine Co.	Westinghouse Traction Brake Co.	Weston-Stilman Instrument Co.	Wharton, Wm., Jr., & Co.	Wheeler Condenser & Eng'g Co.	Wheel Train Brake Shoe Co.	White, J. G., & Co.	Whitmore Mfg. Co., The	Wilson, G. Mfg. Co.	Wood, Guilford S.	Woodman, R., Mfg. & Supply Co.	Worcester, C. H., Co.	Zelnicke, Walter A., Supply Co.
-------------------------------	--------------------	--------------------	-------------------------	---------------------------------	---------------------------	----------------------------	-----------------------------------	---------------------	----------------	------------------	----------------------	--	--------------------------	-----------------------	------------------------------------	-------------------------	----------------------------	---------------------	-----------------------	--------------------	----------------------	----------------------	------------------	---------------------------	--------------------	-------------------------	---------------------	---------------------------	-------------------	---------------------	--------------------	------------------------------	--------------------------	-----------------------------	-----------------	---------------------------	-----------------------------	------------------------------	-------------------------------------	-------------------	-----------	--------------------------	--------------------	---------------------	--------------------------------	----------------------	--------------------	---------------------------	------------------------------	-------------	----------------------------	--------------------------------	------------------------------	-------------------------------	---------------------------	------------------------	---------------------	-----------------------	-------------------	----------------------	-----------------------------	-----------------------	-------------------------	-----------------------	---------------------------	-------------------	--------------	-----------------------------	-------------------------	---------------------------------	---------------------	-------------------------	-------------------------------	-----------------------------------	----------------------	-----------------------------	-----------------------	--------------------------	--------------------------	----------------	---------------	----------------------------	---------------------------	------------------------	------------------	------------------	-----------------	-------------------	--------------	---------------------------	------------------------	----------------------------	---------------------------	----------------------	-------------------	---------------------------	-----------------------	-----------------------------	-------------------------------	---------------------	--------------------------	-----------------------	----------------------------	----------------------	----------------------------	---------------------	----------------	-------------------	------------------------	----------------	-----------------	--------------------------	---------------------	-----------------------	-------------	----------------	--------------------------------	--------------------------	-----------------------------	-------------------	-----------------------	---------------	-------------------	----------------------	-----------------------	------------------------	------------------------------	---------------------------	-----------------------------	---------------------------	-------------------	-------------------------	--------------------------------	-----------------	--------------------	--------------------	------------------------------	------------------	-------------------	--------------------------	------------------	----------------------------	--------------------------	--------------------	----------------------	--------------------------------	------------------------	------------------	------------------------------	--------------------	-----------------------	----------------------	--------------------	-----------------------	----------------------------	------------------------	-----------------------	---------------------	------------------------	--------------------	---------------------------	---------------------------------------	--------------------	---------------------	----------------------	-------------------------------	--------------------------	---------------------------------	-------------------------------	--------------------------	-------------------------------	----------------------------	---------------------	------------------------	---------------------	-------------------	--------------------------------	-----------------------	---------------------------------

## CLASSIFIED LIST OF ADVERTISERS.

<b>Advertising Service.</b> Van Valkenburgh, E. C., 2117 West One Street and Second St., Chicago.	<b>Advertising, Street Car.</b> Collier, Barton, Flat Iron Bldg., New York.	<b>Air Brakes—(See Brakes and Brake Parts).</b>	<b>Air Compressors—(See Compressors, Air).</b>	<b>Alloys and Bearing Metals.</b> Brown, H. P., 120 Liberty St., New York. General Electric Co., Schenectady, N. Y. Harrison Elec. & Mfg. Co., 169 South St., New York. Lumen Bearing Co., Buffalo, N. Y. Ohio Brass Co., Mansfield, O. Ridlon, Frank, Co., 200 Summer St., Boston. St. Louis Car Co., St. Louis, Mo.	<b>Aluminum Wire, Etc.</b> Aluminum Co. of America, Pittsburg.	<b>Anchor.</b> Atlas Anchor Co., Cleveland, O. Electric Service Supplies Co., 200 Plymouth Bldg., Chicago. Miller Anchor Co., Norwalk, O. Ohio Brass Co., Mansfield, O.	<b>Armatures and Coils, Winding and Repairing.</b> Cleveland Armature Works, Cleveland, O. Electric Service Supplies Co., 200 Plymouth Bldg., Chicago. General Electric Co., Schenectady, N. Y. Harrison Elec. & Mfg. Co., 169 South St., New York. Lumen Bearing Co., Buffalo, N. Y. McGuire-Cummings Mfg. Co., Chicago. Marshall, R. W., & Co., 95 Liberty St., New York. Nuttall, R. D., Co., Pittsburg. Ohio Brass Co., Mansfield, O. Ridlon, Frank, Co., 200 Summer St., Boston. Symington, T. H., Co., Baltimore, Md. Van Dorn & Dutton Co., Cleveland, O.	<b>Bells and Gongs.</b> American Car Co., St. Louis. Brill, The J. G. Co., Philadelphia.	<b>Belt and Gongs—Continued.</b> Electric Service Supplies Co., 200 Plymouth Bldg., Chicago. Kuhlman, The G. C., Car Co., Cleveland. McGuire-Cummings Mfg. Co., Chicago. Ohio Brass Co., Mansfield, O. Reiter, G. C., Canton, O. St. Louis Car Co., St. Louis, Mo. Stephenson, John, Co., Elizabeth, N. J. Wallace Supply Co., Chicago. Wason Mfg. Co., Springfield, Mass. Western Electric Co., Chicago.	<b>Black Lead.</b> Detroit Graphite Co., Detroit, Mich. U. S. Graphite Co., Saginaw, Mich.	<b>Block System—(See Signals).</b>	<b>Blowers—(See Mechanical Draft).</b>	<b>Blue Printing Machines.</b> Buckeye Engine Co., Salem, O.	<b>Boilers.</b> Babcock & Wilcox Co., N. Y. Fairbanks, Morse & Co., Chicago. Green Fuel Economizer Co., Matteawan, N. Y. Heine Safety Boiler Co., 421 Olive St., St. Louis. Lord & Burnham, Irvington-on-Hudson, New York. Rositter, MacGovern & Co., 17 Battery Pl., New York.	<b>Boiler Cleaning Compound.</b> Dearborn Ldg. & Chemical Works, Chicago. Johns-Manville, H. W., Co., New York.	<b>Bonds, Rail.</b> Brown, H. P., 120 Liberty St., New York. Chase-Shawmut Co., Newburyport, Mass. Electric Railway Improvement Co., Cleveland, O. Electric Service Supplies Co., 200 Plymouth Bldg., Chicago.	<b>Bonds, Rail—Continued.</b> General Electric Co., Schenectady, N. Y. Goldschmidt Thermit Co., 43 Exchange Pl., New York. Johns-Manville, H. W., Co., New York. Ohio Brass Co., Mansfield, O.	<b>Brackets and Cross Arms.</b> Anderson, A. L. & J. M., Mfg. Co., Boston. Craghead Engineering Co., Cincinnati, O. Electric Railway Equipment Co., Cincinnati, O. Electric Service Supplies Co., 200 Plymouth Bldg., Chicago. Lindsay Bros. Co., Spokane, Wash. Ohio Brass Co., Mansfield, O. Ridlon, Frank, Co., 200 Summer St., Boston. Stuart-Howland Co., Boston. Western Electric Co., Chicago.	<b>Brakes and Brake Parts.</b> Allis-Chalmers Co., Milwaukee, Wis. American Car Co., St. Louis. Brill, The J. G. Co., Philadelphia. Electric Service Supplies Co., 200 Plymouth Bldg., Chicago. General Electric Co., Schenectady, N. Y. Kuhlman, The G. C., Car Co., Cleveland. McGuire-Cummings Mfg. Co., Chicago. National Brake & Electric Co., Milwaukee. Stephenson, John, Co., Elizabeth, N. J. Wason Mfg. Co., Springfield, Mass. Westinghouse Traction Brake Co., Pittsburg, Pa.	<b>Brakeshoes.</b> American Brake Shoe & Fdry. Co., Mahwah, N. J. American Car Co., St. Louis. Barbour-Stockwell Co., Cambridgeport, Mass.
--	--	---	--	--	---	---	--	--	---	--	------------------------------------	--	---	---	---	--	--	--	--	---



**GENUINE  
BELL  
METAL**

# MOTOR BEARINGS

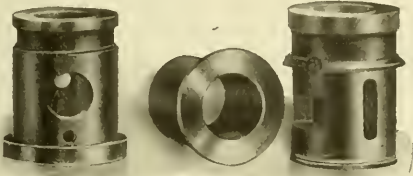

$$\text{ECONOMY} = \frac{\text{Cost per Bearing}}{\text{Number Months Wear}}$$

Did you ever consider the relation that the price of your motor bearings has to the wear they will give? After all, it is a simple question of *wear vs. cost* and might be expressed by the above formula.

If this formula be applied to *Genuine Bell Metal Bearings* and other makes the result will prove conclusively the superiority of the bearings we offer. There is no secret about the superiority of our bearings. It's simply due to two things: the high grade of metal we employ—and the fact that we machine our bearings all over to accurate gauge.

*See pages 286-291, catalogue No. 7, for full list.*

## THE OHIO BRASS CO., Mansfield, O.

# Save Money on Repairs and Parts for Railway Motors

by patronizing our works—the largest of their kind in America—where we

- make Armatures complete, re-shaft and rewind them
- furnish Commutators complete, refilled and assembled
- do all kinds of field work for nearly all different makes of Dynamos and Motors.

We give the best of service. You can pay freight both ways (unless very far distant) and still save money.

**Cleveland Armature Works  
Cleveland, Ohio**

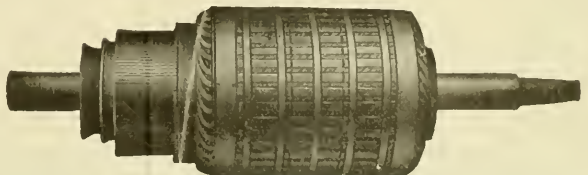
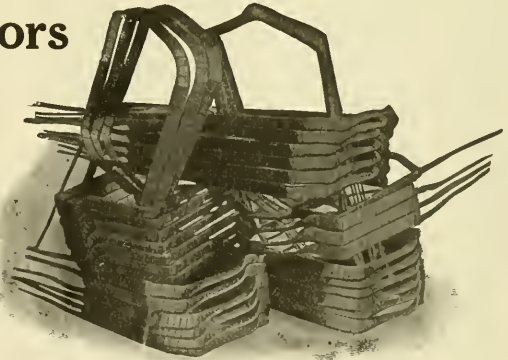

## CLASSIFIED LIST OF ADVERTISERS—Continued.

- Brakeshoes—Continued.**  
Brill, The J. G., Co., Philadelphia.  
Kuhlman, The G. C., Car Co., Cleveland.  
McGuire-Cummings Mfg. Co., Chicago.  
Marshall, R. W., & Co., 95 Liberty St., New York.  
St. Louis Car Co., St. Louis, Mo.  
Standard Brake Shoe Co., Aurora, Ill.  
Stephenson, John, Co., Elizabeth, N. J.  
Wason Mfg. Co., Springfield, Mass.  
Wharton, Wm., Jr., & Co., Philadelphia.  
Wheel Truing Brake Shoe Co., Detroit.
- Bridges.**  
Johann, F. A., 1624 Pierce Bldg., St. Louis.
- Bridge Timbers.**  
Beldler, Francis, & Co., Chgo.
- Brushes, Motors and Dynamos.**  
Electric Service Supplies Co., 200 Plymouth Bldg., Chicago.  
General Electric Co., Schenectady, N. Y.  
National Carbon Co., Cleveland, O.  
Ridlon, Frank, Co., 200 Summer St., Boston.  
Spear Carbon Co., St. Marys, Pa.
- Bumpers, Car.**  
American Car Co., St. Louis.  
Brill, The J. G., Co., Philadelphia.  
Kuhlman, The G. C., Car Co., Cleveland.  
St. Louis Car Co., St. Louis, Mo.  
Stephenson, John, Co., Elizabeth, N. J.  
Wason Mfg. Co., Springfield, Mass.
- Car Cleaner.**  
Gillette Chemical Co., 42 Broadway, New York.
- Car House Doors.**  
Kinnear Mfg. Co., Columbus, O.  
Wilson, J. G., Mfg. Co., New York.
- Car Replacers.**  
Electric Service Supplies Co., 200 Plymouth Bldg., Chicago.  
Fairbanks, Morse & Co., Chgo.  
Ohio Brass Co., Mansfield, O.  
U. S. Metal & Mfg. Co., 25 Broad St., New York.
- Car Roof Paint, Canvas.**  
St. Louis Surfacter & Paint Co., St. Louis, Mo.
- Car Seats.**  
American Car Co., St. Louis.  
Brill, The J. G., Co., Philadelphia.  
Hale & Kilburn Mfg. Co., Philadelphia.  
Heywood Bros. & Wakefield Co., Wakefield, Mass.  
Kuhlman, The G. C., Car Co., Cleveland.  
St. Louis Car Co., St. Louis, Mo.  
Stephenson, John, Co., Elizabeth, N. J.  
Wallace Supply Co., Chicago.  
Wason Mfg. Co., Springfield, Mass.
- Car Signs—(See Signs, Cars and Track).**
- Car Steps.**  
Electric Service Supplies Co., 200 Plymouth Bldg., Chicago.  
Wallace Supply Co., Chicago.
- Car Trimmings—(See Trimmings, Car).**
- Cars, Ballast.**  
Rodger Ballast Car Co., Chgo.  
St. Louis Car Co., St. Louis, Mo.
- Cars, Dump.**  
Fairbanks, Morse & Co., Chgo.  
Middletown Car Works, Middletown, Pa.  
Rodger Ballast Car Co., Chgo.  
Russell Car & Snow-Plow Co., Ridgway, Pa.  
St. Louis Car Co., St. Louis, Mo.
- Cars, Passenger and Freight—Continued.**  
Electric Railway Improvement Co., Cleveland, O.  
Fairbanks, Morse & Co., Chgo.  
Jewett Car Co., Newark, O.  
Johann, F. A., 1624 Pierce Bldg., St. Louis.  
Kuhlman, The G. C., Car Co., Cleveland.  
McGuire-Cummings Mfg. Co., Chicago.  
Niles Car & Mfg. Co., Niles, O.  
Pressed Steel Car Co., Pittsburgh, Pa.  
Rodger Ballast Car Co., Chgo.  
Russell Car & Snow-Plow Co., Ridgway, Pa.  
St. Louis Car Co., St. Louis, Mo.  
Standard Motor Truck Co., Pittsburg.  
Stephenson, John, Co., Elizabeth, N. J.  
Wason Mfg. Co., Springfield, Mass.
- Cars, Pay-As-You-Enter.**  
Pay-As-You-Enter Car Co., 26 Cortlandt St., New York.
- Cars, Rebuilt.**  
Detroit Carbuilding & Equipment Co., Detroit, Mich.
- Cars, Second-Hand.**  
Detroit Carbuilding & Equipment Co., Detroit, Mich.  
Marshall, R. W., & Co., 95 Liberty St., New York.  
Zelnicke, Walter A., Supply Co., St. Louis.
- Cars, Steel.**  
Middletown Car Works, Middletown, Pa.  
Pressed Steel Car Co., Pittsburg.  
St. Louis Car Co., St. Louis, Mo.  
Standard Motor Truck Co., Pittsburg.
- Castings, Brass.**  
Star Brass Works, Kalamazoo, Mich.
- Castings, Iron and Steel.**  
American Brake Shoe & Foundry Co., Mahwah, N. J.  
Green Engineering Co., Com'l Nat. Bk. Bldg., Chicago.  
Lorain Steel Co., Johnstown, Pa.  
National Brake & Electric Co., Milwaukee.
- Catchers—(See Trolley Retrievers and Catchers).**
- Cattle Guards.**  
Fairbanks, Morse & Co., Chgo.
- Cements, Cable and Transformer.**  
Massachusetts Chemical Co., Walpole, Mass.
- Circuit-Breakers.**  
Electric Service Supplies Co., 200 Plymouth Bldg., Chicago.  
General Electric Co., Schenectady, N. Y.  
Western Electric Co., Chicago.
- Coal Handling Machinery—(See Conveyors).**
- Coils—(See Armatures and Coils).**
- Commutators and Parts.**  
Cleveland Armature Works, Cleveland.  
Electric Service Supplies Co., 1024 Filbert St., Phila.  
General Electric Co., Schenectady, N. Y.  
Harrison Elec. & Mfg. Co., 169 South St., New York.  
Homer Commutator Co., Cleveland, O.  
Marshall, R. W., & Co., 95 Liberty St., New York.  
Ohio Brass Co., Mansfield, O.  
Stuart-Howland Co., Boston.
- Compressors, Air.**  
Fairbanks, Morse & Co., Chgo.  
General Electric Co., Schenectady, N. Y.  
National Brake & Electric Co., Milwaukee.  
Westinghouse Traction Brake Co., Pittsburg.
- Concrete Mixers.**  
Contractors' Supply & Equip. Co., Chicago.
- Condensers.**  
Whesler Con. & Eng. Co., New York.
- Condults.**  
Electric Service Supplies Co., 200 Plymouth Bldg., Chicago.  
Western Electric Co., Chicago.
- Conductors.**  
Arnold Company, 131 La Salle St., Chicago.  
Bylesby, H. M., Co., Am. Trust Bldg., Chicago.  
Columbia Construction Co., Milwaukee, Wis.  
Craghead Engineering Co., Cincinnati, O.  
Green Engineering Co., Com'l Nat. Bk. Bldg., Chicago.  
Register, A. L., & Co., 112 N. Broad St., Philadelphia.  
Sanderson & Carter, 52 Willamette, New York.  
Saxton, E., 841 Glensburg R., Washington, D. C.  
Sheaff & Jaastad, 88 Broad St., Boston.  
Stone & Webster Engineering Corp., Boston.  
Wharton, Wm., Jr., & Co., Philadelphia.  
White, J. G., & Co., 49 Exchange Pl., New York.
- Controllers and Attachments.**  
Durkin Con. Handle Co., Arcade Bldg., Philadelphia.  
Electric Service Supplies Co., 200 Plymouth Bldg., Chicago.  
General Electric Co., Schenectady, N. Y.  
Harrison Elec. & Mfg. Co., 169 South St., New York.  
Johns-Manville, H. W., Co., New York.  
Marshall, R. W., & Co., 95 Liberty St., New York.  
Western Electric Co., Chicago.  
Westinghouse Electric & Mfg. Co., Pittsburg.
- Conveyors and Coal Handling Machinery.**  
Green Engineering Co., Com'l Nat. Bk. Bldg., Chicago.  
Northern Engineering Works, Detroit, Mich.
- Cord, Bell and Trolley.**  
American Car Co., St. Louis.  
Brill, The J. G., Co., Philadelphia.  
Electric Service Supplies Co., 1024-24 Filbert St., Phila.  
Kuhlman, The G. C., Car Co., Cleveland.  
St. Louis Car Co., St. Louis, Mo.  
Stephenson, John, Co., Elizabeth, N. J.  
Stuart-Howland Co., Boston.  
Wason Mfg. Co., Springfield, Mass.
- Couplers, Car.**  
American Car Co., St. Louis.  
Brill, The J. G., Co., Philadelphia.  
Kuhlman, The G. C., Car Co., Cleveland.  
McGuire-Cummings Mfg. Co., Chicago.  
Ohio Brass Co., Mansfield, O.  
St. Louis Car Co., St. Louis, Mo.  
Stephenson, John, Co., Elizabeth, N. J.  
Van Dorn & Dutton Co., Cleveland, O.  
Wason Mfg. Co., Springfield, Mass.
- Coverings, Pipe and Boiler.**  
Johns-Manville, H. W., Co., New York.
- Cranes, Hoists and Lifts.**  
American Car Co., St. Louis.  
Brill, The J. G., Co., Philadelphia.  
Brown Hoisting Machinery Co., Cleveland, O.  
Kuhlman, The G. C., Car Co., Cleveland.  
Northern Engineering Works, Detroit, Mich.  
Railway Specialty & Supply Co., Chicago.  
Stephenson, John, Co., Elizabeth, N. J.  
Van Dorn & Dutton Co., Cleveland, O.  
Wason Mfg. Co., Springfield, Mass.
- Cross Arms—(See Brackets and Cross Arms).**
- Crossing Gates—(See Gates and Guards).**
- Crossings, Track—(See Switches).**
- Curtains, Fixtures and Materials—Continued.**  
Electric Service Supplies Co., 200 Plymouth Bldg., Chicago.  
Harrison Stewart, Co., East Newark, N. J.  
Kuhlman, The G. C., Car Co., Cleveland.  
Marshall, R. W., & Co., 95 Liberty St., New York.  
National Lock Washer Co., Newark, N. J.  
Pantanos Co., 11 Broadway, New York.  
St. Louis Car Co., St. Louis, Mo.  
Stephenson, John, Co., Elizabeth, N. J.  
Wason Mfg. Co., Springfield, Mass.
- Cylinder Oil.**  
Power Specialty Co., 111 Broadway, N. Y.
- Derailing Devices.**  
American Frog & Switch Co., Hamilton, O.  
Cincinnati Frog & Switch Co., Cincinnati, O.  
Cleveland Frog & Crossing Co., Cleveland, O.
- Detective Agency.**  
Drummond Detective Agency, New York.
- Diaphragms.**  
Wood, G. S., Great Northern Bldg., Chicago.
- Doors and Fixtures.**  
American Car Co., St. Louis.  
Brill, The J. G., Co., Philadelphia.  
Kuhlman, The G. C., Car Co., Cleveland.  
St. Louis Car Co., St. Louis, Mo.  
Stephenson, John, Co., Elizabeth, N. J.  
Wallace Supply Co., Chicago.  
Wason Mfg. Co., Springfield, Mass.
- Doors, Steel Rolling.**  
Kinnear Manufacturing Co., Columbus, O.  
Wilson, J. G., Mfg. Co., New York.
- Draft, Mechanical—(See Mechanical Draft).**
- Draft Rigging.**  
Van Dorn, W. T., Co., Chgo.  
Wallace Supply Co., Chicago.
- Drills, Track.**  
Brown, H. P., 120 Liberty St., New York.  
Electric Service Supplies Co., 200 Plymouth Bldg., Chicago.  
Fairbanks, Morse & Co., Chgo.  
Marshall, R. W., & Co., 95 Liberty St., New York.  
Read, Francis, Co., Worcester, Mass.  
Ridlon, Frank, Co., 200 Summer St., Boston.
- Drying Appliances.**  
Green Fuel Economizer Co., Matteawan, N. Y.
- Dynamos and Generators.**  
Cleveland Armature Works, Cleveland, O.  
Fairbanks, Morse & Co., Chgo.  
General Electric Co., Schenectady, N. Y.  
National Brake & Electric Co., Milwaukee, Wis.  
Rossiter, MacGovern & Co., 17 Battery Pl., New York.  
Western Electric Co., Chicago.  
Westinghouse Electric & Mfg. Co., Pittsburg, Pa.
- Economizers, Fuel.**  
Green Fuel Economizer Co., Matteawan, N. Y.
- Electrical Instruments.**  
Electric Service Supplies Co., 200 Plymouth Bldg., Chicago.  
General Electric Co., Schenectady, N. Y.  
Johns-Manville, H. W., Co., New York.  
Queen & Co., Philadelphia.  
Western Electric Co., Chicago.  
Westinghouse Electric & Mfg. Co., Pittsburg, Pa.  
Weston Electrical Instrument Co., Newark, N. J.
- Electric Railway Supplies, General.**  
Cleveland Armature Works, Cleveland, O.  
Craghead Engineering Co., Cincinnati, O.

# ST. LOUIS CAR CO.

## ST. LOUIS-MO.

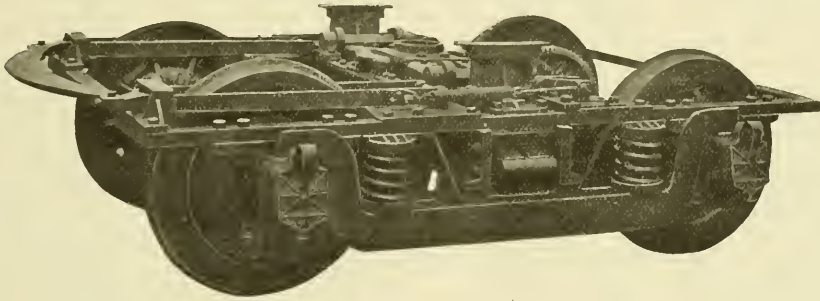

St. Louis Car Company M. C. B. Double Equalizer Type No. 62 Truck

## Details of Construction:

**T**RUCK frames are made of wrought iron forged in one piece, with a heavy fillet in each corner, and planed to receive pedestal jaws and center frames of transoms. Pedestals are of wrought iron and the upper face of each is machined so as to lip on side frame. Wearing faces are machined and provided with oil grooves. Faces which engage the pedestal tie bars are also machined.

Transoms are made of two 10" channels secured to frames by being bolted to machined cast steel side strut castings and bolted to side frame with heavy steel gusset plates.

Removable chafing plates are also provided on the transom channels. Bolsters are of cast steel and provided with end springs to

limit side motion of car body. Bolsters also are provided with removable chafing plates.

Equalizers are of wrought iron and forged with a lug to fit into recess in the journal boxes. Brakes are of the equalized type and arranged to suit cars operated around short curves.

Brake rigging is provided with suitable safety hangers. Ends of hangers and hanger pins are case hardened to reduce the wear to a minimum and prevent rattling.

All bolts used in assembling the trucks are taper finished, turned to a taper of  $\frac{1}{8}$ " per foot, and all holes for bolts are reamed to templates.

All parts of the truck when machined are made to template and all holes are drilled with a jig.

Made in the largest and best equipped  
factory of its kind in the world.

## CLASSIFIED LIST OF ADVERTISERS—Continued.

- Electric Railway Supplies, General—Continued.**  
 Electric Service Supplies Co., 200 Plymouth Bldg., Chicago.  
 Fairbanks, Morse & Co., Chgo.  
 General Electric Co., Schenectady, N. Y.  
 Harrison Elec. & Mfg. Co., 169 South St., New York.  
 Johns-Manville, H. W., Co., New York.  
 Marshall, R. W., & Co., 95 Liberty St., New York.  
 Ohio Brass Co., Mansfield, O.  
 Stuart-Howland Co., Boston.  
 Wallace Supply Co., Chicago.  
 Western Electric Co., Chicago.
- Enamels.**  
 Acme White Lead & Color Works, Detroit, Mich.  
 St. Louis Surfer & Paint Co., St. Louis, Mo.
- Engine Apparatus.**  
 Green Fuel Economizer Co., Matteawan, N. Y.
- Engineers and Contractors.**  
 Arnold Company, Chicago.  
 Bylbyly, H. H., & Co., Chgo.  
 Columbia Construction Co., Milwaukee, Wis.  
 Ford, Bacon & Davis, New York.  
 Register, A. L., & Co., Philadelphia.  
 Roberts & Abbott Co., Cleveland, O.  
 Sanderson & Porter, New York  
 Saxton, E., Washington, D. C.  
 Sheaf & Jaastad, Boston.  
 Stone & Webster Eng. Corporation, Boston.  
 White, J. G., & Co., New York.
- Engines, Gas and Oil.**  
 Buckeye Engine Co., Salem, O.  
 Fairbanks, Morse & Co., Chgo.  
 Westinghouse Machine Co., Pittsburg.
- Engines, Hoisting.**  
 Fairbanks, Morse & Co., Chgo.
- Engines, Steam.**  
 Buckeye Engine Co., Salem, O.  
 Hooven-Owens-Rentschler Co., Hamilton, O.  
 Rossler MacGovern & Co., 17 Battery Pl., New York.  
 Westinghouse Machine Co., Pittsburg.
- Fans, Exhaust and Ventilating.**  
 General Electric Co., Schenectady, N. Y.  
 Green Fuel Economizer Co., Matteawan, N. Y.  
 Western Electric Co., Chicago.  
 Westinghouse Elec. & Mfg. Co., Pittsburg.
- Fare Boxes—(See Electric Railway Supplies).**
- Fare Registers and Register Fittings.**  
 Electric Service Supplies Co., 200 Plymouth Bldg., Chicago.  
 Recording Fare Register Co., New Haven, Conn.  
 Rooke Automatic Register Co., Providence, R. I.  
 Security Register & Mfg. Co., 42 Broadway, New York.
- Feedwater Apparatus.**  
 Green Fuel Economizer Co., Matteawan, N. Y.  
 Wheeler Condenser & Eng'g Co., New York.
- Feed Wire—(See Wire and Cables).**
- Fenders and Guards.**  
 Consolidated Car Fender Co., Providence, R. I.  
 Eclipse Railway Supply Co., Cleveland, O.  
 Electric Service Supplies Co., 1020-24 Filbert St., Phila.  
 McGuire-Cummings Mfg. Co., Chicago.  
 Marshall, R. W., & Co., 95 Liberty St., New York.
- Flangers, Snow.**  
 McGuire-Cummings Mfg. Co., Chicago.  
 Ohio Brass Co., Mansfield, O.  
 Van Dorn & Dutton Co., Cleveland, O.
- Frogs—(See Switches, Frogs and Crossings).**
- Fuel Economizers—(See Economizers, Fuel).**
- Fuses and Fuse Devices.**  
 Chase-Shawmut Co., Newburyport, Mass.
- Fuses and Fuse Devices—Continued.**  
 Electric Service Supplies Co., 200 Plymouth Bldg., Chicago.  
 General Electric Co., Schenectady, N. Y.  
 Johns-Manville, H. W., Co., New York.  
 Western Electric Co., Chicago.  
 Westinghouse Elec. & Manufacturing Co., Pittsburg.
- Gaskets, Bronze.**  
 Power Specialty Co., 111 Broadway, New York.
- Gates and Guards.**  
 Bliss, R., Mfg. Co., Pawtucket, R. I.
- Gear Cases.**  
 Electric Service Supplies Co., 200 Plymouth Bldg., Chicago.  
 General Electric Co., Schenectady, N. Y.  
 Johns-Manville, H. W., Co., New York.  
 Macallen, T. C., Boston.  
 Massachusetts Chemical Co., Walpole, Mass.  
 Ohio Brass Co., Mansfield, O.  
 Okonite Co., Ltd., 253 Broadway, New York.  
 Ridlon, Frank Co., 200 Summer St., Boston.  
 Standard Paint Co., 100 William St., New York.  
 Standard Varnish Works, New York.  
 Stuart-Howland Co., Boston.  
 Western Electric Co., Chicago.
- Generators—(See Dynamos).**
- Gongs—(See Bells and Gongs).**
- Graphite.**  
 Detroit Graphite Co., Detroit, Mich.  
 U. S. Graphite Co., Saginaw, Mich.
- Graphite Paint—(See Paint).**
- Grates, Chain.**  
 Green Engineering Co., Com'l Nat. Bk. Bldg., Chicago.
- Grease—(See Lubricants).**
- Grinders.**  
 Brown, Harold P., 120 Liberty St., New York.
- Guy Anchors—(See Anchors).**
- Harps, Trolley—(See Trolley Poles and Fittings).**
- Headlights.**  
 Electric Service Supplies Co., 200 Plymouth Bldg., Chicago.  
 Fairbanks, Morse & Co., Chgo.  
 General Electric Co., Schenectady, N. Y.  
 Ridlon, Frank Co., 200 Summer St., Boston.  
 St. Louis Car Co., St. Louis, Mo.  
 Stuart-Howland Co., Boston.  
 Trolley Supply Co., Canton, O.
- Headlinings, Passenger Car.**  
 Indestructible Fibre Co., 45 Broadway, New York.
- Heaters, Car, Electric.**  
 Consolidated Car-Heating Co., Albany, N. Y.  
 Johns-Manville, H. W., Co., New York.
- Heaters, Car, Hot Water, and Stoves.**  
 Baker, The Wm. C., Heating & Sup. Co., New York.  
 Cooper Heater Co., The, Dayton, O.  
 Electric Service Supplies Co., 1020-24 Filbert St., Phila.  
 McGuire-Cummings Mfg. Co., Chicago.  
 Smith, Peter, Heater Co., Detroit, Mich.
- Heating and Ventilating Apparatus—(See Mech. Draft).**
- Holists—(See Cranes, Holists and Lifts).**
- Hose Bridges.**  
 Ohio Brass Co., Mansfield, O.
- Hydraulic Machinery.**  
 Watson-Stillman Co., 26 Cortlandt St., New York.
- Inspection.**  
 Central Inspection Bureau.
- Inspection Cars, Gasoline.**  
 Stover Motor Car Co., Freeport, Ill.
- Instruments, Measuring and Testing—(See Electrical Instruments).**
- Insulating Tapes.**  
 General Electric Co., Schenectady, N. Y.  
 Harrison Elec. & Mfg. Co., 169 South St., New York.  
 Massachusetts Chemical Co., Walpole, Mass.  
 Okonite Co., Ltd., 253 Broadway, New York.  
 Western Electric Co., Chicago.
- Insulations and Insulating Material.**  
 Anderson, A. & J. M., Mfg. Co., Boston.  
 Craghead Engineering Co., Cincinnati, O.  
 Electric Railway Equipment Co., Cincinnati, O.  
 Electric Service Supplies Co., 200 Plymouth Bldg., Chicago.  
 General Electric Co., Schenectady, N. Y.  
 Johns-Manville, H. W., Co., New York.  
 Macallen, T. C., Boston.  
 Massachusetts Chemical Co., Walpole, Mass.  
 Ohio Brass Co., Mansfield, O.  
 Okonite Co., Ltd., 253 Broadway, New York.  
 Ridlon, Frank Co., 200 Summer St., Boston.  
 Standard Paint Co., 100 William St., New York.  
 Standard Varnish Works, New York.  
 Stuart-Howland Co., Boston.  
 Western Electric Co., Chicago.
- Jacks.**  
 American Car Co., St. Louis.  
 Brill, The J. G., Co., Philadelphia.  
 Electric Service Supplies Co., 200 Plymouth Bldg., Chicago.  
 Fairbanks, Morse & Co., Chgo.  
 Kuhlman, The G. C., Car Co., Cleveland.  
 Marshall, R. W., & Co., 95 Liberty St., New York.  
 Morden Frog & Crossing Co., Chicago.  
 Security Register & Mfg. Co., New York.  
 Stephenson, John Co., Elizabeth, N. J.  
 Wason Mfg. Co., Springfield, Mass.  
 Watson-Stillman Co., 26 Cortlandt St., New York.
- Joints, Expansion—(See Steam Fittings).**
- Joints, Rail.**  
 Goddard Thermoit Co., 43 Exchange Pl., New York.  
 Rail Joint Co., 29 W. 34th St., New York.
- Joints, Welded—(See Rail Joints, Welded).**
- Journal Boxes.**  
 American Car Co., St. Louis.  
 Brill, The J. G., Co., Philadelphia.  
 Kuhlman, The G. C., Car Co., Cleveland.  
 McGuire-Cummings Mfg. Co., Chicago.  
 St. Louis Car Co., St. Louis, Mo.  
 Stephenson, John Co., Elizabeth, N. J.  
 Symington, T. H., Co., Baltimore, Md.  
 Wason Mfg. Co., Springfield, Mass.
- Journal Lubricators—(See Lubricators).**
- Journal Packing, Steel Wool.**  
 Robertson, Wm., & Co., Great Northern Bldg., Chicago.
- Lamps, Arc and Incandescent.**  
 Anderson, A. & J. M., Mfg. Co., Boston.  
 Electric Service Supplies Co., 200 Plymouth Bldg., Chicago.  
 General Electric Co., Schenectady, N. Y.  
 Ridlon, Frank Co., 200 Summer St., Boston.  
 Stuart-Howland Co., Boston.  
 Western Electric Co., Chicago.  
 Westinghouse Electric & Mfg. Co., Pittsburg, Pa.
- Lamp Sockets.**  
 Electric Service Supplies Co., 200 Plymouth Bldg., Chicago.  
 General Electric Co., Schenectady, N. Y.
- Lantern Globes.**  
 Railway Specialty & Supply Co., Chicago.
- Lifts—(See Cranes, Hoist and Lift).**
- Lightning Arresters.**  
 Electric Service Supplies Co., 200 Plymouth Bldg., Chicago.  
 General Electric Co., Schenectady, N. Y.  
 Stuart-Howland Co., Boston.  
 Western Electric Co., Chics.  
 Westinghouse Elec. & Manufacturing Co., Pittsburg.
- Line Material.**  
 Anderson, A. & J. M., Mfg. Co., Boston.  
 Craghead Engineering Co., Cincinnati, O.  
 Johns-Manville, H. W., Co., New York.  
 Electric Ry. Equipment Co., Cincinnati, O.  
 Electric Service Supplies Co., 200 Plymouth Bldg., Chicago.  
 General Electric Co., Schenectady, N. Y.  
 Macallen, The Co., Boston.  
 Marshall, R. W., & Co., 95 Liberty St., New York.  
 Recording Fare Register Co., New Haven, Conn.  
 Stuart-Howland Co., Boston.  
 Western Electric Co., Chicago.
- Lock and Nut Washers.**  
 Grip Nut Co., 152 Lake St., Chicago.  
 National Lock Washer Co., Newark, N. J.
- Lockers, Metal.**  
 Electric Service Supplies Co., 200 Plymouth Bldg., Chicago.
- Locomotives.**  
 Baldwin Locomotive Works, Philadelphia.  
 Johann, F. A., 1624 Pierce Bldg., St. Louis.
- Locomotives, Electric.**  
 American Car Co., St. Louis.  
 Baldwin Locomotive Works, Philadelphia.  
 Brill, The J. G., Co., Philadelphia.  
 General Electric Co., Schenectady, N. Y.  
 Kuhlman, The G. C., Car Co., Cleveland.  
 McGuire-Cummings Mfg. Co., Chicago.  
 Stephenson, John Co., Elizabeth, N. J.  
 Wason Mfg. Co., Springfield, Mass.  
 Westinghouse Elec. & Manufacturing Co., Pittsburg.
- Locomotives, Gasoline.**  
 Fairbanks, Morse & Co., Chgo.  
 Stover Motor Car Co., Freeport, Ill.
- Lubricants.**  
 Dearborn Drug & Chemical Works, Chicago.  
 Detroit Graphite Co., Detroit, Mich.  
 Galena-Signal Oil Co., Frankl'n, Pa.  
 U. S. Graphite Co., Saginaw, Mich.  
 Whitmore Mfg. Co., Cleveland, O.
- Lumber.**  
 Barnes, G. H., Hardwood Lumber Co., St. Louis, Mo.  
 Beidler, Francis, & Co., Chgo.  
 Berthold & Jennings, St. Louis.  
 Inley Bros. Co., Spokane, Wash.  
 S.-E. Missouri Cypress Co., Campbell, Mo.
- Lumber, Asbestos.**  
 Johns-Manville, H. W., Co., New York.
- Malleable Iron.**  
 St. Louis Car Co., St. Louis, Mo.
- Measuring Tapes.**  
 Lufkin Rule Co., Saginaw, Mich.
- Mechanical Draft.**  
 Green Fuel Economizer Co., Matteawan, N. Y.
- Meters.**  
 Johns-Manville, H. W., Co., New York.  
 Weston Electrical Instrument Co., Newark, N. J.

From the Company's Viewpoint  
the great value of  
**Pay-As-You-Enter Cars**

is in the fact that they increase revenue, increase safety of operation, permit increased speed and promote adherence to schedules.

From the passengers' viewpoint their value is in improved service, greater comfort and freedom from accident.

**Pay-As-You-Enter Cars** have proved to be the greatest improvement of modern times in street railway operation. They have been tried out under the most severe conditions in a number of widely differing cities—and have demonstrated that they are not experimental in any sense.

Companies having lines subject to congestion, and consequently upon which revenue is lost daily by reason of non-payment of fares, should write the undersigned for particulars regarding licenses to build and operate.

All patents are owned exclusively by

**The Pay-As-You-Enter Car Company**

Duncan McDonald  
President

26 Cortlandt Street, New York

Thos. W. Casey  
Manager

## CLASSIFIED LIST OF ADVERTISERS—Continued.

- Molded Goods.  
Massachusetts Chemical Co., Walpole, Mass.  
Wood, G. S., Great Northern Bldg., Chicago.
- Motor Cars, Gasoline.  
Stover Motor Car Co., Freeport, Ill.
- Motors, Electric.  
Cleveland Armature Works, Cleveland, O.  
Fairbanks, Morse & Co., Chgo. General Electric Co., Schenectady, N. Y.  
National Brake & Electric Co., Milwaukee.  
Rosati, MacGovern & Co., 17 Battery Pl., New York.  
Western Electric Co., Chicago. Westinghouse Elec. & Manufacturing Co., Pittsburg.
- Nut Locks.  
Grip Nut Co., 152 Lake St., Chicago.  
National Lock Washer Co., Newark, N. J.  
Railway Specialty & Supply Co., Chicago.  
St. Louis Car Co., St. Louis, Mo.  
U. S. Metal & Mfg. Co., 25 Broad St., New York.
- Nuts and Bolts.  
Grip Nut Co., 152 Lake St., Chicago.  
Lorain Steel Co., Philadelphia. National Lock Washer Co., Newark, N. J.  
Railway Specialty & Supply Co., Chicago.
- Oilers.  
Armstrong Oiler Co., 31st and Chestnut St., Philadelphia.
- Oils—(See Lubricants).
- Overhead Equipment—(See Electric Railway Supplies).
- Packings.  
Electric Service Supplies Co., 200 Plymouth Bldg., Chicago. Johns-Manville, H. W., Co., New York.  
Power Specialty Co., 111 Broadway, New York.
- Packing, Steel Wool Journal.  
Robertson, Wm., & Co., Gt. Northern Bldg., Chicago.
- Paints.  
Acme White Lead & Color Works, Detroit.  
Detroit Graphite Co., Detroit. Massachusetts Chemical Co., Walpole, Mass.  
Standard Paint Co., 100 William St., New York.  
St. Louis Surface & Paint Co., St. Louis, Mo.  
U. S. Graphite Co., Saginaw, Mich.
- Pay-As-You-Enter Cars.  
Pay-As-You-Enter Car Co., 26 Cortlandt St., New York.
- Pipe Bends and Fittings—(See Steam Fittings).
- Plumbago.  
Detroit Graphite Co., Detroit, Mich.  
U. S. Graphite Co., Saginaw, Mich.
- Poles, Metal.  
Creaghead Engineering Co., Cincinnati.  
Electric Railway Equipment Co., Cincinnati, O.  
Electric Service Supplies Co., 200 Plymouth Bldg., Chicago.
- Poles and Ties, Wood.  
Advance Lumber Co., Cleveland, O.  
Barnes, G. H., Hardwood Lumber Co., St. Louis, Mo.  
Beldler, Francis, & Co., Chgo. Berthold & Jennings, St. Louis.  
Churchill Cedar Co., Spokane, Wash.  
Humbird Lumber Co., Sand Point, Idaho.  
Linsley Bros. Co., Spokane, Wash.  
Naugle Pole & Tie Co., 226 La Salle St., Chicago.  
Pacific Coast Pole Co., Spokane, Wash.  
S-E. Missouri Cypress Co., Campbell, Mo.  
Worcester C. H., Co., Tribune Bldg., Chicago.
- Punches—(See Ticket Punches).
- Rail Benders.  
Electric Service Supplies Co., 200 Plymouth Bldg., Chicago. Fairbanks, Morse & Co., Chgo.
- Rail Bonds—(See Bonds, Rail).
- Rail Drills—(See Drills, Track).
- Rail Feed Wire—(See Wire and Cables).
- Rail Joints and Chairs—(See Joints, Rail).
- Rail Joints, Welded.  
Goldsmith Thermit Co., 43 Exchange Pl., New York.  
Lorain Steel Co., Philadelphia.
- Rails, New.  
Lorain Steel Co., Philadelphia. New York Switch & Crossing Co., Hoboken, N. J.  
Wharton, Wm., Jr., & Co., Philadelphia.
- Rails, Relaying.  
Zelner, Walter A., Supply Co., St. Louis.
- Railway Equipment.  
Johns, F. A., 1624 Pierce Bldg., St. Louis.
- Railway Velocpedes.  
Fairbanks Morse & Co., Chgo.
- Registers and Fittings—(See Fare Registers).
- Relays.  
Weston Electrical Instrument Co., Newark, N. J.
- Roofing.  
Johns-Manville, H. W., Co., New York.
- Rubber Goods, Mechanical.  
Wood, G. S., Great Northern Bldg., Chicago.
- Rubber Preservative.  
Wood, G. S., Great Northern Bldg., Chicago.
- Sand Apparatus.  
American Car Co., St. Louis. Brill, The J. G., Co., Philadelphia.  
Electric Service Supplies Co., 200 Plymouth Bldg., Chicago. Kuhlman, The G. C., Car Co., Cleveland.  
Marshall, R. W., & Co., 95 Liberty St., New York.  
Ohio Brass Co., Mansfield, O. Ridion, Frank, Co., 200 Sumner St., Boston.  
St. Louis Car Co., St. Louis, Mo.  
Stephenson, John, Co., Elizabeth, N. J.  
Wason Mfg. Co., Springfield, Mass.
- Sash Balances and Fixtures.  
National Lock Washer Co., Newark, N. J.
- Sash Operating Devices.  
Drouvé, The G., Bridgeport, Conn.  
Lord & Burnham, Irvington-on-Hudson, New York.
- Seats, Car—(See Car Seats).
- Shade Rollers—(See Curtains, Fixtures and Materials).
- Shutters, Steel Rolling.  
Kinney Manufacturing Co., Columbus, O.
- Signals.  
Blake Signal & Manufacturing Co., Boston.  
Telegraph Signal Co., Rochester, N. Y.
- Signal Supplies.  
Railway Specialty & Supply Co., Chicago.
- Skylights.  
Drouvé, The G., Co., Bridgeport, Conn.  
Lord & Burnham, Irvington-on-Hudson, New York.
- Snow Plows, Sweepers and Scrapers.  
American Car Co., St. Louis. Brill, The J. G., Co., Philadelphia.  
Kalamazoo Railway Supply Co., Kalamazoo, Mich.  
Kuhlman, The G. C., Car Co., Cleveland.
- Snow Plows, Sweepers and Scrapers—Continued.  
McGuire-Cummings Mfg. Co., Chicago.  
Russell Car & Snow-Plow Co., Ridgway, Pa.  
Stephenson, John, Co., Elizabeth, N. J.  
Wason Mfg. Co., Springfield, Mass.
- Sockets, Waterproof.  
Johns-Manville, H. W., Co., New York.
- Splicing Compounds and Materials.  
Massachusetts Chemical Co., Walpole, Mass.
- Springs.  
American Car Co., St. Louis. Brill, The J. G., Co., Philadelphia.  
Kuhlman, The G. C., Car Co., Cleveland.  
McGuire-Cummings Mfg. Co., Chicago.  
Marshall, R. W., & Co., 95 Liberty St., New York.  
Railway Steel Spring Co., 71 Broadway, New York.  
St. Louis Car Co., St. Louis, Mo.  
Stephenson, John, Co., Elizabeth, N. J.  
Wason Mfg. Co., Springfield, Mass.
- Sprinkling Cars.  
American Car Co., St. Louis. Brill, The J. G., Co., Philadelphia.  
Kuhlman, The G. C., Car Co., Cleveland.  
McGuire-Cummings Mfg. Co., Chicago.  
Stephenson, John, Co., Elizabeth, N. J.  
Wason Mfg. Co., Springfield, Mass.
- Steam Apparatus.  
Green Fuel Economizer Co., Matteawan, N. Y.
- Steam Fittings, Etc.  
Crane Co., Chicago.  
Davis, The John, Co., Chgo. Simmons, John, Co., 110 Centre St., New York.  
Power Specialty Co., 111 Broadway, New York.
- Steel Cars.  
American Car Co., St. Louis. Brill, The J. G., Co., Philadelphia.  
Kuhlman, The G. C., Car Co., Cleveland.  
St. Louis Car Co., St. Louis, Mo.  
Stephenson, John, Co., Elizabeth, N. J.  
Wason Mfg. Co., Springfield, Mass.
- Steel Tapes.  
Lufkin Rule Co., Saginaw, Mich.
- Stokers.  
Babcock & Wilcox Co., 85 Liberty St., New York.  
Green Engineering Co., Com'l Nat. Bk. Bldg., Chicago.  
Fodel Stoker Co., Dayton, O. Under-Fed Stoker Co. of Am., Chicago.  
Westinghouse Machine Co., Pittsburg.
- Storage Batteries—(See Batteries).
- "Strike-Breakers."  
Drummond Detective Agency, 3 Ann St., New York.
- Superheaters.  
Power Specialty Co., 111 Broadway, New York.
- Switches, Frogs and Crossings.  
American Frog & Switch Co., Hamilton, O.  
Barbour-Stockwell Co., Cambridgeport, Mass.  
Cincinnati Frog & Switch Co., Cincinnati, O.  
Cleveland Frog & Crossing Co., Cleveland, O.  
Fairbanks, Morse & Co., Chgo. Lorain Steel Co., Philadelphia. Morden Frog & Crossing Co., Rookery, Chicago.
- Switches, Frogs and Crossings—Continued.  
New York Switch & Crossing Co., Hoboken, N. J.  
Railway Specialty & Supply Co., Chicago.  
Wharton, Wm., Jr., & Co., Philadelphia.
- Switchboards and Switchboard Instruments.  
Anderson, As & J. M., Mfg. Co., Boston.  
Chase-Shawmut Co., Newburyport, Mass.  
General Electric Co., Schenectady, N. Y.  
Western Electric Co., Chicago. Westinghouse Electric & Mfg. Co., Pittsburg.  
Weston Electrical Instrument Co., Newark, N. J.
- Tapes and Webbing.  
Hopa Webbing Co., Providence, R. I.  
Johns-Manville, H. W., Co., New York.  
Massachusetts Chemical Co., Walpole, Mass.  
Okonite Co., Ltd., 253 Broadway, New York.
- Testing Instruments.  
Weston Electrical Instrument Co., Newark, N. J.
- Ticket Choppers and Destroyers.  
Fatten, Paul B., Salem, Mass.
- Ticket Punches.  
Meyers, Fred J., Mfg. Co., Hamilton, O.  
Woodman Mfg. & Sup. Co., Boston.
- Ties and Poles, Wood—(See Poles and Ties).
- Timber.  
Beldler, Francis, & Co., Chgo. Linsley Bros. Co., Spokane, Wash.  
S-E. Missouri Cypress Co., Campbell, Mo.
- Tools, Pneumatic—(See Pneumatic Tools).
- Track Cleaners and Scrapers.  
American Car Co., St. Louis. Brill, The J. G., Co., Philadelphia.  
Kuhlman, The G. C., Car Co., Cleveland.  
McGuire-Cummings Mfg. Co., Chicago.  
Marshall, R. W., & Co., 95 Liberty St., New York.  
Ohio Brass Co., Mansfield, O. Stephenson, John, Co., Elizabeth, N. J.  
Van Dorn & Dutton Co., Cleveland, O.  
Wason Mfg. Co., Springfield, Mass.
- Track Drills—(See Drills, Track).
- Tracklaying Machinery.  
Holman, D. F., Ry. Tracklayer Co., 1102 Ellsworth Bldg., Chicago.
- Track Tools.  
Electric Service Supplies Co., 200 Plymouth Bldg., Chicago.
- Trimming, Car.  
American Car Co., St. Louis. Brill, The J. G., Co., Philadelphia.  
Curtain Supply Co., Park Row Bldg., New York.  
Kuhlman, The G. C., Car Co., Cleveland.  
National Lock Washer Co., Newark, N. J.  
St. Louis Car Co., St. Louis, Mo.  
Stephenson, John, Co., Elizabeth, N. J.  
Wallace Supply Co., Chicago. Wason Mfg. Co., Springfield, Mass.  
Wood, G. S., Great Northern Bldg., Chicago.
- Trolley Guards.  
Electric Service Supplies Co., 200 Plymouth Bldg., Chicago.
- Trolley Poles and Fittings.  
General Electric Co., Schenectady, N. Y.  
Johns-Manville, H. W., Co., New York.  
Marshall, R. W., & Co., 95 Liberty St., New York.



**TRADE MARK**  
Registered U. S. Patent Office

# The Standard for Rubber Insulation

RAILWAY FEED WIRES insulated with OKONITE are unequalled for flexibility, durability and efficiency, and are in use by the leading Electric Street Railway Companies. OKONITE is preferred above any other insulation for Car Wiring, Telegraph and Telephone Purposes

**Okonite Wires, Okonite Tape, Manson Tape, Candee Weatherproof Wires**

SAMPLES AND ESTIMATES ON APPLICATION

## THE OKONITE Co., Ltd.,

WILLARD L. CANDEE, H. DURANT CHEEVER, Managers.  
GEORGE T. MANSON, Gen'l Supt.; W. H. HODGINS, Secretary.

253 Broadway, NEW YORK

# Galena-Signal Oil Company

FRANKLIN, PA.

THEIR SPECIALTIES

**STREET RAILWAY LUBRICATION** including both rolling stock and power house equipment.

Same skillful *expert supervision* given in this service as in steam railway service has produced very satisfactory results. The business of our Street Railway Department has increased beyond every expectation. In 1906 this department sold ten times the number of barrels of oil sold by the same department in 1903.

We are under contract with many of the largest street and interurban railroads of the country.

We guarantee cost per thousand miles in street railway service when conditions warrant it.

Write to Franklin, Pennsylvania, for further particulars.

**STEAM RAILWAY LUBRICATION** Sole manufacturers of the celebrated *Galena Coach, Engine and Car Oils* for steam railway lubrication.

*Sibley's Perfection Valve Oil* for cylinder lubrication, and *Perfection Signal Oil* for use in railway signal lanterns.

**GALENA RAILWAY SAFETY OIL** Made especially for use in headlights, cab, classification

and tail lights, and for switch and semaphore lamps. Burns equally well with the long time as with the one-day burner; with or without chimney as the burner requires. Is pure water white in color; high fire test, low cold test, and splendid gravity.

CHAS. MILLER, President

# Shawmut Soldered Railbonds

Are the Original Soldered Bonds  
8 YEARS of Service Under ALL  
Conditions Prove Their RE-  
LIABILITY.



WHY Not Try a Proven Bond  
at Least

**SEND FOR OUR PROPOSITION**

See Bulletin No. 29

**CHASE-SHAWMUT CO.**

Newburyport, Mass.

## CLASSIFIED LIST OF ADVERTISERS Continued.

- Trolley Retrievers and Catchers. Earll, C. L., Bowling Green Bldg., New York.
- Electric Service Supplies Co., 1020-24 Filbert St., Phila.
- Milloy Electric Co., Bucyrus. O. Rldon, Frank, Co., 200 Summer St., Boston.
- Trolley Supply Co., Canton, O.
- Trolley Wheels—(See Trolley Poles and Fittings).
- Trolley Wire—(See Wire and Cables).
- Trolleys, Track, Cleveland Armature Works, Cleveland, O.
- Trucks, Car. American Car Co., St. Louis.
- Baldwin Locomotive Works, Philadelphia.
- Brill, The J. G., Co., Philadelphia.
- Kuhlman, The G. C., Car Co., Cleveland.
- McGuire-Cummings Mfg. Co., Chicago.
- St. Louis Car Co., St. Louis, Mo.
- Standard Motor Truck Co., Pittsburg, Pa.
- Standard Varnish Works, New York City.
- Stephenson, John, Co., Elizabeth, N. J.
- Van Dorn & Dutton Co., Cleveland, O.
- Trucks, Car—Continued. Wason Mfg. Co., Springfield, Mass.
- Turbines. General Electric Co., Schenectady, N. Y.
- Hooven-Owens-Rentschler Co., Hamilton, O.
- Westinghouse Machine Co., Pittsburg, Pa.
- Valves—(See Steam Fittings).
- Varnish. Acme White Lead & Color Works, Detroit.
- Electric Service Supplies Co., 200 Plymouth Bldg., Chicago.
- Harrison Elec. & Mfg. Co., 169 South St., New York.
- Marshall, R. W., & Co., 95 Liberty St., New York.
- Massachusetts Chemical Co., Walpole, Mass.
- Milloy Electric Co., Bucyrus. O. Nuttall, R. D., Co., Pittsburg. Rldon, Frank, Co., 200 Summer St., Boston.
- Standard Paint Co., 100 William St., New York.
- Star Brass Works, Kalamazoo, Mich.
- Trolley Supply Co., Canton, O.
- Wallace Supply Co., Chicago.
- Westinghouse Electric & Mfg. Co., Pittsburg, Pa.
- Ventilators. Drouvé, The G., Co., Bridgeport, Conn.
- Lord & Burnham, Irvington-on-Hudson, New York.
- Vestlettes. Bellamy Vestlette Mfg. Co., Cleveland, O.
- Waste, Cotton and Wool. Hagy, J. Milton, Waste Wks., Philadelphia, Pa.
- Railway Specialty & Supply Co., Chicago.
- Water Softening Apparatus. Dearborn Drug & Chemical Works, Chicago.
- Wheels and Axles. American Car Co., St. Louis.
- Brill, The J. G., Co., Philadelphia.
- Griffin Wheel Co., Chicago.
- Kuhlman, The G. C., Car Co., Cleveland.
- Lorain Steel Co., Philadelphia.
- McGuire-Cummings Mfg. Co., Chicago.
- Marshall, R. W., & Co., 95 Liberty St., New York.
- Railway Steel-Spring Co., New York.
- St. Louis Car Co., St. Louis, Mo.
- St. Louis Car Wheel Co., St. Louis.
- Standard Steel Works, Philadelphia.
- Stephenson, John, Co., Elizabeth, N. J.
- Wason Mfg. Co., Springfield, Mass.
- Wheel Grinders. Wheel Truing Brake Shoe Co., Detroit, Mich.
- Whitewashing Machines. Wallace Supply Co., Chicago.
- Window Fixtures. Drouvé, The G., Co., Bridgeport, Conn.
- Wiping Rags. Hagy, J. Milton, Waste Wks., Philadelphia, Pa.
- Wire, Aluminum. Aluminum Co. of America, Pittsburg, Pa.
- Wire, Insulated. Aluminum Co. of America, Pittsburg, Pa.
- American Electrical Works, Providence, R. I.
- General Electric Co., Schenectady, N. Y.
- Okonite Co., Ltd., 253 Broadway, New York.
- Standard Underground Cable Co., Pittsburg, Pa.
- Stuart-Howland Co., Boston.
- Wire and Cables. Aluminum Co. of America, Pittsburg, Pa.
- American Electrical Works, Providence, R. I.
- Bridgeport Brass Co., Bridgeport, Conn.
- General Electric Co., Schenectady, N. Y.
- Okonite Co., Ltd., 253 Broadway, New York.
- Standard Underground Cable Co., Pittsburg, Pa.

## Coach and Car Roof Paint

"Metal" Canvas Preserver—Priming Coat  
"Metal" Canvas Roof Paint—Other Coats



ST. LOUIS SURFACER  
& PAINT COMPANY  
St. Louis, U. S. A.

9

## Your Wife Will Laugh

if you tell her that you purchase electric tape by the pound. When she goes shopping, yardage and quality direct her. Our No. 264 ELECTRIC TAPE

is the highest quality obtainable and the greatest yardage per pound. But don't lose sight of the yardage.

Your jobber will supply you if you insist.

Write for quotations.

MASSACHUSETTS CHEMICAL COMPANY

Operates  
Walpole Varnish Works  
Walpole Rubber Works

PLANT: WALPOLE, MASS.

## Plain and Inlaid LINOLEUM

GUILFORD S. WOOD

ELECTRIC RAILWAY  
NECESSITIES

Great Northern Bldg., Chicago

4

Do you know the difference between

## Motor Packing Waste

and other kinds?

The service each renders, of course, proves the case. A sample order for enough Motor Packing Waste to pack a few motor boxes will show the difference.

All kinds of high-grade Wastes, Wiping Rags, etc.

The J. Milton Hagy Waste Works

433 Spruce Street

Philadelphia

5

## Hamilton-Corliss Engines

AWARDED GOLD MEDAL AT WORLD'S FAIR, ST. LOUIS

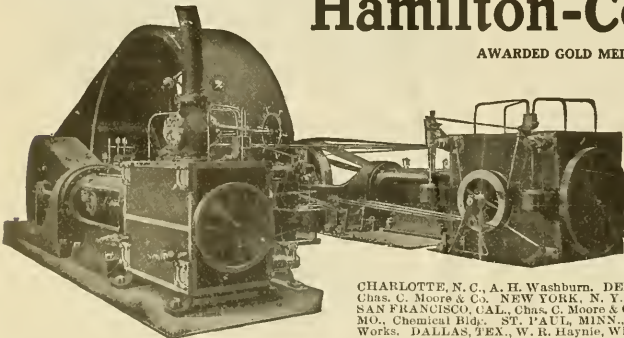

Made in all sizes. We also build other types for all purposes. You are cordially invited to visit our factories and to send for catalog.

The Hooven-Owens-Rentschler Co.

Hamilton, Ohio, U. S. A.

BRANCH OFFICES:

ATLANTA, GA., Equitable Building, BOSTON, MASS., H. E. Rundlett. CHICAGO, ILL., Marquette Building. CHARLOTTE, N. C., A. H. Washburn. DENVER, COLO., Stearns-Roger Mfg. Co. LOS ANGELES, CAL., Chas. C. Moore & Co. NEW YORK, N. Y., 39 Cortlandt St. PITTSBURGH, PA., Machesney Building. SAN FRANCISCO, CAL., Chas. C. Moore & Co. SEATTLE, WASH., Chas. C. Moore & Co. ST. LOUIS, MO., Chemical Bldg. ST. PAUL, MINN., R. B. Whitacre & Co. HONOLULU, S. I., Honolulu Iron Works. DALLAS, TEX., W. R. Haynie, Wilson Bldg. NEW ORLEANS, LA., 47 Hennen Bldg.

2



# Trolley Catchers

THE RIDLON No. 2



Made  
a  
little  
stronger  
than  
the  
service  
requires

When used on single-truck cars having considerable oscillation, the Ridlon will not catch and pull the wheel from the wire, as is the case with many other catchers.

*Catchers sent on 30 days' trial*

## FRANK RIDLON COMPANY

200 Summer St., Boston, Mass.

Pacific Coast Representatives:

**THE H. M. ESTES CO.**

GENERAL OFFICE, SAN FRANCISCO, CAL.

Los Angeles, Cal.

Branch Offices:

Portland, Ore.

3

→ 93.3% ←

# REDUCTION

in the drop over a contact carrying 1,000 amperes was the result of a recent test made in a power house of the Commonwealth Edison Company of Chicago, by the use of the

## HAROLD BROWN ALLOYS.

Contacts amalgamated with these Alloys over ten years ago by the Metropolitan West Side Elevated Ry. Co. of Chicago are *still as bright as when first applied.*

In October, 1897, the South Side Elevated R. R. Co. of Chicago amalgamated the terminals of the bonds used on the third rail and recent investigation showed the contacts to be *perfectly free from oxide and as good as when first installed.*

It is of these Alloys that the

# Plastic Rail Bond

is made.

*The bond that will transmit 3,000 amperes without the slightest injury and show but 5 per cent depreciation after eleven years' severe service.*

Consider these FACTS, or, better still,

**TRY IT.**

**HAROLD P. BROWN,**

120 Liberty Street,  
NEW YORK.

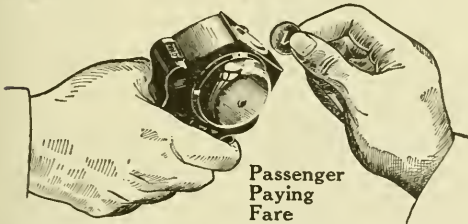

Passenger  
Paying  
Fare

Every nickel collected is registered before reaching the conductor's hand when you use the

# Rooke Automatic Fare Collector

The Rooke System is a revolution in fare-collecting methods, and as far superior to old systems as the trolley car is to the horse car.

¶ Why not ask us to prove it?

**Rooke Automatic Register Co.**

PROVIDENCE

RHODE ISLAND

3

# TUBULAR POLES IRON OR STEEL



FOR  
ELECTRIC  
RAILWAYS  
ELECTRIC  
LIGHTING CO'S  
SIGNAL  
TELEPHONE } SER  
TELEGRAPH } VICE

TRANSMISSION  
LINE  
AND  
CATENARY  
SUSPENSION  
LINE

**ELECTRIC RAILWAY EQUIPMENT CO.**  
General Office: CINCINNATI-O-U-S-A  
Shops: READING PA - WHEELING WVA

# Standard "City and Suburban" High Speed Double Truck "Short Wheel Base"

TYPE O-50

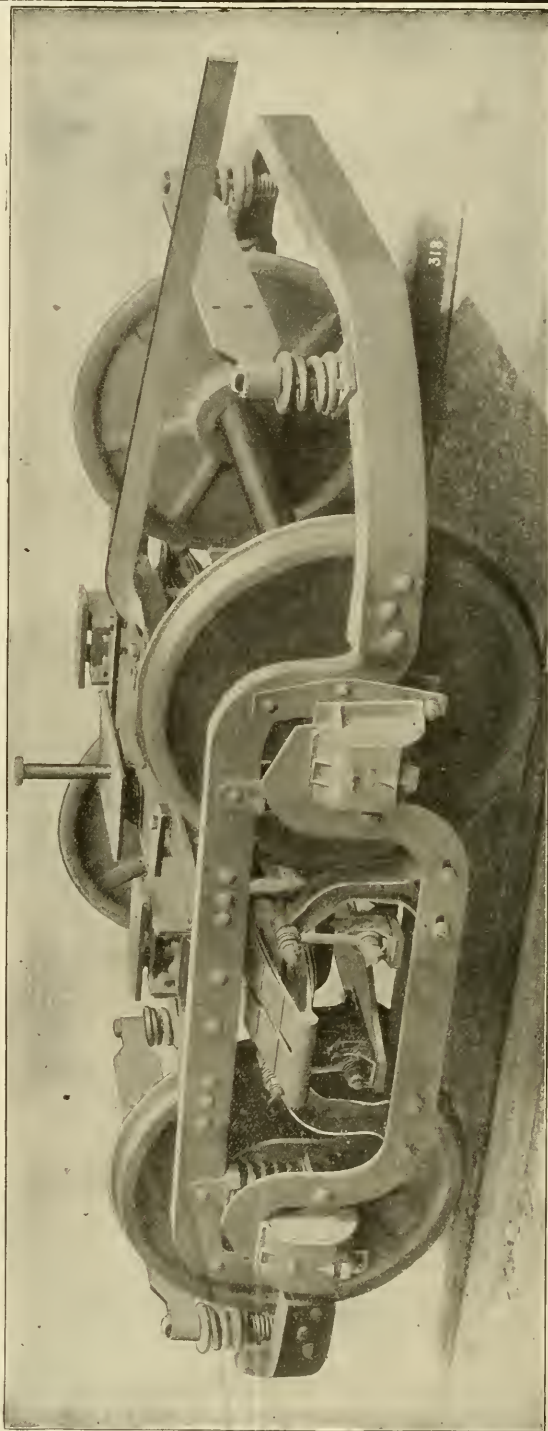

Our new plant is equipped with the most modern truck building machinery and the very best quality of material and workmanship is used in the manufacture of these trucks. M. C. B. standard principles are followed. Frames are made from rolled open hearth steel without welds. We are prepared to build trucks in accordance with purchaser's designs and specifications.

**Standard Motor Truck Company, Frick Bldg., Pittsburg, Pa.**

New York Office: 170 Broadway

Works: New Castle, Pa.

Chicago Office: Fisher Bldg.

# FOR SALE. FOR QUICK DELIVERY

## 6 55-ft. Passenger, Baggage and Smoking Car Bodies

Main Compartment 26' 0"  
 Smoking " 10' 6"  
 Baggage " 10' 0"  
 Seating Capacity, 54

## 8 60-ft. Passenger, Baggage and Smoking Car Bodies

Main Compartment 28' 6"  
 Smoking " 11' 0"  
 Baggage " 8' 0"  
 Seating Capacity, 58

## 5 52-ft. Passenger and Smoking Car Bodies — Double End

Seating Capacity, 60

## 3 52-ft. Passenger and Baggage Car Bodies — Double End

Seating Capacity, 56

## 2 50-ft. Express Car Bodies

*Write or wire us for further information.*

# The Jewett Car Co. Newark Ohio

## THE MIGHTY MIDGET HOT WATER CAR HEATER

Adapted for Large Electric Cars and Long Distance Lines. Exclusively used on Largest Electric Systems. Ask for Catalog

THE WILLIAM C. BAKER HEATING & SUPPLY CO., 143 LIBERTY STREET NEW YORK



## NILES CARS

(The Electric Pullmans)

LARGE, FAST INTERURBANS  
 OUR SPECIALTY

## Niles Car & Mfg. Co.

Works: NILES, OHIO

Sales Office: J. A. HANNA CO.  
 312 Electric Bldg., Cleveland, Ohio

## Middletown Car Works, Inc.

MIDDLETOWN, PA., U. S. A.

LONDON OFFICE: 6 OLD JEWRY, LONDON, E. C.

Steel Frame Cars have proven in steam service far superior to old fashioned Wood Frame Construction. We would be pleased to send you Photographs and Specifications.

Manufacturers of All Kinds of

Steel Frame Box Express Cars. Hopper Ash and Cinder Cars.  
 Rail Laying Cars and Work Cars.

WILLIAM B. DEMING, Export Agent . . . 17 State Street, NEW YORK  
 H. A. CLARK & CO., Domestic Agents . . . 17 State Street, NEW YORK

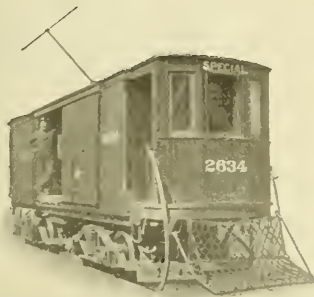

# One Catalogue

sent in response to an inquiry produced by advertising

## is worth a dozen

distributed indiscriminately, because you *know* that practically every man who asks for your advertising matter is interested in your goods and that he is a live prospect worth following up,

but you can't tell how many of the catalogues sent indiscriminately go into the waste basket immediately.

This matter of placing your catalogues, etc., in the hands of interested buyers is only one of the valuable results accomplished by the right kind of advertising.

*Real advertising* will do more good things for any live business than any other one force, and it accomplishes these results at far less cost than any other method or combination of methods.

If you have never considered advertising as a real help to your business—as an efficient aid in a dozen ways of helping sell your goods—ask us to have a representative talk it over with you.

**Electric Railway Review**

160 Harrison Street - Chicago



# GILLETTE SANITARY SPRAY

**CLEANS EVERYTHING  
BUT A GUILTY CONSCIENCE**

Car cleaning made easier and cars kept cleaner.

Does away with the use of water, except in extreme cases, thereby preventing the opening of joints and rotting of timber caused by the use of water.

Kills dust, prevents it from rising while sweeping floors, carpets and upholstery.

It polishes woodwork, mirrors and windows, and preserves varnish and colors.

Kills all germs, thoroughly disinfects and sanitizes the car.

Requires less labor and less expense than any other method of cleaning cars.

Is used in the principal hotels, residences, apartment houses and amusement places, as well as in daily use on the cars of the New York City Ry. Co.

For particulars, address

**GILLETTE CHEMICAL CO.**

42 BROADWAY, NEW YORK CITY

3-6

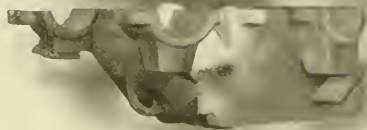

## ECONOMICAL RESULTS ASSURED

by repairing your broken motor cases by the THERMIT PROCESS. The cost of Thermit and appliances for making TEN repairs of the largest size is only a little more than the cost of ONE new motor case. If you do not care to do the work yourselves, we will make the repairs for you, GUARANTEEING results.

*Write for full details, shipping instructions and prices as given in our pamphlet No. 36-Q.*

**Goldschmidt Thermit Co.**

90 West St., New York  
432-436 Folsom Street, San Francisco

## THE BABCOCK & WILCOX COMPANY

85 Liberty Street, New York

Babcock & Wilcox ——— Stirling ——— A & T Horizontal ——— Cahall Vertical

# WATER TUBE STEAM BOILERS

STEAM SUPERHEATERS

Works: Bayonne, N. J. Barberton, Ohio.

MECHANICAL STOKERS

BRANCH OFFICES:

BOSTON, Delta Bldg.  
PHILADELPHIA, 1110-1112 North American Bldg.  
SAN FRANCISCO, 63 First Street  
PITTSBURGH, Farmers Deposit Nat. Bank Bldg.  
NEW ORLEANS, 343 Baronne St.

DENVER, 410 Seventeenth St.  
SALT LAKE CITY, 313 Atlas Block  
WASHINGTON, Colorado Building  
CHICAGO, Marquette Bldg.  
ATLANTA, GA., 1132 Candler Bldg.

CLEVELAND, 706 New England Bldg.  
MEXICO CITY, 7 Avenida, Juarez  
HAVANA, CUBA, 116½ Calle de la Habana  
LOS ANGELES, 321 Trust Bldg.  
CINCINNATI, O., Traction Bldg.

# HEINE Water Tube BOILERS

THE KIND THAT ARE IMITATED

ARE MANUFACTURED ONLY BY THE

**HEINE SAFETY BOILER COMPANY**

421 Olive Street, St. Louis, Mo.

CAR ADVERTISING

# Barron & Collier

ALMOST EVERYWHERE  
Flat Iron Building, New York.



**ECLIPSE  
Life Guard**

Manufactured by the  
ECLIPSE RAILWAY SUPPLY CO.  
Cleveland, Ohio



**It's Great!**

Have you received a working model of the Atlas Anchor?

Ask for one—free.

THE ATLAS ANCHOR CO., Cleveland, Ohio



NULLI SECUNDUS

J P STOKES

THE UNDER-FEED STOKER CO. OF AMERICA. WARRENTON, OREGON. CHICAGO.



WE NOW MAKE 75% OF THE TROLLEY WHEELS.  
WE WANT TO MAKE THE OTHER 25%.

THE STAR BRASS WORKS  
KALAMAZOO, MICH.



**BALDWIN LOCOMOTIVE WORKS**  
BURNHAM, WILLIAMS & CO., PHILADELPHIA, PA., U. S. A.

Builders of **LOCOMOTIVES OF EVERY DESCRIPTION**  
Including **ELECTRIC LOCOMOTIVES** and

## ELECTRIC TRUCKS



**STANDARD STEEL WORKS,** HARRISON BUILDING PHILADELPHIA, PA.

**SOLID FORGED ROLLED AND STEEL TIRED WHEELS** ELLIPTIC AND COIL SPRINGS  
mounted on axles and fitted with Motor Gears for Electric Railway Service

# PIPE FITTINGS AND VALVES

FOR THE  
HEATING AND PLUMBING TRADE

TRADE  MARK

## JOHN SIMMONS Co.

104-110 Centre Street, NEW YORK

# THE LORAIN STEEL COMPANY

**Girder Rails and High Tee Rails**  
**High-Grade Special Track Work**

GENERAL OFFICES  
THE PENNSYLVANIA BUILDING, PHILADELPHIA, PA.

**WESTERN ELECTRIC**  
 COMPANY  
 CHICAGO DENVER PITTSBURG  
 SAINT LOUIS CINCINNATI  
 SAN FRANCISCO SEATTLE SALT LAKE CITY LOS ANGELES  
 SAINT PAUL CINCINNATI PHILADELPHIA  
 NEW YORK ATLANTA PHILADELPHIA

**Victor Combination Meter**

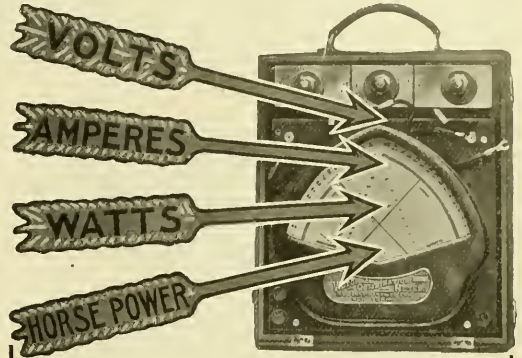

**FOUR READINGS AT ONCE**

Tells at a glance the voltage, current, power consumed in kilowatts, and the horsepower consumption on any direct current circuit.

Accomplishes the results of three meters.

Is substantial in construction, permanent in calibration, requires a minimum of energy to operate, is dead beat, unaffected by temperature variations, and beautifully finished. Made in two types—Portable and Switchboard.

Write nearest Branch for Catalog #4.



**H. W. JOHNS-MANVILLE CO.**

- |              |             |               |
|--------------|-------------|---------------|
| NEW YORK     | PITTSBURG   | MINNEAPOLIS   |
| MILWAUKEE    | CLEVELAND   | SAN FRANCISCO |
| CHICAGO      | BUFFALO     | LOS ANGELES   |
| BOSTON       | BALTIMORE   | SEATTLE       |
| PHILADELPHIA | NEW ORLEANS | DALLAS        |
| ST. LOUIS    | KANSAS CITY | LONDON        |

727

**D. C. GENERATORS**

One of the reasons why W. E. Direct Current Generators are so efficient is because we use Laminated Cast-In Pole Pieces

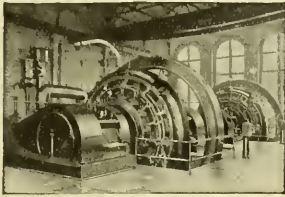

There are many other good reasons that our Bulletin No. 5112-C will tell you all about. Get a copy of it. Write today. Remember—we make prompt deliveries

**For Public Utility Corporations**

**PREVENTION OF ACCIDENTS AND BREAKDOWNS**

should be the first consideration in street railway power plants. Crane cast steel valves and fittings cost more, but they cannot be ruptured under any conditions met with in practice, and the extreme high temperatures of superheated steam do not affect them. Then, too, steel valves and fittings are cheaper in the long run, as they last indefinitely without repairs.

**CRANE STEEL VALVES**

These valves have pure nickel seats and nickel-steel stems. As nickel has the same co-efficient of expansion as steel, seats cannot work loose. Nickel does not deteriorate under excessive temperatures, while bronze and other alloys fail at about 600° Fahrenheit. With proper usage the stems and seats should last as long as valve bodies.

All parts of our steel valves are made in our own works under the most rigid inspection and tests, which insure castings of uniform quality.

We solicit correspondence regarding steel valves and fittings.

**CRANE CO.**  
 CHICAGO  
 ESTABLISHED 1855



# CLASSIFIED ADVERTISEMENTS

Undisplayed advertisements are inserted under this heading at the uniform rate of one cent a word; minimum charge twenty-five cents. Replies directed to this office will be forwarded when required to any address in the United States, Canada or Mexico without extra charge. Advertisements received at the Chicago office by 9 a. m. Thursday will appear in the issue for the same week.

## POSITIONS WANTED.

Storeroom man wishes to make change. At present employed; can furnish first-class reference from present employers. Able to do any kind of office work. Address "Storeroom," care of Electric Railway Review, Chicago.

Position as chief electrician or superintendent; 16 years' experience lighting, power and traction work, alternating and direct current; graduate of well-known school; excellent testimonials; discharged. Address "No. 529," Electric Railway Review, Chicago.

Auditor, experienced in electric railway and lighting and construction accounting, wants position with fair-sized company. Energetic and good systematizer. Best references. Address "No. 527," care of Electric Railway Review, Chicago.

Position of chief motorman or instructor by a first-class competent man who has had 12 years' experience in that line. Thoroughly understands economy in regard to use of power and care of rolling stock; familiar with quadruple equipments and air brakes; highest references. Address "Chief Motorman," care of Electric Railway Review, Chicago.

Position wanted—The manager of a large railway, lighting and gas plant must make a change in his position owing to an unfavorable climate. Has held managerial positions for 10 years and is thoroughly familiar with the construction, organization and operation of electric railways. Correspondence solicited. Exceptional references. Address "No. 539," care of Electric Railway Review, Chicago.

Position Wanted—Have had wide experience in all kinds of street railway work, estimating, specifications, superintending and directing, overhead, underground and power station construction. Have for three years been superintendent of lines for large Massachusetts railway company. Technical education. Nine years' experience. Age 30 years. Wide acquaintance. Best of references. Address "No. 535," care of Electric Railway Review, Chicago.

## POSITIONS WANTED.

Graduate civil engineer, Cornell University 1902, experienced in field work and trade journalism, now engaged, desires work with technical journal or publicity department of manufacturing establishment. Address "No. 525," care of Electric Railway Review, Chicago.

Wanted—Position with interurban road by an engineer having eight years' experience in power station and general railway design and construction work. Age 37, best references furnished. Prefer position with road now under construction. Address "No. 534," care of Electric Railway Review, Chicago.

Position wanted by first-class engineer and machinist with 16 years' practical experience with compound Corliss engines, Allis-Chalmers and Westinghouse steam turbines, surface condensers, A. C. and D. C. electrical apparatus. Age 35. All references. Address "No. 532," care of Electric Railway Review, Chicago.

Experienced and efficient engineer with power station experience (both planning and construction, as chief engineer and as superintendent of construction) desires position with operating company as engineer, assistant to manager or superintendent. Address "No. 518," care of Electric Railway Review, Chicago.

Young man, 30 years of age, who has nearly completed a course of "Electric Lighting and Railway" in the International Correspondence Schools, desires position which will give him practical experience in power house and switchboard work. Willing to start at a nominal salary. Address "No. 526," care of Electric Railway Review, Chicago.

An engineer, experienced in the handling and organizing of station crews, with 10 years' experience as chief engineer in both construction and operation, as well as reconstructing old ones on a modern basis. All voltages up to 15,000, both railway and lights. Salary or per cent, depends on results. I am looking for a reputation as well as salary. Address "No. 536," care of Electric Railway Review, Chicago.

## BUSINESS OPPORTUNITIES.

WANTED—RAILWAY SPECIALTIES. WE HAVE OUR OWN MANUFACTURING AND SELLING ORGANIZATIONS, WITH FACILITIES FOR SELLING THE RAILWAY TRADE. WE DESIRE TO SECURE FOR MANUFACTURE AND SALE SOME GOOD RAILWAY SPECIALTIES. ADDRESS "H. M." CARE OF ELECTRIC RAILWAY REVIEW, CHICAGO.

## POSITIONS OPEN.

Technical men. Positions open in all departments. Write today if you will consider better position, change of location. Twelve offices. Service confidential. HAPGOODS, 305 Broadway, New York, or 1010 Hartford Bldg., Chicago.

Wanted—By a large street railway and lighting company, having 14 storerooms, a thoroughly experienced man, capable of taking inventories. Permanent position. Must be able to furnish best of references as to character and ability. Address "No. 538," care of Electric Railway Review, Chicago.

Master mechanic for a property having 150 to 200 cars. Must be experienced, practical and able to run shop on economical basis. Opportunity for good man to make a record. Prefer someone from middle west. Salary \$125 to \$150. Address "No. 537," care Electric Railway Review, Chicago.

## MISCELLANEOUS WANTS.

What have you to sell in the way of second-hand equipment, machinery or material? Buyers read the "For Sale" cards on the following page and there is the place to tell your story. "For Sale" cards are inexpensive—only \$1.20 an inch (measuring 1 inch deep by 1½ inches wide) per insertion. Special rates on contracts for 100 inches or more to be used within one year. Now is the time to send your order to Electric Railway Review, 160 Harrison St., Chicago.

## MISCELLANEOUS WANTS.

Want to buy second-hand equipment, machinery or material? A card inserted in the Electric Railway Review, stating just what you want, will bring immediate response. The cost is small—only \$1.20 an inch (measuring 1 inch deep by 1½ inches wide) per insertion. Send orders to Electric Railway Review, 160 Harrison St., Chicago.

## BOOKS AND PUBLICATIONS.

Ask us about any book on electric railway and allied subjects. We publish some and sell all that are in print. The Wilson Company, 160 Harrison Street, Chicago.

Copies of the Street Railway Review of January and February, 1906, are wanted. Name condition and price. Address "No. 208," care of Electric Railway Review, Chicago.

Wanted—Copy of the Electric Railway Review of January 12, 1907, in good condition. State price in your answer. Address "No. 530," care of Electric Railway Review, Chicago.

We want your friends to read the Electric Railway Review. You will do them—and us—a favor by sending their addresses. We will gladly mail free sample copies. Electric Railway Review, 160 Harrison Street, Chicago.

Interstate commerce national legislation to July 1, 1906, is fully covered in our reference pamphlet. It contains the full text of the act to regulate commerce as amended, including the Elkins and Hepburn acts, and of the supplementary act relating to the testimony of witnesses before the interstate commerce commission. It also contains the texts of the expedition act, the anti-trust act of 1890, the employers' liability act and the safety equipment laws. Difference in type shows the parts expunged from, and the parts added to, the interstate commerce and Elkins acts by the Hepburn act. This pamphlet is of special value to railway men and lawyers. Mailed prepaid for 25 cents in stamps or coin. Special prices for quantities. The Wilson Company, 160 Harrison St., Chicago.

## If You Have a Position for a High Grade Man

you can quickly secure his services in one of two ways

- by answering "Positions Wanted" advertisements on this page, or
- by advertising on this page under the heading, "Positions Open"

*Either plan will prove a winner—try it now*





Our New Catalogue is nearly ready  
Get on our Mailing List

**GENERAL STORAGE BATTERY CO**

Works, Boonton, N. J. Offices, 42 Broadway, N. Y.



**R.W. MARSHALL & CO.**

95 and 97 Liberty St., NEW YORK

Second-Hand Machinery and Equipment

**ELECTRIC RAILWAY MATERIALS**

The Recording Fare Register Company



New Haven, Conn.

**RAILS**  
Locomotives Cars Etc.  
Bought & sold  
Walter ZELNICKER Supply Co.  
ST. LOUIS

**FOR SALE CHEAP!**

One 14x22 eight-wheel locomotive  
Ten 34-foot 50,000 capacity flat cars  
Two Greenleaf turntables  
70 box cars, 40 and 50,000 capacity  
80 Good Second-hand Bridges  
Specifications and Blue Prints on application  
**F. A. JOHANN**  
1624 Pierce Bldg., St. Louis, Mo.

**TICKET PUNCHES**

Our Cast Steel Ticket Punches are a most universally used for cancelling transfer and other tickets.

We handle all kinds of Railway Supplies.



**R. Woodman Mfg. & Supply Co.**  
63 Oliver St., BOSTON, MASS., U. S. A.

One cent a word for want ads in the Electric Railway Review.

**WANTED:**

About 200 feet of light, second-hand trolley bridges to use for wharf purposes in Maine.

MUST BE CHEAP FOR CASH.

Address Lock Box 335, GREENFIELD, MASS.



**The Fred. J. Meyers Mfg. Co.** Hamilton, O.

Largest Manufacturers in the World of TICKET and CONDUCTORS' PUNCHES

Send for catalog of 75 different styles of punches with 1000 different dies.  
Write for special prices.

**ROSSITER, MACGOVERN & CO. (Inc.)**  
90 West Street, New York

**ENGINES** Boilers, Locomotives, Cars,  
**GENERATORS** 2nd Hand  
**MOTORS**

Transformers, Railway, A. C. & D. C.

**P & B INSULATING VARNISHES**

Possess the highest insulative efficiency. Meet every requirement in electrical work.

**P & B ELECTRICAL COMPOUNDS**

**P & B INSULATING TAPE**

**THE STANDARD PAINT COMPANY,**  
100 WILLIAM ST., NEW YORK.

BRANCHES: CHICAGO, ST. LOUIS, KANSAS CITY, PHILADELPHIA, BOSTON, NEW ORLEANS

**HARTSHORN'S SPRING SHADE ROLLERS**

Used the World Over Wherever Cars are Run



**STEWART HARTSHORN CO.**  
EAST NEWARK, N. J.

**VOLTALAC**

FOR INSULATING ARMATURE AND FIELD COILS

Almost Every Big Electric Railway in the U. S. and Europe uses it.

**STANDARD VARNISH WORKS**

LONDON NEW YORK CHICAGO

**Electric Railway Material**  
of every description

**F. P. HARRISON ELECTRIC & MFG. CO.**  
(Incorporated)  
169-170 South St. NEW YORK

Advertise in the Electric Railway Review

To get an employe.  
To secure a job.  
To sell second-hand machinery, cars, etc.

Want Ads cost only one cent a word per insertion. Special rates on "For Sale" Cards—ask about them.

THE **Bellamy Vestlette**

For Street Railway Conductors

**ABSOLUTELY SAFE.** Money cannot be lost or stolen from these pockets  
**OVER 150,000 IN USE**

Saves the price of a coat yearly. Conductor's uniform always presentable. Adopted as a part of the uniform by over 200 Street Railway Companies. Price \$2.00, sent to any address prepaid, where we have no agent. Agents wanted on every line.



**The Bellamy Vestlette Mfg. Co.,** Cleveland, O.  
and A. F. JURY, 265 Yonge St., Toronto, Canada

Patented April 27, 1897

**THE ARNOLD COMPANY**

ENGINEERS-CONSTRUCTORS  
ELECTRICAL - CIVIL - MECHANICAL  
181 LA SALLE STREET  
CHICAGO

**A. L. REGISTER & CO.**

Engineers and General Contractors—Electric Railway  
112 North Broad St. PHILADELPHIA, PA. Established 1889

**SHIMER & CHASE CO.**

Experienced Promoters of Electrical Railway Projects  
Correspondence Solicited OMAHA, NEB.

**H. M. Bylesby & Company**

Incorporated

ENGINEERS

American Trust Bldg., Chicago

Design, Construct and Operate  
Railway, Light, Power and  
Hydraulic Plants

EXAMINATIONS AND  
REPORTS

A. U. Jaastad

P. J. Harleman

F. E. Greenwood

**SHEAFF & JAASTAD**

ENGINEERS

Broad Exchange Building, 68 Broad Street,

BOSTON, MASS.

**CENTRAL INSPECTION BUREAU**

Inspection of Rails, Ties, Cars, Motors, Bridges, Buildings, Etc.  
17 STATE STREET - - - - NEW YORK CITY

**J. G. WHITE & COMPANY**

INCORPORATED

**Engineers, Contractors**

43-49 Exchange Place,  
41-43 Wall Street

New York, N. Y.

Principal Philippine Office: Manila, P. I.

**LINE MATERIAL**

ELECTRIC SUPPLIES FOR RAILWAYS, POWER PLANTS, ETC.  
THE CREAGHEAD ENGINEERING CO., 348 Main Street, Cincinnati, Ohio

WRITE TO **MODEL STOKER COMPANY** DAYTON OHIO

for detailed information about the best

**AUTOMATIC SMOKELESS FURNACE**

**Surface, Jet and Barometric Condensers****Edwards Air Pumps Centrifugal Pumps****Water Cooling Towers****Wheeler Condenser & Engineering Company**

West and Cedar Streets, New York Works, CARTERET, N. J.  
Mouadnock Block, CHICAGO, ILL.

**HART CONVERTIBLE BALLAST GONDOLA AND CONSTRUCTION CAR**

RODGER BALLAST CAR CO., Railway Exchange, CHICAGO

**RE-ENFORCED SPOKE WHEELS**

For City and Suburban Cars

ST. LOUIS CAR WHEEL CO., St. Louis, Mo.

**SANDERSON & PORTER****ENGINEERS AND CONTRACTORS**

EXAMINATIONS - REPORTS - DESIGNS - SPECIFICATIONS  
CONSTRUCTION - EQUIPMENT - SUPERVISION AND MANAGEMENT  
OF RAILWAY, LIGHT AND POWER, PROPERTIES

**HYDRO-ELECTRIC DEVELOPMENTS**

52 WILLIAM STREET NEW YORK

**The Roberts & Abbott Co.**

E. P. ROBERTS

ENGINEERS

W. H. ABBOTT

**Electric Railways, Light and Power**

Complete Industrial Plants Water Power Development

CLEVELAND CHICAGO PHILADELPHIA BALTIMORE

**STONE & WEBSTER ENGINEERING CORPORATION****CONSTRUCTING ENGINEERS**

147 MILK STREET, BOSTON

ELECTRIC RAILWAY, LIGHT & POWER PLANTS  
WATER POWER DEVELOPMENTS

**SPRINGS—TIRES—STEEL-TIRED WHEELS RAILWAY STEEL-SPRING CO.**

General Offices: 71 Broadway, New York

**WHEEL TRUING BRAKE SHOES**

Repair Crippled Wheels While Running

THE WHEEL TRUING BRAKE SHOE CO., Detroit, Mich.

**TRACKLAYING BY MACHINERY**

SIMPLE, RAPID AND ECONOMICAL

D. F. HOLMAN RAILWAY TRACKLAYER CO., 1102 Ellsworth Bldg., Chicago

**ELECTRIC HEATERS**

For All Classes of Cars

New York Consolidated Car-Heating Co. Chicago

**Gongs For Street Cars Bells**

G. C. REITER, Canton, Ohio

**For Sale**

Cards produce results in the  
Electric Railway Review

**Complete Plants for the Rapid Handling of Material**

Every Sort of Hoisting Apparatus

BROWN HOISTING MACHINERY CO. Cleveland, Ohio

**YOU** have a man—a specialist  
**I**n his line—in charge of each  
of your operating and mechanical  
departments. Why not apply the  
same idea to your advertising?

The Van Valkenburgh Advertising Service is strictly an individual service based on a careful study of your road and the possibilities of your service and territory, and all matter and mediums used are those best adapted to reach your particular public and interest them in your particular proposition.

Will you let us outline a plan based on this specialized service?



**E. C. Van Valkenburgh**  
**Promotional Advertising**  
**for Electric Railways**  
 2117 West 102d Street, Chicago

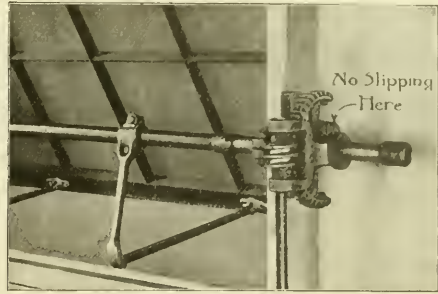

**The Ventilation**

of your Shops, Foundries and Car-Barns is made especially effective by a speedy, positive and easily manipulated

**Sash Operating Apparatus**

which automatically locks the sash at any position. *Let us send you our catalogue*

**LORD & BURNHAM COMPANY**  
 Irvington-on-Hudson, N. Y.

THE RAILWAY SPECIALTY AND SUPPLY CO.

**SPECIAL TRACK WORK**

Great Northern Building  
 CHICAGO

**THE NATIONAL LOCK WASHER CO., NEWARK, N. J.**

Curtains - Curtain Fixtures - Sash Locks - Sash Balances - Nut Locks  
 CHICAGO OFFICE: 419 MONADNOCK BLOCK

**HOT WATER HEATERS for Cars**

THE PETER SMITH HEATER CO., Detroit, Mich.

**THE CINCINNATI FROG & SWITCH COMPANY, CINCINNATI, OHIO**

FROGS, SWITCHES, CROSSINGS, CURVES, SWITCH STANDS

RAIL BRACES AND SPECIAL TRACK WORK

**BRAKESHOOES**  
 STANDARD  
 BRAKESHOE COMPANY  
 GEN'L OFFICES & WORKS - AURORA, ILL. - CHICAGO OFFICE, 315 W. EXCH.

**GEARS AND PINIONS**

FOR ALL TYPES OF MOTORS  
 THE VAN DORN & DUTTON CO., CLEVELAND, OHIO

**FOSTER SUPERHEATERS**

GREATLY INCREASE EFFICIENCY AND POWER OF STEAM TURBINES.

**POWER SPECIALTY COMPANY**  
 111 Broadway, New York



CONTINUOUS JOINT

Over 25,000 miles in use



WEBER JOINT

Rolled from Best Quality Steel



WOLHAUPTER JOINT

Catalogs at Agencies  
 Baltimore, Md. Portland, Ore.  
 Boston, Mass. Seattle, Wash.  
 Chicago, Ill. St. Paul, Minn.  
 Denver, Colo. St. Louis, Mo.  
 Pittsburg, Pa. Troy, N. Y.  
 London, Eng. Montreal, Can.

HIGHEST AWARDS—Paris, 1900;  
 Buffalo, 1901; St. Louis, 1904

Additional safety and economy in **Track Maintenance** has been proved by the use of Continuous, Weber and Wolhaupter base-supported rail joints—after ten (10) years' service, having a record of over 25,000 miles in use—the extent of which is evidence of their excellence.

**THE RAIL JOINT COMPANY**

General Offices: 29 West 34th Street, New York City  
 Makers of Rail Joints for Standard and Special Rail Sections, also Girder, Step or Compromise, and Insulating Rail Joints, protected by patents in United States and Foreign Countries.

# The Lindsley Brothers Company

Producers and Shippers of

and Manufacturers of

## WESTERN CEDAR POLES

## RED FIR CROSS ARMS

Eastern Sales Office, Monadnock Bldg., CHICAGO

SPOKANE, WASHINGTON

### POLES and PILING

20,000 35s and 40s, Ready to Ship at Once  
S-E. MISSOURI CYPRESS CO., CAMPBELL, MO.

#### G. H. BARNES HARDWOOD LUMBER CO.

Office and Yard: Main and Warren Sts., ST. LOUIS, MO.

Ties, Car Oak, Poplar, Ash, Cherry, Plain and Quartered Oak

#### GRIFFIN WHEEL CO.

CHICAGO

CHILLED IRON CAR WHEELS

IRON OR STEEL AXLES

#### C. H. WORCESTER CO. CEDAR POLES

PRODUCERS AND WHOLESALERS

Suite 1710 Tribune Building

CHICAGO

#### Idaho Cedar Poles

PACIFIC COAST POLE CO.

SPOKANE, WASH.

We have in our Chicago Yard available for RUSH SHIPMENTS a SELECTED STOCK of POLES and TIES

#### NAUGLE POLE AND TIE CO.

Chicago Office, 226 La Salle Street

We are Producers and Wholesale Dealers in Western

#### CEDAR POLES

Yards in Washington, Idaho, Montana and British Columbia

WRITE US FOR DELIVERED PRICES

CHURCHILL CEDAR CO., Box 1409, Spokane, Wash.

#### CHESTNUT POLES

Cedar, Oak and Chestnut Ties

FROM OUR OWN TIMBER LANDS

THE ADVANCE LUMBER CO.

CLEVELAND, OHIO

#### 40% SAVED

BY USING

#### Lumen Bronze Axle Bearings

Cast in metal mold—require no-machine finish

Lumen Bearing Company

BUFFALO — TORONTO

Why not cut your packing bill in half?

#### STEEL WOOL JOURNAL PACKING

will do this for your road, as it has for many others. It will also save one-third in oil consumption and an appreciable amount of labor and wear. And it prevents hot boxes positively.

*If you are open to conviction, send for free sample and test it thoroughly*

WM. ROBERTSON & COMPANY

General Office: Great Northern Bldg., CHICAGO  
Factory: 75 S. Jefferson St., BATTLE CREEK, MICH.

12

#### TRACK DRILLS

MADE IN TWO SIZES

With automatic friction feed. Lower gears cased in to protect them from dirt.

Send for circular and prices.

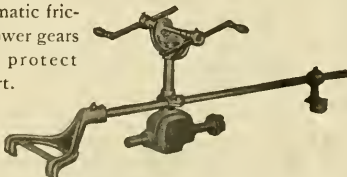

FRANCIS REED CO. WORCESTER, MASS.



### 10c per day

will heat that car if you use a COOPER HEATER

Ask for descriptive matter

The Cooper Heater Co., Dayton, Ohio

9

# BUCKEYE ENGINE CO.

SALEM, OHIO

Builders of High Class

## STEAM AND GAS ENGINES

in powers from 25 to 10,000 H. P.

Correspond with us before placing orders.

Catalogues on application.



Factory of The Milloy Electric Company  
Bucyrus, Ohio

## The Milloy Trolley Base

built in our new and specially equipped factory, insures a quality which will give excellent service under ordinary and extraordinary conditions.

The Milloy Base is unusually low, has even tension on high or low wire. Has no fulcrum, no friction, no oil, no center post. Always efficient. Particulars on request.

**THE MILLOY ELECTRIC COMPANY**  
Bucyrus, Ohio

## Hydraulic Jacks

The different styles and sizes of Watson-Stillman Jacks number 400. No matter what your particular job may be, we have the hydraulic jack to handle it with greatest convenience, dispatch and economy.

No matter whether the load is lighter or heavy, we have the tool. Every Watson-Stillman tool is guaranteed.

Send for Jack Catalogue and you will see a sure way out of your Jack troubles.

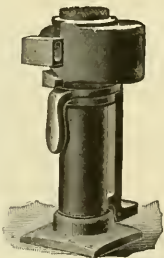

## THE WATSON-STILLMAN CO.

Main Office, 26 Cortlandt Street, New York City  
Branch Office, 453 The Rookery, Chicago, Ill.

# Ten Seconds is Sufficient

for your dispatcher to set a stop signal against any car or train approaching a meeting point—

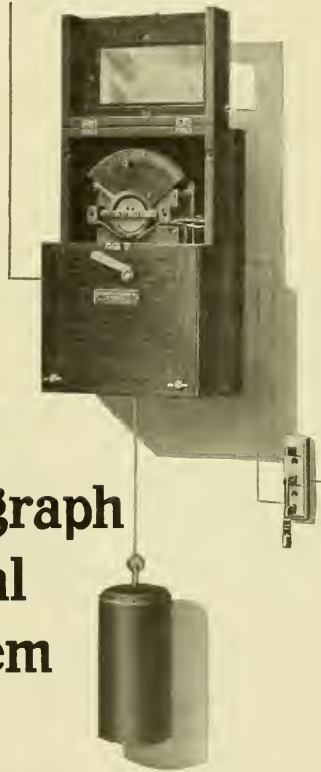

provided, of course, that your line is equipped with the

## Telegraph Signal System

Dispatcher merely inserts plug in the little machine illustrated above—the system does the rest—and does it every time

One Line Wire. Adoption Cost Extremely Low  
Write for Descriptive Literature

## Telegraph Signal Co.

282 State Street, Rochester, N. Y.

# Smooth Running



**Less Noise  
More Power**



## Electric Car Gears

run with U. S. G. Co's Graphited Wood Grease *make less noise*, run easier, transmit more power at less cost and *wear much longer* than with other lubricants.

**U. S. G. Co's**

## Graphited Wood Grease

is a grease of the finest quality incorporated with wood pulp (or fibre) thoroughly graphited with our pure, soft, adhesive graphite powder, *not flake*, but air-floated and gritless. Keeps gear surfaces from coming in direct contact—prevents "grinding." It "stays put." It is very adhesive and lasting—the ideal gear grease. It does not ooze out of cases—it saves labor, power, trouble and money.

Get right on the gear grease question. Write for Folder W 1.

**The United States Graphite Co.**  
SAGINAW, MICH., U. S. A.

# U. S. Metal & Mfg. Co.

25 Broad Street, New York

Pittsburg, 1509 Arrott Bldg. Chicago, 414 Railway Exchange

## Victor Cast Steel Car Replacer

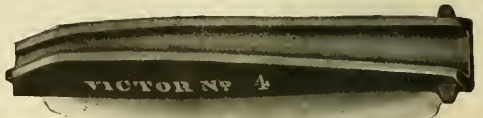
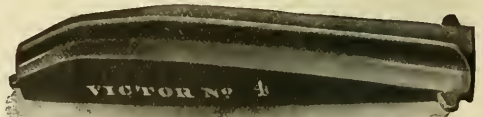

Victor No. 4

Weight, 136 pounds per set. For use on electric or standard steam roads using rails five inches high or under. Replacers are made of cast steel and annealed.

2

## "Not an Experiment"

The Providence Fender has been in successful operation on hundreds of roads for 13 years, and has proved itself reliable under all conditions of Street Railway service.

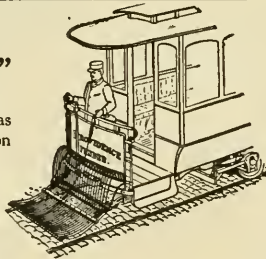

### CONSOLIDATED CAR FENDER COMPANY

Office and Factory: PROVIDENCE, R. I.  
Branch Office: 110 E. Twenty-third St., New York  
European Agents: Comptoir d'Electricite, 6, Rue Boudreau, Paris, France

## GREEN TRAVELING LINK GRATES

- Highest Capacity
- Highest Efficiency
- Automatic Smokeless
- Labor Saving
- Cheap Fuel

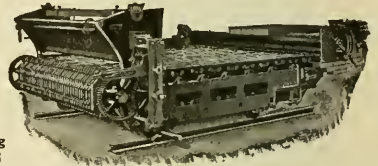

### GREEN ENGINEERING CO.

Main Office: Commercial National Bank Bldg., Chicago, Ill.  
BRANCH OFFICES: Pittsburgh : St. Louis : St. Paul : Louisville  
General Foundry Work a Specialty

## Whitmore's Gear Protective Composition

is the first and only compound placed upon the market that has given entire satisfaction and convinced those who were in doubt that it stands in a class by itself. Cut down your expense by the use of **Whitmore's Gear Protective Composition**

—you can do it.

**The Whitmore Manufacturing Company**  
Cleveland, Ohio, U. S. A.

4

# Pantasote

The National Standard for Car Curtains and Car Upholstery.

### AGOSOTE HEADLINING

The only headlining made in one solid piece. Will not separate, warp or blister. Waterproof and homogeneous.

### THE PANTASOTE COMPANY

707 Fisher Building, Chicago, Ill.

11 Broadway, New York

# Dearborn Water Purifying Reagents

Increase the efficiency and the years of service of steam boilers by keeping them in good condition internally. Gallon sample of the water required for analysis before preparing treatment.

## Dearborn Drug & Chemical Works

WM. H. EDGAR, FOUNDER

299 BROADWAY, NEW YORK POSTAL TELEGRAPH BLDG., CHICAGO

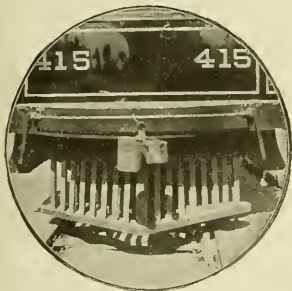

## Washburn Standard M. C. B. Coupler

Coupled or uncoupled from either side and on curved track as easily and safely as on straight track. The result is that

- trains may be operated in from two to six units each
- movement is safe around short curves of city streets
- freight cars are handled satisfactorily, and
- interchange is facilitated with steam roads.

*Our 112-page catalog of traction devices sent free for the asking.*

**Washburn Steel Castings & Coupler Co., Minneapolis, Minn.**

Western Agents: Tweedy, Hood & Finlen, 204 Fisher Bldg., Chicago  
Canadian Agent: John Taylor, Montreal

17



Established 1877.



## ALBERT & J. M. ANDERSON MFG. CO.,

Makers of

**ELECTRICAL APPLIANCES:  
SWITCHES, SWITCHBOARDS,  
TIME SWITCHES, LINE MATERIAL,  
COPPER CASTINGS (75%) CONDUCTIVITY.  
289-293 A ST., BOSTON, MASS., U. S. A.**

Branches: New York, 135 Broadway. Chicago, 175 Dearborn Street.

Agencies: Boston, Pettingell-Andrews Co. San Francisco, Eccles & Smith Co.  
New York, R. W. Marshall & Co. Atlanta, Newcomer-Manry Co.  
St. Louis, J. C. White. Denver, E. M. Messiter.  
Toronto, Ont., H. J. Surtees.



## WESTON Electrical Instrument Co.

Main Office and Works:  
WAVERLY PARK, NEWARK, N. J.



### Illuminated Dial Station Instruments

SEND FOR NEW CATALOGUE

Weston Standard Illuminated  
Dial Station Voltmeter  
Model 11

Berlin—European Weston Electrical Instrument Co., Ritterstrasse, No. 88  
Paris, France—E. H. Cadot, 12 Rue St. Georges  
London—Audrey House, Ely Place, Holborn  
New York Office—74 Cortlandt St.

# ALUMINUM

## Railway Feeders

And all kinds of **Electrical Conductors**

Aluminum Feeders are less than one-half the weight of copper feeders and are of equal conductivity and strength. If insulated wire or cable is required, high grade insulation is guaranteed.

*Write for prices and full information.*

## Aluminum Company of America

PITTSBURGH, PA.

Formerly The Pittsburgh Reduction Company

## Queen Testing Sets

*"The Recognized Standard"*

- Voltmeters
- Ammeters
- Switchboard and Portable
- Alternating and Direct Current



Queen Acme Testing Set

U. S. Standard Testing Sets  
Rail Bond Testers  
Galvanometers, etc., etc.  
Electrical Instruments for All Purposes

**QUEEN & CO., Inc., Philadelphia, Pa.**

## ECONOMY IN BRIDGE PAINTING

depends upon the durability of the paint.

We make serviceable material in desired colors.

**Detroit Graphite Company**  
DETROIT, MICH.

Send for Color Card.

Dept. S.

## ROLLING DOORS

In Steel, Wood or Bronze

FOR CAR BARNs, FREIGHT SHEDS, ETC.

Made by the

**JAS. G. WILSON MFG. CO.**

New York Office: 3 W. 29th Street

ESTABLISHED 1876

Incorporated 1903

## Kinnear STEEL Rolling Doors FOR CAR HOUSES

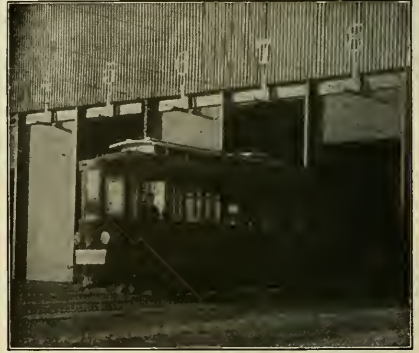

Operate Easily, Speedily, Satisfactorily and are very durable. Write for Catalog

**The Kinnear Manfg. Co.**

BOSTON  
85 WATER ST.

COLUMBUS, OHIO.

CHICAGO  
112 CLARK ST.

PHILADELPHIA  
1011 CHESTNUT ST.

## CAR CURTAINS

Did you ever stop to think how much is added to the appearance of your cars by tasteful window curtains?

Let us give you an estimate upon new ones for those winter cars you are renovating.

**The Curtain Supply Company**

Meto Office and Works,  
83-93 Ohio Street, CHICAGO, ILL.

530 Mission Street  
SAN FRANCISCO

1819 Park Row Bldg.  
NEW YORK

## POWER PLANT EQUIPMENT

at a Sacrifice

- 2 **Siemens-Halske 6-Pole Railway Generators**, 300 K. W., Outside Commutator, compound wound for 600 volts, each mounted upon the shaft of a right hand Tandem Compound Russell 4-valve engine, 18 and 30x24, operating at 150 R. P. M.
- 2 **Enamel Slate Switchboard Panels**, with necessary instruments, including circuit breakers.
- 4 **Feeder Panel Switchboards**, with ammeters, switchboards, but no circuit breakers.
- 2 **300-H. P. Stirling Water Tube Boilers**, set in battery.
- 1 **Closed Feed Water Heater**.

All of the piping connecting the boilers and engines, also the cable between switchboard and generators.

The above apparatus is now erected in a power plant. It has been abandoned because of consolidation. It has been little used, and is in thoroughly good order, and for immediate delivery.

**GEORGE A. GASTON**

1530 Williamson Building

CLEVELAND, OHIO



# Electric Railway Review

PUBLISHED EVERY SATURDAY BY THE WILSON COMPANY, CHICAGO

Entered as second-class matter January 5, 1907, at the postoffice at Chicago, Ill., under the act of March 3, 1879.

160 Harrison Street, Chicago  
150 Nassau Street, New York  
1529 Williamson Bldg., Cleveland

VOL. XIX  
No. 5

CHICAGO, FEBRUARY 1, 1908.

Whole No.  
249

Subscription: Domestic . . . \$2  
Foreign . . . \$5  
Canada . . . \$3.50

The discussion which followed the reading of the paper of Charles F. Price, general passenger agent Western Ohio Railway, at the last meeting of the Central Electric Railway Association, showed the value of an organization for traffic officials. The traffic officials met primarily at Dayton for the purpose of forming the Central

Electric Traffic Association; but they attended the meeting of the older organization and participated freely in the discussion on the "Promotion of Traffic." Mr. Price surprised his hearers by the statement that at the organization meeting of the traffic officials more was accomplished in the promotion of traffic than at any meeting of the parent association previous to that time. While the conditions under which interurban electric railways operate are very different from those which govern the management of steam roads, the freight and passenger agents of electric lines will find it profitable to observe the older established methods of their steam competitors. In the present business situation it is essential that the traffic managers of electric roads do all that lies in their power to stimulate business. If the new traffic association should consider all subjects relating to the development of traffic, it might go beyond the objects of organization as set forth in the articles of association of which an abstract was published in last week's issue of the Electric Railway Review, page 108; but it would afford assistance to those members who face competition which demands their best energies.

Rolling stock can be better adapted to service conditions than has yet been done. This is a rather hold statement when one considers the results of long experience and highly developed training that are called into play in the design of modern equipments. These requisite qualities, as exemplified in many recently built cars,

command our respect. Nevertheless there are cars operated on many street railways which are not well adapted to the service requirements. Such cars are frequently too large and too heavy for the traffic demands. It will be said that rush-hour service and consideration of maintenance warrant the hauling around of large and heavy cars. So they do. Yet who is willing to say that improvement along rolling stock lines is not as desirable as struggling to lower the power costs. Last June we described the new rolling stock that the Denver City Tramway had just put in service (Electric Railway Review, April 6, 1907, page 452). These cars had been designed to afford maximum seating capacity with minimum weight. Trailers are operated in Denver. These were described in the issue of May 4, 1907, page 578. The Denver trail cars have no monitor decks and thereby a considerable amount of weight is saved. In this issue a description is presented, including criticisms, of a monitorless type of car developed by the Black River Traction Company. The latest equipment in this line of development has a body 35 feet long, mounted on a running gear of special design having but two axles with a 12-foot wheel base. Automatic ventilation is

provided in the car body, which has no monitor, and the complete equipment, seating 40 passengers, and equipped with two G.E.-54 motors, weighs only 10.5 tons. The excellent riding qualities of this equipment, even at speeds of 40 miles per hour, combined with the other valuable and new characteristics, should command the careful attention of those interested in more closely adapting cars to traffic.

The possible results of a well-directed and concerted campaign for the purpose of avoiding accidents is well illustrated

## Reduction of Accidents in Omaha.

by a statement by President G. W. Wattles of the Omaha & Council Bluffs Street Railway in his annual address to the stockholders. Mr. Wattles states that during the month of December, 1907, only 29 claims for damages were filed against the company, while the average number of claims per month for the preceding 47 months was 49. This reduction is credited by President Wattles to the campaign of education recently started by the company for the purpose of impressing upon both the public and the employes the serious effects of carelessness. As previously mentioned in these columns, the company has for several months carried large advertisements in the daily papers warning passengers against carelessness and illustrating the proper ways of boarding and leaving cars. During the month of November the practice was instituted of holding frequent evening meetings of the motormen and conductors, at which they were addressed by officials of the company on the subject of accidents. Not only have these efforts been of great service to the public but they have saved the company a great deal of money.

In last week's issue of the Electric Railway Review we presented a complete report of the annual meeting of the Central Electric Railway Association. The papers read at this meeting in Dayton considered topics in the operating, traffic and mechanical fields. To the mechanical man the discussion of "Fundamental Brake Rigging for

## Mechanically Perfect Braking.

High-Speed Electric Railway Cars" was undoubtedly of considerable value. R. C. Taylor, superintendent of motive power Indiana Union Traction Company, presented in this paper a problem for the air brake student and designer which if solved in a practical way will afford results of immense value. Briefly, Mr. Taylor recommends that air brake equipments should be provided with automatic friction regulators to control the braking pressure so that there will be at all times during an application the maximum possible retarding force which will not skid the wheels. The graduated release brakes as now used decrease the braking pressure as the speed decreases, and thus approach Mr. Taylor's requirements. However, to go a step farther toward a perfect brake, Mr. Taylor would have provided a mechanical means to reduce the brake pressure as the coefficient of friction between wheel and shoe increases. At first glance this seems a difficult problem, but the immense value of such a device will be an

inspiration that undoubtedly will lead to its solution. Then it will be possible to stop a car in about half the distance now required with the usual form of automatic brakes.

---

### BETTER URBAN TRANSPORTATION IN NEW YORK.

---

So much has already been done and so much more seems to be in a fair way toward fulfillment in the way of relieving passenger traffic in New York, that already a more cheerful look appears on the faces of urban travelers and a more optimistic tone characterizes the headlines of the daily newspapers.

The completion of the "tube" from the Battery, Manhattan, to Borough hall, Brooklyn, has been a source of so great relief as to make life in this populous part of greater New York much more nearly worth living. Perhaps this feeling is best indicated in a few words, but the fact that a few days ago a tie-up of traffic over the Brooklyn bridge, due to some changes in track arrangement necessitated by the Manhattan terminal extension, was treated rather as a good joke than as an occasion of vituperation of the Brooklyn Rapid Transit Company. As one paper stated in its headlines, "Old Bridge Tied Up and Nobody Cared."

But, as a matter of fact, the bridge terminal has now been improved to such an extent as to be in position to take care of many of its own difficulties as they have previously existed. A great source of congestion has been the inadequacy of the Manhattan terminal to handle the 6-car trains which were essential to the handling of the traffic at the Brooklyn side of the bridge. It has therefore been necessary to run 3-car bridge trains on the shuttle system during the rush hours, involving a delay and change of cars at the Brooklyn end. With the extension of the approach over Park Row it will be possible to handle through 6-car trains to and from Manhattan, to unload and load simultaneously at that end and to avoid the crush of changing on the Brooklyn side.

With this relief and that afforded by the "tube," which appears to be operating to the general satisfaction, bridge jams should, for a time at least, be but a memory.

For relief in the direction of the Bronx, also, the plan described in a recent issue of the Electric Railway Review is passing through the preliminary stages in a hopeful way. One of the more recent suggestions which has been seized upon with avidity is that of the public service commission, which is inclined to make such arrangements as will enable the operation of steam railroad suburban trains through the proposed additional subway without "breaking bulk."

In describing certain changes which the commission has seen fit to make in the plans for the Fourth avenue subway in Brooklyn, it is stated that the object is to promote the more rapid, safe and economical operation of trains and to make it possible for cars now used in the local suburban traffic of steam railroads to be operated through the subway. It is also stated that this plan will facilitate the making by the city of more advantageous contracts for the subsequent rental and operation of the road and that it is considered a mistake to build any future subway of such dimensions that an existing railroad would be debarred from being a competitive bidder because of the impossibility of operating its own cars through it.

It is therefore concluded that the proposed Lexington avenue subway, with its crosstown connection and loop at Canal street, the latter now under construction but still capable of being changed, and all connections of the Williamsburg and Manhattan bridges and possible future connections with the Brooklyn bridge, should be constructed with a clear head room of 14 feet 6 inches instead of 12 feet 6 inches, as previously planned. It is proposed to operate the Canal street loop as two double-track railroads instead of as one single-track road—a modification which will simplify a complicated plan, bring all tracks to a level and increase the operating

capacity to an amount estimated at 25 per cent, while at the same time decreasing the time required for construction.

As shown in the article descriptive of the proposed Lexington avenue subway, connection with the New York New Haven & Hartford at Mott Haven would be a simple matter. If the commission's suggestion as made to the board of estimate is carried out and the section of the subway increased to accommodate standard steam railway equipment, it will not only enable that road—and others—to operate its trains into Brooklyn, but also afford completely practicable connections with the several bridges and with any future subways that may be built in Brooklyn. Of perhaps equal importance to this very desirable feature, from the city's point of view, such a course would open the competition for operation to a larger number of bidders.

---

### PUBLICITY—A MEANS TO AN END.

---

If the pay-as-you-enter cars have accomplished nothing more, they have served to demonstrate the advantages to electric railways of advertising. Various methods have been employed in advertising the pay-as-you-enter cars—leaflets, advertising in the newspapers and a legitimate use of the reading columns, coupled with all the attention to the minor details of operation necessary to the fulfillment of the promises of improved service if the public would co-operate with the companies and their employees. The results have been most gratifying without exception. What would these results have been without advertising?

In connection with operating and corporate affairs there are many possibilities in advertising. Publicity which will aid in securing the good will of the public is well worth while. For example, the effects of hostile public opinion through failure to give publicity to matters of this sort is presented in the situation of the steam railways and other large corporations today, and even some of the electric railways. The railways and other corporations are just awaking, some of them slowly, to the value of publicity. The electric railways, which are for the most part young, can take advantage of an opportunity to acquire an asset of good will which the steam railways are now paying dearly for or have yet to acquire.

There is thought to be no electric railway system with a publicity system more highly developed and with more favorable results than the Twin City Rapid Transit Company. Speaking on "Advertising from the Standpoint of the Street Railway Company" before the American Street and Interurban Railway Association at Atlantic City last fall, Arthur Warnock, general passenger agent of that company, said:

"I emphasize strongly the feeling between the press and the road because I think it a strong asset that every road should have. The good will of the newspapers is of incalculable value and a road should utilize every fair means to secure the support of its newspapers. I mean by this that the relation of the company to the public should be of such a character that in all fairness the newspapers will have a friendly feeling for the company. Criticisms, of course, will be made on the best of service, but the general trend of sentiment should be favorable. There is nothing that appeals to newspapers so strongly as the practice on the part of a public service corporation of taking the public into its confidence, and we have always taken our public into our confidence."

Recently in answer to a request for information for use in the Electric Railway Review there came a reply in which the following sentence appeared: "We have always found that wherever information is published, even in the high-grade technical papers, it is often used in such a manner by outside parties as to make it objectionable to the railroad company." The matter referred to had to do with an accident, but it was not proposed to consider the causes of the accident, but rather the manner in which disastrous conse-

quences had been prevented by the substantial character of the equipment affected.

The statement of the company in the case indicated a condition of public opinion toward it which is deplorable. The value of advertising depends on what one has to offer and how he offers it. The company in question has equipment and service which are not excelled in this country, yet it feared to advertise the good points of its equipment because of the attitude of the public toward all its affairs, with the result that it was thought the information might be so misinterpreted as to cast further discredit upon the company.

A corporation in its position needs an expert publicity manager and needs one badly. Such a position is not acquired at without its causes, but taking for granted that every electric railway intends to give the public a "square deal" and a little more, other things being equal, the advantages of publicity, even at such a stage, if persistently continued, will bring satisfactory results. For instance, the effects of publicity under an adverse state of public opinion are exemplified in the increased good will of Chicagoans toward the Chicago City Railway as a result of its campaign of publicity, coupled with its very evident intention to do all that it advertised. But "if you do not have a good proposition to offer, then make it a good proposition or do not advertise it."

ANNUAL REPORTS.

North American Company.

Gross earnings of the North American Company for the year 1907 increased 14.63 per cent over the previous year. Operating expenses increased 17.15 per cent and net earnings were 12.11 per cent higher. The appropriation for depreciation and reconstruction reserves in the last year was 40.08 per cent larger than in 1906. In the following table the earnings for two years are compared:

	1907.	1906.	Increase.
Gross earnings . . . . .	\$22,821,849.49	\$19,907,433.31	\$2,914,416.18
Operating expenses. 11,693,280.09		9,981,399.92	1,711,980.17
Net earnings \$11,128,569.40		\$9,926,133.39	\$1,202,436.01
Taxes and annual charges . . . . .	1,439,164.41	1,226,758.74	212,405.67
Depreciation and reconstruction reserves . . . . .	1,217,353.11	\$69,002.74	348,350.37
Income from operation . . . . .	\$ 8,472,051.88	\$ 7,830,371.91	\$ 641,679.97
Miscellaneous income . . . . .	810,459.52	302,190.07	508,269.45
Total net income \$9,282,511.40		\$ 8,132,561.98	\$ 1,149,949.42
Interest paid and accrued . . . . .	5,893,446.29	4,828,335.79	1,065,110.50
Surplus applicable to dividends . . . . .	\$ 3,389,065.11	\$ 3,304,226.19	\$ 84,838.92
Preferred dividends 1,044,160.00		1,044,160.00	
Surplus . . . . .	\$ 2,344,905.11	\$ 2,260,066.19	\$ 84,838.92

In addition to the depreciation and reconstruction reserves shown in the foregoing statement, reserves are created for injuries and damages, legal expenses and insurance, by monthly charges made to ordinary operating expenses, "the intent of the accounting system pursued being to provide by reserves for every reasonable contingency that may occur in the operation of the properties, so that the full amount of the surplus applicable to dividends, as reported, shall actually be available for the payment of dividends."

In his address to the stockholders C. W. Wetmore, the president, states:

In revaluing the assets of the company as of December 31, 1907, the sum of \$2,290,365.73 has been written off from undivided profits. To the making of this revaluation the directors have given their most careful consideration, and the valuations assigned are believed to be conservative.

As of December 31, 1907, there remains to the credit of undivided profits account the sum of \$1,996,613.92. All dividends paid are charged to this account. Lest it be supposed that the credit balances, from time to time appearing in this account in the annual reports of the company, have been created by the increase in the value of its assets, as readjusted by the directors at the close of each fiscal year, or be inferred that dividends have, to some extent at least, been based upon such increment in book values, the following statement of the cash receipts and cash disbursements of the company, pertaining to its income and undivided profits account, and of the composition and application of its undivided profits, is made.

Following the reduction of the capital stock of the company to \$12,000,000, and on the occasion of an application for the listing of its reduced stock, a balance sheet was filed with the New York stock exchange, as of February 1, 1901, upon which as a starting point the subsequent accounting of the company has been based.

Its cash income and disbursements from that date, February 1, 1901, to December 31, 1907, have been as follows:

Receipts—Interest received and accrued, \$839,586.20; dividends received, \$4,864,586.08; commissions, profits and compensation for services, \$2,245,552.70; premium on capital stock, \$12,459.86; total, \$7,962,184.84.

Disbursements—Salaries, legal expenses, net rentals and all other expenses of administration, \$517,741.20; taxes, \$35,653.74; commissions, \$182,500; dividends, \$5,392,346.25; total, \$6,128,241.19.

Excess of cash income over disbursements, \$1,833,943.65.

In many of the states of the United States (including Wisconsin and Missouri) laws have been enacted providing for the supervision and regulation of public service corporations, either by state commission or by municipal authority, and similar laws will undoubtedly be enacted by the other states. While varying in many particulars, the general objects of these laws may be summarized as being: (a) To enforce proper and uniform accounting and publicity of rates and accounts; (b) to compel the furnishing of standard facilities adequate for the public requirements; (c) to prescribe and enforce just and reasonable rates and practices.

The management of the public service corporations in which the North American Company is interested may claim credit for having adopted many years ago, for business reasons uninfluenced by fear of impending legislation, the essential principles, which these statutes seek to enforce.

Having anticipated the ends sought to be obtained by the legislation under discussion, we do not feel that it will have an adverse effect upon the interests of the North American Company, but, on the contrary, that its tendency will be to strengthen the position of the operating companies affected and ultimately to enhance the investment value of their securities.

Concerning the accounting methods in force, striking testimony is available in a report made on August 31, 1907, by public accountants, who were retained on behalf of the city of Milwaukee in a proceeding brought by the city against the Milwaukee Electric Railway & Light Company before the Wisconsin railroad commission, and who investigated the accounts of that company for the 10 years ending December 31, 1906. The accountants said:

"We found the books and records of the company to have been kept with unusual skill and accuracy, and we were accorded at the hands of the accounting department every courtesy which would facilitate our work, and are pleased to give here an expression of our appreciation of the consideration shown us. The attitude of the management in this respect is especially creditable, in view of the fact that our visitation was not at the instance of the company, nor was our work presumed to be for its benefit."

Mr. Wetmore also quotes that portion of the accountants' report which relates to the reserves of the company and was published in the Electric Railway Review of September 21, 1907, page 340.

The balance sheet as of December 31, 1907, shows stocks valued at \$28,548,024. The company has sold to the Milwaukee Light Heat & Traction Company the entire common capital stock of the Milwaukee Electric Railway & Light Company (\$9,000,000 par value) and has received in payment therefor the capital stock and refunding and extension mortgage bonds of the traction company, the sale or exchange having been made in the belief that the future development of these properties can be more effectively provided for through the instrumentality of the traction company as the controlling company. The bonds are valued at \$4,520,833, and consist of \$5,000,000, par value, Milwaukee Light Heat & Traction Com-

pany refunding and extension mortgage 5 per cent 30-year gold bonds. The accrued interest on these bonds is \$20,833.33. Loans stood at \$4,047,453. These are loans to constituent companies for construction purposes.

The report refers to the extensions of the railway lines of the Milwaukee Light Heat & Traction Company, and says that because of the adverse financial conditions the capital expenditures of the other subsidiary public service corporations have been limited to such as were deemed to be imperatively required to meet present demands, or as were unavoidable because of engagements previously entered into.

**South Side Elevated Railroad.**

Gross earnings of the South Side Elevated Railroad of Chicago increased 17.47 per cent in 1907 over 1906. This gain is the result of the normal increase of population in the territory traversed, the opening of five new stations on the Englewood extension and to the opening to traffic of the new Kenwood branch. On account of a normal increase in operating expenses and some extraordinary expenses which were made for the improvement of the structure and operating conditions, the increase in net earnings was 9.3 per cent. The principal results of operation for three years follow:

	1907.	1906.	1905.
Gross earnings .....	\$2,105,193	\$1,788,975	\$1,713,347
Oper. expenses and taxes.	1,459,746	1,207,269	1,052,962
Net earnings .....	\$ 645,447	\$ 581,706	\$ 660,385
Interest and rentals.....	205,939	33,750	33,750
Net divisible income.....	\$ 439,508	\$ 547,956	\$ 626,635
	409,187	409,177	409,165
Surplus .....	\$ 30,321	\$ 138,779	\$ 217,470

The expense of conducting transportation increased \$142,537 over 1906, the total expenditure by this department being \$677,482, or 32.2 per cent of gross earnings. Charles V. Weston, the president, said in his remarks to stockholders that the large increase in this expense "is due to the opening of new lines, requiring a much larger number of men and cars, and to the operation of such a service that patrons would be attracted to it from competing lines of transportation on which new and attractive service is being offered to the public."

An abstract of the address of Mr. Weston to stockholders follows:

The effect upon traffic due to the opening of the new branch lines and to the added facilities offered by the operation of express trains on the central track has been gratifying. During January, 1907, the average daily traffic was 92,411 passengers. The patronage of the road increased steadily until October, when the high mark was reached, with a daily average for that month of 126,670 passengers. The sudden depression in general business which occurred in October caused the traffic to decline during November and December. There are indications now that the low point has been reached, and that we are beginning to recover the business which was lost during the last two months of 1907.

Rapid progress is now being made toward the completion of the stock yards branch. The line will be opened to traffic on or before May 1 of this year.

The steel structure between Twelfth and Congress streets was thoroughly overhauled and stiffened at expansion points by the addition of steel channels riveted to the columns and cross girders.

During the year 123 cars went into the shops for general repairs. These cars were thoroughly overhauled inside and out. All necessary carpenter, blacksmith, electrical and machine work was done. Forty-nine platforms have been replaced where timbers were found to show signs of wear. Thirty trailer trucks were entirely rebuilt with larger axles, journal boxes, bearings and brakes of the inside equalizing type. All necessary renewals of steel tires to keep the wheels of the equipment in good condition have been made.

All new construction work authorized by the city ordinance of March 16, 1903, has been completed, except the line to the stock yards which is being constructed by the Chicago Junction Railroad, and the Union avenue yard on the stock yards branch which is being built by the South Side Elevated Railroad. The whole construction will be finished within the

amount of the bond issue. Besides the additions to the elevated railroad structure, equipment and power plant, a large tract of land was purchased, on which there have been created car storage facilities which will be adequate for the business of the company for many years to come.

When the stock yards line is completed and in operation the system of tracks composing your property will represent 36½ miles of single-track railroad, exclusive of yards and sidings, capable of handling a traffic enormously greater than the capacity of the loop terminal in the downtown district. The present traffic during the rush hours at night and morning overtaxes the present terminal facilities in the business center of the city, and one of the most important problems confronting the elevated properties of Chicago at this time is the improvement of this terminal so that its capacity will approximate the ultimate capacity of the main lines. The completion of the special manganese steel work at the junctions and curves on the loop, and the installation of electro-pneumatic interlocked signal devices has increased the facilities for the safe and rapid movement of trains through the junctions, but no material progress has been made toward providing other much needed facilities for the relief of loop congestion. The public authorities have to date declined to permit the lengthening of platforms on the union loop. The lengthening of these platforms to allow two trains to stand in a station and unload at the same time would afford a considerable measure of relief, and is essential to any plan of operation which contemplates the joint use of one track by the trains of two companies. Although lengthened platforms will aid the loading and discharging of passengers at the loop stations, expedite the movement of trains and relieve congestion, they will not completely solve the problem of supplying terminal facilities capable of developing the full capacity of the main lines. Therefore other additional improvements must be provided. The physical conditions are difficult, and there are so many conflicting interests to be harmonized that the problem is complex. However, the problem is believed to be susceptible of solution, and it is hoped that during this year substantial progress will be made toward a final adjustment of it.

**MEETING OF CENTRAL ELECTRIC ACCOUNTING CONFERENCE CALLED.**

A meeting of the Central Electric Accounting Conference has been called by the chairman, M. W. Glover, auditor Ohio Electric Railway, Cincinnati, for February 11 at Lima, O. All the accounting officers of electric railways in Ohio, Indiana, Illinois and Michigan are invited and it is hoped by those who are interested in the conference that a large number will be present.

The following are some of the subjects which have been listed for discussion at this meeting: The settlement of inter-line ticket and mileage balances; prepaid ticket orders; the handling and settlement of overcharge and loss and damage freight claims.

In discussing the object of the meeting Mr. Glover made the following statement:

Even if the meeting of the Central Electric Accounting Conference did not result in more than the meeting together of accounting officers of the various lines in this territory and affording an opportunity of discussing matters of interest to accountants generally, I believe the meetings would be worth the time spent attending them; but our record for the past year shows that at the meetings we have handled various matters and have accomplished much good, in addition to affording us the opportunity of meeting those with whom we correspond daily. I hope this conference will be continued and that we will find it possible to arrange to have regular meetings at least three times a year, and that these meetings will be well attended and that all who come will feel amply repaid for their trip.

We have always been able to complete our work within a day and I think all who have attended agree with me that the meetings have been of great benefit to them. All with whom I have talked about continuing this conference have expressed the opinion that we should not allow the conference to go by default, but should continue the meetings and invite others interested in the accounting work of electric interurban lines to meet with us and discuss matters of general interest.

The Terre Haute Indianapolis & Eastern Traction Company has established through service from Indianapolis to Terre Haute, Ind.

## TRANSPORTATION AND TRAFFIC ASSOCIATION ORGANIZED.

On January 14 the committee on organization of the American Street and Interurban Railway Association, acting in accordance with a resolution passed at the Atlantic City convention, issued a circular letter to general managers announcing a meeting of representatives of member companies of the association, to be held in New York on January 30 for the purpose of organizing a fourth affiliated association, to be devoted to the interests of the operating and traffic departments. The circular setting forth the objects of the proposed association, which was signed by Calvin C. Goodrich, W. Caryl Ely and James F. Shaw, the committee on organization, was published in the Electric Railway Review of January 18, page 65.

The meeting was called to order on Thursday of this week, as announced, with W. Caryl Ely, past president of the American association, in the chair, and an attendance of about 50. Mr. Ely was elected temporary chairman and Bernard V. Swenson, secretary of the American Street and Interurban Railway Association, temporary secretary.

Secretary Swenson read the constitution and by-laws which had been drawn up by the organization committee appointed by the American association. After a discussion of several points it was adopted without change.

An abstract of the constitution and by-laws of the American Street and Interurban Railway Transportation and Traffic Association, in so far as they differ from those of the existing affiliated associations, follows:

### American Street and Interurban Railway Transportation and Traffic Association—Constitution.

1. The name of this association shall be the American Street and Interurban Railway Transportation and Traffic Association, and its office shall be at the place where the secretary resides.

#### Objects.

2. The objects of this association shall be to bring together general managers, managers, superintendents, passenger, express and freight agents, advertising managers and other operating officials and employees engaged in or connected with the actual operation of street and interurban railway companies, for the interchange of ideas, consideration of operating and transportation problems, methods of promoting traffic, and all other matters incident thereto.

#### Members.

3. The membership of this association shall consist of two classes, as follows:

(a) Active members, consisting of active members of the American Street and Interurban Railway Association. Each active member shall be entitled to one vote on all questions coming before this association, which shall be cast by a properly accredited representative of its transportation or traffic department. Each active member shall send as many delegates from these departments as it may desire.

(b) Associate members, consisting of associate members of the American Street and Interurban Railway Association, who may elect to ally themselves with this association.

#### By-Laws.

1. The officers shall consist of a president, three vice-presidents, a secretary and treasurer, and four others, who shall constitute the executive committee. The executive committee shall have the entire charge and management of the affairs of the association. The secretary and treasurer shall be the secretary and treasurer of the American Street and Interurban Railway Association. All other officers and members of the executive committee shall be elected by ballot at each annual meeting of the association, and shall hold office until their successors shall be elected. The officers and members of the executive committee of this association, with the exception of the secretary and treasurer, shall be chosen from the transportation and traffic departments of active members.

#### Secretary and Treasurer.

4. The duties of the secretary and treasurer shall be as follows:

(a) To receive and safely keep all moneys of the association; to keep correct accounts of same, and to pay all bills of

the association approved by the president.

He shall make an annual report to be submitted to the association at its annual convention. His bond given to the American Street and Interurban Railway Association shall be and is deemed to be sufficient for all the purposes of this association.

His salary shall be fixed and paid by the American Street and Interurban Railway Association.

[Sections b, c, d, e, f, g and h outline duties similar to those for the other affiliated associations.]

[By-laws on the following subjects are in substance similar to those for the other associations: Executive committee, meetings, order of business, voting, reading of papers, papers, illustrations and models, rules of order, amendment and copy of constitution and by-laws.]

Letters were read from the following expressing their regret at their inability to be present and giving assurance of their interest and co-operation in the new association:

F. W. Coen, general manager Lake Shore Electric Railway; E. A. Newman, general manager Portland (Me.) Railroad Company; L. E. Fischer, vice-president and general manager Illinois Traction System; F. W. Brooks, general manager Detroit United Railway; T. K. Glenn, vice-president Georgia Railway & Electric Company; W. W. Cole, general manager Elmira Light & Railroad Company; W. E. Kirkpatrick, secretary and treasurer Kansas City Railway & Light Company; George B. Hippee, general manager Des Moines City Railway; R. D. Apperson, general manager Lynchburg Traction & Light Company; Calvert Townley, vice-president Connecticut Company. Other letters had been received, all of which, with one exception, favored the organization of the new association.

A nominating committee was appointed as follows: J. N. Shaw, Dana Stevens, F. W. Bacon, E. W. Peck and J. W. Brown. A committee on subjects for the 1908 convention, including Messrs. J. A. Nagle, E. B. Shaw and Duncan McDonald, was also appointed.

At the afternoon session the nominating committee reported and the following officers were elected: President, C. Loomis Allen, vice-president and general manager Utica & Mohawk Valley Railway, Utica, N. Y.; first vice-president, Robert I. Todd, first vice-president and general manager Indianapolis Traction & Terminal Company, Indianapolis, Ind.; second vice-president, George L. Radcliff, superintendent Cleveland Electric Railway, Cleveland, O.; third vice-president, Arthur W. Warnock, general passenger agent Twin City Rapid Transit Company, Minneapolis, Minn.; secretary-treasurer, Bernard V. Swenson, secretary-treasurer American Street and Interurban Railway Association, New York, N. Y. Executive committee, George W. Parker, general express agent Detroit United Railway, Detroit, Mich.; Henry C. Page, general manager Springfield Street Railway, Springfield, Mass.; N. W. Bolen, superintendent transportation Public Service Corporation of New Jersey, Newark, N. J.; H. A. Davis, superintendent railway department Nashville Railway & Light Company, Nashville, Tenn.

The president announced standing committees on the following subjects: 1. "Express and Freight Traffic." 2. "Passenger Traffic." 3. "Rules for City Operation." 4. "Rules for Interurban Operation." 5. "Training of Transportation Employees."

The committee on "Programme" reported the following tentative list of subjects: 1. "Carrying United States Mail." 2. "Operation of Multiple Car Trains on Interurban Roads." 3. "Rates and Regulations for Carrying Freight and Express." 4. "Shall Electric Railways Engage Directly in Street Car Advertising or Contract the Privilege with an Advertising Company?" 5. "Possibilities of a Well-Conducted Publicity Department." 6. "How Can a Small Road Promote Traffic and Increase Its Revenue?" 7. "Smoking on Cars."

The municipality of Stratford, Ont., is said to be considering the construction of an electric railway, to be operated by the city.

## LONG SINGLE-TRUCK CARS WITHOUT MONITORS.

There are electric roads which operate cars too heavy and too cumbersome for the traffic of the community which they serve. Believing that many of these railways could increase net earnings if attention were given to the problem of more closely adopting the types of rolling stock to the service required, the Electric Railway Review is pleased to present a concrete discussion of this subject by A. H. Lefebvre, secretary and treasurer Black River Traction Company, Watertown, N. Y., and T. J. Nicholl, New York City. In the Electric Railway Review, July 13, 1907, page 44, under the title "Cars for City Service," Mr. Nicholl made a plea for single-ended cars and these cars to be constructed without monitors.

At the time this article was published the Black River Traction Company was building cars without monitors. The original cars have since been improved, and we are now privileged to present descriptions and illustrations of these equipments, together with criticisms by T. J. Nicholl and replies thereto by Mr. Lefebvre of the Black River Traction Company.

As described by Mr. Lefebvre Car No. 5 (illustrated) was

herewith. Car No. 12 had a Peckham 7-foot wheel base truck. A criticism of Car No. 5 was that although it had a 10-foot wheel base it would not ride bad track easily because the steel underframe of the car made the equipment so rigid that it "felt" every depression.



Long Single-Truck Cars Without Monitors—Car No. 5. Low Monitor, Square Ends and 10-Foot Wheel Base.

Car No. 7 exhibits the next step in improving the design. The monitor deck was not used and for this reason the weight of the roof was reduced by 1,200 pounds. Room was



Long Single-Truck Cars Without Monitors—Car No. 7. Twenty-eight Feet 6 Inches Long, Without Monitor, 10-Foot Wheel Base.

the first one built by the Black River company. For purposes of good appearance a monitor, reduced in height, was retained. Car No. 5 is mounted on a Peckham type of truck and spring support, with a 10-foot wheel base. It has made quite an impression on the public, in contrast with the former type of car as illustrated by Car No. 12, shown

also had for a stationary headlight and red markers up beyond the reach of the mud spattered by the horses' feet. The truck, as illustrated, is a radical departure. The car body rests on a bolster of four heavy elliptics with rockers below so that none of the motion of the wheels is transmitted to the car body, whose inertia is enough to permit of passing

depressions of 3 inches in the track without these being noticeable inside of the car. Side springs limit the rolling motion, which is very slow and gives the same impression as the roll of heavy coaches on double trucks. Car No. 7 is 28 feet 6 inches long and weighs complete 18,000 pounds.

**Car No. 14.**

In the design of Car No. 14 (illustrated) the good features of Car No. 7 were retained but the roof was built still higher on the sides to permit of the sashes being raised above the passengers' heads. This type of car received the preference when competing for traffic in summer, so that the company

feet; width, 8 feet 3 inches at eaves. Seats for 40 passengers, double-end control, with a locked compartment at each end for the motorman, the rear compartment being used to carry United States mail. Heywood Brothers & Wakefield walkover seats, independent air brakes on each of the four wheels, no hand brakes, steel underframe, double "Stanwood" steps 5 inches



**Long Single-Truck Cars Without Monitors—Car No. 12. Type Originally Operated with 7-Foot Wheel Base.**



**Long Single-Truck Cars Without Monitors—Interior of Car No. 14, Showing Arrangement of Lamps, Register and Ventilator.**

has sold its regular 10-bench open cars and will not use that type another season. This Car No. 14 is said to be the largest single-truck car ever built for single-truck operation. It is daily making runs at 40 miles per hour between stops.

above rails, 32-inch forged steel wheels with 2 1/4-inch treads, wheel base 12 feet, passing easily curves of 50 feet radius. This length of 12 feet makes a 35-foot single-truck car possible. Journal bearings, 3 3/4 by 9 inches. No check plates.

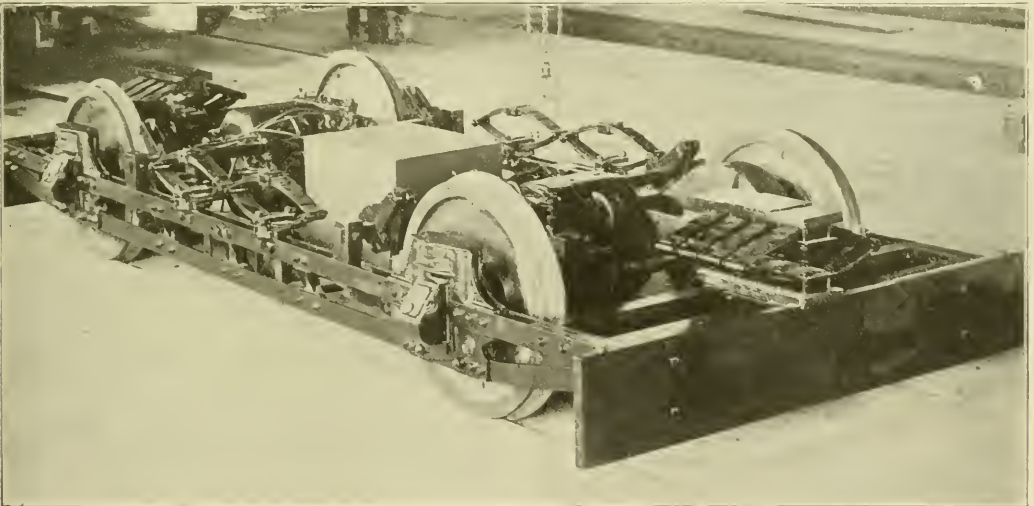

**Long Single-Truck Cars Without Monitors—Running Gear for Car No. 7.**

It rides very smoothly and is the most popular car on the lines of the Black River Traction Company. This desirable quality is due to the success attending three years' use of 10-foot wheel base trucks. Experience at Watertown has satisfied the company that a long wheel base is not objectionable on sharp curves.

The principal dimensions follow: Length over all, 35

Two GE-54 motors. Gears with 17 and 68 teeth, giving a speed of 40 miles per hour on level track when using 38 amperes at 550 volts. Total weight of car complete, 21,000 pounds.

The management has been highly complimented on the interior arrangement of this type of car, similar to No. 14. An interior view is presented which shows a really creditable

design. Every piece of wood is smooth, with rounded corners, so that the car is always clean. The ceiling is enameled white and reflects the light from 25 lamps to make it brilliantly lighted at night.

The heating and ventilation are very satisfactory even for a cold country. Plate glass is used throughout, and the motorman's cab is supplied with a cushioned seat and an 800-watt heater. This not only keeps the cab warm but also keeps the sandbox hot enough to permit of a week's supply being carried.

The design of the square front is responsible for the

of an accident the motorman would not be locked in by the passenger door or the passengers locked in by the motorman's door being open, as each door has a spring catch to hold it in either position.

Normally the motorman's door is closed and locked on the inside. The passenger door swings from the same hinges and when open engages a spring catch on the motorman's door, which can then be used just as readily as before, as both doors swing together when required. The same thing occurs if the motorman's door is opened wide, as shown in the accompanying photograph of the vestibule; it catches on



Long Single-Truck Cars Without Monitors—Side View of Steel Underframe and Running Gear for 35-Foot Single-Truck Car. Wheel Base, 12 Feet.

perfect system of ventilation (a vacuum system). The front of the car body is always in a partial vacuum when the car is moving, so that with front and rear ventilators open the air is changed in 45 seconds. With only the front ventilator open the air is changed in two minutes and with both venti-

lators closed in five minutes. The doors are purposely fitted rather loosely. The loss of the monitor has made it possible to build a warm roof, so that the ceilings last indefinitely. The floor is double, so that heating by electricity is easy and sure in zero weather.

of their standard Yale keys, which are alike for all cars, switchstands, barn doors, etc.

It will also be noticed from the view of the front platform that there are no projecting grab handles to encourage hoarding the cars while in motion. As Mr. Lefebvre says: "We are not leading strenuous lives out here in the north woods. We prefer to have the car stopped when passengers are boarding or alighting. On busy corners we ask the passengers to 'Leave the car by the front door, please,' and they are usually well out of the way before we can load up the waiting passengers."

One seat is left out at each end at the spaces marked A on the diagram, as the space is found convenient to pile up

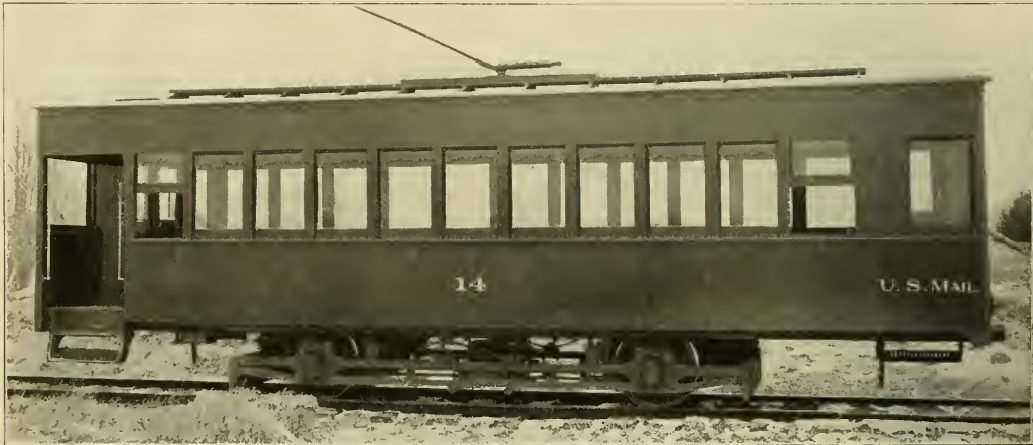

Long Single-Truck Cars Without Monitors—Car No. 14. Thirty-five Feet Long, Without Monitor, 12-Foot Wheel Base.

lators closed in five minutes. The doors are purposely fitted rather loosely.

The loss of the monitor has made it possible to build a warm roof, so that the ceilings last indefinitely. The floor is double, so that heating by electricity is easy and sure in zero weather.

An interesting feature in the construction of Car No. 14 is the arrangement of the vestibule doors, which is illustrated in the plan drawing of the car and the photograph of the front platform. The motorman's compartment is shut off by a door swinging from the same hinges as the door in the entrance to the car body and it was a problem requiring considerable experimenting to so arrange the doors that in case



suitcases of steam train passengers. The sand boxes are covered by a leather cushion, which forms a roomy seat for the motorman and gives the new men who are being instructed a comfortable position without interfering with the safe operation of the car.

**Criticisms of T. J. Nicholl.**

Inasmuch as the design of Car No. 14 had been carried out along lines similar to those proposed by Mr. Nicholl in his article earlier referred to, a description and photographs of the equipment were shown him. We are privileged to abstract a letter of criticism of Car No. 14 which Mr. Nicholl recently wrote:

The Black River Traction Company is unquestionably right in its effort to make the plain roof popular and the officers should have due credit for a very wise move. Please

angles" in the narrow streets. Cities object to wide treads, because they are liable to break down the pavement near the rails and often managers will object to them because they chip the wheels. With a good wide head rail, however, provided with a beveled edge, as is being used in Chicago, there should be no objection. In such cases a long wheel base can be used much more economically than double-truck cars.

The Black River Traction Company has a 35-foot car on a single truck, seating 40 people. This answers its purposes splendidly.

**Mr. Lefebvre's Arguments for Car No. 14.**

Replying to Mr. Nicholl's letter, Mr. Lefebvre writes, in part, as follows:

**Ventilation.**

As regards the ventilation, this has to be attacked with the full knowledge that the public will not agree on anything—

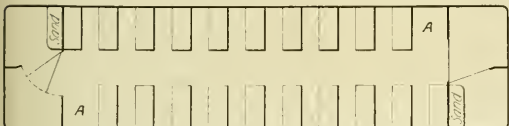

**Long Single-Truck Cars Without Monitors—Floor Plan of Car No. 14, Showing Arrangement of Vestibule Doors.**

note that without the monitor deck they claim a saving of about 1,200 pounds weight as well as the expense. Without doubt they get better ventilation and more room for the headlight in the proper place in permanent form. Now, who can say that the car does not, from a railroad (not a "bus" standpoint, look better and much more businesslike than one with a monitor?

There are a few points, however, that I would change: (1) I would put the ventilation above each window with a shutter like a stove draft, so that it might be handled by each passenger to his liking the same as in Europe. (2) I would put the register on the inside on a rod instead of a cord, so as to make it unlike the signal bell cord, thus preventing



**Long Single-Truck Cars Without Monitors—Front Platform of Car No. 14, Showing Motorman's Compartment.**

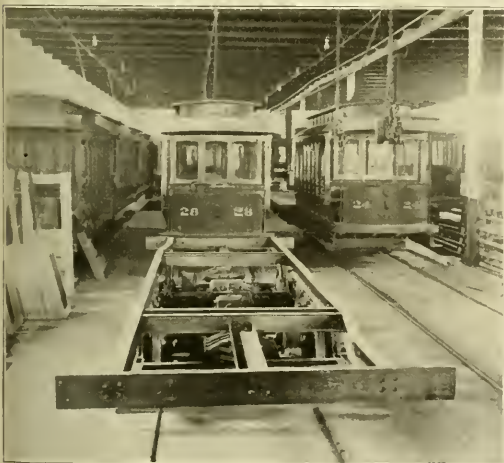

**Long Single-Truck Cars Without Monitors—End View of Steel Underframe and Long Wheel Base Truck.**

angry passengers from ringing up fares instead of stopping the cars. (3) I would bring the curtains nearer the glass.

Mr. Lefebvre seems very much in favor of a long wheel base, and he is right, provided one can be operated, but there must be ample play in the journal boxes, wide tread wheels and a gauge of the wheels much less than the gauge of the track. Otherwise the truck will not go around small radius curves.

I tried an 8-foot 9-inch wheel base in Rochester with Taylor trucks, but they were too rigid to go around "square

so we have the square front car which in parting the air forms a vacuum in the open vestibule over the step. The ventilator opening is the square hole over the door fully open in illustration of the interior of car No. 14. With this ventilator open and all other openings closed, the draft will suck a handkerchief from one's hand so that it will stand straight in a horizontal line toward the opening, when the car moves from 12 to 15 miles per hour. This refers to the front and not the rear of the car.

Under these conditions we can keep the car warm and

comfortable. No drafts are perceptible, as the front opening is fed by air coming in at the rear door and all the windows. The passengers never ask to have that opening closed, as they consider it of small moment; and as soon as the extremely cold days are past we can run with both front and rear openings open. This allows so much air to enter the car from the rear opening that passengers on the three rear seats sometimes complain that they can feel a draft on the backs of their necks, whereupon the conductor reduces the rear opening.

This system did not grow of itself. We have cut up 11 old cars in making experiments and none of these was in line with the usual practice.

#### Fittings.

Now, to speak about the register and signal cords. We have a fine assortment of rods and fittings, but we are satisfied with our present arrangement. We use a secret register, so it would not matter if passengers rang up a few fares now and then, but as a matter of record they have not done so as yet (three years). The ceiling is high, and as the car is almost absolutely quiet it is easier for a passenger wishing to get off to say in ordinary tones, "Court street," than it would be for him to reach up to the signal cord. Your experience, of course, has been with a noisy car, when a passenger would need a megaphone to make the conductor hear.

#### Trucks.

Our truck is fitted according to M. C. B. practice, i. e., the wheels are pressed on so that they have a lateral motion of  $\frac{3}{4}$  inch on standard gauge track— $\frac{1}{8}$  inch on each side. The wheels are solid forged steel, 33 inches in diameter, with  $2\frac{1}{4}$ -inch treads.

The curves in our car barn are 45 feet radius. A dead truck with motors on it ready to place under a car body can be pushed around these curves by four men if the truck has 6-foot 6-inch wheel centers and by only three men if it has 12-foot wheel centers. All other conditions remaining the same, it takes three men to push it along straight track. So we are not worried by the operation on curves of long wheel base trucks. We forget that there are curves on our line and enjoy the long wheel base on straight track.

Regarding the reference to the Taylor truck. Our center bolsters at each end of the car are made up of five 2-ton elliptics, so that we have a carrying capacity of 20 tons under the car, aside from the limiting elliptics on each side, which carry very little weight, being there to keep the car on an even keel only. A load of 100 people, which we often carry on No. 14, lowers the car body 1 inch—of which  $\frac{1}{2}$  inch is on the journal springs (four 5-ton coils) and  $\frac{1}{2}$  inch on the two bolsters. A platform load is not noticeable. The car has absolutely not a particle of galloping motion.

### CONDEMN OHIO FRANCHISE TAX BILL.

F. D. Carpenter of Lima, O., president of the Central Electric Railway Association, has issued a letter condemning the Howe bill, which has been introduced in the Ohio legislature, and which, if passed, would mean the appointment of a state franchise and tax commission to value the property of public service corporations for taxation. An abstract of Mr. Carpenter's letter follows:

You may or may not be familiar with Senator Howe's new bill, which provides for the valuation of public service corporations for the purpose of taxation. This bill provides for the appointment of a commission to value for taxation the property of all public service corporations (except water transportation companies, which for some unknown reason are omitted). The property so valued shall include all tangible and intangible properties, rights and franchises of every description, and shall be estimated as a unit, a going concern.

Two rules are laid down to control the commission. The first rule provides for adding together, first, the full market value of all bonds, or other evidences of funded indebtedness; second, the full market value of notes, open accounts or other unfunded indebtedness and liabilities; third, the total average value of all the capital stock of the corporation. The amount so obtained shall be the aggregate value of the property of the company. The second rule provides that from the gross receipts of the company shall be deducted the operating expenses, but the operating expenses shall not include any interest, dividends, expenditures for permanent betterments or fictitious salaries to officers or directors. The result so obtained shall be multiplied by not less than 20, nor more than 25, and the amount so determined shall be deemed the true capital value of the company.

The valuations so obtained, or the average of these two

valuations, shall constitute the valuation of the properties for taxation; but the commission may increase or diminish the amount so found at its discretion.

The amount shall be submitted to the governor, and approved by him, and shall then be certified to by the county auditors, and the valuation so fixed shall be taxed at the local tax rate in each taxing district. This tax is in addition to the 1 per cent tax now paid upon gross receipts.

The practical effect of this upon interurban companies will be to increase taxes to such an extent that it will require from 15 to 20 per cent of the gross receipts of interurban companies to pay the taxes. This is practical confiscation of the property.

From the annual report of the Ohio railroad commission you will see (page 534) that the gross earnings of the 57 interurban companies in Ohio from operations in Ohio amounted in the last fiscal year to \$12,256,660; the operating expenses (page 535) amounted to \$7,403,396. The net income, as defined by the Howe bill, was \$4,853,334. [These figures do not balance because there was a deficit from the operations of three roads aggregating \$10,070.—Eds.] If this sum is multiplied by 20 (the lowest rate provided in Rule 2 of the Howe bill) it gives a tax valuation for these properties of \$97,266,680. These properties are located partly in cities, where the rate of taxation is from 3 to 4 per cent, and partly in the country, where the rate varies from  $1\frac{1}{2}$  to more than 2 per cent. The average rate must be estimated, but is certainly considerably above 2 per cent. Figuring the tax rate at 2 per cent upon the valuations as found above, the actual taxes that must be paid by these companies will amount to \$1,945,333. Add to this the amount paid under the Cole law, 1 per cent upon gross receipts, and the total tax that must be paid by these interurban companies will amount to \$2,067,899, or more than 16 per cent of the gross receipts. These same roads, in addition to operating expenses, paid as interest on their funded debt \$2,399,075, and as interest on their unfunded debt \$671,018 (page 537); a total interest charge of \$3,070,093. Of these 57 roads (page 539) only 35 had any net income after paying operating expenses and fixed charges, and the aggregate net income of the entire 35 roads was \$1,092,221, while 22 of the roads had an actual deficit aggregating \$469,555. The net income of the entire 57 was only \$622,666.

Only 10 of the entire number paid any dividends; 8 upon common stock, 2 others upon preferred stock, the aggregate dividends amounting to \$424,834.

From the above figures you will see that the effect of the proposed Howe bill upon interurban companies would be:

- (1) To absorb nearly 20 per cent of the gross receipts in taxes.
- (2) To absorb in taxes four and one-half times the amount paid last year in dividends.
- (3) To absorb in taxes three times the aggregate net income of all the interurban roads in the state.
- (4) To absolutely destroy the value of all stock in every interurban road.
- (5) To in part destroy the bonds of all interurban roads, or at least to seriously affect their value.
- (6) To affect the value of the bonds would in part destroy them as collateral and result in loans being called.
- (7) It will be impossible to raise a dollar for betterments or extensions of existing interurban lines, or to finance any new propositions.

If the bill becomes a law receiverships are inevitable, and it is difficult to see how a panic can be avoided. Certainly there will have to be such drastic retrenchment that there will be a serious effect upon labor and impairment of service. Other companies may raise rates; interurban companies are limited by law.

Under these circumstances do you not think it advisable to make a special effort to arouse the interest of those in your community who are interested in public service corporations, and to see to it that your local senators and representatives are fully apprised of the meaning and effect of this bill? Prompt action is necessary. We do not believe that any fair-minded or intelligent member of the assembly who knows what the bill actually means will favor it. The danger comes from their voting in ignorance of the provisions of the bill and the inevitable effect upon the public.

#### A Unique Electric Railway.

The new \$3,000,000 office building erected in Washington, D. C., by the government for the members of the house is practically completed. It is connected with the capitol by a subway, in which a small electric railway will be operated for conveying the representatives to and from their offices.—Western Electrician.

VALUATION OF THE CLEVELAND ELECTRIC RAILWAY.

The valuation of the Cleveland Electric Railway, now in progress, involves determination of the value of (1) the physical property reproduced and (2) the unexpired franchises. When the figures have been agreed upon by the arbitrators, F. H. Goff on behalf of the Cleveland Electric Railway and Mayor Tom L. Johnson for the city, the next step will be consideration of the terms of the arrangement by which the Cleveland Electric Railway and the Forest City Railway will be controlled by a holding company.

During the hearings, which began on December 4, the following facts have developed:

Mayor Johnson has admitted frankly that the charges of the Cleveland Electric Railway Company to capital account were more conservative than his would have been under similar circumstances.

Mr. Goff has urged that in the final negotiations some consideration be given to the fact that the "lost capital account" was the result of a misguided belief that when the franchises expired they would be renewed without difficulty.

As the value of the railway is to comprise what it would cost to reproduce the property there must be added to the agreed appraised value of the physical property an allowance sufficient to cover all costs of engineering, financing and contingencies. Horace E. Andrews, president of the company, believes that to provide for expenses of this description there should be allowed one-third of the worth of the physical property.

The value of unexpired franchises is to be based upon the net earnings of lines with unexpired rights, the operating expenses (including depreciation charges) and taxes to be computed at about 60 to 65 per cent of gross earnings.

Values of Physical Property.

Under the plan of appraisal committees of two, representing the city and the company, value the different classes of property. The physical values upon which full agreement has been reached are as follows:

Track .....	
Pavement .....	
Cars .....	\$2,634,563.23
Land .....	1,134,473.96
Buildings except power and battery house buildings.....	842,987.00
Overhead construction, including feedwire.....	1,907,957.55
Return circuit .....	95,409.02
Three power stations, including buildings.....	2,216,990.93
Storage batteries, including buildings.....	289,862.94
Shops, shop stores and shop tools.....	
Auditors' stores, including rails, ties and track.....	
Miscellaneous rolling stock and equipment.....	154,764.71
All items (except franchise) not included in other schedules .....	
Overhead charges not included in other schedules.....	

Work is in progress upon the other items. The report of the committee which is determining upon the value of the track is expected at any time. Substantial agreement has been reached as to the value of the pavement, but the arbitrators have not agreed as to whether the company shall be allowed anything for paving. The position of Mr. Goff on this subject was stated at one of the early meetings, as follows: "Pavement is a part of roadway with a street railroad. The city stipulates how the track shall be laid and what rails shall be used. Possibly now your specifications go into detail to such an extent as to stipulate in regard to the character of the foundation. It has been, as far back as I can remember, the uniform practice in this city to require a specific, certain kind of pavement. It seems to me that this is to be regarded as a part of the roadbed cost. It is either a part of the capital account or else must be chargeable to operating cost." Mayor Johnson is not disposed to allow much for pavement. The value of shops, shop stores and shop tools has also been substantially agreed upon. The value of auditors' stores, including rails, ties and track has been prac-

tically agreed upon, although during the inventory some question has been raised as to the unit prices which should be followed. The schedule providing for "all items (except franchise) not included in other schedules" is still open, and there is uncertainty as to admission of some of the items.

Overhead Charges.

In consideration of the amount which should be allowed for the last item in the foregoing list, there has been a wide divergence of opinion, although it is recognized that the value upon which agreement is sought is the value of the Cleveland Electric Railway if reproduced. Mayor Johnson has endeavored to minimize the necessity of a substantial allowance for the overhead charges, but the Cleveland Electric Railway has produced considerable testimony in support of its claim that engineering expenses, profits of contractors, contingencies and cost of financing would be large. The view expressed by William Barclay Parsons, who appeared before the arbitrators on January 25, was that 10 per cent should be allowed for contingencies, 10 per cent for the profits of contractors and a minimum of 5 per cent for engineering expenses, to which other essential charges might have to be added, making altogether a possible total of 30 per cent. Mr. Parsons declared that to place the property in the streets of Cleveland had taken a high order of engineering ability. It was not especially to the liking of Mayor Johnson that in response to questions Mr. Parsons expressed his belief that the Cleveland Electric Railway property could not be built in less than three years if ordinary street traffic should be permitted during the construction period. In this estimate Mr. Parsons assumed that there would be no tracks, shops, power houses, substations, car houses or definite ideas on the part of those who intended to build concerning what routes they should utilize. If the people were kept off of the streets the system could be built, he estimated, in two years.

Eugeue Klapp, who is associated with Mr. Parsons, estimated that the engineering expense would be not less than 5 per cent and that 10 per cent should be provided for contingencies.

In first discussing, on January 16, the question of extra expense for which allowance should be made, Mr. Goff referred to the delay which had been experienced in the construction of the Washington Baltimore & Annapolis Electric Railway, the Utica & Mohawk road, the Chicago Lake Shore & South Bend Railway and the Youngstown & Ohio River Railroad. Mr. Goff emphasized the fact that the value as of January 1, 1908, was to be considered; that time, he said, would perhaps have been the least favorable to finance an enterprise of this character of any period since 1873.

Letters were presented by Mr. Goff concerning the percentages which should be added to the cost of labor and materials required to reconstruct the Cleveland Electric Railway with its 236 miles of track and various properties.

Stone & Webster of Boston replied that their usual charge for engineering was 10 per cent of the cost of the physical property.

J. G. White & Co. of New York replied that they usually received 10 or 12½ per cent above the cost for constructing a street railway property.

Sanderson & Porter of New York replied that their regular fee for designing and constructing a street railway property is 10 per cent of the cost, where the work is undertaken on that basis.

At the meeting on January 17 Mr. Goff presented letters from various people concerning the expense of financing and other costs incident to the construction of a new property. H. R. Newcomb, president of the Citizens' Savings & Trust Company of Cleveland, said that the Forest City Railway had sold its stock to the Municipal Traction Company at 90, the latter disposing of the stock at par. It would be practically impossible, he declared, to finance the construction of an

electric railway in a city like Cleveland for less than 10 per cent of its cost, and no contractor would undertake the construction of a property of this character for less than a 10 per cent margin to cover overhead charges. About 6 per cent should be figured for interest charges during the construction period.

Myron H. Wilson, vice-president of the Cleveland Trust Company, figured 10 per cent for discount on the bonds and 7.1 per cent for interest charges during the period of construction.

G. T. Bishop, president of the Washington Baltimore & Annapolis Electric Railway, said that 20 per cent of the cost was an underestimate of the percentages that should be added to the cost of the physical property to cover the expenses of organization, purchasing, engineering, superintendence and incidentals.

M. J. Mandelbaum of Cleveland, in his estimate, allowed 0.15 per cent for organization expenses, 5 per cent for engineering, 0.4 per cent for general administration, purchasing and auditing department expense, 1 per cent for caring for and handling material and 3 per cent for delays in construction without taking into account other losses incidental to delays. No allowance is made here for legal expenses of organization, litigation and incidentals, but Mr. Mandelbaum suggested an average interest charge on the cost of the property of 6 per cent during the construction period and 5 per cent for brokerage, and also stated that provision should be made for taxes for two years.

B. E. Tilton, engineer maintenance of way Cleveland Electric Railway, said that an allowance of 15 to 20 per cent would be what might be called "ideal condition values."

#### Valuation of Franchises.

In the valuation of the unexpired franchises it has been determined to capitalize the net earnings of the lines which have rights. It is the idea of Mayor Johnson that 65 per cent of gross earnings shall be allowed in this computation for operating expenses (including depreciation) and taxes and that the balance of 35 per cent shall be assumed as the net earnings. Henry J. Davies, secretary of the Cleveland Electric Railway, in discussing the method of computing the franchise values, said on January 24 that the earnings of each line, the earnings per car-mile, the number of passengers and the percentages of increase in traffic in the past on each line on which changes have not been made would have to be determined. "What we know of the past," he added, "will be some basis for determining what we do not know of the future. On a line with two franchises estimates will have to be made. We may decide to take the earnings as a whole and per car-mile and then estimate the growth and operating expenses on different lines. I think we will find the rate of growth higher on the long lines than on the short lines and larger on the suburban lines than on the city roads."

#### Reduced Prices of Materials.

The question of value of materials as of January 1, 1908, has raised discussion on the subject of values under conditions of higher costs. Mayor Johnson has called attention frequently to the decline in the price of copper, which he estimated as involving a loss to the Cleveland Electric Railway of about \$1,000,000. Mr. Goff suggested that if the various lines should be operated by the company until each franchise had expired much higher prices for the materials might be granted because the values of commodities might advance.

#### Fares and the Security Franchise.

While there has been considerable discussion of the question of fares under the new arrangement and of the terms of a security franchise which it is proposed shall be granted to the Cleveland Electric Railway, no effort has been made to reach a compromise.

Mr. Goff has expressed the opinion that a franchise based on seven tickets for 25 cents would not enable the company to market its bonds for 75; he thought the city should grant a franchise which would make it possible for the company to raise capital without selling bonds at a discount of 20 or 25 per cent, or even 10 per cent. The cost of operation may be greatly increased, as it has been in the last 25 years. He believed that the people of Cleveland desire more rapid transit; and to meet those needs would require additional capital for the construction of track on which express trains could be operated. He said he had been told that the Forest City Railway is operating for 10 or 12½ cents per car-mile, while its gross earnings are something like 16 or 17 cents, but that no construction of the character of that of the Forest City Railway would be permitted on the new property. He declared that when the report on car-mile earnings of the Cleveland Electric Railway is completed it will be found that the operating expenses are something like 16½ cents per car-mile, while the gross earnings would be 25 or 30 cents upon some lines.

Mr. Goff said he did not think he was committing any breach of confidence when he said it was his understanding that if a franchise, based on seven tickets for 25 cents, had been granted to the Cleveland Electric Railway, it would have been unable, as the officials believe at this time, to finance any future development of the property. He would eliminate the possible construction of subways, but no capital for an express service on surface lines could have been raised.

In speaking of the straits of the company when the offer to accept a franchise based on seven tickets for 25 cents was made, Mr. Goff said that the officials "were driven pretty nearly to the last ditch and it seemed to them that they would better accept the franchise on these terms and do the best they could until possibly they had become wiser, or the people had become wiser; but they did not contemplate that they could ever raise revenue enough from operation or borrowing that would permit any development of importance. You will concede that a 3-cent fare will not yield any large revenues that will permit a rapid development of the property."

Mr. Goff also suggested that it could do no harm to the city of Cleveland if there are not unreasonable provisions of forfeiture in the lease, and that it might result in good to the municipality if in times of need the company could increase the fare and derive necessary revenue for development of the property.

Mr. Davies has also expressed the opinion that the sale of fares on the basis of seven rides for 25 cents would "earn a dividend of 6 per cent upon the value fixed in the negotiation, on its conclusion, of our physical value and franchises."

Mayor Johnson believes that the franchise should be for a period of 25 years, the longest time for which the council could grant it; and he would make the period 50 years if the council had the authority.

The committee appointed to report upon the expiration of franchises, S. H. Tolles and Newton D. Baker, agreed that various franchises expired from 1905 to 1927, but could not agree upon other rights.

#### Mr. Goff Performing a Public Service.

Mr. Goff has undertaken as a public service the work which he is performing. The suggestion of this method of settling the differences was made by E. H. Baker of the Cleveland Plain Dealer. In his opening address to the city council, Mr. Goff stated that his sole financial interest in the property was the ownership of 200 shares of stock of the Cleveland Electric Railway by himself and 130 shares by his wife; and that if it was felt that any unfairness would result from these holdings he would make such disposition

of them as Mayor Johnson would approve. Mr. Goff has announced that he will accept no fee for his services.

In pointing to the difficulties of the present situation Mr. Goff said he was called upon to recognize that a lease to a holding company was the only solution available to the company at this time; but if such an adjustment should be made a proper security franchise must be granted to the Cleveland Electric Railway. Unless the holding company maintained the property, providing for accident liability and depreciation, it might eventually be returned to the Cleveland company less valuable than when it was delivered to the Municipal Traction Company, which has an authorized capital of \$10,000 and a paid-in capital of \$1,000. Mr. Goff said that the Municipal Traction Company was irresponsible financially.

**Electric Package Agency.**

In the discussion concerning various assets, the business of the Electric Package Agency was mentioned. Mr. Davies said that this business is not incorporated, but is a partnership. The interest of the Cleveland Electric Railway in the furniture and equipment of the agency should be listed as an asset. The company receives from the agency such proportion of its net earnings as is shown by the number of car-miles run over the tracks of the Cleveland Electric Railway out of the total. He thought that the equipment, except the cars, had been purchased from earnings. The cars belong to the interurban companies and not to the agency.

Mr. Andrews said that while the actual tangible property might be of small value, the business is of great value; within the last six months various express companies have tried to negotiate for possession of the property, but the companies preferred to hold it themselves.

Mr. Davies said that last spring the property was inventoried at about \$24,000, and it was the interest of the Cleveland Electric Railway in that amount which was estimated at that time at \$4,000.

In response to a question, Mr. Andrews said that the contract with the interurban roads for the handling of this business had decided value, but that the profit was included in the gross earnings, and was part of the franchise value.

Mr. Davies added that the contract is between the Cleveland Electric Railway and the interurban companies, and that it contained a provision that earnings for the carriage of packages should be divided in proportion to length of haul.

**Electrification of St. Petersburg Street Railways.**

All of the 130 miles of street railway in St. Petersburg are to be electrified within the next six years. The first section, 30 miles in length, has been finished by the Westinghouse Company. For operating this section of the lines a central station has been located upon the Obvodny Canal, where it can receive coal from barges. Three turbine-alternator units placed in the dynamo room operate at 1,500 revolutions per minute and are rated at 2,200 kilowatts, delivering 6,600 volts at 25 cycles. The boiler room contains six double boilers, and the plant is also equipped with a battery of 130 cells of accumulators. Five substations are used for the line, and each of these will have a capacity of 1,000 or 2,250 kilowatts, according to its location. In the substations are installed a set of oil transformers which receive the main current from the central station at 6,600 volts. At the secondaries of the transformers the voltage is 370 volts three-phase. This is used upon rotary converters which supply direct current at 600 volts for the trolley wire. Different capacities, either 500 or 150 kilowatts, are used for the rotaries, and the machines are started up by a small three-phase motor, or else a storage battery which the station contains can be used for starting if necessary. The rolling stock used upon the first section consists of 200 motor cars. Each of the cars is fitted with two 40-horsepower motors. The old horse cars may be used as trailers.—Journal of Electricity, Power and Gas.

**TYPICAL TRACTION CARS.**

BY CHARLES A. HERON, INDIANAPOLIS, IND.

At the meeting of the Indiana Engineering Society at Indianapolis, Ind., on January 16, Charles A. Heron, assistant engineer Indianapolis Traction & Terminal Company, Indianapolis, read a paper on "Typical Traction Cars." After outlining the development of the cars now in use from the early horse car, the paper took up the discussion of the

Table No. 1.

TRUCK CENTERS (feet)				
Length of car	Min.	Av.	Max.	Av. % length
40		17		42.5
45	20	22	27	49
50	26.5	27	30	54
55	30	32	33.5	58.2
60		37		61.6
65		42		64.6

Minimum for 45-foot car is for city use.  
Maximum is for express.

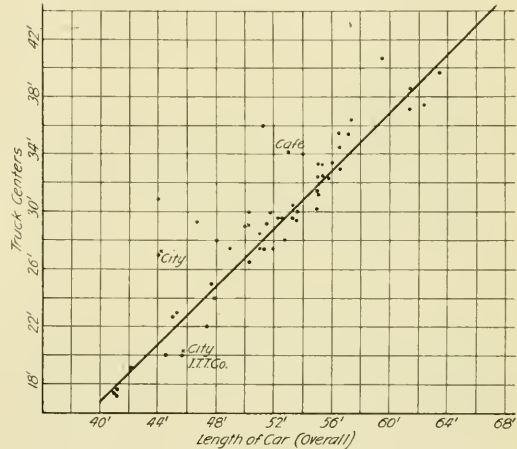

Typical Traction Cars—Curve 1. Relation Between Length of Car and Truck Center Distance.

dimensions, weight and seating capacity of typical cars now operated, based on a compilation made by the author from measurements of nearly 100 cars used by various companies, furnished by such representative car builders as the St. Louis Car Company, Niles Car & Manufacturing Company, The J. G.

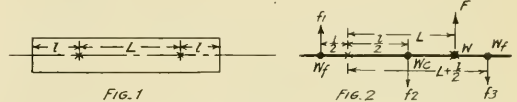

Typical Traction Cars—Figures 1 and 2. Quantities in Formula for Determining Truck Swinging Force.

Brill Company, Cincinnati Car Company and Jewett Car Company. An abstract of this part of the paper follows:

Table 1 and curve shows the relation of truck centers to length of car bodies. An interesting fact known to exist is that a considerable force must be exerted by the track to turn a car body when entering upon a curve. This force is greatly increased as the trucks are set back from the ends. The author has derived an equation for this force and has calculated values, assuming a 62-foot car body weighing 40,000

pounds, for different truck centers. These values have been plotted.

Let Figure 1 represent the outlines of a car body and Figure 2 represent the weights, or masses of the front, center and rear portions of the body, assuming them as concentrated at their respective centers of gravity.

W = force required to turn car body about rear truck center and applied at the front truck center.

f<sub>1</sub> = force required to turn concentrated weight of rear end of car about rear king bolt.

f<sub>2</sub> = force required to turn concentrated weight of center of car about rear king bolt.

f<sub>3</sub> = force required to turn concentrated weight of front end of car about rear king bolt.

W<sub>r</sub> = W<sub>c</sub> = concentrated mass of front and rear ends of car = WL.

W<sub>c</sub> = concentrated mass of center of car = WL.

W = concentrated mass of car at front truck center.

w = weight per lineal foot of car body.

$$M_1 = \text{rear moment} = f_1 \times \frac{1}{2} = W_r \times \frac{1}{2}$$

$$M_2 = \text{center moment} = f_2 \times \frac{1}{2} = W_c \times \frac{1}{2}$$

$$M_3 = \text{front moment} = f_3 \times (L + \frac{1}{2}) = W_r \times (L + \frac{1}{2})$$

$$M = \text{total moment} = W \times L = M_1 + M_2 + M_3$$

$$M = WL = M_1 + M_2 + M_3 = (f_1 \times \frac{1}{2}) + (f_2 \times \frac{1}{2}) + [f_3 \times (L + \frac{1}{2})]$$

which is, therefore, the equation for the sum of all the moments of forces acting to turn the car body about the rear king bolt. This sum of moments is also equal to the moment of a force which, if concentrated at the rear king bolt, would cause the car body to turn about the rear king bolt.

This concentrated force at the front king bolt may be considered as like unto the force which must be exerted by a curved track. Solving for the force:

$$(W_r \times \frac{1}{2}) + (W_c \times \frac{1}{2}) + [W_r \times (L + \frac{1}{2})]$$

$$W = \frac{\dots}{L}$$

This equation will apply only to a stationary car. This assumption is permissible, because if in motion the force to be overcome by the track would be proportional to the velocity of the car. In fact, the force to be exerted for the car in motion may be considered as the concentrated weight, W, times the velocity, V. This turning force is a maximum when the front truck is at the point of curve; and is a minimum when the rear truck reaches the point of curve. From this position the force exerted on the curve track by the car body is centrifugal plus the minimum value of "F" to keep the car turning along the curve. Conversely this force "F" diminishes

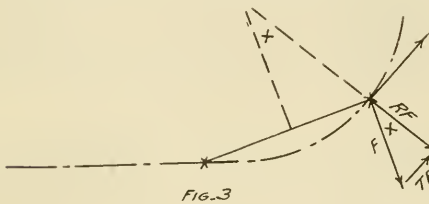

Typical Traction Cars—Figure 3. Relation of Instantaneous Values.

to zero from the time that the front trucks leave the point of tangency until the rear trucks leave the point of tangency.

Consider the force acting at any point on the curve as in Figure 3.

Let F = force required to turn car body about rear trucks = WV.

TF = component of "F" tangent to curve = F sin x.

RF = component of "F" against track = F cos x.

x = angle formed between radius of curve, R, at the instant of consideration, and the perpendicular drawn from the center of curve to the center line of car body.

Table No. 2.

Side Force "W" to Front Truck Center to turn 62-foot 40,000-pound car about rear trucks for different truck centers.

"L" (feet) .....	30	34	38	42	46	50	54	58	62
"W" (pounds) .....	25500	23715	22430	21530	20890	20460	20190	20040	20000

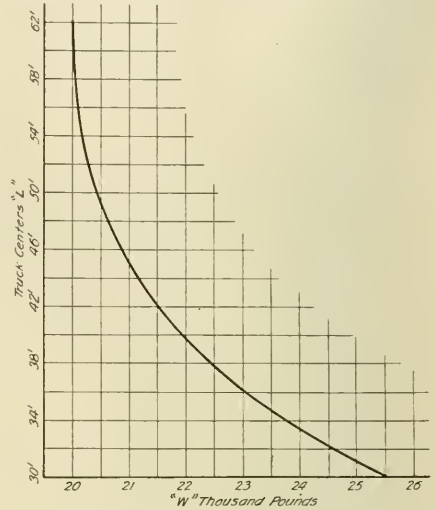

Typical Traction Cars—Curve 2. Relation of Weight and Truck Centers.

Table No. 3.

WEIGHTS OF CAR BODIES

Lengths (feet)	Min.	Av.	Max.
41	15,000	17,000	18,000
45	.....	21,500	25,000
47	.....	21,000	.....
50	25,000	28,000	30,000
55	33,500	35,000	37,000
60	.....	38,000	.....
65	.....	41,000	.....

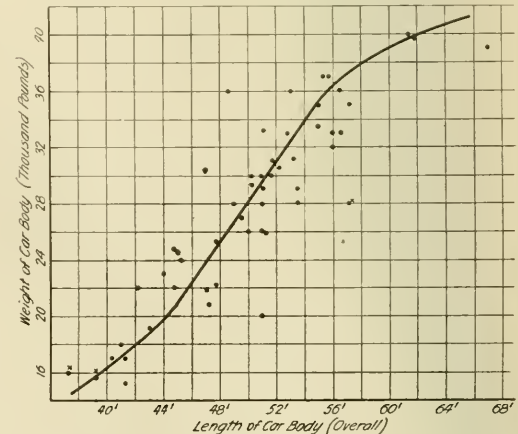

Typical Traction Cars—Curve 3. Relation of Length to Weight.

x is a maximum when the front truck is at the point of curvature, then  $\sin x = 0$ .

x is a minimum when the rear truck is at the point of curvature, then  $\sin x = \frac{2R}{\dots}$

Then  $RF = F \cos x = WV \cos x$  for each position on curve.

The maximum is seen to be  $F \times (\cos x = 1)$  and the minimum value of resultant force on the track to be  $F \times (\cos x)$  when  $\sin x = \frac{2R}{\dots}$

While the present position of trucks is not the most economical, placing the trucks farther apart means a change in the design of car truss, or changing the entrance from the platform. Without change of entrance the present truss framing must be abandoned and the steel truss floor used as on late steel cars for steam railroads. Although the side overhang will, of course, be increased, this may be a slight matter as compared to the decrease in impact on a curve at high speeds. By lengthening the truck centers a better design may be effected for cars to be run in trains through city streets. This method of operation is, however, affected by the radius of the shortest curves.

The actual force on the curved track, then, is directly pro-

portional to the force of 1,533,333 pounds.

Table 3 and curve show the relation of weights of car bodies to lengths. The effect of heavier design is very manifest for cars 48 feet to 54 feet long. Beyond this length, while the design remains practically the same, the increase in weight is not in proportion to the length. The same is true for cars up to 48 feet long used for city and light suburban service.

Table 4 and curve shows relations of seating capacity to

Table No. 5.

SEATING CAPACITY				
Weight of car body (pounds)	Min.	Av.	Max.	
17,000	40	43	44	City and suburban cars
22,000	50	50	52	
32,000	60	65	72	
36,000	.....	.....	.....	
24,500	42	46	48	Two-compartment cars
28,000	50	52	60	
33,000	.....	61	65	
28,000	45	46	46	Three-compartment cars
32,000	.....	51	56	
34,000	52	53	54	
40,000	40	58	58	

Table No. 4.

SEATING CAPACITY				
Length (feet)	Min.	Av.	Max.	
41	40	42	44	City
45	.....	50	.....	
45	42	43	44	Two-compartment
48	48	49	50	
50	.....	53	.....	
55	.....	60	.....	
60	.....	66	.....	
50	.....	43	52	Three-compartment
55	50	54	.....	
56	54	56	61	
58	58	.....	.....	

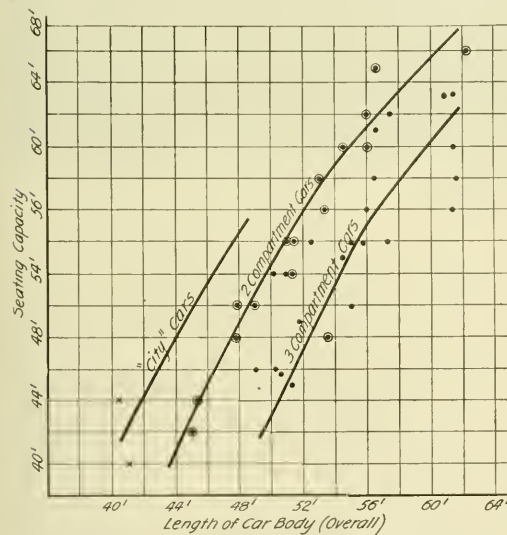

Typical Traction Cars—Curve 4. Relation of Length to Seating Capacity.

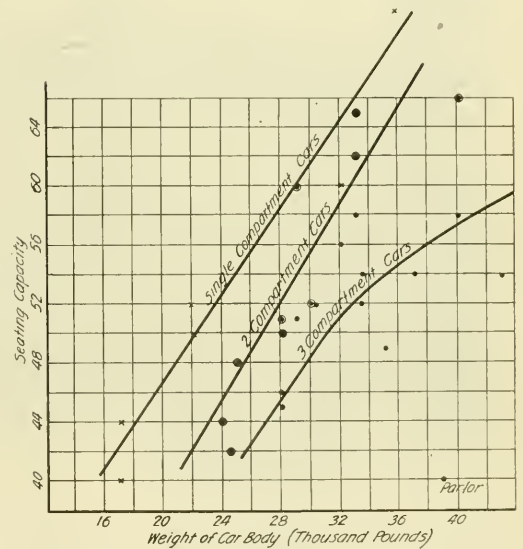

Typical Traction Cars—Curve 5. Relation of Weight to Seating Capacity.

lengths of car bodies. The excess of seating capacity of 2-compartment cars over 3-compartment cars for the same length is noted, as is also noted in Table 5 and curve for weights versus seating capacities. Curve 4 shows that seating capacity does not increase in proportion to length. This is accounted for by the fact that more seat room is allowed on the larger cars. It may also be noted that 55-foot to 60-foot 3-compartment cars have practically the same seating capacity. Curve 5 shows the rapid decrease in seating capacity for the heavier 3-compartment cars. From these the relative carrying capacity of baggage versus passengers is shown to be a question for the operating men to decide upon as against the convenience and safety of the traveling public.

portional to the truck centers and indirectly proportional to the radius of the curve. On long-radius curves this force decreases but little because of the small angle subtended by the truck centers.

Assuming a 3-degree curve whose radius would be 1,910 feet and a speed of 50 miles per hour ( $V = \text{ft. per second}$ ), 38-foot 6-inch truck center, the 62-foot car body mentioned

It is stated that the Southern Michigan Railway Company, operating between St. Joseph, Mich., and South Bend, Ind., intends to use a large tract of land which it controls along the banks of the St. Joseph river near Berrien Springs, as an amusement park. Picnic grounds, a boathouse, bathing beach, a vaudeville theater and other park attractions will be provided, making it one of the largest resorts of the kind in this section of the country.

### THE MANHATTAN TERMINAL EXTENSION OF BROOKLYN BRIDGE.

What promises to be a satisfactory solution of a difficulty which has caused a part of the congestion on the elevated level of the Brooklyn bridge has now been so far completed as to have been in service for several days. The trouble consisted chiefly in the lack of room at the Manhattan terminal to handle elevated trains of sufficient length to care for the volume of traffic offered during rush hours. A remedy which should afford at least a partial relief temporarily seems to have been found in the substantial completion of an extension to the former structure, the principal features of which are shown in the accompanying engravings, which also indicate the rearrangement of tracks which has been made possible by the extension.

The extension proper is 160 feet in length and is carried over Park Row and the adjacent City Hall plaza almost to the line of the fence surrounding City Hall park, thus bringing the stairway leading to the elevated track level just opposite

sion of other platforms in a fairly corresponding proportion.

Ample provision of stairways has been made throughout and with the additional loading and unloading space afforded by the use of trains of six cars each it is reasonable to suppose that the improvement will go far to relieve the congestion which has made the reputation of the bridge as unsavory as its original conception and construction were brilliant.

The actual results that are expected to come from this rearrangement of the Brooklyn bridge are covered in a statement given to the public by James W. Stevenson, one of the commissioners of the bridge department of the city of New York. Mr. Stevenson says that the changes are:

That 6-car bridge trains will be run in place of the 3-car cable trains which have heretofore performed the bridge service.

That fares of local passengers will be paid on entering, in order to save the trouble of conductors collecting fares on trains.

It is offered that the increase in trolley service will be

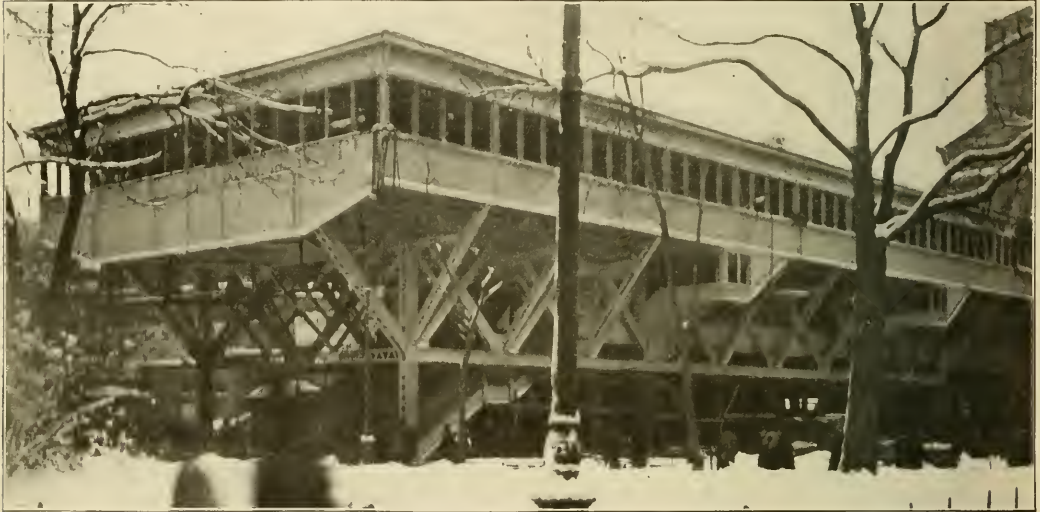

Manhattan Terminal Extension of the Brooklyn Bridge—General View of Extension over Park Row.

the entrance to and exit from the subway. It is a substantial steel structure, architecturally in keeping with the existing projection of the bridge approach over Park Row, and besides the broad stairway which extends across the whole width of the end (40 feet) affords room for five other stairways in addition to those which led to the bridge previously crossing over Park Row. A mezzanine floor furnishes space for the further distribution of crowds before reaching the track level above. The tracks extend to the end of the structure.

Formerly the crossovers between the inbound and outbound tracks leading to and from Brooklyn were at the point indicated upon the engraving by dotted lines. They have been removed to the position shown by the full lines and, even with this curtailment of loading and unloading space, the extension affords about 340 feet of free space between the fouling points of the switches at the crossovers and the end of the tracks. This is ample for the accommodation of 6-car trains.

Some slight alterations in the limits of the previously existing platforms are involved in the change and these are also indicated by dotted lines on the engraving. The removal of the crossovers has necessitated cutting off the ends of some of the platforms, but has also enabled the exten-

increased from 270 to 310 cars in the morning rush hours and from 300 to 320 cars in the evening rush hours.

Beginning on January 27 (Monday) 6-car trains from all the Brooklyn elevated lines have run through to the Manhattan terminal from the various lines of the Brooklyn Rapid Transit Company; also, during the evening rush hours trains will run from the Manhattan terminal at Park Row straight through to the terminals of the several lines in Brooklyn. The important feature of this change is that it will obviate the necessity of a change at the Brooklyn end of the bridge, which has been necessary with the previous arrangement of bridge trains.

It is stated by those in position to know that the new arrangement will increase the capacity of the bridge 9,000 passengers per hour. The avoiding of a change of cars at the Brooklyn end of the bridge is the important feature. Heretofore all trains across the bridge have been shuttle trains. Under the new arrangement, which went into effect on January 27, the shuttle trains are practically discontinued. At the present time all trains run through to or from the Manhattan terminal.

It is unfortunate for the estimation in which the bridge extension will hereafter be held by residents of Brooklyn that



the first impressions of its efficiency were disagreeably colored by its first two days of service—January 27 and 28— which are characterized by the New York papers in their usual unfriendly spirit as resulting in the worst congestion in its history. This was due in a large measure to the lack of familiarity on the part of the public and employes as to the proper lines of progression and partly, also, to the fact that the interlocking system is not yet in order. C. M. Ingersoll, chief engineer of the city bridge department, and W. S. Menden, assistant general manager of the Brooklyn Rapid Transit Company, both expressed the opinion that the service would be all right when the employes and the public were

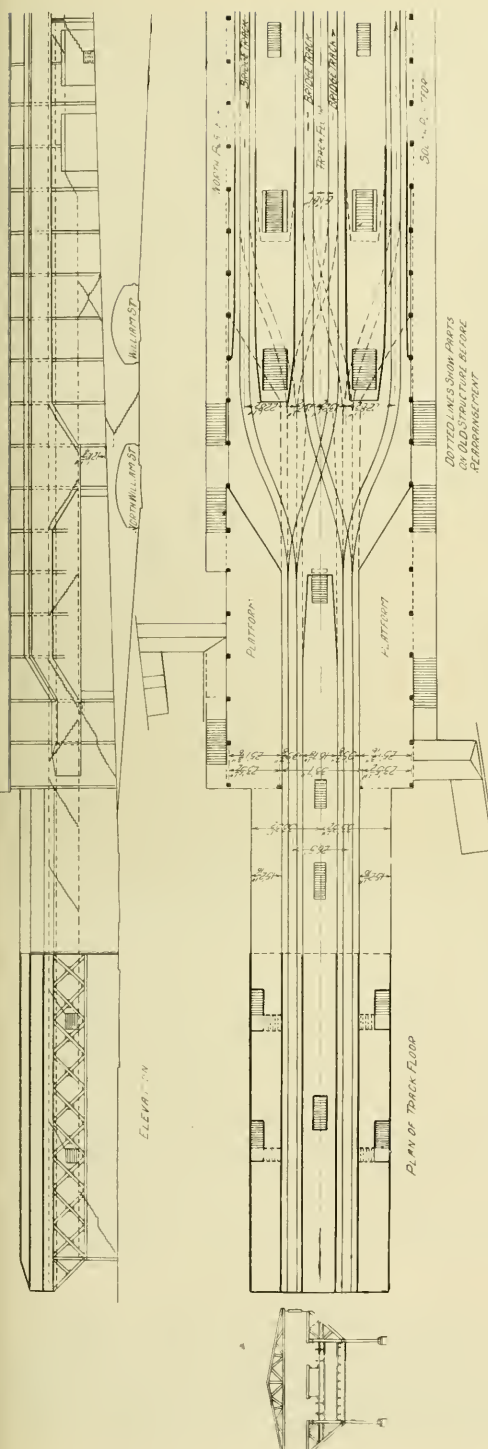

Manhattan Terminal Extension of the Brooklyn Bridge—Side Elevation and Plan of Track Floor.

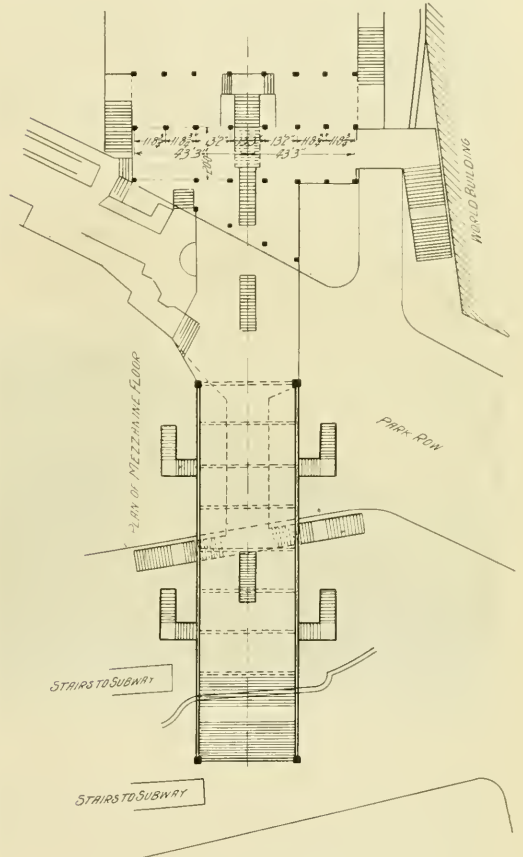

Manhattan Terminal Extension of the Brooklyn Bridge—Plan of Mezzanine Floor.

accustomed to the new arrangement. The jam on Tuesday morning, though less serious than on Monday evening, caused considerable delays to several through trains and few were able to pull out promptly from the Brooklyn end, because of the crowds that attempted to board the through trains at that point. An explanation made by an engineer employed by the public service commission gives less reason for hope that the trouble will soon be abated. It is stated that the old cable cars normally carried about 10 per cent more passengers than the present cars are capable of carrying, even though six cars instead of five are run in a train, and it is hardly probable that the former headway of 60 seconds can be reduced. It is, however, stated from the same source that

the principal difficulty is in the absence of side doors and the small gate room on the elevated cars. The total width of entrance space is figured as 18 feet 9 inches less on the elevated than on the former bridge cars, equivalent approximately to a stream of nine persons abreast.

Notwithstanding these difficulties the rearrangement should result in an improvement of service and these pessimistic views are undoubtedly strongly colored by the partial failure of too optimistic expectations, especially at the outset. On Wednesday the service showed a great improvement and as many as 64 trains per hour were handled from the Manhattan terminal.

The plans were prepared and executed by the department of bridges of the city of New York, C. M. Ingersoll, chief engineer, in consultation with and in accordance with the general views of the Brooklyn Rapid Transit Company as operating tenant. The work has been pushed to completion with remarkable rapidity and there has been no substantial interference with traffic, notwithstanding that this is stated to have amounted to 426,000 persons daily.

#### A POWERFUL WORK CAR.

BY H. L. WEBER, CHIEF ENGINEER FT. WAYNE & WABASH VALLEY TRACTION COMPANY.

An interesting equipment which was used in the construction of the recently completed 38-mile extension of the Ft. Wayne & Wabash Valley Traction line from Logansport



Construction Car for the Ft. Wayne & Wabash Valley Traction Company.

to Lafayette, Ind., was built in the company shops at Ft. Wayne last year. This equipment is a double-truck single-end work car built for handling gravel, ties, rails and poles and can also be used as a locomotive. It was designed by and built under the supervision of Lee W. Jacques, master mechanic, and was placed in service in April, 1907.

The car is 37 feet over all. The sills consist of four 80-pound 7-inch T-rails, with wood fillers. The cab is situated on the front end of the car, immediately over the front truck, and is elevated from the car body by two pieces of 15-inch I-beams bolted to the two middle sills. This gives the cab a clearance on the outside above the floor of the car for convenience in handling long steel rails. The operating equipment consists of one L-4 controller, automatic circuit-breaker, necessary light, headlight, air pump and heater switches, fuses, etc., and the straight air brake equipment for operating the brake. One circuit of L-43 Consolidated heaters is also installed for heating the cab. The headlight can be used on either end of the cab as desired.

The trucks are of the heavy Baldwin M. C. B. type, with a 77-inch wheel base, 33-inch steel-tired wheels, with a 1 by

7/8 inch flange and a 3-inch tread. The axles are 6 inches in diameter, with 5 by 9 inch journals. Four Westinghouse No. 121 motors, of 90 horsepower each and having a gear ratio of 17 to 58, are installed. The car is equipped with straight air brakes using a D-2 E. G. Westinghouse compressor with a 12 by 14 inch cylinder. The couplers are of the Janney M. C. B. type for standard steam railroad practice.

This car was used for ballasting in connection with two locomotives run in relays. The first relay was from the gravel pit to Colburn, 10 miles, and the second from Colburn to Delphi, Rockfield, Clymers or Logansport. Each relay consisted of 10 to 14 flat cars of 15 yards capacity each, or four Rodger ballast cars of 30 yards capacity each and three to four flat cars of 18 yards capacity, making a total for each train of from 165 to 180 yards of ballast. Nineteen regular flat cars with 15 yards on each car were handled a number of times and in one instance four Rodger ballast cars, a "dead" engine and 10 flat cars were hauled and set in on the siding in order to clear up the track. In comparison with the locomotives in connection with which the relay system of hauling was used, it is interesting to note that the work car took its relays and handled them with greater ease and facility than either of the engines. The car is so constructed that it can be loaded with 18 yards of ballast, which helps to give it traction capacity.

#### RECEIVERS AGAIN APPOINTED FOR THE CHICAGO & MILWAUKEE ELECTRIC RAILROAD.

Receivers have again been appointed for the Chicago & Milwaukee Electric Railroad. The property is now under the direction of the United States court and the situation is entirely different from that which precipitated the unexpected appointment of receivers by Judge Tuthill of the Cook county circuit court on December 31, 1907, and the subsequent dismissal of the bill on January 4.

Upon application of several creditors three receivers were appointed for the railroad on January 27 by Judge P. S. Grosscup of the United States circuit court and one receiver was appointed for A. C. Frost & Co., of which A. C. Frost, president of the railroad, is the head. The receivers appointed for the railroad were A. C. Frost, W. Irving Osborne, vice-president of the Central Trust Company of Chicago, and D. B. Hanna, vice-president of the Canadian Northern Railway, Toronto, Ont. George M. Seward, formerly secretary of the railroad, was appointed receiver for A. C. Frost & Co. The action was understood to be a friendly one on behalf of the interests in control of the property.

These proceedings were entered into without notice to Charles G. Dawes, president of the Central Trust Company of Chicago, who had been appointed trustee under the agreement by which the former proceedings was dismissed. As soon as Mr. Dawes learned of the situation in Washington, D. C., where he had gone for a brief visit, he returned to Chicago, and protested to Judge Grosscup that it would not be proper for Mr. Frost to be one of the receivers, supporting his protest with charges of improper accounting methods. Judge Grosscup resented these charges at first, but on January 30 he announced that Mr. Frost had asked to be relieved of his appointment as receiver. In his place H. A. Haugan, president of the State Bank of Chicago, was suggested as the third receiver. The appointment of Mr. Haugan to this position was announced by Judge Grosscup on January 31.

#### Charges Made by Mr. Dawes.

The charges made by Mr. Dawes were contained in a letter to Judge Grosscup, of which an abstract follows:

I object to A. C. Frost as receiver of the Chicago & Milwaukee Electric Railroad for the reason that from my investigation of the affairs of this road in an effort to secure a peaceable settlement of its difficulties I have discovered that he has induced the security-holders to purchase the bonds of

the road upon statements of net earnings which are absolutely misleading.

I have in my possession the statement of accounts from the firm of Barrow, Wade, Guthrie & Co., made after an examination of the books of the Chicago & Milwaukee Electric Railroad, the Republic Construction Company, A. C. Frost & Co. and the other allied Frost interests.

This statement shows that in the case of alleged freight earnings for the year 1904, the total of which is stated to be \$163,814.91, there were included charges to the Republic Construction Company, the stock of which is owned entirely by A. C. Frost, of \$158,791.85 for hauling gravel and dirt and construction material, etc., for building the road itself.

This statement shows that of the total freight earnings for 1905, which were stated as \$232,538.76, the sum of \$228,255.80 was for the same items.

This statement shows that of the total freight earnings for 1906, which were stated as amounting to \$305,450.77, the sum of \$294,695.25 was made up of similar items.

The statement also shows that for the 11 months of 1907 ended November 30, 1907, the freight earnings, amounting to \$313,759.13, included similar charges to the Republic Construction Company for hauling gravel and dirt to the amount of \$267,792.70.

The accountants also found in connection with the passenger earnings that it was the practice of A. C. Frost & Co. arbitrarily to increase the passenger earnings by means of their checks given weekly for amounts ranging from \$1,000 per week in 1905 to \$3,000 per week during 1906 and 1907, which practice on the part of A. C. Frost & Co. naturally resulted in a padding of the earnings to the extent named.

The total of these fictitious passenger earnings for the year ended December 31, 1905, through this account of A. C. Frost & Co., amounted to \$160,095.04; for the year ended December 31, 1906, the padding of the passenger earnings through this operation amounted to \$171,619.80; for the year 1907, up to and including November 30, 1907, they amounted to \$158,789, against which there are sundry credits amounting to \$1,058.35, leaving the net amount for that year \$157,730.65.

I submit that without entering into other matters, A. C. Frost, who is responsible for the negotiation of the securities based upon such fraudulent statements, is not a proper man to act as receiver of this road and as representative of the creditors whom he has thus defrauded.

I will also state that Mr. Frost is the president of and in control of the Chicago & Milwaukee Electric Railroad Company, and he is also the president of and in control of those corporations which have made certain contracts with said railroad, particularly the Republic Construction Company, to the profit of A. C. Frost & Co.

The report of the accountant shows that while on January 1, 1899, the capital account of A. C. Frost & Co. disclosed a credit balance of \$108,812.16, through its transactions between the Chicago & Milwaukee Electric Railroad and the Republic Construction Company, A. C. Frost & Co. had increased this account on December 31, 1900, to the amount of \$4,081,761.73.

I again submit that under these circumstances A. C. Frost is not a proper person to represent the creditors and bondholders, whom, in my judgment, he has defrauded.

It was my earnest hope to secure a peaceable adjustment of the difficulties of this road, and my investigation into its affairs was prompted by a feeling that an injustice in the first instance had been done Mr. Frost, which I hoped to right.

My investigation having disclosed to me Mr. Frost's unworthiness, I owe the same duty to the bondholders, and to the creditors, to protest against the continued control of this property by Mr. Frost, directly or indirectly, that it seemed to me that I owed to Mr. Frost in the first instance to protest against the manner in which I had been appointed receiver.

In this connection it is well for me to state that the action of Judge Tuthill has been justified, in my opinion. I owe it to your court to advise you of these facts, which I believe to be true.

The action of Judge Tuthill, in appointing receivers on December 31 last on an ex parte hearing, was severely criticized at the time.

#### Basis of Proceedings.

The appointment of receivers by Judge Grosscup was based upon several claims. Otto R. Hansen of Milwaukee secured judgment against the Chicago & Milwaukee Electric Railroad of Illinois on a note for \$10,000, and the Sovereign Bank of Canada filed a bill against the Chicago & Milwaukee Electric Railroad of Wisconsin on a note for \$16,000, alleging insolvency. Chicago banks also participated in the proceed-

ings. The receivership for A. C. Frost & Co. was based on a bill filed on behalf of George A. Ball of Muncie, Ind., and others, who held a note for \$50,000. This bill stated that A. C. Frost & Co. were solvent, but that they had been engaged in constructing and financing railroad enterprises, that the recent financial stringency had made it impossible to market securities advantageously and that to conserve the financial interests it was necessary that a receivership be appointed. On January 27 Mr. Frost made public a statement, in which he said:

The direct cause of the receivership is the fact that the credit of the company and the market for its securities were injured by the receivership instituted on New Year's eve, and as a result it became impossible to consummate the sales of bonds, which had been substantially completed. After conferences between the principal holders of the company's obligations it was decided that a receivership would be the best means of conserving the property and the interests of the bondholders, creditors and stockholders. There are only about eight miles of the road to be completed, and more than 50 per cent of this work has been done. The total cost to complete the road will not exceed \$250,000.

Jacob Newman, who represents the holders of \$1,000,000 of bonds of the road, made the following statement: "The receivership inaugurated New Year's eve necessarily destroyed the credit of the road. The bond sales, which would have been completed in four or five days, were stopped. The road has to be completed. The money cannot be obtained in the ordinary way. The \$250,000 must be raised by the sale of receiver's certificates."

#### Statements of Judge Grosscup.

On January 29 Judge Grosscup issued a statement saying that he told Mr. Dawes he regretted that the statement of charges had been given to the press, and adding: "Mr. Frost, who built up this property—has put his life into it—has not been heard, and certainly nothing will be taken as established against him until he had been heard. I will give to the objections against Mr. Frost an early consideration with my mind unaffected until everything is fully weighed and considered."

In the statement issued on January 30 Judge Grosscup announced that Mr. Frost had asked to be relieved. "I think that in taking this step," Judge Grosscup said, "he is doing the right thing, in view of all the controversies that seem to exist within the properties, of which I was not aware at the time of the appointment. I still believe, however, that his personal help is essential to the working out of the interests involved."

The Allis-Chalmers Company recently completed what is regarded as the most powerful stationary engine ever built. This engine has a capacity of 25,000 horsepower and is designed to operate condensing at 175 pounds steam pressure and a speed of 200 revolutions per minute. It is a horizontal, twin-tandem rolling mill engine, with cylinders 42 by 70 inches, with 54-inch stroke. The engine as a whole, without foundation plates or flywheel, weighs 550 tons.

About 50 conductors employed on the lines of the Nashville Railway & Light Company's street railway system at Nashville, Tenn., were arrested on January 28 on the charge of violating a section of the city laws requiring that the names of intersecting streets be called out by the conductors. No fines were assessed in this instance, but warning was given by the court that a second violation would result in a fine in each case.

It is announced that the Schenectady (N. Y.) Railway will adopt the practice of designating the number of its conductors and motormen by awarding a gold stripe, to be worn on the sleeve of the uniform, for each year's service. When the wearer is entitled to five stripes he will be awarded a gold star in place of the stripes.

# News of the Week

## Transit Affairs in New York.

On January 22 the New York public service commission of the first district held a public hearing on the proposed Broadway-Lexington avenue subway route, the plans for which were approved by the commission on December 31. Residents of Manhattan and the Bronx spoke in favor of the route. The commission also ordered a public hearing for February 18 on the section of the Brooklyn Fourth avenue subway route under Ashland place from Fulton street to Fourth avenue.

At a meeting of the commission on January 28 the subcommittee on safety devices was instructed to consider the advisability of ordering the use of a magnetic brake on elevated trains operated over the Brooklyn bridge. The chief engineer was requested to investigate the desirability of having side doors on the cars.

The electrical inspector of the public service commission, who has for more than six weeks past been examining the rolling stock of the Union Railway of the Bronx, has reported to the commission recommending that the company be ordered to overhaul all of its cars and to rebuild some of them.

Judge Rosalsky of the general sessions court, New York City, on January 27 gave a decision in the proceedings instituted to punish Paul D. Cravath for contempt of court in declining to tell the November grand jury what Thomas F. Ryan said to him in connection with the sale of the franchise of the Wall & Cortlandt Street Ferries Railroad to the Metropolitan Securities Company in 1902. Mr. Cravath based his refusal upon the fact that he was Mr. Ryan's counsel and Judge Rosalsky upholds him in this contention. In his decision Judge Rosalsky delivered a severe arraignment of District Attorney Jerome, declaring that he so conducted the examination of Thomas F. Ryan before the grand jury as probably to invalidate any indictments which that body might have found against Mr. Ryan. Hence the court discharged the November grand jury, which had been held over on account of the Cravath incident, and directed Mr. Jerome to submit the matter anew and in a legal way.

## Chicago Union Traction Reorganization Perfected.

The property of the Chicago Union Traction Company was formally sold to the Chicago Railways Company on January 25. The property of the company and its subsidiary roads was bought by the Chicago Railways Company on a general bid for \$2,000,000. On the various items when bid for separately the total bids were \$2,090,000. Judge P. S. Grosscup of the United States circuit court will decide which amount the company must pay. The purchasing committee consisted of L. C. Krauthoff, George Wickersham and John C. Hatley. The bids for the separate properties were as follows:

West Chicago Street Railroad.....	\$ 500,000
North Chicago Street Railroad.....	300,000
Chicago Union Traction Company.....	150,000
Chicago West Division Railway.....	500,000
Chicago Passenger Railway.....	100,000
Chicago West Division Tunnel Company.....	200,000
North Chicago City Railway.....	300,000
For various law claims.....	15,000
For all property which may have been overlooked, or which may be claimed.....	25,000
<b>Totals .....</b>	<b>\$2,090,000</b>

A lease of the properties of the Chicago Union Traction Company to the Chicago Railways Company was executed on January 29 and Judge Grosscup directed the entering of an order approving the lease. The lease was signed by Henry A. Blair and Marshall E. Sampsel as receivers for the Chicago Union Traction Company and runs to John M. Roach as attorney in fact for the Chicago Railways Company. It provides for possession of the lines from December 26, 1907, to February 2, 1927, at a gross rental of \$1,000.

Attorneys for the Chicago Railways Company later filed with the city clerk of Chicago a formal acceptance of the ordinance and a bond of \$100,000 to assure the observance of the conditions.

John M. Roach, president of the Chicago Union Traction Company, was elected a director and the president of the Chicago Railways Company. Henry A. Blair was elected a director of the latter company.

The Chicago Railways Company has executed a trust deed to the Merchants' Loan & Trust Company of Chicago, as trustee. The mortgage is for \$37,500,000, and covers all the properties of the Chicago Union Traction Company and its underlying roads and whatever rights have been obtained by

the Chicago Railways Company under the new ordinance.

The talk of consolidation of the properties of the Chicago Railways Company and the Chicago City Railway has been revived.

## Legislation Affecting Electric Railways.

**District of Columbia.**—Representative Hephurn has offered an amendment to the bill for temporary street railway tracks connecting with the new union station which provides that the district commissioners shall have authority to regulate the number, kind and schedules of street cars operated in the district. The bill was held over until the next district day.

**Massachusetts.**—Recent bills introduced into the legislature include the following: A bill to authorize the Pittsfield Street Railway to acquire by purchase the franchises and property of the Bennington & North Adams Street Railway, thus giving the New York New Haven & Hartford system of electric railways an extension into Vermont; a bill to prohibit the throwing of any lighted match, cigar or cigarette in any railroad car, except smoking cars, in any railroad station or waiting room or sidewalk or platform connected therewith, except in receptacles provided for the purpose; a bill to give personal injury or death claims against an insolvent railroad or street railway preference over all other claims except bonded indebtedness; a bill to require 3-cent fares in Holyoke between 6:30 and 7:30 a. m., 11:30 a. m. and 1 p. m., and 5 to 6 p. m., with a penalty of from \$20 to \$1,000 for each violation; a bill to amend the street railway location law of 1906 so as to place the revisory powers with reference to a location more completely in the hands of the railroad commission instead of the local boards of aldermen or selectmen.—A bill giving the Boston Elevated Railway the right to purchase the West End Street Railway and to increase its capital stock by an amount equal to the par value of the West End stock has been introduced into the legislature.

**New Jersey.**—A bill has been introduced in the house to create in place of the present state railroad commission a public service commission, with powers similar to those of the public service commissions of New York.

**Ohio.**—A bill has been introduced by Senator Howe of Cleveland to enable cities to establish terminal stations for steam and interurban railways. Authority is granted to such cities to lease the terminal facilities to any railroad and to issue bonds on railway terminal certificates. The bill is intended to apply principally to Cleveland, Cincinnati, Columbus and Toledo. It is provided that before cities may purchase land for stations or start the work of construction they must enter into a contract with the railways entering the city for a period of not longer than 40 years, by which the railroads agree to pay to the city an annual rental sufficient to pay the interest on the cost of the terminal station.—A bill introduced in the house by Representative Stockwell provides that consents of property owners to the operation of a street railway shall not be necessary in the case of a renewal of a franchise, whether to a new or to an old company.

## Progress of the Cleveland Settlement Negotiations.

Mayor Tom L. Johnson, representing the city of Cleveland, and F. H. Goff, representing the Cleveland Electric Railway, are still holding meetings twice a day in the effort to decide on the value of the Cleveland Electric Railway property. The principal points discussed within the past week have been the amount of overhead charges and the value of unexpired franchises. At the meeting on January 23, in discussing the amount to be allowed for overhead charges, the mayor finally consented to increase his figures, allowing \$973,550, a little over half of Mr. Goff's estimate. The mayor agreed to allow \$24,000 for accident insurance, \$18,000 for rail inspection, \$12,000 for accident claims and \$100,000 for incidental delays. These are items to which he has previously objected.

On the following day, in discussing the value of outlying franchises after the inside grants had expired, it was decided to ascertain the proportion of the traffic originating on the outlying lines by employing policemen to check the passengers, in order to determine a proper division of the earnings. The mayor also agreed that in estimating the earnings on such lines the possibility of an operating agreement with another company owning the inside lines should be taken into consideration. On Tuesday of this week it was decided that beginning on Thursday of this week 60 policemen should be employed to check the number of passengers boarding the cars outside of the city. The policemen were to be stationed 1,500 feet beyond the city line, and if necessary the cars were to be stopped to facilitate the count.

At the meeting on January 24 Mr. Goff suggested that in case a settlement as to the value of the franchises is not reached by February 10 the Cleveland Electric's franchises in Woodland avenue and the west side should be extended for a month. The mayor took the matter under consideration and on the following day agreed to have an ordinance introduced

on Monday extending the franchises for 60 days, provided the Cleveland Electric would permit the Forest City Railway to use jointly several short sections of track for which it has yet no grants. At the meeting on Monday Mr. Goff announced that the company would not agree to the plan.

At the Monday meeting the question of the terms by which the stock of the Cleveland Electric Railway and the Forest City Railway is to be taken over by the holding company was discussed in a tentative manner, but it was decided to wait until the valuation was settled. At this meeting Mr. Goff proposed to cut six months from the life of the Euclid Heights franchise if the mayor would make certain concessions, such as accepting Mr. Goff's views as to cost of paving and as to charging 62½ per cent of gross earnings to operating expenses instead of 65. The mayor would not accept the compromise.

On January 22 Judge Estep gave a decision that the Forest City Railway has a right to use jointly with the Cleveland Electric Railway the latter's tracks on West Twenty-fifth street, from Bridge avenue to Lorain avenue, and on Lorain avenue, from West Twenty-fifth street to West Seventy-third street. This completes a belt line around the west side and gives the low-fare company 33 miles of track in all over which its cars may now be operated. However, the decision states that the company has no right to use the poles and wires of the Cleveland Electric Railway, as provided by the city council. The decision was handed down in injunction proceedings instituted by the Cleveland Electric Railway.

On January 23 Judge Addams held that the Forest City Railway has the right to joint use of a 1,200-foot stretch of the Cleveland Electric tracks on West Sixty-fifth street, which has been contested by the latter company.

At the suggestion of Mr. Goff it was decided that the two companies should arrange for the amount of compensation to be paid for joint use of the overhead equipment in order to avoid useless duplication. A. B. du Pont, president of the Municipal Traction Company, announced that the new lines would be put in operation about February 1.

**Indicted for Car Ticket Fraud.**—Charles F. Tabler, Andrew Leo Lucas and H. R. Wimsatt were indicted by the grand jury at Washington, D. C., on January 24 for conspiracy in connection with the scheme to defraud the Washington Railway & Electric Company and the Hamilton Bank Note Company by the sale of stolen car tickets, as described in last week's issue of the Electric Railway Review.

**Western Society of Engineers.**—The next regular meeting of the Western Society of Engineers will be held in the society rooms, Monadnock block, Chicago, on Wednesday, February 5. H. B. McFarland will present a report on "A Test of a Small Section Gas Producer Plant." At a meeting of the electrical section, on February 14, James N. Hatch will present a paper on "The Evolution of the Electric Railway."

**Pittsburg Railways Company Must Pay Bridge Toll.**—Judge J. W. Over of the common pleas court at Pittsburg has decided that the Pittsburg Railways Company owes the city \$80,000 in back tolls for running its cars over the Point bridge across the Monongahela river and that the company must hereafter pay the city quarterly a toll of 5 cents for each trip of a car across the bridge. The back tolls represent the period from November 12, 1897, to November 12, 1907.

**American Society of Mechanical Engineers.**—The first meeting of the gas power section of the American Society of Mechanical Engineers will be held on Tuesday evening, February 11, in the Engineering Societies building at 29 West Thirty-ninth street, New York. The subjects under discussion will be "Experimental Gas Turbines in France" (with lantern slides), "A Simple Continuous Gas Calorimeter" and "A Gas Engine and Producer Guarantee." Other subjects relating to the question of gas power will also be discussed.

**Cornell University Section A. I. E. E.**—Before and after the Christmas vacation two special meetings were held. At the first Prof. W. D. Bancroft, head of the department of physical chemistry, Cornell University, delivered an illustrated talk on "The Electro-Metallurgy of Steel." At the second meeting local members abstracted the papers on "The Mechanical Engineering of Power Stations," delivered in New York in December. At the next meeting Charles F. Scott, consulting engineer of the Westinghouse Electric & Manufacturing Company, will be the speaker.

**Public Utilities Commission for Kansas City Proposed.**—The upper house of the Kansas City city council on January 27 passed unanimously an ordinance providing for the creation of a public utilities commission. The commission is to consist of three members at a salary of \$600 a year, to be appointed by the mayor and to serve for three years, and two aldermen, one to be chosen from each house of the council, who will receive no salary and who will hold office for the

length of their aldermanic term. The commission is to investigate and report to the council such matters as rates, service and franchises of public utility companies.

**Motorman Held Guilty for New York Elevated Accident.**—Paul Kelly, the motorman in charge of a Ninth avenue elevated train of the Interborough Rapid Transit Company, New York, that ran off the elevated structure into the street on September 11, 1905, killing 12 persons, was convicted of manslaughter in the second degree on January 24 in the general sessions court. In returning its verdict the jury recommended the prisoner to the extreme mercy of the court. The towerman in charge of the signals at the time of the accident has already been convicted. He testified that the motorman ran past the signals which were set against him, while the motorman claimed he had a clear signal.

**University of Illinois.**—The University of Illinois announces that the formal installation of Dr. William F. M. Goss as dean of the college of engineering will occur on Wednesday, February 5, on the occasion of the formal opening of the graduate school on February 4 and 5. At a meeting to be held at 10 o'clock on the morning of February 5, addresses will be made by the president of the university and by representatives of the trustees, the alumni and the faculty, which will be followed by the installation address of Dr. Goss. After inspection of the buildings and equipment of the college of engineering short addresses by visiting engineers will be made at a meeting to be held in the physics lecture room.

**San Francisco Strikers Ask Reinstatement.**—It is reported that about 500 of the union carmen who have been on a strike against the United Railroads of San Francisco since last May have recently applied to the company for employment. The strike has never been officially declared at an end, but the executive heads of the union have given the men permission to apply for their former positions. At the offices of the company it was stated that about 500 of the strikers have already been reinstated and that of the 500 now on the waiting list those who had not made themselves conspicuous during the strike would be given positions on the same terms as new men as soon as there were vacancies to be filled or new men were required.

**Des Moines Interurban Railway to Reduce Expenses.**—President H. H. Polk of the Interurban Railway, Des Moines, Ia., has announced that the company will be compelled to make heavy retrenchments in all departments in consequence of the heavy slump in business during the past two or three months, although it is hoped that the period of retrenchment will be of only a few weeks' duration. In the office and station forces 10 men will be laid off and 20 track employees, several freight house men and several shop employees will be dismissed. A reduced schedule for the train service will be prepared: "We have delayed the retrenchments as long as possible and have been constantly hoping, but in vain, that business would pick up so that they would not be necessary," said Mr. Polk. "Our gross passenger receipts since November 1 are about 25 per cent lower than they were a year ago and other revenues show a similar decrease. I am confident that business will pick up before long, but we simply have to cut down expenses until it does."

**Des Moines Carmen Ask Increase of Wages.**—The scale committee of the union motormen and conductors employed by the Des Moines City Railway on January 25 presented a demand for an increased scale of wages, effective on February 12, providing for an increase of from 35 to 45 per cent. The company's officials refused the demands, saying that under existing business conditions it would be impossible to accede. Further negotiations will follow. The men are working under a 5-year contract, signed in October, 1906, which provides for an adjustment of the scale on February 12 for the ensuing year. In case of a disagreement the contract provides for arbitration by a committee of three men, one selected by the company, one by the men and the third by the mayor of Des Moines. President George B. Hippee of the Des Moines City Railway has given out the following statement: "A committee of the car operatives, motormen and conductors employed by the Des Moines City Railway today presented a new scale asking the company to approve it. The scale calls for service pay of 23, 25 and 28 cents per hour for the three grades of employees. This is an increase over the scale adopted in October, 1906, and expiring February 12, of from 45 per cent for the lower grade men to 35 per cent for the upper grade, with an average of 40 per cent for all coming under the scale. The advance asked for is the more noticeable when it is considered that in the train department a large proportion of the men, both on the regular and extra list, get in good hours every day in the year on which they desire to work, and that most of them average six and seven days out of each week."

# Traffic and Transportation

## Uniform System of Printing, Publishing and Filing Tariffs in Indiana.

In compliance with a request from the Indiana railroad commission the committee of officials of interurban electric railways appointed on October 2 for the purpose of formulating a uniform system of printing, publishing and filing tariffs in accordance with the Indiana law has made its report. These rules are now being followed. An abstract of the report of the committee follows:

"1. Passenger tariffs may be divided into three classes: (a) Joint tariffs, applying between points on the lines of two or more carriers. (b) Local tariffs, applying only to traffic between points on the lines of the issuing carrier. (c) Inter-division tariffs, applying only to traffic between points on different divisions of the lines of the issuing carrier.

"2. All tariffs must be printed on durable paper of good quality from type of a size not less than 6-point full face, and stereotype, planograph or other printing press process may be used. Hectograph, mimeograph, typewritten sheets or other similar process may be used in the preparation of tariffs covering excursion fares for not exceeding 10 consecutive selling dates or for excursions limited to 30 days or less.

"3. All tariffs must be filed in covers 8 by 11 inches. Local and interdivision tariffs may be in book form, but not larger than the above figures, or loose-leaf plan may be used, the size to remain the same.

"4. It may be desirable that certain fares appearing in local tariffs be repeated in interdivision or joint tariffs, but in all cases the fares so repeated must be the same in every tariff in which they appear.

"5. Interdivision tariffs shall show: (a) Fares between each point on one division and each point on the other division or divisions to which the tariff applies. (b) Fares between each station and every other station on the division or divisions to which the tariff applies and must include explicit rules and bases from which to determine fares to and from points not named in the tariff.

"6. The title page of every tariff shall show: (a) Name of the issuing carrier, carriers or agent. (b) Indiana railroad commission number of tariff in bold type immediately below the upper border line in the center of the sheet, and immediately under this (if there is sufficient room) the number or numbers of tariffs and supplements canceled thereby. If, however, the number of canceled tariffs is too large, same may be shown on the following page, but specific reference to such list must be carried on the title page in connection with the number of the tariff. All passenger tariffs must be numbered in serial numbers. For convenience in filing the passenger department number may be placed in the upper left-hand corner immediately under the border line, and if tariff is both intrastate and interstate the interstate commerce commission filing number should be shown in the upper right-hand corner, immediately under the border line. (c) Whether tariff is local, interdivision or joint. (d) The territory which the tariff is proposed to cover briefly stated. (e) Date of issue and date effective. (f) Name, title and address of officer by whom tariff is issued. (g) On the upper left-hand corner the words, 'Only one supplement to this tariff may be in effect at any time.' (h) If tariff is issued by special permission such permission must be shown on the title page.

"7. Tariffs shall contain, in the order named: (a) Table of contents full and complete. (b) Names of participating carriers, together with their concurrence numbers. (If there are no more than 10 participating carriers, and it is so desired, this may be shown on the title page.) (c) Alphabetical list of stations must be shown, together with page numbers on which such stations may be found, and a mileage table from some given point, together with all rules and regulations applicable to the tariff.

"8. In order that the members may understand what will be acceptable to the Indiana railroad commission we submit tariffs as follows: Local and interdivision tariff of the Terre Haute Indianapolis & Eastern Traction Company; joint passenger tariff of the Indiana Union Traction Company, showing rates of fare from certain junction points to certain stations in Indiana and Ohio via various gateways (this tariff is to be reissued and on such reissue will carry notations named in the foregoing report); interdivision excursion tariff, naming rate in connection with a steam road, but only naming such rate intrastate; excursion tariff, naming rate interdivision from all points on a certain line in connection with a steam line to a point outside of the state (this being wholly interstate, it would not be filed with the Indiana railroad commission); the manner of issuing a supplement to an Indiana railroad commission or an interstate commerce commission tariff;

interline excursion tariff from points on one line to a point on another line. In connection with this tariff we show the manner of filing all tariffs with the Indiana railroad commission.

"Tariffs may be printed either in squares or by head line points at the option of the road."

The committee was composed of the following: Chairman, F. D. Norviel, Indiana Union Traction Company; S. D. McLeish, Indianapolis Crawfordsville & Western Traction Company; J. W. Foutz, Terre Haute Indianapolis & Eastern Traction Company; A. G. Kelly, Ft. Wayne & Springfield Railway; George S. Henry, Indianapolis & Cincinnati Traction Company.

## Four-Cent Fares an Injustice.

The Louisville (Ky.) Herald of January 22 publishes the following interview with S. H. Kendall, chairman of the railroad committee of the board of councilmen, in relation to the 4-cent fare ordinance which has been introduced in the board:

"None of us is in favor of the ordinance proposing to reduce arbitrarily the fares of the Louisville Railway Company to four cents. The company has suffered a great deal, and its conduct toward the administration in granting additional transfers, as well as its trials during two strikes recently, has led us to believe that it would be a great injustice to endeavor to pass this ordinance, and thus put an additional burden upon the corporation."

## Boston & Worcester Street Railway to Maintain Schedule.

E. P. Shaw, Jr., general superintendent Boston & Worcester Street Railway Company, in answer to a question as to whether that road will try to reduce operating expenses by reducing the service, said to a representative of the Worcester (Mass.) Telegram:

"At the present time many of the street railway companies and some of the steam roads are curtailing expenses by changing their timetables to cut out trips. The Boston & Worcester Street Railway has passed through three of the best winter months, for receipts and service, since it started, and is very well satisfied with the present schedule.

"We have had many inquiries as to whether we were to make any changes in our present schedule, so I would be glad to have you quote me as saying that we will not make any changes to reduce our schedule this winter. We will continue to run every half hour as in the past, and at times when the riding demands it, we are ready to give additional service. We find that we are better able to maintain our scheduled service on account of the addition of the double track put in last summer.

"It appears that the reduction in service on the steam and trolley roads has helped us considerably, as our business has steadily increased."

## Difficult Competition for an Electric Road.

The following condition of competition exists between Grand Rapids, Mich., and Muskegon, Mich., where the Grand Rapids Grand Haven & Muskegon Railway, a third-rail electric road, is in direct competition with the Grand Rapids & Indiana Railway, a steam road.

Previous to the building of the Grand Rapids Grand Haven & Muskegon Railway the Grand Rapids & Indiana road charged three cents per mile, or \$1.19, between the cities named. When the electric road was completed it made the rate 60 cents. The Grand Rapids & Indiana road cut the rate to 50 cents, and this rate has been in effect up to very recently. On Sundays a round-trip rate of 50 cents was made by the Grand Rapids & Indiana road. The electric line did not meet this rate, but maintained the 60-cent rate. According to the new 2-cents-per-mile law the Grand Rapids & Indiana road is entitled to 79 cents for the trip. Recently it has placed two kinds of tickets on sale between these cities. A passenger who has baggage to check has to pay 79 cents, but if the passenger has no baggage the 50-cent rate is used. The Grand Rapids Grand Haven & Muskegon Railway has cars running on a schedule of an hour and a half, while the Grand Rapids & Indiana road has two trains each way a day. The electric cars are not equipped for handling baggage, but the company has express cars leaving in the morning and at noon on which baggage is checked, with a charge of 25 cents for each piece.

## Reduced Fares to Pupils of Schools Approved in New York.

The New York public service commission, second district, through Commissioner Decker, has rendered an opinion concerning the sale of low-price commutation tickets for pupils in schools. It is held that this practice "is a long-existing and desirable custom or usage sanctioned by public policy and the public service commissions' law." The opinion states:

"Generally speaking, a special rate transportation ticket, confined to a particular class of persons, involves discrimination, and, as a rule, discrimination of that character is for-

bidden by law. A practice, however, of accepting half fare for children is sanctioned by custom and usage dating back to the beginning of railroad operation. The absolute justice as well as necessity for such variation in rate need not be argued. Arising in like good public policy is the similar custom or usage of fixing and charging special low rates for children riding daily for the purpose of attending desirable schools. Ordinarily these special rates for school children are afforded by the sale of low-price commutation tickets issued in forms deemed appropriate by the carriers. The universal and continuous recognition by carriers and the public that the transportation of children for school, or, indeed, for any purposes, is invariably under conditions dissimilar to those arising in the carriage of adult persons is clearly justified in fact and in law.

"The general practice of carriers is to make half rates for all children under 12 years of age when traveling for any purpose, and the school commutation ticket is as a rule limited to those children attending public schools, or private schools having similar grades. Confined within these reasonable limits, and thus avoiding discrimination in affording rates and transportation facilities as between adult persons, it is impossible to perceive how the practice of allowing special rates for the transportation of children to and from school can produce wrongful discrimination or violate in any sense the equality clauses of the law."

**Transfers in Pittsburg.**—After a conference of the joint committee of councils on universal transfers with J. D. Callery, president of the Pittsburg Railways Company, it was announced by the chairman of the committee, Joseph P. Hilldorfer, that the company would extend its transfer system.

**Lower Rates Sought in Minnesota.**—Formal complaint has been made to A. J. Smith, county attorney of Hennepin county, concerning rates of the Minneapolis & St. Paul Suburban Railway, which is controlled by the Twin City Rapid Transit Company. Residents of communities reached by the Minneapolis & St. Paul Railway desire to have it place in force 2-cents-per-mile fares.

**Better Service Desired in Hartford, Conn.**—A. B. Smith, general traffic manager of the Connecticut Company, New Haven, Conn., and W. P. Bristol, local manager at Hartford, Conn., met Mayor Henney of Hartford and members of the railroad committee of the common council on January 25 in relation to the service. Some complaint has been made regarding a reduction in the number of cars. Mr. Smith said that it is the desire of the company to give the best service it can under the existing business conditions.

**Service Reduced by Philadelphia Rapid Transit Company.**—On account of reduced traffic the Philadelphia Rapid Transit Company has withdrawn from operation 100 cars. New schedules will be promulgated soon, which will reduce the service still further. John B. Parsons, president of the company, is quoted as saying that while no employes have been dismissed, a large number would be put upon "chance work" and the hours of all will be shortened. The men will not work more than six days a week under the new arrangement.

**Fares Restored by Pennsylvania Railroad.**—As the supreme court of the state of Pennsylvania has decided that the act of the last legislature fixing a maximum passenger fare of two cents a mile is inapplicable to the Pennsylvania Railroad, its branches and leased lines, the company will restore on February 1 the schedule of fares which had prevailed from November 1, 1906, when the company voluntarily reduced its maximum 1-way rate to 2½ cents a mile, until October 1, 1907. On the latter date, when the 2-cent fare act became effective, all 1-way rates were reduced to conform to the law.

**Hearing at Omaha, Neb.**—Frank Lyon, special examiner for the interstate commerce commission, held hearings at Omaha on January 20 and 21 on the complaint of the West End Improvement Club of Council Bluffs, which desires to have the commission order a reduction in the rate of fare between Omaha and Council Bluffs. In his testimony R. A. Leussler, secretary and assistant general manager of the Omaha & Council Bluffs Street Railway, referred to the increase in the cost of labor and materials and said that the character of the service had been improved materially.

**Ordinances Affecting Service in Toledo, O.**—An ordinance was passed by the city council of Toledo on January 20 requiring the Toledo Railways & Light Company to establish 15-minute service on the Huron and South line from its terminus in North Toledo to the Toledo state hospital. An ordinance was also introduced providing that the company should operate owl cars at intervals of not less than one hour between midnight and 5:30 a. m., the rate of fare to be fixed by a committee of the council. The latter ordinance was referred to a committee.

# Construction News

## FRANCHISES.

**Christiana, Pa.**—The borough council of Christiana has granted a franchise to the Conestoga Traction Company of Lancaster, Pa., for the construction of its proposed 5-mile extension from Christiana to Arglen and on to Parkesburg. With the completion of this extension through connection from Lancaster to Parkesburg, 22 miles, will be afforded.

**Gresham, Ore.**—The Mt. Hood Railway & Power Company and the Portland Railway Light & Power Company are seeking 25-year franchises from the Gresham city council. The Portland Railway Light & Power Company is also asking for electric light and power privileges in Gresham.

**Kansas City, Mo.**—An ordinance authorizing the Kansas City Railway & Light Company to extend its Twenty-seventh street line from Cleveland to Jackson street was adopted by the lower house of the council on January 27.

**Lincoln, Ill.**—The Peoria Lincoln & Springfield Traction Company, which recently began operation between Lincoln and Mackinaw, Ill., has applied to the railroad and warehouse commission for the right to construct grade crossings in Lincoln with the Chicago & Alton and Illinois Central railroads. Practically all of the line has been completed with the exception of these crossings. The new line is a branch of the Illinois Traction System.

**Pittsburg, Pa.**—It is stated that three new ordinances granting franchises for a subway system in Pittsburg will be introduced in the city councils within a short time. Two will be presented by the Pittsburg Subway Company, which has been applying for a franchise for several months, but whose application was still an unsettled question at the time of the consolidation of the legislative branches of Pittsburg and Allegheny. The other will be introduced by the rapid transit committee of councils. It is planned to invite bids for the franchise and to dispose of it to a corporation which shall demonstrate its financial ability to build the subway and which shall offer the best terms to the city. There is expected to be strenuous competition between the subway interests and interests which have been seeking a charter for an elevated system.

**Summerville, S. C.**—A 39-year franchise has been granted to the Charleston & Summerville Electric Railway Company for the operation of its cars through the principal streets of Summerville, S. C. The company proposes to build a 27-mile interurban line between Charleston and Summerville and considerable grading has been done. Julius G. Hocke, 15 Whitehall street, New York City, president; George Tupper, Summerville, secretary and treasurer; St. Julien Grimke, Charleston, general counsel.

## RECENT INCORPORATIONS.

**New Orleans & Seashore Air Line Railway, New Orleans, La.**—Incorporated in Louisiana to build an electric railway from Algiers, the fifth district of New Orleans, to Grand Isle, a resort on the gulf of Mexico. It is proposed to erect a large hotel and other resort features at Grand Isle and to develop large districts of swamp lands lying along the proposed route. Besides the main line, which will be 50 miles long, it is proposed to build a branch along Bayou Lafourche from Lockport to the gulf of Mexico, besides branches east and west from the terminal at Grand Isle. The construction work will be very extensive on account of the character of the territory to be traversed, which will require a large amount of trestle and fill, including a 12-mile pile trestle from Bayou St. Denis to Grand Isle. It is stated that offers have been made to underwrite sufficient bonds to build the line. Capital stock, \$1,000,000. Incorporators: James W. Porch, Arsene Parriliat, William F. Pinckard, John H. Menge, Honore Dugas, J. W. T. Stephens, R. McWilliams, W. S. Fill, L. H. Marrero, Jr., and others of New Orleans. J. W. T. Stephens, 303 Board of Trade building, is chief engineer.

**West Chester & Wilmington Electric Railway, West Chester, Pa.**—Incorporated in Pennsylvania to build an electric railway from West Chester, Pa., to the Delaware state line, where it will connect with the Delaware section of the road. The capital stock is \$54,000. Thomas E. O'Connell, West Chester, is president. (Noted December 28, 1907.)

**Western Illinois & Iowa Railway.**—Incorporated in Illinois to construct an interurban railway in Hancock county, Illinois. Capital stock, \$2,500,000. Incorporators: Paul A. Neuffer, Harry H. Phillips, James E. Hauronic, Charles J. Horn and Rollo M. Cole, all of Chicago.

## TRACK AND ROADWAY.

**Austin & Lockhart Interurban Railway, Austin, Tex.**—Announcement is made that the fifth survey for this proposed interurban line is being made and that in all probability the road will be built this year. The company was incorporated last July by eastern capitalists with a capital stock of \$400,000. (Noted July 27, 1907.)

**Central Railway, Clinton, Ia.**—Thomas J. Wilcox, president of this company, writes that the entire survey for the proposed electric line from Clinton to Dubuque, Ia., 87 miles, has been completed. The maximum grade is 1.5 per cent; maximum curvature, 4 degrees. The road will be standard gauge, laid with 70-pound rails, and will carry both passengers and freight. After the contracts have been closed, which will be some time during the coming summer, work will be started on the construction. B. Franklin of Franklin & Clark, Philadelphia, Pa., is chief engineer. (Noted December 28, 1907.)

**Chicago Lake Shore & South Bend Railway, South Bend, Ind.**—Rapid progress is being made on the line from South Bend, Ind., to Kensington, Ill. Beginning 1½ miles out of South Bend the track is laid and ballasted for 22 miles. Track is also laid for 8 miles east of Michigan City and for 12 miles west to the Lake Shore & Michigan Southern Railway crossing, near Dune Park. All of the grading is completed between Dune Park and South Bend, except for one mile. From Dune Park to East Chicago grading is completed, except for ¾ mile. All but seven miles of the track between Dune Park and Hammond has been laid. Seventy-pound T-rails and white oak ties are used. The 45-foot poles used were created by the Southern Creosoting Company of Louisiana. The electrical equipment is furnished by the Westinghouse Electric & Manufacturing Company and cars have been ordered from the Niles Car & Manufacturing Company. J. W. S. Reigle is chief engineer. (Noted January 18.)

**Chicago & Southern Traction Company, Harvey, Ill.**—Matthew Slush, president of this company, which recently opened its extension from Harvey to Kankakee, Ill., announces that the next move will be to extend the line from Kankakee to Lafayette, Ind., 55 miles.

**Columbus Delaware & Marion Railway, Columbus, O.**—It is now hoped to have the extension from Marion to Bucyrus, O., ready for operation by April 1. There are two short stretches of grading to be completed, aggregating less than a mile, and nine miles of track, about half the distance, have been laid. The line will be supplied with current from the company's power house at Stratford by a 20,000-volt transmission line leading to a substation at Marion. A second substation will be located at a point 11 miles from Marion. The current on the trolley will be 600-volt direct-current, as on the present main line. George Whysall of Marion is general manager. (Noted December 7, 1907.)

**Evansville & Southern Indiana Traction Company, Evansville, Ind.**—The work of grading the Patoka extension of this company's line was completed as far as Patoka on January 23. The whole line with the exception of the bridge across the Patoka river near Patoka is now ready for tracklaying. (Noted December 28, 1907.)

**Ft. Worth Weatherford & Mineral Wells Interurban Railway, Ft. Worth, Tex.**—It is stated that a formal offer for the construction of this proposed road will soon be made by the firm of Suderman & Dolson, Galveston, Tex. A representative of the firm already has made a tour of inspection of the route between these points and in the cities of Weatherford and Mineral Wells, and it is said that a bond sufficient to guarantee the building of the road will be given, provided the proposition is acted upon favorably by the three cities. C. S. Young is chief engineer. (Noted December 7, 1907.)

**Franklin & Towamensing Street Railway, Slatington, Pa.**—This company has recently opened an office at Slatington, Pa., and has engaged I. W. Cramp, Harrisburg, Pa., as engineer. He will at once begin the preliminary surveys and it is expected that a portion of the road will be completed and in operation by the end of the year. It will connect Slatington and Lehighton by way of Palmerton and Bowman's. Several Allentown, Pa., capitalists are interested. (Noted August 3, 1907.)

**Hamilton Radial Electric Railway, Hamilton, Ont.**—Permission from the Canadian government is being sought by this company for the construction of an electric line from Brantford to Windsor, Ont., or a point near that city. William C. Hawkins, general manager, Hamilton, Ont.

**Little Rock & Pine Bluff Traction Company, Little Rock, Ark.**—It is stated that the stockholders of this company have arranged for a reorganization of the company and will push

the work of construction between Little Rock and Pine Bluff. Contracts for the grading have been let and considerable progress on the work already has been made. (Noted December 21, 1907.)

**Los Angeles Pacific Railway, Los Angeles, Cal.**—This company has commenced work on an extension from Santa Monica avenue to Toluca, Cal. T. R. Gabel, general manager, Los Angeles.

**Macon Railway & Light Company, Macon, Ga.**—It is stated that this company is planning two extensions for the coming year—one from Bellevue to the Idle Hour stock farm and another to the Outing Club. W. J. Masseur, president, Macon, Ga.

**Massillon Wooster & Mansfield Traction Company, Cleveland, O.**—The contract for the construction of this electric line from Massillon west to Mansfield, O., has been awarded to the Northern Engineering & Construction Company, Cleveland, O. Four miles of grading has been completed between Smithville and Madisonburg. The road will be about 50 miles long and will serve the towns of Dalton, Orrville, Smithville, Madisonburg, Wooster, Reedsburg, Jeromeville and Hayesville. G. A. Bartholomew, chief engineer, 1423 Williamson building, Cleveland. (Noted August 24, 1907.)

**Ocean Shore Railway, San Francisco, Cal.**—This road has completed its line from Santa Cruz to the new town of Folger, a distance of 20 miles, and the work of extending the line is progressing steadily. Cars are in regular operation from San Francisco to the San Pedro valley. J. Downey Harvey, president and general manager, San Francisco. (Noted December 14, 1907.)

**Oklahoma & Golden City Railway.**—Announcement is made that the preliminaries have been arranged for the construction of this proposed electric railway from Pawhuska, Okla., to Jefferson City, Mo., and that active construction work will be started in the spring. The line will serve the intermediate towns of Joplin and Golden City and will have a branch to Springfield. W. S. Pope, Jefferson City, Mo., president; E. M. Dempsey, Pawhuska, Okla., vice-president; O. E. Wheelock, Kansas City, Mo., secretary.

**Ontario West Shore Electric Railway, Goderich, Ont.**—This company will apply at the next session of the Ontario legislature for an act empowering it to extend its proposed railway from Grand Bend, Stephen, through Osborne, southeasterly through Blanshard and Biddulph, thence southerly and westerly through West Nissouri or London township to London city; and to construct a branch line from Osborne or Blanshard in an easterly direction to St. Mary's, thence easterly through Downie to Stratford; to extend the time for payment of 15 per cent of the capital stock to May 14, 1909, and to extend the time for the completion of the railway to 1912; to approve the by-laws whereby the towns of Goderich, Kincardine, Ashfield, Huron and Colborne guarantee bonds to the extent of \$400,000, and agreements respecting the company's right to build and operate its railway on certain streets in those towns. M. G. Cameron, Goderich, is interested. (Noted January 4.)

**Pacific Electric Railway, Los Angeles, Cal.**—This company is installing a complete system of interlocking and derailling switches and semaphores at two of the railroad crossings on its Long Beach line at a cost of about \$40,000.

**Pasadena, Cal.**—Horace M. Dobbins of Pasadena is said to be at the head of a company which has been organized with a capital stock of \$5,000,000 for the construction of an electric railway between Pasadena and Los Angeles. As proposed it will be practically an air line, reducing the distance by the existing lines by nearly three miles. It is stated that the third-rail system will be adopted and that all grade crossings will be avoided. It is also planned to enter the business district of Los Angeles by a subway and to utilize the old "cycleway" right of way between the two cities. The cost for constructing the road is estimated at \$2,500,000.

**Pueblo & Arkansas Valley Electric Railway, Pueblo, Colo.**—It is announced that this company is now planning the extension of its interurban line from the proposed terminus at Rocky Ford west as far as Canyon City and south to Trinidad. This road will serve the entire Arkansas valley, including Pueblo, Otero and Fremont counties, and is backed by Kansas City capitalists, among whom are M. Donthitt, E. B. Chapez, M. J. Verner and Lester Wolf. M. G. Saunders, Pueblo, Colo., also is interested. (Noted December 21, 1907.)

**Putnam & Westchester Traction Company, Peekskill, N. Y.**—It is announced that Francis A. Stratton, president of the Peekskill Lighting & Railroad Company, Peekskill, N. Y., has purchased the Putnam & Westchester Traction line and



will operate it as a part of an interurban system which he proposes to build in that section of New York. An extension from Ossining to Pleasantville, White Plains and Mt. Vernon is said to be planned in this connection.

**Toledo Fostoria & Findlay Railway, Fostoria, O.**—The 16-mile extension from Pemberville to Toledo has been completed to the Toledo city limits, with the exception of two short stretches near railroad crossings. F. W. Adams, vice-president and general manager. (Noted October 19, 1907.)

**Twin City & Lake Superior Railway, Minneapolis, Minn.**—E. W. Farnham, president of this company, which is building a 129-mile third-rail electric line from Minneapolis to Duluth, Minn., writes that surveys have been completed for the entire distance. Since July 1, 1907, grading has been finished from the Belt Line in Minneapolis to Sunrise, Minn., on the St. Croix river, 38½ miles. Work on grading the remainder of the distance will be started early in the spring. The road will be double-track and will be laid with 70-pound A. S. C. E. section rails. Ninety-six per cent of the route will be on tangents; maximum curve, 2 per cent; maximum grade, 0.6 per cent. J. H. Thomas, Railway building, Minneapolis, is chief engineer. The officers are: E. W. Farnham, president; W. H. Crossland, vice-president; F. B. Kidder, treasurer. Headquarters, Railway building, Minneapolis, Minn.

**Warsaw, N. Y.**—The project for an electric railway from Warsaw to Rochester, N. Y., is being revived by the promoters who have applied for franchise privileges on Main street in Warsaw and for permission to cross county roads. A hearing has been set for February 15. It is said that construction will be started as soon as the bonds have been sold.

**Winona Interurban Railway, Winona Lake, Ind.**—This company has awarded a contract to the Central States Bridge Company of Indianapolis for the construction of a bridge over the Pennsylvania Company's line on the Peru division of the interurban west of Warsaw, Ind. The Pennsylvania Company will bear part of the expense.

#### POWER HOUSES AND SUBSTATIONS.

**Chicago & Joliet Electric Railway, Joliet, Ill.**—It is stated that this company intends to erect a new \$5,000,000 power station, to be located on the line about four miles from the Chicago terminal. The company has recently installed a 500-kilowatt motor-generator set, consisting of a three-phase 2,300-volt induction motor and an interpole generator at its Joliet substation and it is planned to increase the capacities of its Lemont and Summit substations by the addition of 500-kilowatt and 250-kilowatt machines. These installations were considered necessary by reason of the anticipated heavy travel to Dellwood Park near Joliet during the coming season. J. R. Blackhall, general manager, Joliet, Ill.

**East Shore & Suburban Railway, Richmond, Cal.**—This company recently purchased from the General Electric Company one 500-kilowatt motor generator complete with switchboards, and three 200-kilowatt transformers, 10,000 to 440 volts. W. S. Rhee, general manager, Oakland, Cal.

**Tacoma, Wash.**—It is reported that Stone & Webster of Boston, Mass., are preparing to build a large hydro-electric power plant at Lake Tapps, 10 miles from Tacoma, Wash., and for that purpose have acquired the Seattle-Tacoma Power Company, which owns the Snoqualmie Falls plant and also controls the water rights on Lake Tapps and the White river. According to the report the waters of the White river are to be diverted and carried by a canal to Lake Tapps. From the lake another canal will take the water to an 1,100-foot bluff, at the foot of which the plant is to be erected. The power is to be used for the Seattle and Tacoma lines and for the additional lines which Stone & Webster propose to build in that vicinity.

**Torrington & Winchester Street Railway, Burrville, Conn.**—We are officially advised that the note published in the Electric Railway Review of January 18, page 96, to the effect that this company proposed to abandon its present power house at Burrville and to build a new one at Torrington, Conn., is incorrect and that no such plans are contemplated.

**Utah Light & Railway Company, Salt Lake City, Utah.**—It is stated that this company will probably begin the construction early in the spring of its proposed 2,000-horsepower power plant at Devil's Gate on the Weber river, in Weber canyon, about 18 miles from Ogden, Utah. With the extension of the street railway lines in Salt Lake and in Ogden more power will be required and it is to meet this necessity that the new power plant will be erected. It will cost from \$200,000 to \$300,000 and when completed the company will have about 15,000 horsepower at its disposal.

## Personal Mention

Mr. William Dudley Dwyer, Superior, Wis., has been appointed attorney for the Twin City Rapid Transit Company at Minneapolis, effective at once.

Mr. P. C. Dolan, heretofore manager of the Pittsfield Electric Street Railway at Pittsfield, Mass., has been elected president of the company, succeeding the late Joseph Tucker.

Mr. George S. Rankin has been appointed general manager of the Yakima Valley Transportation Company, which has just completed and placed in operation a street railway line in North Yakima, Wash.

The position of supervisor of inspectors of the Brooklyn Rapid Transit Company has been abolished and Mr. J. M. Stoddard, who had held that position heretofore, has been transferred to other duties.

Mr. Charles W. Smith has resigned as treasurer of the subsidiary companies of the Boston & Suburban Electric Companies preliminary to starting on an extended trip abroad. He will continue, however, as trustee of the holding company. Mr. E. M. Richards will succeed him as treasurer of the subsidiary companies.

Mr. Arthur H. Mann has been appointed general master mechanic of the Michigan United Railways in charge of the Kalamazoo, Battle Creek and Albion shops of the company, with headquarters at Albion, Mich. Mr. Mann formerly was master mechanic of the Evansville & Southern Indiana Traction lines at Evansville, Ind.

Mr. Edwin W. Robertson of Columbia, S. C., has resigned as president and treasurer of the Anderson (S. C.) Traction Company and Mr. William Elliott, Jr., has resigned as manager. Both men have held office since April, 1907. Mr. Robert E. Ligon of Anderson has been elected acting president, treasurer and general manager.

Mr. Lisle Bennion has been appointed acting general manager of the Illinois Light & Traction Company at Streator, Ill., succeeding Mr. R. W. Harris, who recently resigned to become general manager of the Joplin & Pittsburg Railway at Pittsburg, Kan., as announced in a previous issue. Mr. Bennion formerly was assistant to Mr. Harris.

Effective on January 25 the elevated lines of the Brooklyn Rapid Transit Company will be operated in three divisions, which will be known as the southern, eastern and bridge divisions. In this connection the following appointments have been announced: Mr. F. L. McCotter to be assistant trainmaster, eastern division; Mr. J. V. Byrne, to be trainmaster, bridge division; Mr. T. F. Blowitt to be trainmaster, southern division; Mr. J. T. Lavolio to be assistant trainmaster, southern division; Mr. F. H. Hammond to be assistant trainmaster, bridge division; Mr. H. Ahorn to be general yardmaster, eastern division.

Mr. Thomas K. Glenn has resigned as vice-president, secretary and manager of railroads of the Georgia Railway & Electric Company, Atlanta, Ga., to become president of the Atlanta Steel Company. Mr. G. W. Brime, heretofore vice-president, treasurer and manager of the electrical department, has been appointed general manager. Mr. W. H. Glenn, superintendent of maintenance of way, has been appointed manager of railroads. Mr. C. A. Smith, assistant superintendent of maintenance of way, has been appointed superintendent of maintenance of way. Mr. Thomas K. Glenn has been connected with the Georgia Railway & Electric Company and its predecessors since 1891. He was born in Vernon, Miss., about 29 years ago and was educated in public and private schools in Marietta and Atlanta, Ga. He entered the service of the Atlanta Consolidated Street Railway in 1891 as stenographer. In a short time he was appointed claim agent and he was soon after advanced to the position of secretary and treasurer. In 1898 he was elected vice-president, which position he retained when the name of the company was changed to the Atlanta Railway & Power Company. In 1901 the company was absorbed by the Atlanta Rapid Transit Company and reorganized as the Georgia Railway & Electric Company. Mr. Glenn was made vice-president and secretary and was also placed in charge of the claim department. In March, 1903, he was appointed manager of the railway department to succeed Mr. D. A. Belden. Mr. W. H. Glenn became connected with the Atlanta street railway lines at the same time as his brother and has had a thorough experience in nearly every department of the business. A graduate of the Georgia School of Technology, he entered the service of the Atlanta Consolidated Street Railway as a rodman, at the time the horse cars were

being replaced by electricity. Later he was placed in charge of the motor repairing department and two years afterward he was appointed assistant superintendent and purchasing agent. In 1898 he was placed in charge of the construction department, which position he held until the organization of the Georgia Railway & Electric Company, when he was appointed superintendent of maintenance of way. Mr. C. A. Smith, who succeeds Mr. W. H. Glenn, has held his present position for about two years.

Mr. John Millard Roach, who was elected president of the Chicago Railways Company, the new company that has taken over the properties of the Chicago Union Traction Company, at a meeting of the directors on January 29, has been connected with the street railways of Chicago for over a quarter of a century. For the past seven years he has held the active management of the entire street railway system of North and West Chicago, aggregating about 500 miles of track. Mr. Roach was born at Lowell, O., on January 30, 1851, and received an academic education at Beverly and Athens, O. He has been connected with the street railways of Chicago since 1872, when he entered the service of the North Chicago Street Railroad as conductor. He was later appointed cashier and still later purchasing agent, as well as serving in various other positions during successive changes in the management. In 1887 he was appointed assistant superintendent; in 1890 superintendent; in 1893 second vice-president and general manager. In 1897 he was also appointed general manager of the West Chicago Street Railroad and consequently had jurisdiction over the entire Yerkes system of street railways. In 1897 he was also elected president of the Cicero & Proviso Street Railway and the Suburban Railroad. On July 1, 1899, when the Chicago Union Traction Company assumed control of the North Chicago and West Chicago lines, he was elected vice-president and general manager. On May 17, 1900, when the Chicago Consolidated Traction Company was purchased by the Chicago Union Traction Company, he was elected president and general manager, succeeding Charles T. Yerkes. On May 29, 1900, he was elected president of the Chicago Union Traction Company, in addition to his duties as general manager, succeeding Jesse Spalding. During the year 1900 he was president of the American Street Railway Association.



John Millard Roach.

#### Obituary.

George E. Hoppie, at one time president of the Atlanta, Ga., street railway company, died at his home in New York City on January 26, aged 51 years.

M. J. Blondell, formerly master car builder and later superintendent of the United Railways & Electric Company, Baltimore, Md., died recently after several months' illness.

#### Chilean Railway Electrification Proposed.

Consul Alfred A. Winslow of Valparaiso reports that the Chilean government has commissioned an American electrical engineer to study the feasibility of changing the first and second sections of the state railways for the use of electrical instead of steam power. The consul adds:

"The engineer has left for New York, where he goes after a careful study of the conditions here. It seems that the project might be very practicable, as there are several good streams crossed by the railway lines that have their sources in the regions of perpetual snow along the Cordilleras that must have ample fall for limitless power possibilities. The first section connects Valparaiso with Santiago and is about 100 miles long, and the second section extends from Santiago to Concepcion, and is about 350 miles in length. Double track is being laid on the first section. At present the coal bills for the state railways are heavy, since a large proportion of the coal used is imported at a high cost.

## Financial News

**American Light & Traction Company, New York.**—Gross earnings of this company in 1907 were \$2,463,158, as compared with \$2,263,735 in the previous year. Operating expenses were \$36,563, as compared with \$48,000. Net earnings were \$2,426,595, as compared with \$2,215,735. Dividends aggregating \$1,242,912 were paid last year against \$1,173,969 the previous year. From the balance remaining after the payment of dividends \$681,000 was set aside in 1907 as a reconstruction reserve, leaving a surplus of \$502,683; in 1906 \$680,500 was set aside in this way, leaving a surplus of \$361,266.

**Chicago City Railway.**—An extra dividend of 2½ per cent has been declared upon the capital stock, payable on February 10 to stockholders of record at the close of business on February 4. This dividend is paid from the percentages allowed under the ordinance for profit on construction.

**Interborough-Metropolitan Company, New York.**—At the annual meeting of shareholders on January 21 August Belmont, Jr., was elected a director to fill a vacancy in the board. The other directors were re-elected.

**Louisville (Ky.) Railway Company.**—Oscar Fenley, president of the National Bank of Kentucky, Louisville, has been elected a director of the Louisville Traction Company and the Louisville Railway Company to fill the vacancies left by the death of J. W. Gaubert.

**Meyersdale & Salisburg Street Railway.**—On application of R. W. Marshall & Co. of New York the South Side Trust Company of Pittsburg was appointed receiver for this company on January 22.

**Milwaukee Electric Railway & Light Company and Milwaukee Light Heat & Traction Company.**—At the annual meetings of shareholders the directors were re-elected.

**New York City Railway.**—Judge Lacombe of the United States circuit court of New York has granted authority to the receivers for the New York City Railway to sue the Metropolitan Securities Company and certain individuals who were directors of the latter company in 1902 for \$2,797,200. The suit is for the recovery of money which it is alleged was not paid under an agreement executed in February, 1902, providing for the payment of \$23,000,000. The former directors of the Metropolitan Securities Company who were named are: Thomas P. Fowler, Paul D. Cravath, Edward J. Berwind, George G. Haven, Herbert H. Vreeland, Edward W. Sayre, Mortimer L. Schiff, Thomas F. Ryan, Peter A. B. Widener, Thomas Dolan and John D. Crimmins. In a memorandum issued by Judge Lacombe attention is called to the fact that the same charges of liability were made before the New York railroad commission in 1906 and were dismissed. He states that the defendants deny liability and allege that a proper accounting would bear out their contention. In a statement issued by Cravath, Henderson & De Gersdorff, attorneys for the defendants, it is stated: "The defendants are confident there can be no personal recovery against the directors, and that the suit involves only an adjustment of accounts between the two corporations."

**Union Railway, New York.**—A receiver has been appointed for another subsidiary company of this railway, which is controlled by the New York City Railway. J. Addison Young was appointed receiver for the Tarrytown White Plains & Mamaroneck Railway of White Plains, N. Y., by Justice Mills of the New York state supreme court on January 21. Mr. Young is also receiver for the Westchester Electric Railroad, Mt. Vernon, N. Y. John H. Calhoun, superintendent of the Tarrytown White Plains & Mamaroneck road, testified that a report of accountants showed that in the last year the company lost \$43,769.37.

#### ELECTRIC RAILWAY EARNINGS.

Aurora Elgin & Chicago Railroad.			
	1907.	1906.	
Gross receipts	\$109,595.86	\$100,547.30	
Operating expenses	62,297.76	56,943.04	
Net earnings	47,298.10	43,604.26	
Fixed charges	28,440.39	26,186.10	
Surplus	18,857.71	17,418.16	
Houghton County Street Railway, Houghton, Mich.			
	1907.	1906.	
Gross earnings	\$19,816.28	\$18,545.46	
Expenses and taxes	13,210.52	11,993.78	
Net earnings	6,605.76	6,551.68	
Interest charges	3,926.08	3,907.08	
Balance	2,679.68	2,644.60	

# Manufactures and Supplies

## ROLLING STOCK.

Cumberland Valley Railroad has placed an order for three double-truck cars.

Indiana County Traction Company, Indiana, Pa., has ordered two double-truck cars from The J. G. Brill Company.

Illinois Central Electric Railway, Canton, Ill., has ordered two double-truck 30-foot semi-steel semi-convertible cars from the Danville Car Company. These cars will have a smoking compartment and will be equipped with the Anderson-Smith headlight. They will be 42 feet long over all.

Northwestern Pacific Railroad, San Francisco, Cal., as reported in the Electric Railway Review of December 21, has placed an order with the St. Louis Car Company for two combination passenger and baggage cars, two motor passenger cars and eight passenger cars to be used as trailers. All of these cars are equipped to operate in train service. The specifications include the following details:

### Two Passenger and Baggage Cars.

Weight, complete.....	64,000 lb.	Seating capacity .....	
Length, of body.....	40 ft. 8 in.	.....	36 passengers
Of platforms.....	4 ft. 8½ in.	Width, inside .....	8 ft. 8½ in.
Over all .....	50 ft. 1 in.	Over all .....	9 ft. 11½ in.
Height, inside .....	8 ft. 9 in.	Body .....	Wood
Sill to roof.....	10 ft. 2½ in.	Underframe .....	Wood
Track to roof.....	13 ft. 8½ in.		

### Two Motor Passenger Cars.

Seating capacity .....	66 passengers	Length, of body.....	50 ft. 6 in.
Height, inside .....	8 ft. 9 in.	Of platforms.....	3 ft. 2 in.
Sill to roof.....	10 ft. 2½ in.	Over all .....	56 ft. 10 in.
Track to roof.....	13 ft. 8½ in.	Width, inside .....	8 ft. 8½ in.
Body .....	Wood	Over all .....	9 ft. 11½ in.
Underframe .....	Wood	Weight, complete .....	59,000 lb.

### Eight Passenger Trailers.

Seating capacity .....	66 passengers	Height, inside .....	8 ft. 9 in.
Length, of body.....	50 ft. 6 in.	Sill to roof.....	10 ft. 2½ in.
Of platforms.....	3 ft. 2 in.	Track to roof.....	13 ft. 8½ in.
Over all .....	56 ft. 10 in.	Body .....	Wood
Width, inside .....	8 ft. 8½ in.	Underframe .....	Wood
Over all .....	9 ft. 11½ in.	Weight, complete .....	45,000 lb.

### Special Equipment.

Air brakes .....	Westinghouse, "AMR" schedule	Hand brakes .....	St. Louis type
Control system .....	"Sprague-GE type "M"	Headlights .....	St. Louis arc
Curtain fixtures .....	Curtain Supply Co.	Markers .....	Peter Gray
.....	Pantastote	Motors .....	2 GE-66
Door fastenings .....	.....	Seats.....	Hale & Kilburn Co.
.....	Adams & Westlake	Trucks—	
Door check .....	Blount	Motor cars .....	St. Louis
Gongs .....	New Departure	Car Co.'s No. 32 Hedley	
		Trailers .....	St. Louis Car Co.'s No. 48
		.....	Varnish...Valentine or Hueter

## SHOPS AND BUILDINGS.

Illinois Traction System, Champaign, Ill.—L. E. Fischer, general manager, Danville, Ill., writes that this company has arranged by lease for a large terminal site at Springfield, but on account of the stringency in the money market it will be impossible to proceed with the plan of construction at the present time.

## TRADE NOTES.

Pressed Steel Car Company, Pittsburg, Pa., declared on January 22 a quarterly dividend of 1¼ per cent on the preferred stock, payable February 26 to stockholders of record February 5.

Dossert & Co., 242 West Forty-first street, New York, report the receipt of an order for 500 cable taps for No. 0000 stranded cable from the Chicago City Railway for use on the new construction work.

The J. G. Brill Company, Philadelphia, Pa., has declared the regular quarterly dividends of 1¼ per cent on the preferred stock, payable February 1 to stock registered January 28, and 1 per cent on the common stock payable March 14 to stock of record March 12.

Allis-Chalmers Company, Milwaukee, Wis., states that the new type OB governor, recently brought out by it, which attracted a great deal of attention at the American Street and

Interurban Railway Association's convention held in Atlantic City, is being installed on many of the principal traction lines of the country, including the Manhattan Elevated Railway, Milwaukee Northern Railway, Indianapolis Crawfordsville & Western Railway, Connecticut Companies, Massachusetts Electric Company and others.

Freeman & Sons Manufacturing Company, Racine, Wis., has recently received an order from the West Penn Railways Company, Connellsville, Pa., for ten 350-horsepower Bonus-Freeman water-tube boilers. Two batteries of two boilers have been installed and the balance are now being installed.

Power Specialty Company, New York, states that the Foster superheater is rapidly finding its way into favor in Canada. The company's Montreal office, in the Board of Trade building, is in charge of Laurie & Lamb, consulting engineers, and largely through their efforts 12,670 horsepower of superheaters have been installed in Canada within the last 2½ years.

Stuart-Howland Company, Boston, Mass., has advanced Willard L. Lyall from the position of purchasing agent to that of manager of sales in the street railway department. The company has recently placed several valuable agencies and is preparing to push the street railway department with great activity. It reports business as fairly active and the future brightening.

Stewart Hartshorn Company, East Newark, N. J., manufacturer of spring shade rollers, has installed a gas producer plant, and is now using gas under all its tempering furnaces. The company reports that the result is a perfect control of all heat, which is so important in getting an even temper on all its spring wire. Coke firing did not produce as good results as are now possible.

Louis McFarland, 4741 Butler street, Pittsburg Pa., has secured a patent on an improved steel rail and tie, in which the rail is rolled with a projecting flange or tongue at the center of the base. This projection is square in section, the height and width being equal to about one-seventh of the width of the rail base, and the tie is provided with a corresponding recess to receive the tongue of the rail base.

American Locomotive Company, 111 Broadway, New York City, on December 19 declared a dividend of 1¼ per cent on the common capital stock, payable February 26 to stockholders of record February 6. About February 1 it is the intention of this company to close its plant at Providence. This is merely the carrying out of plans decided upon several years ago, but which were not executed at that time, owing to the enormous amount of business.

S-E. Missouri Cypress Company, Campbell, Mo., reports that prospects for business in cypress poles and ties are fair and indicate that quite a number of former users of cypress intend to continue its use in construction work this coming summer. This company is one of the oldest engaged in the production of poles and piling, and even during the late money stringency its volume of business was very nearly normal, although prices had fallen.

Lindsay Brothers Company, Spokane, Wash., producer and shipper of western cedar poles and manufacturer of red fir crossarms, states that no poles have been produced this winter on account of the late financial stringency. The company is fortunate in having its own stumpage, and therefore can always keep its yards completely stocked. A concentrating yard has been established at Spokane to enable the company to get cars promptly. The crossarms plant is operated under the name of the Barnes-Lindsay Manufacturing Company.

Lumen Bearing Company, Buffalo, N. Y., announces that its interests on the Pacific coast are now looked after by Charles C. Moore & Co., Incorporated, engineer, of San Francisco, Cal., with branch offices in Seattle, Los Angeles and Salt Lake City. In Cauda the agency is in the hands of J. A. Dawson & Co. of Montreal, with a branch office in Winnipeg. With five salesmen traveling from the Buffalo office, the Lumen company feels that the electric railway field is thoroughly covered, as is evidenced by its rapidly growing business.

William W. Power has recently been appointed manager of the electrical department of the Boston, Mass., branch of the H. W. Johns-Manville Company, New York. Mr. Power was formerly district manager of the Allis-Chalmers Company's Philadelphia office, and previous to that he was connected with the Christensen Engineering Company as special representative throughout the New England states. When that company was reorganized and made the National Electric Company Mr. Power continued with the latter concern until he became associated with the Allis-Chalmers Company. Mr.

Power is well and favorably known in the New England states and his wide experience in the electrical field, combined with a most pleasing personality, will assist him in his new position in charge of the electrical business of the H. W. Johns-Manville Company throughout New England.

#### ADVERTISING LITERATURE.

**Wickes Brothers, Saginaw, Mich.**—The January stock list of boilers, engines, dynamos, motors and machinery is at hand.

**Weber Gas Engine Company, Kansas City, Mo.**—Brochure No. 55 illustrates and describes heavy duty gas power plants.

**John Simmons Company, 102-110 Centre Street, New York, N. Y.**—A recent leaflet illustrates and describes the Rothschild inverted blow-off cock.

**Standard Steel Works, Philadelphia, Pa.**—A catalogue descriptive of springs of various types for railway and electric traction service has just been issued. A large number of interesting illustrations are included, consisting of exterior and interior views of the works, as well as of standard types of springs.

**Eastern Granite Roofing Company, 1 Hudson Street, New York, N. Y.**—The advantages of perfected Granite roofing are set forth in a 64-page booklet recently issued. Attention is directed to the fact that 23 years' use has demonstrated the special adaptability of Granite roofing for railway buildings. A list is shown of 10 such buildings, having a total area of 2,020,700 square feet of Granite roofing. The booklet has a large number of illustrations showing the roofing on a great variety of buildings throughout America.

**Chandler Brothers & Co., Philadelphia, Pa.**—A diary for 1908 contains information concerning the leading bond and stock issues, including the securities of electric railways, handled in the Philadelphia market. There are also published the principal facts concerning the securities of the Philadelphia Rapid Transit Company, the Indianapolis Traction & Terminal Company, the Indiana Union Traction Company, the Ft. Wayne & Wabash Valley Traction Company, the Louisville (Ky.) Traction Company, the Lexington & Interurban Railways Company and the Norfolk & Portsmouth Traction Company. Other information relating to quotations of securities, interest returns, etc., is given.

#### THE COST OF HOT WATER HEATING.

Some interesting data regarding the cost of heating suburban cars by hot water have been furnished by the Twin City Rapid Transit Company of Minneapolis, which has been using on all of its standard cars the "Mighty Midget" heater, manufactured by the William C. Baker Heating & Supply Company of New York. During the last winter the heaters on this road were in operation 164 days, during many of which the thermometer stood between zero and 25 degrees below, and the company found no difficulty in heating its cars and keeping them comfortable. The cost of coal to operate this heater was 28 cents per car per day, the best grade of anthracite being used. This is on the basis of coal at \$7.75 per ton, f. o. b. cars at Minneapolis. The company has been using the "Mighty Midget" heater on its cars for about 15 years.

#### IMPROVEMENTS IN KINNEAR DOORS.

Important improvements have recently been made in the well-known Kinear steel rolling door for car houses, manufactured by the Kinear Manufacturing Company of Columbus, O., in the new construction for the operation of two or more steel rolling doors in a group by means of an electric motor. It is claimed that this system now affords the best, most efficient and reliable means of closure for car house entrances, and that it is at the same time the most flexible. By means of an operating box at the side of each door, any door may be operated independently of all others, by motor, or it may be operated by hand crank if necessary or desirable.

The direction of travel is determined automatically and the door may be started from any position by merely throwing over an operating lever. When the end of the travel is reached the door is mechanically disengaged from the motor shaft, the circuit is broken and the motor stopped, and the lever returned to the neutral position. To operate by hand the lever is merely thrown in the opposite direction and the door operated by the hand crank which is provided.

Only approximately 10 seconds is required for the motor operation, so it will be seen that such a construction is of very great value, not only for car houses, but also for shops, where cars are run in and out frequently, and particularly in

cold climates, where the shop must be heated and where doors cannot be left open for any great length of time. The system is already in use on several car houses with the greatest success.

#### AIR COMPRESSORS FOR PUMPING.

The advantages of employing compressed air for pumping water, oil and other liquids from wells, vats and tanks, are so pronounced that within the last few years this system has

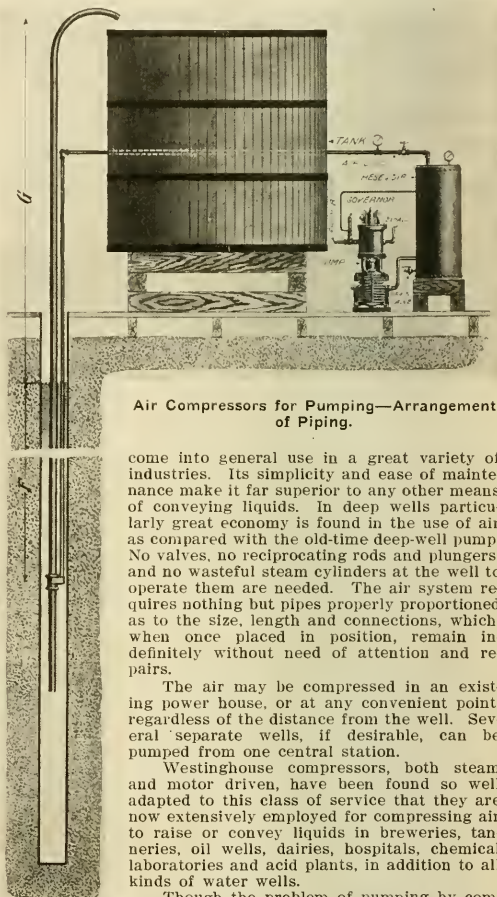

Air Compressors for Pumping—Arrangement of Piping.

come into general use in a great variety of industries. Its simplicity and ease of maintenance make it far superior to any other means of conveying liquids. In deep wells particularly great economy is found in the use of air as compared with the old-time deep-well pump. No valves, no reciprocating rods and plungers, and no wasteful steam cylinders at the well to operate them are needed. The air system requires nothing but pipes properly proportioned as to the size, length and connections, which, when once placed in position, remain indefinitely without need of attention and repairs.

The air may be compressed in an existing power house, or at any convenient point, regardless of the distance from the well. Several separate wells, if desirable, can be pumped from one central station.

Westinghouse compressors, both steam and motor driven, have been found so well adapted to this class of service that they are now extensively employed for compressing air to raise or convey liquids in breweries, tanneries, oil wells, dairies, hospitals, chemical laboratories and acid plants, in addition to all kinds of water wells.

Though the problem of pumping by compressed air with given conditions is a simple one, conditions differ so widely that it is impossible to arrive at a satisfactory solution by mathematical analysis. Results of actual tests are necessary to form a correct basis of figuring. Realizing this the Westinghouse Air Brake Company has lately completed a series of nearly 2,000 tests covering a range of from 350 to 400 different conditions of deep-well pumping, to obtain data concerning water delivered, air consumed and the best proportion and arrangement of piping and apparatus. The tests were made with a well driven on the premises of the Westinghouse Air Brake Company specially fitted up for experimental work. The results place the manufacturers in a position to be of great assistance to those desiring to install compressors for direct air pressure pumping.

The accompanying illustration shows the simple arrangement of piping used when the inside diameter of the well casing permits a discharge pipe and an air pipe, both of suitable size, to be placed side by side in the casing.

Much additional information is given in a booklet (No. 9006) published by the Westinghouse Air Brake Company, devoted entirely to the subject of pumping liquids by compressed air.

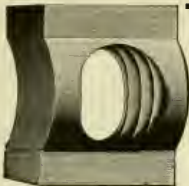

# Use GRIP NUTS on track bolts

and You Have a Better, Safer Track

GRIP NUTS never let loose under any strain, jar or vibration unless bolts break.

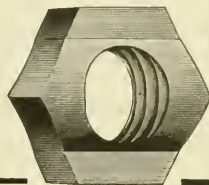

## GRIP NUT COMPANY

500 Fifth Avenue, NEW YORK

152 Lake Street, CHICAGO

# Demanded

by all heavy and high speed equipment on traction lines everywhere.

Their use assures safer and more economical operation.

Write us for the facts, please

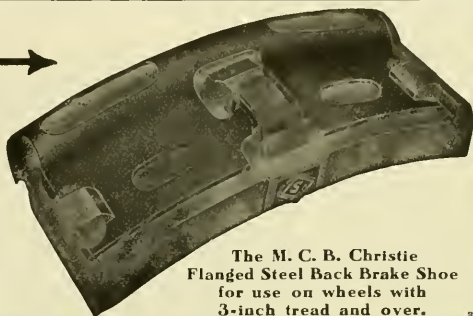

## American Brake Shoe & Foundry Co.

New York Chicago Chattanooga MAHWAH, N. J.

The M. C. B. Christie Flanged Steel Back Brake Shoe for use on wheels with 3-inch tread and over.

# Baltimore Center and Side Bearings

FOR ELECTRIC TRUCKS

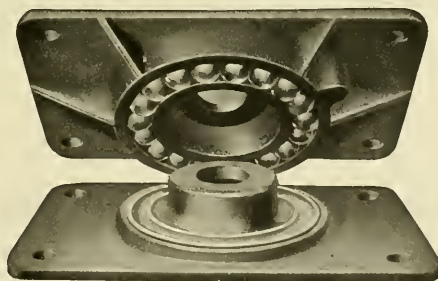

Impossible to Clog Balls

No Lubrication Necessary

**SAVES:** { FLANGE WEAR  
RAIL WEAR  
TRUCK REPAIRS

**DURABILITY:** { PROVEN UNDER HEAVIEST LOADS

BALTIMORE MD.

**THE T. H. SYMINGTON CO.**

CHICAGO ILL.

## THE J. G. BRILL COMPANY, PHILADELPHIA, PA.

AMERICAN CAR COMPANY, ST. LOUIS, MO.  
 G. C. KUHLMAN CAR COMPANY, CLEVELAND, OHIO  
 JOHN STEPHENSON COMPANY, ELIZABETH, N. J.  
 WASON MANUFACTURING CO. SPRINGFIELD, MASS.

MAIN OFFICE: PHILADELPHIA, PA.  
 LONDON OFFICE: 110 CANNON ST. E. C.  
 PACIFIC COAST AGENTS: PIERSON  
 ROEDING & CO., SAN FRANCISCO.  
 AUSTRALIAN AGENTS: NOYES  
 BROTHERS, SYDNEY. CABLES:  
 "BRILL," PHILA., "AXLES" LONDON.

*CARS TRUCKS SEATS RATTAN SPRINGS SPECIALTIES SUPPLIES*

## NON-OSCILLATING FRAME

In spite of the fact that the Brill No. 27-GE1 Truck has three sets of springs (one set more than any other truck of its class) working in series, and is the smoothest, easy-riding and most elastic truck in use to-day, it has that essential quality of a truck with outside-hung motors—a non-oscillating frame. The objectionable oscillation common to most trucks when running at a fair rate of speed, is entirely overcome in the Brill truck by the spring-link suspension of the load on the frame at wide-apart points and close to the yokes, enabling it to run steadily and smoothly at thirty miles an hour. There is no dangerous kicking-up of the frame under violent brake action, and, having a stable frame, the brake adjustment is reduced to the minimum. The non-oscillating frame is one of the best features of this truck.

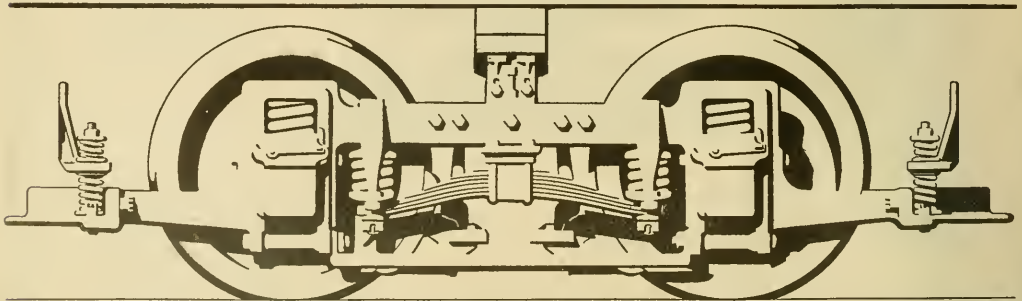

*THE BRILL NUMBER 27-GE1 TRUCK (PATENTED)*

# *General Electric Company*

## Controller Fingers and Segments

General Electric Contact Fingers are made of pure wrought copper, punched or drop forged, depending on conditions of operation. Fingers carrying heavy current have phosphor bronze springs reinforced with shunts of flexible copper strips, which insures deterioration of finger only at point of contact.

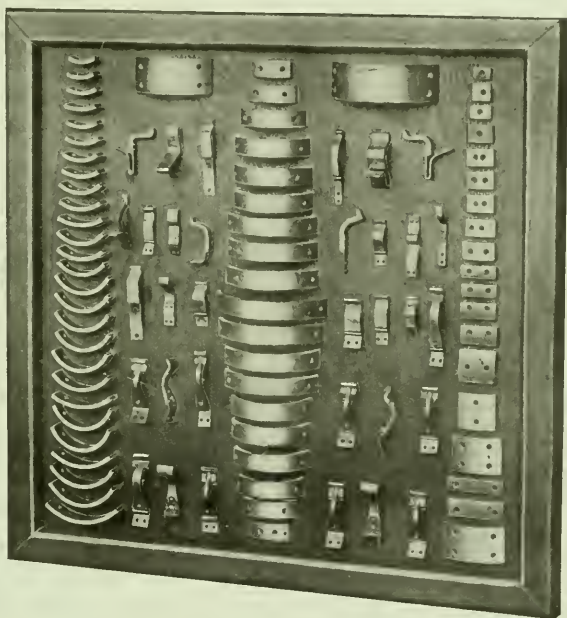

Increased thickness of shank and cold dropping  
prevent buckling of fingers.

All segments are made from rolled copper.

**“Original Equipment Quality”**

means

**“Original Equipment Service”**

1525

Chicago Office:  
Monadnock Bldg.

Principal Office:  
Schenectady, N. Y.

Sales Offices in  
all large cities

# Stuart-Howland Co.

Everything Electrical  
BOSTON

**LUFKIN**



**MEASURING TAPES**  
are the choice of expert electrical engineers in all quarters of the globe. Absolute accuracy and the highest possible degree of durability make them especially adapted to Electric Railway Work.

New York.  
London, Eng.  
Windsor, Can.

**THE LUFKIN RULE CO.**  
SAGINAW MICH., U. S. A.



(END VIEW)

Has adjustable steel noses — suitable for general urban and light interurban service. The most efficient low-priced electric snow-plow on the market.

## The Russell Pedestal Electric Snow-Plow No. 6

Further information on request — also catalog Electric Snow Plows.

**RUSSELL CAR & SNOW-PLOW CO., Ridgway, Pa.**

Wendell & MacDuffie, Cortlandt St., New York, Eastern Sales Agents; Robinson & Cary Co., St. Paul, Minn., C. A. Ralston, Fisher Bldg., Chicago, Ill., Western Sales Agents; Dominion Supply Co., Winnipeg, Manitoba, Western Canada Sales Agents.

Bonding and rebonding are better done by this car  
because its two processes

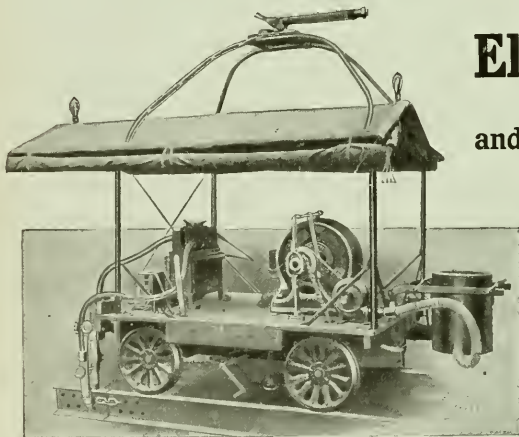

## Electric Brazing and Copper Welding

insure perfect mechanical and electrical union between bond and rail. And it is the only method that does produce this result at moderate cost.

*Write us for further facts.*

**The Electric Railway Improvement Co.**

6005 Carnegie Avenue, Cleveland, Ohio

6

**Drummond's Detective Agency**  
RAILWAY WORK A SPECIALTY  
A. L. DRUMMOND, GENERAL MANAGER, EX-CHIEF U. S. SECRET SERVICE, NEW YORK.



# Electric Railway Review

PUBLISHED EVERY SATURDAY.

FORMERLY THE STREET RAILWAY REVIEW.

THE WILSON COMPANY, CHICAGO.

160 Harrison Street, Chicago  
150 Nassau Street, New York  
1529 Williamson Bldg., Cleveland

VOL. XIX  
No. 6

CHICAGO, FEBRUARY 8, 1908

Whole No. 250  
Subscription: Domestic . . . \$2  
Foreign . . . \$5  
Canada . . . \$3.50

# STOP!

Consider the reasons  
why your road should  
be equipped with the

## Telegraph Signal System



### THE OPERATING SITUATION TODAY:

Two crews have orders to meet at a certain point, but one crew has forgotten. Disaster is almost certain, since there are no means at hand of enforcing the order. Serious accident, and perhaps death, with a long list of claims and litigation, naturally follow, together with a loss of patronage and prestige.

### AND THIS IS HOW IT SHOULD BE—

The dispatcher, desiring to reinforce his order, merely inserts a plug in the master machine of the Telegraph Signal System and within a few seconds the semaphore at the meeting point has been set at STOP! And he has positive evidence that the signal has been set, for the number of the station executing the stop order is automatically telegraphed back to his office and registered there.

When the first car approaching is stopped by the signal, the conductor enters the signal station or booth and calls the dispatcher. The latter gives such further orders as are necessary, or a release, and within a minute the car is again safely on its way or waiting in the clear.

No signal system approaches ours in positive results which produce safe operation, or in economical cost, both of installation and maintenance. One bare iron wire only is required for signaling. One dollar a month per station pays the maintenance. One bad smashup will pay for installation many times over.

Delays are dangerous! Don't put off investigation another day! Write today—*now*.

**Telegraph Signal Company** 282 State Street  
Rochester, N. Y.

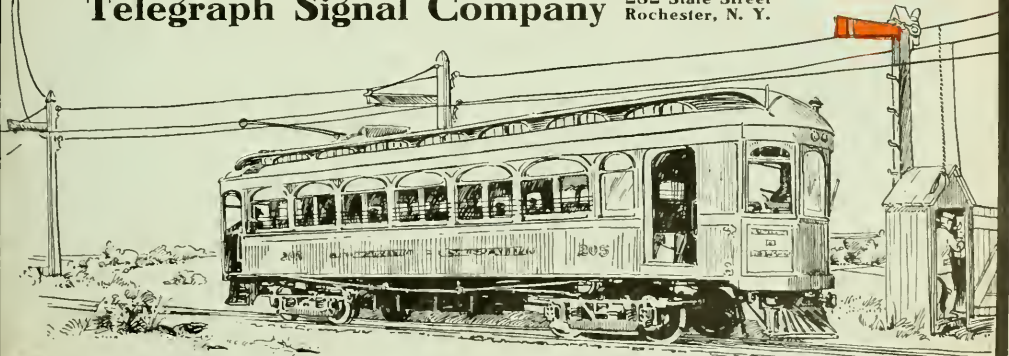

# ARMATURE AND FIELD COILS

of a Special Manufacture and High Quality

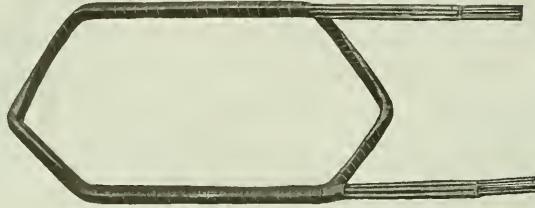

Armature Coils furnished by this Company have a special form of mica insulation. All coils are made to fit perfectly in slots without hammering and are thoroughly tested before leaving the factory.

Field Coils are placed under a vacuum, which removes all objectionable moisture. They are then impregnated with a solid compound which gives them high insulation and high heat resistance.

## ELECTRIC SERVICE SUPPLIES Co.

"Supplies for Every Electric Service"

MAYER & ENGLUND DEPT.  
PHILADELPHIA

NEW YORK

GARTON-DANIELS DEPT.  
KEOKUK

PITTSBURG

SAINT LOUIS

PORTER & BERG DEPT.  
CHICAGO

ATLANTA

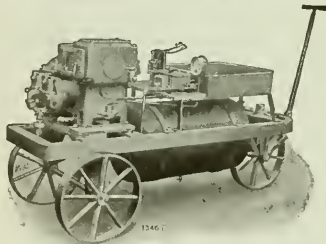

Portable Outfit with A-1 Compressor

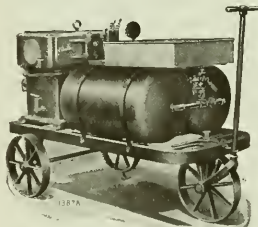

Portable Outfit with CC-3 Compressor

## National Portable Air Compressor Outfits

are especially adapted for service in car shops where compressed air is used for various operations such as drilling, chipping, riveting and for blowing dust and other matter out of car motors, car seats, etc. They are built in capacities of from 11 to 50 cubic feet of free air per minute. The 11 and 35 cubic foot sizes are illustrated herewith.

The small width of National Portable Outfits permits of their being taken through doors and other openings of much smaller width than the average.

Bulletin Sent on Request

## National Brake & Electric Co.

NEW YORK: 111 Broadway  
PHILADELPHIA:  
W. H. Goble, 1722 Westmoreland St.  
BOSTON: F. E. Huntress, 131 State St.

Milwaukee, U. S. A.

SAN FRANCISCO, CAL.: W. F. McKenny,  
69-71 First Street  
LONDON: 14 Great Smith St., Westminster

General Sales Office: 519 First National Bank Building, Chicago

# Westinghouse

## Interpole Railway Motors

reduce maintenance costs—have perfect commutation—practically eliminate flashing—greatly diminish brush wear—and are cleaner motors.

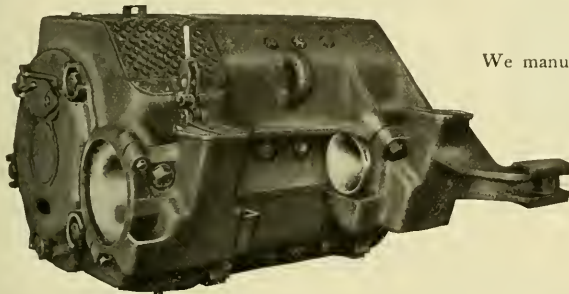

No. 300, 200 H. P.

We manufacture a complete line:

No. 300.....	200	H. P.
No. 301.....	160	“
No. 302.....	125	“
No. 303.....	100	“
No. 304.....	75	“
No. 305.....	60	“
No. 306.....	50	“
No. 307.....	40	“

## Westinghouse Electric & Mfg. Co.

Atlanta  
Baltimore  
Boston

Buffalo  
Chicago  
Cincinnati

Cleveland  
Dallas  
Denver

Detroit  
Kansas City  
Los Angeles  
Minneapolis

New Orleans  
New York  
Philadelphia

Pittsburg  
St. Louis  
Salt Lake City

San Francisco  
Seattle  
Syracuse

Canada: Canadian Westinghouse Co., Ltd., Hamilton, Ontario. Mexico: G. & O. Braniff & Co., City of Mexico.

## STEAM TURBINES



Can always be relied upon in emergencies

The day after a 3000-K.W. Westinghouse Turbine was installed in a plant already equipped with two turbines of another make, one of the latter failed and the Westinghouse Unit was immediately started and called upon to carry loads up to 3200 K.W. during peak hours, *without the assistance of a condenser*, which had not yet been installed. In spite of this handicap the Westinghouse Unit met the emergency without difficulty.

Particulars of Westinghouse Turbines in Catalogue 7002.

**The Westinghouse Machine Co.**  
Pittsburg, Pa.

## For High-Speed Service

[whether city, suburban or interurban, there is no other brake equipment possessing the many advantages of the]

## WESTINGHOUSE “AMM” AUTOMATIC

FOR 1, 2, 3, 4 AND 5 CAR TRAIN SERVICE.

It is strictly automatic, yet may be arranged to give a straight air release when required. Furthermore, it gives quick recharge of the auxiliary reservoirs, quick serial application of all brakes, graduated release at the triple valve and high pressure in emergencies.

Fully Described in Instruction Pamphlet T-5031.

**Westinghouse Traction Brake Co.**  
General Offices: Pittsburg, Pa.  
New York: Trinity Building  
Chicago: Ry. Exchange Building  
St. Louis: 1932 N. Broadway  
For Canada: Canadian Westinghouse Co., Ltd., Hamilton, Ont.

## ALPHABETICAL INDEX TO ADVERTISEMENTS.

Advance Lumber Co.....24	Drouvé, The G. Co.....26	Middleton Car Works.....	Smith, Peter, Heater Co.....25
Allis-Chalmers Co.....26	Drummond Detective Agency..	Miller Anchor Co.....	Speer Carbon Co.....22
Aluminum Co. of America.....26	Durkin Controller Handle Co..	Milloy Electric Co., The.....22	Standard Brake Shoe Co.....21
American Brake Shoe & Fdry. Co.....27	Earl, C. I.....23	Model Stoker Co., The.....22	Standard Motor Truck Co.....25
American Electrical Works.....	Eclipse Railway Supply Co.....18	Morden Frog & Crossing Wks.....	Standard Paint Co.....25
American Frog & Switch Co.....	Electric Railway Equipment Co.....	National Brake & Electric Co. 2	Standard Steel Works.....18
Anderson, Albert & J. M., Mfg. Co.....17	Electric Ry. Improvement Co.11	National Car Co.....25	Standard Underground Cable Co.....12
Armstrong Oiler Co.....22	Electric Service Supplies Co.2	National Lock Washer Co.....25	Standard Furnish Works.....12
Arnold Company.....22	Engineers and Contractors.....22	National Pole Co.....24	Star Brass Works.....18
Atlas Anchor Co.....18	Fairbanks, Morse & Co.....21	Naugle Pole & Tie Co.....24	Stone & Webster Engr. Corp.22
Babcock & Wilcox Co.....12	Ford, Bacon & Davis.....22	New York Switch & Crossing Co.....14	Stuart-Howland Co.....30
Baker, The Wm. C. Heating & Supply Co.....15	Galena-Signal Oil Co.....11	Niles Car & Mfg. Co.....15	Symington, T. H., Co.....30
Baldwin Locomotive Works.....13	General Electric Co.....29	Northern Engineering Works.30	Telegraph Signal Co.....1, 30
Barbour-Stockwell Co.....13	Goldschmidt Thermit Co.....17	Nuttall, R. D., Co.....30	Trolley Supply Co.....23
Barnes, G. H., Hardwood Lumber Co.....24	Green Engineering Co.....25	Ohio Brass Co.....	Under-Feed Stoker Co.....13
Beldler, Francis, & Co.....24	Green Fuel Economizer Co.....25	Okonite Co., Ltd.....	United States Graphite Co., The.....
Bellamy Vestlette Mfg. Co.....24	Griffin Wheel Co.....22	Pacific Coast Pole Co.....24	U. S. Metal & Mfg. Co.....
Berthold & Jennings.....24	Grip Nut Co.....27	Pantastote Co.....	Van Dorn & Dutton Co.....13
Blake Signal & Mfg. Co.....5	Haky, J. Milton, Waste Wks. 12	Patten, Paul.....25	Van Dorn, W. T., Co.....18
Bliss, R., Mfg. Co.....	Hale & Kilburn Mfg. Co.....24	Pay-As-You-Enter Car Co.9	Van Valkenburg, E. C.....25
Bridgport Brass Co.....31	Harrison, F. P., Elec. Mfg. Co.24	Power Specialty Co.....	Wallace Supply Co.....17
Brill, The J. G. Co.....28	Hartshorn, Stewart, Co.....	Pressed Steel Car Co.....15	Wanted and For Sale Cards.....
Brown, Harold P.....	Heine Safety Boiler Co.....22	Queen & Co.....17	.....20, 21
Brown Hoisting Machy. Co.5	Hewwood Bros. & Wakefield Co.....21	Rail Joint Co.....25	Washington Coupler Co.....25
Buckeye Engine Co.....18	Holman, D. F., Ry. Tracklayer Co.....	Robertson, C. B., Supply Co.....	Railway Steel-Spring Co.....22
Burnham, Williams & Co.....15	Home Computer Co.....	Reed, Francis, Co.....13	Recording Fare Register Co.22
Bylesby, H. M., & Co.....22	Hope Weibing Co.....22	Register, L., & Co.....22	Reid, J. B., & Co.....27
Central Inspection Bureau.....22	Hubbard Bros. Co.....	Reiter, G. C.....25	Westinghouse Elec. & Mfg. Co.....3
Chase-Shawmut Co.....11	Indestructible Fibre Co.....	Ridlon, Frank, Co.....	Westinghouse Machine Co.3
Churchill Cedar Co.....24	Jewett Car Co.....15	Roberts & Abbott Co.....	Westinghouse Traction Brake Co.....3
Cincinnati Car Co.....	Johann, F. A.....21	Robertson, Wm., & Co.30	Weston Electric Co.....3
Cincinnati Frog & Switch Co..	Johns-Manville, H. W., Co.5	Rodger Ballast Car Co.....14	Weston Electrical Instrument Co.....17
Cleveland Armature Works.....26	Kalamazoo Ry. Supply Co.....27	Rooke Automatic Register Co.13	Weston, Wm., Jr., & Co.....14
Cleveland Frog & Cross. Co.....	Kinnear Manufacturing Co.....	Rossiter, MacGovern & Co. (Incl.).....21	Western Condens. & Eng'g Co.....
Collier, Barron G.....	Lindsay Bros. Co., The.....24	Russell Car & Snow-Plow Co.21	Wheel Truing Brake Shoe Co.21
Columbia Construction Co.....22	Lorain Steel Co.....18	S-E. Missouri Cypress Co.....24	White, J. G., & Co.....22
Consolidated Car Fender Co.31	Lord & Burnham Co.....13	Low, Carl N. Y.....7	Wilson, J. G., Mfg. Co.....17
Consolidated Car-Heating Co.22	Lubin Rule Co.....30	St. Louis Car Wheel Co.....13	Wood, Guilford S.....12
Contractors' Supply & Equipment Co.....22	Lumen Bearing Co.....24	St. Louis Surfact. & Paint Co.....25	Woodman, R., Mfg. & Supply Co.....
Cooper Heater Co.....19	Macallen Co.....23	Sanders & Porter.....	Worcester, C. H., Co.....24
Curtine Co.....28	McGuire-Cummings Mfg. Co.20	Saxton, E.....	Zelnicke, Walter A., Supply Co.....21
Creaghead Engineering Co.22	Marshall, R. W., & Co.....21	Shimer & Chase Co.....22	
Curtain Supply Co.....25	Massachusetts Chemical Co.12	Sheaff & Jastad.....	
Davis, The John, Co.....	Meyers, Fred J., Mfg. Co.....	Simmons, John, Co.....18	
Dearborn Drug & Chemical Works.....17			
Detroit Graphite Co.....26			

## CLASSIFIED LIST OF ADVERTISERS.

<b>Advertising Service.</b> Van Valkenburg, E. C., 2117 West One Hundred and Second St., Chicago.	<b>Armature Lifts.</b> Electric Service Supplies Co., 200 Plymouth Bldg., Chicago.	<b>Bells and Gongs—Continued.</b> Kuhlman, The G. C., Car Co., Cleveland. McGuire-Cummings Mfg. Co., Chicago. Ohio Brass Co., Mansfield, O. Reiter, G. C., Canton, O. St. Louis Car Co., St. Louis, Mo. Stephenson, John, Co., Elizabeth, N. J. Wallace Supply Co., Chicago. Wason Mfg. Co., Springfield, Mass. Western Electric Co., Chicago.	<b>Bonds, Rail—Continued.</b> Goldschmidt Thermit Co., 43 Exchange Pl., New York. Johns-Manville, H. W., Co., New York. Ohio Brass Co., Mansfield, O.
<b>Advertising, Street Car.</b> Collier, Barron G., Flat Iron Bldg., New York.	<b>Asbestos Materials.</b> Johns-Manville, H. W., Co., New York.	<b>Black Lead.</b> Detroit Graphite Co., Detroit, Mich. U. S. Graphite Co., Saginaw, Mich.	<b>Brackets and Cross Arms.</b> Anderson, Albert & J. M., Mfg. Co., Boston. Creaghead Engineering Co., Cincinnati, O. Electric Railway Equipment Co., Cincinnati, O. Electric Service Supplies Co., 200 Plymouth Bldg., Chicago. Johns-Manville, H. W., Co., New York, N. Y. Lindsay Bros. Co., Spokane, Wash. Ohio Brass Co., Mansfield, O. Ridlon, Frank, Co., 200 Summer St., Boston. Western Electric Co., Chicago.
<b>Air Brakes—(See Brakes and Brake Parts).</b>	<b>Axles—(See Wheels and Axles).</b>	<b>Block System—(See Signals).</b>	<b>Brakes and Brake Parts.</b> Allis-Chalmers Co., Milwaukee, Wis. American Car Co., St. Louis. Brill, The J. G., Co., Philadelphia. Electric Service Supplies Co., 200 Plymouth Bldg., Chicago. General Electric Co., Schenectady, N. Y. Kuhlman, The G. C., Car Co., Cleveland. McGuire-Cummings Mfg. Co., Chicago. National Brake & Electric Co., Milwaukee. Stephenson, John, Co., Elizabeth, N. J. Wason Mfg. Co., Springfield, Mass. Westinghouse Traction Brake Co., Pittsburg, Pa.
<b>Air Compressors—(See Compressors, Air).</b>	<b>Badges and Buttons.</b> Electric Service Supplies Co., 200 Plymouth Bldg., Chicago. Recording Fare Register Co., New Haven, Conn.	<b>Blowers—(See Mechanical Draft)</b> Buckeye Engine Co., Salem, O.	<b>Brakeshoes.</b> American Brake Shoe & Fdry. Co., Mahwah, N. J. American Car Co., St. Louis. Barbour-Stockwell Co., Cambridgeport, Mass.
<b>Alloys and Bearing Metals.</b> Brown, H. P., 120 Liberty St., New York. General Electric Co., Schenectady, N. Y. Harrison Elec. & Mfg. Co., 169 South St., New York. Lumen Bearing Co., Buffalo, N. Y. Ohio Brass Co., Mansfield, O. Ridlon, Frank, Co., 200 Summer St., Boston. St. Louis Car Co., St. Louis, Mo.	<b>Ball Bearings.</b> Symington, T. H., Co., Baltimore, Md.	<b>Bolter.</b> Ebecock & Wilcox Co., N. Y. Fairbanks, Morse & Co., Chicago. Green Fuel Economizer Co., Milwaukee, Wis. Heine Safety Boiler Co., 421 Olive St., St. Louis. Lord & Burnham, Irvington-on-Hudson, New York. Rossiter, MacGovern & Co., 17 Battery Pl., New York.	<b>Brushes.</b> Stuart-Howland Co., Boston.
<b>Aluminum Wire, Etc.</b> Aluminum Co. of America, Pittsburg.	<b>Bases—(See Trolley Poles and Fittings).</b>	<b>Bolter Cleaning Compound.</b> Dearborn Drug & Chemical Works, Chicago. Johns-Manville, H. W., Co., New York.	
<b>Anchors.</b> Atlas Anchor Co., Cleveland, O. Electric Service Supplies Co., 200 Plymouth Bldg., Chicago. Miller Anchor Co., Norwalk, O. Ohio Brass Co., Mansfield, O.	<b>Ballast Cars—(See Cars, Ballast).</b>	<b>Bonds, Rail.</b> Brown, H. P., 120 Liberty St., New York. Chase-Shawmut Co., Newburyport, Mass. Electric Railway Improvement Co., Cleveland, O. Electric Service Supplies Co., 200 Plymouth Bldg., Chicago. General Electric Co., Schenectady, N. Y.	
<b>Armatures and Coils, Winding and Repairing.</b> Cleveland Armature Works, Cleveland, O. Electric Service Supplies Co., 200 Plymouth Bldg., Chicago. General Electric Co., Schenectady, N. Y. Harrison Elec. & Mfg. Co., 169 South St., New York. Marshall, R. W., & Co., 95 Liberty St., New York. Ridlon, Frank Co., 200 Summer St., Boston. Stuart-Howland Co., Boston.	<b>Belts and Gongs.</b> American Car Co., St. Louis. Brill, The J. G., Co., Philadelphia. Electric Service Supplies Co., 1020-24 Filbert St., Phila.		



# Time Saved for All by the Blake Signal System

On high-speed interurban roads where this system is in use, train crews do not have to stop at a number of points to call up for orders, which may or may not be awaiting them.

They stop and call up **ONLY** when signaled by the dispatcher to do so, though they **MAY** call him whenever emergency makes it necessary.

This saves time for all—train crew, dispatcher and passengers.

Economical to install and to operate.  
Ask for descriptive pamphlet, please.

## Blake Signal & Manufacturing Company

246 Summer St. Boston, Mass. 3

# Remarkable Waterproof Test



THIS illustration shows a 16 c. p. lamp burning under water in a J-M MOULDED MICA WEATHERPROOF SOCKET. This is proof, positive, of the exceptional waterproof qualities of this socket.

These sockets are without equal for use out of doors and in other damp places. They are practically indestructible and will not break or crack like porcelain; are absolutely waterproof, and possess the highest insulating qualities.

Approved by National Board of Fire Underwriters.

*Write nearest Branch for Booklet 430.*

### H. W. JOHNS-MANVILLE CO.

	New York	Pittsburg	Minneapolis
	Milwaukee	Cleveland	San Francisco
	Chicago	Buffalo	Los Angeles
	Boston	Baltimore	Seattle
	Philadelphia	New Orleans	Dallas
	St. Louis	Kansas City	London 712A

# Brown Hoist Electric Locomotive

## CRANES DO VALUABLE SERVICE IN LIFTING AROUND POWER STATIONS AND CAR HOUSES

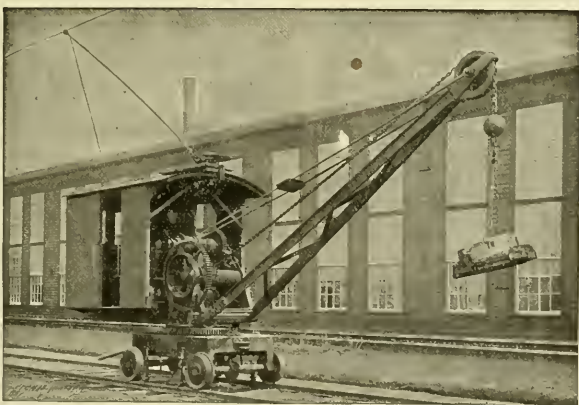

EVERY SORT OF HOISTING APPARATUS IS SHOWN IN OUR CATALOGUE

# THE BROWN HOISTING MACHINERY CO.

HAVEMEYER BLDG., NEW YORK      CLEVELAND, OHIO      FRICK BLDG., PITTSBURG, PA.

## CLASSIFIED LIST OF ADVERTISERS—Continued.

- Brakeshoes—Continued.**  
Brill, The J. G., Co., Philadelphia.  
Kuhlman, The G. C., Car Co., Cleveland.  
McGuire-Cummings Mfg. Co., Chicago.  
Marshall, R. W., & Co., 95 Liberty St., New York.  
St. Louis Car Co., St. Louis, Mo.  
Standard Brake Shoe Co., Aurora, Ill.  
Stephenson, John, Co., Elizabeth, N. J.  
Wason Mfg. Co., Springfield, Mass.  
Wharton, Wm., Jr., & Co., Philadelphia.  
Wheel Truing Brake Shoe Co., Detroit.
- Bridges.**  
Johann, F. A., 1624 Pierce Bldg., St. Louis.
- Bridge Timbers.**  
Beidler, Francis, & Co., Chgo.
- Brushes, Motors and Dyanomos.**  
Electric Service Supplies Co., 200 Plymouth Bldg., Chicago.  
General Electric Co., Schenectady, N. Y.  
National Carbon Co., Cleveland, O.  
Ridlon, Frank, Co., 200 Summer St., Boston.  
Speer Carbon Co., St. Marys, Pa.
- Bumpers, Car.**  
American Car Co., St. Louis.  
Brill, The J. G., Co., Philadelphia.  
Kuhlman, The G. C., Car Co., Cleveland.  
St. Louis Car Co., St. Louis, Mo.  
Stephenson, John, Co., Elizabeth, N. J.  
Wason Mfg. Co., Springfield, Mass.
- Car House Doors.**  
Kinner Mfg. Co., Columbus, O.  
Wilson, J. G., Mfg. Co., New York.
- Car Replacers.**  
Electric Service Supplies Co., 200 Plymouth Bldg., Chicago.  
Fairbanks, Morse & Co., Chgo.  
Ohio Brass Co., Mansfield, O.  
U. S. Metal & Mfg. Co., 25 Brd St., New York.
- Car Roof Paint, Canvas.**  
St. Louis Surfacor & Paint Co., St. Louis, Mo.
- Car Seats.**  
American Car Co., St. Louis.  
Brill, The J. G., Co., Philadelphia.  
Hale & Kilburn Mfg. Co., Philadelphia.  
Heywood Bros. & Wakefield Co., Wakefield, Mass.  
Kuhlman, The G. C., Car Co., Cleveland.  
St. Louis Car Co., St. Louis, Mo.  
Stephenson, John, Co., Elizabeth, N. J.  
Wallace Supply Co., Chicago.  
Wason Mfg. Co., Springfield, Mass.
- Car Signs—(See Signs, Cars and Track).**
- Car Steps.**  
Electric Service Supplies Co., 200 Plymouth Bldg., Chicago.  
Wallace Supply Co., Chicago.
- Car Trimmings—(See Trimmings, Car).**
- Cars, Ballast.**  
Rodger Ballast Car Co., Chgo.  
St. Louis Car Co., St. Louis, Mo.
- Cars, Dump.**  
Fairbanks, Morse & Co., Chgo.  
Midletown Car Works, Midletown, Pa.  
Rodger Ballast Car Co., Chgo.  
Russell Car & Snow-Plow Co., Ridgway, Pa.  
St. Louis Car Co., St. Louis, Mo.
- Cars, Passenger and Freight.**  
American Car Co., St. Louis.  
Brill, The J. G., Co., Philadelphia.  
Cincinnati Car Co., Cincinnati.  
Detroit Carbuilding & Equipment Co., Detroit, Mich.
- Cars, Passenger and Freight—Continued.**  
Electric Railway Improvement Co., Cleveland, O.  
Fairbanks, Morse & Co., Chgo.  
Jewett Car Co., Newark, O.  
Johann, F. A., 1624 Pierce Bldg., St. Louis.  
Kuhlman, The G. C., Car Co., Cleveland.  
McGuire-Cummings Mfg. Co., Chicago.  
Niles Car & Mfg. Co., Niles, O.  
Pressed Steel Car Co., Pittsburg.  
Roda Ballast Car Co., Chgo.  
Russell Car & Snow-Plow Co., Ridgway, Pa.  
St. Louis Car Co., St. Louis, Mo.  
Standard Motor Truck Co., Pittsburg.  
Stephenson, John, Co., Elizabeth, N. J.  
Wason Mfg. Co., Springfield, Mass.
- Cars, Pay-As-You-Enter.**  
Pay-As-You-Enter Car Co., 26 Cortland St., New York.
- Cars, Rebuilt.**  
Detroit Carbuilding & Equipment Co., Detroit, Mich.
- Cars, Second-Hand.**  
Detroit Carbuilding & Equipment Co., Detroit, Mich.  
Marshall, R. W., & Co., 95 Liberty St., New York.  
Zelnicke, Walter A., Supply Co., St. Louis.
- Cars, Steel.**  
Midletown Car Works, Midletown, Pa.  
Pressed Steel Car Co., Pittsburg.  
St. Louis Car Co., St. Louis, Mo.  
Standard Motor Truck Co., Pittsburg.
- Castings, Brass.**  
Star Brass Works, Kalamazoo, Mich.
- Castings, Iron and Steel.**  
American Brake Shoe & Foundry Co., Mahwah, N. J.  
Green Engineering Co., Com'l Nat. Bk. Bldg., Chicago.  
Lorain Brake Co., Johnstown, Pa.  
National Brake & Electric Co., Milwaukee.
- Catchers—(See Trolley Retrievers and Catchers).**
- Cattle Guards.**  
Fairbanks, Morse & Co., Chgo.
- Cements, Cable and Transformer.**  
Massachusetts Chemical Co., Walpole, Mass.
- Circuit-Breakers.**  
Electric Service Supplies Co., 200 Plymouth Bldg., Chicago.  
General Electric Co., Schenectady, N. Y.  
Western Electric Co., Chicago.
- Coal Handling Machinery—(See Conveyors).**
- Colls—(See Armatures and Colls).**
- Commutators and Parts.**  
Cleveland Armature Works, Cleveland.  
Electric Service Supplies Co., 1020-24 Filbert St., Phila.  
General Electric Co., Schenectady, N. Y.  
Harrison Elec. & Mfg. Co., 169 South St., New York.  
Home Commutator Co., Cleveland, O.  
Marshall, R. W., & Co., 95 Liberty St., New York.  
Ohio Brass Co., Mansfield, O.  
Stuart-Howland Co., Boston.
- Compressors, Air.**  
Fairbanks, Morse & Co., Chgo.  
General Electric Co., Schenectady, N. Y.  
National Brake & Electric Co., Milwaukee.  
Westinghouse Traction Brake Co., Pittsburg.
- Concrete Mixers.**  
Contractors' Supply & Equip. Co., Chicago.
- Condensers.**  
Wheeler Con. & Eng. Co., New York.
- Conduits.**  
Electric Service Supplies Co., 200 Plymouth Bldg., Chicago.  
Western Electric Co., Chicago.
- Contractors.**  
Arnold Company, 181 La Salle St., Chicago.  
Beveland, H. M., Co., Am. Trust Bldg., Chicago.  
Columbia Construction Co., Milwaukee, Wis.  
Crescent Engineering Co., Cincinnati, O.  
Green Engineering Co., Com'l Nat. Bk. Bldg., Chicago.  
Register A. L., & Co., 112 N. Broad St., Philadelphia.  
Sanderson & Porter, 52 William St., New York.  
Saxton, E., 341 E. Broadway, R. Washington, D. C.  
Sheaff & Jaastad, 88 Broad St., Boston.  
Stone & Webster Engineering Corp., Boston.  
Wharton, Wm., Jr., & Co., Philadelphia.  
White, J. G., & Co., 49 Exchange Pl., New York.
- Controllers and Attachments.**  
Durkin Con. Handle Co., Arcade Bldg., Philadelphia.  
Electric Service Supplies Co., 200 Plymouth Bldg., Chicago.  
General Electric Co., Schenectady, N. Y.  
Harrison Elec. & Mfg. Co., 169 South St., New York.  
Jones-Manville, H. W., Co., New York.  
Marshall, R. W., & Co., 95 Liberty St., New York.  
Western Electric Co., Chicago.  
Westinghouse Electric & Mfg. Co., Pittsburg.
- Conveyors and Coal Handling Machinery.**  
Green Engineering Co., Com'l Nat. Bk. Bldg., Chicago.  
Northern Engineering Works, Detroit, Mich.
- Cord, Bell and Trolley.**  
American Car Co., St. Louis.  
Brill, The J. G., Co., Philadelphia.  
Electric Service Supplies Co., 1020-24 Filbert St., Phila.  
Kuhlman, The G. C., Car Co., Cleveland.  
St. Louis Car Co., St. Louis, Mo.  
Stephenson, John, Co., Elizabeth, N. J.  
Stuart-Howland Co., Boston.  
Wason Mfg. Co., Springfield, Mass.
- Couplers, Car.**  
American Car Co., St. Louis.  
Brill, The J. G., Co., Philadelphia.  
Kuhlman, The G. C., Car Co., Cleveland.  
McGuire-Cummings Mfg. Co., Chicago.  
Ohio Brass Co., Mansfield, O.  
St. Louis Car Co., St. Louis, Mo.  
Stephenson, John, Co., Elizabeth, N. J.  
Van Dorn, W. T., Co., Paulina St., Chicago.  
Wallace Supply Co., Chicago.  
Washburn, E. C., Minneapolis.  
Wason Mfg. Co., Springfield, Mass.
- Coverings, Pipe and Boiler.**  
Jones-Manville, H. W., Co., New York.
- Cranes, Hoists and Lifts.**  
American Car Co., St. Louis.  
Brill, The J. G., Co., Philadelphia.  
Brown Hoisting Machinery Co., Cleveland, O.  
Kuhlman, The G. C., Car Co., Cleveland.  
Northern Engineering Works, Detroit, Mich.  
Railway Specialty & Supply Co., Chicago.  
Stephenson, John, Co., Elizabeth, N. J.  
Van Dorn & Dutton Co., Cleveland, O.  
Wason Mfg. Co., Springfield, Mass.
- Cross Arms—(See Brackets and Cross Arms).**
- Crossing Gates—(See Gates and Guards).**
- Crossings, Track—(See Switches).**
- Curtains, Fixtures and Materials.**  
American Car Co., St. Louis.  
Brill, The J. G., Co., Philadelphia.  
Curtain Supply Co., 93 Ohio St., Chicago.
- Curtains, Fixtures and Materials—Continued.**  
Electric Service Supplies Co., 200 Plymouth Bldg., Chicago.  
Hartshorn, Stewart, Co., East Newark, N. J.  
Kuhlman, The G. C., Car Co., Cleveland.  
Marshall, R. W., & Co., 95 Liberty St., New York.  
National Lock Washer Co., Newark, N. J.  
Pantatote Co., 11 Broadway, New York.  
St. Louis Car Co., St. Louis.  
Stephenson, John, Co., Elizabeth, N. J.  
Wason Mfg. Co., Springfield, Mass.
- Cylinder Oil.**  
Power Specialty Co., 111 Broadway, N. Y.
- Derailing Devices.**  
American Frog & Switch Co., Hamilton, O.  
Cincinnati Frog & Switch Co., Cincinnati, O.  
Cleveland Frog & Crossing Co., Cleveland, O.
- Detective Agency.**  
Drummond Detective Agency, New York.
- Diaphragms.**  
Wood, G. S., Great Northern Bldg., Chicago.
- Doors and Fixtures.**  
American Car Co., St. Louis.  
Brill, The J. G., Co., Philadelphia.  
Kuhlman, The G. C., Car Co., Cleveland.  
St. Louis Car Co., St. Louis, Mo.  
Stephenson, John, Co., Elizabeth, N. J.  
Wallace Supply Co., Chicago.  
Wason Mfg. Co., Springfield, Mass.
- Doors, Steel Rolling.**  
Kinner Manufacturing Co., Columbus, O.  
Wilson, J. G., Mfg. Co., New York.
- Draft, Mechanical—(See Mechanical Draft).**
- Draft Rigging.**  
Van Dorn W. T., Co., Chgo.  
Wallace Supply Co., Chicago.
- Drills, Track.**  
Brown, H. P., 120 Liberty St., New York.  
Electric Service Supplies Co., 200 Plymouth Bldg., Chicago.  
Fairbanks, Morse & Co., Chgo.  
Marshall, R. W., & Co., 95 Liberty St., New York.  
Reed, Francis, Co., Worcester, Mass.  
Ridlon, Frank, Co., 200 Summer St., Boston.
- Drying Appliances.**  
Green Fuel Economizer Co., Matteawan, N. Y.
- Dynamos and Generators.**  
Cleveland Armature Works, Cleveland, O.  
Fairbanks, Morse & Co., Chgo.  
General Electric Co., Schenectady, N. Y.  
National Brake & Electric Co., Milwaukee, Wis.  
Rossiter, MacGovern & Co., 17 Battery Pl., New York.  
Westinghouse Electric Co., Chicago.  
Westinghouse Electric & Mfg. Co., Pittsburg, Pa.
- Economizers, Fuel.**  
Green Fuel Economizer Co., Matteawan, N. Y.
- Electrical Instruments.**  
Electric Service Supplies Co., 200 Plymouth Bldg., Chicago.  
General Electric Co., Schenectady, N. Y.  
Jones-Manville, H. W., Co., New York.  
Queen & Co., Philadelphia.  
Western Electric Co., Chicago.  
Westinghouse Electric & Mfg. Co., Pittsburg, Pa.  
Wason Electric Instrument Co., Newark, N. J.
- Electric Railway Supplies, General.**  
Cleveland Armature Works, Cleveland, O.  
Crescent Engineering Co., Cincinnati, O.

# ST. LOUIS CAR CO.

## ST. LOUIS - MO.

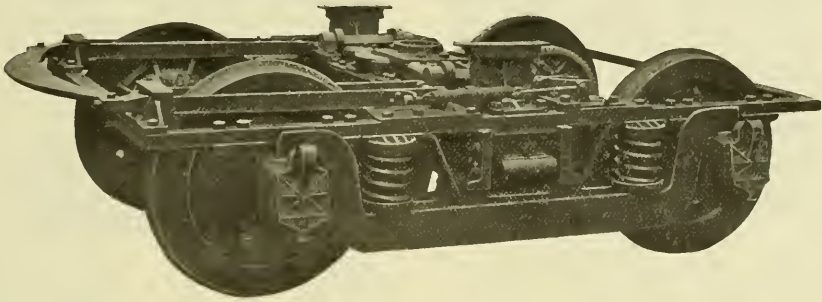

St. Louis Car Company M. C. B. Double Equalizer Type No. 62 Truck

### Details of Construction:

**T**RUCK frames are made of wrought iron forged in one piece, with a heavy fillet in each corner, and planed to receive pedestal jaws and center frames of transoms. Pedestals are of wrought iron and the upper face of each is machined so as to lip on side frame. Wearing faces are machined and provided with oil grooves. Faces which engage the pedestal tie bars are also machined.

Transoms are made of two 10" channels secured to frames by being bolted to machined cast steel side strut castings and bolted to side frame with heavy steel gusset plates.

Removable chafing plates are also provided on the transom channels. Bolsters are of cast steel and provided with end springs to

limit side motion of car body. Bolsters also are provided with removable chafing plates.

Equalizers are of wrought iron and forged with a lug to fit into recess in the journal boxes. Brakes are of the equalized type and arranged to suit cars operated around short curves.

Brake rigging is provided with suitable safety hangers. Ends of hangers and hanger pins are case hardened to reduce the wear to a minimum and prevent rattling.

All bolts used in assembling the trucks are taper finished, turned to a taper of  $\frac{1}{8}$ " per foot, and all holes for bolts are reamed to templates.

All parts of the truck when machined are made to template and all holes are drilled with a jig.

Made in the largest and best equipped  
factory of its kind in the world.

## CLASSIFIED LIST OF ADVERTISERS—Continued.

- Electric Railway Supplies, General—Continued.  
Electric Service Supplies Co., 200 Plymouth Bldg., Chicago.  
Fairbanks, Morse & Co., Chgo.  
General Electric Co., Schenectady, N. Y.  
Harrison Elec. & Mfg. Co., 169 South St., New York.  
Johns-Manville, H. W., Co., New York.  
Marshall, R. W., & Co., 95 Liberty St., New York.  
Ohio Brass Co., Mansfield, O.  
Stuart-Howland Co., Boston.  
Wallace Electric Co., Chicago.  
Western Electric Co., Chicago.
- Enamels.  
Acme White Lead & Color Works, Detroit, Mich.  
St. Louis Surfact & Paint Co., St. Louis, Mo.
- Engine Apparatus.  
Green Fuel Economizer Co., Matteawan, N. Y.
- Engineers and Contractors.  
Arnold Company, Chicago.  
Bylesby, H. M., & Co., Chgo.  
Columbia Construction Co., Milwaukee, Wis.  
Ford, Bacon & Davis, New York.  
Register, A. L., & Co., Philadelphia.  
Roberts & Abbott Co., Cleveland, O.  
Sanderson & Porter, New York.  
Saxton, E., Washington, D. C.  
Sheaf & Jastad, Boston.  
Stone & Webster Eng. Corporation, Boston.  
White, J. G., & Co., New York.
- Engines, Gas and Oil.  
Buckeye Engine Co., Salem, O.  
Fairbanks, Morse & Co., Chgo.  
Westinghouse Machine Co., Pittsburg.
- Engines, Hoisting.  
Fairbanks, Morse & Co., Chgo.
- Engines, Steam.  
Buckeye Engine Co., Salem, O.  
Rossiter, MacGovern & Co., 17 Battery Pl., New York.  
Westinghouse Machine Co., Pittsburg.
- Fans, Exhaust and Ventilating.  
General Electric Co., Schenectady, N. Y.  
Green Fuel Economizer Co., Matteawan, N. Y.  
Western Electric Co., Chicago.  
Westinghouse Elec. & Mfg. Co., Pittsburg.
- Fare Boxes—(See Electric Railway Supplies).
- Fare Registers and Register Fittings.  
Electric Service Supplies Co., 200 Plymouth Bldg., Chicago.  
Recording Fare Register Co., New Haven, Conn.  
Rooke Automatic Register Co., Providence, R. I.
- Feedwater Apparatus.  
Green Fuel Economizer Co., Matteawan, N. Y.  
Wheeler Condenser & Eng'g Co., New York.
- Feed Wire—(See Wire and Cables).
- Fenders and Guards.  
Consolidated Car Fender Co., Providence, R. I.  
Eclipse Railway Supply Co., Cleveland, O.  
Electric Service Supplies Co., 1020-24 Filbert St., Phila.  
McGuire-Cummings Mfg. Co., Chicago.  
Marshall, R. W., & Co., 95 Liberty St., New York.
- Flangers, Snow.  
McGuire-Cummings Mfg. Co., Chicago.  
Ohio Brass Co., Mansfield, O.  
Van Dorn & Dutton Co., Cleveland, O.
- Frogs—(See Switches, Frogs and Crossings).
- Fuel Economizers—(See Economizers, Fuel).
- Fuses and Fuse Devices.  
Chase-Shawmut Co., Newburyport, Mass.
- Fuses and Fuse Devices—Continued.  
Electric Service Supplies Co., 200 Plymouth Bldg., Chicago.  
General Electric Co., Schenectady, N. Y.  
Johns-Manville, H. W., Co., New York.  
Western Electric Co., Chicago.  
Westinghouse Elec. & Manufacturing Co., Pittsburg.
- Gaskets, Bronze.  
Power Specialty Co., 111 Broadway, New York.
- Gates and Guards.  
Bliss, R., Mfg. Co., Pawtucket, R. I.
- Gear Cases.  
Electric Service Supplies Co., 200 Plymouth Bldg., Chicago.  
General Electric Co., Schenectady, N. Y.  
Marshall, R. W., & Co., 95 Liberty St., New York.
- Gears and Pinions.  
Electric Service Supplies Co., 200 Plymouth Bldg., Chicago.  
General Electric Co., Schenectady, N. Y.  
Marshall, R. W., & Co., 95 Liberty St., New York.  
Nuttall, R. D., Co., Pittsburg.  
Van Dorn & Dutton Co., Cleveland, O.
- Generators—(See Dynamos).
- Gongs—(See Bells and Gongs).
- Graphite.  
Detroit Graphite Co., Detroit, Mich.  
U. S. Graphite Co., Saginaw, Mich.
- Gratings, Chain.  
Green Engineering Co., Com'l Nat. Bk. Bldg., Chicago.
- Grease—(See Lubricants).
- Grinders.  
Brown, Harold P., 120 Liberty St., New York.
- Guy Anchors—(See Anchors).
- Harps, Trolley—(See Trolley Poles and Fittings).
- Headlights.  
Electric Service Supplies Co., 200 Plymouth Bldg., Chicago.  
Fairbanks, Morse & Co., Chgo.  
General Electric Co., Schenectady, N. Y.  
Ridlon, Frank, Co., 200 Summer St., Boston.  
St. Louis Car Co., St. Louis, Mo.  
Stuart-Howland Co., Boston.  
Trolley Supply Co., Canton, O.
- Headlinings, Passenger Car.  
Indestructible Fibre Co., 46 Broadway, New York.
- Heaters, Car, Electric.  
Consolidated Car-Heating Co., Albany, N. Y.  
Johns-Manville, H. W., Co., New York.
- Heaters, Car, Hot Water, and Stoves.  
Baker, The Wm. C., Heating & Sup. Co., New York.  
Cooper Heater Co., The, Dayton, O.  
Electric Service Supplies Co., 1020-24 Filbert St., Phila.  
McGuire-Cummings Mfg. Co., Chicago.  
Smith, Peter, Heater Co., Detroit, Mich.
- Heating and Ventilating Apparatus—(See Mech. Draft).
- Hoists—(See Cranes, Hoists and Lifts).
- Hose Bridges.  
Ohio Brass Co., Mansfield, O.
- Hydraulic Machinery.  
Watson-Stillman Co., 26 Cortlandt St., New York.
- Inspection.  
Central Inspection Bureau.
- Inspection Cars, Gasoline.  
Stover Motor Car Co., Freeport, Ill.
- Instruments, Measuring and Testing—(See Electrical Instruments).
- Insulating Tapes.  
General Electric Co., Schenectady, N. Y.  
Harrison Elec. & Mfg. Co., 169 South St., New York.  
Johns-Manville, H. W., Co., New York, N. Y.  
Massachusetts Chemical Co., Walpole, Mass.  
Okonite Co., Ltd., 253 Broadway, New York.  
Western Electric Co., Chicago.
- Insulations and Insulating Material.  
Anderson, A. & J. M., Mfg. Co., Boston.  
Craghead Engineering Co., Cincinnati, O.  
Electric Railway Equipment Co., Cincinnati, O.  
Electric Service Supplies Co., 200 Plymouth Bldg., Chicago.  
General Electric Co., Schenectady, N. Y.  
Johns-Manville, H. W., Co., New York.  
Macallen, The, Co., Boston.  
Massachusetts Chemical Co., Walpole, Mass.  
Ohio Brass Co., Mansfield, O.  
Okonite Co., Ltd., 253 Broadway, New York.  
Ridlon, Frank, Co., 200 Summer St., Boston.  
Standard Paint Co., 100 William St., New York.  
Standard Varnish Works, New York.  
Stuart-Howland Co., Boston.  
Western Electric Co., Chicago.
- Jacks.  
American Car Co., St. Louis.  
Brill, The J. G., Co., Philadelphia.  
Electric Service Supplies Co., 200 Plymouth Bldg., Chicago.  
Fairbanks, Morse & Co., Chgo.  
Kuhlman, The G. C., Car Co., Cleveland.  
Marshall, R. W., & Co., 95 Liberty St., New York.  
Morden Frog & Crossing Co., Chicago.  
Stephenson, John, Co., Elizabeth, N. J.  
Wason Mfg. Co., Springfield, Mass.  
Watson-Stillman Co., 26 Cortlandt St., New York.
- Joints, Expansion—(See Steam Fittings).
- Joints, Rail.  
Goldschmidt Thermit Co., 43 Exchange Pl., New York.  
Rail Joint Co., 29 W. 34th St., New York.
- Joints, Welded—(See Rail Joints, Welded).
- Journal Boxes.  
American Car Co., St. Louis.  
Brill, The J. G., Co., Philadelphia.  
Kuhlman, The G. C., Car Co., Cleveland.  
McGuire-Cummings Mfg. Co., Chicago.  
St. Louis Car Co., St. Louis, Mo.  
Stephenson, John, Co., Elizabeth, N. J.  
Syrington, T. H., Co., Baltimore, Md.  
Wason Mfg. Co., Springfield, Mass.
- Journal Lubricators—(See Lubricators).
- Journal Packing, Steel Wool.  
Robertson, Wm., & Co., Great Northern Bldg., Chicago.
- Lamps, Arc and Incandescent.  
Anderson, A. & J. M., Mfg. Co., Boston.  
Electric Service Supplies Co., 200 Plymouth Bldg., Chicago.  
General Electric Co., Schenectady, N. Y.  
Ridlon, Frank, Co., 200 Summer St., Boston.  
Stuart-Howland Co., Boston.  
Western Electric Co., Chicago.  
Westinghouse Electric & Mfg. Co., Pittsburg, Pa.
- Lamp Sockets.  
Electric Service Supplies Co., 200 Plymouth Bldg., Chicago.  
General Electric Co., Schenectady, N. Y.  
Johns-Manville, H. W., Co., New York, N. Y.
- Lantern Globes.  
Railway Specialty & Supply Co., Chicago.
- Lifts—(See Cranes, Hoist and Lift).
- Lightning Arresters.  
Electric Service Supplies Co., 200 Plymouth Bldg., Chicago.  
General Electric Co., Schenectady, N. Y.  
Stuart-Howland Co., Boston.  
Western Electric Co., Chicago.  
Westinghouse Elec. & Manufacturing Co., Pittsburg.
- Line Material.  
Anderson, A. & J. M., Mfg. Co., Boston.  
Craghead Engineering Co., Cincinnati, O.  
Johns-Manville, H. W., Co., New York.  
Electric Ry. Equipment Co., Cincinnati, O.  
Electric Service Supplies Co., 200 Plymouth Bldg., Chicago.  
General Electric Co., Schenectady, N. Y.  
Macallen, The, Co., Boston.  
Marshall, R. W., & Co., 95 Liberty St., New York.  
Recording Fare Register Co., New Haven, Conn.  
Stuart-Howland Co., Boston.  
Western Electric Co., Chicago.
- Lock and Nut Washers.  
Grip Nut Co., 152 Lake St., Chicago.  
National Lock Washer Co., Newark, N. J.
- Lockers, Metal.  
Electric Service Supplies Co., 200 Plymouth Bldg., Chicago.
- Locomotives.  
Baldwin Locomotive Works, Philadelphia.  
Johns, F. A., 1624 Pierce Bldg., St. Louis.
- Locomotives, Electric.  
American Car Co., St. Louis.  
Baldwin Locomotive Works, Philadelphia.  
Brill, The J. G., Co., Philadelphia.  
General Electric Co., Schenectady, N. Y.  
Kuhlman, The G. C., Car Co., Cleveland.  
McGuire-Cummings Mfg. Co., Chicago.  
Stephenson, John, Co., Elizabeth, N. J.  
Wason Mfg. Co., Springfield, Mass.  
Westinghouse Elec. & Manufacturing Co., Pittsburg.
- Locomotives, Gasoline.  
Fairbanks, Morse & Co., Chgo.  
Stover Motor Car Co., Freeport, Ill.
- Lubricants.  
Dearborn Drug & Chemical Works, Chicago.  
Detroit Graphite Co., Detroit, Mich.  
Galena-Signal Oil Co., Franklin, Pa.  
U. S. Graphite Co., Saginaw, Mich.  
Whitmore Mfg. Co., Cleveland, O.
- Lumber.  
Barnes, G. H., Hardwood Lumber Co., St. Louis, Mo.  
Beidler, Francis, & Co., Chgo.  
Berthold & Jennings, St. Louis.  
Lindsey Bros. Co., Spokane, Wash.  
S-E. Missouri Cypress Co., Campbell, Mo.
- Malleable Iron.  
St. Louis Car Co., St. Louis, Mo.
- Measuring Tapes.  
Lucifer Rule Co., Saginaw, Mich.
- Mechanical Draft.  
Green Fuel Economizer Co., Matteawan, N. Y.
- Meters.  
Johns-Manville, H. W., Co., New York.  
Queen & Co., Philadelphia.  
Weston Electrical Instrument Co., Newark, N. J.



# Pay-As-You-Enter Cars



are successfully operated under widely varying conditions

**in Chicago**                      **in Buffalo**  
**in New York City**    **in Montreal**

Pay-As-You-Enter Cars have been inspected by many street railway men from other cities, and, so far as we are aware, no serious fault has been found, either by visitors or by officials of the operating companies.

But it would be better for you to inspect them personally and it is worth your while to make a trip to the nearest city named above. Then you will get first-hand information about the greatest improvement in the history of street railways. If you can't make the trip now, ask us for illustrated descriptions.

We license manufacturers and railways to build and use the Pay-As-You-Enter Car, the patents on which are owned by

**The Pay-As-You-Enter Car Company**

DUNCAN McDONALD,    26 Cortlandt Street, New York

President

THOS. W. CASEY,  
 Manager

## CLASSIFIED LIST OF ADVERTISERS—Continued.

- Molded Goods.  
Massachusetts Chemical Co.,  
Walpole, Mass.  
Wood, G. S., Great Northern  
Bldg., Chicago.
- Motor Cars, Gasoline.  
Stover Motor Car Co., Free-  
port, Ill.
- Motors, Electric.  
Cleveland Armature Works,  
Cleveland, O.  
Fairbanks, Morse & Co., Chgo.  
General Electric Co., Schene-  
cady, N. Y.  
National Brake & Electric Co.,  
Milwaukee.  
Roslter, MacGovern & Co., 17  
Battery Pl., New York.  
Western Electric Co., Chicago.  
Westinghouse Elec. & Manu-  
facturing Co., Pittsburg.
- Nut Locks.  
Grip Nut Co., 152 Lake St.,  
Chicago.  
National Lock Washer Co.,  
Newark, N. J.  
Railway Speciality & Supply  
Co., Chicago.  
St. Louis Car Co., St. Louis,  
Mo.  
U. S. Metal & Mfg. Co., 25  
Broad St., New York.
- Nuts and Bolts.  
Grip Nut Co., 152 Lake St.,  
Chicago.  
Lorain Steel Co., Philadelphia.  
National Lock Washer Co.,  
Newark, N. J.  
Railway Speciality & Supply  
Co., Chicago.
- Oilers.  
Armstrong Oiler Co., 31st and  
Chestnut St., Philadelphia.
- Oils—(See Lubricants).
- Overhead Equipment—(See Elec-  
tric Railway Supplies).
- Packings.  
Electric Service Supplies Co.,  
200 Plymouth Bldg., Chicago.  
Johns-Manville, H. W., Co.,  
New York.  
Power Speciality Co., 111  
Broadway, New York.
- Packing, Steel Wool Journal.  
Robertson, Wm., & Co., Gt.  
Northern Bldg., Chicago.
- Paints.  
Detroit Graphite Co., Detroit.  
Massachusetts Chemical Co.,  
Walpole, Mass.  
Standard Paint Co., 100 Will-  
iam St., New York.  
St. Louis Surfer & Paint  
Co., St. Louis, Mo.  
U. S. Graphite Co., Saginaw,  
Mich.
- Pay-As-You-Enter Cars.  
Pay-As-You-Enter Car Co., 26  
Cortland St., New York.
- Pipe Bands and Fittings—(See  
Steam Fittings).
- Plumbago.  
Detroit Graphite Co., Detroit,  
Mich.  
U. S. Graphite Co., Saginaw,  
Mich.
- Poles, Metal.  
Creaghead Engineering Co.,  
Cincinnati, O.  
Electric Railway Equipment  
Co., Cincinnati, O.  
Electric Service Supplies Co.,  
200 Plymouth Bldg., Chicago.
- Poles and Ties, Wood.  
Advance Lumber Co., Clevel-  
and, O.  
Barnes, G. H., Hardwood  
Lumber Co., St. Louis, Mo.  
Beidler, Francis, & Co., Chgo.  
Berthold & Jennings, St. Louis.  
Churchill Cedar Co., Spokane,  
Wash.  
Humbird Lumber Co., Sand  
Point, Idaho.  
Lindsay Bros. Co., Spokane,  
Wash.  
Naugle Pole & Tie Co., 226  
La Salle St., Chicago.  
Pacific Coast Pole Co., Spoka-  
ne, Wash.  
S-E, Missouri Cypress Co.,  
Campbell, Mo.  
Worcester, C. H., Co., Tribune  
Bldg., Chicago.
- Punches—(See Ticket Punches).
- Rail Benders.  
Electric Service Supplies Co.,  
200 Plymouth Bldg., Chicago.  
Fairbanks, Morse & Co., Chgo.
- Rail Bonds—(See Bonds, Rail).
- Rail Drills—(See Drills, Track).
- Rail Feed Wire—(See Wire and  
Cables).
- Rail Joints and Chairs—(See  
Joints, Rail).
- Rail Joints, Welded.  
Goldschmidt Thermit Co., 43  
Exchange Pl., New York.  
Lorain Steel Co., Philadelphia.
- Rails, New.  
Lorain Steel Co., Philadelphia.  
New York Switch & Crossing  
Co., Hoboken, N. J.  
Wharton, Wm., Jr., & Co.,  
Philadelphia.
- Rails, Relaying.  
Zelnicler, Walter A., Supply  
Co., St. Louis.
- Railway Equipment.  
Johann, F. A., 1624 Pierce  
Bldg., St. Louis.
- Railway Velocipedes.  
Fairbanks Morse & Co., Chgo.
- Registers and Fittings—(See  
Fare Registers).
- Relays.  
Weston Electrical Instrument  
Co., Newark, N. J.
- Roofing.  
Johns-Manville, H. W., Co.,  
New York.
- Rubber Goods, Mechanical.  
Wood, G. S., Great Northern  
Bldg., Chicago.
- Rubber Preservative.  
Wood, G. S., Great Northern  
Bldg., Chicago.
- Sand Apparatus.  
American Car Co., St. Louis.  
Brill, The J. G., Co., Phila-  
delphia.  
Electric Service Supplies Co.,  
200 Plymouth Bldg., Chicago.  
Kuhlman, The G. C., Car Co.,  
Cleveland.  
Marshall, R. W., & Co., 95  
Liberty St., New York.  
Ohio Brass Co., Mansfield, O.  
Ridion, Frank, Co., 200 Sum-  
mer St., Boston.  
St. Louis Car Co., St. Louis,  
Mo.  
Stephenson, John, Co., Eliza-  
beth, N. J.  
Wason Mfg. Co., Springfield,  
Mass.
- Sash Balances and Fixtures.  
National Lock Washer Co.,  
Newark, N. J.
- Sash Operating Devices.  
Drouvé, The G. Co., Bridge-  
port, Conn.  
Lord & Burnham, Irvington-  
on-Hudson, New York.
- Seats, Car—(See Car Seats).
- Shade Rollers—(See Curtains,  
Fixtures and Materials).
- Shutters, Steel Rolling.  
Kinner Manufacturing Co.,  
Columbus, O.
- Signals.  
Blake Signal & Manufacturing  
Co., Boston.  
Telegraph Signal Co., Roches-  
ter, N. Y.
- Signal Supplies.  
Railway Speciality & Supply  
Co., Chicago.
- Skylights.  
Drouvé, The G. Co., Bridge-  
port, Conn.  
Lord & Burnham, Irvington-  
on-Hudson, New York.
- Snow Plows, Sweepers and  
Scrapers.  
American Car Co., St. Louis.  
Brill, The J. G., Co., Phila-  
delphia.  
Kalamazoo Railway Supply  
Co., Kalamazoo, Mich.  
Kuhlman, The G. C., Car Co.,  
Cleveland.
- Snow Plows, Sweepers and  
Scrapers—Continued.  
McGuire-Cummings Mfg. Co.,  
Chicago.  
Russell Car & Snow-Plow Co.,  
Ridgway, Pa.  
Stephenson, John, Co., Eliza-  
beth, N. J.  
Wason Mfg. Co., Springfield,  
Mass.
- Sockets, Waterproof.  
Johns-Manville, H. W., Co.,  
New York.
- Splicing Compounds and Mate-  
rials.  
Massachusetts Chemical Co.,  
Walpole, Mass.
- Springes.  
American Car Co., St. Louis.  
Brill, The J. G., Co., Phila-  
delphia.  
Kuhlman, The G. C., Car Co.,  
Cleveland.  
McGuire-Cummings Mfg. Co.,  
Chicago.  
Marshall, R. W., & Co., 95  
Liberty St., New York.  
Railway Steel Spring Co., 71  
Broadway, New York.  
St. Louis Car Co., St. Louis,  
Mo.  
Stephenson, John, Co., Eliza-  
beth, N. J.  
Wason Mfg. Co., Springfield,  
Mass.
- Sprinkling Cars.  
American Car Co., St. Louis.  
Brill, The J. G., Co., Phila-  
delphia.  
Kuhlman, The G. C., Car Co.,  
Cleveland.  
McGuire-Cummings Mfg. Co.,  
Chicago.  
Stephenson, John, Co., Eliza-  
beth, N. J.  
Wason Mfg. Co., Springfield,  
Mass.
- Steam Apparatus.  
Green Fuel Economizer Co.,  
Matteawan, N. Y.
- Steam Fittings, Etc.  
Crane Co., Chicago.  
Davis, The John, Co., Chgo.  
Simmons, John, Co., 110 Cen-  
tre St., New York.  
Power Speciality Co., 111  
Broadway, New York.
- Steel Cars.  
American Car Co., St. Louis.  
Brill, The J. G., Co., Phila-  
delphia.  
Kuhlman, The G. C., Car Co.,  
Cleveland.  
St. Louis Car Co., St. Louis,  
Mo.  
Stephenson, John, Co., Eliza-  
beth, N. J.  
Wason Mfg. Co., Springfield,  
Mass.
- Steel Tapes.  
Lufkin Rule Co., Saginaw,  
Mich.
- Stokers.  
Babcock & Wilcox Co., 85 Lib-  
erty St., New York.  
Green Engineering Co., Com'l  
Nat. Bk. Bldg., Chicago.  
Model Stoker Co., Dayton, O.  
Under-Feed Stoker Co. of Am.,  
Chicago.  
Westinghouse Machine Co.,  
Pittsburg.
- Storage Batteries—(See Bat-  
teries).
- "Strike-Breakers."  
Drummond Detective Agency,  
3 Ann St., New York.
- Superheaters.  
Power Speciality Co., 111  
Broadway, New York.
- Switches, Frogs and Crossings—  
Continued.  
Anderson & J. M., Mfg.  
Co., Boston.  
Chase-Shawmut Co., New-  
buryport, Mass.  
General Electric Co., Schene-  
cady, N. Y.  
Western Electric Co., Chicago.  
Westinghouse Electric & Mfg.  
Co., Pittsburg.  
Weston Electrical Instrument  
Co., Newark, N. J.
- Switchboards and Switchboard  
Instruments.  
Anderson & J. M., Mfg.  
Co., Boston.  
Chase-Shawmut Co., New-  
buryport, Mass.  
General Electric Co., Schene-  
cady, N. Y.  
Western Electric Co., Chicago.  
Westinghouse Electric & Mfg.  
Co., Pittsburg.  
Weston Electrical Instrument  
Co., Newark, N. J.
- Tapes and Webbing.  
Hope Webbing Co., Provid-  
ence, R. I.  
Johns-Manville, H. W., Co.,  
New York.  
Massachusetts Chemical Co.,  
Walpole, Mass.  
Okonite Co., Ltd., 253 Broad-  
way, New York.
- Testing Instruments.  
Queen & Co., Philadelphia.  
Weston Electrical Instrument  
Co., Newark, N. J.
- Ticket Choppers and Destroyers.  
Patten, Paul B., Salem, Mass.
- Ticket Punches.  
Meyers, Fred J., Mfg. Co.,  
Hamilton, O.  
Woodman Mfg. & Sup. Co.,  
Boston.
- Ties and Poles, Wood—(See  
Poles and Ties).
- Timber.  
Beidler, Francis, & Co., Chgo.  
Lindsay Bros. Co., Spokane,  
Wash.  
S-E, Missouri Cypress Co.,  
Campbell, Mo.
- Tools, Pneumatic—(See Pneu-  
matic Tools).
- Track Cleaners and Scrapers.  
American Car Co., St. Louis.  
Brill, The J. G., Co., Phila-  
delphia.  
Kuhlman, The G. C., Car Co.,  
Cleveland.  
McGuire-Cummings Mfg. Co.,  
Chicago.  
Marshall, R. W., & Co., 95  
Liberty St., New York.  
Ohio Brass Co., Mansfield, O.  
Stephenson, John, Co., Eliza-  
beth, N. J.  
Van Dorn & Dutton Co.,  
Cleveland, O.  
Wason Mfg. Co., Springfield,  
Mass.
- Track Drills—(See Drills, Track).
- Tracklaying Machinery.  
Holman, D. P., Ry. Tracklayer  
Co., 1102 Ellisworth Bldg.,  
Chicago.
- Track Tools.  
Electric Service Supplies Co.,  
200 Plymouth Bldg., Chicago.
- Trimmings, Car.  
American Car Co., St. Louis.  
Brill, The J. G., Co., Phila-  
delphia.  
Curtain Supply Co., Park Row  
Bldg., New York.  
Kuhlman, The G. C., Car Co.,  
Cleveland.  
National Lock Washer Co.,  
Newark, N. J.  
St. Louis Car Co., St. Louis,  
Mo.  
Stephenson, John, Co., Eliza-  
beth, N. J.  
Wallace Supply Co., Chicago.  
Wason Mfg. Co., Springfield,  
Mass.  
Wood, G. S., Great Northern  
Bldg., Chicago.
- Trolley Guards.  
Electric Service Supplies Co.,  
200 Plymouth Bldg., Chicago.
- Trolley Poles and Fittings.  
General Electric Co., Schene-  
cady, N. Y.  
Johns-Manville, H. W., Co.,  
New York.  
Marshall, R. W., & Co., 95  
Liberty St., New York.

Experience of many traction companies has proved that the average cost of rail bond installation with this car is

## 12 Cents per Bond

and that the saving in cost over installation by pressure is about \$75.00 per mile.

Furthermore, our Electric Brazed and Copper Welded bonds are *better bonds*, both mechanically and electrically.

*Don't believe it without proof—but ask us for that.*

## The Electric Railway Improvement Co.

6005 Carnegie Avenue, Cleveland, Ohio

7

## Galena-Signal Oil Company

FRANKLIN, PA.

THEIR SPECIALTIES

**STREET RAILWAY LUBRICATION** including both rolling stock and power house equipment.

Same skillful *expert supervision* given in this service as in steam railway service has produced very satisfactory results. The business of our Street Railway Department has increased beyond every expectation. In 1906 this department sold ten times the number of barrels of oil sold by the same department in 1903.

We are under contract with many of the largest street and interurban railways of the country.

We guarantee *cost per thousand miles* in street railway service when conditions warrant it.

Write to Franklin, Pennsylvania, for further particulars.

**STEAM RAILWAY LUBRICATION** Sole manufacturers of the celebrated *Galena Coach, Engine and Car Oils* for steam railway lubrication. *Sibley's Perfection Valve Oil* for cylinder lubrication, and *Perfection Signal Oil* for use in railway signal lanterns.

**GALENA RAILWAY SAFETY OIL** Made especially for use in headlights, cab, classification and tail lights, and for switch and semaphore lamps. Burns equally well with the long time as with the one-day burner; with or without chimney as the burner requires. Is pure water white in color; high fire test, low cold test, and splendid gravity.

CHAS. MILLER, President

## Shawmut Soldered Railbonds

Are the Original Soldered Bonds 8 YEARS of Service Under ALL Conditions Prove Their RELIABILITY.



WHY Not Try a Proven Bond at Least

**SEND FOR OUR PROPOSITION**

See Bulletin No. 29

**CHASE-SHAWMUT CO.**

Newburyport, Mass.

CLASSIFIED LIST OF ADVERTISERS—Continued.

Trolley Retrievers and Catchers. Earl, C. L., Bowling Green Bldg., New York.  
 Electric Service Supplies Co., 1020-24 Filbert St., Phila.  
 Miloy Electric Co., Bucyrus, O.  
 Riddon, Frank, Co., 200 Summer St., Boston.  
 Trolley Supply Co., Canton, O.

Trolley Wheels—(See Trolley Poles and Fittings).

Trolley Wire—(See Wire and Cables).

Trolleys, Tract. Cleveland Armature Works, Cleveland, O.

Trucks, Car. American Car Co., St. Louis.  
 Baldwin Locomotive Works, Philadelphia.  
 Brill, The J. G., Co., Philadelphia.  
 Kuhlman, The G. C., Car Co., Cleveland.  
 McGuire-Cummings Mfg. Co., Chicago.  
 St. Louis Car Co., St. Louis, Mo.  
 Standard Motor Truck Co., Pittsburg, Pa.  
 Standard Varnish Works, New York City.  
 Stephenson, John, Co., Elizabeth, N. J.  
 Van Dorn & Dutton Co., Cleveland, O.

Trucks, Car—Continued. Wason Mfg. Co., Springfield, Mass.

Turbines. General Electric Co., Schenectady, N. Y.  
 Westinghouse Machine Co., Pittsburg, Pa.

Valves—(See Steam Fittings).

Varnish. Electric Service Supplies Co., 200 Plymouth Bldg., Chicago.  
 Harrison Elec. & Mfg. Co., 169 South St., New York.  
 Marshall, R. W., & Co., 95 Liberty St., New York.  
 Massachusetts Chemical Co., Walpole, Mass.  
 Miloy Electric Co., Bucyrus, O.  
 Nuttall, R. D., Co., Pittsburg, Riddon, Frank, Co., 200 Summer St., Boston.  
 Standard Paint Co., 100 William St., New York.  
 Star Brass Works, Kalamazoo, Mich.  
 Trolley Supply Co., Canton, O.  
 Wallace Supply Co., Chicago.  
 Westinghouse Electric & Mfg. Co., Pittsburg, Pa.

Ventilators. Drouvé, The G., Co., Bridgeport, Conn.  
 Lord & Burnham, Irvington-Hudson, New York.

Vestiettes. Balmey Vestiette Mfg. Co., Cleveland, O.

Waste, Cotton and Wool. Hagy, J. Milton, Waste Wks., Philadelphia, Pa.  
 Railway Specialty & Supply Co., Chicago.

Water Softening Apparatus. Dearborn Drug & Chemical Works, Chicago.

Wheels and Axles. American Car Co., St. Louis.  
 Brill, The J. G., Co., Philadelphia.  
 Griffin Wheel Co., Chicago.  
 Kuhlman, The G. C., Car Co., Cleveland.  
 Lorain Steel Co., Philadelphia.  
 McGuire-Cummings Mfg. Co., Chicago.  
 Marshall, R. W., & Co., 95 Liberty St., New York.  
 Railway Steel-Spring Co., New York.  
 St. Louis Car Co., St. Louis, Mo.  
 St. Louis Car Wheel Co., St. Louis, Mo.  
 Standard Steel Works, Philadelphia.  
 Stephenson, John, Co., Elizabeth, N. J.  
 Wason Mfg. Co., Springfield, Mass.

Wheel Grinders. Wheel Truing Brake Shoe Co., Detroit, Mich.

Whitewashing Machines. Wallace Supply Co., Chicago.

Window Fixtures. Drouvé, The G., Co., Bridgeport, Conn.

Wiping Rags. Hagy, J. Milton, Waste Wks., Philadelphia, Pa.

Wire, Aluminum. Aluminum Co. of America, Pittsburg, Pa.

Wire, Insulated. Aluminum Co. of America, Pittsburg, Pa.  
 American Electrical Works, Providence, R. I.  
 General Electric Co., Schenectady, N. Y.  
 Okonite Co., Ltd., 253 Broadway, New York.  
 Standard Underground Cable Co., Pittsburg, Pa.  
 Stuart-Howland Co., Boston.

Wire and Cables. Aluminum Co. of America, Pittsburg, Pa.  
 American Electrical Works, Providence, R. I.  
 Bridgeport Brass Co., Bridgeport, Conn.  
 General Electric Co., Schenectady, N. Y.  
 Okonite Co., Ltd., 253 Broadway, New York.  
 Standard Underground Cable Co., Pittsburg, Pa.

**TROLLEY WIRE, BARE COPPER CABLES  
 WEATHERPROOF WIRE AND CABLES**

RUBBER COVERED CABLES AND LEAD COVERED UNDERGROUND CABLES FOR ANY SERVICE. WRITE US FOR SPECIAL PRICES AT THIS TIME.

**STANDARD UNDERGROUND CABLE CO.**

Pittsburg New York Boston St. Louis San Francisco Chicago Philadelphia Los Angeles Atlanta

**PNEUMATIC TOOL AIR BRAKE and FIRE HOSE**

**GUILFORD S. WOOD**

ELECTRIC RAILWAY NECESSITIES

Great Northern Bldg., Chicago

**Your Wife Will Laugh**

if you tell her that you purchase electric tape by the pound. When she goes shopping, yardage and quality direct her. Our No. 264 ELECTRIC TAPE is the highest quality obtainable and the greatest yardage per pound. But don't lose sight of the yardage. Your jobber will supply you if you insist. Write for quotations.

**MASSACHUSETTS CHEMICAL COMPANY**

Operates  
 Walpole Varnish Works  
 Walpole Rubber Works

PLANT: WALPOLE, MASS.

Waste for Electric Railway Service

**Motor Packing Waste**

Free from dirt and grit. Easy to pack. All long strands. Good absorber. One packing of the journal box will last longer than with the ordinary waste.

**WIPING WASTE**

White and colored sanitary cleaned wiping rags. Samples submitted.

**The J. Milton Hagy Waste Works**

433 Spruce St. INCORPORATED Philadelphia

**THE BABCOCK & WILCOX COMPANY**

85 Liberty Street, New York

Babcock & Wilcox — Stirling — A & T Horizontal — Cahall Vertical

**WATER TUBE STEAM BOILERS**

Works: Bayonne, N. J. Barberton, Ohio.

BRANCH OFFICES:

BOSTON, Delta Bldg.  
 PHILADELPHIA, 110-1112 North American Bldg.  
 SAN FRANCISCO, 63 First Street  
 PITTSBURGH, Farmers Deposit Nat. Bank Bldg.  
 NEW ORLEANS, 345 Baronne St.

DENVER, 410 Seventeenth St.  
 SALT LAKE CITY, 313 Atlas Block  
 WASHINGTON, Colorado Building  
 CHICAGO, Marquette Bldg.  
 ATLANTA, Ga., 1132 Candler Bldg.

CLEVELAND, 706 New England Bldg.  
 MEXICO CITY, 7 Avenida, Juarez  
 HAVANA, CUBA, 1164 Calle de la Habana  
 LOS ANGELES, 321 Trust Bldg.  
 CINCINNATI, O., Traction Bldg.

STEAM SUPERHEATERS

MECHANICAL STOKERS

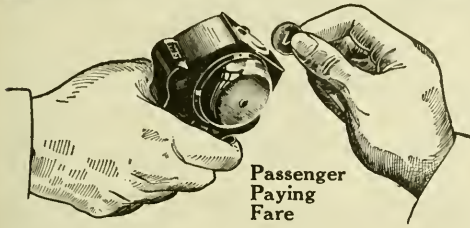

Passenger Paying Fare

Every nickel collected is registered before reaching the conductor's hand when you use the

# Rooke Automatic Fare Collector

The Rooke System is a revolution in fare-collecting methods, and as far superior to old systems as the trolley car is to the horse car.

Why not ask us to prove it?

**Rooke Automatic Register Co.**  
PROVIDENCE RHODE ISLAND

3

# TUBULAR POLES IRON OR STEEL



FOR  
**ELECTRIC RAILWAYS**  
**ELECTRIC LIGHTING CO'S**  
 SIGNAL )  
 TELEPHONE )  
 TELEGRAPH )  
**TRANSMISSION**  
**L I N E S**  
 AND  
**CATENARY**  
**SUSPENSION**  
**L I N E S**

**ELECTRIC RAILWAY EQUIPMENT CO.**  
 General Office: CINCINNATI-O. U.S.A.  
 Shops: READING PA - WHEELING WVA

# RE-ENFORCED SPOKE WHEELS

For City and Suburban Cars

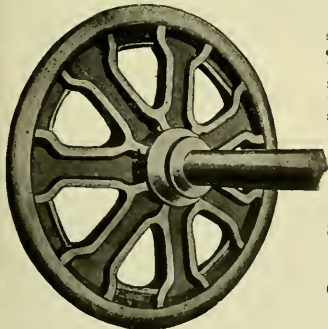

This wheel is being substituted in place of the Old Style Plate Wheel because it does not rumble and roar when on paved city streets.

The only spoke wheel for Heavy High Speed Service.

- Stronger Spokes
- Stronger Flange
- Deep, Even Chill
- Greater Mileage
- Absolute Safety

A Sample Order Will Prove Its Superiority Over the Old Style Spoke Wheel

WRITE FOR BOOKLET ON WHEELS

**ST. LOUIS CAR WHEEL CO.**  
ST. LOUIS, MO.

# THE Van Dorn & Dutton Co.

CLEVELAND, OHIO

MANUFACTURERS OF

# GEARS AND PINIONS

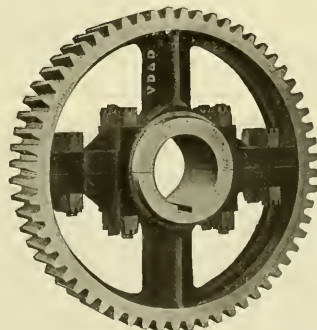

For All Types of Motors

HIGHEST QUALITY

# Hart Convertible CONSTRUCTION BALLAST and GONDOLA CAR



A Center-Dump, Side-Dump and Flat-Bottom Gondola-All in One

Diagonal shading shows position of ballast after being spread by the Rodger Distributing Car which follows the hopper cars

## Rodger Ballast Car Co. Railway Exchange, CHICAGO.

### Avoid Accidents By Using This Switch



## Anti-Straddling or Anti-Kicking Tongue Switch

It will not drive down at the heel, because it is held to either side with a spring tension and firmly down on its bed. A car can not straddle this tongue.

SPECIAL TRACK WORK OF EVERY DESCRIPTION

### New York Switch & Crossing Co.

HOBOKEN, N. J.

WRITE FOR SPECIAL CIRCULAR

## Special Work for Street Railways



Switches and Crossings with Hard Steel Centers

Mates

Frogs

PATENTED OCT. 4, 1892

Cast Weld Compromise Rail

### Barbour - Stockwell Co., 205 Broadway, Cambridgeport, Mass.

# WHARTON SPECIAL TRACK WORK

OF EVERY DESCRIPTION FOR ALL CLASSES OF SERVICE

## WM. WHARTON JR. & CO.

INCORPORATED.

PHILADELPHIA, PA. JENKINTOWN, PA.

MANGANESE STEEL TRACK WORK IS OUR SPECIALTY

# FOR SALE. FOR QUICK DELIVERY

## 6 55-ft. Passenger, Baggage and Smoking Car Bodies

Main Compartment 26' 0"  
 Smoking " 10' 6"  
 Baggage " 10' 0"  
 Seating Capacity, 54

## 8 60-ft. Passenger, Baggage and Smoking Car Bodies

Main Compartment 28' 6"  
 Smoking " 11' 0"  
 Baggage " 8' 0"  
 Seating Capacity, 58

## 5 52-ft. Passenger and Smoking Car Bodies — Double End

Seating Capacity, 60

## 3 52-ft. Passenger and Baggage Car Bodies — Double End

Seating Capacity, 56

## 2 50-ft. Express Car Bodies

*Write or wire us for further information.*

# The Jewett Car Co. Newark Ohio

## THE MIGHTY HOT WATER CAR HEATER

Adapted for Large Electric Cars and Long Distance Lines. Exclusively used on Largest Electric Systems. Ask for Catalog  
**THE WILLIAM C. BAKER HEATING & SUPPLY CO., 143 LIBERTY STREET NEW YORK**



## NILES CARS

(The Electric Pullmans)

LARGE, FAST INTERURBANS  
 OUR SPECIALTY

## Niles Car & Mfg. Co.

Works: NILES, OHIO

Sales Office: J. A. HANNA CO.  
 312 Electric Bldg., Cleveland, Ohio

# Steel Passenger Cars and Trucks

For Steam and Electric Railways

Steel and Composite Freight Cars for all Classes of Service

# Pressed Steel Car Co.

NEW YORK, PITTSBURGH, CHICAGO, ST. LOUIS, ATLANTA, MEXICO CITY, BUENOS AIRES, SYDNEY, N.S.W.

You cannot expect electric railway buyers to inform themselves regarding your products. Life is too short!

You yourself must give buyers the information they ought to have and make upon them those impressions that lead to sales.

And the best method—best because it is direct and economical—is advertising, real advertising in the **ELECTRIC RAILWAY REVIEW**.

To do real advertising, you must plan it as an important part of your selling scheme. Every advertisement should be so designed as to accomplish a certain, definite result. Each individual advertisement may not give evidence of having accomplished that result, but it most certainly will not come anywhere near hitting the mark unless it is carefully aimed in the right direction.

In short, pay attention to your advertising and the advertising will pay you for the attention!

All advertisers in the **ELECTRIC RAILWAY REVIEW** are at liberty to call upon our Advertisers' Copy Service for aid in preparing or handling their advertising in this publication. No charge for this co-operative work, and a brief letter will start it going.

# Electric Railway Review

160 Harrison Street, Chicago



# THE BOILERS WILL BE OUT OF SERVICE

a much shorter time for washing, thereby requiring very much less labor, to say nothing of the saving in fuel and the increased efficiency of the boilers, if the incrusting solids and other deleterious salts in the water are acted upon by **Dearborn Compounds** and their injurious properties destroyed. Send us gallon sample of your feed water for analysis.

## Dearborn Drug & Chemical Works

WM. H. EDGAR, FOUNDER

299 BROADWAY, NEW YORK      POSTAL TELEGRAPH BLDG., CHICAGO



Established 1877.



### ALBERT & J. M. ANDERSON MFG. CO.,

Makers of

**ELECTRICAL APPLIANCES:  
SWITCHES, SWITCHBOARDS,  
TIME SWITCHES, LINE MATERIAL,  
COPPER CASTINGS (75%) CONDUCTIVITY.**  
289-293 A ST., BOSTON, MASS., U. S. A.

Branches: Chicago, 175 Dearborn Street.  
Agencies: New York, 135 Broadway.

Boston, Pettingell-Andrews Co.      San Francisco, Eccles & Smith Co.  
New York, R. W. Marshall & Co.      Atlanta, Newcomer-Manry Co.  
St. Louis, J. C. White.      Denver, E. M. Mossiter.  
Toronto, Ont., H. J. Surtees.



## Queen Testing Sets

"The Recognized Standard"

Voltmeters  
Ammeters  
Switchboard  
and Portable  
Alternating  
and Direct  
Current



Queen Acme Testing Set

U. S. Stand-  
ard Testing  
Sets  
Rail Bond  
Testers  
Galvanom-  
eters, etc., etc.  
Electrical  
Instruments for  
All Purposes

**QUEEN & CO., Inc., Philadelphia, Pa.**

## Whitmore's Gear Protective Composition

will eliminate all of the difficulties and disagreeable features that many complain to us they experience when using other material. It does not become fluid in hot weather, and will not absorb power in cold weather. Try it and be convinced.

**The Whitmore Manufacturing Company**  
Cleveland, Ohio, U. S. A.

## WESTON Standard Portable Direct-Reading



Voltmeters  
Millivoltmeters  
Voltammeters  
Ammeters  
Millammeters  
Ohmmeters  
Ground Detectors  
and Circuit Testers

Our STATION VOLTMETERS and AMMETERS are unsurpassed in point of extreme accuracy and lowest consumption of energy.

**WESTON ELECTRICAL INSTRUMENT CO.**

Main Office and Works: Waverly Park, Newark, N. J.

London Branch: Audrey House, Ely Place, Holborn, Paris, France: E. H. Cadot, 12 Rue St. Georges, New York Office: 74 Cortlandt St. Berlin: European Weston Electrical Instrument Co., Ritterstrasse, No. 88.

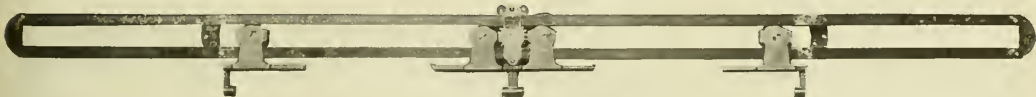

## The "WALLACE" Double Door Fixture

Built so well mechanically it cannot help but run easily

The "Wallace" Fixture has all the good points that make easy-running and noiseless double doors—but it has no chains or cables to stretch, no hanger plates exposed to view, nothing to bind or get out of alignment, no parts that wear out quickly. For other good points see Bulletin No. 3, sent free.

26 CORTLANDT ST.  
NEW YORK

**WALLACE SUPPLY COMPANY**

19 S. JEFFERSON ST.  
CHICAGO

For CABLE, ELECTRIC and ELEVATED CARS

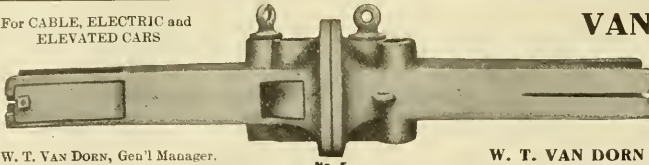

### VAN DORN AUTOMATIC COUPLERS

The records go farther than talk. Look up the records. Send for booklet of information on Couplings.

W. T. VAN DORN, Gen'l Manager.

No. 5

W. T. VAN DORN COMPANY, 1076 S. Paulina Street, CHICAGO

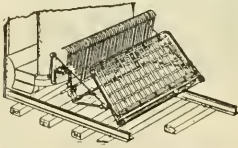

### ECLIPSE Life Guard

Manufactured by the ECLIPSE RAILWAY SUPPLY CO. Cleveland, Ohio



Jobbers who publish a new catalogue should have one of our cuts.

THE ATLAS ANCHOR CO., Cleveland, Ohio

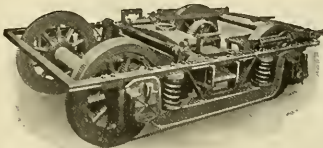
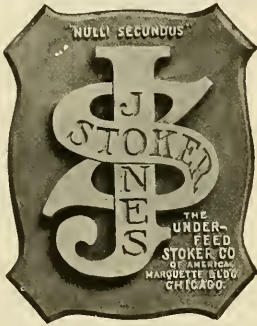

### BALDWIN LOCOMOTIVE WORKS

BURNHAM, WILLIAMS & CO., PHILADELPHIA, PA., U. S. A.

Builders of LOCOMOTIVES OF EVERY DESCRIPTION Including ELECTRIC LOCOMOTIVES and

### ELECTRIC TRUCKS



Truck built for Indianapolis, New Castle & Toledo Electric Railway Company.

### STANDARD STEEL WORKS, HARRISON BUILDING PHILADELPHIA, PA.

SOLID FORGED ROLLED AND STEEL TIRED WHEELS ELLIPTIC AND COIL SPRINGS mounted on axles and fitted with Motor Gears for Electric Railway Service

PIPE FITTINGS AND VALVES FOR THE HEATING AND PLUMBING TRADE

TRADE  MARK

JOHN SIMMONS CO. 104-110 Centre Street, NEW YORK

### THE LORAIN STEEL COMPANY

Girder Rails and High Tee Rails High-Grade Special Track Work

GENERAL OFFICES THE PENNSYLVANIA BUILDING, PHILADELPHIA, PA.

### A Cooper Heater

will heat eight cars satisfactorily for the same cost of operating one car with the electric heater. It pays for itself.

*Ask us to prove it*

The Cooper Heater Co., Dayton, Ohio

10

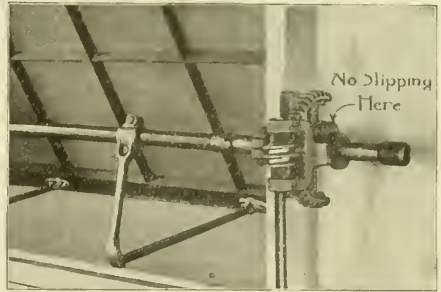

### The Ventilation

of your Shops, Foundries and Car-Barns is made especially effective by a speedy, positive and easily manipulated

### Sash Operating Apparatus

which automatically locks the sash at any position. *Let us send you our catalogue*

**LORD & BURNHAM COMPANY**  
Irvington-on-Hudson, N. Y.

## TRACK DRILLS

MADE IN TWO SIZES

With automatic friction feed. Lower gears cased in to protect them from dirt.

Send for circular and prices.

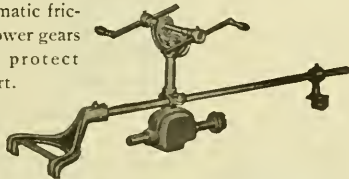

**FRANCIS REED CO.** WORCESTER, MASS.

One cent a word for want ads in the Electric Railway Review

# How to Secure a Position Through Advertising:

**First**, tell exactly the kind of position you want.

**Second**, tell in detail why you believe you can fill the position satisfactorily.

**Third**, give such other facts as you would care to know if you were in your prospective employer's place and considering an advertisement

making application for a position.

**Fourth**, don't expect one insertion of an ad to bring you the best job you ever had. Order your ad inserted several times. If you secure a position before all insertions have been made, the amount paid for the unused space will be refunded on request.

*At the top of the following page you will find complete information about classified advertisements in the ELECTRIC RAILWAY REVIEW. Your order will receive careful attention. Send it to*

**Electric Railway Review** 160 Harrison St. **Chicago**

# CLASSIFIED ADVERTISEMENTS

Undisplayed advertisements are inserted under this heading at the uniform rate of one cent a word; minimum charge twenty-five cents. Replies directed to this office will be forwarded when required to any address in the United States, Canada or Mexico without extra charge. Advertisements received at the Chicago office by 9 a. m. Thursday will appear in the issue for the same week.

## POSITIONS WANTED.

Master mechanic wants position with interurban city road, medium-sized preferred. Wide and thorough experience in all branches; can also do armature winding and switchboard work. Address "No. 542," care Electric Railway Review, Chicago.

Position as superintendent of city or interurban line wanted by a man of 15 years' experience in both construction and operation. Best of references as to ability and habits. Open for engagement after February 1. Address "No. 541," care Electric Railway Review, Chicago.

Wanted—Position with interurban road by an engineer having eight years' experience in power station and general railway design and construction work. Age 33; best references furnished. Prefer position with road now under construction. Address "No. 534," care of Electric Railway Review, Chicago.

Position of chief motorman or instructor by a first-class competent man who has had 12 years' experience in that line. Thoroughly understands economy in regard to use of power and care of rolling stock; familiar with quadruple equipments and air brakes; highest references. Address "Chief Motorman," care of Electric Railway Review, Chicago.

Position wanted—The manager of a large railway, lighting and gas plant must make a change in his position owing to an unfavorable climate. Has held managerial position with 10 years and is thoroughly familiar with the construction, organization and operation of electric railways. Correspondence solicited. Exceptional references. Address "No. 539," care of Electric Railway Review, Chicago.

Position Wanted—Have had wide experience in all kinds of street railway work, estimating, specifications, superintending and directing, overhead, underground and power station construction. Have for three years been superintendent of lines for large Massachusetts railway company. Technical education. Nine years' experience. Age 30 years. Wide acquaintance. Best of references. Address "No. 532," care of Electric Railway Review, Chicago.

## POSITIONS WANTED.

Graduate civil engineer, Cornell University 1902, experienced in field work and trade journalism, now engaged, desires work with technical journal or publicity department of manufacturing establishment. Address "No. 525," care of Electric Railway Review, Chicago.

Position wanted by first-class engineer and machinist with 16 years' practical experience with compound Corliss engines, Allis-Chalmers and Westinghouse steam turbines, surface condensers, A. C. and D. C. electrical apparatus. Age 35. All references. Address "No. 532," care of Electric Railway Review, Chicago.

Experienced and efficient engineer with power station experience (both planning and construction, as chief engineer and as superintendent of construction) desires position with operating company as engineer, assistant to manager or superintendent. Address "No. 515," care of Electric Railway Review, Chicago.

Young man, 30 years of age, who has nearly completed a course of "Electric Lighting and Railway" in the International Correspondence Schools, desires position which will give him practical experience in power house and switchboard work. Willing to start at a nominal salary. Address "No. 528," care of Electric Railway Review, Chicago.

An engineer, experienced in the handling and organizing of station crews, with 10 years' experience as chief engineer in both construction and operation, as well as reconstructing old ones on a modern basis. All voltages up to 15,000, both railway and lights. Salary or per cent, depends on results. I am looking for a reputation as well as salary. Address "No. 536," care of Electric Railway Review, Chicago.

## POSITIONS OPEN.

Superintendents, engineers, draftsmen, street railway, electrical, mechanical. Positions open. Write for free list and information, HAPGOODS, 305 Hartford Bldg., New York, or 1010 Broadway, New York, or 1010 Hartford Bldg., New York.

## POSITIONS OPEN.

Wanted—By a large street railway and lighting company, having 14 storerooms, a thoroughly experienced man, capable of taking inventories. Permanent position. Must be able to furnish best of references as to character and ability. Address "No. 538," care of Electric Railway Review, Chicago.

Master mechanic for a property having 150 to 200 cars. Must be experienced, practical and able to run shop on economical basis. Opportunity for good man to make a record. Prefer someone from middle west. Salary \$125 to \$150. Address "No. 537," care Electric Railway Review, Chicago.

Young man wanted to begin work at once as assistant claim agent by a large interurban system in western Pennsylvania. Man of some experience preferred. Must be able to look after office work satisfactorily, as well as to make investigations and adjustments. Address "No. 540," care Electric Railway Review, Chicago.

## BOOKS AND PUBLICATIONS.

Ask us about any book on electric railway and allied subjects. We publish some and sell all that are in print. The Wilson Company, 160 Harrison Street, Chicago.

Wanted—Copy of the Electric Railway Review of January 12, 1907, in good condition. State price in your answer. Address "No. 530," care of Electric Railway Review, Chicago.

Copies of the Street Railway Review of March and April, 1904, in good condition for binding are wanted. State price sent care Electric Railway Review, Chicago.

A copy of "The Motorman and His Duties," the standard handbook on the theory and practice of electric car operation, is worth many times its cost to every man interested in the subject. Send for 16-page pamphlet of sample pages. The Wilson Company, 160 Harrison Street, Chicago.

## MISCELLANEOUS WANTS.

Want to buy second-hand equipment, machinery or material? A card inserted in the Electric Railway Review, stating just what you want, will bring immediate response. The cost is small—only \$1 an inch (measuring 1 inch deep by 1½ inches wide) per insertion. Send orders to Electric Railway Review, 160 Harrison St., Chicago.

What have you to sell in the way of second-hand equipment, machinery or material? Buyers read the "For Sale" cards on the following page and there is the place to tell your story. "For Sale" cards are inexpensive—only \$1.20 an inch (measuring 1 inch deep by 1½ inches wide) per insertion. Special rates on contracts for 100 inches or more to be used within one year. Now is the time to send your order to Electric Railway Review, 160 Harrison St., Chicago.

## BOOKS AND PUBLICATIONS.

Copies of the Street Railway Review of January and February, 1906, are wanted. Name condition and price. Address "No. 535," care of Electric Railway Review, Chicago.

We want your friends to read the Electric Railway Review. You will do them—and us—a favor by sending their addresses. We will gladly mail free sample copies. Electric Railway Review, 160 Harrison Street, Chicago.

Interstate commerce national legislation to July 1, 1906, is fully covered in our reference pamphlet. It contains the full text of the act to regulate commerce as amended, including the Elkins and Hepburn acts, and of the supplementary act relating to the testimony of witnesses before the interstate commerce commission. It also contains the texts of the expedition act, the anti-trust act of 1890, the employers' liability act and the safety equipment laws. Difference in type shows the parts expunged from, and the parts added to, the interstate commerce and Elkins acts by the Hepburn act. This pamphlet is of special value to railway men and lawyers. Mailed prepaid for 25 cents in stamps or coin. Special prices for quantities. The Wilson Company, 160 Harrison St., Chicago.

## If You Have a Position for a High Grade Man

you can quickly secure his services in one of two ways

- by answering "Positions Wanted" advertisements on this page, or
- by advertising on this page under the heading, "Positions Open"

*Either plan will prove a winner—try it now*

**ROSSITER, MACGOVERN & CO. (Inc.)**  
 90 West Street, New York  
**ENGINES** Boilers, Locomotives, Cars,  
 New and **GENERATORS** 2nd Hand  
 Transformers, Railway, A. C. & D. C. **MOTORS**

**R.W. MARSHALL & CO.**  
 85 and 97 Liberty St., New York  
 Second-Hand Machinery and Equipment  
**ELECTRIC RAILWAY MATERIALS**

One cent a word  
 for want ads in  
 the Electric Rail-  
 way Review.

**NO SNOW TO DELAY CARS**  
 \* The Russell Snow-Plow is used by more than 50 roads to maintain schedules and prevent blockades. Russell Car & Snow-Plow Co., Ridgway, Pa. Wendell & MacDuffie, Cortlandt St., New York; C. A. Halston, Fisher Bldg., Chicago; Robinson & Cary Co., Saint Paul.  
**IF YOU HAVE A RUSSELL**

**RAILS**  
*Locomotives, Cars, Etc.*  
 Bought & Sold  
 Walter F. ZELNICKER Supply Co.  
 15 ST. LOUIS

**FOR SALE CHEAP!**  
 One 14x22 eight-wheel locomotive  
 Ten 34-foot 50,000 capacity flat cars  
 Two Greenleaf turntables  
 70 box cars, 40 and 50,000 capacity  
 80 Good Second-hand Bridges  
 Specifications and Blue Prints on application  
**F. A. JOHANN**  
 1624 Pierce Bldg., St. Louis, Mo.

**WHEEL TRUING BRAKE SHOES**  
 Repair Crippled Wheels While Running  
**THE WHEEL TRUING BRAKE SHOE CO.,** Detroit, Mich.

**FOR SALE: Three Car Bodies and Three Pairs of Double Trucks**  
 with or without electric equipment and air brakes; all new and never used. Compelled to sell, as these cars will not operate over a leased line by reason of their width and length.  
**R. W. MARSHALL & CO.,** 97 Liberty St., New York, N. Y.

The Recording Fare Register Company  
  
 New Haven, Conn.

**BRAKESHOES**  
 STANDARD BRAKESHOE COMPANY  
 GEN'L OFFICES & WORKS - AURORA, ILL. - CHICAGO OFFICE 35 RY ENCL.

**WAKEFIELD CAR SEATS**  
 We make everything necessary to seat a car of any description. Our line includes Reversible seats of both the Slideover and Turnover types for Steam and Electric service, as well as the only practical Double Revolving seat on the market.  
 Our Longitudinal Spring Seating is unexcelled for superiority of workmanship and durability. We also carry a large variety of Rattan Chairs for Parlor and Observation Cars.  
**Heywood Brothers & Wakefield Company**  
 New York, N. Y. Wakefield, Mass.

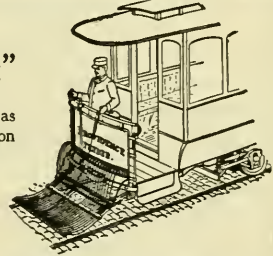

**"Not an Experiment"**  
 The Providence Fender has been in successful operation on hundreds of roads for 13 years, and has proved itself reliable under all conditions of Street Railway service.  
  
**CONSOLIDATED CAR FENDER COMPANY**  
 Office and Factory: PROVIDENCE, R. I.  
 Branch Office: 110 E. Twenty-third St., New York  
 European Agents: Comptoir d'Electricite, 6 Rue Boudreau, Paris, France

**Gasoline** Motor Cars for Street Car Service  
 Can be used advantageously for owl car service and on branch lines of large railroads where the passenger traffic does not warrant the maintenance of a regular train schedule.  
 Address R. R. Dept. No. 757 MS.  
**Fairbanks, Morse & Co.**  
 CHICAGO, ILLINOIS

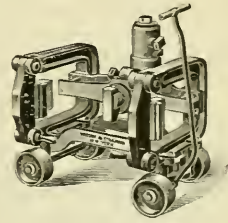
**Girder Rail Benders**  
 THIS rail bender is made in two sizes and will bend any section of rail now on the market. These tools are all portable and mounted on wheels.  
  
 Our tools thoroughly guaranteed  
**THE WATSON-STILLMAN CO.**  
 26 Cortlandt Street, New York City  
 Branch Office, 453 The Rookery, Chicago, Ill.

**THE ARNOLD COMPANY**  
 ENGINEERS—CONSTRUCTORS  
 ELECTRICAL — CIVIL — MECHANICAL  
 181 LA SALLE STREET  
 CHICAGO

**A. L. REGISTER & CO.**  
 Engineers and General Contractors—Electric Railways  
 112 North Broad St. PHILADELPHIA, PA. Established 1889

**SHIMER & CHASE CO.**  
 Experienced Promoters of Electrical Railway Projects  
 Correspondence Solicited OMAHA, NEB.

**H. M. Bylesby & Company**  
 Incorporated  
 ENGINEERS  
 American Trust Bldg., Chicago  
 Design, Construct and Operate  
 Railway, Light, Power and  
 Hydraulic Plants EXAMINATIONS AND  
 REPORTS

**SMITH CONCRETE MIXER**  
 does the work better, quicker, cheaper and lasts longer.  
**CONTRACTORS' SUPPLY & EQUIPMENT COMPANY**  
 Old Colony Building, Chicago 170 Broadway, New York 9

**CENTRAL INSPECTION BUREAU**  
 Inspection of Rails, Ties, Cars, Motors, Bridges, Buildings, Etc.  
 17 STATE STREET - - - - NEW YORK CITY

**J. G. WHITE & COMPANY**  
 INCORPORATED  
**Engineers, Contractors**  
 43-49 Exchange Place,  
 41-43 Wall Street New York, N. Y.  
 Principal Philippine Office: Manila, P. I.

**LINE MATERIAL**  
 ELECTRIC SUPPLIES FOR RAILWAYS, POWER PLANTS, ETC.  
 THE CREAGHEAD ENGINEERING CO., 348 Main Street, Cincinnati, Ohio

WRITE TO **MODEL STOKER COMPANY** DAYTON OHIO  
 for detailed information about the best  
**AUTOMATIC SMOKELESS FURNACE**

**Ford, Bacon & Davis,**  
 Engineers,  
 115 BROADWAY,  
 NEW YORK.

**GRIFFIN WHEEL CO.**  
 CHICAGO  
 CHILLED IRON CAR WHEELS IRON OR STEEL AXLES

SPRINGS—TIRES—STEEL-TIRED WHEELS  
**RAILWAY STEEL-SPRING CO.**  
 General Offices: 71 Broadway, New York

**COLUMBIA CONSTRUCTION CO.**  
 BUILDERS OF  
**Electric Railways**  
 Colby and Abbot Building : MILWAUKEE, Wis.

**HEINE SAFETY BOILER CO.**  
 421 OLIVE STREET, ST. LOUIS, MO.  
 Manufacturers of WATER TUBE BOILERS

**ELECTRIC HEATERS** For All Classes  
 of Cars  
 New York Consolidated Car-Heating Co. Chicago

VALVES—FITTINGS—STEAM SPECIALTIES  
**CRANE CO.**  
 CHICAGO  
 ESTABLISHED 1855

**HOPE TAPES AND WEBBINGS**  
 ARE THE BEST  
 WRITE FOR SAMPLES AND PRICES  
**HOPE WEBBING CO., Providence, R. I.**

**STONE & WEBSTER ENGINEERING CORPORATION**  

---

**CONSTRUCTING ENGINEERS**  

---

 147 MILK STREET, BOSTON  
 ELECTRIC RAILWAY, LIGHT & POWER PLANTS  
 WATER POWER DEVELOPMENTS



**GREEN FUEL ECONOMIZER CO.**  
 Sole builders of the Green Fuel Economizer in the United States. Also Fans, Blowers and Exhausters, Steam Heating Coils and the Green Air Heater. Heating, Ventilating and Mechanical Draft Apparatus. Send for Book "S.V." on Fuel Economy and Fan Catalogue.  
**GREEN FUEL ECONOMIZER CO., Matteawan, N. Y.**



THE  
EARLL  
RETRIEVERS

Perfect in design and construction.  
Absolute protection to poles  
and overhead work.  
Easy to maintain and convenient  
to operate.

Send for 20-Page Catalogue.

C. I. EARLL, Bowling Green Bldg., NEW YORK



The Motorman  
Behind This  
Headlight

can see a car approaching from  
the opposite direction *much  
sooner* than he would be able  
to see either the reflected or  
direct rays of an ordinary  
headlight.

*Reason:* Because of the pe-  
culiar construction of the *Climax  
Headlight* a portion of the re-  
flected rays of light is projected  
upward, while its most powerful  
light is thrown ahead.

*Result:* Safer operation and a  
great reduction in the probability of  
accident.

WRITE TODAY FOR CATALOG

TROLLEY SUPPLY CO.

Canton, O.



Factory of The Milloy Electric Company  
Bucyrus, Ohio

The Milloy Trolley Base

built in our new and specially equipped  
factory, insures a quality which will give ex-  
cellent service under ordinary and extraor-  
dinary conditions.

The Milloy Base is unusually low, has even  
tension on high or low wire. Has no ful-  
crum, no friction, no oil, no center post.  
Always efficient. Particulars on request.

THE MILLOY ELECTRIC COMPANY  
Bucyrus, Ohio

The Macallen Company

Formerly The W. T. C. Macallen Co.

Electric Railway  
Material

Brass Founders



Foundry and Division Streets, BOSTON, MASS.

# The Lindsley Brothers Company

Producers and Shippers of and Manufacturers of

## WESTERN CEDAR POLES RED FIR CROSS ARMS

Eastern Sales Office, Monadnock Bldg., CHICAGO SPOKANE, WASHINGTON

## POLES and PILING

20,000 35s and 40s, Ready to Ship at Once  
S-E. MISSOURI CYPRESS CO., CAMPBELL, MO.

**G. H. BARNES HARDWOOD LUMBER CO.**  
Office and Yard: Main and Warren Sts., ST. LOUIS, MO.  
Ties, Car Oak, Poplar, Ash, Cherry, Plain and Quartered Oak

**For Sale** Cards produce results in the  
Electric Railway Review

**C. H. WORCESTER CO.**  
**CEDAR POLES**

PRODUCERS AND WHOLESALERS

Suite 1710 Tribune Building CHICAGO

## Idaho Cedar Poles

PACIFIC COAST POLE CO. SPOKANE, WASH.

We have in our Chicago Yard available for **RUSH SHIPMENTS** a **SELECTED STOCK** of **POLES** and **TIES**

**NAUGLE POLE AND TIE CO.**  
Chicago Office, 226 La Salle Street

We are Producers and Wholesale Dealers in Western

## CEDAR POLES

Yards in Washington, Idaho, Montana  
and British Columbia  
WRITE US FOR DELIVERED PRICES

**CHURCHILL CEDAR CO.,** Box 1409, Spokane, Wash.

**CHESTNUT POLES**  
Cedar, Oak and Chestnut Ties

FROM OUR OWN TIMBER LANDS

**THE ADVANCE LUMBER CO.**  
CLEVELAND, OHIO

**40% SAVED**  
BY USING

## Lumen Bronze Axle Bearings

Cast in metal mold—require no-machine finish

**Lumen Bearing Company**  
BUFFALO — TORONTO

If you want good **POLES** Michigan or Western Cedar at the right prices and prompt delivery, write us.

**NATIONAL POLE COMPANY**  
SEATTLE, WASH. ESCANABA, MICH.

## Electric Railway Material

of every description

**F. P. HARRISON ELECTRIC & MFG. CO.**  
(Incorporated) NEW YORK

169-170 South St.

**WHITE CEDAR POLES**

Large Stock 14 to 65 ft.  
Prompt Shipment

**POLES**

YARDS:  
Menominee, Mich.  
Escanaba, Mich.  
Superior, Wis.  
Deer River, Minn.

**FRANCIS BEIDLER & CO.**  
Chicago, Ill.

**BERTHOLD & JENNINGS**  
LUMBERMENS BLDG. SAINT LOUIS, MO.

**TIMBERS**  
L. L. Pine, Oak

**POLES**  
Cedar, Cypress, Chestnut

**TIES**  
Oak, Cypress, Chestnut



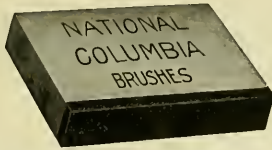

**COLUMBIA** CARBON BRUSHES wear smooth, take a high polish and will outlast any other long life brushes made, with less wear on commutator.

**NATIONAL CARBON CO.** Cleveland, Ohio

**HOT WATER HEATERS for Cars**

THE PETER SMITH HEATER CO., Detroit, Mich.

**THE NATIONAL LOCK WASHER CO.,** NEWARK, N. J.

Curtains - Curtain Fixtures - Sash Locks - Sash Balances - Nut Locks

CHICAGO OFFICE: 419 MONADNOCK BLOCK



CONTINUOUS JOINT

Over 25,000 miles in use



WEBER JOINT

Rolled from Best Quality Steel



WOLHAUPTER JOINT

Additional safety and economy in Track Maintenance has been proved by the use of Continuous, Weber and Wolhaupter base-supported rail joints—after ten (10) years' service, having a record of over 25,000 miles in use—the extent of which is evidence of their excellence.

Catalogs at Agencies  
 Baltimore, Md. Portland, Ore.  
 Boston, Mass. Seattle, Wash.  
 Chicago, Ill. St. Paul, Minn.  
 Denver, Colo. St. Louis, Mo.  
 Pittsburg, Pa. Troy, N. Y.  
 London, Eng. Montreal, Can.

HIGHEST AWARDS—Paris, 1900;  
 Buffalo, 1901; St. Louis, 1904

**THE RAIL JOINT COMPANY**

General Offices: 29 West 34th Street, New York City  
 Makers of Rail Joints for Standard and Special Rail Sections, also Girders, Sleep or Cross-ties, and Insulating Rail Joints, protected by patents in United States and Foreign Countries.

**Gongs Bells** For Street Cars  
 G. C. REITER, Canton, Ohio

**THE CURTAIN SUPPLY CO.**

CAR CURTAINS  
 CHICAGO, 85-98 Ohio Street 1819 Park Row Bldg., NEW YORK

**"METALSTEEL" PAINT**

Best Steel Protective and Rust Preventive for all Metal Surfaces.



ST. LOUIS SURFACER & PAINT COMPANY  
 St. Louis, U. S. A.



**E. C. Van Valkenburgh**

Promotional Advertising for Electric Railways

2117 West 102d Street : Chicago

Advertise economically—use Van Valkenburgh Advertising Service

INSULATING VARNISHES (BAKING; AIR-DRYING) COMPOUNDS TAPE



Possess the Highest Insulative Efficiency.

The Standard Paint Co.  
 100 William St. New York.



**PATTEN TICKET DESTROYER**

Don't burn your used tickets. Destroy them, and avoid fraud. Remember, it is difficult to get a man to destroy anything of value to him.

Sell the old stock—it will soon pay for machine. In use on the Boston & Northern R. R., Old Colony St. Ry. Co., Brockton St. Ry. Co., Waterbury El. Co., Bridgeport Traction Co., Buffalo Ry. and others. Write for circular.

**PAUL B. PATTEN**  
 78 Lafayette Street • SALEM, MASS., U. S. A.

**Washburn Standard** M. C. B. Coupler

—equal to every test

This coupler enabled heavy interurban cars to be hauled on their own wheels in trains from St. Louis to Los Angeles—and without a single breakage. The 152 cars equipped with these couplers are now in fast and heavy service on the Pacific Electric Railway, running in trains of from two to six units each, and around the short curves of city streets.

Our 112-page catalog of traction devices sent free for the asking.

**Washburn Steel Castings & Coupler Co.,** Minneapolis, Minn.

Western Agents: Tweedy, Hood & Finlen, 204 Fisher Bldg., Chicago  
 Canadian Agent: John Taylor, Montreal



## STACK PAINTS THAT LAST

Try our number 36 if exceptionally long service is desired.

**Detroit Graphite Company**  
DETROIT, MICH.

Dept. S.

## ALUMINUM

### Railway Feeders

And all kinds of **Electrical Conductors**

Aluminum Feeders are less than one-half the weight of copper feeders and are of equal conductivity and strength. If insulated wire or cable is required, high grade insulation is **guaranteed**.

*Write for prices and full information.*

**Aluminum Company of America**  
PITTSBURGH, PA.

Formerly The Pittsburgh Reduction Company



## THE "ANTI-PLUVIUS" SKYLIGHT

Lets in all the light.  
Keeps out all rain and dust.

It has so many points of superiority that one small space cannot tell of them all.

Over 3,000,000 square feet in use is **proof** of goodness.

We would like to have the opportunity of demonstrating our claims.

 Anti-Pluvius Skylight as used in Train Shed of new Hoboken Terminal.

It is a pleasure to send catalogues and furnish estimates. Let us hear from you.

**G. DROUVE COMPANY, Bridgeport, Conn.**

Western Office, 40 Dearborn Street, Chicago.

# C. A. W. Motors and Dynamamos

We claim for them the advantages of perfect commutation, coolness in operation, high efficiency, substantial construction, interchangeable parts, high quality of insulation, perfect balance, and pleasing appearance.

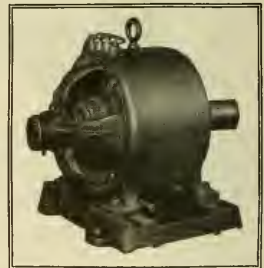

*Ask, please, for booklet and information about our offer of a 30-day free test*

**CLEVELAND ARMATURE WORKS, CLEVELAND, OHIO**

*America's Greatest Armature Winding, Commutator and Field Works*

# Electric Railway Review

PUBLISHED EVERY SATURDAY BY THE WILSON COMPANY, CHICAGO

Entered as second-class matter January 5, 1907, at the postoffice at Chicago, Ill., under the act of March 3, 1879.

160 Harrison Street, Chicago  
150 Nassau Street, New York  
1529 Williamson Bldg., Cleveland

VOL. XIX  
No. 6

CHICAGO, FEBRUARY 8, 1908.

Whole No.  
250

Subscription: Domestic . . . \$2  
Foreign . . . \$5  
Canada . . . \$8.50

It has been our pleasure to visit in the course of our work many railway properties. Usually such visits are made in the company of a mechanical or operating superintendent. On a recent visit of this sort we were impressed with the respectful attitude of the trainmen toward their superintendent. It was at once apparent that

## The Boss and the Job.

the "boys" on this road (and a large one, too) would "stand by the boss" in any emergency. Continued questioning of the modest superintendent was rewarded by an expression from him which, briefly put, was to the effect that having "risen from the ranks" he knew the usual feeling of men toward the head of a department and so made it a rule to know all the men by their first names and always greet them with a cheerful word. This practice had made his organization a close-knit one, in which all the employees were friends of their superior rather than merely job holders ready to revolt at any slight excuse. There is a lesson in this for all of us.

It is interesting to note that the catenary overhead work on the Syracuse Lake Shore & Northern Railroad, which is described on another page of this issue of the Electric Railway Review, though built for single-phase operation, is at present used for direct current and that the direct-current system may be used permanently.

## Economy in Catenary Construction.

When it is also appreciated that the cost of this construction as compared with the company's standard suspension overhead with 35-foot poles, 8-inch tops, at both sides of the track, spaced 85 feet apart, is approximately only \$800 per mile greater and when consideration is taken of the permanence and operating economy of the catenary construction as compared with construction using wooden poles, some idea of the real economy possible in catenary construction may be had. Heretofore 300-foot spans for single catenary work have scarcely been thought feasible, and it will be interesting to note the way in which the work on the Syracuse Lake Shore & Northern, which now gives every evidence of proving satisfactory in every way, will stand up under the severe tests of continued operation.

An interesting method of supporting trolley wires, as developed by P. J. Pringle, electrical engineer for the Borough-on-Trent (England) tramway system, is described by the Electrical Review. This method consists in attaching a short span of steel cable to the trolley wire by means of soldered ears. The spans are about 10

## Improved Bracket Construction.

feet long and take up part of the tensile stress on the trolley wire. The cable is supported by a bracket of ordinary construction and is passed over a reel-shaped earthenware insulator, the working conductor passing under the support. The wire is thus supported from two points instead of one, a straighter run under the support is secured and the wire is free to move vertically, laterally and even longitudinally, since the cable can slip along over the insulator. The idea of the arrangement is to avoid the hammer blow of the trolley wheel which, with the span construction, occurs at every support;

even when a short span of wire is interposed between the bracket and the hanger the severity of the blow is only modified. The method thus possesses much of the advantage of the catenary system of suspension without the complicated and expensive overhead construction.

The reasons for the increased operating expenses of the South Side Elevated Railroad of Chicago in 1907, outside of the natural enhancement due to growth in traffic, were explained by Charles V. Weston, the president, in his annual report to shareholders, of which an abstract was published in the Electric Railway Review of February 1, page 142. The cost of conducting transportation was 32.2 per cent of gross earnings last year, as compared with 29.9 per cent in 1906. The total expended by this department in 1907 was \$677,482, an increase of \$142,537 over the previous year. Mr. Weston said that this increase was due in part to the desire to furnish good service on the new branches to compete with the improved service on the surface lines serving the same territory. Old personal injury claims amounting to \$9,000 were paid. General taxes increased \$7,698 and the city tax on cars was \$3,832 on account of a larger number of cars. The additional cars and structures required an increased payment of \$2,047 for insurance. The loop expenses increased \$26,667 on account of additional passengers and \$8,582 on account of operating expenses, presumably some maintenance expenditures, for which the South Side Elevated road was responsible to the extent of \$8,582. Included in the larger expenses for maintenance of way and structures were \$8,075 for remodeling the old Congress street station and tracks, now used as a terminal for express trains, and \$6,381 for maintenance of the structure at various points.

The problem of providing any special means for ventilating cars is one which has not generally been encountered by managers of street railway companies. It has consequently not been given sufficient study or attention to develop a scheme which has been shown to offer a satisfactory solution, or even to show that a special or unusual system of ventilation is necessary at all for ordinary street car use. The need for careful ventilation of the coaches of steam or electric interurban roads can readily be understood from the fact that such coaches are not so frequently opened in transit. Approved and sometimes costly methods have been adopted on these railway and interurban lines and little difficulty now arises in securing ventilators. The street railway companies have disregarded the subject as one which does not require special treatment and it is doubtful indeed if their position is not a correct one. Where ordinary hinged windows are placed in the monitor decks and the doors are being constantly opened and closed it seems reasonable to assume that enough fresh air will be admitted to provide ample ventilation for the comfort and health of the passengers. The Detroit United Railway, however, has been compelled by municipal legislation to give more serious consideration to this subject and is now conducting a series of

## Ventilating Street Cars.

experiments by making chemical analyses of air samples collected in a number of cars, each one of which is equipped with a different kind of ventilator. The results of these tests will be watched as a matter of interest by street railway officials and others. Tests made several years since by this company show that the need for special means of ventilation is not as great as would seem from the demands made in the ordinance passed at that time by the common council of Detroit and from which it appears that too much stress is being laid on a minor detail when it is probably true that questions of more importance should receive attention from the municipal body. It is such little annoyances that sometimes entail a useless and unwarranted expenditure of time and money and show the utter incapability of the average municipal government to direct the affairs of corporations in a spirit of accomplishing reform when they are entirely ignorant of conditions or of the needs of such companies.

#### BOSTON ELEVATED RAILWAY AND BROOKLYN RAPID TRANSIT COMPANY OPERATIONS.

Comparison of the results of operation of two electric railways is frequently misleading and disappointing because the published reports usually do not contain information in sufficient detail to make it certain that the comparative figures developed are accurate. But the details in the annual pamphlet reports of the Boston Elevated Railway and the Brooklyn Rapid Transit Company and the similarity between their mileage and earnings justify such comparative analysis of the figures as is possible.

In this article the figures for the Boston Elevated Railway are as of September 30, 1907, or for the fiscal year ended that date. The figures of the Brooklyn Rapid Transit Company are as of June 30, 1907, or for the fiscal year ended that date. The Boston railway operated 462 miles of track, of which 446 miles were used for surface cars and 16 miles for elevated cars; the elevated track mileage is 3.5 per cent of the total. The Brooklyn Rapid Transit system operated a total of 578 miles of track, of which 70 miles, or 12.1 per cent, comprised the elevated lines and 508 miles were surface tracks.

The main results of operation of the two companies were as follows:

	Boston Elevated Railway.	Brooklyn Rapid Transit Company.
Miles of track .....	462	579
Gross passenger earnings .....	\$13,546,779	\$18,443,983
Other earnings from operation.....	406,187	937,604
Total earnings from operation.....	\$13,952,966	\$19,381,587
Operating expenses .....	9,647,145	11,465,705
Net earnings from operation.....	\$ 4,305,821	\$ 7,915,882
Other income .....	58,201	555,166
Net income from operation.....	\$ 4,364,022	\$ 8,471,048
Taxes, interest and rentals.....	3,432,744	6,026,387
Balance .....	\$ 931,278	\$ 2,444,661
Special appropriations .....	100,000	442,063
Balance .....	\$ 831,278	\$ 2,002,598
Dividends .....	798,000	.....
Surplus .....	\$ 33,278	\$ 2,002,598

From these figures it may be computed that the gross earnings from operation of the Boston Elevated Railway per mile of track were \$30,201, while those of the Brooklyn company were \$33,474 per mile of track. Operating expenses of the Boston company were larger per mile of track than those of the Brooklyn company. The figures averaged as follows. Boston, \$20,881; Brooklyn, \$19,803. The operating ratio of the Boston railway was 69.1 per cent, as compared with 59.16

per cent on the Brooklyn road. The result of the larger proportion of gross earnings used in operating expenses by the Boston Elevated Railway is shown in reduction of the net earnings from operation to the per mile basis, as follows: Boston Elevated Railway, \$9,320; Brooklyn Rapid Transit Company, \$13,671. The taxes, interest and rentals of the Boston railway averaged \$7,430 per mile, against \$10,408 for the Brooklyn system. As the taxes charged by the two companies during the year were not widely apart, \$966,975 for the Boston road and \$893,782 for the Brooklyn property, the discrepancy is due to the much higher capital cost and rentals of the Brooklyn line.

In computing car-mile results of these two companies we have disregarded the mileage of the United States mail cars as reported by the Boston Elevated Railway, and have taken only the total revenue elevated and surface passenger car mileage for the reason that the Brooklyn Rapid Transit Company gives in its report only passenger car mileage. Figured on this basis the car-mile results follow:

	Boston Elevated Railway.	Brooklyn Rapid Transit Company.
Passenger car-miles .....	51,830,188	68,273,181
Car-mile results, cents—		
Passenger earnings .....	26.14	27.02
Total earnings from operation .....	26.92	28.39
Operating expenses .....	18.61	16.79
Net earnings from operation.....	8.31	11.60

These figures show the larger car-mile passenger and gross earnings of the Brooklyn system and the larger operating expenses of the Boston road, with the resultant material difference in net earnings from operation per car-mile.

We have divided the operating expenses per car-mile into the general accounts shown by each road under operating expenses; but this comparison is rather unsatisfactory because the classification presented by the Brooklyn company in its report renders impossible a distribution of its expenses into the general accounts followed by the Boston Elevated Railway. The Boston company devoted to maintenance accounts 4 cents per car-mile out of a total of 18.61 cents required for operating expenses. The Brooklyn company shows an expenditure on maintenance accounts of 3.89 cents per car-mile out of a total applied to operating expenses of 16.79 cents. Following are the figures:

	Boston Elevated Railway.	Brooklyn Rapid Transit Company.
Operating expenses per car-mile—cents.		
General expenses .....	1.90	0.94
Maintenance of way and structures.....	2.05	1.27
Maintenance of equipment .....	1.95	2.62
Transportation expenses .....	12.71	9.44
Damages and legal expenses.....	.....	1.65
Freight, mail and express expenses.....	.....	0.34
American Railway Traffic Co. expenses.....	.....	0.53
Total operating expenses .....	18.61	16.79

The maintenance of way expenditures averaged \$2,296 per mile of track for the Boston Elevated Railway and \$1,485 for the Brooklyn company. The density of traffic is much greater on the Brooklyn system than on the Boston railway. The number of revenue passengers per mile of track on the Boston road was 586,764. It is not possible to state with accuracy the number of revenue passengers, and hence the density of revenue passenger traffic on the Brooklyn system for the reason that the report mentions only the total passenger traffic, 511,839,437. It is stated, however, that the number of transfer passengers was 41.2 per cent greater last year than in the previous year; and in the annual report for the previous year, ended June 30, 1906, the total number of transfers collected was stated. Figuring from this data the number of transfers collected last year as 136,194,903, there would be left 375,644,534, which, if assumed to be the number of net paid passengers during the year, would average 648,781 revenue-passengers per mile of track.

ANNUAL REPORTS.

Metropolitan West Side Elevated Railway.

Operating expenses of the Metropolitan West Side Elevated Railway of Chicago required 50.11 per cent of gross earnings in 1907 as compared with 48.92 per cent in 1906. The figures of earnings for two years follow:

	1907.	1906.	Increase.
Gross earnings	\$2,878,588	\$2,637,901	\$240,687
Operating expenses	1,443,498	1,290,358	153,140
Net earnings	\$1,435,090	\$1,347,543	\$ 87,547
Other income	6,819	16,665	*9,846
Total income	\$1,441,909	\$1,364,208	\$ 77,701
Taxes, interest and charges	1,050,124	984,938	65,186
Surplus	\$ 391,785	\$ 379,270	\$ 12,515

\*Decrease.

Passenger earnings contributed \$2,778,597 of the total gross revenue in 1907 and advertising earnings amounted to \$62,240. On maintenance of way and structures there was expended \$115,714 and on maintenance of equipment \$194,724.

H. G. Hetzler, the president, refers in the report to the opening of the extension of the Douglas park line. Owing to reductions in forces at industrial plants the traffic from this extension was not as large as anticipated, but it met operating expenses and fixed charges. With the reopening of industries and the revival of good business conditions an increasing volume of business is expected from this extension.

Mr. Hetzler speaks of the increased cost of transportation as a result of the higher cost of power, labor and material. The cost of conducting transportation was \$937,293 in 1907, an increase of \$165,954 over 1906. The increase in gross passenger earnings was \$233,461.

Lake Shore Electric Railway.

Gross earnings of the Lake Shore Electric Railway of Cleveland, O., in 1907 gained \$52,440 over 1906, but operating expenses and taxes increased \$45,301, and net earnings therefore increased but \$7,139. The principal results of operation in the two years, and the changes, follow:

	1907.	1906.	Increase.
Gross earnings	\$913,160	\$860,720	\$52,440
Operating expenses and taxes	521,559	476,258	45,301
Net earnings	\$391,601	\$384,462	\$ 7,139
Other income	25,000	6,250	18,750
Total income	\$416,601	\$390,712	\$25,889
Charges	294,072	254,198	39,874
Surplus	\$122,529	\$136,514	*\$13,985

\*Decrease.

The passenger traffic contributed \$839,237 of the gross revenue in 1907. Among the other sources of gross revenue were the following: Chartered cars, \$5,003; freight, \$45,412; mail, \$2,179; milk, \$1,795; advertising, \$2,490; and car mileage, \$10,177. The earnings per mile of track on the completed divisions extended from \$7,442 on the Cleveland division to \$3,342 on the Sandusky-Norwalk division. Other statistics follow:

	1907.	1906.	Increase.
Operating expenses and taxes—per cent of gross earnings	57.11	55.33	1.78
Car-miles	3,392,735	3,355,661	37,074
Gross earnings per car-mile—cents	26.91	25.65	1.26
Operating expenses and taxes per car-mile—cents	15.37	14.19	1.18
Net earnings per car-mile—cents	11.54	11.46	0.08
Passengers carried	4,904,505	4,758,838	145,667
Gross earnings per mile of track	\$5,854	\$5,733	\$121

E. W. Moore, the president, states that "practically all the switches on the interurban divisions of the road were

equipped with electric switch lights," and that "in order to insure greater safety on account of the high speed of our limited trains, almost all of the sidings were made single-end and the spring switches changed to rigid switches."

Cleveland Painesville & Eastern Railroad.

Operating expenses and taxes of the Cleveland Painesville & Eastern Railroad of Cleveland, O., required 53.5 per cent of gross earnings in 1907 as compared with 53.1 per cent in the previous year. The earnings for the two years compare as follows:

	1907.	1906.	Increase.
Gross earnings	\$296,318	\$271,100	\$25,218
Operating expenses and taxes	157,197	143,993	13,204
Net earnings	\$139,121	\$127,107	\$12,014
Charges	86,552	82,939	2,613
Surplus	\$ 52,569	\$ 43,168	\$ 9,401

Passenger travel contributed \$259,187 of the gross revenue in 1907. Other items which entered into the total gross earnings as shown were \$3,711 from chartered cars, \$12,629 from express, \$5,926 from milk, \$639 from car mileage, \$227 from mail and \$5,000 from track rental.

E. W. Moore, the president, states that hot water heaters have been installed in 10 cars to take the place of electric heaters. A second telephone line was built from Painesville to Willoughby to connect with the Cleveland Painesville & Ashtabula Railroad line to Ashtabula, so that all cars can now be dispatched from the Willoughby office.

Car-mile and passenger statistics compare as follows:

	1907.	1906.	Increase.
Total passengers carried	2,110,215	1,984,877	125,338
Gross earnings per passenger—cts.	12.46	11.97	0.49
Total number car-miles	954,003	910,793	43,210
Gross earnings per car-mile—cts.	30.54	29.76	0.78
Operating expenses and taxes per car-mile—cents	16.48	15.81	0.67
Net earnings per car-mile—cents.	14.06	13.95	0.11

Northern Ohio Traction & Light Company.

From the surplus remaining after the payment of dividends in the year 1907 the Northern Ohio Traction & Light Company of Akron, O., charged off on account of depreciation \$100,000. The operating expenses and taxes absorbed 57.4 per cent of gross earnings in 1907 as compared with 59.1 per cent in 1906. The results of operations for the last three years compare as follows:

	1907.	1906.	1905.
Gross earnings	\$1,909,061	\$1,702,340	\$963,187
Operating expenses and taxes	1,095,755	1,006,842	516,390
Net earnings	\$ 813,306	\$ 696,498	\$446,797
Interest	513,242	483,174	276,744
Net divisible income	\$ 300,064	\$ 213,324	\$170,053
Dividends	158,778	113,527	.....
Surplus	\$ 141,286	\$ 99,797	\$170,053

Of the gross earnings of last year \$1,645,864 was received from passenger traffic, \$137,921 from light and power, \$4,223 from car mileage and \$43,299 from freight. The company is now operating Lakeside park in Akron and Meyers' Lake park in Canton and also the theaters maintained in connection therewith. Gross earnings from the parks were \$68,161 and net earnings were \$22,129. H. A. Everett, the president, states that this account has been credited monthly with 2 per cent of the gross earnings and the surplus in the account at the end of the year was \$21,800.

Of the operating expenses and taxes for 1907, shown in the foregoing table, \$95,820 was devoted to maintenance of way and structures and \$155,945 to maintenance of equipment, a total of \$251,765, while power plant operation required \$251,212 and conducting transportation \$354,692. The balance

sheet shows reserves of \$100,000 for depreciation and \$21,800 for injuries and damages.

Mr. Everett says: "We feel, notwithstanding a falling off in general business, that both the gross and net earnings of the company for the coming year will show an increase and that requirements for capital account will be comparatively small."

**CITY OF SHREVEPORT, LA., DENIED RIGHT TO ENFORCE TRANSFER SYSTEM.**

We have received from L. M. Levinson, secretary and manager of the Shreveport (La.) Traction Company, a copy of the opinion of A. J. Murff, judge of the first judicial district court, parish of Caddo, regarding the transfer litigation in that city. In his opinion Judge Murff says:

This is an injunction suit brought by the Shreveport Traction Company against the city of Shreveport et al., enjoining them from the enforcement of an ordinance passed by the city council on August 11, 1907, requiring transfers to be given, without additional fare, by the various lines in the city, and imposing a fine and penalty for the failure or refusal to do so.

The undisputed facts are as follows: On September 7, 1897, the city council of Shreveport granted to the company the right to build and operate a street railway along certain streets. One of the terms and conditions was "that five cents shall be the fare on each belt, and for school children three cents, with the privilege of transfer in going to and from school."

Subsequent ordinances were granted, with similar terms as to fares. The decision continues:

These franchises were accepted by the traction company, which at great expense has built and has been operating its railway ever since. There is no complaint that the lines have not lived up to the terms and conditions of the grants.

On August 11, 1907, the city council, feeling that it had the right and power, notwithstanding its grant to the traction company, with its terms and conditions as fixed therein, to change the terms relating to fares and reduce the same, passed an ordinance requiring the different lines to give transfers from one to the other, without additional fare, thereby reducing indefinitely the fare fixed and agreed upon in the original contract or franchise, and making it a penal offense to refuse these transfers.

The traction company brought this suit, coupled with an injunction, asking that the ordinance be declared illegal, null, void and unconstitutional and that the writ of injunction be perpetuated. The plaintiff sets up several reasons why the ordinance should be declared null and void, but under our construction of the case it is only necessary to consider one, which is that: "Because the said ordinances confirming said grants and franchises as to their several provisions constitute and form valid contracts between the city and plaintiff, and that the ordinance of August 11, 1907, seeks to impair the obligations of said contracts, contrary to and in violation of Section 10 of Article 1 of the constitution of the United States, and Article 166 of the constitution of the state of Louisiana."

The sole question to be decided is one of law and that is this: Can a municipal corporation, after it has entered into a solemn obligation with an individual or a corporation, under certain named material terms and conditions, change those terms or conditions, and thereby impose additional burdens, without the consent of the individual or corporation with whom it contracted?

No one for a moment could hold such a doctrine, and the defendant city does not so contend, but it does contend that a municipal corporation, without special authority, cannot grant away certain rights and any contract or franchise wherein it attempts to do so is null and void and not binding on the municipality.

It is clear that the city council of a municipal corporation cannot barter away the rights of said corporation unless it has the power to do so. The question then is, had the city council of Shreveport the right to enter into these various contracts with the traction company, whereby the rate of fare was fixed and agreed upon for a number of years? To decide this we must first decide what are its powers.

Among the declared objects for which the corporation of the city of Shreveport was created were to regulate, control and improve its streets, and regulate and control the government of carts, drays, wagons, passengers and street cars which run in the streets and within the limit of the city.

The right to fix fares, in granting a franchise to an individual or corporation, is one of the most important powers incident to the right to regulate the streets and traffic thereon,

and it cannot be denied that such a power is fairly implied and necessarily a part of its express authority. The fixing of fares is a matter of grave importance, both to the city and the railway company, and to hold that this important right and power was not intended to be granted, to be exercised as in its discretion it thought best, would be contrary to all principles of law and judicial conclusions.

Having deliberately made and invoked the conditions upon which the franchise was granted when the city considered them essential to its protection and the preservation of its rights under the contract with the traction company, it would be bad faith and contrary to every principle of law to let it now deny the validity thereof, when it thinks its interest will be benefited thereby.

Upon decisions and our conception of the law, we must hold that although the city council may have acted unwisely, it had the power to grant these franchises, fixing the conditions, rate of fare and term of franchise; that having so fixed them and the traction company having accepted them, they became irrevocable contracts that are binding on both parties and cannot be revoked, directly or indirectly, or burdened with additional charges without the consent of both parties.

For these reasons it is ordered and adjudged that the ordinance of the city council of the city of Shreveport, passed on August 11, 1907, be and the same is declared null and void and of no effect in so far as it may affect the traction company herein acting under the franchises granted prior thereto. It is further ordered that the injunction be perpetuated and the defendant pay all costs of the suit.

# Communications

## ON CAR WHEELS.

To the Editors:

The absence of definite data on which railway managers may predicate judgment has led to many experiments the result of which has proved more or less surprising. I know of an instance where steel wheels have been used on an inter-urban railway with the following results:

First cost per pair ..... \$50  
Cost for removing, turning and replacing three times.... 35

Total cost ..... \$91  
Total mileage ..... 132,000

Motors were provided, power supplied and schedules arranged predicated on the original diameter of these wheels. With each turning these above calculations were upset, because of the diminishing diameter of the wheel. After the third turning the motor case was brought into dangerous proximity to the pavement in cities.

It is conceded that the added factor of safety, the comparison being with cast wheels, is to be duly credited; but so conceding, do not the facts here stated suggest to the manufacturer of steel wheels and to railway managers that a problem is here present? Will any one support a suggestion that wheel manufacturers must produce a steel wheel and supply it to railways at a cost that will permit the railways to scrap it after the first tire wear, abandoning the idea that it is practicable to turn and return the tires, according to present practice?

Of course, we are all afflicted to a degree with "commercial instinct," but I submit that it may be best satisfied by making it possible for the user to obtain the desired article at a permissible cost.

Perhaps there are others who have had "experience." I therefore leave the question for their consideration, assuring you that I remain most sincerely somewhat

A. GROUCH.

January 31, 1908.

A French water tube boiler built by Grille & Co. of Paris recently evaporated on official test 72 pounds of water per square foot of heating surface. The boiler consists of a horizontal steam drum and water leg with tubes of U-shape, the upper leg of the tubes discharging into the steam space of the boiler.

ELEVATED CARS FOR THE BROOKLYN RAPID TRANSIT COMPANY.

The Brooklyn Rapid Transit Company is now placing in service at the rate of one car a day the first consignment of the 100 elevated cars, orders for which were placed about March 1, 1907, with the Jewett Car Company and the Laocinia Car Company, each building 50.

The cars are of the double-end, straight side, semi-con-

The motor trucks were built by the American Locomotive Company and have a wheel base of 6 feet 8 inches and 34-inch Schoen rolled steel wheels. Each truck, including contact shoes and gears, weighs 12,700 pounds. The trailer trucks have a wheel base of 5 feet 6 inches and 31-inch Schoen rolled steel wheels and weigh complete with contact shoes 9,200 pounds. The trailer trucks were built by the St. Louis Car Company from designs furnished by the Brooklyn Rapid Transit Company. Each set of motor trucks is equipped with two

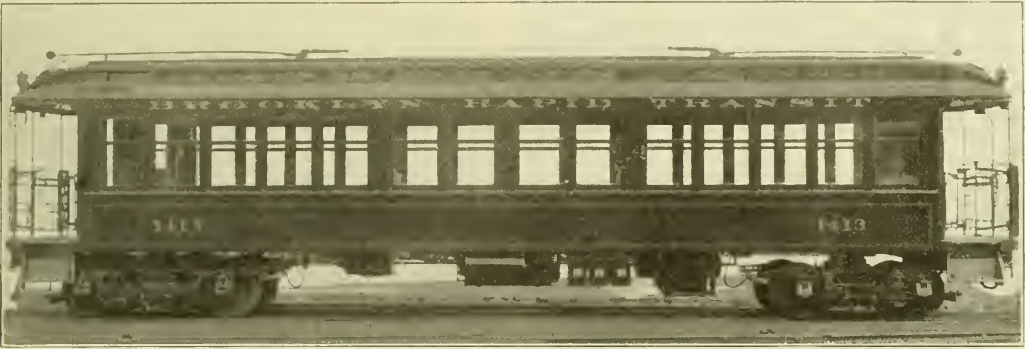

New Elevated Cars for Brooklyn Rapid Transit Company—Side View of Standard Car.

vertible type which is standard on this road and are designed to meet their particular service and traffic conditions. The underframes are of pressed steel and the side frames are of wood, reinforced with steel channels and plates.

Dimensions.

The general dimensions of the cars are as follows:

- Length over platform ..... 48 ft. 11 in.
- Length over end sheathing ..... 40 ft. 5 in.
- Length between centers of trucks ..... 33 ft. 2 in.

Westinghouse type 300, 200-horsepower motors, geared to the ratio of 19 to 64, and operated by Westinghouse controllers of the 251-13 U. S. G. type. The brake equipment includes a New York air brake with 12-inch cylinder style S, triple valve and a 28-inch cubic foot B-B-4 National compressor, controlled by a Westinghouse type L governor. The air brake system is automatic, with graduated release on the first car of the train only.

The motors on these cars are of the interpole type made

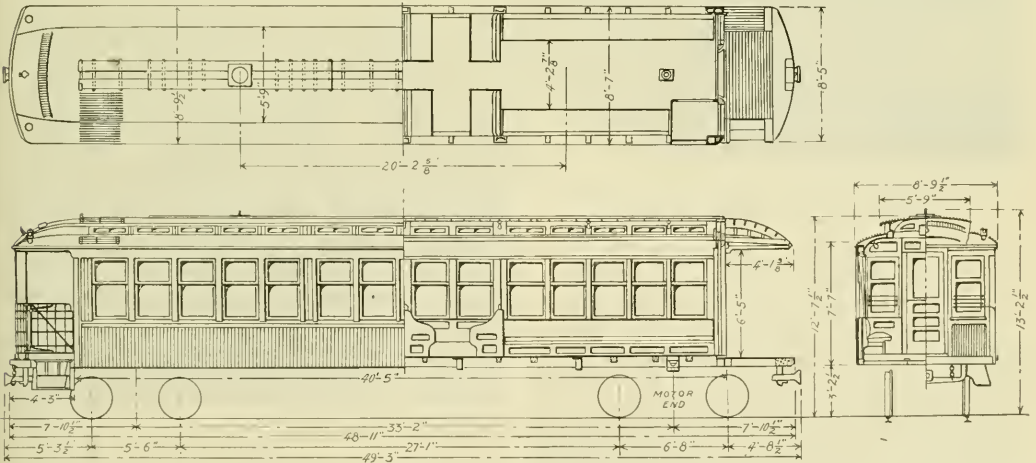

New Elevated Cars for Brooklyn Rapid Transit Company—Floor Plan and Side and End Elevation.

- Length center of truck to end of platform ..... 7 ft. 10 1/2 in.
- Length end of body to end of platform ..... 4 ft. 3 in.
- Width over sills ..... 8 ft. 6 in.
- Width over sheathing ..... 8 ft. 7 in.
- Width over drip rail ..... 8 ft. 9 1/2 in.
- Height, bottom of sill to top of roof ..... 9 ft. 2 in.
- Height, rail to bottom of sill ..... 3 ft. 2 1/2 in.
- Height, rail to top of roof ..... 12 ft. 4 1/2 in.

by the Westinghouse Electric & Manufacturing Company. They operate safely on a fluctuating voltage having a temporary maximum of 800 volts. The continuous rating of the motor will be 150 amperes at 300 volts with perforated covers and 175 amperes with all covers off. The motor has a rating of 200 horsepower at 550 volts. The weight of the gear case

is 550 pounds and of the armature 2,000 pounds. The total weight of the motor complete is 6,000 pounds. There are four main pole pieces built up of soft steel punchings and riveted together between wrought iron end plates. The interpole coil is wound with copper strap, insulated by asbestos and taped fabrics the same as the standard field coils. The armature coil is built up of soft steel punchings assembled on a spider, the commutator also being pressed on this spider. The rear end bell or coil support is detachable, being solidly bolted to the spider. The commutator bars are made from hard drawn copper, clamped between two cast steel retaining rings. The back of the commutator is thoroughly sealed against carbon and copper dust, and all parts of the commutator are interchangeable. The oil pockets are unusually large and provide for waste lubrication. A separate oil reservoir allows the fresh oil to be fed and filtered up through the waste to the bearings. The axle bearings are 1 3/4 inches long and 6 1/2 inches in diameter. The gear has 64 teeth, 2 1/2-

tures, hinges and other fittings are finished in polished bronze.

Eight cross seats are located in the center of the car and longitudinal seats extend from the cross seats to the end in two diagonal corners and from cross seats to the cabs in two diagonally opposite corners. The seats are canvas lined, covered with rattau, and are the product of the Hale & Kilburn Manufacturing Company. Each car has a seating capacity of 54 and a standing capacity of 85, making a total carrying capacity of 139.

**Weight.**

The total weight of the car body completely equipped is 71,755 pounds, 43,325 pounds of which is carried by the motor

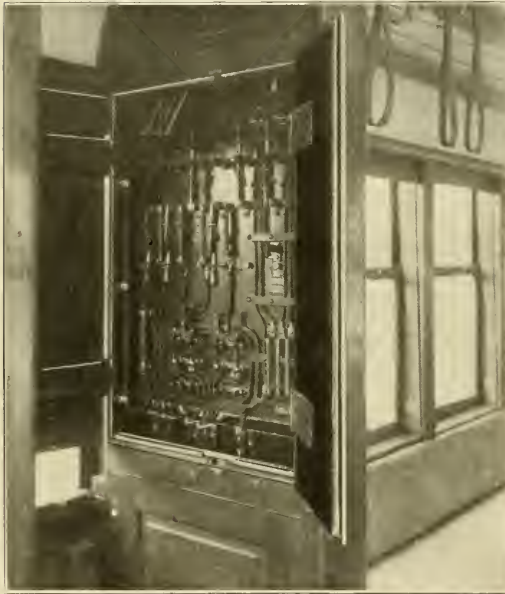

New Elevated Cars for Brooklyn Rapid Transit Company—  
Switchboard in Rear of Motorman's Cab.

inch pitch and 5 1/4-inch face. The pinion has 19 teeth and is made from special high-grade steel.

The right-hand corner in each end of the car contains the motorman's cab, equipped with the usual master switch, air gauge and brake valve. A motorman's cab is formed by a hinged door, which in one position encases the master switch and brake valve and at about 90 degrees engages with the arched posts of the car. In the cab at the trailer end of the car an extension has been provided for in which is built the switchboard controlling the lighting, heating and power circuits. The sides and back of the closet containing the switchboard are encased in steel plate having steel swinging doors, which protection provides at all times against ignition from an electric spark. A removable switch box is built into the hood at the trailer end of the car. A fire extinguisher and support are fastened on the rear partition of the cab at the motor end of the car.

The interior finish is of natural color cherry, with plain inlaid lines and such molding and fittings as are necessary for structural purposes. All door, sash and ventilation fix-

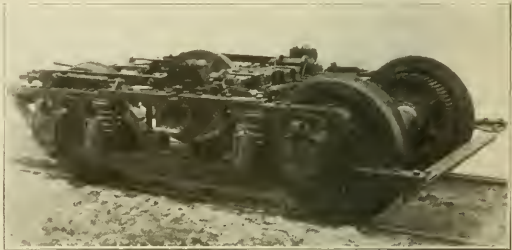

New Elevated Cars for Brooklyn Rapid Transit Company—  
Side View of Motor Truck.

tures and 28,430 pounds by the trailer trucks. The distribution of the weight is given in the following table:

Car body complete with foundation brake rigging.....	27,080 lb.
Motor truck with contact shoes and gears.....	12,700 lb.
Trailer truck with contact shoes.....	9,200 lb.
Two motors complete with gear cases.....	12,260 lb.
Control apparatus.....	2,628 lb.
Brake apparatus.....	2,197 lb.
Switches, switchboard, headlights and heaters.....	552 lb.
Wiring, conduits, piping, hangers, transits and sheathing under car.....	5,138 lb.

In specifying the details and arrangements of this type



New Elevated Cars for Brooklyn Rapid Transit Company—  
Interior View.

of car the company has tried to adopt a type of rolling stock suitable to the service required. To this end both the interior and exterior finish have necessarily been made plain. Very careful attention was given to the quality of the material, both wood and metal, which constitutes an economical and thoroughly efficient structure. The wood used in the framing and car body was of southern long-leaf yellow pine, maple, white ash and cherry, each variety being covered by specifica-



tions that should insure a durable car, ordinarily requiring few repairs. The wrought iron used shows, when tested in specimens of uniform sectional area of at least one-half square inch for a distance of 10 inches, an ultimate strength of 50,000 pounds to the square inch and stretches at least 10 per cent in 8 inches, with an elastic limit of at least 25,000 pounds per square inch. Similar specimens taken from plates, angles or shaped iron have an ultimate strength of 48,000 pounds per square inch and an elongation of 15 per cent in 8 inches. The malleable iron and steel castings used in the cars have been thoroughly tested in a similar manner.

**Body Construction.**

For the flooring southern pine 1 1/4 inches thick with 3 1/2-inch face running lengthwise of the car has been used, each



New Elevated Cars for Brooklyn Rapid Transit Company—  
Exterior of 200-Horsepower Motor.

board being secured to each timber with two 2 1/2-inch No. 14 screws, which are sunk and covered with putty. The floor space between the seats is covered with 5/8 by 5/8 inch beveled maple strips. The side posts and end framing are

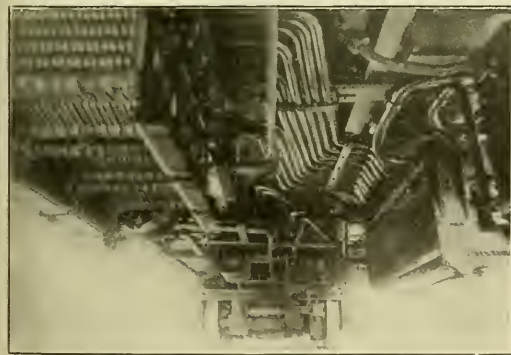

New Elevated Cars for Brooklyn Rapid Transit Company—  
View of Apparatus on Under Side of Car.

of thoroughly seasoned kiln-dried straight-grained white ash. Each single post consists of two sections with a 1/2-inch tie rod grooved between, running from top of plate to bottom of sill angle, and each double post consists of two sections of 1 1/4 by 4 1/2 inch ash, with an 8-inch channel framed between the bottom of the channel being securely riveted to the pressed steel side sill, while the top is turned over and bolted to the bottom of the plate. A 9 by 1 1/4 inch steel plate riveted to the pressed steel side frame is built into each corner post. The car sheathing is of whitewood, 1/2 inch thick and 2 1/2 inches wide, glued and blind nailed to sills.

The roof is of the monitor type, with framing of ash, with the exception of the clearstory sill and plate, which are each of yellow pine in one piece. Steel carlines, 5/8 by 1 1/2 inches, run across the car from plate to plate on every post and are secured by 1/2-inch bolts. The shape of the carlines varies from the center to the end of the car, giving the roof an initial camber upwards in the middle and the plate rail and letter board an initial camber inwards in the middle. The roof is covered with whitewood, 5/8 by 2 1/2 inches, and then covered with No. 6 cotton duck canvas.

The cars are arranged to operate from both ends and on either side. Four platform gates of the Pitt type are installed on each car.

The cars are heated by electric panel heaters known as type 146 X, manufactured by the Consolidated Car-Heating Company. The main body of the car is heated by 18 heaters and one smaller in size in each of the motorman's cabs, the latter being specially designed by the road. The markers are the standard 4-sided electrically lighted type, manufactured by the Dayton Manufacturing Company.

The 100 surface cars which the Brooklyn Rapid Transit put into service last fall were described in the Electric Railway Review of October 26, 1907.

**MAKING THE WHEELS GO.**

In an informal address delivered before the students of Purdue University on January 27, 1908, by Prof. H. H. Norris, Sibley College, Cornell University, some especially pointed remarks were made which undoubtedly are of as much value to engineers in actual service as to technical college students. A summary of these remarks follows:

**Which Would You Rather Be?**

Technical graduates (and others) divide themselves more or less automatically into two classes: wage earners, salaried employes.

The first puts his skill, the second himself, into his work. The first is paid for his labor, the second for his interest. The first is paid for overtime—there is no overtime for the second.

The pay of the first is regulated by the unions. The second is (theoretically) paid a reasonable living salary, consistent with the expenses to which his position subjects him.

Good work on the part of wage earners is usually recognized, as the results are evident. It is not always so in the other case, as the true leader loses himself in his work.

**How to Make the Wheels Go.**

Osborne's maxims for leaders: (1) Allow nothing to be everybody's business. (2) Make everything somebody's business. (3) Let no one interfere with another's responsibility. (4) Put in force a clear and simple system, but (5) Avoid red tape.

**Can You Do Them?**

- Things some technical graduates cannot do:
- Answer a business letter by return mail.
- Write a clear brief report or letter.
- Defend their own opinions.
- Reason from premises to a conclusion.
- Realize the obligation involved in a contract.
- Inspire others to their best efforts.

Concluding an article on the Valtellina electric railroad in Italy, in the Electric Trunk Line Age, J. M. Graham, vice-president of the Erie Railroad, says: "Technically, the electrical equipment of the Valtellina line demonstrates beyond the shadow of a doubt that the three-phase system is admirably adapted to the longest distances and the most severe traffic conditions that can be found in practice. Indeed, it possesses advantages which seem to make it better suited for real heavy trunk-line work than any other system. Commercially—and I consider commercial practicability the more important consideration for the railroad man—my inspection of the three-phase system here briefly described leads me to the conviction that, wherever the traffic is dense enough electric traction will not only materially decrease the operating cost per ton-mile, but it will accomplish this end, either with a material decrease in the motive power equipment, or it will handle as much as 50 per cent more traffic than could be handled under the most favorable conditions of steam operation."

### CATENARY CONSTRUCTION ON THE SYRACUSE LAKE SHORE & NORTHERN RAILROAD.

The Syracuse Lake Shore & Northern Railroad on January 25 placed a  $4\frac{1}{2}$ -mile stretch of catenary construction designed for single-phase current at 6,600 volts in operation, using direct current at 550 volts.

The road is at present about 12 miles long and cars are operated on a half-hour schedule from Syracuse to Baldwinsville, N. Y. As originally built the line was single track, following a circuitous route. When in September, 1905, the property was acquired by the present interests, the work of entirely rebuilding the road was undertaken, and this has included a second track, much of which has already been completed, as well as the relocation of the portion now equipped with catenary trolley construction. The road is to

pedestals 20 inches square and of varying depth according to the nature of the ground. The trusses have 8-inch channel top chords and 6-inch channel bottom chords set flanges down, the diagonal members being  $\frac{5}{8}$ -inch rods and the struts  $2\frac{1}{2}$  by  $2\frac{1}{2}$  by  $\frac{1}{4}$  inch angles. The struts are flattened and bent over at the ends and riveted to the channels. Malleable iron pins for the porcelain insulators carrying the messenger cable are bolted to the top chord of the truss.

The messenger cable is  $\frac{7}{8}$ -inch galvanized cable, furnished by the John S. Roebling's Sons Company and No. 0000 grooved copper wire, furnished by the same company, is used for the trolley wire. The trolley hangers are galvanized steel rods  $\frac{5}{8}$  inch in diameter, spaced 10 feet centers. These hangers are of the Ohio Brass Company's standard type, attached to the messenger cable with a sister hook, through the base of which the rod is threaded and drawn up tight



Syracuse Lake Shore & Northern Railroad—Catenary Trolley Construction and Power Transmission Line.

be extended from Baldwinsville, through Phoenix and Fulton to Oswego, making a line about 30 miles long. Much of the distance from Baldwinsville to Fulton is already graded.

#### Catenary Bridges.

The catenary work, as previously stated, is designed for single-phase at 6,600 volts, but owing to the facts that but a small portion of the proposed work has thus far been completed and that the rolling stock is built for direct current, the road is being operated under the alternating-current-direct-current system. As will be seen from the accompanying engravings a single messenger cable is used with steel bridge construction. The bridges are located 300 feet apart on tangent and have a span of 30 feet, the track being laid on 12-foot centers. The bents for the bridges are built of two 8-inch channel members, spaced 6 feet apart at the base, converging to 8 inches at the top and supported on concrete

against the messenger cable. The trolley wire is secured to the hanger by mechanical ears.

The catenary is strung for a net sag of 6 feet 6 inches at 100 degrees F. At 20 degrees F. the sag is about 5 feet 6 inches and the trolley is 12 inches higher at the center of the span than under the bridges, the height from rail to trolley being 18 feet. The bridge construction is designed for a wind pressure of 8 pounds per square foot on the trolley and messenger cables when covered with  $\frac{1}{2}$  inch of ice. A somewhat lower load is assumed on the high-tension wires, which are No. 2 copper. Under the assumed wind and ice load the unit strain on the bridge is 22,500 pounds per square inch, reduced for the compression members of the bridge, which is computed as a braced portal.

At each bridge there is a steady strain attachment applied to the trolley in the manner indicated by an accompanying plan, the Ohio Brass Company's 8-inch wheel type insulators

being used. The messenger cable is dead-ended on an equalizer attached to a pair of these insulators, which are in turn connected by short cable loops secured to the anchor bridge. Temporarily the dead-end bridges are the same as the other bridges along the line with the addition of a second channel top chord set at right angles to the other channel chords and to which the catenary dead end is bolted.

During the 10 days the catenary work has been in service

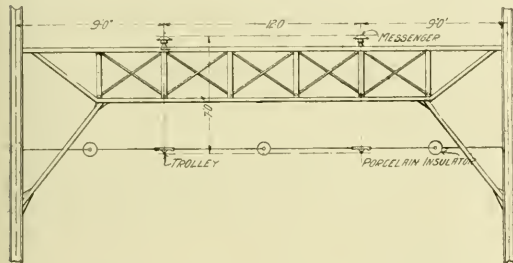

Syracuse Lake Shore & Northern Railroad—Plan of Steady Attachment at Catenary Bridges.

there have been temperature changes of 50 degrees and wind velocities of 45 miles per hour. These conditions have appeared to make no difference in operation, even before the

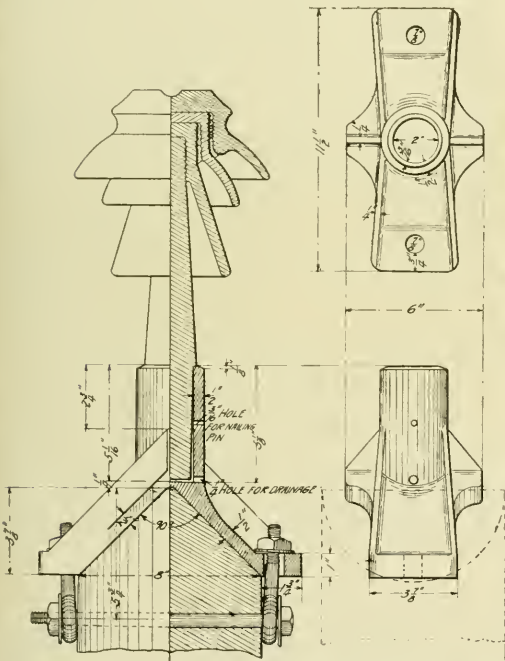

Syracuse Lake Shore & Northern Railroad—Standard Socket for Pole-Top High-Tension Line.

steady strains were installed, and the lateral stiffness has been such at all times that very little deflection or rolling can be noticed under the action of the wheel trolley with a tension of about 25 pounds.

As will be seen from the engraving the construction is comparatively simple, and though in operation for but a short time has been very satisfactory, there having been no trouble

from trolley wheels jumping the trolley wire. The construction also gives to the motorman all along his range of vision a clear view of both sides of the right of way, and it is believed will be permanent and much more satisfactory than a catenary bracket construction using wood poles. In this connection it is interesting to note that as compared with the standard span construction for double track using 35-foot cedar poles 8 inches in diameter at the top and spaced 85 feet apart the cost for the catenary construction of the type described has been but \$800 per mile greater. The catenary work was designed by the Archbold-Brady Company of Syracuse. This company also designed and furnished the steel catenary bridges and designed such special work as was required, all of which was subject to the approval of Thomas H. Mather, chief engineer of the Syracuse Lake Shore & Northern. All catenary clips, hangers and insulators were furnished by the Ohio Brass Company. The work of erection

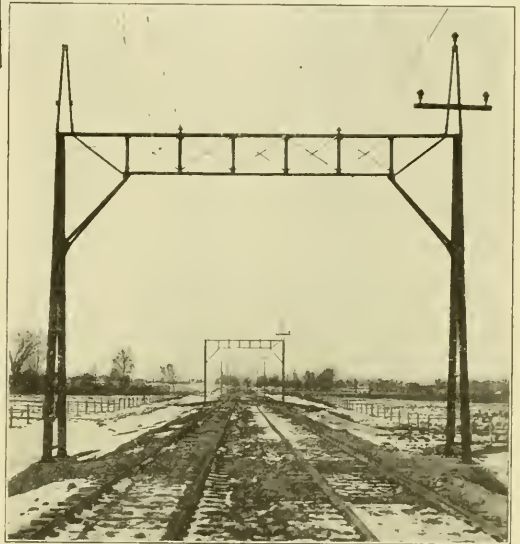

Syracuse Lake Shore & Northern Railroad—Partially Completed Catenary Trolley Construction and Power Transmission Line.

was done under the immediate direction of L. J. Myers, superintendent of construction of the road.

**Power Transmission Lines.**

The three-phase power transmission line is carried on an A-frame on the catenary bridges throughout the length of the catenary construction, power being obtained from an auto-transformer station of the Niagara Lockport & Ontario Power Company, located on the outskirts of Baldwinsville, which delivers current at 22,000 volts. On the portion of the line between Syracuse and Long Branch, which has the standard suspension overhead work with wooden poles at the side of the right of way, the transmission line is carried on the pole tops. A special bracket designed for the insulator pin immediately on the top of the pole and shown in an accompanying engraving is used with a 6-foot crossarm below. The power transmission line runs to the power house of the Syracuse Lake Shore & Northern at Nine-Mile creek, about 4 1/2 miles from Syracuse, where the current is at present stepped down to 402 volts and a 500-kilowatt rotary converter used to furnish the necessary direct current for present operation. The company also has here its two engine-driven generators, used

heretofore as reserve for emergency. The new equipment was all furnished by the Westinghouse Electric & Manufacturing Company. The switchboard equipment includes integrating and recording wattmeter automatic synchronizer and all the essential apparatus for the operation of the power equipment.

**Roadbed.**

The double-track roadbed is at present on cinder fill, cinders being obtained in large quantities from the Solvay Process Company. When these become thoroughly packed

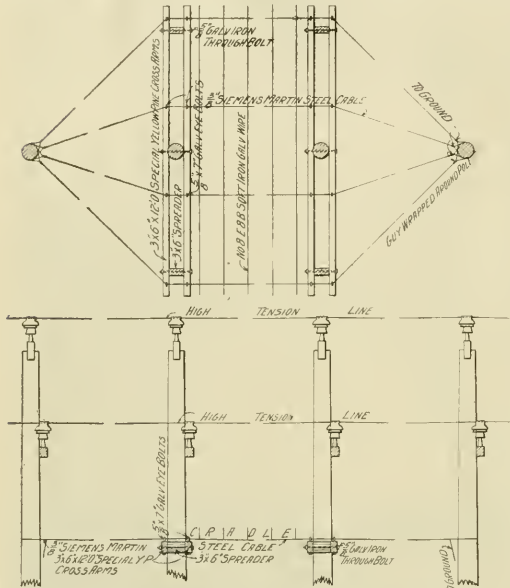

Syracuse Lake Shore & Northern Railroad—Cradle Construction for Protection of Steam Railroad Crossing and Power Transmission Line.

they afford a good subconstruction for crushed rock ballast. The rails are 70-pound sections. They are bonded with Chase-Shawmut soldered bonds.

**CAUTIONS TO BE OBSERVED IN LAYING OFF BOILERS AND BOILER CLEANING.**

In view of the accidents which are reported from time to time due to the bad methods adopted in preparing to clean boilers, and in the actual work of carrying out such operations, it may be worth while to give a few general hints as to the way in which to treat a boiler when it is proposed to lay it off for any time. The general conception as to how to treat a boiler when it is to be laid off for any length of time is to empty all or part of the water, and to leave the boiler standing with the fire-doors in any position in which they may happen to be placed at the time. It does not matter to the intelligences of those in charge of such installations as to whether the doors are open or shut, or whether there is any water or none in the boiler. No trouble is even taken to ascertain whether the boiler is under heavy pressure or not.

The correct procedure should be as follows: Do not attempt to blow the boiler down at all, but let it cool down until the pressure gauge stands at zero. When this is the case, in order to make sure that the gauge is not deceiving the operator, open the gauge-glass cock, or any other convenient opening, to make sure that there is no pressure in the boiler. Then, when this is certain, but not before, take off the top manhole cover and pump water into the boiler until it is full right up flush with the manhole flange rim. It should be carefully seen that all the fire doors are shut in order to prevent air circulating through the tubes, etc.,

of the boilers. Shut as far as possible all openings in the front of the boiler. The advisability of this is apparent when it is remembered that the variations of temperature, especially in a boiler house which shuts down all night, or in an open-fronted boiler house, are enough to cause a considerable amount of condensation on the exterior of the tubes and drums of a standing boiler. Cases have come within the experience of the writer where, with boilers standing exposed to all sorts of temperature variations, it has been possible after two months to take flakes of rust of considerable size off the outside of the tubes.

The folly of attempting to remove the manhole cover when there is any pressure at all in the boiler is illustrated by the two cases of fatality arising through foolishness of this sort which were reported in the technical press a short time ago. One case was at Cambridge, where two men started to take off the cover of a boiler for cleaning purposes with the idea that there was no steam in the boiler because the pressure gauge stood at zero. They took out all the bolts and then proceeded to force off the cover, with the result that a rush of steam occurred, which scalded one of the men to death. Another case, an American one, was that of two men who started to take off the cover of a large vessel no less than 5 feet in diameter and 40 feet in length, under the impression that no steam was in it, whereas the pressure had not been relieved. After a number of the bolts had been removed, the head was suddenly blown off, with the result that the two men were killed.

If the boiler is to stand idle for any length of time it is not advisable to leave it empty. However carefully it may be dried and sealed up, there is always a risk of dampness, either from the atmosphere or due to water being left in some part of the boiler, whereas if the boiler is pumped full there is no risk of any part of the surface being exposed to the air.

In boiler cleaning a very useful method, if there is much scale in a boiler, particularly in one of the Babcock type, where there are a large number of small tubes, is to put about one hundredweight of soda ash into the boiler and fill it right up with water. Then keep a very small fire in the grate for about 48 hours in order to keep the water just boiling; the top manhole cover should be left off in order to prevent steam pressure being generated, and immediately after this boiling process is finished the water should be run off. This makes the scale far easier to remove. If the operation of scaling takes more than a day, in order to prevent the scale from getting hard again it is advisable to pump the water full up when the men knock off at night, provided that all the tube caps have not been removed. For this reason, if no other, it is advisable to take off the tube caps row by row as required, because if the boiler is once allowed to get thoroughly dry the scale hardens and the good effects of the soda boiling are lost.

While the boiler is down it is advisable to look out for signs of grease pitting—that is to say, corrosion of the boiler due to decomposition of the fatty compounds which make their way into the boiler with the feedwater, if this is derived in any way from engine exhausts. If there is any likelihood of grease getting into the feed in this way a useful thing is to paint the inside of the steam-drum along the sides and ends to a depth of about 4 inches below the normal water level with Portland cement. Only a very thin coat is necessary. This will entirely prevent grease pitting.

Some experts are believers in the idea that boilers, when laid off, should be kept dry. In the case of large-diameter drum boilers, coke fires have been kept alight in the interior of the boiler in order to drive off any moisture, but in the writer's opinion by far the best way in every case, provided the feedwater is pure and free from acid, is to pump up as full as possible and carefully seal all outlets of escape for the water. Corrosion only occurs where iron and steel surfaces are subjected alternately to the action of air and water.—Electrical Engineer, London.

**Effect of 2-Cent Fare Laws.**

The following have written letters to the Electric Railway Review in response to our request concerning the effect of 2-cents-per-mile fare laws upon traffic:

E. B. Lincoln, general manager Muncie & Portland Traction Company, Portland, Ind.: "We have not noticed any decreases in our traffic up to this time on account of the 2-cent fare law."

J. C. Lugar, general manager Philadelphia & Easton Electric Railway, Doylestown, Pa.: "Two-cents-per-mile fares of steam railways have had no effect upon our traffic. I do not think the decreases in steam railway fares will cause any changes in the fares of interurban electric railways."

THE GRAND VALLEY RAILWAY.

The present Grand Valley Railway is a road with 26 miles of track extending from Brantford, Ont., north through the town of Paris and the village of Glen Morris to Galt, Ont., a town of approximately 10,000 population, where it connects with the Galt Preston & Hespeler Street Railway, an electric line reaching the towns comprising its name and Berlin. Until recently it has been controlled by the same interests as the Brantford Street Railway and the Woodstock Thames Valley & Ingersoll Electric Railway, the former, a city line exclusively with about eight miles of track, and the latter an interurban line, 12 miles long, connecting Woodstock and Ingersoll, Ont. Woodstock is located about 25 miles west of Brantford.

Within the past four months new interests, headed by Murray A. Verner, president, have acquired the three properties and propose to rehabilitate the three existing lines and

the existing properties appearing as solid lines and the extensions as dotted lines. The existing steam lines of the Grand Trunk, Michigan Central, Canadian Pacific and Toronto Hamilton & Buffalo railroads are also shown, together with the population, according to the latest census, of the villages on the lines and in the nearby surrounding country.

The existing properties, which, under the previous management, in addition to being poorly constructed, were allowed to become badly run-down, it is proposed to entirely rebuild and relay with new 80-pound steel. The Colborne street line of the Brantford Street Railway is to be double-tracked and seven additional miles of track laid in Brantford, giving a loop through the city for interurban cars and several new city lines. The interurban line from Brantford to Port Dover is to be built with a maximum grade of 1.3 per cent and the line from Brantford to Woodstock, as well as the St. George extension, will have grades not exceeding 2 per cent. Contracts for grading, masonry and timber work have been awarded to Joseph Gianini, Pittsburg, Pa., and it is expected that contracts for rails, bridge work and electrical equipment will be let in the spring, when construction work will be commenced.

The decision as to the electrical system to be adopted and as to whether the company will build its own power house or purchase power depends much upon the elections now being held in Ontario to determine whether the government shall have the right to construct power transmission lines from Niagara Falls and sell power for lighting and other purposes to municipalities and corporations. Should the government obtain the necessary approval of the people power will doubtless be obtained from the line which will be built in lower Ontario. On the other hand a transmission line from Niagara Falls for the exclusive use of the Grand Valley Railway Company or a power plant built by the company at Brantford or some other point would be considered. The single-phase system is favorably looked upon for the electrical equipment because of the mileage of the projected lines.

A tabular statement of the projected work is as follows:

Lines to be Rebuilt.		Miles.
Brantford Street Railway	.....	8.0
Grand Valley Railway	.....	22.0
Woodstock Thames Valley & Ingersoll Railway	.....	12.0
		<hr/> 42.0
New Lines.		
Brantford Street Railway	.....	7.0
St. George extension	.....	6.0
Brantford to Port Dover	.....	34.5
Brantford to Woodstock	.....	25.0
Ingersoll to London	.....	18.0
		<hr/> 90.5
Total	.....	132.5

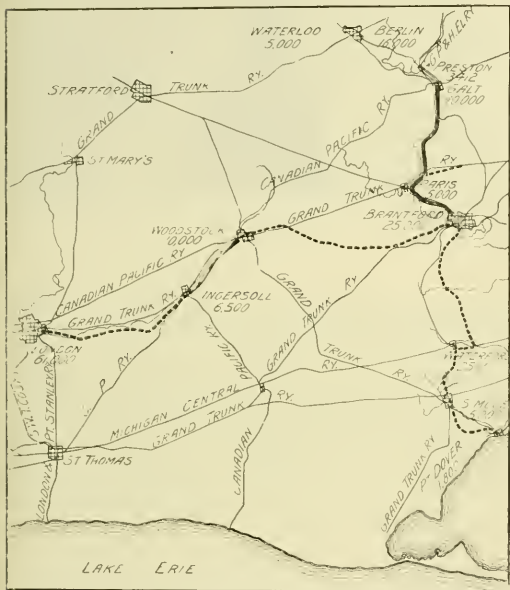

Map of Operating and Proposed Lines of the Grand Valley Railway.

create a system aggregating 132 miles of track. The Dominion charter of the Grand Valley Railway gives them broad powers to build and operate steamship lines on the Great Lakes, as well as telegraph and telephone lines and other utilities.

The principal extension will be from Brantford south to Port Dover, a town of 1,800 inhabitants, on Lake Erie, and will pass through the villages of Mt. Pleasant, Boston and Bloomsburg and the towns of Waterford and Simcoe, located in a rich fruit belt. Port Dover, though not a large port of entry, is said to have one of the few harbors on Lake Erie which can be entered by a vessel in a storm and it is believed that its location will result in material development of the surrounding country and a large freight and express business when the new line, 34.5 miles long, is completed.

The other extensions comprise links connecting Brantford and Woodstock, and Ingersoll and London, Ont., thus completing a line 55 miles long from Brantford to London, and a 6-mile spur from the Galt-Brantford line to St. George. The extensions are shown in detail in an accompanying map.

The interurban lines, as at present laid out, will be practically all upon private right of way. Crossings with steam lines, of which seven are shown, are to be below the grade of the steam line, with the exception of one on the outskirts of Brantford. A steel trestle about 1,200 feet long will be required on the Port Dover extension and at the Simcoe crossing of the Grand Trunk 45,000 yards of earth will have to be moved and the Grand Trunk tracks raised to obtain the crossing by the steam road overhead.

The chief engineer of the Grand Valley Railway is William P. Kellett, to whom we are indebted for the accompanying map and for information in regard to the company's plans.

It is reported that the Cleveland Electric Railway is having a car of the pay-as-you-enter type constructed for experimental use on its lines and that if it proves as successful in Cleveland as in other cities the company may order a number of the cars. George L. Radcliffe, superintendent, has spent some time in Buffalo observing the operation of the new pay-as-you-enter cars recently placed in service by the International Railway.

**NEW CARS FOR THE AURORA ELGIN & CHICAGO RAILROAD.**

The cars are mounted on McGuire-Cummings No. 10-A trucks with chilled wheels 33 inches in diameter. The wheel

Illustrations are presented herewith of one of two passenger motor cars which were recently furnished for the Fox River division of the Aurora Elgin & Chicago Railroad by the McGuire-Cummings Manufacturing Company, Chicago, Ill. Three more cars of the same type are now being built for this road.

The principal dimensions are: Length over all, 47 feet 10 inches; length over corner posts, 36 feet 6 inches; width over side sills, 8 feet 5 inches; width over all, 8 feet 9 inches; height from bottom of sill to top of roof, 9 feet 5 inches.

The general appearance of the car and the details of the floor and side framing will be noted from the accompanying engravings. The interior of the car is divided by a partition and a single sliding door into main passenger and smoking compartments, the smoking compartment seating 16 persons and the main compartment 34. A toilet room with dry hopper is placed in the rear left-hand corner of the main compartment. The water cooler is located in the toilet room partition. The interior finish is of white quarter-sawed oak with a light finish. The ceiling and deck linings are of birds-eye maple.

The side sills are 5/8 by 8 inch steel plates, faced outside with 4 1/2 by 8 inch yellow pine, and inside with 1 3/4 by 6 inch yellow pine. The two center sills are 6-inch I-beams, filled on each side with 6 by 2 1/2 inch yellow pine. The two intermediate sills are of 2 1/2 by 1 3/4 inch long-leaf yellow pine. The cross sills are of 2 1/2 by 6 inch yellow pine. The bolsters



Aurora Elgin & Chicago Cars—Interior of Passenger Compartment.

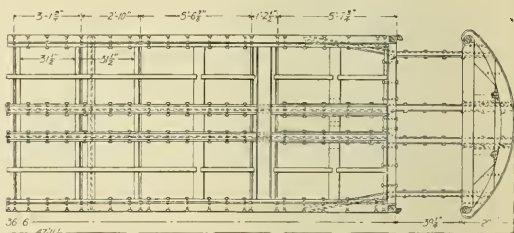
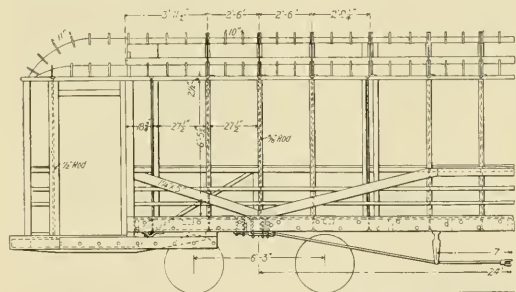

Aurora Elgin & Chicago Cars—Side and Floor Framing.



Aurora Elgin & Chicago Cars—Exterior View.

are of the M. C. B. built-up type, with the arch completely filled with oak. The body framing is of ash and the longitudinal rails and plates are of yellow pine.

base is 6 feet 6 inches and the distance between truck centers is 24 feet. The equipment includes Hale & Kilburn walkover rattan seats and Pantasote curtains.

## BOOK TABLE.

**Experimental Electrical Engineering.** By V. Karapetoff, Cornell University, Ithaca, N. Y. Published by John Wiley & Sons, New York, 1908. Book, 790 pp., 5¾ by 9 in., 538 figures. Price, cloth, \$6.00, net.

This is a book of experiments. The author, who is a member of the instructing staff of Cornell University, has compiled in this work a very complete laboratory manual suited to the needs of students pursuing the last two years' courses in the higher technical colleges. Practically every phase of electrical engineering as it occurs in commercial design and practice is considered in this book.

The student, to carry on the 750 experiments, must have a working knowledge of physics. "The plan followed in each chapter is this: First, the particular class of machinery is described and the practical needs for certain arrangements and procedures of operation are given; then the object and the method of each particular experiment are described in detail and instructions given for the manner in which data should be taken. At the end of most experiments the requirements for the reports are stated so that the student will not omit to take all the necessary readings and dimensions while in the laboratory."

It will be remembered that the author in June, 1907, presented before the annual convention of the American Institute of Electrical Engineers at Niagara Falls, N. Y., a paper on "The Concentric Method of Teaching Electrical Engineering." This laboratory schedule is arranged complete in chapters so that the course may be pursued in the order laid out from cover to cover, or the instructor may arrange an irregular choice of subjects according to the concentric method of teaching proposed by Mr. Karapetoff.

**Introduction to the Study of Electrical Engineering.** By Henry H. Norris, M. E., professor of electrical engineering Sibley College, Cornell University, Ithaca, N. Y. Published by John Wiley & Sons, New York, 1907. Book, 404 pp., 5¾ by 9 in., 179 figures. Price, cloth, \$2.50, net.

Professor Norris has in this, his latest book, given the engineering profession at large, and embryo engineers yet in college, a most valuable means of assistance. A serious omission would be made if attention were not called to the method by which the author presents to the reader or student his treatment of the subject of electrical engineering. In the preface we read: "Having defined electrical engineering as one of application, it is especially important that the student in approaching the subject should have personal knowledge of the things and phenomena involved before any reasons can be ascribed to them. Observation and memory must supply the raw material from which deductions are to be made. We must proceed from the familiar to the new and unknown. Hence the plan of this introductory work is to take the everyday experience of the student as the basis of a general survey of electrical applications. Everyone rides on electric cars, uses telephones and electric lights, and in other ways comes into more or less intimate contact with electrical phenomena. By combining with this experience the lessons taught by scientific research, a clear conception of electrical laws should result. These laws may then be used to explain the operation of the numerous devices used in electrical practice."

In laying the foundation for further analytical work, which is the purpose of this new book, Professor Norris describes in a clear and concise way a large number of electrical machines and devices as found in actual service. From these descriptions the reader or student is led to the theoretical and operating phases on which each machine depends for its operation. It may be of interest to mention briefly some of the subjects to which attention is devoted.

The earlier part of the book considers the electrical machinery and phenomena as encountered in every-day experience. Then follow chapters on the fundamental electrical and magnetic quantities, together with a description of the

materials of electrical engineering. A discussion and descriptions of electric and magnetic circuits lead to chapters on the construction and operation of electric generators, transformers and power stations. Following a very thorough treatment of the power station, Professor Norris describes, illustrates and discusses electric motors and their application and electric lighting and heating. In the concluding two chapters he considers, for the benefit of the student, various measuring instruments and means for the electrical transmission of intelligence. The book concludes with a detail subject index comprising 46 pages.

#### EXECUTIVE COMMITTEE MEETINGS OF THE AMERICAN STREET AND INTERURBAN RAILWAY ASSOCIATIONS.

Important meetings of the executive committees of the American Street and Interurban Railway Association and the affiliated associations were held last week at the office of the association, 29 West Thirty-ninth street, New York City.

##### • Transportation and Traffic Association.

On Thursday, January 30, a meeting was held for the purpose of organizing a fourth affiliated association, the American Street and Interurban Railway Transportation and Traffic Association. The organization of this association, together with an abstract of the constitution and by-laws and the names of the officers, was reported in the Electric Railway Review of February 1, page 143. President C. Loomis Allen, vice-president and general manager Utica & Mohawk Valley Railway, has appointed the following standing committees:

"Express and Freight Traffic"—H. H. Polk, president Interurban Railway, Des Moines, Ia.; W. S. Dimmock, manager Puget Sound Electric Railway, Tacoma, Wash.; A. L. Eastman, Utica, N. Y.; Charles M. Paxton, general manager Dayton & Troy Electric Railway, Dayton, O.; and J. H. Lathrop, general freight agent Spokane & Inland Empire Railroad, Spokane, Wash.

"Passenger Traffic"—H. J. Crowley, general manager American Railways Company, Philadelphia, Pa.; M. C. Brush, general manager Lexington & Boston Street Railway, Boston, Mass.; F. W. Coen, general manager Lake Shore Electric Railway, Cleveland, O.; E. F. Peck, general manager Schenectady Railway, Schenectady, N. Y.; and Franklin Woodman, general manager New Hampshire Electric Railways, Haverhill, Mass.

"Rules for City Operation"—(Two years): Duncan McDonald, manager Montreal Street Railway, Montreal, Canada; George R. Nagle, general manager Wheeling Traction Company, Wheeling, W. Va.; Robert S. Goff, vice-president and general manager Boston & Northern Street Railway, Boston, Mass. (One year): E. J. Ryon, superintendent of transportation Schenectady Railway, Schenectady, N. Y.; W. M. Weatherwax, superintendent of transportation Chicago City Railway, Chicago, Ill.; F. H. Lincoln, assistant general manager Philadelphia Rapid Transit Company, Philadelphia, Pa.

"Interurban Rules"—(Two years): J. N. Shannahan, second vice-president and general manager Washington Baltimore & Annapolis Electric Railway, Baltimore, Md.; J. E. Duffy, superintendent Syracuse Rapid Transit Company, Syracuse, N. Y.; F. D. Carpenter, general manager Western Ohio Railway, Lima, O. (One year): L. E. Fischer, vice-president and general manager Illinois Traction System, Danville, Ill.; Charles Currie, general manager Northern Ohio Traction & Light Company, Akron, O. (One to be appointed.)

##### American Association.

The regular winter meeting of the executive committee of the American association was held on Friday, January 31. Those present were: C. G. Goodrich, president; James F. Shaw, W. Caryl Ely, A. W. Brady, F. R. Henry, T. N. McCarter, C. S. Sergeant, F. G. Simmons, H. R. Goshorn, B. V. Swenson, secretary; C. Loomis Allen, H. M. Littell and H. H. Vreeland.

The secretary presented a report upon association matters covering the period since the executive committee meeting held directly after the last convention, and outlining the

work which is to be taken up during the ensuing year.

On January 30, 1908, the number of active members, street and interurban railway companies, was 244, and the number of associate members, individuals, was 184.

The estimated receipts for the year amount to \$29,130 and the estimated total expenditures of the association, if it is to proceed along the lines already laid down, amount to \$28,500.

As to the 1908 convention the secretary reported that invitations had been received from the Asbury Park Convention League and from the Atlantic City Hotel Men's Association; also invitations from the Denver City Tramway Company, the Denver Convention League, the mayor of Denver and the acting governor of Colorado to hold the 1908 convention at Denver. The time and the place of holding this convention were discussed at some length and it was finally decided to leave this matter in the hands of a committee with power to act, subject to the approval of the president. It is expected that this committee, in conjunction with a similar committee from the Manufacturers' association, will investigate this entire matter and make a report to the president some time before the first of April.

The organization of the American Street and Interurban Railway Transportation and Traffic Association was reported by C. Loomis Allen, president. The constitution and by-laws of the new association were ratified and the action of the organization committee in the formation of the new association was approved.

The programme was reported and, in accordance with the general scheme of having all the general work of the association performed by the various affiliated associations, the organization of the new Transportation and Traffic association will take over a large part of the work of the American association. The programme for the latter will provide for executive sessions, at which questions of public policy will be discussed. A tentative programme for the American association was submitted and approved.

#### Claim Agents' and Accountants' Associations.

Meetings of the executive committees of the Claim Agents' and Accountants' associations were held on Thursday, January 30, for the purpose of deciding on a programme for the 1908 convention, announcements of which will be made at a later date.

#### Engineering Association.

Meetings of the executive committee of the Engineering association were held on January 30 and February 1. Those present were Messrs. F. G. Simmons, Paul Winsor, F. H. Lincoln, W. H. Evans, J. W. Corning and E. O. Ackerman of the executive committee; Past President H. H. Adams; H. W. Blake, Street Railway Journal; C. B. Fairchild, Jr., Electric Traction Weekly; and L. E. Gould, Electric Railway Review.

After giving a résumé of an informal meeting of the executive committee at Atlantic City, President Simmons stated that the object of this meeting was to outline the work of the various committees for the ensuing year. The "Standardization" committee was instructed to continue with the work agreed on last year and in addition to take up the following group of subjects and any other subjects which it might think it advisable to consider, one of which was the question of specification for axles:

1. Standard height of couplers for city cars.
2. Standard height of couplers for interurban cars.
3. Standard automatic couplers for interurban cars and radial draft rigging.
4. Standard height of platforms.
5. Standard height of car steps.
6. Bumpers.

A committee of five on "Economic Maintenance" was appointed and instructed to consider the question of what is the most economical method of maintenance, whether tak-

ing into consideration the present only or looking into the future.

The committee on control was instructed to continue the present line of work and in addition to consider the question of the proper method of controlling the rate of acceleration.

A committee of five on "Power Generation" was appointed with instructions to consider the question of boiler room instruments, such as CO<sub>2</sub> recorders, draft gauges, etc., and also to take up and report on the practical operation of steam turbine plants.

A committee of five on "Power Distribution" was appointed and was instructed to take up and report on modern methods of overhead construction, with particular reference to the catenary type.

The committee on "Maintenance and Inspection of Electrical Equipment" was instructed to continue its work, amplifying on one or more of the subjects started last year and to take up the question of tests for materials and supplies.

The committee on "Way Matters" was instructed to continue the work of last year and to consider especially the question of the application of bonds, the quality of rails and rail corrugations and such other matters as might in its opinion be advisable.

The committee on "Operating and Storage Car House Designs and Rules for the Construction of Car Houses," yet to be appointed, will be instructed to continue the work originally laid out for it, get out its report and in addition take up and report on rules for the construction of car houses already presented by the main association.

The committee on "Car and Car House Wiring" was instructed to take up in addition to its usual work the question of methods of car and car house lighting.

The committees on "Car Wiring," "Standardization" and "Rules for the Construction of Storage and Car Houses" were turned over to the Engineering association by the American association.

The secretary was instructed to have prepared for distribution drafts of proposed amendments to the constitution and by-laws, providing for the election of an honorary secretary, making the past presidents members of the executive committee and changing the method of amending the by-laws. A discussion was held on the advisability of having all papers in the hands of the secretary 60 days in advance of the convention and dispensing with the reading of reports on the floor of the convention. A suggestion was also made that one day be set aside at the convention for the examination of exhibits.

#### Banquet to Executive Committees.

On Friday evening, January 31, the executive committee of the Manufacturers' association gave a banquet to the members of the executive committees of the other associations at the Imperial hotel. About 60 were present. Joseph R. Elliott, president of the Manufacturers' association, acted as toastmaster and addresses were made by James F. Shaw, Boston; H. H. Vreeland, New York; W. Caryl Ely, Buffalo; Frank Hedley and James H. McGraw, New York; C. S. Sergeant, Boston; John A. Beeler, Denver; Charles C. Peirce, Boston; and C. Loomis Allen, Utica. Important association matters and questions of public relations were discussed.

#### The Conventions for 1908.

At the meetings of the executive committees of both the American and the Manufacturers' associations much consideration was given to the place for holding the annual conventions of the street railway associations next fall. W. G. Evans, president, and John A. Beeler, vice-president and general manager, of the Denver City Tramway Company, were present to urge the claims of Denver as a convention city. That they did their work well was evidenced by the fact that everybody was talking Denver. One of the strong arguments in favor of taking the conventions of 1908 so far west is that the



American association has not as strong a representation from the Pacific coast and the mountain states in its membership as it should have. It is felt by many that if the meetings were held as far west as Denver the local interest aroused would tend to rectify this fault and that probably large accessions to the membership of the parent association would result.

The whole subject will be considered by committees representing both the American and the Manufacturers' associations. Those appointed by President Goodrich of the American association are: James F. Shaw, president Boston & Worcester Street Railway, Boston, Mass.; Arthur W. Brady, president Indiana Union Traction Company, Anderson, Ind.; Frank R. Henry, auditor United Railways Company of St. Louis; and Bernard V. Swenson, secretary-treasurer American Street and Interurban Railway Association, New York. The Manufacturers' committee appointed, in addition to President Joseph R. Ellicott and Secretary George Keegan, consists of Messrs. James H. McGraw, Charles C. Peirce, Henry C. Evans, Arthur S. Partridge, Charles K. Knickerbocker and Hugh M. Wilson.

It is probable that this joint committee will in the near future visit Denver and other cities which may advance proposals for accommodating the conventions. The committee has authority to decide the questions referred to it.

#### VENTILATOR EXPERIMENTS ON THE DETROIT UNITED RAILWAY.

For the past several years experiments have been made at intervals by the board of health of the city of Detroit and the Detroit United Railway to determine upon the most satisfactory means or device for ventilating street cars and some interesting results are reported from these tests.

The cause which led to the carrying out of these experiments was the passage, in the fall of 1905, of an ordinance by the city of Detroit specifying certain requirements for ventilators which it was stated the railway company should adopt on and after November 1, 1905. The stipulations of this ordinance are given in the following extract:

It shall be unlawful for any street railway company to operate upon the streets or highways of the city of Detroit any cars (other than summer or open cars) which are not equipped with ventilators, which, irrespective of the position of doors or ordinary windows, will, of their own action, automatically cause a continuous interchange of the air in the cars. That is, such ventilators as will not only admit fresh air to the car, but also remove the vitiated air from the car. The ventilation shall not be effected by the admission of violent or dangerous drafts, but by the continuous and practically imperceptible process incapable of injuring or endangering the health of anyone. The ventilators used for the purpose shall be automatic and continuous in action, having no movable parts requiring adjustment by car operatives, or subject to being tampered with by passengers. Furthermore, owing to bad conditions of air known to exist in cars during storms, or periods of extreme low temperature, arising from the necessity of closing ordinary windows or transoms to protect passengers at such times, the ventilators used shall be so constructed as to be continuously operative and effective at such times, without admitting rain or snow through the ventilating air passages.

The ordinance further provided that for each day and for each and every car operated in violation of these requirements a separate and distinct offense would be committed, and that such offenses would be punishable by a fine of not more than \$200 and costs.

The requirements of this ordinance could at that time be fulfilled only by the use of a certain patented ventilator. The unjust advantage thus given to a particular device caused the board of health, in connection with the railway company, to conduct experiments on the efficiency of the various devices as indicated by the number of parts of carbon dioxide per 1,000 parts of air found present in cars equipped with such devices under average operating conditions.

A summary of a report made by the board of health to

the common council on February 13, 1906, giving results of a series of chemical tests, is as follows:

Ventilator.	Car.	Temperature.	Humidity.	Parts CO <sub>2</sub> per 1,000.
None	1121	72	57	20.5
End hinge	1121	69	47	13.4
Perry	1121	72	49	16.0
Royal	1106	73	61	28.5

In collecting the samples for these analyses care was taken to secure them under the same conditions as to number of passengers in the car at the time and at the same height above the floor, a height about equal to that of a person standing being considered the most reasonable.

Later tests also indicated the superiority of the "end hinge" ventilator over the other types tested.

The company, however, was not satisfied with these results and is now equipping a number of cars with various systems of ventilation upon which tests will be made at an early date. These will include the several patented ventilators, the "end hinge" type opening outward at the end nearest the rear of the car, so that a direct draft is not created, and operated either singly, in pairs or in multiple, the "center hinge" or type which revolves on an axis parallel with the center line of the car, and a new type, which is simply the use of a brass wire gauze placed over the open end window of the monitor deck, the rest of the monitor deck all around being kept closed by glass windows. It is thought that by this latter method a suction will result from the motion of the car which will cause the vitiated air which usually collects above a plane about five feet from the floor to be drawn out through the gauze-covered opening, drawing in at the same time fresh air from the outside through small openings near the floor.

#### AUSTRALASIAN TRAMWAY OFFICERS' ASSOCIATION.

At a meeting at Sydney, New South Wales, on November 7, 8 and 9, 1907, at which representatives of most of the tramway systems of Australia and New Zealand were present, the Australasian Tramway Officers' Association was organized. The objects of the association, as stated in the constitution adopted at the inaugural meeting, are as follows:

The acquisition of experimental, statistical and scientific knowledge relating to the construction and operation of tramways.

The diffusion of this knowledge among the members of the association, with the view of increasing the accommodation of passengers, improving the service and reducing the cost of operation.

The establishment and maintenance of a spirit of fraternity among the members of the association by social intercourse.

The encouragement of cordial and friendly relations between the tramway undertakings and the public.

The membership is to consist of the chief officers, principal assistants in charge of departments, the secretaries and accountants of Australasian tramways. Meetings are to be held annually and special meetings may be called by order of the executive committee. The next annual meeting will be held at Sydney on October 7, 1908. The following officers were elected: President, John Kneeshaw, traffic superintendent New South Wales Tramways, Sydney; vice-presidents, O. W. Brain, electrical engineer New South Wales Tramways, Sydney, and J. S. Badger, manager and chief engineer Brisbane Tramways, Queensland; secretary and treasurer, George McCoun, accountant electrical engineer's department New South Wales Tramways, Sydney.

With a view to the standardization of accounts a committee was appointed to secure information from the officers of various tramways in Australia as to their classification of accounts and to report at the next meeting. The following papers were read and discussed: "Thermit Welding in Relation to Tramways," by G. R. Cowdery, and "Brakes," by O. W. Brain.

EMBLEMS FOR THE UTICA & MOHAWK VALLEY, SYRACUSE RAPID TRANSIT AND ONEIDA RAILWAYS.

In November last the Utica & Mohawk Valley Railway of Utica, N. Y., the Syracuse (N. Y.) Rapid Transit Company and the Oneida (N. Y.) Railway announced that prizes would be given by each company for suitable emblems or trademarks for display on cars and stationery. The contests closed recently and the award of prizes has just been made. Over 250 designs were sent in. Following a suggestion made by B. A. Frankel of the Utica & Mohawk Valley Railway, who planned the competition, a large majority of the designs submitted contained something of historical significance. The Indian or some object used by the Indian was a favorite subject.

In the competition for the Utica & Mohawk Valley Railway emblem. William T. Schwarz, a student in Syracuse University, was the winner of the first prize, his design representing a stately Indian standing with outstretched hands, overlooking a valley through which a trolley car is passing. The second prize went to J. H. Kuehnling of Utica and the third to G. D. Evans of Utica.

The first prize in the competition for the Oneida Railway Company was awarded to Byron E. White, a civil engineer of Utica, whose design commended itself at once to the committee of judges because of its simplicity and appropriateness. The emblem designed by Mr. White is an inverted Indian arrow head with the name of the company appearing thereon. John Gargan of Syracuse took second prize with the design of a T-rail inclosed in an oval. John Lyth of Utica received the third prize.

Mrs. Margaret Landers Sanford of Clinton received the first prize for a design for the Syracuse Rapid Transit Company; Frederick W. Geisler of Madison, Wis., the second; and J. B. Chase of Syracuse the third. Mrs. Sanford's design is in the form of a medallion with an Indian head appearing on the shield.

In each case the first prize was \$25, the second \$15 and the third \$5.00. The designs of Mr. Schwarz, Mr. White, Mr.

Gargan and Mrs. Sanford are illustrated herewith. The contests were considered successful by the companies. The interest attracted by the competition and the number of designs submitted and the excellence of many of them justified the contests.

The awards of prizes were made by a committee of newspaper men, who did not know the names of the contestants. While no design has definitely been settled upon for any of the roads, it is probable that the inverted Indian arrow head will be adopted for all of the lines, the name being changed in each instance.

MOTOR OMNIBUS TESTS.

United States Consul Frank W. Mahin of Nottingham, England, states that a year or two ago an intense discussion was carried on between the advocates of motor omnibuses and street cars as to their respective merits, the practical results of which he points out as follows:

"Reports from different parts of the country, notably London, where motor omnibuses have been used are adverse in several particulars. Their noise and odor and the alleged injury to the value of property on streets through which they ran were objections from the outset. Now we are told of declining values of motor omnibus shares, of companies tottering on the verge of bankruptcy, of vehicles being retired after patient trial for failing to maintain required standards, or being 'scrapped' for lack of a market.

"The city of Nottingham has experimented with three motor omnibuses for the past two years,

traversing parts of the town not served by street cars, with the view of extending the service if results were satisfactory. The receipts have averaged 20½ cents per mile traveled, while the street cars averaged 25 cents per mile. The receipts of the three omnibuses were \$1,263 less than the working expenses during the last corporation year, leaving nothing for depreciation or interest on capital. Against the street car receipts of 25 cents a mile were working expenses of 14½ cents a mile; the omnibus receipts of 20½ cents a mile were offset by working expenses somewhat larger—the official accounts do not state precisely how much."



Emblems for the Utica & Mohawk Valley, Syracuse Rapid Transit and Oneida Railways.

REPAIRING A COMMUTATOR ON A SMALL ROAD.

BY J. L. SULLIVAN, MASTER MECHANIC ST. FRANCOIS COUNTY RAILWAY COMPANY.

The following is a statement of a repair experience with a 150-kilowatt 500-volt Western Electric generator. A grounded or short-circuited commutator on a generator armature in an isolated plant is a bad thing to deal with. Herewith is a sketch showing the method by which I reassembled such a commutator. It was necessary to take off all armature windings and knock down the commutator, as the mica commutator rings and segments had to be renewed, the whole task being done without the use of a lathe—something that is not to be had in this locality.

In order to carry out the work it was necessary to devise some scheme for setting up the commutator, and this I shall endeavor to explain with the aid of the accompanying sketches.

When ready to reassemble the commutator I put twelve 1/2-inch bolts through holes bored through a hardwood board shown in Figure 1. This was laid on the floor of the engine room with the boltheads underneath. I next placed a galvanized iron band of the same diameter as the inside diameter of the commutator, as shown in Figure 2. Then I placed around the outside another galvanized iron band of the same diameter as the outside diameter of the commutator, as in Figure 2. Then the commutator segments alternately—copper and mica—were stood on end between the two galvanized iron bands, placing the bottom ends so that they would rest on a 5/8-inch round iron ring laid on the board. When all the segments

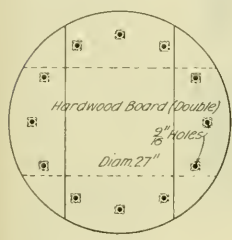

Figure 1.

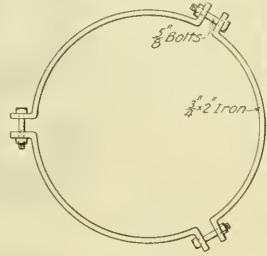
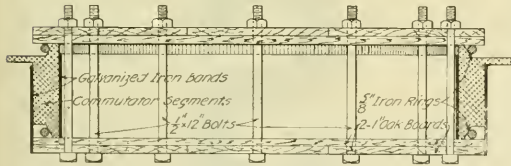

Figure 3.



Repairing Commutators—Figure 2.

were in place another 5/8-inch iron ring, a mate to the first one, was placed on the top as shown. Next a second board frame, similar to frame shown in Figure 1, was placed on top of all and bolted.

When all parts were tight and it was safe to do so the outside galvanized iron band was removed by cutting it in two; then by tightening the bolts and slightly tapping the outside face of the commutator segments the commutator was drawn almost to its proper diameter. Next, six pieces were made of 3/4 by 2 inch iron, to be used as two clamping rings (see Figure 3). These were put on the outside of the commutator; then by drawing up the clamp bolts tight enough to release the tension on the 5/8-inch iron rings, the twelve 1/2-inch bolts were withdrawn and the mica segments were all trimmed almost level inside with the copper segments of the commutator.

The commutator was then ready to be placed on the core or barrel, after setting the rear mica ring in place. When the commutator was placed in position on the core and the front ring adjusted and bolted it was seen, by gauging from the rocker arm while the machine was slowly revolved, that the commutator was only about 1/4 inch out of true.

My next step was to make all secure, and using a carborundum truing device fastened to the rocker arm, the commutator was made true.

The time required for this job was as follows: Knocking down the commutator, 13 days; rewinding and soldering, 8 days.

USEFUL ARMATURE STANDS.

The accompanying half-tone engraving illustrates some of the interesting armature handling methods practiced in the shops of the Winona Railway & Light Company at Winona, Minn. In the foreground is an armature truck, the con-

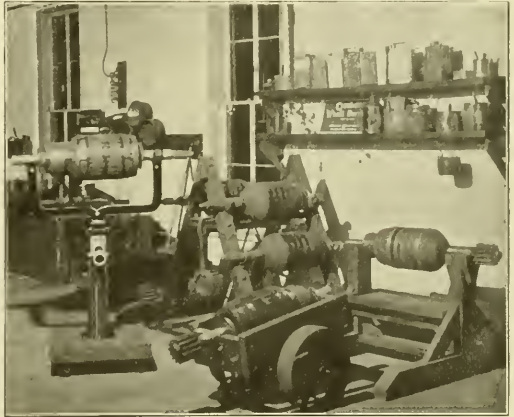

Useful Armature Supports.

venience of which is readily apparent. To the right is an armature rack for winding or repairing purposes. In the center is shown an armature storage rack, which occupies a floor space of 3 feet 6 inches by 3 feet 3 inches. This rack will accommodate seven or nine armatures and its construction is such that it need not be placed against the wall. To the left is a pit jack for removing armatures from a car. By the use of this jack it is necessary only to swing down one side of the lower half of the motor frame, then pick the armature up with the jack from the lower half of the motor frame, and, after lowering the armature to clear the truck rigging, push out from under the car. The device consists principally of an old retired track jack mounted on a roller table and having a pair of Y-ended horns bolted to its head.

These devices, together with a number of other labor-saving tools used in the company shops, were designed and made by N. M. Argabrite, superintendent and master mechanic.

Edward P. Burch, electric railway engineer, is giving a course of lectures to the senior electrical engineering students at the University of Minnesota on "Electric Traction for Heavy Railway Service." These lectures supplement the regular course in electric railways by Professor Springer, and include the following subjects: "Introduction," "Advantages of Electric Traction," "Characteristics of Steam Locomotives," "Characteristics of Electric Locomotives," "Problems of Electrification," "Load Factor, Cost of Steam and Water Power," "Power Plants and Transmission Lines," "Plans of Complete Electrification," "Data Sheets."

**STRIKE-BREAKING AT LOUISVILLE.**

BY A STRIKE-BREAKER.

On November 26, 1907, the Louisville Railway Company succeeded in breaking a strike which had lasted for 12 days and during which time there was considerable rioting. This strike had been called by the union because the company had refused to reinstate several conductors who had earlier been discharged. During the entire period of the strike the writer acted as a motorman strike-breaker. The experiences related here have therefore been drawn from the personal observations of one who "rode the front end" during the trouble.

Before the strike was declared preparations were well under way to continue the operation of the cars with non-union men. Large numbers of men were obtained from lists of available men kept on file by Edwin L. Reed & Co., 185 Dearborn street, Chicago. To secure a large number of additional men required, advertisements were placed in the daily newspapers. These advertisements stated that experienced motormen were wanted for strike work out of town. Although both motormen and conductors were required, only motormen were advertised for in the papers.

Only a small percentage of the many men who applied for strike-breaking work were employed. At 4 o'clock each afternoon the men were checked off and told to report at the railroad station ready to leave town. Usually they were sent to Louisville in gangs of about one hundred. Special cars were provided for the trips. After the train was under way the men were sorted according to the car houses to which they were assigned and a leader was appointed to keep all the men for a particular car house together. It is an all-night ride from Chicago to Louisville and a second-class coach does not provide the most comfortable sleeping accommodations, however, there was very little complaint from the men, as they were apparently satisfied: the cars were warm and they knew that they would not be disturbed until morning.

As the men arrived in Louisville they were taken in special cars to the various car houses. They were instructed to stop before crossing all intersecting lines and to keep sober. The new men were then detailed to ride over the lines on which they would be placed so they might become more familiar with railway crossings and switches. It was not unusual for a new man to make the wrong turn and run his car on the wrong track.

During the strike the food given the men at the car houses was far better than many of them were accustomed to getting. On Thanksgiving day a turkey dinner was served.

For the most part the men had to sleep in the cars. The Louisville cars all have cross seats and very comfortable bunks could be made by laying boards over the backs of the seats and spreading mattresses on the boards. A car would furnish sleeping accommodations for eight men. A little manipulation of the ventilators with the heaters full on would give a very comfortable temperature. All of the men were ordered to get up for the early breakfast and report to the captain for work. If there was no work to be done the orders were to get dinner at 10:30 and report again. Usually the men who had not worked in the morning would be detailed to make the relief runs while the regular men got their dinners. After supper at 4:30 p. m. the relief men made the runs until 8:30 p. m., at which time the cars were taken off. A few days before the strike-breakers were withdrawn the cars were operated until midnight on some of the lines.

During the strike the sympathy of the public was with the company. The strikers established a bus service on several routes, but the buses were not patronized to any extent, as the sympathy of the people was not great enough to make up for the high rates and the poor service given. Ribbon badges and cardboard signs bearing the legend, "I Will Walk," were worn to a considerable extent by sympathizers. The lack of public sympathy and the determined attitude on the part of the

police were largely responsible for the small number of attacks on the cars during the strike. During the first few days many obstructions were placed on the track, but in only one instance was there a serious encounter with the strikers and their sympathizers. This occurred the day before the strike was declared off. In this encounter a policeman shot and seriously injured one of the strikers and several passengers were hurt in the riot. To protect the motormen on the lines where the cars were most likely to be attacked, screens of about one-half inch mesh were placed over the vestibule windows.

The principal factors that contributed to the success of the strike were the strong support of the public, the efficiency of the police, the fact that the company was prepared in advance, the efficiency of the men brought to Louisville by Mr. Reed, and his good generalship. Within a few hours of the time the strike was called a trainload of strike-breakers from Chicago had arrived at Louisville in charge of E. L. Reed and within 72 hours 80 per cent of the company's rolling stock was in operation.

**PUPILS' LOW-FARE IDENTIFICATION CARDS OF THE PUBLIC SERVICE RAILWAY.**

Identification cards are issued by the Public Service Railway Company of Newark, N. J., to school pupils who desire to take advantage of the 3-cent fares under the limited ar-



**Pupils' Low-Fare Identification Cards of the Public Service Railway.**

arrangement established recently. In sending us a sample of the cards M. R. Boylan, general auditor of the company, writes that "the 3-cent fare rate is extended to scholars under 16 years of age, although exceptions to the age limit have been made to high school pupils in several cases. Transfers are issued on school tickets."

It is announced that the tunnels of the Hudson & Manhattan Railroad under the Hudson river from Hoboken, N. J., to Sixth avenue and Nineteenth street, New York, will be officially opened on February 25. President Roosevelt will touch a button to turn on the electric power.

# News of the Week

## Meeting of the Central Electric Accounting Conference.

The Central Electric Accounting Conference meeting, announced for February 11 at Lima, O., will be held at the Lima house. The meeting will be called to order at 11 a. m. by the chairman, M. W. Glover, auditor Ohio Electric Railway, Cincinnati, O. As announced in the Electric Railway Review of last week, the subjects to be discussed are: The settlement of interline ticket and mileage balances, prepaid ticket orders and the handling and settlement of overcharge and loss and damage freight claims. All the accounting officers of electric railways in Ohio, Indiana, Illinois and Michigan are invited to be present.

## Annual Dinner, American Institute of Electrical Engineers.

The annual dinner of the American Institute of Electrical Engineers will be held at the Waldorf-Astoria, Thirty-fourth street and Fifth avenue, New York City, on the evening of Wednesday, February 19. Carrying out the idea established upon former occasions, the feature of the dinner this year will be the tribute rendered by the speakers to the relation of the electrical engineer with public service corporations. The occasion will be designated as the "Public Service Dinner," and among the speakers who have promised responses to toasts are many men prominently identified with public service utilities, either as members of commissions or as operating heads of large utilities organizations. The dinner committee is composed of Robert T. Lozier, chairman; A. A. Gray, Frederick C. Bates and George H. Guy.

## Accident Bulletin of the Indiana Commission.

Accident Bulletin No. 2 of the Indiana railroad commission for the last quarter of 1907 has just been issued. The report states that during the quarter 14 persons were killed and 70 injured on the interurban lines of the state, as compared with 8 killed and 34 injured during the preceding quarter. A derailment on the line of the Indiana Union Traction Company at Indianapolis on November 7, causing one death and 23 injuries, and a derailment on the line of the Indianapolis & Cincinnati Traction Company at Acton on December 12, causing one death and four injuries, partly account for the increase. Of the 99 persons killed by both steam and interurban roads during the quarter 38 were trespassers and 28 were travelers on highway crossings. Eight of the casualties on the interurban roads were to employees.

The commission states that drastic legislation is necessary to keep trespassers off railway tracks and it is its purpose to recommend in its next report to the governor practical measures to abate this fatal nuisance. In regard to crossing accidents the commission says that the responsibility is divided between the public and the companies and that it expects to recommend to the people a provision for some proper division of the expense of separating grades and to the railways the keeping of the highway crossings in perfect repair and the construction and repair of crossing signs.

## Progress of the Cleveland Negotiations.

An important step was taken last week in the work of determining a valuation of the Cleveland Electric Railway property, as a basis for a lease to a holding company, when Mayor Johnson, representing the city, and F. H. Goff, representing the company, agreed upon a valuation of \$5,521,000 for the track and pavement. This question has been one of the most fruitful sources of contention throughout the course of the negotiations and the final agreement was reached only by a compromise. C. H. Clark and Robert Hoffman, the two engineers appointed as appraisers of the track value, representing the company and the city, respectively, each submitted two reports based on allowances of 4 per cent and 8 per cent for depreciation. Under the 8 per cent rule Mr. Clark reported a valuation of \$4,047,000 and Mr. Hoffman of \$3,899,000. Under the 4 per cent rule the figures were \$3,837,000 and \$3,737,000. After some discussion it was decided to compromise on \$3,736,000. The paving estimates were made by Mr. Goff and Mr. Johnson, the figures submitted being \$1,814,000 and \$1,651,000. It was decided to split the difference, making \$1,732,000. Later \$11,000 was deducted for paving done by the city.

Horace E. Andrews, president of the Cleveland Electric Railway, and A. B. du Pont, president of the Municipal Traction Company, have reported an agreed schedule of miscellaneous items amounting to \$520,000. This, however, is not completed and it is estimated that it will be balanced by current liabilities. At a meeting on Monday of this week Mr. Andrews and Mr. du Pont reported an agreed estimate of

\$421,915 for the value of the shops, shop tools and shop stores. This is \$80,000 more than Mr. du Pont's estimate of last spring.

At the Monday meeting Mr. Goff submitted a new estimate for overhead charges and financing of \$2,967,687. The mayor's estimate is \$930,783.

The schedules of physical property now remaining to be decided upon are: Auditor's stores, miscellaneous items and overhead charges. The amount of the physical property already agreed upon, including the items published in last week's issue of the Electric Railway Review, page 149, now approximates \$14,000,000.

Police and street railway men have been employed to count the number of passengers boarding the cars outside of the city limits, as a basis for calculating the value of the franchises.

On Monday night the city council extended the Woodland avenue and other west side franchises for 30 days from February 10, the date on which the city claims they expire. The company claims they do not expire until 1910.

The Forest City Railway has begun operating a new 3-cent fare line, extending from West Seventy-third street and Lorain avenue to East Ninth street and Superior avenue.

## Legislation Affecting Electric Railways.

**Maryland.**—A bill has been introduced into the legislature providing for the appointment by the mayor of Baltimore of a "superintendent of street railways in Baltimore City," who shall verify reports made to the city by street railway companies in regard to their gross receipts with a view to ascertaining the amount due the city and shall have the power to examine all books of the companies, to take testimony of all persons required and to compel the production of all papers necessary. He is to make quarterly reports to the mayor and the city council and to make such suggestions for the regulation and improvement of the street railway service as he may see fit.—A bill introduced in the house aims to prevent overcrowding of street cars in Baltimore by requiring the inspector of buildings to inspect all cars with a view to determining their seating capacity and to issue a certificate for each car specifying the number of passengers that may be carried without overcrowding. When the specified number of passengers shall have boarded a car a sign shall be displayed stating that the car is full and no additional passengers may be allowed to get on.

**Ohio.**—Representative Carl Shuler has introduced a bill for the regulation of public service companies, placing the control of all public and quasi-public corporations in the hands of a state commission, to be appointed by the governor. The commission is to consist of five members, each appointed for a term of five years, at a salary of \$10,000 a year. The bill is in many respects similar to the public service bill passed at the last session of the Wisconsin legislature. One of the principal provisions is that instead of franchises being granted for a definite length of time, only indeterminate permits shall be given, which shall run for such length of time as the corporation conforms to the rules or orders of the commission and to the enactments of the city or village councils. The bill provides that every public utility company shall furnish adequate service and facilities subject to the orders of the commission. The commission shall have power to investigate and ascertain the value of all property of the companies and to compel all public utility companies to keep uniform accounts, open to the inspection of the commission. The commission is to have power to require each company to make such provision for depreciation as shall be determined by the commission. All information in the possession of the commission is to be open to the public at all times. The commission shall investigate any complaint made against a public utility company by any 25 persons, and shall have power to order such changes in the rates or service as it may deem necessary. The companies may make similar complaint to the commission if its orders are deemed unreasonable, and its orders and regulations are subject to court review upon application to the common pleas court, notice to the commission and a public hearing. No injunctions shall be issued suspending any order of the commission except after such application and hearing. The public utility corporations are practically granted a monopoly in municipalities which they serve by a provision that no license or franchise can be granted in a municipality where there is in operation a public utility engaged in a similar service, without first securing from the commission a declaration after a public hearing that there is a reasonable necessity therefor. Municipalities shall have the power to issue bonds to require or construct a public utility upon the assent of a majority of those voting on the question, provided that majority is equal to 60 per cent of the vote cast at the last regular election. The bill also gives the commission power to regulate the issue of stocks and bonds.—Representative Stockwell has introduced a bill pro-

viding that whenever a new street railway company secures a franchise over a line previously occupied by another company whose franchise has expired, it may appropriate the poles, tracks and wires used by the old company. The bill is in the interest of the Forest City Railway of Cleveland.—The senate on January 30 defeated by a vote of 20 to 15 the bill introduced by Senator Howe which provided for the appointment of a state franchise and tax commission to value for taxation the property of public service corporations. This is the bill which was condemned in a circular letter issued by F. D. Carpenter, president of the Central Electric Railway Association, which was abstracted in last week's issue of the Electric Railway Review, page 148.

**Virginia.**—A joint resolution has been presented in the senate to provide for the segregation of the property of public service corporations for purposes of state taxation and the segregation of all other kinds of property for purposes of local taxation.

**Engineers' Club of Philadelphia.**—The Engineers' Club of Philadelphia has removed its headquarters from 1122 Girard street to 1317 Spruce street, Philadelphia.

**Ordered to Equip Cars with Vestibules.**—The Connecticut railroad commission has issued an order to the Connecticut Company, operating the street railways of Middletown, Conn., requiring that all cars operated in that city during the months of December, January, February and March shall be equipped with vestibules. The order is effective on December 1, 1908.

**New York Electrical Show.**—It is announced that the second annual New York electrical show will be held at Madison Square Garden, October 3 to 14, 1908. Sixty per cent of the floor space was allotted to exhibitors before the close of the 1907 show. The officers in charge of the exhibition are: President, George F. Parker; secretary, Dudley Farrand; treasurer, Walter Neumuller.

**Chicago Cold Car Suits Dismissed.**—Corporation Counsel Brundage of Chicago has ordered dismissed about 60 cases brought by the city last year against the street railway companies for operating cars insufficiently heated. The suits were instituted by M. F. Doty, former city superintendent of transportation, and were pending before the Illinois supreme court. Mr. Brundage said that the companies are now meeting all requirements of the city ordinance and that the suits are therefore unnecessary.

**Indiana Conference on Operating Rules Postponed.**—The conference which was to have been held by the Indiana railroad commission with the managers, superintendents and dispatchers of the various interurban roads in the state on February 10 at Indianapolis has been postponed until February 18. The conference is for the purpose of arriving at a uniform system of operating interurban trains and to urge the managements of the roads to adopt uniform and improved rules governing their trainmen and to urge the necessity for the observance of the rules.

**Extension of Chicago Elevated Platforms Opposed.**—The Chicago real estate board on February 6 passed resolutions condemning the plan of the Chicago elevated roads to lengthen the loop platforms so as to accommodate two trains at once, on the ground that any such extension would give only temporary relief from congestion, would be unsightly and would irreparably damage abutting property. The resolutions favored the plan proposed by Bion J. Arnold for a through routing of a portion of the elevated trains. A large number of owners of property in the streets served by the loop have signed a petition favoring the extension of the platforms.

**American Institute of Electrical Engineers.**—At a meeting of the Worcester Polytechnic branch of the American Institute of Electrical Engineers, held on January 31 at Worcester, Mass., W. F. Foster, engineering assistant to the general manager of the Union Switch & Signal Company, gave an illustrated talk on "Railway Signaling," describing the various types of signal systems now generally used.—A meeting of the Armour Institute of Technology branch was held in Chicago on February 6. M. Gilmore presented a paper on "Train Lighting Systems." On February 13 a special meeting will be devoted to a discussion of the subject of "The Value of an Engineering Education." At the meeting on February 20 T. W. Simpson will present a paper on "Heavy Electric Railway Practice."—At a meeting of the Pittsburg section on February 5 papers on subjects connected with the use of varnished insulating cloth were presented by Henry W. Fisher, A. B. Reyners and G. A. Jacobs.—The fifth regular meeting of the Columbus branch was held on February 5. George Loring of the American Electric Lamp Association presented a paper on "The Manufacture and Performance of Large Carbon and Metal Filament Lamps."

# Traffic and Transportation

## Chicago Elevated Road Traffic.

The South Side Elevated Railroad of Chicago carried a daily average of 112,707 passengers in January, an increase of 20,296, or 21.96 per cent, over January, 1907.

The Northwestern Elevated Railroad carried an average of 100,392 passengers daily, an increase of 11,760, or 13.27 per cent.

The Metropolitan West Side Elevated Railway carried an average of 141,564 passengers daily, a decrease of 8,601, or 5.73 per cent.

## Reduced Rate Between Toledo and Cleveland.

In response to our request F. W. Coen, general manager of the Lake Shore Electric Railway, Norwalk, O., has written us as follows concerning the 30-day excursion rate between Cleveland and Toledo: "On January 8 we established a 30-day excursion rate between Cleveland and Toledo on the following basis: Single fare \$1.50, reduced from \$1.75; round-trip fare \$2.75, reduced from \$3.15. This reduction has stimulated traffic somewhat, but the experiment has been carried on for such a short period of time that we are unable thus far to determine what the result will be."

## Chairmanship of Central Electric Traffic Association.

We have been asked to direct further attention to the fact that a competent man is desired for the chairmanship of the Central Electric Traffic Association. As was announced in the account of the formation of the traffic association, published in the Electric Railway Review of January 25, 1908, it was decided to elect one man to the office of chairman of this association and secretary and treasurer of the Central Electric Railway Association. A committee was appointed to assist in the selection of an individual thoroughly posted in freight and passenger tariffs. Applications for the position should be made to F. D. Carpenter, president of the Central Electric Railway Association, Lima, O.

## Traffic on United Railways of St. Louis.

During the year 1907 313,945,149 passengers were carried by the United Railways of St. Louis, of whom 91,797,561, or 29.24 per cent, rode on transfers. The cars traveled 38,447,977 miles. The figures show an average of 8.17 passengers on each trip. In 1907 the roads transported 22,422,363 more passengers than in 1906. The gross revenue from fares was \$10,659,037, an increase of 5.36 per cent. The average fare on all the lines was 3.38 cents. On some lines the average fare was considerably below 3 cents, and on one line it was 2.2 cents a ride. On one line 56.01 per cent of the passengers traveled on transfers, and on nine other lines the transfer traffic reached from 40.99 to 51.11 per cent of the total.

The number of passengers per car-mile on the various lines was as follows: Hamilton, 4.66; Page, 8.02; Taylor, 9.89; Vandeventer, 9.88; Chouteau, 4.42; Compton, 9.32; Park, 10.39; Tiffany, 7.25; Clayton, 1.78; Delmar-Clayton, 4.65; Midland, 4.33; Cherokee, 6.95; Tower Grove, 6.09; Grand, 12.59; Cass, 8.44; Easton, 9.83; Lee, 7.63; Marcus, 5.17; Spring, 5.64; Bellefontaine, 6.82; Eighteenth, 9.84; Jefferson, 14; Laclede, 11.99; Market, 8.14; Olive, 9.58; Broadway, 7.76; Fourth, 9.61; Seventh, 5.26; Manchester, 6.35; Hodiadmont, 7.38; Union, 4.63; Sarah, 8.48; and suburban county lines, 3.19.

## safeguarding Children in Boston.

The Boston Elevated Railway is publishing in the Boston newspapers an advertisement addressed "To parents and others having the care or custody of children," which says:

"Safety of operation is the paramount aim of the management of this company in its efforts to make the service on its system satisfactory. A large portion of the accidents that occur, especially those to children, are due to causes such as jumping on cars to 'catch' a ride, running in front of cars, putting things on the rail, and the like, causes which the company and its employes cannot control.

"At best every moving vehicle, whether carriage, wagon, automobile or street car, is a source of possible injury to careless users of the highway. Parents and others concerned should require their children not only not to 'catch' rides, etc., but to avoid roadways in which there is evident danger from passing street cars.

"The company is unsparing in its expenditures and unceasing in its efforts to promote the safety of its patrons and of others using the streets where its cars are run, but it cannot control the actions of children and of other persons using

these streets. This can be done only by individuals. The company points out the danger and appeals to the public for co-operation in protecting the lives and persons of those whose tender years and lack of judgment render them but partly capable of caring for themselves."

#### Hearing on Chicago Elevated Loop Situation.

The committee on local transportation of the city council of Chicago met on February 6 to consider the congestion on the union loop. Representatives of the various elevated railroads were present and submitted suggestions for the improvement of conditions.

Howard G. Heltzer, president of the Metropolitan West Side Elevated Railway, said that the only trouble experienced on the loop was during rush hours. He attributed the trouble to short trackage on the loop, short platforms, delays at crossings and stations too close to junction points. If these difficulties were remedied and more stub-end terminals established there would be no further trouble, he thought.

Clarence A. Knight, president of the Chicago & Oak Park Elevated Railroad, stated that that company desires the right to operate a portion of its trains to its terminal in Market street, instead of being obliged to operate all trains to and around the loop.

Charles V. Weston, president of the South Side Elevated Railroad, urged the necessity of lengthening the platforms at each station on the loop so that they could accommodate two 6-car trains at the same time. He suggested that the loop be divided into four quarters by the building of intersecting lines, north and south and east and west, and that each elevated road be given one of these quarters for its individual use.

Mason B. Starring, president of the Northwestern Elevated Railroad, advocated the lengthening of the platforms of the loop stations and asked for the passage of an ordinance permitting the construction of a stub-end terminal in North Water street.

#### Local and Joint Freight Tariffs of Toledo Urban & Interurban Railroad.

We have received from Charles J. Lauey, assistant general freight agent Toledo Urban & Interurban Railroad, Bowling Green, O., copies of the local and joint freight tariffs of that company. The tariffs have been filed with and accepted by the interstate commerce commission and the Ohio railroad commission as meeting their requirements. The rules governing the local freight tariff include the following:

"The charge for less than carload shipment will not be greater than the minimum carload charge for the same kind of freight.

"For information regarding carload shipments agents will communicate with the general freight department.

"In all cases where shipments are receipted for and accepted to points where no agent is installed the shipper must prepay charges and fully understand that said goods are received and receipted for solely at the owner's risk, and he should, for protection, notify consignee of the day and train on which shipment goes forward.

"No article of any description will be accepted on passenger cars for transportation. Agents will refer shippers to freight department or Pacific Express Company.

"Agents will carefully check all shipments unloaded at their station and will be responsible for all articles shown on the waybills unless conductor's attention is called to shortage or damage and his indorsement or signature secured on the billing. Conductors will check all shipments loaded at stations and will be responsible for all articles billed unless agent's attention is called to the shortage or damage and his indorsement or signature secured on the waybill. Agents will report at once any over, short, damaged, refused or unclaimed freight, and will be responsible for any loss occasioned by their failure to make these reports promptly.

"Carload shipments, handled as trailers, cannot be accepted for Toledo, O., over traction line. Such shipments are subject to the Toledo Railway & Terminal Company's switching charges."

The local tariff is governed by the official classification, with the following exceptions:

"Bread.—In baskets, 25 cents per basket. Return of empty basket, 5 cents each.

"Bicycles.—Not crated, taken at owner's risk, the same to be noted on shipping order over signature of shipper.

"Green Hides, Fertilizer, Bones or Other Commodities of an Injurious Odor.—Will not be accepted for transportation in merchandise cars.

"Household Goods.—Less than carload, accepted at double first-class rate when released to a valuation of \$5.00 per 100 pounds, as provided in the official classification. When not so released, rate of three times first-class will apply. All shipments to be prepaid.

"Ice Cream.—In tubs, 25 cents each. Return of empty tubs, 10 cents each.

"Minimum Weights.—Terms of official classification will apply on carload shipments, subject to the loading capacity of the car.

"Pianos.—If not boxed taken at owner's risk, the same to be noted on shipping order over signature of shipper.

"Trunks.—If not crated or boxed taken at owner's risk, the same to be noted on shipping order over signature of shipper. Freight must be prepaid.

"Articles too long or bulky to be handled conveniently in merchandise cars must not be accepted. When shipments are offered, communicate with the general freight department for instructions."

The following roads are parties to the joint tariff of the Toledo Urban & Interurban road: Detroit Monroe & Toledo Short Line Railway, Dayton & Troy Electric Railway, Dayton Covington & Piqua Railway, Ft. Wayne & Wabash Valley Traction Company, Ft. Wayne & Springfield Railway, Ohio Electric Railway, Springfield Troy & Piqua Railway, Toledo & Indiana Railway, Toledo & Western Railroad, Toledo Port Clinton & Lakeside Railway, Western Ohio Railway.

The joint tariff is governed by the official classification, with the exception of green hides, etc., and household goods, as provided in the list of exceptions in the local tariff, stated in the foregoing, and with the following additional exceptions:

"Live Stock.—Will not be accepted for transportation to points on the Ohio Electric Railway or other lines with the Ohio Electric Railway as an intermediate carrier.

"Minimum Weights.—As per official classification, subject to loading capacity of car, on carload shipments."

Among the rules governing the joint tariff are the following:

"Class rates to points on the Ohio Electric Railway, routed via Springfield Troy & Piqua Railway, will take an arbitrary of three cents per 100 pounds for transfer at Springfield, O., to be added to Springfield Troy & Piqua proportion of rate.

"Carload shipments can be handled only under special arrangements and subject to the restrictions in the various municipalities through which the lines mentioned in this tariff are operated. Carloads will be handled subject to all rates and conditions of this tariff when possible.

"This company will not accept shipments of freight in carloads or less destined to points on this road or connections, where freight must be prepaid, when shipments are consigned 'to order,' 'to order, notify,' or 'to notify.' Shipments for prepaid stations can only be accepted when they are straight consignments and all charges are prepaid.

"Freight may be accepted for prey stations with the understanding that it is to be unloaded at owner's risk. Agents will give receipts accordingly.

"Articles too long or too bulky to be loaded conveniently in merchandise cars must not be accepted. When shipments are offered agents will communicate with general freight department for instructions.

"Articles rated lower than fourth-class rate will be handled at fourth-class rate to points where fifth and sixth class rates are not shown.

"Articles rated lower than fifth-class rate will be handled at fifth-class rate to points where sixth-class rates are not shown.

"C. O. D. shipments or shipments billed to the order of ..... cannot be accepted to points on the Ohio Electric Railway."

**Through Routes in Chicago.**—Some of the through routes for which provision is made under the Chicago City Railway and the Chicago Railways Company ordinances have been established.

**Mail Service on Illinois Traction System.**—The Illinois Traction Company has established a mail service between Peoria and Bloomington. One car will leave each of these points at 7 o'clock every morning.

**Fares to Coney Island.**—In a letter to Chairman Wainwright of the New York assembly committee on "Railroads" the public service commission, first district, asserts that it has jurisdiction over the fares to Coney Island.

**Bill for Universal Transfers in District of Columbia.**—A subcommittee of the "District" committee of the house of representatives has drafted a bill providing for universal transfers in the District of Columbia. The bill provides that the transfers shall be issued good over all lines for one cash fare of five cents, but the companies must continue to sell six tickets, each good for a fare and transfer, for 25 cents. The bill provides for a penalty of \$25 if a transfer is refused by a company, and for a fine of not more than \$100 for any officer or agent who shall violate any of the provisions of the act. Provision is also made for fines for the unauthorized use of transfers.

# Construction News

## FRANCHISES.

**Redlands, Cal.**—George H. Dunn and Charles S. Chesnut have been granted an extension of three months to the franchise which they hold for the construction of an electric railway on Colton avenue, Sixth street, State street, Citrus avenue, East Highland avenue and Reservoir street in Redlands. The franchise expired on February 6.

**San Diego, Cal.**—A right of way franchise has been granted to F. W. Peterson for the construction and operation of an electric railway, sidings, bridges and switches at South San Diego. He has from 4 to 18 months in which to build the road.

**San Francisco, Cal.**—The board of election commissioners at a recent meeting considered the petition of John J. Egan that his application for a franchise for 242 miles of street railway be placed on the ballot at the next election. It was found that no subjects except bond issues could be considered at such an election and that the proposition must be held over until the November election. Mr. Egan says he represents eastern capitalists, who propose to build an extensive system of subway and surface lines in competition with the United Railways.

**Shelbyville, Ind.**—The Capital Circuit Traction Company, which secured a franchise some months ago to use the streets of Shelbyville for the operation of its interurban cars, has applied to the council for an extension of time in which to start work on the line. February 20 was specified in the franchise as the date on which construction was to be begun. The object of the company is to encircle Indianapolis with a belt line serving the county seats in the seven adjacent counties. (Noted July 20, 1907.)

## RECENT INCORPORATIONS.

**Cincinnati Madison & Western Traction Company.**—Incorporated in Indiana to build a number of short lines radiating from Scottsburg to surrounding cities and towns in Indiana and Ohio. These new lines will be built as extensions of the Indianapolis & Louisville Traction Company's line from Seymour to Jeffersonville, now in operation. The different routes as outlined in the articles of incorporation are as follows: From Scottsburg through Scott and Jefferson counties to Madison, and thence in a northeasterly direction through Switzerland, Ohio, Ripley and Dearborn counties in Indiana to Cincinnati; also in a westerly direction from Scottsburg through Salem in Washington county and through Paoli to West Baden and French Lick; also northwesterly from Scottsburg to Bedford, Ind. It is announced that construction work will be started in the spring. Capital stock, \$50,000. Incorporators: J. E. Greeley, Louisville, Ky.; S. D. Miller, Maurice Cahill, G. B. Gaston and G. N. Owen, Indianapolis, Ind.

**Mississippi Valley Interurban Railway.**—Incorporated in Illinois to construct an interurban railroad from Springfield to Quincy, Ill., by way of Petersburg, Virginia, Rushville and Mt. Sterling; from Mt. Sterling to Hillsboro, Ill., by way of Pittsfield, Hardin, Jerseyville, Winchester and Jacksonville; from Hillsboro to Greenville and Shelbyville through Owanoo and Vandalia, and from Greenville to Carlisle, Nashville, Pinckneyville and Murphysboro, Ill. Headquarters, Springfield. Incorporators: James H. Ward, Butler; George E. Watson, Hillsboro; H. R. Lakin, Rochester; John F. Melick and F. A. Melick, Springfield, Ill. It is stated that the new corporation will acquire control of the Sangamon Valley Railway, which proposes to build from Springfield, Ill., to Hillsboro, 53 miles, and of which road J. E. Melick of Springfield is president.

**Texas Union Traction Company, Clarksville, Tex.**—Incorporated in Texas to build an electric railway between the cities of Texarkana and Sherman, a distance of 154 miles; between the cities of Paris and Ennis, 124 miles; between the cities of Texarkana and Ft. Worth, 215 miles; between the cities of Paris and Cleburne, 155 miles, and for extensions and spurs leading out from points on the main line to inland towns, estimated distance from 5 to 20 miles from the main line. Incorporators: C. P. Moore and John T. Upchurch of Longfellow, Pecos county, and A. A. St. John of El Paso, Tex.

## TRACK AND ROADWAY.

**Americus Railway & Light Company, Americus, Ga.**—Orders for machinery and electrical equipment for this proposed 5-mile street railway have been placed and work on

the line will be started at once. The company is capitalized at \$250,000 and has deposited a guarantee bond with the city for \$25,000. A 20-year lighting contract also is included in the franchise under which the road will operate. A. N. Walker, president. (Noted January 4.)

**Ardmore Traction Company, Ardmore, Okla.**—Rapid progress is reported on this company's line in Ardmore and extending north to a park, and it is announced that 7½ miles of track will be completed and in operation by next June. J. F. Robison, general manager, Ardmore. (Noted December 14, 1907.)

**Argenta Railway, Argenta, Ark.**—Announcement is made that this company has let the contract for the construction of its electric line in Argenta to the Electric Construction Company, Little Rock, Ark. It is stated that the overhead work will be started within a few days and the line completed within 90 days.

**Athens, La.**—The Athens Progressive League, recently organized, has appointed a committee to solicit for the construction of an electric railway from McNeill, Ark., by way of Athens to Natchitoches, La.; also for another line from Shreveport by way of Minden to Athens. E. A. Watson, president; A. G. Pace, vice-president; Carl Campana, secretary-treasurer; S. J. Crump, assistant secretary.

**Boise Valley Railway, Boise, Idaho.**—Announcement is made that the lines of this company from Boise to South Boise, from Boise to the fair grounds and the cemetery and from Boise to Ustick and Onwiler will henceforth be operated by the railway company and not the Boise Valley Construction Company, as heretofore, the property recently having been turned over to the former company.

**Burlington-Bonaparte Interurban Railway, Burlington, Ia.**—E. E. Egan, secretary, writes that all surveys have been completed for this electric line, which will connect Burlington and Bonaparte, Ia., a distance of 40 miles, serving the intermediate towns of Augusta, Denmark and West Point, with a branch from Denmark to Ft. Madison, Ia. Power for operating the line will be secured from the Des Moines river at Bonaparte. The Wallace-Coates Engineering Company, Ellsworth building, Chicago, made the surveys and is now engaged in preparing plats and profiles for the report.

**Centralia & Chehalis Railway & Power Company.**—Announcement is made that this company, which will build an interurban line between Chehalis and Centralia, Wash., has purchased a 10-mile interurban line in southern California, including the power station, rolling stock equipment and rails, all of which will be moved and used in the construction of the line in Washington. F. W. Boyne, a Los Angeles promoter and capitalist, built the southern road at a cost of \$180,000, but on account of financial reasons its operation was discontinued after the first three days and last week it was sold to the Centralia & Chehalis company. Six passenger cars, 20 freight cars, a fully equipped power plant and nearly 10 miles of 60-pound steel rails will be shipped to the new line as soon as possible and it is planned to have it completed and in operation inside of a year. B. J. Weeks, Tacoma, Wash., is general manager.

**Connecticut Company, New Haven, Conn.**—The state board of railroad commissioners has granted this company permission to take by condemnation proceedings the necessary land for a right of way over which to construct and operate its proposed line in Middlebury, Conn. The company intends to build an electric line from Waterbury to Middlebury and Woodbury, Conn. W. P. Bristol, general manager, New Haven, Conn.

**Denver & Interurban Railway, Denver, Colo.**—Grading on this company's 44-mile interurban line from Denver to Boulder, Colo., is practically completed and it is expected that the line will be ready for operation by June 1 next. Its 7-mile extension to Ft. Collins was placed in operation on December 28, 1907, together with the four miles of city track in Ft. Collins. H. W. Cowan, chief engineer, Denver, Colo. (Noted January 4, 1908.)

**Des Moines, Ia.**—A. Anderson, an engineer of Lake City, Ia., has applied to the Commercial Club of this city for support in promoting an electric railway between Des Moines and Lake City and probably extending into northwestern Iowa. He states that \$100,000 has been pledged toward its construction and asks the aid of the club in arranging for terminals in Des Moines. He proposes to build the line by stock and bond subscriptions.

**Ennice Lafayette & Abbeyville Railroad, Ennice, La.**—It is announced that this company will start construction work on its proposed 55-mile line some time in May. The road will



connect Eunice and Abbeyville by way of Lafayette, Church Point and Maurice, La. The motive power has not been decided upon. Capital stock, \$1,000,000. James J. Lewis, president; George A. Clark, vice-president, Eunice, La.; C. D. Cafery, secretary and treasurer, Lafayette.

**Ft. Wayne & Springfield Railway, Decatur, Ind.**—Contracts for the construction of a branch line from Decatur to Berne, Ind., and a concrete bridge probably will be let during the next six months by this company. W. H. Fledderjohann, general manager, Decatur, Ind. (Noted November 16, 1907.)

**Frankfort Delphi & Northern Traction Company, Frankfort, Ind.**—It is stated that the early completion from Frankfort to Delphi, Ind., of this proposed interurban road is practically assured. A bond issue of \$700,000 has been made and the entire right of way between the two cities secured. This follows the old Rossville gravel road through Edna Mills, Prymont and on to Delphi, 27 miles. It is stated that a dam will be built at Prymont for the generation of power to operate the system, as well as for commercial purposes. A franchise for 25 years has been secured in Monticello, Ind. W. Cohee, Frankfort, Ind., is treasurer. (Noted December 21, 1907.)

**Grand Rapids Electric Railway, Grand Rapids, Mich.**—At a recent meeting of stockholders it was voted to increase the capital stock from \$2,000,000 to \$15,000,000 and to construct a road from Grand Haven by way of Grand Rapids to Alpena and Bay City; also from Grand Rapids to Kalamazoo, Battle Creek, Coldwater and other towns in the southern part of Michigan. This will be a part of a 500-mile system of electric lines radiating from Grand Rapids and extending into Ohio. J. W. Boynton, president and general manager, Grand Rapids, Mich. (Noted May 11, 1907.)

**Grayson Electric Corporation, Christiansburg, Va.**—The Vaughan Construction Company has recently purchased the lighting system of Christiansburg and Cambria, Va., together with the Grayson Electric Corporation, which furnishes power for the lighting systems. Under the name of the electric company it is proposed to build an electric railway connecting the two towns, a distance of about 2¼ miles. It is proposed to begin work in the spring. J. L. Vaughan, president.

**Hopkinton, R. I.**—A bill recently was presented to the Rhode Island senate providing for the construction of an electric railway between Westerly and Ashaway. Land may be acquired by condemnation proceedings if necessary and the company may manufacture and sell electricity for light, power and heat. No plan was offered showing the proposed route. The company must, however, cross steam roads either above or below grade, and the consent of the town councils must be secured before construction work may be started. Capital stock, \$100,000. Leverett A. Briggs, William J. Battey, Alexander B. Briggs, Frank Hill and John W. Sweeney are named in the bill as incorporators. Senator Cole, Hopkinton, R. I., presented the application to the senate.

**Idaho Oregon & Washington Electric Railway.**—A meeting of citizens has been called by the mayor of Pomeroy, Wash., to consider the proposition of Frank McKean, trustee of this company, relative to the construction of an electric railway connecting Pomeroy, Asotin and Anaton, Wash. According to surveys now being made the proposed route lies up the Pataha creek six miles, thence across the Lewiston flat to the McGuire gulch, and down the gulch to Asotin. It was originally planned to connect with Lewiston, Idaho, but owing to the expense of bridging the Snake river and other complications, the idea is said to have been abandoned. The company requires about 20 per cent of the cost of the road to be subscribed by local capital.

**Indianapolis Huntington Columbia City & Northwestern Railway, Syracuse, Ind.**—This company, which has been in the hands of William L. Self, Syracuse, Ind., as receiver, was sold by order of the superior court of Marion county at Warsaw, Ind., on February 1 to Melvin A. Peoples, Chicago, for two-thirds of the appraised value, the minimum price. This company has built five miles of track from Syracuse to Vawter's Park and has about five miles additional graded toward Goshen, Ind. The entire project contemplated connection of Goshen and Huntington by way of Syracuse, Wawasee Lake and Columbia City. Mr. Peoples is acting in connection with Burns & Co., Isabella building, Chicago, who contemplate reconstruction and extension of the road in accordance with the original plan.

**Interurban Railway, Des Moines, Ia.**—It is reported that an extension from Woodward to Ogden, Ia., is contemplated.

**Kenora, Ont.**—The taxpayers of this city are said to have voted in favor of the construction of a municipal street railway. D. H. Currie is city clerk.

**Mt. McKay & Kakabeka Falls Electric Railway.**—This company has applied for permission to cross the tracks of the Canadian Pacific, the Grand Trunk and the Canadian Northern railways with its proposed electric line between Port Arthur and Ft. William. A hearing before the dominion board of railway commissioners is in progress at Ft. William.

**North Yakima, Wash.**—At a meeting held last week at Zillah, Wash., for the purpose of organizing a company to build an electric railway from North Yakima to Granger, Wash., by way of Parker and Zillah, 32 miles, a committee was appointed to confer with the officials of the Yakima Valley Transportation Company to ascertain if that company would undertake the construction of its line to Granger. If this is not done it is stated that the new company at once will proceed with the building of the proposed line. W. N. Granger, H. H. Lombard, J. H. Thomas, A. P. Wilcox, F. G. Page, George P. Eaton and C. H. Putnam of the Yakima country are interested.

**Omaha & Council Bluffs Street Railway, Omaha, Neb.**—President G. W. Wattles has announced that the company proposes to complete this year the extensions which have been promised, namely, the extension of the South Tenth street line to Riverview park and the Twenty-fourth street line from Leavenworth to Cuming street, but that until the market for securities improves it will be impossible for the company to engage in any extensive building.

**Ottawa (Ont.) Electric Railway.**—It is stated that this company will proceed early in the spring with the extension of its line in accordance with the by-law passed by the city council of Ottawa last fall. The extension will reach the Experimental Farm by way of Preston street. All of the special work, such as curves, switches, etc., has been ordered and some of it is already on the ground. The road will intersect the Grand Trunk Railway's main and branch lines, which cross Preston street at two different places. A. Ahearn, president, Ottawa, Can.

**Pittsburg, Pa.**—It is reported that Thomas Fitzgerald of Baltimore, Md., is interested in a new company which is being organized to build an electric railway from Clarksburg, W. Va., to Pittsburg, Pa. Mr. Fitzgerald is said to be in New York concluding financial arrangements for its construction and engineers are now engaged in making surveys for the route. The line will be equipped for freight as well as passenger service and work will be started early in the spring.

**Quincy, Cal.**—J. O. Moncur is said to be interested in a proposed railway from Quincy to the Hartwell ranch on the Western Pacific Railway, about three miles, the line to be operated either by steam or electricity. Local capital to the extent of \$13,000 is said to have been subscribed. (Noted December 21, 1907.)

**Redlands Central Railway, Redlands, Cal.**—Announcement is made that this line is now completed and ready for operation in the city of Redlands. The last of the tracklaying was completed at the corner of Orange street and Citrus avenue, where the line intersects that of the San Bernardino Traction Company on January 29 and service was to be started on February 1. Surveys have been made for the extension of the road out on Brookside avenue to Riverside, and it is expected that as soon as the city line is in regular operation work on the extension to Riverside will be started, thus affording direct connection between Redlands and Riverside by an electric railway. A. G. Hubbard is president; J. H. Fisher, vice-president and general manager; F. E. Sanford, secretary; C. S. McWhorter, treasurer. (Noted October 5, 1907.)

**St. Joseph Valley Traction Company, Elkhart, Ind.**—It has been decided to delay building the proposed extension of this line from Middlebury to Elkhart, Ind., until the necessary bonds can be floated. The road extends from Angola to Middlebury and at present is operated by steam locomotives, although eventually it will be an electric line, as originally planned. At one time a gasoline-electric motor car was used in connection with the locomotives, but since this was burned some time ago steam has been used exclusively. H. E. Bucklen, general manager, Chicago, Ill. (Noted November 30, 1907.)

**Shrewsbury, Pa.**—At a meeting held in this city on February 3, which was attended by residents of Glen Rock, Loganville and Paradise, Pa., a company was formed to construct an electric railway from Shrewsbury to York. Temporary officers were elected as follows: President, D. E. Godding, Loganville; vice-presidents, Charles Williams, Paradise, and C. B. Smith, Shrewsbury; secretary, John H. Keller; corresponding secretary, W. G. Allen, both of Shrewsbury; treasurer, Jacob L. Myer, Glen Rock. The following executive

committee was appointed to carry on the preliminary work; W. G. Allen, William Able and J. H. Keller, Shrewsbury; D. E. Gooding, Frank J. Beck, J. W. Bailey and Samuel Hartman, Loganville; George M. Leader and Charles A. Williams, Paradise; Jacob L. Myer and B. F. Seitz, Glen Rock; G. F. Miller, New Freedom.

**Stratford, Ont.**—The municipality of Stratford, Ont., is said to be considering the construction of an electric street railway in that city. The Ontario West Shore Electric Railway, which has a charter to build an interurban road from Goderich to Kincardine, Ont., has applied for permission to continue the line to St. Joseph and Stratford and it is stated that if this is done the city of Stratford proposes to allow it to operate in the city provided that control of the tracks within the city limits is vested in the municipality.

**Terre Haute Indianapolis & Eastern Traction Company, Terre Haute, Ind.**—It is announced that this company expects to spend about \$75,000 for improvements on its Terre Haute lines within the next few months. T. F. Grover, general manager, Terre Haute.

**Washington Frederick & Gettysburg Railway, Frederick, Md.**—This company has ordered a survey for a further extension of its line from Lewistown to Rocky Ridge, Md. The road eventually will be built to Thurmont and Emmitsburg. D. C. Kemp, president and general manager, Frederick, Md.

**Windsorville & East Hartford Street Railway.**—It is stated that this company is concluding arrangements for the necessary capital to construct its proposed electric line in East Windsor, South Windsor and East Hartford, Conn. The company was organized with a capital stock of \$500,000, a part of which will be raised by subscriptions.

**Winona Interurban Railway, Winona Lake, Ind.**—The sales of stock for the Warsaw and Wabash extension of the Winona Interurban Railway are said to have been far above the expectation of the promoters, who now announce that by the time the Winona assembly opens next August through cars will be running between Winona Lake and Indianapolis, Ind. Graders are at work on the Warsaw and Peru extension of the road and it is planned to have cars running between the two cities within the next five months. S. C. Dickey, general manager, Winona Lake, Ind. (Noted January 25.)

**Woodstock Marengo Genoa & Sycamore Electric Railway.**—This company expects to begin grading some time in May on its proposed electric line which will extend southwest from Woodstock, by way of Marengo and Genoa, to Sycamore, Ill., 38 miles. The company was incorporated last November, with headquarters at Chicago, Ill. It is now ready to receive bids for material and for building the line. Charles A. Spenny, secretary, Chicago, Ill. (Noted November 9, 1907.)

#### POWER HOUSES AND SUBSTATIONS.

**Chambersburg Greencastle & Waynesboro Street Railway, Waynesboro, Pa.**—It is stated that this company will increase the capacity of its Waynesboro power station in order to care for the additional load which will be required when its extension from Greencastle to Chambersburg has been completed. J. MacWolf, general manager, Waynesboro, Pa.

**New Jersey & Pennsylvania Traction Company, Trenton, N. J.**—This company has purchased a 1,500-horsepower engine for use in its power station at Yardley, Pa. It is stated that the plant will be enlarged and improved. John G. Honecker, general manager, Trenton, N. J.

**Northern Texas Traction Company, Ft. Worth, Tex.**—The power station equipment for which this company let contracts last fall will be installed in the Handley station in the near future. The approximate cost of the new machinery will be about \$150,000. It consists of a 1,500-horsepower engine, two boilers and a new 1,500-horsepower electric generator, together with the auxiliary pumps, condensers, etc. H. T. Edgar, vice-president and manager, Ft. Worth. (Noted November 23, 1907.)

**Terre Haute Indianapolis & Eastern Traction Company, Terre Haute, Ind.**—It is stated that this company will enlarge its Water street power station by the installation of a 500-kilowatt generator. T. F. Grover, general manager, Terre Haute.

**Virginia Passenger & Power Company, Richmond, Va.**—This company has awarded a contract to James Leffel & Co. for two 56-inch Samson turbines, direct connected to Allis-Chalmers alternators. This is part of the new equipment which was recently authorized by the federal court at an approximate cost of \$250,000. S. W. Huff, general manager, Richmond, Va. (Noted December 21, 1907.)

## Personal Mention

Mr. Harry S. Calvert, Etna, Pa., has been appointed secretary of the new Pennsylvania state railroad commission.

Mr. Gordon W. Wattles, president of the Omaha & Council Bluffs Street Railway, will start next week for Los Angeles, Cal., and will soon leave for a four months' trip around the world.

Mr. Charles Hamilton, division superintendent of the Cincinnati Northern Traction Company, has been appointed superintendent of the Hamilton city lines, succeeding Mr. A. E. Rehner, resigned.

At a meeting of the directors of the Anderson (S. C.) Traction Company on January 30 Mr. Robert E. Ligon was elected president and general manager to succeed Mr. Edwin W. Robertson and Mr. William Elliott, resigned.

Mr. Guy E. Tripp, vice-president of Stone & Webster, Boston, Mass., and Mr. H. F. Grant, general manager of the Seattle Electric Company, recently made a trip of inspection of the Stone & Webster properties in Washington.

Mr. A. R. Moore has resigned as president and manager of the Escanaba Electric Street Railway, Escanaba, Mich., and will be succeeded by Mr. John K. Stack, treasurer of the company. Mr. Moore will continue as a director of the company.

Mr. Henry Rohwer, formerly consulting engineer of the Missouri Pacific Railway, has been appointed consulting and supervising engineer for the Joplin & Pittsburg Railway of Pittsburg, Kan., and other lines promoted by J. J. Heim of Kansas City.

Mr. George R. Scarrett has resigned as roadmaster of the Berkshire Street Railway, Pittsfield, Mass., and the Bennington & North Adams Street Railway, Hoosick Falls, N. Y., effective on February 1. Mr. Scarrett has been connected with these roads since they first were placed in operation about six years ago.

Mr. Isaac S. Ruth, since 1901 superintendent of the Allentown & Reading Traction Company, Allentown, Pa., has resigned, effective on February 1. As foreman of construction for H. E. Ahrens & Co., Reading, Pa., Mr. Ruth built the road and on its completion in 1901 became superintendent. His present retirement is caused by ill health.

Mr. J. B. Hanna has resigned as president of the Chicago Lake Shore & South Bend Railway, now under construction from South Bend, Ind., to Chicago, Ill. It is announced that the Pomeroy-Mandelbaum-Wolf syndicate of Cleveland, which is interested in this and other electric railway properties in the central west, will complete and operate the new line.

Mr. F. W. Coen, who was recently appointed general manager of the Lake Shore Electric Railway and its subsidiary companies, as announced in our issue of November 23, 1907, has been elected vice-president of the company. Mr. John Witt was elected secretary and treasurer, succeeding Mr. Coen, who held this office prior to his appointment as general manager.

Mr. W. E. Kirkpatrick, heretofore secretary and treasurer of the Kansas City Railway & Light Company, Kansas City, Mo., has been elected vice-president and treasurer of the company. During the absence of Mr. Bernard Corrigan, president, who expects to take an extended vacation, Mr. Kirkpatrick will have active charge of the property. He has been succeeded as secretary by Mr. J. A. Harder, formerly auditor of the company.

#### Obituary.

James R. Ledyard, formerly superintendent of the Cincinnati Newport & Covington Light & Traction Company, Covington, O., died last week. Mr. Ledyard had been identified with street railway work for a number of years.

George Thomas Dunlop, for the past 12 years president of the Capital Traction Company, Washington, D. C., died at his home in Georgetown, Md., on February 5 of heart failure. He was a native of Maryland, having been born at Otterburn on March 25, 1845. When the Capital Traction Company was formed in 1895 by a special act of congress authorizing the merging of the Washington & Georgetown Railroad and the Rock Creek Railway of the District of Columbia, Mr. Dunlop was elected president of the new company and since that time had been in continuous service in this capacity.

# Financial News

**Boston Elevated Railway.**—The remaining \$2,300,000 of the \$5,800,000 bonds authorized last year have been sold to R. L. Day & Co. of Boston. The rate of interest is 4½ per cent. It is stated that the sale of these securities will provide for the capital requirements of the company during the current year.

**Boston Suburban Electric Companies, Newton, Mass.**—The Norumbega Park Company, a subsidiary company, has filed with the Massachusetts secretary of state a statement of its financial condition as of September 30, 1907, which shows the following: Assets: Real estate, \$152,678; material, \$998; cash and debts receivable, \$21,536; total, \$175,212. Liabilities: Capital stock, \$60,000; accounts payable, \$10,755; floating debt, \$103,500; surplus, \$957; total, \$175,212.

**Capital Traction Company, Washington, D. C.**—Gross earnings from operation in 1907 were \$1,764,345, of which \$1,760,209 was received from passengers, \$1,254 from freight and \$2,882 from mail. Operating expenses and taxes were \$903,481, or 51.33 per cent of gross passenger earnings. Other income amounted to \$22,163. Charges were \$91,500 and dividends aggregating \$720,000 were paid, leaving a surplus of \$71,527. The total number of car-miles was 10,679,895. The passenger traffic was as follows: Passengers carried at 4½ cents, 32,431,576; passengers carried at 5 cents, 8,036,150; passengers carried on commutation tickets, 519,254; total revenue passengers, 40,987,980; transfer passengers, 15,311,445; total passengers, 56,299,425.

**Chicago City Railway.**—This company has sold \$5,000,000 of 5 per cent bonds to the Illinois Trust and Savings bank, the Harris Trust and Savings bank and the First Trust and Savings bank of Chicago, making a total of \$12,000,000 bonds outstanding.

**Chicago & Milwaukee Electric Railroad.**—The receivers have made a trip of inspection over the property, and it is expected that the issue of about \$500,000 of receivers' certificates will be authorized in order to provide funds for the completion of the Milwaukee extension and for other purposes.

**Chicago & Oak Park Elevated Railroad.**—Gross earnings for the fiscal year ended June 30, 1907, were \$892,569. Operating expenses were \$527,180 and net earnings were \$365,389. After the payment of interest, taxes and rentals, aggregating \$429,334, the deficit was \$63,945. In his report to the stockholders, Clarence A. Knight, president, states that it is desired to extend the road through the territory lying west of Oak Park.

**Chicago Railways Company.**—The Harris Trust and Savings bank of Chicago and the National City bank of New York have agreed to purchase \$12,000,000 of first mortgage bonds. The bonds are issued to provide funds for the rehabilitation of the properties.

**Citizens' Electric Company, Eureka Springs, Ark.**—On application of the Kansas City (Mo.) Trust and Fidelity Company as the holder of bonds, Henry C. Brent, vice-president of the trust and fidelity company, has been appointed receiver of the Citizens' Electric Company.

**Columbus (O.) Railway & Light Company.**—Earnings in 1907 were as follows: Gross earnings, \$2,238,546; expenses, \$1,153,878; net earnings, \$1,084,668; other income, \$17,972; total income, \$1,102,640; interest and dividends, \$854,057; surplus, \$248,583; renewals and depreciation, \$57,002; surplus, \$191,581; dividends, \$75,000.

**Detroit United Railway.**—At the annual meeting of stockholders on February 4 Charles M. Swift of Detroit and J. M. Wilson of Montreal were elected directors to succeed C. W. Wason of Cleveland and H. S. Holt of Montreal. Gross earnings in 1907 were \$7,073,245.56, an increase of \$1,010,063.02 over 1906. Operating expenses and taxes were \$4,465,043.84, increase \$746,422.30; net earnings from operation \$2,608,201.72, increase \$263,640.72; other income \$60,505.25, increase \$1,747.52; gross income less operating expenses \$2,668,706.97, increase \$265,388.24; interest charges \$1,554,248.65, increase \$310,975.27; dividends \$343,750, decrease \$281,250; charged off for depreciation \$276,000, increase \$26,000; total deductions \$2,173,998.65, increase \$55,725.27; surplus income \$494,708.32, increase \$209,662.97. It is announced that \$750,000 bonds will be sold.

**Georgia Railway & Electric Company, Atlanta, Ga.**—At the annual meeting of shareholders Charles F. Ayer of Boston

was elected a director. Gross earnings in 1907 were \$2,658,872.70.

**Holyoke (Mass.) Street Railway.**—The annual report for the fiscal year ended September 30, 1907, shows the following: Gross earnings from operation, \$441,637.47; operating expenses, \$500,325.36; net earnings from operation, \$141,332.11; miscellaneous income, \$8,912.95; gross income above operating expenses, \$150,245.06; charges upon income during year—interest on loans and funded debt, \$31,094.67; taxes, \$38,218.57; rental of railroads, \$8,250; Mountain park expenses over receipts, \$202.80; total charges, \$77,766.04; net divisible income, \$72,479.02; dividends, \$64,000; surplus for year, \$8,479.02. Car-miles run for year, 1,758,538; persons employed, 283; number cars, 120; miles of track, 63,733.

**Hudson Companies, New York.**—Notes aggregating \$15,000,000, maturing in two years, and bearing 6 per cent interest, have been issued. The notes are secured by deposit as collateral of \$22,500,000 of 1½ per cent convertible bonds of the Hudson & Manhattan Railroad. The notes are offered at par and interest by Harvey Fisk & Sons, New York. W. G. Oakman, the president, states that the directors decided to issue short-term notes because of their unwillingness to sell any of the treasury assets under present conditions. The proceeds will be used to continue the work of construction.

**Indianapolis Huntington Columbia City & Northwestern Traction Company, Indianapolis, Ind.**—The property of this company was sold at foreclosure on February 1 at Warsaw, Ind., for \$6,500.

**Interborough Rapid Transit Company, New York.**—It is proposed to issue \$50,000,000 of 4½ per cent first mortgage bonds, of which \$15,000,000 will be used to retire \$15,000,000 notes due on May 1 and \$10,000,000 will be used for the retirement of \$10,000,000 notes due on May 1, 1910. The remainder will be reserved for extensions and improvements.

**Interurban Railway & Terminal Company, Cincinnati, O.**—A trust deed has been filed to the Cincinnati Trust Company, as trustee, to secure an issue of \$1,650,000 of 5 per cent 20-year bonds, dated January 1, 1908.

**Kansas City (Mo.) Railway & Light Company.**—Kuhn, Loeb & Co. and Blair & Co. of New York offer for sale \$1,125,000 of 6 per cent 5-year convertible notes of this company at 96 and interest, netting about 7 per cent on the investment. The notes, Series A, are part of an issue of \$5,500,000 notes secured by pledge with the New York Trust Company, as trustee, of at least \$5,500,000 notes of the Metropolitan Street Railway of Kansas City, \$1,000,000 notes of the Kansas City Electric Light Company, \$2,695,000 Kansas City Railway & Light Company common stock, \$2,977,900 Kansas City Railway & Light Company preferred stock, and of such securities of the subsidiary companies of the Kansas City Railway & Light Company as are pledged under the indenture of May 15, 1903, securing the first lien refunding bonds, subject to the prior lien of said indenture. The remaining \$1,375,000 of 6 per cent notes are known as notes of Series B, and are non-convertible. Each of these Series A notes is convertible at the option of the holder, on and after September 1, 1908, into six and one-half shares of the common stock and seven shares of the preferred stock of the company. The notes are redeemable at the option of the company at par and interest on eight weeks' notice upon any interest date, beginning March 1, 1909. If called for redemption, the provision for conversion shall cease 20 days before the redemption date mentioned in the call. Such right to convert will also cease July 1, 1912, provided the railway company shall give notice to that effect by advertisement.

**Milwaukee Electric Railway & Light Company.**—Earnings in the last three years compare as follows:

	1907.	1906.	1905.
Gross earnings	\$3,823,383	\$3,523,438	\$3,226,535
Operating expenses and taxes	2,204,124	1,945,993	1,745,055
Net earnings	\$1,619,259	\$1,577,445	\$1,481,480
Other income	183,283	155,791	122,161
Total net income	\$1,802,542	\$1,733,236	\$1,603,641
Depreciation reserve fund	382,338	352,344	322,653
Interest charges	572,864	509,765	414,771
Balance applicable for dividends	\$ 847,340	\$ 871,127	\$ 866,217
Preferred dividends	270,000	270,000	270,000
Common dividends	540,000	540,000	400,000
Surplus	\$ 37,340	\$ 61,127	\$ 196,217

**Mt. Mansfield Electric Railroad, Stowe, Vt.**—The sale of the property of this company to A. H. Soden of Boston for \$22,500 has been confirmed by James L. Morton, judge of the United States circuit court at Montpelier, Vt.

**New York City Railway.**—Judge Lacombe of the United States circuit court, New York, has dismissed the suit brought by the receivers appointed by the New York state supreme court to secure possession of the railway property from the receivers appointed by the federal court. Judge Lacombe declared that the suit had been presented prematurely. The suit was dismissed without prejudice and the state receivers may renew it whenever they desire.

**New York-Philadelphia Company.**—The Camden & Trenton Railway, Camden, N. J., and the Trenton & New Brunswick Railroad, Trenton, N. J., subsidiary companies, did not meet the interest due on their bonds on January 1. The interest due on November 1, 1907, on the first mortgage bonds of the Camden & Trenton road was not paid.

**Ottawa (Ont.) Electric Railway.**—Receipts for the year 1907 were \$574,278.46, an increase over 1906 of \$48,531.87. The net earnings of the year were \$224,349.07. The passengers carried numbered 12,623,440, or 1,215,215 more than last year.

**Philadelphia Company, Pittsburg.**—Gross earnings in 1907 were \$19,091,423, as compared with \$18,223,537 in 1906. Operating expenses and taxes were \$12,067,303, as compared with \$11,107,967. Net earnings were \$7,024,120, as compared with \$7,115,570.

**Third Avenue Railroad, New York.**—Frederick W. Whitridge, receiver for this company, was appointed receiver also for the subsidiary Forty-second Street Manhattanville & St. Nicholas Avenue Railway and the Dry Dock East Broadway & Battery Railroad by Judge Lacombe of the United States circuit court, New York, on February 1. The receiver for the first-named subsidiary road was appointed on application of the Barber Asphalt Paving Company, which had a claim for \$20,349.27. The American Hay Company held a claim against the second-named subsidiary road for \$6,546.01.

**Vincennes (Ind.) Traction & Light Company.**—At the annual meeting of stockholders an issue of \$100,000 of 6 per cent preferred stock was authorized. Gross earnings in 1907 were \$55,023, as compared with \$44,913; net earnings were \$13,420. During the last year there were carried 1,162,210 passengers.

**Washington (D. C.) Railway & Electric Company.**—Gross earnings in 1907 were \$1,265,616. Operating expenses and fixed charges were \$1,149,584. Other income was \$456,088. From the balance of \$572,120 dividends aggregating \$425,000 were paid and there was charged off \$52,700 discount on \$250,000 of consolidated mortgage 4 per cent bonds sold, leaving a surplus of \$94,420.

**ELECTRIC RAILWAY EARNINGS.**

**Duluth Street Railway.**

December—	1907.	1906.
Total earnings	\$73,091.64	\$66,589.97
Operating expenses	45,291.81	41,620.94
Net earnings	27,799.83	24,969.03
Total deductions	22,042.62	16,726.78
Net income	5,757.21	8,242.25
January 1 to December 31—	1907.	1906.
Total earnings	\$846,084.35	\$768,874.77
Operating expenses	437,391.21	418,820.49
Net earnings	408,693.14	350,054.28
Taxes	32,681.81	26,071.97
Interest	185,000.00	185,000.00
Depreciation	84,053.00	50,820.00
Total deductions	301,734.81	261,891.97
Net income	106,958.33	88,162.31

Kansas City Railway & Light Company.		
December—	1907.	1906.
Gross earnings	\$512,666.17	\$499,631.71
Operating expenses	261,196.70	244,102.84
Net earnings	251,469.47	255,528.87
Interest and taxes	152,178.88	147,891.69
Net income	99,290.59	107,637.18

**Dividends Declared.**

Boston Elevated Railway, 3 per cent.  
 Chicago City Railway, extra, 2½ per cent.  
 Columbus (O.) Railway & Light Company, one-half of 1 per cent.  
 Connecticut Railway & Lighting Company, New Haven, Conn., common, assenting, 1 per cent; preferred, 1 per cent.  
 Ohio Traction Company, Cincinnati, O., preferred, quarterly, 1¼ per cent.

# Manufactures and Supplies

**ROLLING STOCK.**

**Chicago City Railway** is building 12 work cars in its own shops.

**Milwaukee Northern Railway** is reported to be in the market for a number of cars.

**Hudson Companies, New York City,** are completing specifications for two construction cars.

**Winnebago Traction Company, Oshkosh, Wis.,** is reported to be in the market for new car equipment.

**Philadelphia & Western Railroad, Philadelphia, Pa.,** is in the market for two double-truck snow plows.

**Rochester Syracuse & Eastern Railway, Syracuse, N. Y.,** is in the market for two double-truck interurban cars.

**Erie Railroad** is in the market for three electric cars for its Elmira single-phase division. Specifications are being prepared by Westinghouse, Church, Kerr & Co., New York City.

**Alexander Arnois, engineer, Frankford, Pa.,** is asking prices on 50 all-steel double-truck closed passenger cars for electric traction service. All bids are to be submitted on or before February 14.

**Denver & Interurban Railway,** which was reported in the Electric Railway Review of January 11 to be in the market for 12 interurban cars, has placed the order with the St. Louis Car Company.

**Georgia Railway & Electric Company, Atlanta, Ga.,** will build about 30 cars in its own shops during 1908. The company does not contemplate placing any orders for rolling stock with contract builders.

**Russell Car & Snow-Plow Company, Ridgway, Pa.,** on February 1 shipped to the Montreal Street Railway one Size 3 Russell double-end, double-truck, right and left hand running snow plow with flanger. This car is especially adapted for interurban service.

**Van Brunt Street & Erie Basin Railroad, Brooklyn, N. Y.,** which was reported in the Electric Railway Review of December 21 as being in the market for five single-truck open cars, has placed this order with The J. G. Brill Company.

**Fargo & Moorehead Street Railway, Fargo, N. D.,** which was reported in the Electric Railway Review of November 30 to be in the market for one car, has placed the order with M. Mithskun Company of Detroit, Mich. The car is a flat trailer and will be used to transport live stock from the railway yards to the state fair grounds. The body and underframe are of wood. It weighs 19,000 pounds, is 36 feet 6 inches long over all and 9 feet 4 inches wide over all.

**Indiana Union Traction Company, Anderson, Ind.,** in two mysterious fires in its car houses at South Marion, Ind., lost two cars and suffered damage to a few more. The first fire occurred on February 2 and two cars were completely destroyed. The second fire occurred on February 3, when considerable damage was done to some of the rolling stock in the car houses before the flames were under control. No plausible origin for either fire has been discovered.

**Mahoning & Shenango Railway & Light Company, New Castle, Pa.,** as previously reported in the Electric Railway Review, on October 26 placed an order with the G. C. Kuhlman Car Company for 10 closed vestibule single-truck cars. Delivery has been made. The details of the cars are as follows:

Wheel base	.....7 ft.	Width, inside	.....6 ft. 7 in.
Length of body	.....20 ft.	Over all	.....7 ft. 6 in.
Over vestibule	.....29 ft. 5 in.	Seating capacity	.....
Over all	.....31 ft. 3 in.		.....26 passengers
Height, inside	.....8 ft. 2 in.	Body	.....Wood
Sill to trolley base	.....9 ft. 6 in.	Underframe	.....Composite
Track to trolley base	.....12 ft.		

**Special Equipment.**

Brakeshoes	.....Am.	Heating system	Consolidated
Brake Shoe & Fdry. Co.		Motors	.....2 Westinghouse
Control system	.....Westinghouse	Safety tread	.....Mason
Couplers	.....Co. standard	Sanders	.....Co. standard
Curtain fixtures	.....Brill	Trolley poles and attachments	.....Nuttall
.....Curtain Supply Co.		Trucks	.....Brill 21E
Curtain material	.....Pantastote	Varnish	.....Hildreth
Fenders	.....Co. standard	Door device	.....Wallace
Hand brakes	.....Peacock		

## SHOPS AND BUILDINGS.

**Hamilton (Ont.) Street Railway.**—This company's car houses at the corner of Locke and Herkimer streets, Hamilton, were destroyed by fire on January 20. Four cars were burned. The loss is estimated at \$30,000.

**Indiana Union Traction Company, Anderson, Ind.**—Property at Main and Seventeenth streets, Elwood, Ind., has been purchased and excavating for the foundation of the new station will be started as soon as the weather permits. According to the company's agreement with the city the building will cost \$15,000.

**Washington Baltimore & Annapolis Electric Railway, Washington, D. C.**—E. D. Skipper & Co., Annapolis, Md., have been awarded the contract for the company's new terminal station at Annapolis.

## TRADE NOTES.

**Rossiter MacGovern & Co., Incorporated,** 90 West street, New York, was placed in the hands of receivers on February 1.

**Standard Paint Company,** New York, has removed its office from Atlanta, Ga., to 506 Hibernian Bank building, New Orleans, La.

**Daniel C. Stover,** president of the Stover Motor Car Company and head of several other large industries bearing his name, died at his home in Freeport on January 23 at the age of 69 years.

**Hicks Car & Locomotive Works** has moved its general sales offices to 410 Fisher building, Chicago. The purchasing and accounting departments are at the company's works at Chicago Heights.

**Improved Automatic Air Brake Company** has closed an option on some brick buildings at Elwood, Ind., and may install a plant to manufacture patented automatic air brakes. Charles St. Clair and James Shoemaker of Indianapolis, Ind., are interested.

**S. R. Shepherd,** until December 31, 1907, secretary and treasurer of the Walter A. Zelnicker Supply Company, St. Louis, Mo., has accepted the presidency of the Indiana Malleable Casting Corporation, a new concern located at Washington, Ind.

**Robert W. Hunt & Co.,** Chicago, have established their St. Louis office, which is in charge of C. W. Gennet, Jr., as previously noted in the Electric Railway Review, at 1445 Syndicate Trust building. They have arranged to locate their chemical and cement laboratory in the same building.

**Electric Cable Company,** 17 Battery place, New York, has received a large order from the Harlan & Hollingsworth Corporation, Wilmington, Del., for its anti-corrosive compound, Voltax. The company states the order was placed after tests lasting over nine months had been made.

**W. S. Barstow & Co.,** New York and Portland, Ore., have appointed W. S. Turner manager of their Portland office. Mr. Turner, who is a graduate of Kent College and Cornell University, has had experience all over this country and in New Zealand. He was formerly a member of the firm of Woodbridge & Turner.

**Kalamazoo Railway Supply Company,** Kalamazoo, Mich., reports that the demand for the Root railway spring scrapers and fenders is constantly increasing. The scraper is now used by over 250 street and interurban railways, and several orders for next winter have been received, calling for delivery during the summer months.

**Goldschmidt Thermit Company,** New York, has just completed quite an extensive piece of rail welding for the Los Angeles-Pacific Company of Los Angeles, Cal. The Goldschmidt company's San Francisco office reports the receipt of a letter from the general manager of the railway in which he expresses his satisfaction with the work.

**New Doty Manufacturing Company,** Janesville, Wis., is building four punching and shearing machines for the St. Louis Car Company, St. Louis, Mo. Three of these machines will weigh about 35,000 pounds each and the other one about 40,000 pounds. The company is also building two 25,000-pound punching and shearing machines for the government to be installed at the Brooklyn navy yard.

**Massachusetts Chemical Company,** Walpole, Mass., corrects the trade note which appeared in the Electric Railway Review of January 25, in which it was stated that a weekly or semi-weekly bath of Armalac would save hundreds of dollars in rewinding expense on armatures, and that this was an adopted practice on some large systems. Instead of

weekly or semi-weekly this sentence should have read yearly or semi-yearly.

**A. T. Le Baron** has joined forces with C. A. Ralston, under the firm name of Ralston & Le Baron, with offices at 702 Fisher building, Chicago. They will deal in locomotives, cars and contractors' equipment, and are agents for the Russell Car & Snow-Plow Company, Htdgway, Pa. Mr. Le Baron for two years past has been in charge of southern territory for the Fitz-Hugh, Lutha Company, Chicago, with headquarters at New Orleans, La.

**J. W. Duntley,** president of the Chicago Pneumatic Tool Company, Chicago, on February 4 sailed from New York for a four or five weeks' business trip to Europe. Before leaving Mr. Duntley stated that while the volume of business transacted by the American company was not, of course, satisfactory, at the same time January had shown considerable improvement over the month of December. Mr. Duntley has gone to Europe to close up several important matters there.

**Blake Signal & Manufacturing Company,** Boston, Mass., states that prospects for business for the Blake signal are brighter than ever. The first installation of these signals was made on the Boston & Worcester Railroad, four and one-half years ago, and the company reports that they have always and are at present giving as good service as when first installed. Over 800 miles of interurban road are equipped with the Blake signals. The company states that some of the foremost railroad signal engineers, who have thoroughly investigated the installations, pronounce the Blake system in many respects ahead of the best steam railway practice of today.

**Arthur B. Shepard,** who gave up his position as manager of the General Electric Company's Cleveland office last July to devote his time to completing the Toledo & Chicago Interurban Railway, of which he was president, has now resigned that position in order to go into the selling business again, with offices in the New England building, Cleveland. He will represent in northern Ohio the Wagner Electric Manufacturing Company of St. Louis, the Electric Machinery Company of Minneapolis, Broderick & Bascom Rope Company of St. Louis and the Asbestos Protected Metal Roofing Company. Mr. Shepard remains as director in the Toledo & Chicago Interurban Railway.

**Daniel Shafer,** for many years one of the best known salesmen and engineers in the south, succumbed to a sudden attack of pneumonia at the Nashville hotel, Nashville, Tenn., on January 24. Mr. Shafer, who was 47 years of age at his death, had been associated for the past three years with the Allis-Chalmers Company of Milwaukee, being attached during a portion of that time to the pumping engine department, and for the past year as sales engineer of the steam turbine department. For five years previous to taking his position with the Milwaukee company he was associated with the Hooven-Owens-Rentschler Company of Hamilton, O., during which time he acted as its southern representative, and was well known throughout that section as an expert on the power equipment of cotton mills.

**H. W. Nutt,** who for the past year has represented Buell & Mitchell of New York in Boston, has been appointed district manager for the New England states by the General Fireproofing Company of Youngstown, O., and will have headquarters at 161 Devonshire street, Boston. Through his previous connections Mr. Nutt has a wide acquaintance among architects, contractors and engineers of the east. Mr. Nutt has been assistant general sales agent for the American Steel Hoop Company, secretary of the American Tube & Stamping Company of Bridgeport, Conn., and vice-president of the Superior Steel Company of Pittsburg. As district manager for the General Fireproofing Company his attention will be devoted largely to exploiting the materials for reinforcing concrete which are manufactured by this company, and particularly pin-connected girder frames and cold twisted lug bars.

## ADVERTISING LITERATURE.

**Westinghouse Electric & Manufacturing Company,** Pittsburg, Pa.—Circular No. 1104, recently issued, is devoted to Westinghouse portable and precision meters. Fifty-four pages are required to describe and illustrate the various types.

**Arnold Company,** 181 La Salle Street, Chicago, Ill.—The latest postcard of an illustrated series shows the reinforced concrete storehouse and the locomotive repair shop under construction at Bogalusa, La., for the New Orleans Great Northern.

**Milwaukee Locomotive Manufacturing Company,** North Milwaukee, Wis.—Vanguard gasoline and alcohol locomotives, especially designed for switching service in industrial plants,

railway construction and passenger service, are illustrated and described in a recently issued catalogue.

**George Callahan & Co., Santos Building, Front Street, New York, N. Y.**—A recently issued booklet of valuable information is entitled "Leaky Roofs—How to Make Them Waterproof." It sets forth the advantages of Callahan's "Elastica" waterproof liquid coating for roofs of all materials.

**Rockwell Engineering Company, 26 Cortlandt Street, New York, N. Y.**—Bulletin No. 13 demonstrates the uses of Rockwell portable heaters for oil fuel in and about railway and other shops. Type H-901 is self-contained and for kerosene oil only. Type H-902 employs compressed air and burns crude or refined oil.

**Allis-Chalmers Company, Milwaukee, Wis.**—Bulletin No. 1049 is devoted to polyphase induction motors, two types of which are described. Type AN motors have a rotor with "squirrel cage" winding and are suitable for all classes of constant-speed service. Type AN(Y) motors are provided with a wound rotor adapted to the insertion of resistance at starting or for obtaining variable speed.

**Cutler-Hammer Clutch Company, Milwaukee, Wis.**—A recently issued booklet in the form of a miniature magazine is entitled "Lifting Magnets and Recent Improvements in Them." It traces briefly the development of the lifting magnet, illustrates the different kinds of magnets used for handling pig iron, metal plates and other classes of material and explains, by an easily understood analogy, how the magnetic "lines of force" support weights up to 10 tons.

**Joseph Dixon Crucible Company, Jersey City, N. J.**—"Air Brake Lubrication" is the title of an attractive booklet of 16 pages and cover,  $3\frac{1}{2}$  by  $6\frac{1}{4}$  inches, recently issued by this company. The booklet is typographically attractive, being printed in two colors, illustrated and having a cover of pleasing design. The text starts with the description of the air brake testing rack installed at Purdue University by the Master Car Builders' Association. This rack embraces a full air brake equipment for two trains of 50 cars each upon which Professor Goss made his first tests with Dixon's flake graphite. The booklet discusses the preparation and introduction of Dixon's air brake and triple valve grease and details the parts of the air brake system on which this lubricant can be used to advantage. The lubricating troubles ordinarily experienced with the air brake system are pointed out and the remedies given. The book closes with a few pages on the lubrication of air pumps. All those interested in the train service may obtain a copy by writing to the company.

**General Electric Company, Schenectady, N. Y.**—Recently issued bulletins include No. 4562, which is descriptive of mill type motors, designed to meet the demand of the constantly increasing business done in electrically driven rolling mills, etc. These motors are manufactured for direct and also for alternating current circuits and are designated MD and MI motors, respectively. They are built in sizes from 30 to 150 horsepower, and the direct-current motors, while generally rated at 220 volts, can be supplied for 500 volts, with a slight variation from standard speed. The MI alternating-current motors are wound for either 220 or 440 volts, 25 cycles, three-phase. The illustrations in the bulletin show the particularly heavy construction, and dimension diagrams with other data are given in the text.—Bulletin No. 4559 describes motor-starting rheostats and panels for direct current. It shows a variety of these panels in which different types of starting rheostats are used, the rheostat being combined with a line switch and fuses, or with a double-pole circuit-breaker. Dimension diagrams for the different capacities of rheostats and panels are included.

**Electric Journal, Pittsburg, Pa.**—The Electric Journal has published a pamphlet of 30 pages, 6 by 9 inches, which is its "Four-Year Topical Index." This index contains, in convenient form, references to all of the important engineering articles which have appeared in the issues of The Electric Journal from the first issue to date. By the use of the topical method of indexing all of the articles on a given subject are classified together, so that in looking up any reference one can see not only the article desired, but also all articles which have appeared on the same subject in the various issues of the periodical. An outline scheme of the topical arrangement is given at the beginning of the index, so that anyone, even though unacquainted with the topical system, can easily locate any reference. To persons who have disagreeable recollections of other methods of finding some article in some magazine by looking through a semi-annual, alphabetical index in common use, this index will come as a great relief. The references are arranged so that they can be used in a card index if so desired, the indexes being printed on one side only for this purpose. The index is supplied at 25 cents per copy.

## COMMUTATING-POLE GENERATORS, BOSTON ELEVATED RAILWAY.

Among the comparatively recent improvements made in the design of direct-current machines, probably none has done more to mark a distinct advance in the art than the employment of commutating poles. While commutating-pole machines of moderate capacity have been in successful operation for some time past, it is only recently that this feature has been applied to large direct-connected engine-driven generators operating under the severe service conditions generally met with in street railway work.

The two 2,700-kilowatt commutating-pole railway generators recently installed in the Charlestown and Harvard power stations of the Boston Elevated Railway Company by the General Electric Company, present some interesting features in connection with the design, installation and operation of this type of railway generator.

The first of these generators was put in commercial service on October 10, exactly eight months from receipt of order

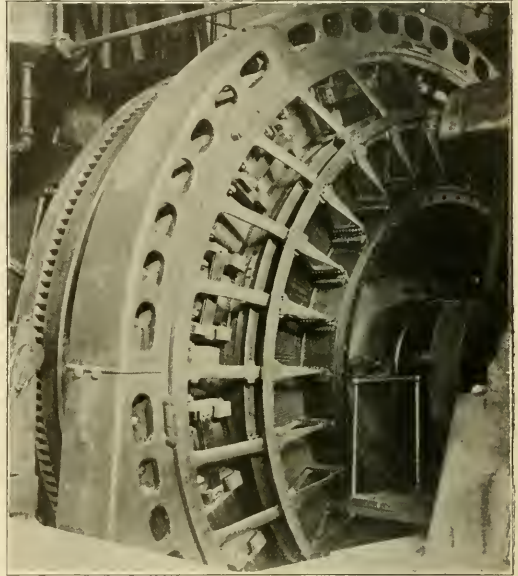

Near View of Generator, Showing Commutating Poles.

and 21 days in advance of the date specified for delivery. This is said to have been the quickest delivery on record for an engine-driven unit of this size.

These generators are direct connected to McIntosh & Seymour 4,100-horsepower vertical cross compound engines and are designed for 575 volts at a speed of 90 revolutions per minute, but are capable of a wide voltage range at all loads. Although the largest commutating-pole railway generators ever built, at the same time they are of smaller physical dimensions and occupy less floor space than any machines of same output and speed previously constructed. It is interesting to note in this connection that the armature diameter of these machines is approximately  $4\frac{1}{2}$  feet less than the armature diameter of the non-commutating pole generators of the same output just installed in the Lincoln wharf station of the Boston Elevated Railway.

The generators are guaranteed to deliver 2,700 kilowatts (4,700 amperes at 575 volts) continuously with a temperature rise not to exceed 35 degrees C. in any part above the surrounding air, also 50 per cent overload or 4,050 kilowatts (7,050 amperes at 575 volts) for two hours following the normal run, temperature rise not to exceed 55 degrees C. and to withstand a momentary overload of 100 per cent or 5,400 kilowatts (9,400 amperes at 575 volts) without injury.

That these guarantees have been fully met has been clearly demonstrated since the machines have been put in service. Their operation under the severe conditions imposed by a fluctuating railway load has been entirely satisfactory in every respect, and tests taken show an extremely low tem-

perature rise that is within the guarantee by a very large margin.

The practically sparkless commutation secured under all conditions of load by conservative design and use of commutating poles reduces wear of commutator and brushes to a minimum, which is an additional source of economy obtained with this type of generator.

No change whatever in the brush setting has to be made from no load to momentary overload condition of 100 per cent, and the circuit-breaker can be tripped under any condition of load between these limits without appreciable disturbance at the brushes. No trouble whatever is experienced in paralleling these machines with others in the stations where they are installed.

**TESTS OF STRAIN INSULATORS.**

Electrical tests recently made on the No. 7 and No. 10 safety strain insulators recently placed on the market by the Western Electric Company, Chicago, Ill., show some interesting as well as highly satisfactory results.

The electrical value of the No. 7 safety strain insulator ranges between 30,000 and 40,000 volts. One of these areed between loops over the outside surface of the insulator at 40,000 volts; another of the same type areed at 40,800 volts and was maintained at that value for one minute without breaking down. The mechanical strength of the No. 7 safety strain insulator is about 10,000 pounds.

The electrical value of the No. 10 safety strain insulator ranges between 40,000 and 50,000 volts. This insulator areed from loop to loop over the outside surface at 54,000 volts, and was held at that voltage for one-half minute without breaking down. The mechanical strength is about 20,000 pounds.

The company feels confident that when size and strength are considered the new safety strain insulators practically reach the limit of electrical value and greatly exceed all previous records. All metal parts are of drop-forged steel.

**THE HENDERSHOT COUPLING.**

A new shaft coupling, to be known as the Hendershot coupling, is being placed upon the market by Manning, Maxwell & Moore, Incorporated, 85 Liberty street, New York,

and the shells are bolted together. The fits, 3 and 4, true up the coupling and perfect alignment is assured by keeping the two faces, 1 and 2, parallel.

The coupling is easily taken apart by screwing two bolts in holes that are tapped in the shell for the purpose. In coupling shafting this construction permits of a great saving in time, especially in a new factory where it is not convenient to start up to see how the line runs. The manufacturer is sure this feature will meet with the approval of millwrights and mechanics, who have had experience in coupling shafting with compression couplings of the single-sleeve type. It should also appeal to mill owners, as the time saved in using the Hendershot coupling is quite an item. If put on properly the shafting cannot be sprung.

If the shafts to be coupled vary a little in size, are a little out of line, or both, the Hendershot coupling will adjust itself and the compression will be the same the full length of the sleeve, which is not possible with the sleeve in one piece. The sleeves are made thinner and the hubs heavier, thereby greatly increasing the strength without increasing the outside diameter of the coupling.

The coupling is made of the best gray iron, and is heavy enough to withstand all stresses. Every coupling is put together on a test pin and inspected before it leaves the factory.

**A CLEARING HOUSE FOR ENGINEERS.**

The nature of engineering work is such that the men employed in it are periodically looking for new engagements. These men become available, not through any fault of their own, but because engineering work is inherently of a temporary character. A tunnel may require 2½ years to build, yet at the end of that time the engineers who have built it are often compelled to seek other engagements, which may carry them to entirely different parts of the globe.

The business of the Engineering Agency, Incorporated, Monadnock block, Chicago, is to maintain a reliable list of competent engineers, qualified for all the branches of the profession, electrical, mechanical, civil, architectural and mining, for the convenience of employers who may need their services.

It is a centrally located institution, that keeps in touch with all the engineering work in progress, and it has acquired exceptional facilities for aiding the better class of men.

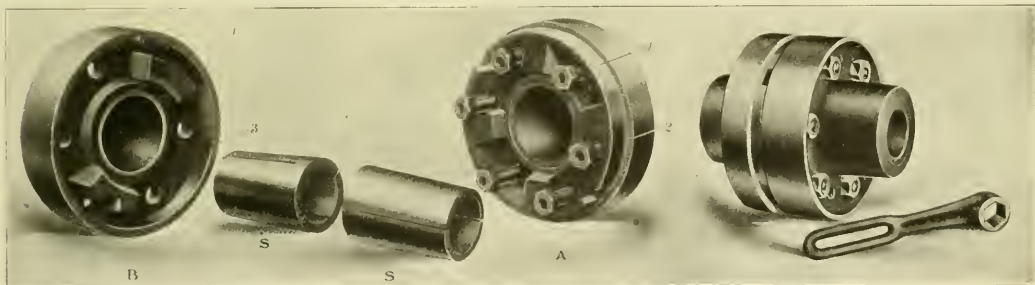

The Hendershot Coupling.

N. Y., which has several new features which give it great strength and facilitate its quick and convenient application.

The general appearance of the coupling assembled and the component parts are shown in the accompanying engravings.

It will be noted that two short taper compression sleeves are provided, S, S, in the engraving. These make it possible to put the two halves of the coupling in place while the shafting is upon the floor, so that it may be hoisted into position and bolted together as easily as with a plain flanged coupling. The shells, A and B, contain cast lugs, which, interlocked, form a clutch, thereby taking the stress upon the shells and relieving the bolts of all shearing stress and making a most rigid and durable connection.

Although the bolts are relieved of shearing stresses, about half again as many more of them are used than is usual. This is in keeping with the very large compression area of this style of coupling and the unusually large factor of safety provided.

In applying the coupling the shells, A and B, are slipped upon the shafting first. Then the sleeves, S and S, are put into place, so that the shells may be drawn over them. The lugs of shells, A and B, are brought into interlocking position

Through the agency men have been sent to many foreign countries.

The work of every member is carefully watched and only the best men are recommended to clients. The agency has striven to live up to its slogan, "None but competent men need apply."

Electric railways contemplating surveys or construction will find the Engineering Agency ready to organize a competent engineering corps on short notice. It is prepared either to conduct the surveys under its own supervision or to furnish the men to the railway company.

The agency was organized in 1893 by Frederick A. Peckham, then western manager for the Engineering News. For 11 years Mr. Peckham conducted the business, until it was acquired by Albert G. Frost and his associates.

The Twin City Rapid Transit Company of Minneapolis, Minn., has contracted with the St. Anthony Falls Hydroelectric Company for 12,000 horsepower of the output of the Hennepin island plant for a term of years. The additional power will be of great assistance to the company in handling its enormous summer excursion traffic.

### MACHINE FOR TESTING JACKS.

With known strengths of materials it should be easy to figure quite approximately the safe working load of any jack, but as a final confirmation of all such calculations a test should be made with a known load. For such tests the Joyce-Cridland Company of Dayton, O., has for many years used a hydraulic press, and its jacks, including some 200 or more

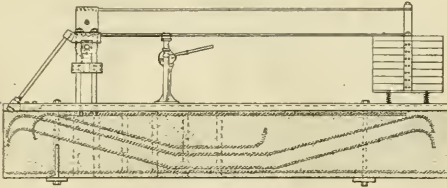

Machine for Testing Jacks.

kinds—hydraulic, lever, friction, geared lever and screw jacks, etc.—have been tested on this machine before shipment.

It was noticed, however, that under heavy pressure indications on this machine were not accurate, for it would show loads in excess of the load mathematically possible, even as-

withstands any pressure which may be applied by the heaviest jack. The fulcrum, attached to the bar by a steel casting, is a pin which carries knife edges both above and below. When the machine is standing idle the lower knife edges rest on each side of the centering block. When a jack is put under the beam and pumped up the upper knife edges rise against hard steel plates in the head. Graduations in tons are marked on the I-beam, commencing with one ton. The beam is graduated for each number of weights, the place for each graduation being determined by accurate calibration. On the bottom side of the beam is a sliding clamp or block with a V-shaped notch. The jack to be tested is set just under this notch, and a round pin is laid on top the jack so that it will enter the notch. This insures correct bearing during the tests. By shifting the point of application of the jack and adjusting the number of weights any desired load may be thrown upon the jack before the weights will rise. A hydraulic or other heavy jack can thus be tested under precisely the same conditions as if it were lifting a locomotive truck, car or any other weight.

### ELECTRIC PILLAR JIB CRANE.

The crane shown in the accompanying photograph is an electric pillar jib crane recently built for the Chicago City Railway. This crane is of three tons capacity and has an effective radius of 10 feet. The jib swings 360 degrees. The crane is designed to be placed on a flat car, to be used for handling rails and track material, and is operated by an 11-

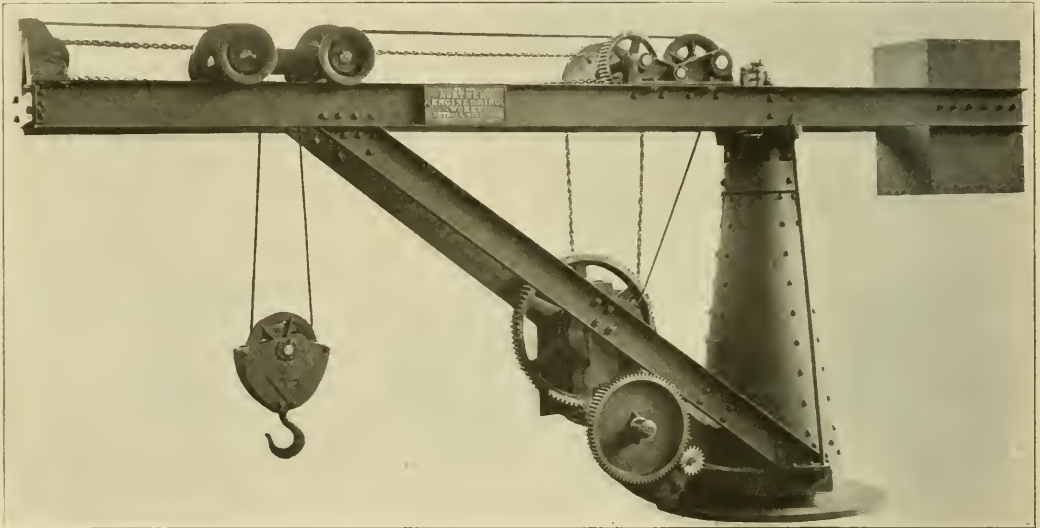

Electric Pillar Jib Crane for the Chicago City Railway.

suming that there was no friction within the jack. After careful investigation the difficulty was found to be in the transfer gauge of the testing machine, and upon taking the matter up with the gauge manufacturers, it developed that the latter were not prepared to guarantee gauges of greater accuracy. The result was that the Joyce-Cridland Company designed and installed the testing machine illustrated herewith.

This machine is simply a 16-foot bar with a fulcrum at one end, and weighted at the other with eight 850-pound weights, any or all of which may be used at one time. The bar is an ordinary 15-inch I-beam and the machine is set over a reinforced concrete foundation six feet deep. The weights remain on a spring platform while at rest, and are picked up by inserting pins through the yoke from each side.

The base of the machine consists of two 15-inch channels placed side by side and with the flat side up. The head or fulcrum is braced by round steel struts to a cast-steel head on the ends of the channels. The concrete below the channels is reinforced by twisted steel bars, which are placed to give greatest resistance near the fulcrum, where the stress is greatest.

The vertical rods which hold the fulcrum in place are anchored at the bottom of the concrete, so that the fulcrum

horsepower direct-current motor at 500 volts. The conditions required that the crane should not exceed 8 feet above the floor of the car. The trolley travels by hand chain gear and the swinging is done by hand. Cut gearing is used throughout. The central pillar is of plate steel riveted and is equipped with steel ball bearings at the top and steel roller bearings at the base. The hoisting speed is about 30 feet per minute full load.

Cranes of this kind have been found very useful, not only for placing on flat cars, but for use on stationary foundations where freight is to be transferred from car to platform or from car to wagons. In cases where the cost of electric power would not be justified it could be equipped with hand power throughout; or, if pneumatic power is available, pneumatic motors can be applied instead of electric motors. The crane shown was made by the Northern Engineering Works, Detroit, Mich.

Central Inspection Bureau, 17 State street, New York City, has been given the contract by the Lacroze Company for the complete inspection of six interurban cars built by The J. G. Brill Company and which are for shipment to Buenos Aires, S. A.



# The Grip Nut

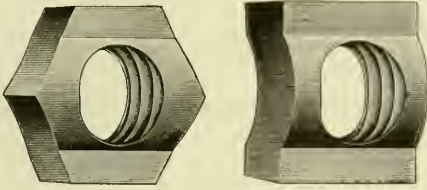

Among the various economies and advantages of the Grip Nut are:

Elimination of loose and lost holding nuts. Low cost. High individual load strength. Simplicity; no complexity of stock, as involved by the use of nut locks. Advantage in clearance over ordinary jam nuts. Absolute assurance of full service from holding nut, whether applied loosely or jammed up. Its "setting up" quality as elastic as a bolt thread. Reports received agree that **Grip Nuts** prolong the life of crossings, insulated joints and all equipment to which they are applied.

*Used by the United States Government.*

**Grip Nut Company**  
New York Chicago

**WESTERN ELECTRIC COMPANY**  
 CHICAGO DENVER PITTSBURG SAINT PAUL NEW YORK  
 SAINT LOUIS SAN FRANCISCO SEATTLE SALT LAKE CITY LOS ANGELES  
 CINCINNATI RICHMOND PHILADELPHIA

## Our High Tension Insulators



Insure Your Lines Against Trouble  
*Get a copy of our catalog*

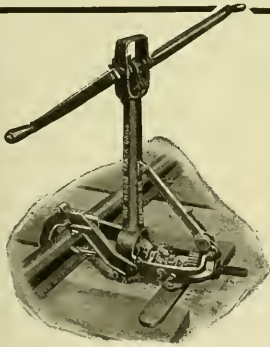

# The Moore Track Drill

does not interfere with traffic!

The shifting of one lever and a few seconds' time takes down the drill—the operation reversed makes it ready for work again.

This is only one of the many strong points about the Moore Track Drill that make it worth buying.

*Ask for descriptive catalogue.*



**Kalamazoo Railway Supply Co.** Kalamazoo Michigan

# Save ←

money on your brake shoe bills, both in first cost and maintenance, by adopting this standard type.

The steel back strengthens the shoe and *doubles its life.* Let us tell you about it.

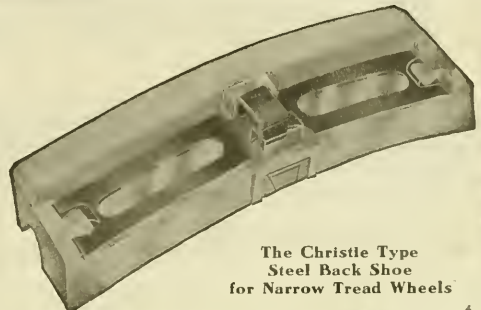

The Christie Type  
Steel Back Shoe  
for Narrow Tread Wheels

**American Brake Shoe & Foundry Co.**  
New York Chicago Chattanooga MAHWAH, N. J.

## THE J. G. BRILL COMPANY, PHILADELPHIA, PA.

AMERICAN CAR COMPANY, ST. LOUIS, MO.  
 G. C. KUHLMAN CAR COMPANY, CLEVELAND, OHIO  
 JOHN STEPHENSON COMPANY, ELIZABETH, N. J.  
 WASON MANUFACTURING CO. SPRINGFIELD, MASS.

MAIN OFFICE: PHILADELPHIA, PA.  
 LONDON OFFICE: 110 CANNON ST. E. C.  
 PACIFIC COAST AGENTS: PIERSON  
 ROEDING & CO., SAN FRANCISCO.  
 AUSTRALIAN AGENTS: NOYES  
 BROTHERS, SYDNEY. CABLES:  
 "BRILL," PHILA., "AXLES" LONDON.

*CARS TRUCKS SEATS RATTAN SPRINGS SPECIALTIES SUPPLIES*

## SAFE SUMMER SERVICE

The "Narragansett" is the right car for handling crowds safely in excursion service and is the only practical double-truck open car. The width over all is the same as a single-step open car as the upper step is on the flange of a Z-bar sill and within the line of the posts. The best possible arrangement of the running board of a single step car with the minimum height of floor is 19½ inches to board and 17 inches to floor. The same height in the "Narragansett" is divided into 16, 13 and 7½ inches. Companies which have used "Narragansett" cars for a number of years have recently reported that they have had no accidents. Women, children and elderly persons can get in and out easily and quickly. The Z-bar sills make it the strongest open car ever built. The arrangement does not reduce the length of the seats. Write for catalog.

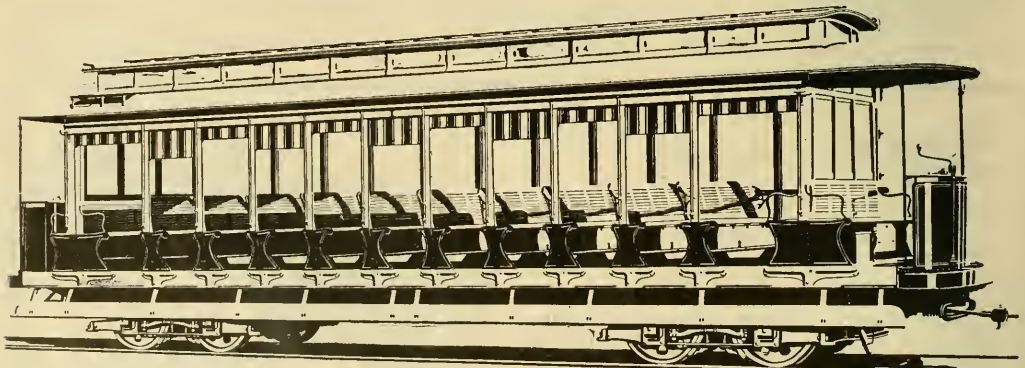

*THE BRILL "NARRAGANSETT" CAR (PATENTED)*

# General Electric Company

## Circuit Breakers Type MR

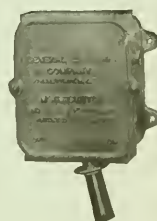

For Car Equipments

MR-10A-50 to 150 Amperes  
MR-11A-100 to 300 Amperes

MR-12A-200 to 600 Amperes  
MR-13A-300 to 900 Amperes

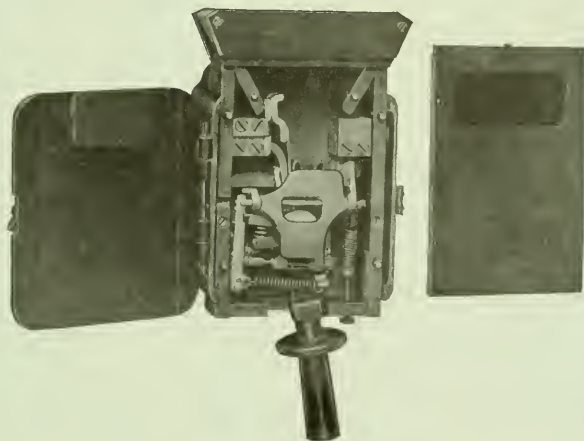

SMALL

COMPACT

RELIABLE

All parts readily accessible for repair or inspection

### Contacts and Operation:

Main contact brush protected by auxiliary contact fingers. Positive catch and wiping contact prevent sticking. Cannot remain in any position except full on or full off.

**Arc Chute:** Arc rupture concealed by extension arc chute.

**Insulation:** No "live" parts exposed. All working parts encased in insulated box

These breakers can be used as a device to automatically break the main trolley circuit in case of excessive overloads or short circuits, and as a hand operated main circuit switch.

1582

Principal Office:

Chicago Office:  
Monadnock Bldg.

# Schenectady, N. Y.

Sales Offices in  
All Large Cities

# NORTHERN CRANES



121 C

We give especial attention to Cranes for Electric Railway Power Stations, Car Shops and Barns. Also to Coal and Ash Handling Cranes and Hoists.

**NORTHERN ENGINEERING WORKS, DETROIT, MICH.**

ELECTRIC HOISTS      AIR HOISTS      AIR JACKS

## LUFKIN

### MEASURING TAPES

are the choice of expert electrical engineers in all quarters of the globe. Absolute accuracy and the highest possible degree of durability make them especially adapted to Electric Railway Work.

New York, London, Eng., Windsor, Can.

## THE LUFKIN RULE CO.

SACINAW MICH., U.S.A.



"Phono-Electric" Trolley Wire will stand up under the most trying conditions.—"It's tough."

Our "Red Booklet" tells why. Mailed free.

BRIDGEPORT BRASS COMPANY  
253 Broadway, New York  
Mills: Bridgeport, Conn.

## STEEL WOOL JOURNAL PACKING

- saves one-half the packing
- saves one-third the oil
- saves labor and wear
- prevents hot boxes **positively**

No other packing you ever heard of can do these things!

*Send today for free sample*

**WM. ROBERTSON & COMPANY**  
General Office: Great Northern Bldg., CHICAGO  
Factory: 75 S. Jefferson St., BATTLE CREEK, MICH.

## The Signal System

that prevents accidents  
facilitates traffic and  
promotes adherence to  
schedules

is made by the

### TELEGRAPH SIGNAL COMPANY

282 State Street, - - - Rochester, N. Y.

# THE SYMINGTON JOURNAL BOX

## FOR ELECTRIC TRUCKS

Now Standard on the Majority of Modern Electric Trucks of M. C. B. or Special Type

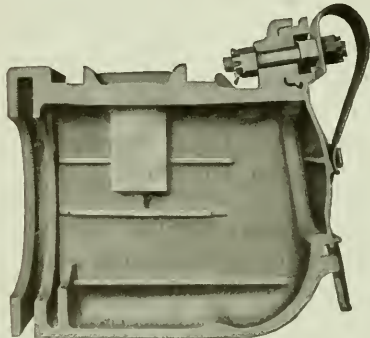
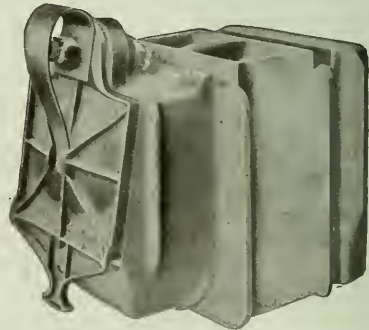
**Special Notice!**

WE ARE PREPARED TO FURNISH AT ONCE  
THE **STANDARD JOURNAL BOXES** OF  
THE AMERICAN STREET AND INTERURBAN RAILWAY ASSOCIATION

BALTIMORE MD.

**THE T. H. SYMINGTON CO.**

CHICAGO ILL.

# Electric Railway Review

PUBLISHED EVERY SATURDAY.

FORMERLY THE STREET RAILWAY REVIEW.

THE WILSON COMPANY, CHICAGO.

160 Harrison Street, Chicago  
150 Nassau Street, New York  
1529 Williamson Bldg., Cleveland

VOL. XIX  
No. 7

CHICAGO, FEBRUARY 15, 1908

Whole No.  
251

Subscription: Domestic . . . \$2  
Foreign . . . \$5  
Canada . . . \$3.50

## A New Section Insulator

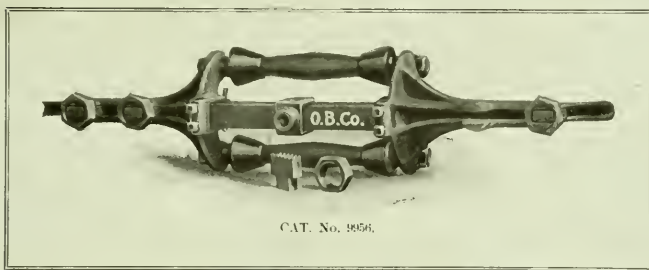

CAT. No. 1956.

☞ **Exceptional mechanical strength and insulating qualities** are prominent features. ☞ No horizontal stress comes on the runner piece or suspension bar, the pull being sustained by two wood break strain insulators in the same plane as the trolley wire, which **eliminates any tendency to buckle**. ☞ Trolley wires are held in the cars by binding wedges (see illustration). **The largest wires will break before slippage occurs**, and without injury to the insulator. ☞ The wooden runner piece is removable, being separate from the suspension bar.

*Address Line Material Division for full particulars.*

*Please mention this advertisement.*

## THE OHIO BRASS COMPANY

MANSFIELD, OHIO

NEW YORK: 43-49 Exchange Place  
CHICAGO: 321 Dearborn Street  
Burt Gellatly, 336 Fourth Ave., Pittsburg, Pa.

::

ST. LOUIS: 10 North Forth Street  
ATLANTA: 308 Peters Building  
Pierson, Roeding & Co., San Francisco, Los Angeles, Seattle

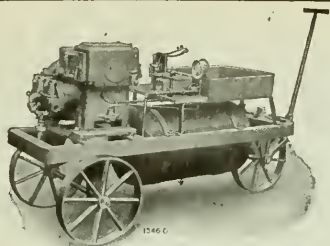

Portable Outfit with A-1 Compressor

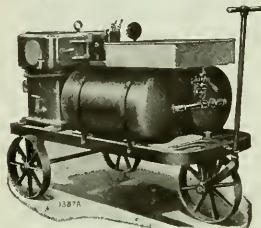

Portable Outfit with CC-3 Compressor

## National Portable Air Compressor Outfits

are especially adapted for service in car shops where compressed air is used for various operations such as drilling, chipping, riveting and for blowing dust and other matter out of car motors, car seats, etc. They are built in capacities of from 11 to 50 cubic feet of free air per minute. The 11 and 35 cubic foot sizes are illustrated herewith.

The small width of National Portable Outfits permits of their being taken through doors and other openings of much smaller width than the average.

Bulletin Sent on Request

## National Brake & Electric Co.

NEW YORK: 111 Broadway

PHILADELPHIA:

W. H. Goble, 1722 Westmoreland St.

BOSTON: F. E. Huntress, 131 State St.

Milwaukee, U. S. A.

SAN FRANCISCO, CAL.: W. F. McKenny,

69-71 First Street

LONDON: 14 Great Smith St. Westminster

General Sales Office: 519 First National Bank Building, Chicago

We buy for spot cash anything you may have for sale in the way of

**Railway Motors  
Armatures  
Commutators  
Scrap Copper, Etc.**

↔ No deal too large for us to handle ↔

We refer to Bradstreet, Dun or any Cleveland bank.

**Cleveland Armature Works**

4732 St. Clair Avenue

:

:

CLEVELAND, OHIO

America's Greatest Armature Winding, Commutator and Field Works

# Westinghouse

## Heavy Duty Gas Engines

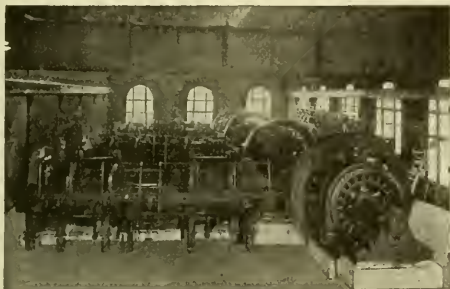

### Overloads

A 1500-KW Westinghouse Gas Engine Generating Set, recently put into service on blast furnace gas in a large steel mill, demonstrated from the start its ability to maintain frequent overloads.

Ask nearest office for full particulars

## The Westinghouse Machine Co.

Steam Turbines, Steam Engines, Gas Engines, Gas Producers, Storage Batteries and The Roney Stoker

New York, 10 Bridge Street  
Boston, 131 State Street  
Atlanta, Candler Building  
St. Louis, Chemical Building

Pittsburg, Westinghouse Building  
Cleveland, New England Building  
Chicago, 171 La Salle Street  
Cincinnati, Traction Building

Philadelphia, North American Building  
Denver, McPhee Building  
San Francisco, Hunt, Mirk & Co.



### First Cost

is often the deciding factor in choosing the equipment for single car operation. Westinghouse SM-1 and SM-3 straight air equipments meet this condition. They are the cheapest good straight air brake equipments on the market, easy to operate and easy to maintain.

For one, two, three, four and five car "train service" our AMM automatic, graduated release, quick service, quick recharge, high pressure emergency equipment has no equal.

Any Braking Problem Solved

Westinghouse Traction Brake Co., Pittsburg, Pa.

## Take No Risks

Have Westinghouse apparatus repaired only with Westinghouse material, by Westinghouse skilled labor, in the Westinghouse factory. You cannot expect it to maintain its high standard if repaired with inferior material.

Our nearest office will give full particulars

### Westinghouse Electric & Mfg. Co.

Atlanta Cincinnati Kansas City New York Salt Lake City  
Baltimore Cleveland Los Angeles Philadelphia San Francisco  
Boston Dallas Minneapolis Pittsburg Seattle  
Buffalo Denver New Orleans St. Louis Syracuse  
Chicago Detroit Mexico: G. & O. Brantiff & Co., City of Mexico  
Canada: Canadian Westinghouse Co., Ltd., Hamilton, Ont.

Advance Lumber Co. .... 16  
 Allis-Chalmers Co. .... 16  
 Aluminum Co. of America. .... 20  
 American Brake Shoe & Fdry. Co. .... 25  
 American Electrical Works. .... 17  
 American Frog & Switch Co. .... 17  
 Anderson, Albert & J. M., Mfg. Co. .... 17  
 Armstrong Oiler Co. .... 17  
 Arnold Company. .... 22  
 Atlas Anchor Co. .... 18  
 Babcock & Wilcox Co. .... 12  
 Baker, The Wm. C., Heating & Supply Co. .... 15  
 Baldwin Locomotive Works. .... 18  
 Barbour-Stockwell Co. .... 18  
 Barnes, G. H., Hardwood Lumber Co. .... 16  
 Beidler, Francis, & Co. .... 16  
 Bellamy Vestlette Mfg. Co. .... 21  
 Berthold & Jennings. .... 21  
 Blake Signal & Mfg. Co. .... 21  
 Bliss, R. Mfg. Co. .... 21  
 Bridgeport Brass Co. .... 21  
 Brill, The J. G., Co. .... 26  
 Brown, Harold P., Co. .... 23  
 Brown Hoisting Machinery Co. .... 23  
 Buckeye Engine Co. .... 23  
 Burnham, Williams & Co. .... 18  
 Byllesby, H. M., & Co. .... 22  
 Central Inspection Bureau. .... 22  
 Chase-Shawmut Co. .... 24  
 Churchill Cedar Co. .... 16  
 Cincinnati Car Co. .... 23  
 Cincinnati Frog & Switch Co. .... 23  
 Cleveland Armature Works. .... 2  
 Cleveland Frog & Cross. Co. .... 2  
 Collier, Barron G. .... 18  
 Columbia Construction Co. .... 20  
 Consolidated Car Fender Co. .... 20  
 Consolidated Car-Heating Co. .... 22  
 Contractors' Supply & Equipment Co. .... 21  
 Cooper Heater Co. .... 21  
 Crane Co. .... 16  
 Creaghead Engineering Co. .... 23  
 Curtain Supply Co. .... 23  
 Davis, The John, Co. .... 24  
 Dearborn Drug & Chemical Works. .... 17  
 Detroit Graphite Co. .... 24

Drouvé, The G. Co. .... 24  
 Drummond Detective Agency. .... 24  
 Durkin Controller Handle Co. .... 24  
 Earl, C. I. .... 13  
 Eclipse Railway Supply Co. .... 18  
 Electric Railway Equipment Co. .... 13  
 Electric Ry. Improvement Co. .... 23  
 Electric Service Supplies Co. .... 23  
 Engineers and Contractors. .... 22  
 Fairbanks, Morse & Co. .... 24  
 Ford, Bacon & Davis. .... 24  
 Galena-Signal Oil Co. .... 24  
 General Electric Co. .... 27  
 Goldschmidt Thermit Co. .... 28  
 Green Engineering Co. .... 17  
 Green Fuel Economizer Co. .... 17  
 Griffin Wheel Co. .... 22  
 Grip Nut Co. .... 25  
 Hagy J. Milton, Waste Wks. .... 12  
 Hale & Kilburn Mfg. Co. .... 19  
 Harrison, F. P., Elec. Mfg. Co. .... 19  
 Hartshorn, Stewart, Co. .... 16  
 Heine Safety Boiler Co. .... 21  
 Heywood Bros. & Wakefield Co. .... 21  
 Holman, D. F., Ry. Tracklayer Co. .... 16  
 Hope Lumber Co. .... 16  
 Humbird Lumber Co. Ltd. .... 16  
 Indestructible Fibre Co. .... 22  
 Jewett Car Co. .... 15  
 Johann, F. A. .... 21  
 Johns-Manville, H. W., Co. .... 5  
 Kalamazoo Ry. Supply Co. .... 25  
 Kinnear Manufacturing Co. .... 24  
 Lindsay Bros. Co., The. .... 16  
 Lorain, Inc. Co. .... 18  
 Lord & Burnham Co. .... 19  
 Lufkin Rule Co. .... 28  
 Lumen Bearing Co. .... 19  
 Macallen Co. .... 21  
 McGuire-Cummings Mfg. Co. .... 21  
 Marshall, R. W., & Co. .... 21  
 Massachusetts Chemical Co. .... 12  
 Meyers, Fred J., Mfg. Co. .... 22

Miller Anchor Co. .... 21  
 Milloy Electric Co., The. .... 21  
 Model Stoker Co., The. .... 22  
 Morden Frog & Crossing Wks. .... 22  
 National Brake & Electric Co. .... 2  
 National Lock Washer Co. .... 15  
 National Pole Co. .... 16  
 Naugle Pole & Tie Co. .... 16  
 New York Switch & Crossing Co. .... 22  
 Niles, Car & Mfg. Co. .... 15  
 Northern Engineering Works. .... 23  
 Nuttall, R. D., Co. .... 23  
 Ohio Brass Co. .... 1  
 Okonite Co., Ltd. .... 13  
 Pacific Coast Pole Co. .... 16  
 Pantasote Co. .... 15  
 Patten, Paul B. .... 19  
 Pay-As-You-Enter Car Co. .... 9  
 Power Specialty Co. .... 19  
 Pressed Steel Car Co. .... 19  
 Queen & Co. .... 17  
 Rail Joint Co. .... 16  
 Railway Specialty & Supply Co. .... 19  
 Railway Steel-Spring Co. .... 22  
 Recording Face Register Co. .... 28  
 Reed, Francis Co. .... 17  
 Register, L. & Co. .... 22  
 Reiter, G. C. .... 21  
 Ridlon, Frank, Co. .... 22  
 Roberts & Abbott Co. .... 22  
 Roberton Wm., & Co. .... 11  
 Rodger Ballast Car Co. .... 22  
 Rooke Automatic Register Co. .... 13  
 Rossiter, MacGovern & Co. .... 13  
 Russell Car & Snow-Flow Co. .... 21  
 S-E. Missouri Cypress Co. .... 16  
 St. Louis Car Wheel Co. .... 7  
 St. Louis Surfacer & Paint Co. .... 12  
 Sanderson & Porter. .... 22  
 Sarton E. Co. .... 22  
 Shimer & Chase Co. .... 22  
 Sheaff & Jastaad. .... 22  
 Simmons, John, Co. .... 18  
 Smith, Peter, Heater Co. .... 19

Speer Carbon Co. .... 23  
 Standard Brake Shoe Co. .... 23  
 Standard Motor Truck Co. .... 13  
 Standard Paint Co. .... 21  
 Standard Steel Works. .... 18  
 Standard Underground Cable Co. .... 23  
 Standard Varnish Works. .... 23  
 Star Brass Works. .... 18  
 Stone & Webster Engineering Corporation. .... 5, 22  
 Stuart-Howland Co. .... 23  
 Symington, T. H., Co. .... 23  
 Telegraph Signal Co. .... 28  
 Trolley Supply Co. .... 28  
 Under-Feed Stoker Co. .... 18  
 United States Graphite Co. .... 23  
 Wagon, Wm., Jr., & Co. .... 24  
 U. S. Metal & Mfg. Co. .... 25  
 Van Dorn & Dutton Co. .... 22  
 Van Dorn, W. T., Co. .... 19  
 Van Valkenburgh, E. C. .... 19  
 Wallace Supply Co. .... 23  
 Wanted and For Sale Cards. .... 21  
 Washburn Steel Castings & Coupler Co. .... 19  
 Watson-Stillman Co. .... 21  
 Wendt, MacDuffie. .... 23  
 Western Electric Co. .... 3  
 Westinghouse Elec. & Mfg. Co. .... 3  
 Westinghouse Machine Co. .... 3  
 Westinghouse Traction Brake Co. .... 3  
 Weston Electrical Instrument Co. .... 17  
 White, J. G., & Co. .... 22  
 Wheeler Condenser & Eng'g Co. .... 22  
 Wheel Truing Brake Shoe Co. .... 22  
 White, J. G., & Co. .... 22  
 Whitmore Mfg. Co., The. .... 17  
 Wilson, J. G., Mfg. Co. .... 24  
 Wood, Gullford S. .... 12  
 Woodman, R., Mfg. & Supply Co. .... 16  
 Worcester, C. H., Co. .... 16  
 Zeinicker, Walter A., Supply Co. .... 21

### CLASSIFIED LIST OF ADVERTISERS.

**Advertising Service.**  
 Van Valkenburgh, E. C., 2117 West One Hundred and Second St., Chicago.

**Advertising, Street Car.**  
 Collier, Barron G., Flat Iron Bldg., New York.

**Air Brakes—(See Brakes and Brake Parts).**

**Air Compressors—(See Compressors, Air).**

**Alloys and Bearing Metals.**  
 Brown, H. P., 120 Liberty St., New York.  
 General Electric Co., Schenectady, N. Y.  
 Harrison Elec. & Mfg. Co., 169 South St., New York.  
 Lumen Bearing Co., Buffalo, N. Y.  
 Ohio Brass Co., Mansfield, O.  
 Ridlon, Frank, Co., 200 Summer St., Boston.  
 St. Louis Car Co., St. Louis, Mo.

**Aluminum Wire, Etc.**  
 Aluminum Co. of America, Pittsburg.

**Anchors.**  
 Atlas Anchor Co., Cleveland, O.  
 Electric Service Supplies Co., 200 Plymouth Bldg., Chicago.  
 Miller Anchor Co., Norwalk, O.  
 Ohio Brass Co., Mansfield, O.

**Armatures and Coils, Winding and Repairing.**  
 Cleveland Armature Works, Cleveland, O.  
 Electric Service Supplies Co., 200 Plymouth Bldg., Chicago.  
 General Electric Co., Schenectady, N. Y.  
 Harrison Elec. & Mfg. Co., 169 South St., New York.  
 Marshall, R. W., & Co., 95 Liberty St., New York.  
 Ridlon, Frank, Co., 200 Summer St., Boston.  
 Stuart-Howland Co., Boston.

**Armature Lifts.**  
 Electric Service Supplies Co., 200 Plymouth Bldg., Chicago.

**Asbestos Materials.**  
 Johns-Manville, H. W., Co., New York.

**Axles—(See Wheels and Axles).**

**Babbitt Metals—(See Alloys and Bearing Metals).**

**Badges and Buttons.**  
 Electric Service Supplies Co., 200 Plymouth Bldg., Chicago.  
 Recording Face Register Co., New Haven, Conn.

**Ballast Cars—(See Cars, Ballast).**

**Ball Bearings.**  
 Symington, T. H., Co., Baltimore, Md.

**Bases—(See Trolley Poles and Fittings).**

**Bearings.**  
 Electric Service Supplies Co., 200 Plymouth Bldg., Chicago.  
 General Electric Co., Schenectady, N. Y.  
 Harrison Elec. & Mfg. Co., 169 South St., New York.  
 Lumen Bearing Co., Buffalo, N. Y.  
 McGuire-Cummings Mfg. Co., Chicago.  
 Marshall, R. W., & Co., 95 Liberty St., New York.  
 Nuttall, R. D., Co., Pittsburg, Ohio  
 Ohio Brass Co., Mansfield, O.  
 Ridlon, Frank, Co., 200 Summer St., Boston.  
 Symington, T. H., Co., Baltimore, Md.  
 Van Dorn & Dutton Co., Cleveland, O.

**Bells and Gongs.**  
 American Car Co., St. Louis.  
 Brill, The J. G., Co., Philadelphia.  
 Electric Service Supplies Co., 1020-24 Filbert St., Phila.

**Bells and Gongs—Continued.**  
 Kuhlman, The G. C., Car Co., Cleveland.  
 McGuire-Cummings Mfg. Co., Chicago.  
 Ohio Brass Co., Mansfield, O.  
 Reiter, G. C., Canton, O.  
 St. Louis Car Co., St. Louis, Mo.  
 Stephenson, John, Co., Elizabeth, N. J.  
 Wallace Supply Co., Chicago.  
 Wason Mfg. Co., Springfield, Mass.  
 Western Electric Co., Chicago.

**Black Lead.**  
 Detroit Graphite Co., Detroit, Mich.  
 U. S. Graphite Co., Saginaw, Mich.

**Block System—(See Signals).**

**Blowers—(See Mechanical Draft).**

**Blue Printing Machines.**  
 Buckeye Engine Co., Salem, O.

**Boilers.**  
 Babcock & Wilcox Co., N. Y.  
 Fairbanks, Morse & Co., Chicago.  
 Green Fuel Economizer Co., Matteawan, N. Y.  
 Heine Safety Boiler Co., 421 Olive St., St. Louis.  
 Lord & Burnham, Irvington-on-Hudson, New York.  
 Rossiter, MacGovern & Co., 17 Battery Pl., New York.

**Boiler Cleaning Compound.**  
 Dearborn Drug & Chemical Works, Chicago.  
 Johns-Manville, H. W., Co., New York.

**Bonds, Rail.**  
 Brown, H. P., 120 Liberty St., New York.  
 Chase-Shawmut Co., Newburyport, Mass.  
 Electric Railway Improvement Co., Cleveland, O.  
 Electric Service Supplies Co., 200 Plymouth Bldg., Chicago.  
 General Electric Co., Schenectady, N. Y.

**Bonds, Rail—Continued.**  
 Goldschmidt Thermit Co., 43 Exchange Pl., New York.  
 Johns-Manville, H. W., Co., New York.  
 Ohio Brass Co., Mansfield, O.

**Brackets and Cross Arms.**  
 Anderson, Albert & J. M., Mfg. Co., Boston.  
 Creaghead Engineering Co., Cincinnati, O.  
 Electric Railway Equipment Co., Cincinnati, O.  
 Electric Service Supplies Co., 200 Plymouth Bldg., Chicago.  
 Johns-Manville, H. W., Co., New York, N. Y.  
 Lindsay Bros. Co., Spokane, Wash.  
 Ohio Brass Co., Mansfield, O.  
 Ridlon, Frank, Co., 200 Summer St., Boston.  
 Stuart-Howland Co., Boston.  
 Western Electric Co., Chicago.

**Brakes and Brake Parts.**  
 Allis-Chalmers Co., Milwaukee, Wis.  
 American Car Co., St. Louis.  
 Brill, The J. G., Co., Philadelphia.  
 Electric Service Supplies Co., 200 Plymouth Bldg., Chicago.  
 General Electric Co., Schenectady, N. Y.  
 Kuhlman, The G. C., Car Co., Cleveland.  
 McGuire-Cummings Mfg. Co., Chicago.  
 National Brake & Electric Co., Milwaukee.  
 Stephenson, John, Co., Elizabeth, N. J.  
 Wason Mfg. Co., Springfield, Mass.  
 Westinghouse Traction Brake Co., Pittsburg, Pa.

**Brakeshoes.**  
 American Brake Shoe & Fdry. Co., Mahwah, N. J.  
 American Car Co., St. Louis.  
 Barbour-Stockwell Co., Cambridgeport, Mass.



# WESTERN ELECTRIC

**COMPANY**

CHICAGO    DENVER    SAINT PAUL    NEW YORK  
 SAINT LOUIS    PITTSBURG    CINCINNATI    ATLANTA  
 SAN FRANCISCO    SEATTLE    KANSAS CITY    PHILADELPHIA  
 SALT LAKE CITY    LOS ANGELES

## A. C. GENERATORS

The EFFICIENCY CURVE of an A. C. generator is a vital point to consider. Western Electric A. C. generators have a comparatively flat efficiency curve which is obtained by nicely proportioning what are known as the natural

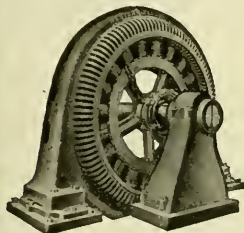

copper and iron losses. These losses are kept at a minimum, thus giving high operating efficiency, low temperature rise and large overload capacity.

Western Electric A. C. generators will give you the highest average or all-day efficiency, and we can prove it. Write today for catalog No. 5210-C

# Every Car

SHOULD BE PROVIDED WITH

## MANVILLE FIRE EXTINGUISHERS



The only Extinguisher which is really effective in putting out electrical fires. Liquids are conductors of electricity, but the dry powder used in the **Manville Extinguisher**, being a non-conductor, will put out the fire without spreading it or causing further damage.



Over a half million in use by the U. S. Government, prominent firms and electric railway companies.

*Write nearest branch for special proposition*

## H. W. JOHNS-MANVILLE CO.



NEW YORK	PITTSBURG	MINNEAPOLIS
MILWAUKEE	CLEVELAND	SAN FRANCISCO
CHICAGO	BUFFALO	LOS ANGELES
BOSTON	BALTIMORE	SEATTLE
PHILADELPHIA	NEW ORLEANS	DALLAS
ST. LOUIS	KANSAS CITY	LONDON 750

**3000 K. W. Power Station of The Lowell Electric Light Corporation**



**WE** are prepared to undertake the design and construction of water power developments, power stations, industrial buildings, railways, electrical transmission lines and distributing systems.

We make preliminary reports and estimates, design your plant in all details, select and buy your land or right-of-way, purchase your equipment and construct your plant, turning it over to you ready for operation.

All our contracts are on a basis of cost plus a fixed sum, or cost plus a percentage. We act as agents for you, our client, keep you fully informed as to costs, progress, etc., and submit vouchers for all expenditures on your account.

If you contemplate any construction, either new work or an extension, write for further information, or arrange for a personal interview.

**Stone & Webster**  
**Engineering Corporation**  
 Constructing Engineers  
 147 Milk Street - BOSTON, MASS.

## CLASSIFIED LIST OF ADVERTISERS—Continued.

- Brakeshoes—Continued.**  
Brill, The J. G., Co., Philadelphia.  
Kuhlman, The G. C., Car Co., Cleveland.  
McQuire-Cummings Mfg. Co., Chicago.  
Marshall, R. W., & Co., 95 Liberty St., New York.  
St. Louis Car Co., St. Louis, Mo.  
Standard Brake Shoe Co., Aurora, Ill.  
Stephenson, John, Co., Elizabeth, N. J.  
Wason Mfg. Co., Springfield, Mass.  
Wharton, Wm., Jr., & Co., Philadelphia.  
Wheel Truing Brake Shoe Co., Detroit.
- Bridges.**  
Johann, F. A., 1624 Pierce Bldg., St. Louis.
- Bridge Timbers.**  
Beidler, Francis, & Co., Chgo.
- Brushes, Motors and Dynamos.**  
Electric Service Supplies Co., 200 Plymouth Bldg., Chicago.  
General Electric Co., Schenectady, N. Y.  
Ridlon, Frank Co., 200 Summer St., Boston.  
Speer Carbon Co., St. Marys, Pa.
- Bumpers, Car.**  
American Car Co., St. Louis.  
Brill, The J. G., Co., Philadelphia.  
Kuhlman, The G. C., Car Co., Cleveland.  
St. Louis Car Co., St. Louis, Mo.  
Stephenson, John, Co., Elizabeth, N. J.  
Wason Mfg. Co., Springfield, Mass.
- Car House Doors.**  
Kinnear Mfg. Co., Columbus, O.  
Wilson, J. G., Mfg. Co., New York.
- Car Replacers.**  
Electric Service Supplies Co., 200 Plymouth Bldg., Chicago.  
Fairbanks, Morse & Co., Chgo. Kalamazoo Railway Supply Co., Kalamazoo, Mich.  
Ohio Brass Co., Mansfield, O.  
U. S. Metal & Mfg. Co., 25 Broad St., New York.
- Car Roof Paint, Canvas.**  
St. Louis Surfacor & Paint Co., St. Louis, Mo.
- Car Seats.**  
American Car Co., St. Louis.  
Brill, The J. G., Co., Philadelphia.  
Hale & Kilburn Mfg. Co., Philadelphia.  
Heywood Bros. & Wakefield Co., Wakefield, Mass.  
Kuhlman, The G. C., Car Co., Cleveland.  
St. Louis Car Co., St. Louis, Mo.  
Stephenson, John, Co., Elizabeth, N. J.  
Wallace Supply Co., Chicago.  
Wason Mfg. Co., Springfield, Mass.
- Car Signs—(See Signs, Cars and Track).**
- Car Steps.**  
Electric Service Supplies Co., 200 Plymouth Bldg., Chicago.  
Wallace Supply Co., Chicago.
- Car Trimmings—(See Trimmings, Car).**
- Cars, Ballast.**  
Rodger Ballast Car Co., Chgo.  
St. Louis Car Co., St. Louis, Mo.
- Cars, Dump.**  
Fairbanks, Morse & Co., Chgo.  
Rodger Ballast Car Co., Chgo.  
Russell Car & Snow-Plow Co., Ridgway, Pa.  
St. Louis Car Co., St. Louis, Mo.
- Cars, Passenger and Freight—Continued.**  
American Car Co., St. Louis.  
Brill, The J. G., Co., Philadelphia.  
Cincinnati Car Co., Cincinnati.  
Detroit Carbuilding & Equipment Co., Detroit, Mich.
- Cars, Passenger and Freight—Continued.**  
Electric Railway Improvement Co., Cleveland, O.  
Fairbanks, Morse & Co., Chgo.  
Jewett Car Co., Newark, O.  
Johann, F. A., 1624 Pierce Bldg., St. Louis.  
Kuhlman, The G. C., Car Co., Cleveland.  
McQuire-Cummings Mfg. Co., Chicago.  
Niles Car & Mfg. Co., Niles, O.  
Pressed Steel Car Co., Pittsburg.  
Rodger Ballast Car Co., Chgo.  
Russell Car & Snow-Plow Co., Ridgway, Pa.  
St. Louis Car Co., St. Louis, Mo.  
Standard Motor Truck Co., Pittsburg.  
Stephenson, John, Co., Elizabeth, N. J.  
Wason Mfg. Co., Springfield, Mass.
- Cars, Pay-As-You-Enter.**  
Pay-As-You-Enter Car Co., 26 Cortland St., New York.
- Cars, Rebuilt.**  
Detroit Carbuilding & Equipment Co., Detroit, Mich.
- Cars, Second-Hand.**  
Detroit Carbuilding & Equipment Co., Detroit, Mich.  
Marshall, R. W., & Co., 95 Liberty St., New York.  
Zelnicke, Walter A., Supply Co., St. Louis.
- Cars, Steel.**  
Pressed Steel Car Co., Pittsburg.  
St. Louis Car Co., St. Louis, Mo.  
Standard Motor Truck Co., Pittsburg.
- Castings, Brass.**  
Star Brass Works, Kalamazoo, Mich.
- Castings, Iron and Steel.**  
American Brake Shoe & Foundry Co., Mahwah, N. J.  
Green Engineering Co., Com'l Nat. Bk. Bldg., Chicago.  
Lorain Steel Co., Johnstown, Pa.  
National Brake & Electric Co., Milwaukee.
- Catchers—(See Trolley Retrievers and Catchers).**
- Cattle Guards.**  
Fairbanks, Morse & Co., Chgo.
- Cements, Cable and Transformer.**  
Massachusetts Chemical Co., Walpole, Mass.
- Circuit-Breakers.**  
Electric Service Supplies Co., 200 Plymouth Bldg., Chicago.  
General Electric Co., Schenectady, N. Y.  
Western Electric Co., Chicago.
- Coal Handling Machinery—(See Conveyors).**
- Coils—(See Armatures and Coils).**
- Commutators and Parts.**  
Cleveland Armature Works, Cleveland, O.  
Electric Service Supplies Co., 1020-24 Filbert St., Phila.  
General Electric Co., Schenectady, N. Y.  
Harrison Elec. & Mfg. Co., 169 South St., New York.  
Marshall, R. W., & Co., 95 Liberty St., New York.  
Ohio Brass Co., Mansfield, O.  
Stuart-Howland Co., Boston.
- Compressors, Air.**  
Fairbanks, Morse & Co., Chgo.  
General Electric Co., Schenectady, N. Y.  
National Brake & Electric Co., Milwaukee.  
Westinghouse Traction Brake Co., Pittsburg.
- Concrete Mixers.**  
Contractors' Supply & Equip. Co., Chicago.
- Condensers.**  
Wheeler Car & Eng. Co., New York.
- Conduits.**  
Electric Service Supplies Co., 200 Plymouth Bldg., Chicago.  
Western Electric Co., Chicago.
- Contractors.**  
Arnold Company, 181 La Salle St., Chicago.  
Eylesby, H. M., Co., Am. Trust Bldg., Chicago.  
Sanderson & Porter, 52 William St., Milwaukee, Wis.  
Creaghead Engineering Co., Cincinnati, O.  
Green Engineering Co., Com'l Nat. Bk. Bldg., Chicago.  
Register, A. L., & Co., 112 N. Broad St., Philadelphia.  
Saxe & Jaastad, 83 Broad St., Boston.  
Stone & Webster Engineering Corp., Boston.  
Wharton, Wm., Jr., & Co., Philadelphia.  
White, J. G., & Co., 49 Exchange Pl., New York.
- Controllers and Attachments.**  
Durkin Con. Handle Co., Arcade Bldg., Philadelphia.  
Electric Service Supplies Co., 200 Plymouth Bldg., Chicago.  
General Electric Co., Schenectady, N. Y.  
Harrison Elec. & Mfg. Co., 169 South St., New York.  
Johns-Manville, H. W., Co., New York.  
Marshall, R. W., & Co., 95 Liberty St., New York.  
Western Electric Co., Chicago.  
Westinghouse Electric & Mfg. Co., Pittsburg.
- Conveyors and Coal Handling Machinery.**  
Green Engineering Co., Com'l Nat. Bk. Bldg., Chicago.  
Northern Engineering Works, Detroit, Mich.
- Cord, Bell and Trolley.**  
American Car Co., St. Louis.  
Brill, The J. G., Co., Philadelphia.  
Electric Service Supplies Co., 1020-24 Filbert St., Phila.  
Kuhlman, The G. C., Car Co., Cleveland.  
St. Louis Car Co., St. Louis, Mo.  
Stephenson, John, Co., Elizabeth, N. J.  
Stuart-Howland Co., Boston.  
Wason Mfg. Co., Springfield, Mass.
- Couplers, Car.**  
American Car Co., St. Louis.  
Brill, The J. G., Co., Philadelphia.  
Kuhlman, The G. C., Car Co., Cleveland.  
McQuire-Cummings Mfg. Co., Chicago.  
Ohio Brass Co., Mansfield, O.  
St. Louis Car Co., St. Louis, Mo.  
Stephenson, John, Co., Elizabeth, N. J.  
Stuart-Howland Co., Boston.  
Wason Mfg. Co., Springfield, Mass.
- Couplers, Car.**  
American Car Co., St. Louis.  
Brill, The J. G., Co., Philadelphia.  
Kuhlman, The G. C., Car Co., Cleveland.  
McQuire-Cummings Mfg. Co., Chicago.  
Ohio Brass Co., Mansfield, O.  
St. Louis Car Co., St. Louis, Mo.  
Stephenson, John, Co., Elizabeth, N. J.  
Stuart-Howland Co., Boston.  
Wason Mfg. Co., Springfield, Mass.
- Coverings, Pipe and Boiler.**  
Johns-Manville, H. W., Co., New York.
- Cranes, Holsts and Lifts.**  
American Car Co., St. Louis.  
Brill, The J. G., Co., Philadelphia.  
Brown Hoisting Machinery Co., Cleveland, O.  
Kuhlman, The G. C., Car Co., Cleveland.  
Northern Engineering Works, Detroit, Mich.  
Railway Specialty & Supply Co., Chicago.  
Stephenson, John, Co., Elizabeth, N. J.  
Van Dorn & Dutton Co., Cleveland, O.  
Wason Mfg. Co., Springfield, Mass.
- Cross Arms—(See Brackets and Cross Arms).**
- Crossing Gates—(See Gates and Guards).**
- Crossings, Track—(See Switches).**
- Curtains, Fixtures and Materials.**  
American Car Co., St. Louis.  
Brill, The J. G., Co., Philadelphia.  
Curtain Supply Co., 93 Ohio St., Chicago.
- Curtains, Fixtures and Materials—Continued.**  
Electric Service Supplies Co., 200 Plymouth Bldg., Chicago.  
Hartman, Stewart, Co., East Newark, N. J.  
Kuhlman, The G. C., Car Co., Cleveland.  
Marshall, R. W., & Co., 95 Liberty St., New York.  
National Lock Washer Co., Newark, N. J.  
Pantalone Co., 111 Broadway, New York.  
St. Louis Car Co., St. Louis, Mo.  
Stephenson, John, Co., Elizabeth, N. J.  
Wason Mfg. Co., Springfield, Mass.
- Cylinder Oil.**  
Power Specialty Co., 111 Broadway, N. Y.
- Derailing Devices.**  
American Frog & Switch Co., Hamilton, O.  
Cincinnati Frog & Switch Co., Cincinnati.  
Cleveland Frog & Crossing Co., Cleveland, O.
- Detective Agency.**  
Drummond Detective Agency, New York.
- Diaphragms.**  
Wood, G. S., Great Northern Bldg., Chicago.
- Doors and Fixtures.**  
American Car Co., St. Louis.  
Brill, The J. G., Co., Philadelphia.  
Kuhlman, The G. C., Car Co., Cleveland.  
St. Louis Car Co., St. Louis, Mo.  
Stephenson, John, Co., Elizabeth, N. J.  
Wallace Supply Co., Chicago.  
Wason Mfg. Co., Springfield, Mass.
- Doors, Steel Rolling.**  
Kinnear Manufacturing Co., Columbus, O.  
Wilson, J. G., Mfg. Co., New York.
- Draft, Mechanical—(See Mechanical Draft).**
- Draft Rigging.**  
Van Dorn, W. T., Co., Chgo.  
Wallace Supply Co., Chicago.
- Drills, Track.**  
Brown, H. P., 120 Liberty St., New York.  
Electric Service Supplies Co., 200 Plymouth Bldg., Chicago.  
Fairbanks, Morse & Co., Chgo. Kalamazoo Railway Supply Co., Kalamazoo, Mich.  
Marshall, R. W., & Co., 95 Liberty St., New York.  
Reed, Francis, Co., Worcester, Mass.  
Ridlon, Frank Co., 200 Summer St., Boston.
- Drying Appliances.**  
Green Fuel Economizer Co., Matteawan, N. Y.
- Dynamos and Generators.**  
Cleveland Armature Works, Cleveland, O.  
Fairbanks, Morse & Co., Chgo.  
General Electric Co., Schenectady, N. Y.  
National Brake & Electric Co., Milwaukee, Wis.  
Reisinger MacGovern & Co., 17 Battery Pl., New York.  
Western Electric Co., Chicago.  
Westinghouse Electric & Mfg. Co., Pittsburg, Pa.
- Economizers, Fuel.**  
Green Fuel Economizer Co., Matteawan, N. Y.
- Electrical Instruments.**  
Electric Service Supplies Co., 200 Plymouth Bldg., Chicago.  
General Electric Co., Schenectady, N. Y.  
Johns-Manville, H. W., Co., New York.  
Queen & Co., Philadelphia.  
Western Electric Co., Chicago.  
Westinghouse Electric & Mfg. Co., Pittsburg, Pa.  
Weston Electrical Instrument Co., Newark, N. J.
- Electric Railway Supplies, General.**  
Cleveland Armature Works, Cleveland, O.  
Creaghead Engineering Co., Cincinnati, O.

# ST. LOUIS CAR CO. ST. LOUIS-MO.

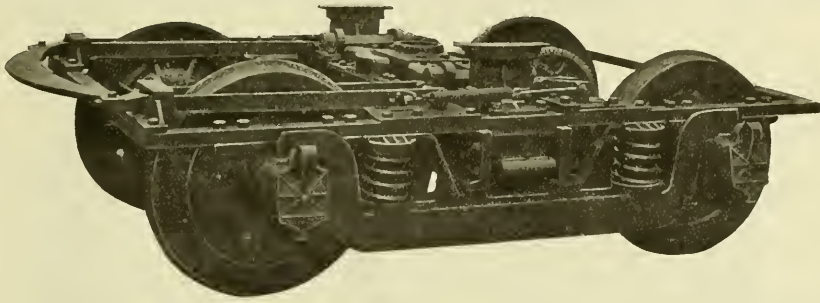

St. Louis Car Company M. C. B. Double Equalizer Type No. 62 Truck

## Details of Construction:

**T**RUCK frames are made of wrought iron forged in one piece, with a heavy fillet in each corner, and planed to receive pedestal jaws and center frames of transoms. Pedestals are of wrought iron and the upper face of each is machined so as to lip on side frame. Wearing faces are machined and provided with oil grooves. Faces which engage the pedestal tie bars are also machined.

Transoms are made of two 10" channels secured to frames by being bolted to machined cast steel side strut castings and bolted to side frame with heavy steel gusset plates.

Removable chafing plates are also provided on the transom channels. Bolsters are of cast steel and provided with end springs to

limit side motion of car body. Bolsters also are provided with removable chafing plates.

Equalizers are of wrought iron and forged with a lug to fit into recess in the journal boxes. Brakes are of the equalized type and arranged to suit cars operated around short curves.

Brake rigging is provided with suitable safety hangers. Ends of hangers and hanger pins are case hardened to reduce the wear to a minimum and prevent rattling.

All bolts used in assembling the trucks are taper finished, turned to a taper of  $\frac{3}{8}$ " per foot, and all holes for bolts are reamed to templates.

All parts of the truck when machined are made to template and all holes are drilled with a jig.

Made in the largest and best equipped  
factory of its kind in the world.

## CLASSIFIED LIST OF ADVERTISERS—Continued.

- Electric Railway Supplies, General—Continued.**  
 Electric Service Supplies Co., 200 Plymouth Bldg., Chicago.  
 Fairbanks, Morse & Co., Chgo.  
 General Electric Co., Schenectady, N. Y.  
 Harrison Elec. & Mfg. Co., 169 South St., New York.  
 Johns-Manville, H. W., Co., New York.  
 Marshall, R. W., & Co., 95 Liberty St., New York.  
 Ohio Brass Co., Mansfield, O.  
 Stuart-Howland Co., Boston.  
 Wallace Supply Co., Chicago.  
 Western Electric Co., Chicago.
- Enamels.**  
 Acme White Lead & Color Works, Detroit, Mich.  
 St. Louis Surfacter & Paint Co., St. Louis, Mo.
- Engine Apparatus.**  
 Green Fuel Economizer Co., Matteawan, N. Y.
- Engineers and Contractors.**  
 Arnold Company, Chicago.  
 Bylesby, H. M., & Co., Chgo.  
 Columbia Construction Co., Milwaukee, Wis.  
 Ford, Bacon & Davis, New York.  
 Register, A. L., & Co., Philadelphia.  
 Roberts & Abbott Co., Cleveland, O.  
 Sanderson & Porter, New York.  
 Saxton, E., Washington, D. C.  
 Sheaff & Jaastad, Boston.  
 Stone & Webster Eng. Corporation, Boston.  
 White, J. G., & Co., New York.
- Engines, Gas and Oil.**  
 Buckeye Engine Co., Salem, O.  
 Fairbanks, Morse & Co., Chgo.  
 Westinghouse Machine Co., Pittsburg.
- Engines, Hoisting.**  
 Fairbanks, Morse & Co., Chgo.
- Engines, Steam.**  
 Buckeye Engine Co., Salem, O.  
 Rossler, MacGovern & Co., 17 Battery Pl., New York.  
 Westinghouse Machine Co., Pittsburg.
- Fans, Exhaust and Ventilating.**  
 General Electric Co., Schenectady, N. Y.  
 Green Fuel Economizer Co., Matteawan, N. Y.  
 Western Electric Co., Chicago.  
 Westinghouse Elec. & Mfg. Co., Pittsburg.
- Fare Boxes—(See Electric Railway Supplies).**
- Fare Registers and Register Fittings.**  
 Electric Service Supplies Co., 200 Plymouth Bldg., Chicago.  
 Recording Fare Register Co., New Haven, Conn.  
 Rooke Automatic Register Co., Providence, R. I.
- Feedwater Apparatus.**  
 Green Fuel Economizer Co., Matteawan, N. Y.  
 Wheeler Condenser & Eng'g Co., New York.
- Feed Wire—(See Wire and Cables).**
- Fenders and Guards.**  
 Consolidated Car Fender Co., Providence, R. I.  
 Eclipse Railway Supply Co., Cleveland, O.  
 Electric Service Supplies Co., 109-24 Fifth St., Philadelphia.  
 McGuire-Cummings Mfg. Co., Chicago.  
 Marshall, R. W., & Co., 95 Liberty St., New York.
- Flangers, Snow.**  
 McGuire-Cummings Mfg. Co., Chicago.  
 Ohio Brass Co., Mansfield, O.  
 Kalamazoo Railway Supply Co., Kalamazoo, Mich.  
 Van Dorn & Dutton Co., Cleveland, O.
- Frogs—(See Switches, Frogs and Crossings).**
- Fuel Economizers—(See Economizers, Fuel).**
- Fuses and Fuse Devices.**  
 Chase-Shawmut Co., Newburyport, Mass.
- Fuses and Fuse Devices—Continued.**  
 Electric Service Supplies Co., 200 Plymouth Bldg., Chicago.  
 General Electric Co., Schenectady, N. Y.  
 Johns-Manville, H. W., Co., New York.  
 Western Electric Co., Chicago.  
 Westinghouse Elec. & Manufacturing Co., Pittsburg.
- Gaskets, Bronze.**  
 Power Specialty Co., 111 Broadway, New York.
- Gates and Guards.**  
 Biles, R., Mfg. Co., Pawtucket, R. I.  
 Kalamazoo Railway Supply Co., Kalamazoo, Mich.
- Gear Cases.**  
 Electric Service Supplies Co., 200 Plymouth Bldg., Chicago.  
 General Electric Co., Schenectady, N. Y.  
 Marshall, R. W., & Co., 95 Liberty St., New York.
- Gears and Pinions.**  
 Electric Service Supplies Co., 200 Plymouth Bldg., Chicago.  
 General Electric Co., Schenectady, N. Y.  
 Marshall, R. W., & Co., 95 Liberty St., New York.  
 Nuttall, R. D., Co., Pittsburg.  
 Van Dorn & Dutton Co., Cleveland, O.
- Generators—(See Dynamos).**
- Gongs—(See Bells and Gongs).**
- Graphite.**  
 Detroit Graphite Co., Detroit, Mich.  
 U. S. Graphite Co., Saginaw, Mich.
- Graphite Paint—(See Paint).**
- Grates, Chain.**  
 Green Engineering Co., Com'l Nat. Bk. Bldg., Chicago.
- Grease—(See Lubricants).**
- Grinders.**  
 Brown, Harold P., 120 Liberty St., New York.
- Guy Anchors—(See Anchors).**
- Harps, Trolley—(See Trolley Poles and Fittings).**
- Headlights.**  
 Electric Service Supplies Co., 200 Plymouth Bldg., Chicago.  
 Fairbanks, Morse & Co., Chgo.  
 General Electric Co., Schenectady, N. Y.  
 Riddion, Frank Co., 200 Summer St., Boston.  
 St. Louis Car Co., St. Louis, Mo.  
 Stuart-Howland Co., Boston.  
 Trolley Supply Co., Canton, O.
- Headlinings, Passenger Car.**  
 Indestructible Fibre Co., 45 Broadway, New York.
- Heaters, Car, Electric.**  
 Consolidated Car-Heating Co., Albany, N. Y.  
 Johns-Manville, H. W., Co., New York.
- Heaters, Car, Hot Water, and Stoves.**  
 Baker, The Wm. C. Heating & Sup. Co., New York.  
 Cooper Heater Co., The, Dayton, O.  
 Electric Service Supplies Co., 109-24 Fifth St., Philadelphia.  
 McGuire-Cummings Mfg. Co., Chicago.  
 Smith, Peter, Heater Co., Detroit, Mich.
- Heating and Ventilating Apparatus—(See Mech. Draft).**
- Hoists—(See Cranes, Hoists and Lifts).**
- Hose Bridges.**  
 Ohio Brass Co., Mansfield, O.
- Hydraulic Machinery.**  
 Watson-Stillman Co., 26 Cortlandt St., New York.
- Inspection.**  
 Central Inspection Bureau.
- Inspection Cars, Gasoline.**  
 Stover Motor Car Co., Freeport, Ill.
- Instruments, Measuring and Testing—(See Electrical Instruments).**
- Insulating Tapes.**  
 General Electric Co., Schenectady, N. Y.  
 Harrison Elec. & Mfg. Co., 169 South St., New York.  
 Johns-Manville, H. W., Co., New York, N. Y.  
 Massachusetts Chemical Co., Walpole, Mass.  
 Okonite Co., Ltd., 253 Broadway, New York.  
 Western Electric Co., Chicago.
- Insulations and Insulating Material.**  
 Anderson, A. & J. M., Mfg. Co., Boston.  
 Craghead Engineering Co., Cincinnati, O.  
 Electric Railway Equipment Co., Cincinnati, O.  
 Electric Service Supplies Co., 200 Plymouth Bldg., Chicago.  
 General Electric Co., Schenectady, N. Y.  
 Johns-Manville, H. W., Co., New York.  
 Macallen, The, Co., Boston.  
 Massachusetts Chemical Co., Walpole, Mass.  
 Ohio Brass Co., Mansfield, O.  
 Okonite Co., Ltd., 253 Broadway, New York.  
 Riddion, Frank Co., 200 Summer St., Boston.  
 Standard Paint Co., 160 William St., New York.  
 Standard Varnish Works, New York.  
 Stuart-Howland Co., Boston.  
 Western Electric Co., Chicago.
- Jacks.**  
 American Car Co., St. Louis.  
 Brill, The J. G., Co., Philadelphia.  
 Electric Service Supplies Co., 200 Plymouth Bldg., Chicago.  
 Fairbanks, Morse & Co., Chgo.  
 Kalamazoo Railway Supply Co., Kalamazoo, Mich.  
 Kuhlman, The G. C., Car Co., Cleveland.  
 Marshall, R. W., & Co., 95 Liberty St., New York.  
 Morden Frog & Crossing Co., Chicago.  
 Stephenson, John, Co., Elizabeth, N. J.  
 Wason Mfg. Co., Springfield, Mass.  
 Watson-Stillman Co., 26 Cortlandt St., New York.
- Joints, Expansion—(See Steam Fittings).**
- Joints, Rail.**  
 Goldschmidt Thermit Co., 43 Exchange Pl., New York.  
 Rail Joint Co., 29 W. 34th St., New York.
- Joints, Welded—(See Rail Joints, Welded).**
- Journal Boxes.**  
 American Car Co., St. Louis.  
 Brill, The J. G., Co., Philadelphia.  
 Kuhlman, The G. C., Car Co., Cleveland.  
 McGuire-Cummings Mfg. Co., Chicago.  
 St. Louis Car Co., St. Louis, Mo.  
 Stephenson, John, Co., Elizabeth, N. J.  
 Symington, T. H., Co., Baltimore, Md.  
 Wason Mfg. Co., Springfield, Mass.
- Journal Lubricators—(See Lubricants).**
- Journal Packing, Steel Wool.**  
 Robertson, Wm., & Co., Fifth Floor Great Northern Bldg., Chicago.
- Lamps, Arc and Incandescent.**  
 Anderson, A. & J. M., Mfg. Co., Boston.  
 Electric Service Supplies Co., 200 Plymouth Bldg., Chicago.  
 General Electric Co., Schenectady, N. Y.  
 Riddion, Frank Co., 200 Summer St., Boston.  
 Stuart-Howland Co., Boston.  
 Western Electric Co., Chicago.  
 Westinghouse Electric & Mfg. Co., Pittsburg, Pa.
- Lamp Sockets.**  
 Electric Service Supplies Co., 200 Plymouth Bldg., Chicago.  
 General Electric Co., Schenectady, N. Y.  
 Johns-Manville, H. W., Co., New York, N. Y.
- Lantern Globes.**  
 Railway Specialty & Supply Co., Chicago.
- Lifts—(See Cranes, Hoist and Lift).**
- Lightning Arresters.**  
 Electric Service Supplies Co., 200 Plymouth Bldg., Chicago.  
 General Electric Co., Schenectady, N. Y.  
 Stuart-Howland Co., Boston.  
 Western Electric Co., Chicago.  
 Westinghouse Elec. & Manufacturing Co., Pittsburg.
- Line Material.**  
 Anderson, A. & J. M., Mfg. Co., Boston.  
 Craghead Engineering Co., Cincinnati, O.  
 Johns-Manville, H. W., Co., New York.  
 Electric Ry. Equipment Co., Cincinnati, O.  
 Electric Service Supplies Co., 200 Plymouth Bldg., Chicago.  
 General Electric Co., Schenectady, N. Y.  
 Macallen, The, Co., Boston.  
 Marshall, R. W., & Co., 95 Liberty St., New York.  
 Recording Fare Register Co., New Haven, Conn.  
 Stuart-Howland Co., Boston.  
 Western Electric Co., Chicago.
- Lock and Nut Washers.**  
 Grip Nut Co., 152 Lake St., Chicago.  
 National Lock Washer Co., Newark, N. J.
- Lockers, Metal.**  
 Electric Service Supplies Co., 200 Plymouth Bldg., Chicago.
- Locomotives.**  
 Baldwin Locomotive Works, Philadelphia.  
 Johann, F. A., 1624 Pierce Bldg., St. Louis.
- Locomotives, Electric.**  
 American Car Co., St. Louis.  
 Baldwin Locomotive Works, Philadelphia.  
 Brill, The J. G., Co., Philadelphia.  
 General Electric Co., Schenectady, N. Y.  
 Kuhlman, The G. C., Car Co., Cleveland.  
 McGuire-Cummings Mfg. Co., Chicago.  
 Stephenson, John, Co., Elizabeth, N. J.  
 Wason Mfg. Co., Springfield, Mass.  
 Westinghouse Elec. & Manufacturing Co., Pittsburg.
- Locomotives, Gasoline.**  
 Fairbanks, Morse & Co., Chgo.  
 Stover Motor Car Co., Freeport, Ill.
- Lubricants.**  
 Dearborn Drug & Chemical Works, Chicago.  
 Detroit Graphite Co., Detroit, Mich.  
 Galena-Signal Oil Co., Franklin, Pa.  
 U. S. Graphite Co., Saginaw, Mich.  
 Whitmore Mfg. Co., Cleveland, O.
- Lumber.**  
 Barnes, G. H., Hardwood Lumber Co., St. Louis, Mo.  
 Wagoner, Francis, & Co., Chgo.  
 Bertlow & Jennings, St. Louis.  
 Lindsay Bros. Co., Spokane, Wash.  
 S-B, Missouri Cypress Co., Campbell, Mo.
- Malleable Iron.**  
 St. Louis Car Co., St. Louis, Mo.
- Measuring Tapes.**  
 Lufkin Rule Co., Saginaw, Mich.
- Mechanical Draft.**  
 Green Fuel Economizer Co., Matteawan, N. Y.
- Meters.**  
 Johns-Manville, H. W., Co., New York.  
 Queen & Co., Philadelphia.  
 Weston Electrical Instrument Co., Newark, N. J.



## Passengers Alight from the Front End of PAY-AS-YOU-ENTER CARS

and the door is under sole control of the motorman. When a stop is made, he throws a lever and the door slides open. Before starting, he releases the lever and the door closes. ¶ Confusion between passengers alighting and those entering is entirely eliminated, as they use separate doors. The time required for loading and unloading is materially cut down, too. ¶ Accidents resulting from attempts to board the front platform while car is in motion and those caused by starting while passengers are in the act of entering or leaving are also eliminated. ¶ And the company gets every passenger's fare before the car is entered.

We license manufacturers and railways to build and use the  
Pay-As-You-Enter Car, the patents on which are owned by

## The Pay-As-You-Enter Car Company

DUNCAN McDONALD  
President

26 Cortlandt Street, New York

THOS. W. CASEY  
Manager

## CLASSIFIED LIST OF ADVERTISERS—Continued.

- Molded Goods.**  
Massachusetts Chemical Co., Walpole, Mass.  
Wood, G. S., Great Northern Bldg., Chicago.
- Motor Cars, Gasoline.**  
Stover Motor Car Co., Freeport, Ill.
- Motors, Electric.**  
Cleveland Armature Works, Cleveland, O.  
Fairbanks, Morse & Co., Chgo. General Electric Co., Schenectady, N. Y.  
National Brake & Electric Co., Milwaukee.  
Rossiter, MacGovern & Co., 17 Battery Pl., New York.  
Western Electric Co., Chicago.  
Westinghouse Elec. & Manufacturing Co., Pittsburg.
- Nut Locks.**  
Grip Nut Co., 152 Laka St., Chicago.  
National Lock Washer Co., Newark, N. J.  
Railway Speciality & Supply Co., Chicago.  
St. Louis Car Co., St. Louis, Mo.  
U. S. Metal & Mfg. Co., 25 Broad St., New York.
- Nuts and Bolts.**  
Grip Nut Co., 152 Lake St., Chicago.  
Lorain Steel Co., Philadelphia.  
National Lock Washer Co., Newark, N. J.  
Railway Speciality & Supply Co., Chicago.
- Oilers.**  
Armstrong Oiler Co., 31st and Chestnut St., Philadelphia.
- Oils—(See Lubricants).**
- Overhead Equipment—(See Electric Railway Supplies).**
- Packings.**  
Electric Service Supplies Co., 200 Plymouth Bldg., Chicago.  
Johns-Manville, H. W., Co., New York.  
Power Speciality Co., 111 Broadway, New York.
- Packing, Steel Wool Journal.**  
Robertson, Wm., & Co., Fifth Floor Great Northern Bldg., Chicago.
- Paints.**  
Detroit Graphite Co., Detroit, Mass.  
Massachusetts Chemical Co., Walpole, Mass.  
Standard Paint Co., 100 William St., New York.  
St. Louis Surfacor & Paint Co., St. Louis, Mo.  
U. S. Graphite Co., Saginaw, Mich.
- Pay-As-You-Enter Cars.**  
Pay-As-You-Enter Car Co., 26 Cortlandt St., New York.
- Pipe Bends and Fittings—(See Steam Fittings).**
- Plumbago.**  
Detroit Graphite Co., Detroit, Mich.  
U. S. Graphite Co., Saginaw, Mich.
- Poles, Metal.**  
Creaghead Engineering Co., Cincinnati, O.  
Electric Railway Equipment Co., Cincinnati, O.  
Electric Service Supplies Co., 200 Plymouth Bldg., Chicago.
- Poles and Ties, Wood.**  
Advances Lumber Co., Cleveland, O.  
Barnes, G. H., Hardwood Lumber Co., St. Louis, Mo.  
Beldier, Francis, & Co., Chgo.  
Berthold & Jennings, St. Louis.  
Churchill Cedar Co., Spokane, Wash.  
Humbird Lumber Co., Sand Point, Idaho.  
Lindsay Bros. Co., Spokane, Wash.  
National Pole Co., Escanaba, Mich.  
Naugie Pole & Tie Co., 226 La Salle St., Chicago.  
Pacific Coast Pole Co., Spokane, Wash.  
S-E. Missouri Cypress Co., Campbell, Mo.  
Worcester, C. H., Co., Tribune Bldg., Chicago.
- Promoters of Railway Projects.**  
Shiner & Chase Co., Omaha, Neb.
- Punches—(See Ticket Punches).**
- Rail Benders.**  
Electric Service Supplies Co., 200 Plymouth Bldg., Chicago.  
Fairbanks, Morse & Co., Chgo.
- Rail Bonds—(See Bonds, Rail).**
- Rail Drills—(See Drills, Track).**
- Rail Feed Wire—(See Wire and Cables).**
- Rail Joints and Chairs—(See Joints, Rail).**
- Rail Joints, Welded.**  
Goldschmidt Thermit Co., 43 Exchange Pl., New York.  
Lorain Steel Co., Philadelphia.
- Rails, New.**  
Lorain Steel Co., Philadelphia.  
New York Switch & Crossing Co., Hoboken, N. J.  
Wharton, Wm., Jr., & Co., Philadelphia.
- Rails, Relaying.**  
Zelicker, Walter A., Supply Co., St. Louis.
- Railway Equipment.**  
Johns-Manville, H. W., Co., 1624 Pierce Bldg., St. Louis.
- Railway Velocipedes.**  
Fairbanks Morse & Co., Chgo.  
Kalamazoo Railway Supply Co., Kalamazoo, Mich.
- Registers and Fittings—(See Fare Registers).**
- Relays.**  
Western Electrical Instrument Co., Newark, N. J.
- Roofing.**  
Johns-Manville, H. W., Co., New York.
- Rubber Goods, Mechanical.**  
Wood, G. S., Great Northern Bldg., Chicago.
- Rubber Preservative.**  
Wood, G. S., Great Northern Bldg., Chicago.
- Sand Apparatus.**  
American Car Co., St. Louis.  
Brill, The J. G., Co., Philadelphia.  
Electric Service Supplies Co., 200 Plymouth Bldg., Chicago.  
Kuhlman, The G. C., Car Co., Cleveland.  
Marshall, R. W., & Co., 95 Liberty St., New York.  
Ohio Brass Co., Mansfield, O.  
Ridion, Frank Co., 200 Summer St., Boston.  
St. Louis Car Co., St. Louis, Mo.  
Stephenson, John, Co., Elizabeth, N. J.  
Wason Mfg. Co., Springfield, Mass.
- Sash Balances and Fixtures.**  
National Lock Washer Co., Newark, N. J.
- Sash Operating Devices.**  
Drouvé, The G. Co., Bridgeport, Conn.  
Lord & Burnham, Irvington-on-Hudson, New York.
- Seats, Car—(See Car Seats).**
- Shade Rollers—(See Curtains, Fixtures and Materials).**
- Shutters, Steel Rolling.**  
Kinners Manufacturing Co., Columbus, O.
- Signals.**  
Blake Signal & Manufacturing Co., Boston.  
Telegraph Signal Co., Rochester, N. Y.
- Signal Supplies.**  
Railway Speciality & Supply Co., Chicago.
- Skylights.**  
Drouvé, The G. Co., Bridgeport, Conn.  
Lord & Burnham, Irvington-on-Hudson, New York.
- Snow Plows, Sweepers and Scrapers.**  
American Car Co., St. Louis.  
Brill, The J. G., Co., Philadelphia.  
Kalamazoo Railway Supply Co., Kalamazoo, Mich.  
Kuhlman, The G. C., Car Co., Cleveland.
- Snow Plows, Sweepers and Scrapers—Continued.**  
McGuire-Cummings Mfg. Co., Chicago.  
Russell Car & Snow-Plow Co., Ridgway, Pa.  
Stephenson, John, Co., Elizabeth, N. J.  
Wason Mfg. Co., Springfield, Mass.
- Sockets, Waterproof.**  
Johns-Manville, H. W., Co., New York.
- Splicing Compounds and Materials.**  
Massachusetts Chemical Co., Walpole, Mass.
- Springs.**  
American Car Co., St. Louis.  
Brill, The J. G., Co., Philadelphia.  
Kuhlman, The G. C., Car Co., Cleveland.  
McGuire-Cummings Mfg. Co., Chicago.  
Marshall, R. W., & Co., 95 Liberty St., New York.  
Railway Steel Spring Co., 71 Broadway, New York.  
St. Louis Car Co., St. Louis, Mo.  
Stephenson, John, Co., Elizabeth, N. J.  
Wason Mfg. Co., Springfield, Mass.
- Sprinkling Cars.**  
American Car Co., St. Louis.  
Brill, The J. G., Co., Philadelphia.  
Kuhlman, The G. C., Car Co., Cleveland.  
McGuire-Cummings Mfg. Co., Chicago.  
Stephenson, John, Co., Elizabeth, N. J.  
Wason Mfg. Co., Springfield, Mass.
- Steam Apparatus.**  
Green Fuel Economizer Co., Matteawan, N. Y.
- Steam Fittings, Etc.**  
Crane Co., Chicago.  
Davis, The John, Co., Chgo.  
Simmons, John, Co., 110 Centre St., New York.  
Power Speciality Co., 111 Broadway, New York.
- Steel Cars.**  
American Car Co., St. Louis.  
Brill, The J. G., Co., Philadelphia.  
Kuhlman, The G. C., Car Co., Cleveland.  
St. Louis Car Co., St. Louis, Mo.  
Stephenson, John, Co., Elizabeth, N. J.  
Wason Mfg. Co., Springfield, Mass.
- Steel Tapes.**  
Lufkin Rule Co., Saginaw, Mich.
- Stokers.**  
Babcock & Wilcox Co., 85 Liberty St., New York.  
Green Engineering Co., Com'l Nat. Bk. Bldg., Chicago.  
Model Stoker Co., Dayton, O.  
Under-Feed Stoker Co. of Am., Chicago.  
Westinghouse Machine Co., Pittsburg.
- Storage Batteries—(See Batteries).**
- "Strike-Breakers."**  
Drummond Detective Agency, 3 Ann St., New York.
- Superheaters.**  
Power Speciality Co., 111 Broadway, New York.
- Switches, Frogs and Crossings.**  
American Frog & Switch Co., Cincinnati, O.  
Barbour-Stockwell Co., Cambridgeport, Mass.  
Cincinnati Frog & Switch Co., Cincinnati, O.  
Cleveland Frog & Crossing Co., Cleveland, O.  
Fairbanks, Morse & Co., Chgo.  
Lorain Steel Co., Philadelphia.  
Morden Frog & Crossing Co., Rookery, Chicago.  
New York Switch & Crossing Co., Hoboken, N. J.
- Switches, Frogs and Crossings—Continued.**  
Railway Speciality & Supply Co., Chicago.  
Wharton, Wm., Jr., & Co., Philadelphia.
- Switchboards and Switchboard Instruments.**  
Anderson, A. & J. M., Mfg. Co., Boston.  
Chase-Shawmut Co., Newburyport, Mass.  
General Electric Co., Schenectady, N. Y.  
Western Electric Co., Chicago.  
Westinghouse Electric & Mfg. Co., Pittsburg.  
Weston Electrical Instrument Co., Newark, N. J.
- Tapes and Webbing.**  
Hope Webbing Co., Providence, R. I.  
Johns-Manville, H. W., Co., New York.  
Massachusetts Chemical Co., Walpole, Mass.  
Okon, J. G., 253 Broadway, New York.
- Testing Instruments.**  
Chicago Co., Philadelphia.  
Weston Electrical Instrument Co., Newark, N. J.
- Ticket Choppers and Destroyers.**  
Patten, Paul B., Salem, Mass.
- Ticket Punches.**  
Meyers, Fred J., Mfg. Co., Hamilton, O.  
Woodman Mfg. & Sup. Co., Boston.
- Ties and Poles, Wood—(See Poles and Ties).**
- Timber.**  
Beldier, Francis, & Co., Chgo.  
Lindsay Bros. Co., Spokane, Wash.  
S-E. Missouri Cypress Co., Campbell, Mo.
- Tools, Pneumatic—(See Pneumatic Tools).**
- Track Cleaners and Scrapers.**  
American Car Co., St. Louis.  
Brill, The J. G., Co., Philadelphia.  
Kalamazoo Railway Supply Co., Kalamazoo, Mich.  
Kuhlman, The G. C., Car Co., Cleveland.  
McGuire-Cummings Mfg. Co., Chicago.  
Marshall, R. W., & Co., 95 Liberty St., New York.  
Ohio Brass Co., Mansfield, O.  
Stephenson, John, Co., Elizabeth, N. J.  
Van Dorn & Dutton Co., Cleveland, O.  
Wason Mfg. Co., Springfield, Mass.
- Track Drills—(See Drills, Track).**
- Tracklaying Machinery.**  
Holman, D. F., Ry. Tracklayer Co., 1102 Ellsworth Bldg., Chicago.
- Track Tools.**  
Electric Service Supplies Co., 200 Plymouth Bldg., Chicago.  
Kalamazoo Railway Supply Co., Kalamazoo, Mich.
- Trimmings, Car.**  
American Car Co., St. Louis.  
Brill, The J. G., Co., Philadelphia.  
Curtain Supply Co., Park Row Bldg., New York.  
Kuhlman, The G. C., Car Co., Cleveland.  
National Lock Washer Co., Newark, N. J.  
St. Louis Car Co., St. Louis, Mo.  
Stephenson, John, Co., Elizabeth, N. J.  
Wallace Supply Co., Chicago.  
Wason Mfg. Co., Springfield, Mass.  
Wood, G. S., Great Northern Bldg., Chicago.
- Trolley Guards.**  
Electric Service Supplies Co., 200 Plymouth Bldg., Chicago.
- Trolley Poles and Fittings.**  
General Electric Co., Schenectady, N. Y.  
Johns-Manville, H. W., Co., New York.  
Marshall, R. W., & Co., 95 Liberty St., New York.

# Steel Wool Journal Packing

is Worth a Fair Test!

Three  
pounds  
com-  
pressed

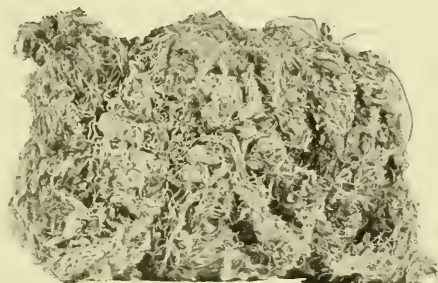

About  
one-third  
actual  
size

It possesses these great advantages:

- saves one-half the packing
- saves one-third the oil
- saves labor and wear
- prevents hot boxes positively.

Don't condemn, argue, infer or disbelieve—but test it to your own satisfaction. A sample for this purpose is yours for the asking.

## William Robertson & Co.

General Office: Fifth Floor Great Northern Bldg., Chicago  
Factory: 75 South Jefferson Street, Battle Creek, Mich.

## CLASSIFIED LIST OF ADVERTISERS—Continued.

- Trolley Retrievers and Catchers.**  
Earl, C. L., Bowling Green Bldg., New York.  
Electric Service Supplies Co., 1020-24 Filbert St., Phila.  
Milloy Electric Co., Bucyrus, O.  
Ridlon, Frank, Co., 200 Summer St., Boston.  
Trolley Supply Co., Canton, O.
- Trolley Wagons.**  
Kalamazoo Railway Supply Co., Kalamazoo, Mich.
- Trolley Wheels—(See Trolley Poles and Fittings).**
- Trolley Wire—(See Wire and Cables).**
- Trolleys, Track.**  
Cleveland Armature Works, Cleveland, O.
- Trucks, Car.**  
American Car Co., St. Louis.  
Baldwin Locomotive Works, Philadelphia.  
Brill, The J. G., Co., Philadelphia.  
Kuhlman, The G. C., Car Co., Cleveland.  
McGuire-Cummings Mfg. Co., Chicago.  
St. Louis Car Co., St. Louis, Mo.  
Standard Motor Truck Co., Pittsburg, Pa.  
Standard Varnish Works, New York City.  
Stephenson, John, Co., Elizabeth, N. J.
- Trucks, Car—Continued.**  
Van Dorn & Dutton Co., Cleveland, O.  
Wason Mfg. Co., Springfield, Mass.
- Turbines.**  
General Electric Co., Schenectady, N. Y.  
Westinghouse Machine Co., Pittsburg, Pa.
- Valves—(See Steam Fittings).**
- Varnish.**  
Electric Service Supplies Co., 200 Plymouth Bldg., Chicago.  
Harrison Elec. & Mfg. Co., 169 South St., New York.  
Marshall, R. W., & Co., 95 Liberty St., New York.  
Massachusetts Chemical Co., Walpole, Mass.  
Milloy Electric Co., Bucyrus, O.  
Nuttall, R. D., Co., Pittsburg, Rldon, Frank, Co., 200 Summer St., Boston.  
Standard Paint Co., 100 William St., New York.  
Star Brass Works, Kalamazoo, Mich.  
Trolley Supply Co., Canton, O.  
Wallace Supply Co., Chicago.  
Westinghouse Electric & Mfg. Co., Pittsburg, Pa.
- Ventilators.**  
Drouvé, The G., Co., Bridgeport, Conn.  
Lord & Burnham, Irvington-Hudson, New York.
- Vestlettes.**  
Bellamy Vestlette Mfg. Co., Cleveland, O.
- Waste, Cotton and Wool.**  
Hagy, J. Milton, Waste Wks., Philadelphia, Pa.  
Railway Specialty & Supply Co., Chicago.
- Water Softening Apparatus.**  
Dearborn Drug & Chemical Works, Chicago.
- Wheels and Axles.**  
American Car Co., St. Louis.  
Brill, The J. G., Co., Philadelphia.  
Griffin Wheel Co., Chicago.  
Kuhlman, The G. C., Car Co., Cleveland.  
Lorain Steel Co., Philadelphia.  
McGuire-Cummings Mfg. Co., Chicago.  
Marshall, R. W., & Co., 95 Liberty St., New York.  
Railway Steel-Spring Co., New York.  
St. Louis Car Co., St. Louis, Mo.  
St. Louis Car Wheel Co., St. Louis.  
Standard Steel Works, Philadelphia.  
Stephenson, John, Co., Elizabeth, N. J.  
Wason Mfg. Co., Springfield, Mass.
- Wheel Grinders.**  
Wheel Truing Brake Shoe Co., Detroit, Mich.
- Whitewashing Machines.**  
Wallace Supply Co., Chicago.
- Window Fixtures.**  
Drouvé, The G., Co., Bridgeport, Conn.
- Wiping Rags.**  
Hagy, J. Milton, Waste Wks., Philadelphia, Pa.
- Wire, Aluminum.**  
Aluminum Co. of America, Pittsburg, Pa.
- Wire, Insulated.**  
Aluminum Co. of America, Pittsburg, Pa.  
American Electrical Works, Providence, R. I.  
General Electric Co., Schenectady, N. Y.  
Okonite Co., Ltd., 253 Broadway, New York.  
Standard Underground Cable Co., Pittsburg, Pa.  
Stuart-Howland Co., Boston.
- Wire and Cables.**  
Aluminum Co. of America, Pittsburg, Pa.  
American Electrical Works, Providence, R. I.  
Bridgeport Brass Co., Bridgeport, Conn.  
General Electric Co., Schenectady, N. Y.  
Okonite Co., Ltd., 253 Broadway, New York.  
Standard Underground Cable Co., Pittsburg, Pa.

**Coach and Car (Metal) Surfacer**

Elastic — Durable — Economical

**ST. LOUIS SURFACER  
& PAINT COMPANY**  
St. Louis, U. S. A.

8

**Fire Extinguishers  
Fire Hose Carts and Reels**
**GUILFORD S. WOOD**
ELECTRIC RAILWAY  
NECESSITIES

Great Northern Bldg., Chicago 2

**Your Wife Will Laugh**

if you tell her that you purchase electric tape by the pound. When she goes shopping, yardage and quality direct her. Our No. 264 ELECTRIC TAPE

is the *highest quality obtainable* and the greatest yardage per pound. *But don't lose sight of the yardage.*

Your jobber will supply you if you insist.

*Write for quotations.*

**MASSACHUSETTS CHEMICAL COMPANY**

 Operates  
Walpole Varnish Works  
Walpole Rubber Works

**PLANT: WALPOLE, MASS.**
**Motor Packing Waste**

It is free from dirt and grit, holds the oil better and is easier to pack than ordinary waste.

One packing of the journal box will last longer than with other waste. Used by leading traction companies and electric motor manufacturers.

All grades of white and colored wiping waste, also sanitary cleaned wiping rags. Samples submitted.

**The J. Milton Hagy Waste Works**

433 Spruce St.

INCORPORATED

Philadelphia 2

**THE BABCOCK & WILCOX COMPANY**

85 Liberty Street, New York

Babcock &amp; Wilcox — Stirling — A &amp; T Horizontal — Cahall Vertical

**WATER TUBE STEAM BOILERS**
**STEAM SUPERHEATERS**

Works: Bayonne, N. J. Barberton, Ohio.

**MECHANICAL STOKERS**

BRANCH OFFICES:

 BOSTON, Delta Bldg.  
PHILADELPHIA, 1110-1112 North American Bldg.  
SAN FRANCISCO, 63 First Street  
PITTSBURGH, Farmers Deposit Nat. Bank Bldg.  
NEW ORLEANS, 343 Beronne St.

 DENVER, 410 Seventeenth St.  
SALT LAKE CITY, 313 Atlas Block  
WASHINGTON, Colorado Building  
CHICAGO, Marquette Bldg.  
ATLANTA, GA., 1132 Candler Bldg.

 CLEVELAND, 705 New England Bldg.  
MEXICO CITY, 7 Avenida, Juarez  
HAVANA, CUBA, 116 1/2 Calle de la Habana  
LOS ANGELES, 321 Truett Bldg.  
CINCINNATI, O., Traction Bldg.





TRADE MARK  
Registered U. S. Patent Office

# The Standard for Rubber Insulation

RAILWAY FEED WIRES insulated with OKONITE are unequalled for flexibility, durability and efficiency, and are in use by the leading Electric Street Railway Companies. OKONITE is preferred above any other insulation for Car Wiring, Telegraph and Telephone Purposes

**Okonite Wires, Okonite Tape, Manson Tape, Candee Weatherproof Wires**

SAMPLES AND ESTIMATES ON APPLICATION

## THE OKONITE Co., Ltd.,

WILLARD L. CANDEE, H. DURANT CHEEVER, Managers.  
GEORGE T. MANSON, Gen'l Supt.; W. H. HODGINS, Secretary.

253 Broadway, NEW YORK

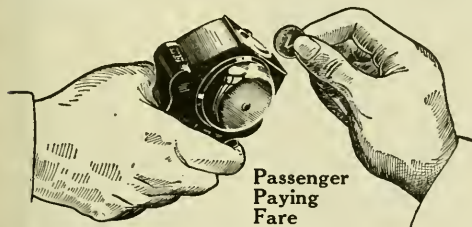

# Rooke Automatic Fare Collector

Every nickel collected is registered before reaching the conductor's hand when you use the

The Rooke System is a revolution in fare-collecting methods, and as far superior to old systems as the trolley car is to the horse car.

Why not ask us to prove it?

**Rooke Automatic Register Co.**  
PROVIDENCE RHODE ISLAND

# TUBULAR POLES IRON OR STEEL



FOR  
ELECTRIC RAILWAYS  
ELECTRIC LIGHTING CO'S  
SIGNAL }  
TELEPHONE } SER-  
TELEGRAPH } VICE

TRANSMISSION  
LINE }  
AND  
CATENARY  
SUSPENSION  
LINE }

**ELECTRIC RAILWAY EQUIPMENT CO.**  
General Office: CINCINNATI-O-U-S-A  
Shops: READING PA - WHEELING WVA

# Standard "High Speed Interurban" Double Truck

Types C-60 and C-60-A, "Solid Forged", Without Welds

STANDARD HIGH SPEED INTERURBAN  
DOUBLE TRUCK,  
TYPE C-60-A

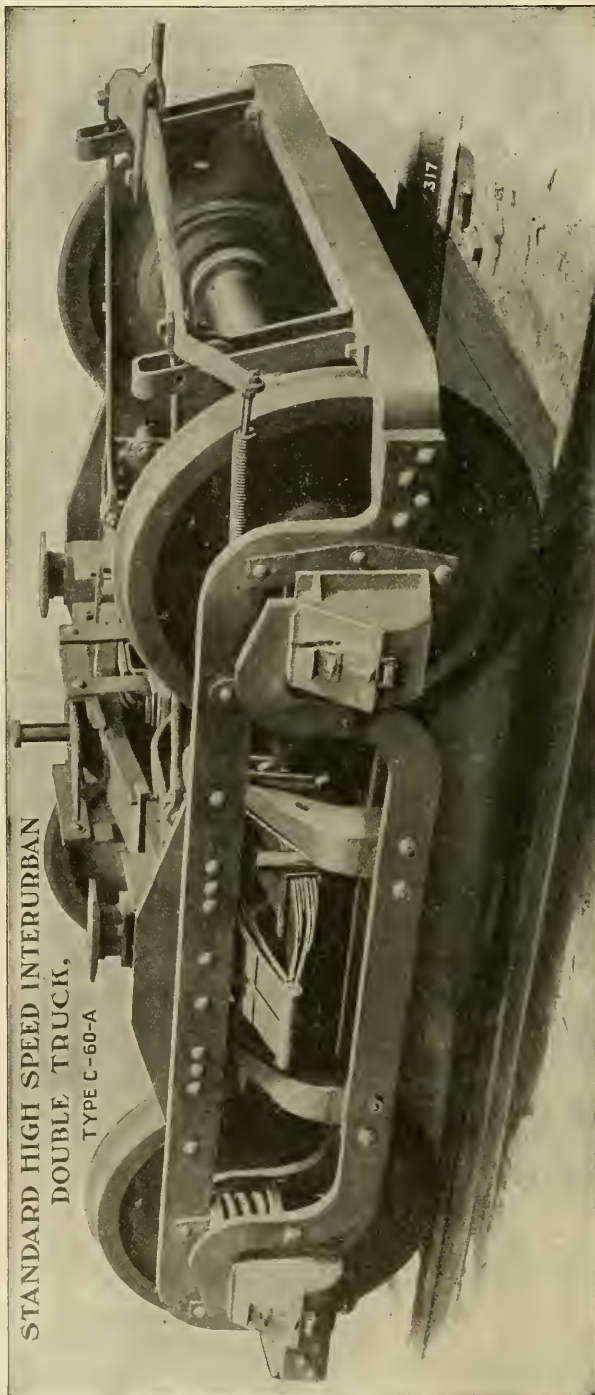

Our new plant is equipped with the most modern truck building machinery and the very best quality of material and workmanship is used in the manufacture of these trucks. M. C. B. standard principles are followed. Frames are made from rolled open hearth steel without welds. We are prepared to build trucks in accordance with purchaser's designs and specifications.

**Standard Motor Truck Company, Frick Bldg., Pittsburg, Pa.**

New York Office: 170 Broadway

Works: New Castle, Pa.

Chicago Office: Fisher Bldg.

# FOR SALE. FOR QUICK DELIVERY

## 6 55-ft. Passenger, Baggage and Smoking Car Bodies

Main Compartment 26' 0"  
 Smoking " 10' 6"  
 Baggage " 10' 0"  
 Seating Capacity, 54

## 8 60-ft. Passenger, Baggage and Smoking Car Bodies

Main Compartment 28' 6"  
 Smoking " 11' 0"  
 Baggage " 8' 0"  
 Seating Capacity, 58

## 5 52-ft. Passenger and Smoking Car Bodies — Double End

Seating Capacity, 60

## 3 52-ft. Passenger and Baggage Car Bodies — Double End

Seating Capacity, 56

## 2 50-ft. Express Car Bodies

*Write or wire us for further information.*

# The Jewett Car Co. Newark Ohio

## THE MIGHTY HOT WATER CAR HEATER MIDGET

Adapted for Large Electric Cars and Long Distance Lines. Exclusively used on Largest Electric Systems. Ask for Catalog

THE WILLIAM C. BAKER HEATING & SUPPLY CO., 143 LIBERTY STREET NEW YORK



## NILES CARS

(The Electric Pullmans)  
 LARGE, FAST INTERURBANS  
 OUR SPECIALTY

### Niles Car & Mfg. Co.

Works: NILES, OHIO  
 Sales Office: J. A. HANNA CO.,  
 312 Electric Bldg., Cleveland, Ohio

## Pantasote

The National Standard for Car Curtains and Car Upholstery.

### AGOSOTE HEADLINING

The only headlining made in one solid piece. Will not separate, warp or blister. Waterproof and homogeneous.

### THE PANTASOTE COMPANY

707 Fisher Building, Chicago, Ill. 11 Broadway, New York

## NATIONAL

Curtain Fixtures  
 Sash Locks Sash Balances  
 and Nut Locks

### COMPLETE CURTAINS

### The National Lock Washer Co.

NEWARK, N. J.  
 CHICAGO OFFICE: 419 Monadnock Block

Specify the Genuine Roller. It is that Element that makes a Car Curtain a Success.

Every Genuine Roller has the Name of Manufacturer



**STEWART HARTSHORN**  
IN SCRIPT ON LABEL

**STEWART HARTSHORN CO.**

Office and Factory, E. NEWARK, N. J.  
NEW YORK, 382 Lafayette St. CHICAGO, 333-344 Wabash Ave.

Special Car Rollers are made. Brackets are made for all classes of fittings.  
Used all over the world wherever cars are run.

# The Lindsley Brothers Company

Producers and Shippers of

and Manufacturers of

**WESTERN CEDAR POLES**

**RED FIR CROSS ARMS**

Eastern Sales Office, Monadnock Bldg., CHICAGO

SPOKANE, WASHINGTON

**G. H. BARNES HARDWOOD LUMBER CO.**

Office and Yard: Main and Warren Sts., ST. LOUIS, MO.

Ties, Car Oak, Poplar, Ash, Cherry, Plain and Quartered Oak

**TRACKLAYING BY MACHINERY**

SIMPLE, RAPID AND ECONOMICAL

D. F. HOLMAN RAILWAY TRACKLAYER CO., 1102 Ellsworth Bldg., Chicago

**C. H. WORCESTER CO.**  
**CEDAR POLES**

PRODUCERS AND WHOLESALE

Suite 1710 Tribune Building

CHICAGO

**Idaho Cedar Poles**

PACIFIC COAST POLE CO.

SPOKANE, WASH.

We have in our Chicago Yard available for RUSH SHIPMENTS a SELECTED STOCK of POLES and TIES

**NAUGLE POLE AND TIE CO.**

Chicago Office, 226 La Salle Street

We are Producers and Wholesale Dealers in Western

**CEDAR POLES**

Yards in Washington, Idaho, Montana and British Columbia

WRITE US FOR DELIVERED PRICES

**CHURCHILL CEDAR CO.,** Box 1409, Spokane, Wash.

**CHESTNUT POLES**

Cedar, Oak and Chestnut Ties

FROM OUR OWN TIMBER LANDS

**THE ADVANCE LUMBER CO.**

CLEVELAND, OHIO

**POLES and PILING**

20,000 35s and 40s

Ready to Ship at Once

**S-E. Missouri Cypress Co.,** Campbell, Mo.

Red **Cedar Poles** White

Prompt deliveries at right prices.

**NATIONAL POLE COMPANY**

EVERETT, WASH.

ESCANABA, MICH.

**VALVES—FITTINGS—STEAM SPECIALTIES**

**CRANE CO.**

CHICAGO

ESTABLISHED 1855



CONTINUOUS JOINT

Over 25,000 miles in use



WEBER JOINT

Rolled from Best Quality Steel

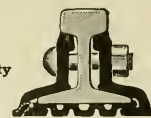

WOLHAUPTER JOINT

Catalogs at Agencies  
Baltimore, Md. Portland, Ore.  
Boston, Mass. Seattle, Wash.  
Chicago, Ill. St. Paul, Minn.  
Denver, Colo. St. Louis, Mo.  
Pittsburg, Pa. Troy, N. Y.  
London, Eng. Montreal, Can.

HIGHEST AWARDS—Paris, 1900;  
Buffalo, 1901; St. Louis, 1904

Additional safety and economy in Track Maintenance has been proved by the use of Continuous, Weber and Wolhaupter base-supported rail joints—after ten (10) years' service, having a record of over 25,000 miles in use—the extent of which is evidence of their excellence.

**THE RAIL JOINT COMPANY**

General Offices: 29 West 34th Street, New York City  
Makers of Rail Joints for Standard and Special Rail Sections, also Girdler, Step or Compromise, and Insulating Rail Joints, protected by patents in United States and Foreign Countries.

# Dearborn Water Purifying Reagents

Increase the efficiency and the years of service of steam boilers by keeping them in good condition internally. Gallon sample of the water required for analysis before preparing treatment.

## Dearborn Drug & Chemical Works

WM. H. EDGAR, FOUNDER

299 BROADWAY, NEW YORK POSTAL TELEGRAPH BLDG., CHICAGO

Established 1877.

**ALBERT & J. M. ANDERSON MFG. CO.,**  
Makers of

**ELECTRICAL APPLIANCES:**  
SWITCHES, SWITCHBOARDS,  
TIME SWITCHES, LINE MATERIAL,  
COPPER CASTINGS (75%) CONDUCTIVITY.  
289-293 A ST., BOSTON, MASS., U. S. A.

Branches: Chicago, 175 Dearborn Street.  
New York, 135 Broadway.

Agencies:  
Boston, Pettingell-Andrews Co. San Francisco, Eccles & Smith Co.  
New York, R. W. Marshall & Co. Atlanta, Newcomer-Manry Co.  
St. Louis, J. C. White. Denver, E. M. Mesailer.  
Toronto, Ont., H. J. Surtees.

## Queen Testing Sets

*"The Recognized Standard"*

Voltmeters  
Ammeters  
Switchboard and Portable  
Alternating and Direct Current



Queen Acme Testing Set

U. S. Standard Testing Sets  
Rail Bond Testers  
Galvanometers, etc., etc.  
Electrical Instruments for All Purposes

**QUEEN & CO., Inc., Philadelphia, Pa.**

One road writes as follows:  
"All doubts that we had in the beginning about the merits of your

## Whitmore's Gear Protective Composition

have been thoroughly removed. The results from the use of this material are far beyond our expectations. You are entitled to great success."

We are in position to do the same thing for you.

**The Whitmore Manufacturing Company**  
CLEVELAND, OHIO, U. S. A.

## WESTON Electrical Instrument Co.

Main Office and Works:  
WAVERLY PARK, NEWARK, N. J.

### Illuminated Dial Station Instruments



SEND FOR NEW CATALOGUE

Berlin—European Weston Electrical Instrument Co., Ritterstrasse, No. 88  
Paris, France—E. H. Cadot, 12 Rue St. Georges  
London—Audrey House, Ely Place, Holborn  
New York Office—74 Cortlandt St.

Weston Standard Illuminated Dial Station Voltmeter Model 11

## GREEN TRAVELING LINK GRATES

Highest Capacity  
Highest Efficiency  
Automatic Smokeless  
Labor Saving  
Cheap Fuel

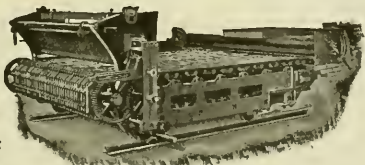

**GREEN ENGINEERING CO.**  
Main Office: Commercial National Bank Bldg., Chicago, Ill.  
BRANCH OFFICES: Pittsburgh : St. Louis : St. Paul : Louisville  
General Foundry Work a Specialty

## TRACK DRILLS

MADE IN TWO SIZES

With automatic friction feed. Lower gears cased in to protect them from dirt.



Send for circular and prices.

**FRANCIS REED CO. WORCESTER, MASS.**

**CAR ADVERTISING**  
*Barron & Collier*  
**ALMOST EVERYWHERE**  
*Flat Iron Building, New York.*

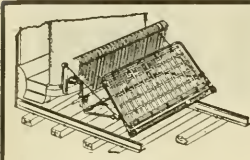

**ECLIPSE  
 Life Guard**

Manufactured by the  
**ECLIPSE RAILWAY SUPPLY CO.**  
 Cleveland, Ohio



**Eventually  
 Atlas Anchors**

Why not now?

**THE ATLAS ANCHOR CO.,** Cleveland, Ohio

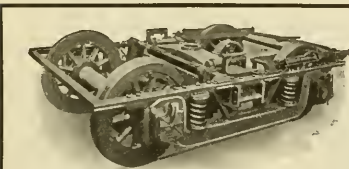

**BALDWIN LOCOMOTIVE WORKS**

BURNHAM, WILLIAMS & CO., PHILADELPHIA, PA., U. S. A.

Builders of **LOCOMOTIVES OF EVERY DESCRIPTION**  
 Including **ELECTRIC LOCOMOTIVES** and

**ELECTRIC TRUCKS**



Truck built for Indianapolis, New Castle & Toledo Electric Railway Company.

**STANDARD STEEL WORKS,**

HARRISON BUILDING, PHILADELPHIA, PA.

**SOLID FORGED ROLLED AND STEEL TIRED WHEELS**  
 mounted on axles and fitted with Motor Gears for Electric Railway Service

**ELLIPTIC AND COIL SPRINGS**

**PIPE FITTINGS  
 AND VALVES**  
 FOR THE  
**HEATING AND PLUMBING TRADE**  
 TRADE  **MARK**  
**JOHN SIMMONS CO.**  
 104-110 Centre Street, NEW YORK

**THE LORAIN STEEL COMPANY**  
**Girder Rails and High Tee Rails**  
**High-Grade Special Track Work**  
 GENERAL OFFICES  
**THE PENNSYLVANIA BUILDING, PHILADELPHIA, PA.**

**I**T IS EASY to say that everybody knows about your road, but it is quite another thing to be sure that they are fully alive to its value as a time and money saver—as a factor in their plans, both for business and pleasure purposes.

To be sure that they are as fully informed as they should be, it is necessary that you should set forth your claims to public favor in a way to interest patrons and possible patrons in all branches of your service, and in all the attractions of your territory.

The object of the **Van Valkenburgh Advertising Service** is to co-operate with your traffic department in putting the facts about your road before the public in the most effective manner.



**E. C. Van Valkenburgh**  
**Promotional Advertising**  
**for Electric Railways**  
 2117 West 102d Street, Chicago

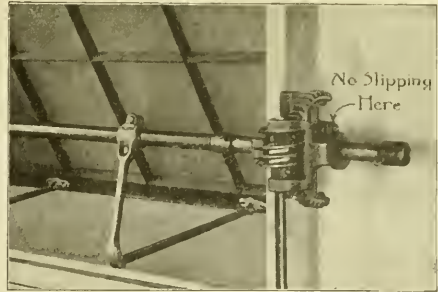

## The Ventilation

of your Shops, Foundries and Car-Barns is made especially effective by a speedy, positive and easily manipulated

## Sash Operating Apparatus

which automatically locks the sash at any position. *Let us send you our catalogue*

**LORD & BURNHAM COMPANY**  
 Irvington-on-Hudson, N. Y.

# HOT WATER HEATERS for Cars

THE PETER SMITH HEATER CO., Detroit, Mich.

THE RAILWAY SPECIALTY  
 AND SUPPLY CO.

## WHERE? CAN WE USE SMITH IMPROVED NUTS ON CROSSINGS

Great Northern Building  
 CHICAGO

# FOSTER SUPERHEATERS

INSURE ECONOMICAL STEAM CONSUMPTION ON LIGHT LOADS.

POWER SPECIALTY COMPANY  
 111 Broadway, New York

## 40% SAVED

BY USING

## Lumen Bronze Axle Bearings

Cast in metal mold—require no-machine finish

### Lumen Bearing Company

BUFFALO — TORONTO

## Electric Railway Material

of every description

### F. P. HARRISON ELECTRIC & MFG. CO.

(Incorporated)

169-170 South St.

NEW YORK

## WASHBURN Traction Draft Rigging

The highest development of its kind, so designed and constructed that the draft rigging is always directly in the line of all pulling and buffing strains. In other words, the spring takes up all shocks without undue strains on the rigging.

This is the draft rigging that enabled heavy interurban cars to be hauled on their own wheels in trains from St. Louis to Los Angeles without a breakage.

Further comment on their strength is unnecessary.

*Ask for new catalogue of traction devices.*

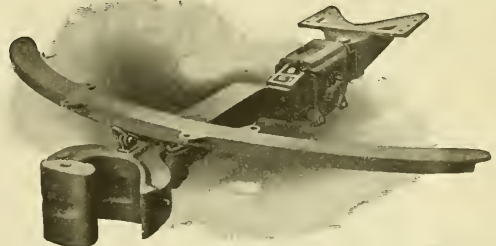

### Washburn Steel Castings & Coupler Co., Minneapolis, Minn.

Western Agents: Tweedy, Hood & Finlen, 204 Fisher Bldg., Chicago

Canadian Agent: John Taylor, Montreal

# CLASSIFIED ADVERTISEMENTS

Undisplayed advertisements are inserted under this heading at the uniform rate of one cent a word; minimum charge twenty-five cents. Replies directed to this office will be forwarded when required to any address in the United States, Canada or Mexico without extra charge. Advertisements received at the Chicago office by 9 a. m. Thursday will appear in the issue for the same week.

## POSITIONS WANTED.

Position as superintendent of city or interurban line wanted by a man of 15 years' experience in both construction and operation. Best of references as to ability and habits. Open for engagement after February 1. Address "No. 541," care Electric Railway Review, Chicago.

Graduate civil engineer, Cornell University 1902, experienced in field work and trade journalism, now engaged, desires work with technical journal or publicity department of manufacturing establishment. Address "No. 525," care Electric Railway Review, Chicago.

Position wanted by first-class engineer and mechanic with 16 years' practical experience with compound Corliss engines, Allis-Chalmers and Westinghouse steam turbines, surface condensers, A. C. and D. C. electrical apparatus. Age 35. A1 references. Address "No. 532," care of Electric Railway Review, Chicago.

Position wanted—The manager of a large railway, lighting and gas plant, desires a change in his position owing to an unfavorable climate. Has held managerial positions for 10 years and is thoroughly familiar with the construction, organization and operation of electric railways. Correspondence solicited. Exceptional references. Address "No. 529," care of Electric Railway Review, Chicago.

An engineer, experienced in the handling and organizing of station crews, with 10 years' experience as chief engineer in both construction and operation, as well as reconstructing old ones on a modern basis. All voltages up to 15,000, both rail and lights. Salary or per cent, depends on results. I am looking for a position as well as salary. Address "No. 536," care of Electric Railway Review, Chicago.

Mechanical and electrical engineer, 14 years' experience. Experienced in power station design and for 14 months acting superintendent of power stations on one of the largest street railway systems in America. At liberty April 1. Desires superintendent of power or similar position. Would open office in Boston as New England representative of responsible manufacturer. Address "No. 546," care Electric Railway Review, Chicago.

## POSITIONS WANTED.

Position as auditor wanted by a young man of experience in street railway and electric light accounting. Best of references as to character and ability. Address "No. 545," care Electric Railway Review, Chicago.

Position as auditor or assistant wanted by a young single man. Thoroughly experienced in railway, gas and lighting accounting. Now employed. Address "No. 544," care of Electric Railway Review, Chicago.

Master mechanic wants position with interurban city road; medium-sized preferred. Wide and thorough experience in all branches; can also do armature winding and switchboard work. Address "No. 542," care Electric Railway Review, Chicago.

Experienced and efficient engineer with power station experience (both planning and construction, as chief engineer and as superintendent of construction) desires position with operating company as engineer, assistant to manager or superintendent. Address "No. 516," care the Electric Railway Review, Chicago.

Young man, 30 years of age, who has nearly completed a course of "Electric Lighting and Railway" in the International Correspondence Schools, desires position which will give him practical experience in power house and switchboard work. Willing to start at a nominal salary. Address "No. 526," care of Electric Railway Review, Chicago.

Position as chief electrician maintenance and inspection wanted with traction company by young man 27 years of age, technical education, five years' experience in testing, construction and maintenance. Salary a secondary consideration, providing hard work and merit will win advancement. Best of recommendations. Address "No. 547," care Electric Railway Review, Chicago.

## POSITIONS OPEN.

Wanted—Electrical salesman who is selling to street railways to take important side line. J. W. Morrison, 29 Griswold street, Detroit, Mich.

## POSITIONS OPEN.

Twelve offices, covering entire street railway and manufacturing world. 1,000 technical and office positions open. Confidential service; write today, HARGOODS, 305 Broadway, New York, or 1010 Hartford Bldg., Chicago.

Wanted—By a large street railway and lighting company, having 14 storerooms, a thoroughly experienced man, capable of taking inventories. Permanent position. Must be able to furnish best of references as to character and ability. Address "No. 538," care of Electric Railway Review, Chicago.

Master mechanic for a property having 150 to 200 cars. Must be experienced, practical and able to run shop on economical basis. Opportunity for good man to make a record. Prefer someone from middle west. Salary \$125 to \$150. Address "No. 537," care Electric Railway Review, Chicago.

Young man wanted to begin work at once as assistant claim agent by a large interurban system in western Pennsylvania. Man of some experience preferred. Must be able to look after office work satisfactorily, as well as to make investigations and adjustments. Address "No. 540," care Electric Railway Review, Chicago.

## BOOKS AND PUBLICATIONS.

Wanted—Copy of the Electric Railway Review of January 12, 1907, in good condition. State price in your answer. Address "No. 530," care of Electric Railway Review, Chicago.

Copies of the Street Railway Review of March and April, 1904, in good condition for binding are wanted. State price sent postpaid. Address "No. 543," care Electric Railway Review, Chicago.

A copy of "The Motorman and His Duties," the standard handbook on the theory and practice of electric car operation, is worth many times its cost to every man interested in the subject. Send for 16-page pamphlet of sample pages. The Wilson Company, 160 Harrison Street, Chicago.

## BOOKS AND PUBLICATIONS.

Copies of the Street Railway Review of January and February, 1906, are wanted. Name condition and price. Address "No. 535," care of Electric Railway Review, Chicago.

We want your friends to read the Electric Railway Review. You will do them—and us—a favor by sending their addresses. We will gladly mail free sample copies. Electric Railway Review, 160 Harrison Street, Chicago.

Interstate commerce national legislation to July 1, 1906, is fully covered in our reference pamphlet. It contains the full text of the act to regulate commerce as amended, including the Elkins and Hepburn acts, and of the supplementary act relating to the testimony of witnesses before the interstate commerce commission. It also contains the texts of the expedition act, the anti-trust act of 1890, the employers' liability act and the safety equipment laws. Difference in type shows the parts expunged from, and the parts added to, the interstate commerce and Elkins acts by the Hepburn act. This pamphlet is of special value to railway men and lawyers. Mailed prepaid for 25 cents in stamps or coin. Special prices for quantities. The Wilson Company, 160 Harrison St., Chicago.

## MISCELLANEOUS WANTS.

Want to buy second-hand equipment, machinery or material? A card inserted in the Electric Railway Review, stating just what you want, will bring immediate response. The cost is small—only \$1.20 an inch (measuring 1 inch deep by 1 1/2 inches wide) per insertion. Send orders to Electric Railway Review, 160 Harrison St., Chicago.

What have you to sell in the way of second-hand equipment, machinery or material? Buyers read the "For Sale" cards on the following page and there is the place to tell your story. "For Sale" cards are inexpensive—only \$1.20 an inch (measuring 1 inch deep by 1 1/2 inches wide) per insertion. Special rates on contracts for 100 inches or more to be used within one year. Now is the time to send your order to Electric Railway Review, 160 Harrison St., Chicago.

# ALUMINUM

## Railway Feeders

And all kinds of Electrical Conductors

Aluminum Feeders are less than one-half the weight of copper feeders and are of equal conductivity and strength. If insulated wire or cable is required, high grade insulation is guaranteed.

Write for prices and full information.

## Aluminum Company of America

PITTSBURGH, PA.

Formerly The Pittsburgh Reduction Company

## "Not an Experiment"

The Providence Fender has been in successful operation on hundreds of roads for 13 years, and has proved itself reliable under all conditions of Street Railway service.

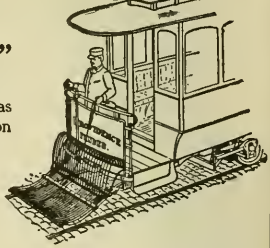

## CONSOLIDATED CAR FENDER COMPANY

Office and Factory: PROVIDENCE, R. I.

Branch Office: 118 E. Twenty-third St., New York  
European Agents: Comploire d'Electricite, 6 Rue Boudreau, Paris, France



**ROSSITER, MACGOVERN & CO. (Inc.)**  
 90 West Street, New York  
**ENGINES** Boilers, Locomotives, Cars,  
*New and* **GENERATORS** *2nd Hand*  
 Transformers, Railway, A. C. & D. C. **MOTORS**

**R.W. MARSHALL & CO.**  
 95 and 97 Liberty St., New York  
 Second-Hand Machinery and Equipment  
**ELECTRIC RAILWAY MATERIALS**

**HEINE SAFETY BOILER CO.**  
 421 OLIVE STREET, ST. LOUIS, MO.  
 Manufacturers of WATER TUBE BOILERS

**NO SNOW TO DELAY CARS**  
 \* The Russell Snow-Plow is used by more than 50 roads to maintain schedules and prevent blockades.  
 Russell Car & Snow-Plow Co., Ridgway, Pa.  
 Wendell & MacDuffie, Cortlandt St., New York; C. A. Ralston, Fisher Bldg., Chicago; Robinson & Cary Co. Saint Paul.  
**IF YOU HAVE A RUSSELL**

**RAILS**  
*Locomotives Cars Etc*  
*Bought & sold*  
*Wholesale & Retail*  
**ZELNICKER Supply Co.**  
 IN ST. LOUIS

**FOR SALE CHEAP!**  
 One 14x22 eight-wheel locomotive  
 Ten 34-foot 50,000 capacity flat cars  
 Two Greenleaf turntables  
 70 box cars, 40 and 50,000 capacity  
 80 Good Second-hand Bridges  
 Specifications and Blue Prints on application  
**F. A. JOHANN**  
 1624 Pierce Bldg., St. Louis, Mo.

**Bellamy Vestlette**  
 For Street Railway Conductors  
**ABSOLUTELY SAFE. Money cannot be lost or stolen from these pockets OVER 150,000 IN USE**  
 Saves the price of a coat yearly. Conductor's uniform always presentable. Adopted as a part of the uniform by over 200 Street Railway Companies. Price \$2.00, sent to any address prepaid, where we have no agent. Agents wanted on every line.  
 The Bellamy Vestlette Mfg. Co., Cleveland, O. and A. F. JURY, 265 Yonge St., Toronto, Canada  
 Patented April 27, 1897

**FOR SALE: Three Car Bodies and Three Pairs of Double Trucks**  
 with or without electric equipment and air brakes; all new and never used. Compelled to sell, as these cars will not operate over a leased line by reason of their width and length.  
**R. W. MARSHALL & CO., 97 Liberty St., New York, N. Y.**

**Gongs** For Street Cars **Bells**  
 G. C. REITER, Canton, Ohio

**It costs just two 5c fares to heat a car 24 hours if you use a COOPER HEATER**  
 Send for interesting pamphlet  
**The Cooper Heater Co., Dayton, Ohio**

**P & B INSULATING VARNISHES**  
 Possess the highest insulative efficiency. Meet every requirement in electrical work.  
**P & B ELECTRICAL COMPOUNDS**  
 Send for Literature and prices.  
**THE STANDARD PAINT COMPANY, 100 WILLIAM ST., NEW YORK.**  
 BRANCHES: CHICAGO, ST. LOUIS, KANSAS CITY, PHILADELPHIA, BOSTON, NEW ORLEANS.  
**P & B INSULATING TAPE**

**The Milloy Trolley Base**  
 built in our new and specially equipped factory, insures a quality which will give excellent service under ordinary and extraordinary conditions.  
 The Milloy Base is unusually low, has even tension on high or low wire. Has no fulcrum, no friction, no oil, no center post. Always efficient. Particulars on request.  
**THE MILLOY ELECTRIC COMPANY**  
 Bucyrus, Ohio

**Hydraulic Pumps**  
 WE have just received from the printers Catalogue No. 71, describing Hydraulic Pumps, which we are building. This replaces our former Catalogue No. 56, and shows about 75 varieties of pumps for obtaining pressures from 300 lbs. to 10,000 lbs. to the square inch. Operated by hand, belt, steam or electric power. It is a book of about 140 pages. Do you want a copy?  
**THE WATSON-STILLMAN CO.**  
 26 Cortlandt Street, New York City  
 Branch Office, 453 The Hookery, Chicago, Ill.





## The Worst Sleet Storms

are yet to come. If you have not already a supply of "Nuttall" Sleet Scrapers and Sleet Wheels, you had better order now.

*If in a hurry, wire us.*

SEND FOR CATALOGUE No. 10

**R. D. Nuttall Company**  
Pittsburg, Pa.

GEARS PINIONS TROLLEYS

# → 93.3% ← REDUCTION

in the drop over a contact carrying 1,000 amperes was the result of a recent test made in a power house of the Commonwealth Edison Company of Chicago, by the use of the

## HAROLD BROWN ALLOYS.

Contacts amalgamated with these Alloys over ten years ago by the Metropolitan West Side Elevated Ry. Co. of Chicago are *still as bright as when first applied.*

In October, 1897, the South Side Elevated R. R. Co. of Chicago amalgamated the terminals of the bonds used on the third rail and recent investigation showed the contacts to be *perfectly free from oxide and as good as when first installed.*

It is of these Alloys that the

## Plastic Rail Bond

is made.

*The bond that will transmit 3,000 amperes without the slightest injury and show but 5 per cent depreciation after eleven years' severe service.*

Consider these FACTS, or, better still,

**TRY IT.**

**HAROLD P. BROWN,** 120 Liberty Street,  
NEW YORK.

One of the strongest points about this car for installing rail bonds by

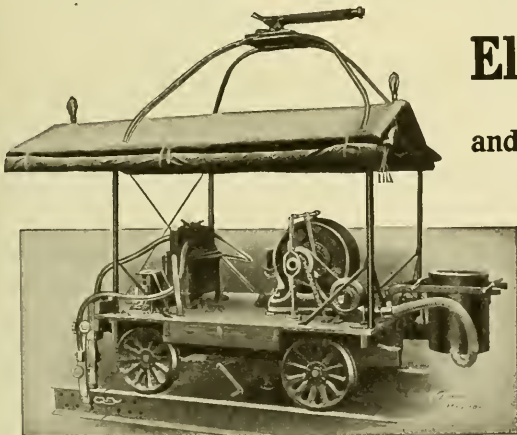

## Electric Brazing and Copper Welding

is its *portability.*

It can be removed from the track in one minute when necessary to meet traffic conditions. And it can be replaced in equally short time. Its use has proved profitable, without serious interruption of service, on lines running under a 2½-minute headway.

*We would like to tell you some more facts  
—write us, please.*

**The Electric Railway Improvement Co.**

6005 Carnegie Avenue, Cleveland, Ohio

## PAINTS FOR BRICK SURFACES

Let us write you how to secure lasting results in painting your power houses and car barns.

**Detroit Graphite Company**  
DETROIT, MICH.

Send for Color Card A.

Dept. S.

## ROLLING DOORS

In Steel, Wood or Bronze

FOR CAR BARNS, FREIGHT SHEDS, ETC.

Made by the

**JAS. G. WILSON MFG. CO.**

New York Office: 3 W. 29th Street

ESTABLISHED 1876

Incorporated 1903

# Kinnear

## STEEL

# Rolling Doors

### FOR CAR HOUSES



Operate Easily, Speedily, Satisfactorily and are very durable. Write for Catalog

**The Kinnear Manfg. Co.**

COLUMBUS, OHIO.

BOSTON  
85 WATER ST.

CHICAGO  
112 CLARK ST.

PHILADELPHIA  
1011 CHESTNUT ST.

## Shawmut Soldered Bond Cap

to make over your  
**PLUG BONDS**



Why not look this up

**CHASE-SHAWMUT CO.**

Newburyport, Mass.

# Galena-Signal Oil Company

FRANKLIN, PA.

THEIR SPECIALTIES

**STREET RAILWAY LUBRICATION** including both rolling stock and power house equipment.

Same skillful *expert supervision* given in this service as in steam railway service has produced very satisfactory results. The business of our Street Railway Department has increased beyond every expectation. In 1906 this department sold ten times the number of barrels of oil sold by the same department in 1903.

We are under contract with many of the largest street and interurban railways of the country.

We guarantee cost per thousand miles in street railway service when conditions warrant it.

Write to Franklin, Pennsylvania, for further particulars.

**STEAM RAILWAY LUBRICATION** Sole manufacturers of the celebrated *Galena Couch, Engine and Car Oils* for steam railway lubrication. *Sibley's Perfection Valve Oil* for cylinder lubrication, and *Perfection Signal Oil* for use in railway signal lanterns.

**GALENA RAILWAY SAFETY OIL** Made especially for use in headlights, cab, classification and tail lights, and for switch and semaphore lamps. Burns equally well with the long time as with the one-day burner; with or without chimney as the burner requires. Is pure water white in color; high fire test, low cold test, and splendid gravity.

CHAS. MILLER, President

# Electric Railway Review

PUBLISHED EVERY SATURDAY BY THE WILSON COMPANY, CHICAGO

Entered as second-class matter January 5, 1907, at the postoffice at Chicago, Ill., under the act of March 3, 1879.

160 Harrison Street, Chicago  
150 Nassau Street, New York  
1529 Williamson Bldg., Cleveland

Vol. XIX  
No. 7

CHICAGO, FEBRUARY 15, 1908.

Whole No.  
251

Subscription: Domestic . . . \$2  
Foreign . . . \$5  
Canada . . . \$3.50

Among the factors which contribute materially to the successful operation of the lines of the Ft. Wayne & Wabash Valley

## Associations for Officers and Employes.

Traction Company are the three associations organized by the management, some of the principal features of which are described in this issue. The regular meetings of the Officers' association of this company give the heads of departments a more thorough understanding of the problems of management than they could acquire in any other way. At these meetings the questions which arise are discussed in their relation to various departments and from the broad standpoint of the good of the company. The Superintendents' association deals with matters pertaining to discipline, and its primary duty is the impartial enforcement of the merit system which was adopted recently. Such a plan, providing for just recognition of all conduct that is prejudicial to the best interests of the company, accompanied by willing recognition of acts which promote the good will of the public toward the corporation and conserve its earnings, might well be adopted by every public service corporation. A loose method of discipline, without systematic records, is likely to cause the retention of employes who are so far below the standard that they do incalculable damage in the service in spite of the painstaking efforts of their superiors; the desire for good records, which will be called to the attention of the management, and the hope of winning the promised prizes, will inspire many to unusual efforts to please. The deep interest felt in the third association, the Employes' Mutual Benefit association, is shown by the fact that the membership now comprises 85 per cent of the total number of employes, although the organization has been established only since October 1 last.

An important problem in handling traffic in a growing city is the storage of rolling stock which is neither in service nor in the shop. Obviously, a small road operating but a dozen or two cars can usually

## Subdividing Car Storage.

handle them most economically from a single house; as business increases, however, a decision must be made between more than one car house and a central storage and repair point. To a considerable degree the shop practice of a company is involved with the car storage, but on the whole the most important point to examine is the reduction of dead mileage. It seems to be accepted generally now that while one main repair shop is essential for street railways of almost all sizes, except perhaps in the special cases of one or two very large organizations, inspection can be conducted at subordinate centers of operation just as well as at the main repair shops. Fear that proper inspection will not be given to the equipment at secondary car houses should not deter a company from building such houses. The problem should be attacked along the line of reducing dead mileage at night and morning, and the cost of this mileage balanced against the fixed and operating charges of the new house. Each case must be weighed upon its own peculiar merits in somewhat the following way: A cost estimate should be made for a new car house of a capacity likely to be required in the near future, and located on a site of known value near the operating

center of the section of the city which it will directly serve. The saving in dead mileage for this location should then be estimated, in comparison with the cost of the dead mileage to and from the central and original car house of the system. Power should of course be included, as well as labor cost, in getting at the operating expense of the excess miles run.

---

## Reducing Dead Mileage.

In a specific instance the average operating cost per car-mile on an entire system may not apply to the expense of actual dead mileage operation on a particular part of the system, and it may pay to check the idle mileage and power by actual measurements. On a road where cars are started out in the morning from a central house to begin their regular runs 20 or 30 minutes later at the distant ends of their routes, with the reverse process of returning late at night over a route practically void of earnings, it ought not to be difficult to secure fairly close estimates of this dead mileage cost. The saving due to the new location should more than offset the fixed charges, extra supervision and attendance at the new house, if a clear-cut solution of the problem is to be secured. Beyond a certain point, possibly 50 cars on a small system and from 200 to 300 on a large system, it is a matter of insurance against fire losses and to some extent blockades, to subdivide the rolling stock storage. The point is that, while no general rule can be laid down, there is a chance for some skillful analysis of the financial aspect of car house location in connection with the expansion of growing systems. Local conditions impose restrictions upon the actual locations of car houses, and sometimes the lack of proper land produces awkward operating results. It costs some time to figure out the economies of different locations, but the problem is no more insoluble than the corresponding engineering question of power and substation location. The dollar side of the feeder problem is scarcely less difficult than the car house money question, viewed from the standpoint of annual operating cost. Rule of thumb methods are no longer applicable to the well-conducted transportation department.

---

Electric railway companies have usually been so actively engaged in building new lines and increasing their facilities for handling traffic that their officials have

## Treated Ties for Electric Railways.

not had opportunity to give as much attention to the development of numerous little refinements in operating methods effecting reductions in operating expenses as have the officials of the older and better organized steam roads. A limiting initial cost also has often been a factor in the building of new lines which has prevented the employment of improved methods. One of the practices through which an appreciable saving can be effected is in the use of treated instead of untreated ties for both street and interurban railways. A fair estimate of the number of ties in use on the electric railways of the United States is 125,000,000. The average life of an untreated tie being five years (it is perhaps less on some street railways where conditions are unfavorable), the number of ties required annually would be 25,000,000. On the steam railways records show that about 16

per cent of all ties used are treated and if we assume that as high a per cent of treated ties is used on electric railways there will still remain in the annual tie order about 21,000,000 untreated ties which, if treated by approved processes, would generally give service five or six years longer than if untreated. Based upon reasonable assumptions as to cost of tie and cost of treatment an annual saving of about one and one-quarter million dollars would result from the complete adoption of treated ties. Reduced to more tangible figures this means a saving in maintenance expense of about \$32 per mile per annum. It is usually the practice of such apparently little economies as this which in the aggregate marks the difference between dividends and deficits at the close of the year.

---

### SINGLE-PHASE RAILWAY CONSTRUCTION FEATURES.

---

With nearly 100 miles of well-built track the Washington Baltimore & Annapolis Electric Railway is now in regular operation. As a magnificent example of the most recently completed large single-phase electric railway we are pleased to describe the constructional features of this road in the present issue of the Electric Railway Review. In the engineering design of this new road features novel and of especial interest to both operators and constructors have been introduced, some with a view to economies and others as the best-known means of meeting conditions imposed.

We know of no other road the rolling stock equipment of which is called upon to operate under so many different arrangements of current supply.

In Baltimore the cars of the new road are fed direct current, at 600 volts pressure, through a single trolley pole and wheel of the type in general use elsewhere. Between cities on the private right of way this same trolley wheel collects current at 6,600 volts pressure. In the streets of Annapolis and likewise in the District of Columbia two trolley poles are used, one for collecting direct current at 600 volts pressure and the other for the return circuit, which is overhead, two trolley wires being used.

Still another method of current collection, one which, while not required at present, may be required in the future, is the use of the underground plow. Should conditions ever be such that the Washington Baltimore & Annapolis high-speed interurban cars can be run over the city system tracks in Washington, then current for their propulsion must be collected from the conductor rails in the underground conduits. Realizing this not altogether improbable condition the engineers have so equipped the cars of the new road that none of the existing apparatus will interfere in the event of the mounting of contact plow supports for city terminal service in Washington. The commutating switches which serve to change the wiring connections for various methods of current supply are built with a view to fulfilling the additional duty of feeding current from an underground plow to the motor circuits, as well as making the 6,600-600-volt transfer.

At present and conditionally all the cars are fitted with only trolley wheels and poles for current collection. The regular schedule for through car service between termini will necessitate speeds of 60 miles per hour; the distance between the terminals in Washington and Baltimore is 38 miles and the schedule time for the run is 60 minutes, including the time required to operate over city tracks and for making regular stops. We believe that operation will demonstrate that the pantagraph trolley or some form of sliding collector is more suitable for this fast service than is the wheel trolley.

The high potential (6,600 volts), of course, reduces the current density at the collecting point very greatly as compared with 600-volt service. Yet with a catenary-supported trolley there are so many more ears under which the trolley must pass that the wear will probably be as great as though

lower voltage were used. Another reason, other than because of its longer life and smoother operation, for our view that the sliding current collector will be found better adapted for the service, is that at the high speeds at which the cars of this road will run the jumping of a trolley wheel and pole from the wire will cause no little damage. Especially is this true with the wire catenary-supported. Were a trolley wheel to leave the wire at high speed and catch in the overhead work the results would be far more serious on a road operating at 6,600 than at 600 volts.

We are told that two locomotives being built for the Washington Baltimore & Annapolis will be equipped with pantagraph current collectors. Records of the service rendered by these, as compared with the poles and wheels, will answer our question definitely.

The overhead construction on the new line comprises some novel features that should undoubtedly render it especially serviceable and permanent. Differing from some other of the double-track high-speed single-phase lines steel bridges are not used to support the messenger cables. A combination of wooden poles, steel brackets, span wires and back guys has been devised and so erected that the trolley wires of the new road are as well hung as can anywhere be found.

On the double-track route each catenary messenger cable is carried on porcelain insulators resting on metal pins clamped to horizontal T-iron bracket arms. Each bracket arm is supported from above by a wrought-iron rod bolted through the pole. Center pole construction is not used. The trolley wire over each track is supported by a row of poles set in the outer shoulder of the subgrade, the poles being so spaced and set that they are opposite each other in pairs. This arrangement places the two brackets, one for each track, in line.

The tipping strain toward the track caused by the weight of the wires is transmitted to a solidly planted guy anchor by a back guy fastened to the pole just below the bracket.

The structure as thus far described would seem to be capable of meeting any demands to be placed upon it, but an additional factor of safety has been introduced by the tying together of the poles and brackets standing opposite each other across the track. A  $\frac{1}{2}$ -inch steel cable spans the tracks, connecting the poles at the points where the back guys are fastened to them. This cable passes through a depending arm hung from the end of each bracket and thus completes the very substantial structure.

Considering the service requirements it hardly seems possible that a more economical structure could have been devised for supporting the messenger and trolley.

These few innovations in single-phase railway engineering and the many others described in the article on the Washington Baltimore & Annapolis road, elsewhere in this issue, are an index of the development that may be expected in high-voltage railway construction during the next few years.

---

General Manager T. W. Wilson of the International Railway of Buffalo is quoted as saying that the first month's operation of pay-as-you-enter cars on the Niagara line has been so successful that many requests have been made by patrons of the company that it install this type of cars on its other lines. Mr. Wilson says that the warmth and good ventilation of these cars, which are made possible by keeping the front platform doors closed except at stops, have added to the popularity of the cars.

---

The Cheltenham Press, New Castle, Pa., has recently published an excellent pocket size map of the electric railways in operation and under construction in western New York and Pennsylvania, northern West Virginia, eastern Indiana and southern Michigan. The map is lithographed in five colors.

# Communications

## PRACTICAL VIEWS ON TRUCKS FOR ELECTRIC MOTOR SERVICE.

To the Editors:

Replying to the communication of C. Loomis Allen in the Electric Railway Review for January 25, 1908, page 103, pertaining to this subject as discussed by me in your issue for October 19, 1907, page 679, I desire that it should be first stated that as author of the paper referred to I did not purposely endeavor to favor any particular make of truck—patented or otherwise—the points brought up being entirely from experience and observation and especially from wide observation.

The type of passenger coach truck universally used by the steam railways and generally known as the M. C. B. standard is not in a technical sense a standard truck and for the purpose of a brief and practical discussion it was not intended nor expected that such inference would be made. We all know that a thing to be technically standard must conform in its entirety in shape, size and substance and that the various classes of steam railway passenger equipment differing widely as to weight and service require trucks of varying capacity, etc., to conform. What I did intend to infer was that the general principles involved in the M. C. B. type of truck were standardized in a practical sense and as such were adopted by the Master Car Builders' Association and universally used before electric motors were used in connection with double trucks of street or interurban railways and therefore were not intended to apply to such requirements as are not yet fully developed.

Referring to my analysis of the so-called M. C. B. type of truck, in connection with Mr. Allen's criticisms of the antagonistic features of the double frame, I believe that my statements are amply justified by observation of excessive wear between the parts in contact, especially between the journal box and the pedestal jaws. The point Mr. Allen raises—of my overlooking the fact that the motors are not rigidly connected to the main frame—is, most certainly, not the case, for I believe that it is largely on account of this "flexible connection" and the consequent uncontrolled flopping of the motors in opposite directions that excessive wear is produced in the double-framed truck. It is principally for this reason that I am inclined to favor the abandonment of complicated trucks and principles. I cannot agree with Mr. Allen as to the good effects of the generous equalizing qualities of the truck named. The extensive use in high-speed interurban service, where only a practical test of real value can be made, of even the so-called M. C. B. type of truck would seem to completely refute all theories in this regard.

My plea is for a truck to accomplish the desired results which will be lighter, cheaper and with fewer pieces than either the so-called M. C. B. truck or the truck named by Mr. Allen. and a single frame, preferably of the diamond form, is entitled to serious consideration. The flexibility of the springs which has proved so effective in taking care of side motion in single trucks may yet demonstrate its effectiveness in double trucks, but certainly not as long as they are placed crosswise of the truck where flexibility is impossible except in the wrong direction, i. e., fore and aft.

Mr. Allen's statement that the type suggested by me has long since been discarded in this country and that its dangers are recognized in Europe is certainly amazing—especially in view of the fact that this single frame is at the front of every fast train in this country—either under the engine or tender and sometimes both. Good or bad riding in any truck is largely a matter of springs and good riding cannot be secured without springs of proper capacity and

flexibility, although it is frequently attempted to do so.

It pleases me to note our agreement as to the desirability of a single-frame truck, and I believe that if the subject received the attention it deserves from such men as Mr. Allen a suitable design would be forthcoming and the Scotch verdict of "not proven" could not be rendered.

FRANKLYN M. NICHOLL.

Cincinnati, O., February 7, 1908.

## ANNUAL REPORT.

### Detroit United Railway.

Gross earnings of the Detroit United Railway increased 16.7 per cent in 1907 over 1906, but operating expenses and taxes were 20.1 per cent larger and net earnings from operation showed a gain of 11.2 per cent. The earnings for 1907, with a comparison, were as follows:

	1907.	1906.	Increase.
Miles of track.....	741	620	121
Gross earnings .....	\$7,073,246	\$6,063,183	\$1,010,063
Oper. expenses and taxes. .	4,465,044	3,718,622	746,422
Net earnings .....	\$2,608,202	\$2,344,561	\$ 263,641
Other income .....	60,505	58,758	1,747
Total net income.....	\$2,668,707	\$2,403,319	\$ 265,388
Charges .....	1,554,249	1,243,273	310,976
Net divisible income....	\$1,114,458	\$1,160,046	*\$ 45,588
Dividends .....	343,750	625,000	*\$21,250
Surplus .....	\$ 770,708	\$ 535,046	\$ 235,662
Depreciation .....	276,000	250,000	26,000
Surplus .....	\$ 494,708	\$ 285,046	\$ 209,662

\*Decrease.

The figures show the reduced dividend disbursement and the larger appropriation for depreciation. These figures are those presented in the annual report covering the operations of the Detroit United Railway, the Rapid Railway System, the Sandwich Windsor & Amherstburg Railway and the Detroit Monroe & Toledo Short Line Railway for the year 1907, and of the Detroit Jackson & Chicago Railway for the 11 months ended December 31, 1907. The balance sheet of the Detroit United Railway shows \$656,906 bills payable. J. C. Hutchins, the president, refers to the organization of the Detroit Jackson & Chicago Railway, which acquired, at a cost of \$1,230,000, the properties of the Detroit Ypsilanti Ann Arbor & Jackson Railway, the Jackson Ann Arbor & Detroit Railway and the Detroit Plymouth & Northville Railway. The rolling stock of the company consists of 943 closed passenger cars, 325 open passenger cars, 229 freight and construction cars, 16 line cars, 42 express cars, 6 miscellaneous cars, 2 locomotives, 2,637 motors and 2,019 trucks.

Passenger and mileage statistics for the entire system compare as follows:

	1907.	1906.	Increase.
Revenue passengers .....	126,601,946	113,011,309	13,590,637
Transfer passengers .....	36,704,431	32,840,259	3,864,172
Employe passengers .....	5,274,390	4,939,224	335,166
Total passengers .....	168,580,767	150,790,792	17,789,975
Gross earnings per revenue passenger, cents .....	5.25	5.07	0.18
Gross earnings per passenger, cents .....	3.94	3.80	0.14
Car-miles .....	30,209,488	25,973,526	4,235,962
Car-mile results, cents—			
Gross earnings .....	23.41	23.34	0.07
Expenses .....	14.78	14.32	0.46
Net earnings .....	8.63	9.02	*0.39

\*Decrease.

Wells, Fargo & Co. have taken over the entire express business of the Los Angeles-Pacific Company, Los Angeles, Cal.

THE WASHINGTON BALTIMORE & ANNAPOLIS ELECTRIC RAILWAY.

On February 7 the first regular cars were put in service on the Washington Baltimore & Annapolis Electric Railway. The new road connecting the three cities included in its name is a magnificent example of the latest development of the 6,600-volt trolley system. The present article describes and illustrates the interesting features of construction of this property.

Organization.

The Roberts & Abbott Company of Cleveland, O., has been in complete charge of the design and construction of the new road, M. A. Munn acting as chief engineer. Simouson & Pietsch of Baltimore were architects for the buildings and the Fidelity Construction Company, Detroit, Mich., did the grading, track and line work as general contractor.

The Washington Baltimore & Annapolis Electric Railway has a total capitalization of \$10,500,000, of which \$4,250,000 is first mortgage bonds, \$1,000,000 second mortgage bonds and \$5,250,000 stock.

The officers and operating heads of the company are: President, George T. Bishop; vice-president, John Sherwin; second vice-president and general manager, J. N. Shannahan; secretary and assistant treasurer, W. A. Kappler; treasurer and assistant secretary, C. F. Gladfelter; general traffic manager, W. E. Slaughter; purchasing agent, William Stewart; superintendent of transportation, J. O'Hara; superintendent

cars operate from this point to Fifteenth and H streets over the Columbia line of the Washington Railway & Electric Company, a distance of approximately four miles.

(2) A single-track road located practically at right angles to the main line, and crossing it 15.5 miles from the Baltimore terminus. This road, the Annapolis Washington & Baltimore Railroad, one of the oldest steam roads in the country, is now electrified. It connects Annapolis with the Baltimore & Ohio Railroad at Annapolis Junction, with the Pennsylvania Railroad at Odenton, and with the new main line at Naval Academy Junction.

(3) A single-track suburban line running north from Washington, termed the Berwin & Laurel Electric Railway,

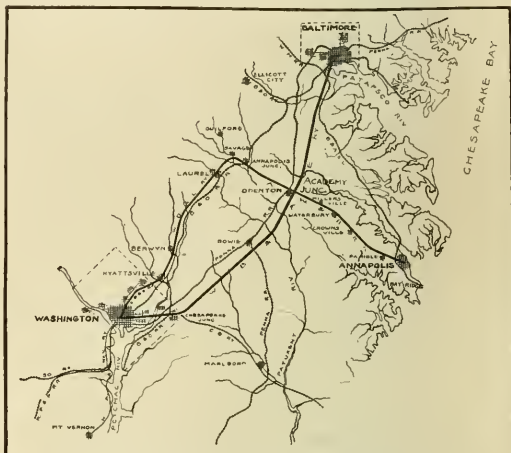

Washington Baltimore & Annapolis—Map of Lines.



Washington Baltimore & Annapolis—General View of Baltimore Terminal Station.

of track and overhead, J. J. Doyle; master mechanic, Henry Donovan.

Roadway and Track.

The Washington Baltimore & Annapolis Electric Railway Company's system, as shown on the accompanying map, consists of:

(1) A double-track road, known as the main line, running from the retail center of Baltimore to Fifteenth and H streets, N. E., Washington, D. C. At this point is located a transfer station, where special cars of the Washington Railway & Electric Company connect with the interurban cars, running direct to the Treasury building. The tracks of the new road stop at the District of Columbia line, but the large interurban

which connects with the Washington Railway & Electric lines at Berwin, the cars of the latter company operating from Berwin to the Treasury building, Washington. It is proposed in the future to complete the system by extending the Berwin & Laurel road to meet the Annapolis Washington & Baltimore Railroad at Annapolis Junction.

The single-track mileage is as follows: Main line, 67.28 miles; Annapolis Washington & Baltimore, 20.5 miles; Berwin & Laurel, 9 miles. A total of 96.33 miles of track owned.

The main line is laid with 80-pound A. S. C. E. section 33-foot rails on 6 by 8 inch 8-foot chestnut ties, ballasted with gravel. The city tracks are laid with Pennsylvania Steel Company rails, section 273-125, in 50-foot lengths. The maximum grade is 2 per cent, with the exception of one 5.7 per cent grade about 500 feet long in Baltimore. With one exception the curves are of 1 degree or less. Seventy-nine per cent of the main line is tangent track. The track on private right of way is bonded with the American Steel & Wire Company twin-terminal bonds. In Baltimore Lord Electric Company soldered bonds are used and in Annapolis the Crown bonds. All bonds are of No. 0000 capacity. Those on private right of way are painted black.

As the country between Baltimore and Washington is rolling, with the valleys crossing the line, a large amount of grading, approximately 1,600,000 cubic yards, was necessitated in order to obtain the grades and alignment stated.

On private right of way the tracks are laid with 11-foot centers.

Entrance to Baltimore.

From the terminal in Baltimore the cars operate over the city streets about a mile and a half. At the foot of Scott street the cars leave the street level and pass on to a long



elevated roadway. The tracks cross the main line of the Baltimore & Ohio Railroad at a height of 22 feet on a through Pratt truss bridge 115 feet 6 inches long. This is the beginning of a series of three steel viaducts, by means of which a safe and rapid entrance into Baltimore is obtained. The viaducts aggregate approximately one-half mile in length and are separated by fills. The total distance from the north end

forced concrete solid floor bridges, the latter type giving a smooth running roadbed.

At Baltimore an attractive terminal building is located at Liberty and Marion streets, extending through the block and facing a cross street. The cars run through the station on the street level. The upper floors provide excellent office accommodations for the railroad operating organization.



Washington Baltimore & Annapolis—Standard Two-Compartment Car Fully Equipped.

of the elevated structure to the south end is approximately  $1\frac{1}{2}$  miles.

A short distance south of the elevated structure there are two tunnels, the northern one being at the head of a 40-foot cut. These tunnels are rectangular in cross section and are built with reinforced concrete sides and roof. The north tunnel is 88 feet long and the south tunnel is 270 feet long.

The terminal building is built of reinforced concrete throughout, with brick and stone facings on streets. Accompanying halftone illustrations present interior and exterior views.

#### Overhead Construction.

Accompanying engravings show the arrangement and dimensions of the overhead construction and also include a

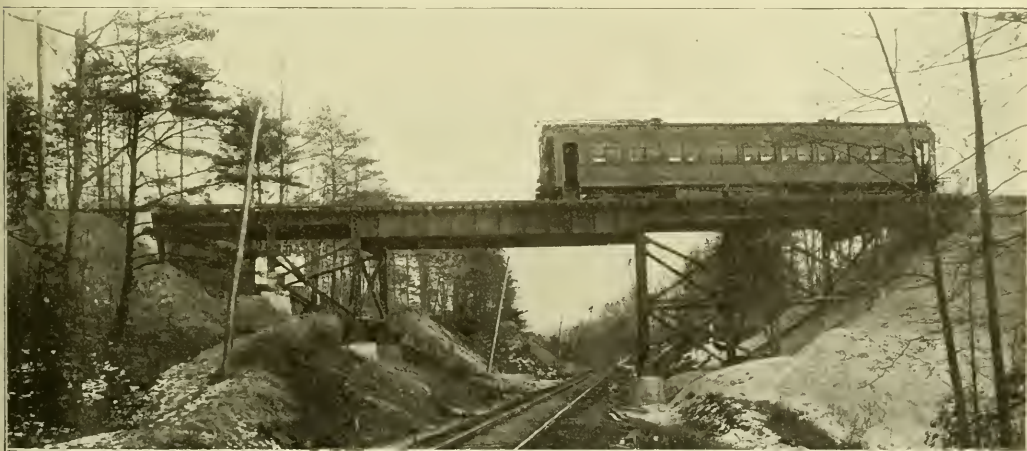

Washington Baltimore & Annapolis—Double-Track Steel Viaduct over Steam Road.

They are connected by retaining walls 103 feet long. The tunnels pass under two county roads and one residence. They were constructed by making an open cut with a steam shovel; the concrete was then placed and the structures back filled upon completion.

There are no grade crossings of either steam or county roads on the entire main line, with the exception of two public road crossings little used. The under grade crossings consist of timber bridges and the overhead crossings consist of rein-

complete "circuit diagram." Compared with other single-phase roads the new Washington Baltimore & Annapolis overhead construction includes many advanced ideas.

The trolley wires carry current to the cars at 6,600 volts feeding pressure. The single No. 0000 trolley wire over each track is supported from a  $\frac{3}{8}$ -inch high strength steel messenger cable by hangers spaced 16 feet 8 inches apart.

The messenger wire rests on top of a special insulator designed by C. E. Eveleth, construction engineer for the



Washington Baltimore & Annapolis—Interlocking Tower at Naval Academy Junction.



Washington Baltimore & Annapolis—Overhead Construction on Main Line.

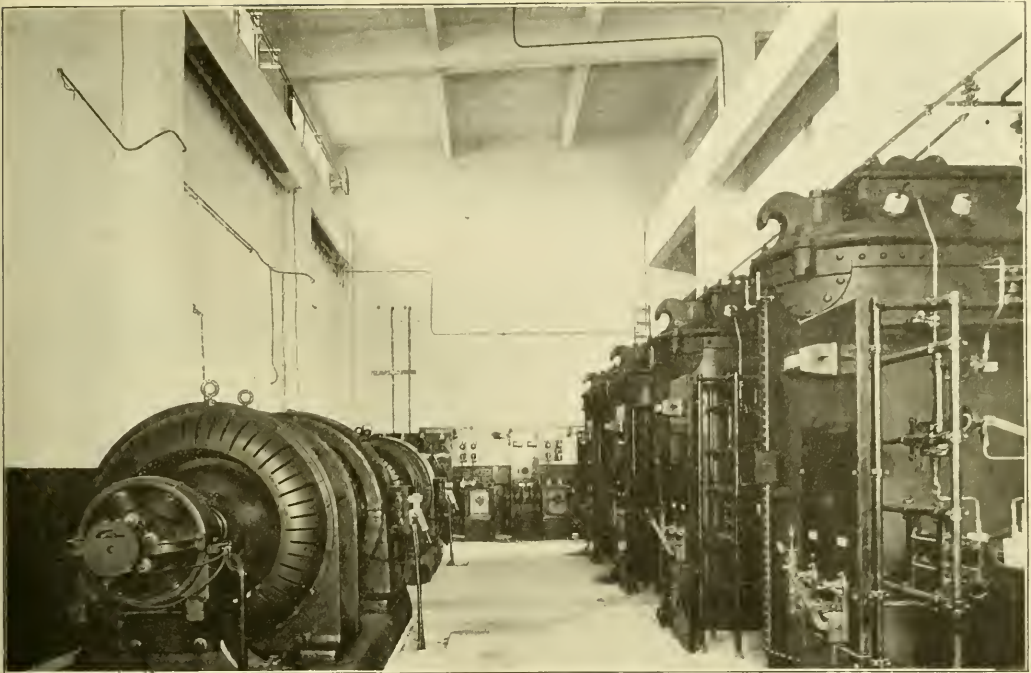

Washington Baltimore & Annapolis—Interior of Substation at Naval Academy Junction.

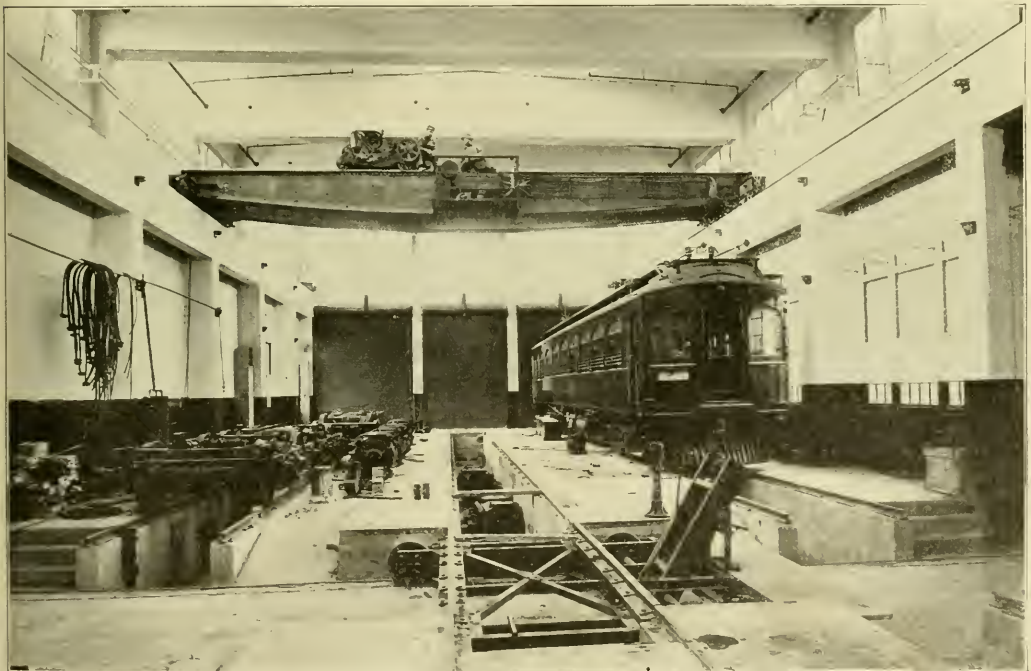

Washington Baltimore & Annapolis—Interior of Part of Repair Shops.

General Electric Company. This insulator of porcelain is provided on its upper surface with grooves parallel with and also at right angles to the messenger wire. The grooves are of such depth in the porcelain and are so spaced that any ordinary blow will not damage the entire insulator, but serve merely to crack off one side of the petticoat, leaving the messenger wire in the top still well insulated.

The messenger wire insulators are cemented on malleable iron pins, the pins being adjustable on bracket arms comprising 10-foot 6-inch lengths of T-bar and  $\frac{5}{8}$ -inch supporting rods, as illustrated in detail.

Where the line is double-tracked from Washington to

ground wire of  $\frac{1}{8}$ -inch galvanized steel strand is strung along the tops of the poles, which line is grounded at every fifth pole. On each bracket at the back of the pole casting, and in electrical contact with the latter, is mounted a ground plate, which is connected by a wire with the ground line extending along the tops of the poles. By this arrangement each bracket is thoroughly grounded.

On curves as conditions demand the messenger and trolley are guyed by wires extending from porcelain strain insulators mounted on the poles, out to the suspension rods on each side of the bracket. On tangent track steady braces are installed on every tenth pole. At sidings the main line

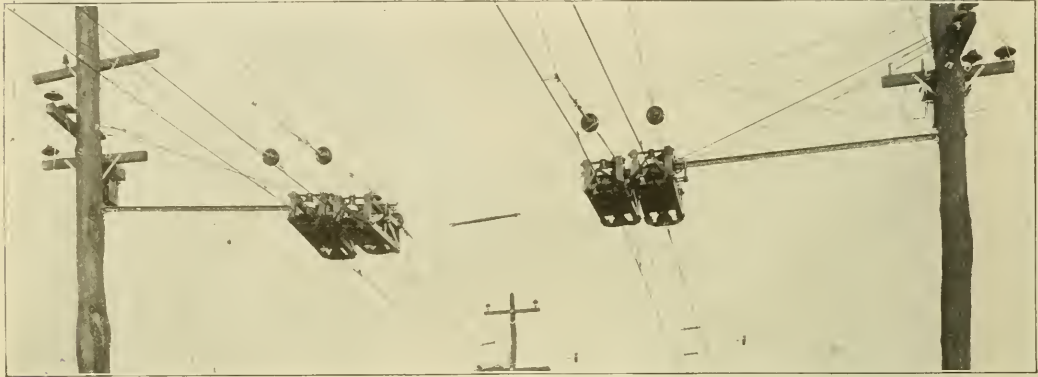

Washington Baltimore & Annapolis—Section Insulators Where Change of Current is Made.

Baltimore a pole line is erected on each side of the right of way, carrying the side brackets for suspending the trolley wires. The poles, which are painted with carbolineum, are spaced 150 feet apart. This pole spacing is not reduced except on curves sharper than 6 degrees. Each pole carries a bracket of the type illustrated. At the outer end of each

and switch track trolley wires are parallel, but no switch pan is used. Where the line passes under bridges the structure overhead is protected by a galvanized iron trolley trough grounded to the rails.

In Baltimore the cars are operated over the city tracks by direct current at 500 volts potential taken from span sup-

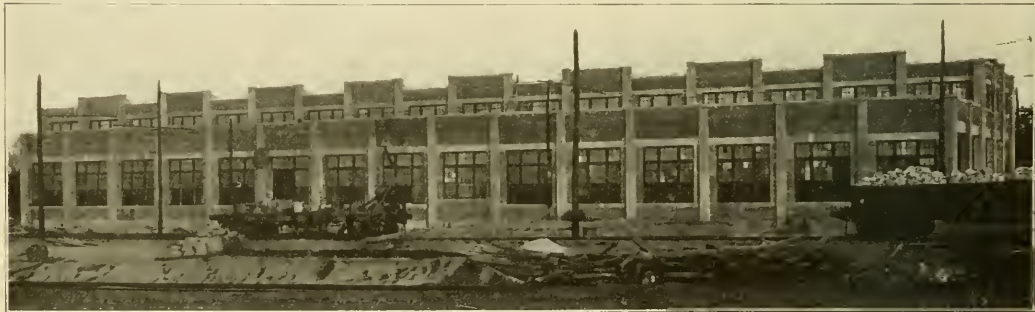

Washington Baltimore & Annapolis—Exterior of Repair Shops.

bracket is a guide casting through which is threaded a cable extending across the track between each pair of poles. Other cables extend from each pole obliquely to the ground and there are anchored with Miller guy anchors. The pole line by this arrangement is given ample stiffening against lateral vibration. A 24-inch wood break strain insulates one trolley supporting system from the other on the double-track roadway.

On the branch line running from Academy Junction to Annapolis single-track construction is used with a single pole line.

All pole lines are grounded in the following manner: A

ported trolley wires of the usual form carried on steel poles. In Annapolis and Washington direct current is also used and a double overhead trolley was required with one positive and one negative wire for each track.

Illustrations are presented showing the sectionalizing line breakers installed where the change is effected from alternating to direct current or vice versa. The car apparatus is so designed that these changes from trolley wires supplying one kind of current to the other can be made at full speed.

The method used for placing the hangers which support the trolley wire from the messenger wire is of interest because of the economy resulting therefrom. For this work the

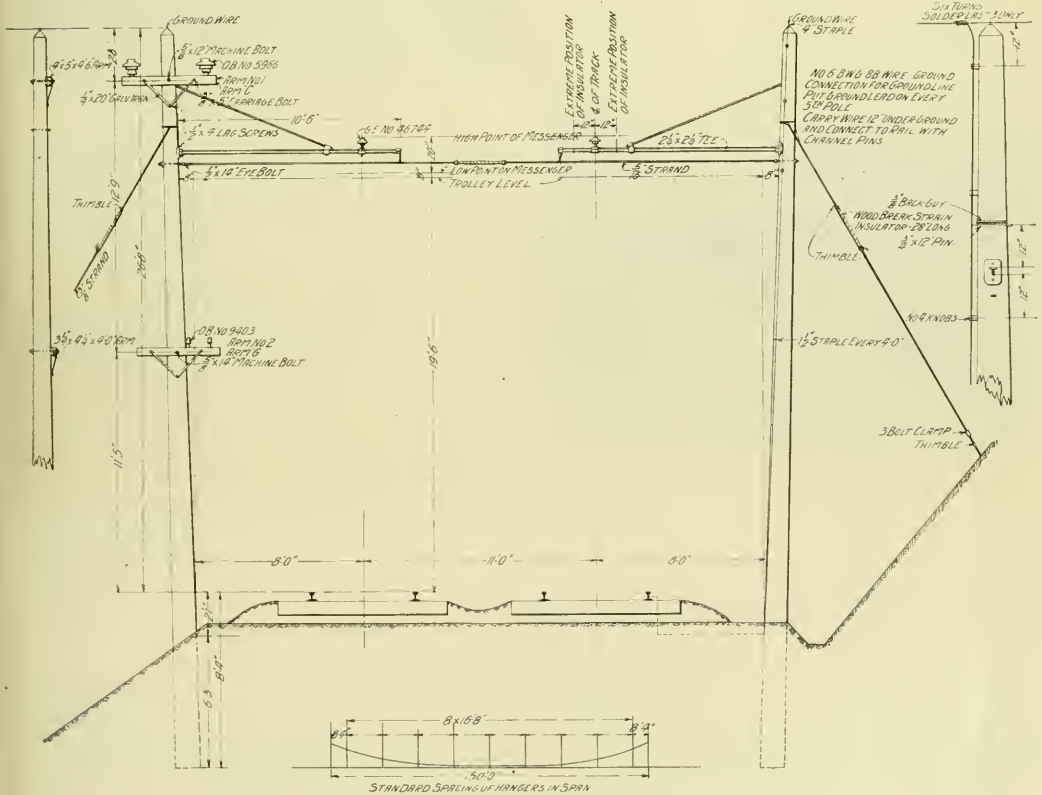
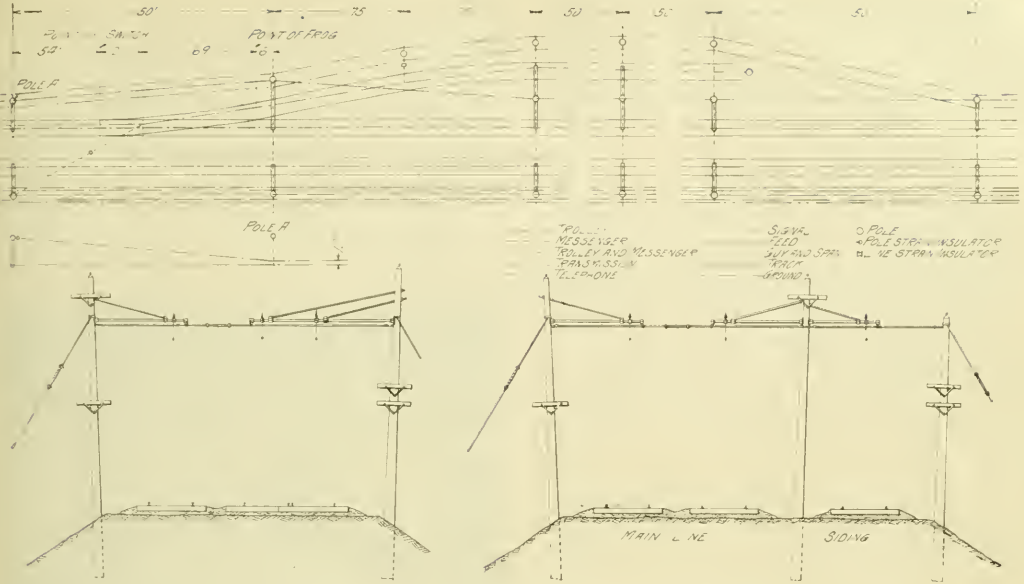

construction force used a train of five box cars attached to a heavy steam locomotive. Thirty men were spaced along the tops of the cars. Each man was provided with and placed only one length of hanger, so that the disposition of material was greatly simplified. With 150-foot spans and nine supports between poles five different lengths of hangers were required. With a gang working as described about four miles of trolley was hung each day.

#### Current Distribution.

Current for the operation of the entire line is purchased from the Potomac Light & Power Company, which operates the Bennings station. This generating station (see Electric Railway Review, June 8, 1907, page 747) is located on the line of the new road, so that no difficulties were encountered in delivering high-potential current to the transmission line on the private right of way.

The high-tension transmission line comprises two No. 00 copper wires supported at the top of one of the trolley pole lines. The insulators are of triple-peticoat porcelain construction, with a maximum diameter of 8¾ inches and a height of 7¼ inches. They are supported on 9-inch oak pins.

The transmission and trolley line fittings were supplied part by the Ohio Brass Company and part by the General Electric Company. The latter company supplied the messenger wire insulators, catenary hangers, steady braces and section insulators. The other material for the various services in the overhead and transmission system, including Detroit trolley wire clamps and Miller guy anchors, was supplied by the Ohio Brass Company.

#### Substations.

The current as delivered to the railway company substation in Washington is at 6,600 volts pressure, three-phase, 25-

Here the potential is stepped down by four transformers of like capacity and fed to the trolley wires extending four ways from the junction. The substation which is illustrated is of ample size to receive two more transformers.

To provide direct current for the shops and yards at the junction and for the street trackage in Baltimore and Annapolis there are two synchronous motor-generator sets in substations at each of these places. These motor-generator sets take 6,600-volt current from the trolley at 6,600 volts and regenerate it as 600-volt direct current.

The units at Baltimore and Annapolis have 300-kilowatt single-phase motors, while those in the Naval Academy Junction substation have two-phase motors. Normally these operate on the secondaries of the step-down transformers for one



Washington Baltimore & Annapolis—Waiting Room in Baltimore Terminal Station.



Washington Baltimore & Annapolis—Concrete Subway at Baltimore Entrance.

cycle. How this current is transformed, distributed and delivered to the cars from the overhead conductor is shown graphically by the circuit diagram and the mileage and copper diagram which are presented herewith.

There are two feeding points which serve the entire mileage operated by alternating current. These are at the Washington and Naval Academy substations. As stated, current at Washington is received at 6,600 volts, three-phase. By means of Scott connected one-to-one transformers the Washington end of the two trolley wires are fed with 6,600-volt current. For the remaining portion of the line a bank of 800-kilowatt oil-insulated water-cooled Scott connected transformers step up the current to 33,000 volts pressure for transmission to the Naval Academy Junction substation, 18.06 miles distant.

phase and on the incoming trolley from Washington for the other phase. They operate equally well, however, on either single phase. There is a tendency for these machines to balance the voltage between the two phases, which feature is valuable under some conditions of loading.

All the substation apparatus is of General Electric manufacture.

#### Telephone and Signal Systems.

The telephone system comprises a pair of No. 10 galvanized-iron wires mounted on 3 by 3½ inch brown porcelain 5,000-volt insulators and having connected to this pair at each station and at booths along the lines Kellogg Switchboard & Supply Company telephone sets with 5-bar generators and 2,000-ohm ringers. The telephone wires have a single-pin transposition on every fifth pole. Each set of telephone instruments is protected from high voltages by a General Electric 109-Y one-to-one telephone transformer.

On the east and west line from Annapolis to Annapolis Junction Blake signals, supplied by the Blake Signal & Manufacturing Company, Boston, Mass., are being installed. The main line will be protected by automatic electric block signals. The interlocking equipment at Naval Academy Junction tower, shown in the illustration, was supplied by the General Railway Signal Company, Rochester, N. Y.

#### Rolling Stock.

The passenger rolling stock equipment comprises 19 cars for limited service and 4 for local service. These cars were described and illustrated in a very complete article by E. P. Roberts, president of the Roberts & Abbott Company, in the Electric Railway Review for October 12, 1907, page 438.

The detail dimensions of the limited cars are as follows: Length of body over corner posts, 51 feet 1¾ inches; length

over spring buffers, 62 feet 2 3/4 inches; length of smoking compartment, 12 feet 7 5/8 inches; length of general compartment, 38 feet 6 1/8 inches; width of car body, inside, 8 feet 3/4 inch; width over all, 9 feet 3/4 inch; height from bottom of side sill to top of monitor roof, 9 feet 6 inches; height from rail to top of monitor roof, 13 feet 1/2 inch. The weight of the car body is 40,000 pounds and the total weight of the fully equipped car is 97,200 pounds.

Because of terminal conditions it was necessary to adopt

The main passenger compartment has a seating capacity of 50. The smoking compartment is located at one end of the car and has seats for 16 passengers. In one corner of this

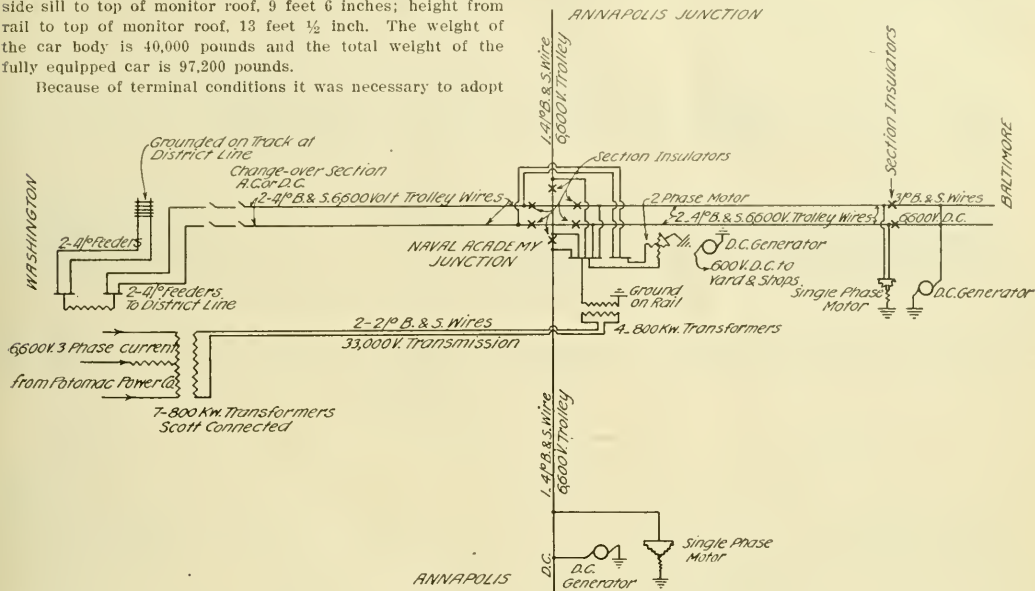

Washington Baltimore & Annapolis—Circuit Diagram, Showing Connections for Distribution and Transmission Systems.

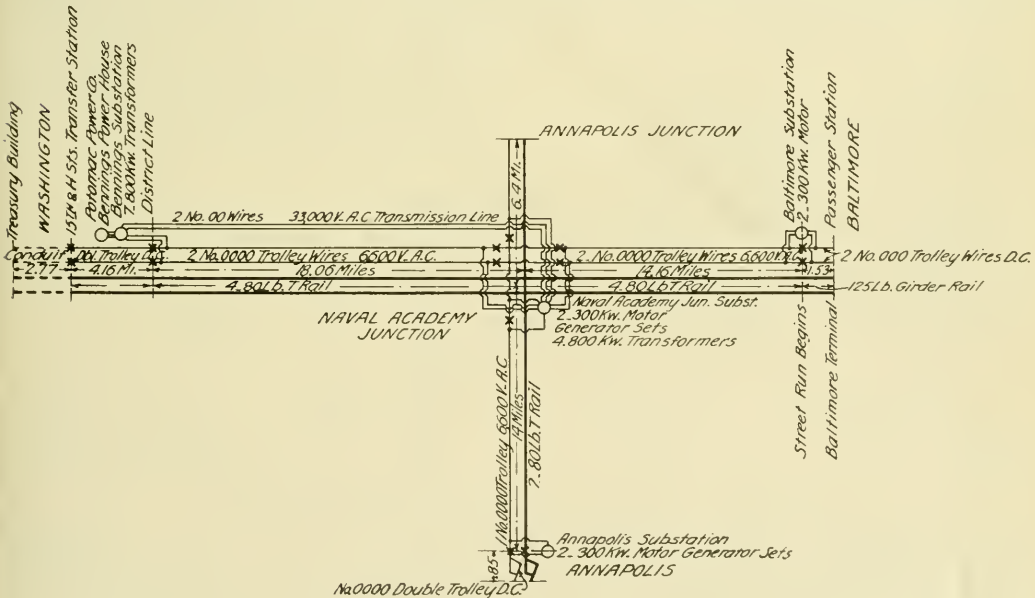

Washington Baltimore & Annapolis—Mileage and Copper Diagram, Showing Lengths and Interconnection of Electrical Circuits.

double-end cars. Both end platforms have doors and steps on each side and vestibule doors for the convenience of the crews when operating cars in trains. The toilet room is adjacent to the vestibule of the main passenger compartment.

compartment is placed the high-tension cabinet, containing the protective and selective apparatus for the motor control circuits. The seat spacing is unusually liberal and the seats are long, with arm rests and high backs.







a Lovell window-operating device, supplied by the G. Drouvé Company, Providence, R. I.

The truck and machine shops are served by an overhead crane of 15 tons lifting capacity. The crane has four electric motors and an auxiliary hoist. It was built by the Whiting Foundry Equipment Company, Harvey, Ill. The very complete equipment of machine tools was purchased from the Niles-Bement-Pond Company.

The track arrangement of these new shops is of especial interest. Outside the building the storage tracks for cars in

If it is desired to change the trucks under a car the car is placed in the shop so that the trucks to be replaced stand on the transfer table. Then with the overhead crane the body is lifted just high enough to let the wheels clear the truss rods. The transfer table can then be moved by hand, out from under the car body, taking the trucks on it. These can be run on to another track and a different set placed on the transfer table. Then the table and trucks are moved under the car body ready for it to be lowered again. A decided advantage in this method of truck replacement is that

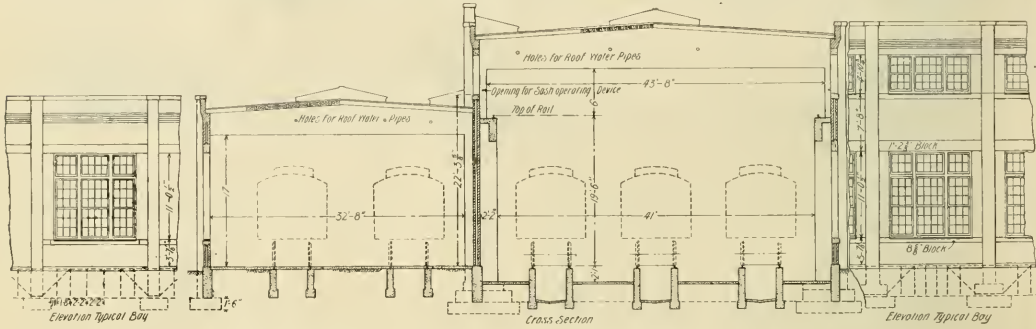

Washington Baltimore & Annapolis—Section Through Part of Repair Shops.

daily use are served by alternating-current trolley wires, while the shop and adjacent tracks have trolley wires carrying 600-volt current. Switches in the nearby substations control the current supply to the yards and shop buildings.

The track layout in the various divisions of the shops is shown in the accompanying floor plan. In the inspection and

for removing the trucks it is not necessary to lift the car body so high that the trucks will clear the steps, but only high enough so that the wheels will clear the truss rods.

The Washington Baltimore & Annapolis road has been built for high-speed operation. The territory is one from which little but through traffic may be expected for some time

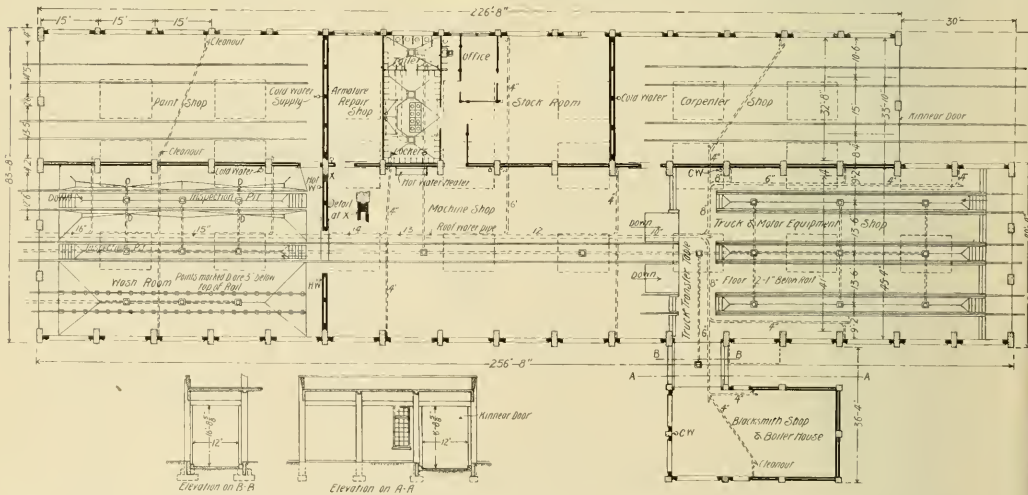

Washington Baltimore & Annapolis—General Floor Plan of Repair Shops.

wash room the concrete floor is sloped so that rapid drainage is provided. One track in this department is raised about six inches above the floor level, so that water will run under the rails. The other two tracks are provided with pits. All tracks ending in the shops are provided with Ellis bumping posts.

One track extends through the wash room, machine shop and truck shop. In the latter shop there are three pit tracks and a truck transfer table, as shown in the foreground.

to come, and as the competing steam railroad service between Baltimore and Washington offers 123 trains each day, one-hour running time, the necessity for high speed is apparent. The new road will, when fully in service, operate cars between the Baltimore and Washington terminals, 38 miles, on a 15-minute headway, making the run in one hour, including the time required to operate over the 4.5 miles of track in the District of Columbia, owned by the Washington Railway & Electric Company. The Washington terminal is at Fifteenth and E

streets, N. E., where passengers will be transferred free to the H street urban line. The Baltimore terminal building of the electric railway is at the corner of Park avenue and Martin street, near the heart of the retail shopping district.

**Rates of Fare.**

The steam railway fares between Washington and Baltimore are \$1.00 one way and \$2.00 round trip, except on Saturday and Sunday, when an excursion round-trip ticket is sold for \$1.25. The electric railway fares will be 75 cents one way and \$1.45 round trip, tickets to be good until used.

Between Annapolis and Washington, about 38 miles, the electric railway will operate four trains per day each way, charging 75 cents one way and \$1.25 round trip. The steam roads charge \$1.20 one way and \$2.00 round trip for the same mileage.

The rates of fare between Baltimore and Annapolis, 29 miles, have not been decided.

**ADVERTISING CARDS ON THE INLAND EMPIRE SYSTEM.**

We have received from Charles E. Flagg, department of publicity of the Inland Empire System, Spokane, Wash., copies of two display cards issued with the idea of educating

**MEETING OF THE CENTRAL ELECTRIC ACCOUNTING CONFERENCE.**

The meeting of the Central Electric Accounting Conference was called to order at 11 a. m. on Tuesday of this week at the Lima house, Lima, O., by the chairman, M. W. Glover, auditor Ohio Electric Railway, Cincinnati. Mr. Glover spoke of the many expressions of opinion which he had received, favoring the continuance of the conference, and said that responses to his letters of invitation to be present at the Lima meeting had been received from a number of accounting officers who would not be able to attend this meeting, but hoped to be at future meetings.

**Freight Claims.**

The first business before the meeting was the consideration of an agreement for the handling and settlement of overcharge and loss and damage freight claims between carriers. After discussion, rules were adopted. An abstract of some of the loss and damage rules follows:

Claim for concealed loss shall be prorated on revenue, initial point to destination. Such claim shall be verified in manner satisfactory to the paying carrier.

Claim for unlocated loss shall be prorated on revenue from point where freight is last checked in full and in good order to point where loss is discovered.

Claim for concealed damage shall be prorated on revenue, initial point to destination. Such claim shall be verified in manner satisfactory to paying carrier.

Claim for unlocated damage shall be prorated on revenue from point where freight was last checked in good order to point where damage is discovered. When delivering carrier loads freight at junction point and checks it in good order, and receiving carrier re-checks and finds freight damaged, or finds loss arising from damage, under delivering carrier's seals, claim shall be divided between delivering and receiving carriers, 50 per cent each. Claim for unlocated damage by overflow from the clogging of ice boxes, or drip pipes, shall be prorated on revenue from point where car is first iced to point where damage is discovered. Freight in car furnished by refrigerator car

company, under contract to provide refrigeration, is expressly excluded from the provision of this paragraph.

Claim arising from delay shall be charged to carrier with which delay is located. When delay is located with two or more carriers, claim shall be charged to such carriers, each carrier being charged with such proportion thereof as delay located with it bears to entire delay.

When freight reaches destination in visibly good order, and is unclaimed or refused, and has to be sold for charges and expenses, and proceeds of sale do not cover same, deficit shall be prorated on revenue by carriers interested in transportation charges, unless it is clearly shown that the deficit is the result of negligence of one or more carriers in the line.

Where a shipment received from another carrier is found to have been damaged by wreck or otherwise, necessitating a return to the shippers for repairs, no charge shall be made for the return movement, provided shipment is returned by the same route it was forwarded, reference to the original billing to be shown on return billing.

The following rule applies to loss and damage and overcharge claims:

No charge shall be made by one carrier against another when the entire proportion beyond charging carrier is less than 25 cents, except that in cases of misrouted shipments through error of carrier's agent, there shall be no minimum; and except as specifically provided for in another rule or ruling. No correction shall be required in bill rendered or authority issued, for any clerical error less than 25 cents.

Other rules concerning overcharges follow:

When claim for overcharge caused by erroneous classification is presented, and it is supported by bill of lading or receipt for freight, published classification and original invoice,

Advertising Cards on the Inland Empire System—Large Card.

people who glance at the poster to memorize the principal points reached by the system. The larger card, which is reproduced herewith, shows the map, which is the sole feature of the smaller card. The larger cards will be used for street railway advertising and the smaller cards will be framed and placed in the cars of the system and in stations, hotels, etc.

**New Sanitary Regulations for Kentucky Street Cars.**

The Kentucky state board of health has instituted a campaign for better sanitary conditions in the street railway cars operated in the various cities of the state and after conferences with local health officers and railway officials has issued a new set of regulations. The officers of the Louisville Railway have offered to co-operate with the board in every way. The regulations adopted by the board are as follows:

"First—All cars operated are to be disinfected once daily by the formalin and permanganate of potassium method or by such other system as may be regarded safe and hygienic by the board. No car not regularly used is to be sent out on duty until duly disinfected as above directed.

"Second—At the termini of each half trip each car is to have both front and rear doors opened for at least two and one-half minutes, or during the time when running the last square of trip.

"Third—Operatives are to be enjoined, and directed to enforce, the various city ordinances, and the regulations of this board in reference to expropriation.

"Fourth—Each car operated is to be thoroughly scrubbed or otherwise rendered clean daily.

"Fifth—Cars must be properly ventilated and heated.

or certificate of delivering agent, it may be settled, and the other carriers in interest will be obligated to pay their proportions of the amount so paid; provided, however, that no deduction shall be made in the advanced charges back of a rebilling point without a full knowledge of what they represent.

When claim for overcharge caused by erroneous rate is presented, and it is supported by published tariff in effect at time of shipment, which has been accepted by all parties in interest, it may be settled, and the other carriers in interest will be obligated to pay their proportions of the amount so paid.

When claim for alleged overcharge is presented, supported by bill of lading, or receipt for freight, naming unauthorized rate, it shall be referred at once to the carrier the agent of which made such unauthorized contract. Such rates shall not be protected.

Overcharge arising through error of agent or other employe through improper routing or waybilling, shall be paid by the carrier employing such agent or employe, except that when contributory negligence on the part of other carriers can be shown, claim shall be charged to the carriers at fault upon the basis of revenue.

All undercharges occurring through errors in the original division of earnings, which are discovered in handling overcharge claims, shall be credited to the carriers to which they belong in the final apportionment; provided the amount is in excess of the debit minimum and cannot be adjusted through interline freight account settlement.

When an amount is recovered from any carrier through due process of law, such amount and all costs and special attorney fees shall be settled under the appropriate rule, provided that the carrier or carriers which, in course of investigation, signified willingness to participate in payment under appropriate rule, shall be exempt from participation in the expenses incident to litigation. The term, "due process of law," means any settlement by court or attorneys interested, after suit has been commenced, or before suit has been commenced, when general or principal attorney of carrier to which claim is presented advises in writing in claim papers that such suit cannot be successfully defended.

**Proceedings of Afternoon Session.**

At the afternoon session Frederic Nicholas, associate editor of the Electric Railway Review, spoke on the subject of "Uniform Accounting."

It was decided that vouchers should be mailed on the last day of each month in settlement of interline ticket balances

OTHER  
STAMP

**THE OHIO ELECTRIC RAILWAY COMPANY,**

PART I - PREPAID ORDER - RECEIPT

No. \_\_\_\_\_

Station, \_\_\_\_\_ 190\_\_

Form No. 10

Received of \_\_\_\_\_ and \_\_\_\_\_ Dollars, \$ \_\_\_\_\_

For \_\_\_\_\_ Ticket, From \_\_\_\_\_ to \_\_\_\_\_ Route \_\_\_\_\_

To be furnished Mr \_\_\_\_\_ at \_\_\_\_\_ Ry Co.

who should be promptly notified to call on Agent of \_\_\_\_\_ and be identified as the proper person to receive same \_\_\_\_\_ Agent.

**CONDITIONS.**

Money received on deposit by Agents of this Company for tickets and fare for prepaid orders is non-refundable. Prepaid orders are subject to the same conditions as tickets. This receipt is not valid unless countersigned by the Agent of the issuing company. This receipt is not valid unless countersigned by the Agent of the issuing company.

**Meeting of the Central Electric Accounting Conference—Form for Prepaid Ticket Orders.**

for the preceding month, the minimum amount to be \$1.00. Any balance of less than this amount would be carried over to the ensuing month.

The subject of prepaid ticket orders was fully discussed and it was finally decided to adopt a form recommended by Mr. Glover. This form is in four parts, an original and three carbon copies. Part 1, illustrated herewith, is delivered to the individual who makes the deposit for the ticket; part 2 is to be forwarded to the agent who is to furnish the ticket; part 3 is to be sent to the auditor, attached to the daily balance sheet; and part 4 is to be held by the agent for his office record.

The apportionment of interline tickets on a uniform basis was discussed, and Charles F. Price, general passenger agent Western Ohio Railway, who was present, was requested to ask the Central Electric Traffic Association to furnish statements of division of interline freight and ticket rates between

lines for use in the apportionment of revenues from such business. The sum of five cents was adopted as the minimum for correction of mistakes on the revenue from a single ticket. Complaint was made of the lack of uniformity in the apportionment of revenue by the traffic departments of connecting lines.

Chairman Glover was authorized to appoint a committee to procure blanks for the presentation of claims, freight and ticket accounts and other purposes, with a view to securing uniformity. This committee will report at the next meeting, which will probably be held in the latter part of May. It was suggested that hereafter the meetings be held at the same time as the meetings of the Central Electric Railway Association and the Central Electric Traffic Association; but in the discussion it developed that many of the accounting officers would be unable to attend the meetings on account of the absence of other officials, who would want to attend the sessions of the other associations. It was therefore thought that the best results would be attained by continuing the present plan of having the accounting meetings separate from those of the other associations. An effort will be made to arrange for a session lasting two days at the next meeting.

**Railway Representatives Present.**

- The following representatives of railways were present:
- Ohio Electric Railway—M. W. Glover, auditor; M. White, traveling auditor; F. A. Burkhardt, division passenger and freight agent; C. S. Carl, storekeeper; George Mayer.
  - Western Ohio Railway—R. H. Carpenter, auditor; C. C. Collins, general freight agent; C. B. Baker, freight auditor; H. H. Stephenson, assistant freight auditor; E. Riddle, traveling freight agent; Oliver Burgett.
  - Terre Haute Indianapolis & Eastern Traction Company—L. T. Hixson, auditor; T. C. Dodd, freight claim agent.
  - Indiana Union Traction Company—Walter Shroyer, auditor.
  - Marion Bluffton & Eastern Traction Company—J. S. Clark, auditor; C. H. Shaffer, local freight agent, Bluffton, Ind.
  - Ft. Wayne & Springfield Railway—A. G. Kelly, auditor and general passenger and freight agent.
  - Ft. Wayne & Wabash Valley Traction Company—H. E. Vordermark, auditor.
  - Indianapolis & Cincinnati Traction Company—W. B. Wright, auditor.
  - Toledo & Chicago Interurban Railway—William Robins, auditor; G. M. Patterson, general freight and passenger agent.
  - Toledo Urban & Interurban Railway—W. L. Smith, superintendent; C. J. Laney, assistant general freight agent; W. I. McClure, auditor.
  - Muncie & Portland Traction Company—E. J. Skehan, auditor.
  - Lake Shore Electric Railway—A. C. Henry, auditor.
  - Dayton & Troy Electric Railway—Cyrus Bucher, auditor ticket accounts; L. D. Johnson, general freight agent.
  - Springfield Troy & Piqua Railway—Gus Kohler, auditor.
  - Southeastern Ohio Railway Light & Power Company—William H. Neikirk, auditor.
  - Toledo Railways & Light Company—A. J. Lamb, chief clerk.

J. L. Blake, general manager of the Ft. Dodge Des Moines & Southern Railroad of Boone, Ia., in an address at Humboldt, Ia., last week, declared that the time had passed when interurban companies would buy right of way and expend large sums of money for the privilege of building lines. He said that hereafter the companies would demand more co-operation from the property owners interested and urged that the farmers and business men of communities desiring interurban lines go to the electric railway builders with a proposition to furnish the right of way and grade the roadbed in return for stock. He suggested that they organize according to districts for this work. "With this method," said Mr. Blake, "there is no reason why any well-populated section of Iowa should be without an interurban line."

The Pittsburg & Butler Street Railway last week began operating its cars over the tracks of the Pittsburg Railways Company to Sixth street and Penn avenue. At present only the limited cars, which run every two hours, enter the city, but it is expected that the local cars soon will do likewise.

**PAY-AS-YOU-ENTER CARS FOR THE PUBLIC SERVICE RAILWAY.**

The Public Service Railway expects to place in operation early in March on its Newark, N. J., lines a portion of an order for 150 pay-as-you-enter cars which are now nearing

successful operation in Montreal, Chicago and Buffalo, which have been previously described in the Electric Railway Review. They are single-end cars with little variance in the dimensions of the front and rear platforms from the Montreal cars and have two or three new features which are not found on any previous cars of this type. The body of the car over

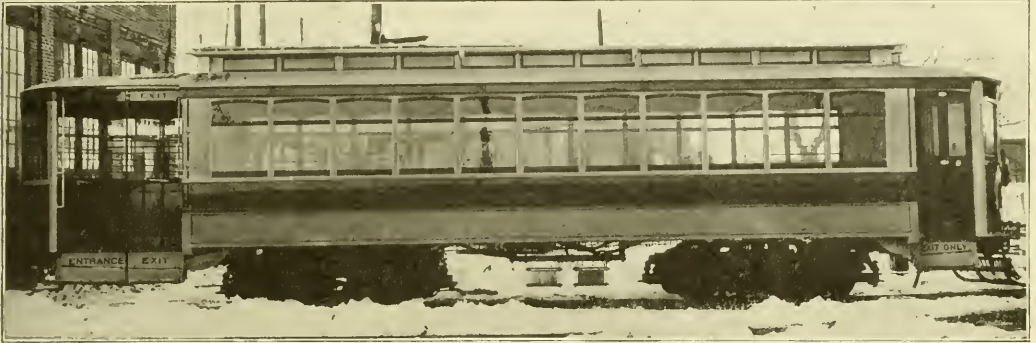

Pay-As-You-Enter Cars for Public Service Railway—Side View.

completion at the works of the Cincinnati Car Company. The first car of this type was received at the Plank Road shops of the company on February 15 and will be operated over the Newark lines during the next two or three weeks

corner posts has a length of 30 feet 8 inches with a 5-foot platform in front and an 8-foot rear platform, making the total length of the car 43 feet. The cars are of the convertible type, the window dropping into a socket in the side of the



Pay-As-You-Enter Cars for Public Service Railway—Rear Platform.



Pay-As-You-Enter Cars for Public Service Railway—View of Front Platform.

for the purpose of thoroughly familiarizing the motormen and conductors with the operating features essential to this type of equipment and also to give the public an opportunity to become sufficiently acquainted with the method for collecting fares so that when the new cars are used exclusively little trouble will be experienced.

The cars in general are not dissimilar to those now in

car, and all the glass is set into the sashes with rubber filling. Twelve Hale & Kilburn cross seats are placed in the center of each car and two longitudinal seats are located at each end, giving a seating capacity of 40 passengers. Push buttons have been installed for the convenience of passengers as well as the more ordinary bell cord to the motorman's cab. The hand straps instead of being movable and hung

from a stationary pole are securely fastened at intervals of about two feet, the object being to secure a more even distribution. The interior finish is of cherry, which is standard on this road.

#### Motorman's Cab.

In the arrangement of the motorman's cab some changes have been made from the plans usually employed. At the extreme left and close to the bulkhead a Jewell No. 60 stove is installed. This is connected to a radiator placed just inside and near the roof of the car, from which the supply of air can be regulated. The location of the stove thus provides a means of keeping the cab at a comfortable temperature. The sandbox is located between the side of the stove and the front of the cab. The controllers are placed a few inches to the left of the center of the cab to provide the necessary space for the operation of the lever controlling the exit door. This lever is fastened to the front of the cab and, operating horizontally, controls two hinged doors which are locked at right angles to the side of the car when open. There are no grab handles on the inside of the front door and it can only be opened by the motorman's lever. There are no grab handles on the exterior of the front end of the car, the presence of which might be the cause of an accident to someone unfamiliar with this type of car, in trying to gain entrance through the front end. The closing of the front exit door automatically locks it so that it is impossible to enter.

#### Rear Platform.

The rear platform is divided by two railings, one separating the entrance and exit doors, behind which the conductor stands, as in the usual pay-as-you-enter car, and the other running parallel with the end of the car at about two feet distance, behind which smokers may stand without blocking the entrance. This space will accommodate six passengers, but standing on the platform will be discouraged as far as possible after fares have been paid. The entrance door swings inward and the exit door is of the sliding type, being controlled by a lever fastened to the body of the car within convenient reach of the conductor. This door, unlike the exit door on the front platform, can be opened by a passenger from within the car as well as by the conductor, but the conductor can at will prevent the opening of this door by keeping his hand on the lever. This may be desirable where an aged person is trying to get on the step before the car has come to a stop. With the conductor always at his position on the rear platform and both exit doors under control by employees it is hoped that accidents will be reduced to a minimum. At the shops of the Cincinnati Car Company the rear platform was tested by putting upon it 39 persons. It was found that the platform easily withstood the strain and could safely accommodate that number of people, so that in districts where traffic is congested at certain hours of the day few delays would occur in waiting for passengers to board.

It has not been definitely decided at this time just what type of fare box will be adopted. Sterling-Meaker registers have been installed and it is the plan of the company to have the fares registered by the conductor pressing with his heel a small plate connected with the register, but the exact method to be used in collecting the fares has not yet been decided.

#### Equipment.

The car is equipped with four Westinghouse No. 101 quadruple motors, Brill No. 27-G trucks and General Electric independent air brakes. The destination signs are of the Hunter illuminated type. The marker lights are the Nichols-Lintern type.

The words "Pay As You Enter" will be painted on the right side of the front of the car with either yellow or white letters on a background of red. It is thought that this will facilitate matters a great deal, especially when strangers not

familiar with the operation of the cars are boarding. There are many foreigners in the locality served by this company that cannot read or understand the English language and the large red space, which does not appear on any other type of car of this company, will be a guide to what they may expect in boarding the pay-as-you-enter car.

#### BOOK TABLE.

**Standard Handbook for Electrical Engineers.** Written and compiled by a staff of specialists. New York, 1908. McGraw Publishing Company, 239 West Thirty-ninth street. Flexible leather, 1,300 pp., 4 by 7 in. Price, \$4.00.

Practice in electrical engineering changes so frequently that it is not possible for text books on the subject to be kept up to date, but the latest ones from good authors are usually the most valuable.

The Standard Handbook is intended to be an improvement on other electrical handbooks published in this country and abroad, and in some respects this claim has been well sustained. The work of preparing the material has been assigned to 12 different authors, each of whom has made a specialty of his particular department. The book attempts to cover the entire field of electrical engineering and is divided into 20 sections, each of which is a complete and self-contained treatise on the subject covered by its title.

The section on materials contains much conveniently arranged information on conducting and insulating materials. The section on the design of electrical apparatus is up-to-date in its treatment of the design of transformers, motors and generators, and the constants taken are made from the best practice of the largest manufacturers. The standard practice of transmission line design and construction has been given its proper share of treatment, and several valuable tables are here added to the literature of the subject. There is a large amount of data concerning the cost of materials and labor, based upon recent prices. The report on standardization of the American Institute of Electrical Engineers is brought up to as late a date as October, 1907. The section on electric traction is particularly valuable, as it was written by one who had unusual opportunities for obtaining the best information on the subject, and it may be regarded as an important addition to the literature of modern traction practice and a satisfactory treatise on the entire subject. In this section will be found a large amount of data combined and condensed in the form of curves, much of this information being given to the public for the first time. The sections on transformers, generators, motors and electro-chemistry are all treated in a satisfactory manner, and supply constants for use in design which have not heretofore been available.

The mechanical construction of the book is fully up to the best standards for engineers' pocketbooks in regard to the quality of the paper, binding and printing. The index is unusually full, comprising 54 pages of the book and having 6,000 references. The arrangement combines the alphabetical and topical methods. The most decided departure from the usual method in indexing is the method of dividing the book into sections and paragraphs and referring to these as units instead of to pages. Taken altogether the Standard Handbook is the most satisfactory one for electrical engineers thus far published.

Electric car service was started on the First avenue line of the New York City Railway on January 5, from the Willis avenue bridge over the Harlem river at One Hundred and Twenty-fifth street to Fourth street. The horse car service on this line was abandoned on July 1 and the change to electric motive power was expected to be completed by October 1, but the work was suspended on account of the receivership. Horse car service will be continued on First avenue south from Fifty-ninth street.

**MERIT SYSTEM AND OFFICERS' AND EMPLOYEES' ASSOCIATIONS OF FT. WAYNE & WABASH VALLEY TRACTION COMPANY.**

Both the efficiency of the service and the welfare of employees are promoted by the associations which have been created by the Ft. Wayne & Wabash Valley Traction Company, Ft. Wayne, Ind., under the direction of C. D. Emmons, the general manager. The associations are three in number: The Officers' association, which acts on questions of operation; the Superintendents' association, which considers matters of discipline; and the Employees' Mutual Benefit association, which provides relief and death benefits and is designed also "to promote social relations and good fellowship among the members, and the best conduct of the business of this company for the mutual advantage of the association and the company."

A vital part of this successful inner organization of the company is the merit system, applicable to all lines, which was adopted on January 15, 1908, as a change in the method of discipline "to better promote the interests of this company and employes and at the same time discipline such employes on their individual performance."

The official announcement concerning the new method of discipline and the list of merits and demerits for motormen and conductors have been given to us by Mr. Emmons and are as follows:

**The Merit System.**

1. The new method of discipline is what is known as the merit system and is introduced with the belief that it will be a benefit and that it will meet with the approval and cordial co-operation of all concerned.

2. The objects to be obtained under the new system are: (a) To avoid a loss of wages by persons employed and suffering to those dependent upon their earnings. (b) To stimulate and encourage employes in the faithful and intelligent performance of their duties.

3. Under this system a certain number of marks will be entered against the record of each employe for violation of rules, etc., instead of suspension, as formerly. The "Discipline" committee of the Superintendents' association will administer such discipline.

4. Where demerits are given for unsatisfactory service it is logical that merits should be given for good service; and merit marks will be credited on an employe's record whenever possible. In addition a prize of \$25 will be awarded to the conductor and to the motorman having the best record at the end of six months. If more than one conductor or motorman have an equally good record at the end of six months the prize will be divided equally among them. The first prizes will be awarded on July 1, 1908.

5. Each employe will be notified in writing of any favorable or unfavorable entry against his record, the reasons therefor, and the number of marks given.

6. Whenever merit or demerit marks are given a notice will be posted stating how many marks have been given and on what charge, but omitting name, date, train or location.

7. When an employe's demerits have reached the number of 90 he shall be called in by the superintendent, duly cautioned and advised that when his demerits amount to 100 he will be subject to dismissal from the service.

8. Employes will be permitted to examine their record at any time upon application.

9. All employes affected by this system of discipline shall start on an even basis, that is, without merits or demerits.

10. This company reserves the right to discharge any employe under this system.

**Immediate Discharge.**

Disloyalty to the company, intoxication, dishonesty, false statements.

**Demerits.**

Incompetent or unsatisfactory service	10-100
Disobedience of rules governing railroad crossings	10-100
Failing to report accidents	10-100
Smoking on duty	10
Incomplete and poor accident reports	1-20
Inattention to passengers	1-10
Failing to show up or report for duty:	
First time in one month	10
Second time in one month	20
Third time in one month	30

Dirty car	5
Untidy condition of dress	2
Reading on duty	10
Unnecessary conversation when on car	5
Drinking intoxicants or frequenting saloons at any time	10-50
Accidents when avoidable	10-100
Ungentlemanly conduct	5-100
Disobedience of orders	10-100
Gambling	50
Bad judgment on special occasions	1-25
Criticizing management of road	50
Talking about accidents to others than proper officials of the company	20
Failure to report negligence or delays	2-10
Failing to protect trains	10-50
Carelessness in taking or transferring order	2-50
Signals improperly displayed or failure to notice and answer signals	2-50
Overrunning an order or getting on the time of another car	10-100
Carelessness with switches or derails	2-50
Running ahead of schedule	10-100
Running away from passengers	5-30
Careless or indifferent operation of car	5-25
Backing car without proper signals and protection	10-25
Injury to equipment caused by improper handling	10-50
Failure to report trouble or any defects with car, roadway or overhead	5-50
Acts detrimental to good service	3-20

**Motormen's Special Demerits.**

Running over circuit-breakers with current on	1-5
Allowing unauthorized persons to ride in vestibule	1-10
Headlight not burning according to rules	1-10
Feeding current too fast	10
Failing to whistle or ring gong in proper place	10
Starting car without proper signals, except to avoid collisions	10-25
Following car in front too close	10-25
Running too fast when within city or yard limits or over special work	5-25
Flattening wheels except to avoid collisions or accidents	5-20
Reversing car, except to avoid accident	25
Failure to observe stop, slow or caution sign	5-50
Improper use of air	5-10
Splitting switch	5-100
Using current with brake set	5-25
Running too close to wagons	5-25
Leaving car without taking reverse lever, throwing overhead or pulling line switch	5-25
Not obeying conductor's signals	0-25
Seated while operating car, except where permission is specifically granted	25
Running ahead of time	10-100

**Conductors' Special Demerits.**

Errors in taking register impressions or readings	1-10
Errors in punching transfers	1-5
Missing fares	5-25
Failing to ring up fares	10-50
Carrying people free	5-50
Repeated mistakes in report to auditor	5-25
Inattention to passengers	1-10
Bad judgment and carelessness in regulating heat or ventilators on car	1-10
Carelessness in using hat checks	5-25
Failing to cancel tickets	1-10
Bunching fares	5-25
Failure to turn in report and money on time	5
Sitting down while on duty, unless at authorized points	5-25
Riding inside of car when not necessary	5-25
Failing to hold trolley where necessary	5-25
Failure to be supplied with tickets, transfers and other necessary supplies	5-25
Failure to give proper signals	5-25
Failure to call stations, streets or public places	5-25
Punching transfers to permit passengers taking extra time	1-10

**Merits.**

Warning persons when in the act of jumping to or from a moving car, thus preventing accident	1-25
Assistance rendered in case of accident, such as to bring commendation from passengers	1-25
Securing the names and addresses of witnesses who saw the accident, other than those on report	5-25
Informing company of matters in the interest of good service	5-25
Politeness and attention to passengers	1-5

Reporting defects in equipment, track or line.....	5-25
Complete and perfect accident reports.....	5-25
Good judgment and work in handling blockades or on special occasions .....	5-25
Neatness in personal appearance.....	1-10
Striving to keep car neat and clean, lamps, windows, etc.	1-10
Good reports from barn foreman as to care of car equipment .....	1-25
For driving stock out of right of way.....	1-10
Using good judgment with sander.....	1-5
One month without demerits.....	5
Proper adjustment of windows, shades or ventilators..	1-5
Keeping car at proper temperature.....	1-5
For any meritorious acts, which in the opinion of the discipline board deserve recognition.....	1-100

#### Motormen's Special Merits.

Careful handling of car during previous month.....	5-25
Good stop to avoid accident.....	5-25
For bringing in defective car without tying up line.....	5-25

#### Conductors' Special Merits.

Handling boisterous, unreasonable or drunken passengers with tact and judgment.....	1-25
Special attention to ladies, children or old and infirm persons .....	1-25
Perfect reports to auditor for one month.....	5-25

#### The Employees' Benefit Association.

The Employees' Mutual Benefit Association of the Ft. Wayne & Wabash Valley Traction Company was organized on October 1, 1907. Mr. Emmons informs us that 85 per cent of the employees of the company are members of the association. Its affairs are administered by a board of trustees, consisting of a chairman and six members, who are: C. D. Emmons, general manager, chairman; H. E. Vordermark, auditor; C. F. Guild, superintendent light and power department; H. L. Weber, chief engineer; H. Bitings, motorman on Lafayette city division; H. J. Waggoner, conductor on Ft. Wayne city division; and N. K. Smith, motorman on interurban division.

The trustees meet monthly and at their last meeting it was shown that since the organization of the association \$500 had been disbursed for relief of members, and that there is now \$1,000 in the treasury. The employes have requested that they be permitted to pay double dues, if they desire, and receive double benefits. An abstract of some of the principal articles of the constitution follows:

The membership shall be limited to employes now or hereafter employed by the company. Such membership shall cease when a member leaves the employ of the company unless terminated prior thereto.

Any member in good standing is entitled to the following benefits when the necessity for such is not due in any way to intemperate or immoral conduct. Payments while totally disabled or unable to labor by reason of accident, to the amount of 75 cents for each day so disabled, beginning with the first day of accident upon which wages are not earned, and for a period not exceeding 120 days in any one year, and provided that if upon the decision of the medical examiner a member shall have returned to duty after such accident, and shall again be disabled or unable to labor because of sickness resulting from accident within less than two weeks from his return to duty, such disability shall be computed with the prior one in computing the 120 days for which payments may be made. Payments while totally disabled or unable to labor by reason of sickness or injury other than accident in the company's service, to the amount of 50 cents for each day so disabled, after the first seven days, and for a period not exceeding 120 days in any one year; provided that if upon the decision of the medical examiner a member shall have returned to duty after such disablement or inability to labor because of sickness, and shall again be unable to labor because of sickness within less than two weeks from his return to duty, such disability shall be computed with the prior one in computing the 120 days for which payments may be made, and the deduction of seven days shall not be made therefrom. In the event of the death of a member, provided such death was not caused by intemperance or immoral conduct, there shall be paid to the person or persons designated by him, or, if there be no such person or persons, then to his executors or administrators, the sum of \$100. Accident and sick benefits shall be paid semi-monthly, and death benefits shall be paid within 30 days after filing with the secretary the proof of death.

The funds of the association shall be derived from con-

tributions of the Ft. Wayne & Wabash Valley Traction Company and the dues. For the several benefits, with the social privileges of the association, each member shall pay in advance 50 cents dues each month, to be deducted by the company from any moneys due such member, and paid by said company to the treasurer of the association. A member shall not be required to pay any dues for any time during which he is entitled to disability benefits, after the month in which the disability begins. If absent from disablement and the member shall recover in a month for which he has not paid, he shall not be required to pay dues for the remainder of that month, but will be entitled to payments for disability or death occurring during that month. The dues for a month or a part of a month are to pay only for the benefits secured to the members for disablement or death occurring in that month and subsequent to the date of payment, and those benefits are secured from month to month by a payment of monthly dues. Each month is to stand by itself and if service terminates at the end of a month nothing is to be returned to the member. If a member leaves the service before the end of the month there shall be returned to him a proportional part of said dues for the unexpired part of the month.

All money paid or received by the treasurer shall be deposited in one of the banks or trust companies in Ft. Wayne, and all money not needed for immediate payments of necessary current expenses, accident and sick benefits or death benefits shall be invested by the treasurer of the association under the direction of the trustees in such securities as trust funds may be invested in under the laws of Indiana.

The general manager of the company shall always be the president of the association. The vice-president, treasurer and secretary of the association shall be elected by a majority vote of the members present at the annual meeting of the trustees, from among their number. The president of the association shall be chairman of the board of trustees, and shall appoint three members of the board of trustees from the Officers' association of the company. The other trustees shall be members of the relief association, and shall be chosen annually in November, by ballot, to serve for one year.

Any employe of the company over 21 and under 45 years of age, both inclusive, who shall have been in the service for at least one month, shall be eligible to membership, upon approval as to his physical condition, upon payment of \$1.00 for initiation fee and dues for first month, and 50 cents dues for each and every month thereafter, and a further payment of 50 cents to the examining physician.

The applicant for membership is required to certify that he is correct and temperate in his habits and that, so far as he is aware, he has no injury or disease, constitutional or otherwise, which will tend to shorten his life, and that he is in good health and able to earn a livelihood. Concealment of facts would cause the forfeit of membership in the association. Other provisions follow:

Benefits will not be paid on account of accidents, sickness or death occurring at any place beyond the United States, or on account of death of an epidemic disease at any place where said disease is known to prevail to which duties as an employe of the company or his family relations do not require him to go. Benefits are not to be paid for disability arising from sickness contracted or injuries received while intoxicated, or from injuries received while engaged in unlawful acts, or sickness or death resulting from immorality, or from the intemperate use of stimulants or narcotics, or from death by the hands of justice.

#### Hydro-Electric Plant for Tokio, Japan.

The first 60,000-volt hydro-electric plant in Japan has just been put into service with signal success. Power is obtained by impounding the Ugigawa river, a narrow and swift but deep river, such as is often found in the mountainous portions of Japan. The normal capacity of the main station is 18,000 kilowatts, furnished by six 3,000-kilowatt 50-cycle 6,600-volt water-wheel-driven alternators.

The generator voltage is stepped up to the line voltage of 60,000 volts through three banks of three single-phase water-cooled 2,000-kilowatt transformers and is transmitted 25 miles to the Waseda substation, just outside the city of Tokio. In this main substation water-cooled transformers of 1,800 kilowatts each step the line voltage down to 11,000 volts, at which potential it is transmitted underground through lead-armored cables to 11 distributing substations situated in various parts of the city.

In each of these smaller substations oil-cooled transformers of 250 kilowatts capacity step the voltage down to 2,000 volts, the line potential of the city circuits.

The entire equipment, including the cable, was furnished by the General Electric Company.



**BONUS SYSTEM OF THE AMERICAN KOREAN ELECTRIC COMPANY.**

We have received from H. E. Colbran, general manager of the American Korean Electric Company, operating the street railways of Seoul, Korea, the particulars of a plan which the company has adopted of awarding to its conductors and motormen monthly rewards for good service. According to the system which has been in operation for some time monthly bonuses are awarded to the conductors who have turned in the largest number of fares during the month and to the motormen who have had no fatal accident during the month. In regard to the success of the plan Mr. Colbran says: "I am glad to say that the reward system quickly had its effect in increasing the passenger receipts, although the railway is equipped with cash registers on the cars and a proper spotter service is maintained. It was also promptly noticeable when the bonus system went into effect that the car service was much improved and that very considerably less accidents occurred."

Quarterly rewards were also given. It was recently decided to double these prizes, and the following notice, giving

No reward will be paid to any motorman or conductor for any month in which a fatal accident occurs.

No reward will be paid to any conductor or motorman for any month in which a clear case of stealing fares or giving free rides is found against any one conductor.

If a motorman causes an accident because of neglect or carelessness he will not receive any reward for that month, even though the accident occasions no fatal result.

No conductor or motorman will receive a reward for any month in which he is found to be drunk or to have in any way neglected his duties.

No reward will be paid to conductors or motormen whose cars are continually dirty.

Motormen are specially reminded to approach all bad street crossings slowly and to have their cars under perfect control in going down the steep grades. It will be to the growing interest of every employe to see that all employes do their work properly and honestly.

**Extensive Power Project in Washington.**

Announcement is made in Spokane that the Pacific Coast Power Company, recently organized by the Stone & Webster interests of Boston, Mass., will erect at the foot of Lake Tapps, near Spokane, Wash., at a cost of \$10,000,000, what is said to be the second largest electric power plant in the United

**EARNINGS AND EXPENSES OF STONE & WEBSTER COMPANIES FOR THE YEAR 1907.**

	Gross earnings.	Operating expenses.	Net earnings.	Interest charges.	Balance.	Dividends.
Blue Hill Street Railway, Canton, Mass.....	\$89,946.17	\$76,098.53	\$13,847.64	\$23,279.28	\$89,431.64	.....
Brockton & Plymouth St. Ry., Plymouth, Mass....	119,365.12	87,705.13	31,659.99	21,378.59	10,281.40	.....
*Cape Breton Electric Co., Ltd., Sydney, N. S.....	250,064.67	157,048.12	93,016.55	42,862.30	50,154.25	\$14,040.00
Columbus (Ga.) Electric Company.....	340,574.51	184,699.36	155,875.15	122,495.26	33,379.89	15,000.00
Dallas (Tex.) Electric Corporation.....	1,125,673.06	818,102.13	307,570.93	223,108.02	84,462.91	50,000.00
El Paso (Tex.) Electric Company.....	506,693.69	378,615.05	128,078.64	60,350.22	67,728.42	22,842.00
Galveston-Houston Electric Co.....	1,050,892.64	656,195.30	394,697.34	154,027.74	240,669.60	34,742.25
Galveston (Tex.) Electric Company.....	369,168.23	221,012.11	148,156.12	51,230.83	96,925.29	21,000.00
Houghton County Street Railway, Houghton, Mich.	249,919.22	155,917.79	94,001.43	47,449.10	46,552.33	12,000.00
Houston (Tex.) Electric Company.....	681,724.41	434,671.96	247,052.45	100,036.78	147,015.67	60,000.00
Jacksonville (Fla.) Electric Company.....	392,393.73	256,341.22	136,052.51	50,165.23	85,887.28	60,000.00
Northern Texas Electric Company, Ft. Worth, Tex.	1,060,953.56	623,572.22	437,381.34	128,503.23	308,878.01	149,400.00
Paducah (Ky.) Traction & Light Company.....	237,513.48	165,249.33	72,264.15	68,414.76	3,849.39	5,000.00
Pensacola (Fla.) Electric Company.....	228,149.95	151,880.75	76,269.20	40,904.41	35,364.79	18,000.00
Ponce Electric Company, Ponce, Porto Rico.....	120,087.49	73,704.22	46,383.27	29,586.69	16,796.58	.....
Puget Sound Electric Railway, Tacoma, Wash....	1,664,281.45	1,091,233.99	573,047.46	345,421.54	227,625.92	30,000.00
Savannah (Ga.) Electric Company.....	602,399.70	414,309.24	188,090.46	144,034.29	44,056.17	60,000.00
Seattle (Wash.) Electric Company.....	3,949,433.93	2,684,941.31	1,264,492.62	435,350.51	829,142.11	300,000.00
Tampa (Fla.) Electric Company.....	521,181.10	388,130.30	133,050.80	6,530.18	126,520.62	119,000.00
Whatcom County Ry. & Lt. Co., Bellingham, Wash.	354,469.22	210,441.80	144,027.42	77,516.56	66,510.86	13,236.00

\$Deficit.

\*Includes one-half of the earnings of Sydney & Glace Bay Railway Company, Limited.

the details of the plan, was posted in the carmen's assembly room:

The American Korean Electric Company is glad to be able to recognize the care which nearly all motormen and conductors have used in avoiding accidents and in operating the car service in a proper manner and has decided to double the prizes heretofore distributed every three months, commencing on January 1, 1908, first payments being made for the three months ending March 31, 1908.

In future the prizes awarded to the conductors will be as follows:

First prize.....	30 yen	Fourth prize.....	10 yen
Second prize.....	20 yen	Fifth prize.....	5 yen
Third prize.....	15 yen		

The sum of 80 yen will also be divided every three months as special prize money among such motormen as the assistant manager considers have used the greatest care in running their cars and in the general performance of their duties.

The present monthly rewards paid to all motormen and conductors properly performing their duties will be continued.

These rewards will be continued so long as the employes show that they are appreciated and that all are trying to see that the company is honestly and properly served by every employe, but they will be entirely stopped if any general stealing of fares occurs.

The bonuses will be paid subject to the following conditions:

They will be paid only when good service is given.

States, having ultimately a capacity of 100,000 horsepower.

The plant will be developed to 50,000 horsepower at first and subsequently will be increased to its maximum capacity, as fast as additional power is required for the proposed interurban system which will unite the cities of Bellingham, Everett, Seattle, Tacoma, Olympia and Aberdeen, Wash., and Hoquiam and Portland, Ore. It is stated that work will begin in a short time and that it will be rushed to completion. The Seattle-Tacoma Power Company, which controls extensive power rights on the White river, has been acquired. Jacob Furth, president of the Seattle Electric Company, has given out the following statement: "The Pacific Coast Power Company has acquired all the White river lands, so called, which have been the subject of so much recent litigation. This company will develop the property, but the detailed plans for its development have not yet been completed. The White river situation is one of the greatest power projects on Puget sound, and the present settlement of the disputes and litigations concerning it, thus insuring its early development, will be of the greatest benefit. It is expected that more than \$5,000,000 will be expended in the initial development."

The Twin City Rapid Transit Company, Minneapolis, Minn., will manage and operate the Tonka Bay hotel, the largest hotel at Lake Minnetonka, Minn.

# News of the Week

## Legislation Affecting Electric Railways.

**New York.**—A bill has been introduced in the legislature providing that all street cars outside of New York City shall be equipped with air or power brakes and that all summer cars shall have aisles for free ingress and egress of passengers.

**Ohio.**—Representative Hunt has introduced a bill which makes provision for the construction of an elevated railway in Cincinnati.—The Schmidt bill, which provides that franchises may be granted to new companies over routes that have been occupied within a year by an old company, without obtaining new consents from the owners of abutting property, has been passed by the senate unanimously.

**Massachusetts.**—Recent bills introduced in the legislature include the following: To require "an improved and more efficient car fender"; to require street railway companies to equip cars with heated sand boxes, lifting jacks and emergency apparatus; to require street railways to furnish, subject to the railroad commission's approval, suitable smoking compartments and proper toilet accommodations on all cars used on suburban lines; to require railroads and street railways to maintain distance signals at grade crossings of their respective lines, the railroads to pay for maintenance, but both companies to join in cost of installation; to require passenger cars of steam and electric railways to be equipped with a ventilating system on the suction principle; to amend the hours-of-labor law to provide that a day's work shall be 9 hours in 11 instead of 10 hours in 12; to require railroads or railroads and street railways to pay the cost of abolishing grade crossings with highways; a resolution that the railroad commission investigate the giving of free passes by railroads and street railways and report recommendations; to allow cities of 75,000 inhabitants to make their own terms for granting trolley freight and express rights within their limits, conditional on a referendum where desired by the voters, but not subject to the railroad commission's approval; that street railways be authorized to transport milk and cream anywhere on their lines, subject to the railroad commission's supervision, but to no other board or law or existing charters; to provide temporary locations for street railway companies pending repair or reconstruction of bridges forming part of an existing location; to provide for joint use of tracks by electric railroad and street railway companies, for proper handling of bulk and express freight, subject to the regulation of the railroad commissioners.

## Rapid Transit Affairs in New York.

The New York public service commission on February 5 finally approved the plans for the Broadway-Lexington avenue subway. The line will begin at the Battery, continue under Church and Vesey streets to Broadway, and then under Broadway and Lexington avenue to the Bronx side of the Harlem river, where it will branch into two spurs, one going to Woodlawn cemetery and the other to Pelham Bay Park. The estimated cost of the road and a connecting line across town under Canal street is \$67,000,000. Because the new route is made up of several modifications of routes laid out by the old rapid transit commission, it was necessary to submit the plans to the board of estimate for approval. The latter board met on Thursday and ordered a public hearing so that the commission could advertise in a short time for bids for construction.

The commission is planning additional subway routes which it hopes to have under way at an early date. Comptroller Metz insists that the city has no resources for building additional subways and that a way must be found to have them constructed by private capital. The commission states that it will be possible to start the work if \$10,000,000 can be appropriated.

The commission has suggested, in a report to the legislature, the construction of an elevated freight railroad along the shore of the North river, to take the place of the New York Central's surface line on Eleventh avenue, but the plan has met strong opposition from all sides.

A hearing was held on February 11 on a tentative order for the equipment of the local tracks of the subway with automatic trippers. Frank Hedley, general manager of the Interborough Rapid Transit Company, testified that such a plan would cost \$450,000 and would reduce the number of trains that could be operated. He said that since the opening of the subway not a passenger had been killed after boarding a train.

The commission has decided to begin an investigation of the equipment and service of the elevated lines, particularly with reference to heating the cars, and on February 11

issued an order to the Interborough company to show cause why an even temperature of 60 degrees should not be maintained in its cars.

## Cleveland Settlement Negotiations.

Mayor Johnson of Cleveland and F. H. Goff, representing the Cleveland Electric Railway, have been engaged for several days in an attempt to estimate the valuation of the unexpired franchises of the company, especially on the lines outside of the city limits, which it is conceded are affected by the life of the franchises within the city. The mayor has suggested that an average date of expiration should be determined. He has also suggested some compromises.

At the meeting on Monday of this week Mr. Johnson submitted a report made by Prof. E. W. Bemis on the earnings of the Detroit line, one of the suburban lines, which tended to show that the suburban portion of the line caused a large deficit annually. In calculating the earnings of the line the average fare was taken as 4.82 cents, of which 3 cents was credited to the city end of the line and 1.82 to the outside line. According to Professor Bemis' report there would be a deficit on that line of \$60,000 for 1908, \$65,000 in 1909, and \$70,000 in 1910, and that the entire loss on the line, if operated until the end of the franchise, 1926, would be \$960,000. The mayor said that as this line was the most profitable of the 10 outside lines to be valued the indications were that the outside franchises were of no value after the expiration of the inside franchises. Henry J. Davies, secretary of the Cleveland Electric Railway, replied to the mayor, saying that Professor Bemis had not taken all of the facts into consideration and that he would not concede that the grants had no value.

The Bemis report was discussed further on Tuesday. Mr. Goff said that the building of the outlying lines had been done with the idea of building up the city and with the idea that if they were operated at first at a loss the development of the traffic would bring returns in later years. The company had calculated on a renewal of its city grants and it was not fair, in his opinion, to value the property on the basis of not being able to secure renewals.

## Bill for Examination of Company's Books Declared Unnecessary.

Referring to the bill introduced in the Maryland legislature providing for the expenditure by the city of \$10,000 a year to maintain a department to make examinations of the books of the United Railways & Electric Company, President W. A. House of that company said in his opinion there was no necessity for this department. He said:

"The company has nothing to conceal, its policy being one of frankness in all its dealings with the city. Furthermore, an act was passed by the legislature of 1894 giving the city practically all that is proposed to be conferred by the pending bill. The city has authority at any time to make an examination of the books of the company to see that a full return is being made of the park tax.

"The city has made examinations of the company's books. These display in full detail the receipts, the trips and the mileage of all the lines of the system.

"The park tax receipts of this company have grown from \$253,823.82 in 1897 to \$435,065.84 in 1907. In 1897 all the street railways in the city paid \$253,823.82 in park tax. In 1907 the total amount of taxes paid by the company, including park tax, street paving (the company caring for 50 per cent of the paving of streets occupied by its tracks) and licenses was more than \$700,000. This is fully 10 per cent upon its gross revenue from all sources.

"The company is affording its patrons excellent service in the way of supplying cars of modern design. It has purchased 530 since the fire of 1904. This is about the same number operated over the entire system at the time of the consolidation in 1899. It has also proportionately increased the number of car service miles. The reports for December, 1907, show that there were 40,000 more car-miles made during that month than in December, 1906.

"Several years ago the length of the average car was 18 feet. Today the company has in service 350 cars 42 feet long, increasing the carrying capacity to that extent.

"It was shown by the annual report of 1906 that there had been expended since the fire of February, 1904, about \$6,891,734.21 for the general betterment of the property in the reconstruction of tracks and power houses, for the purchase of cars and for extensions. During 1907 \$1,000,000 additional was expended upon the property, the policy of the company being to put it in the best physical operating condition so that the traveling public of Baltimore and its suburbs might enjoy transportation facilities second to none in the country. Neither time, money nor effort is being spared to accomplish this result."

**Pay-As-You-Enter Cars May be Tried in St. Louis.**—Robert McCulloch, general manager of the United Railways of St. Louis, is quoted as saying that the company is seriously considering the adoption of the pay-as-you-enter type of car for one of its lines, with a view to using it on the entire system after a thorough test, but that no definite action has yet been taken.

**Accident in Chicago.**—In a rear-end collision on the Metropolitan West Side Elevated Railway, Chicago, on the morning of February 9, 19 persons were injured, two of them seriously. A Garfield Park train, just leaving the Center avenue station, was struck from behind by a Humboldt Park train. The motorman of the rear train is blamed for not sufficiently slackening the speed of his train as he approached the station.

**American Institute of Electrical Engineers, Chicago Section.**—At a meeting of the Chicago section of the American Institute of Electrical Engineers on Tuesday evening, February 18, in the rooms of the Western Society of Engineers, Garrett T. Seely, engineer maintenance of way of the South Side Elevated Railway, Chicago, will present a paper on "Some Recent Improvements in the Mechanical and Electrical Equipment of the South Side Elevated Railway."

**Western Society of Engineers.**—A regular meeting of the electrical section of the Western Society of Engineers was held in the society rooms, Monadnock block, Chicago, on Friday, February 14. James N. Hatch presented a paper on "The Evolution of the Electric Railway," which was illustrated by lantern slides. At an extra meeting on February 19 Wilson E. Symons will present a paper on "The Passing of the Steam Locomotive," with a discussion of the relation of steam and electric railways, illustrated by lantern slides.

**Storm Causes Suspension of Service.**—The Georgia Railway & Electric Company of Atlanta, Ga., was obliged to suspend its railway service and its suburban electric lighting service from late Sunday night until noon on Tuesday on account of a heavy sleet, snow and rain storm, which played havoc with the overhead system. Although only a few cases are reported of breaks in the company's wires, so many of the telephone and telegraph wires and poles were broken, tangling up the railway company's overhead wires and causing short-circuits, that it was impossible to operate.

**American Institute of Electrical Engineers.**—The Philadelphia section of the American Institute of Electrical Engineers held its regular meeting on February 10. The programme included a brief note by Carl Hering, consulting engineer, on "An Error in the Usual Statement of the Fundamental Law of Electro-Magnetic Induction"; "A Talk on the Single-Phase Railway Motor," by Benjamin G. Lamme, assistant chief engineer Westinghouse Electric & Manufacturing Company; "The Present Status of the Single-Phase System," by William McClellan, engineer, Campion-McClellan Company.

**Testimonial Dinner to H. H. Vreeland.**—Members of the New York Railroad Club on February 7 tendered a testimonial dinner at the Hoffman House, New York, to H. H. Vreeland, for many years the president of the club. Covers were laid for 300 and Mr. Vreeland was presented with a silver water pitcher. Those present included steam railroad, traction, railroad supply men and representatives of interests identified with transportation in the east. W. G. Besler, vice-president of the Central of New Jersey, acted as toastmaster, and the speakers were John F. Deems, general superintendent of motive power of the New York Central Lines; William J. Wilgus; and George Post, president of the Standard Coupler Company.

**Considering Car Plans in Chicago.**—The Chicago board of supervising engineers has held several conferences in the past few days in the effort to determine on plans for the new cars to be ordered by the Chicago Railways Company, as specified in the city ordinance, which provides for a thorough rehabilitation of the property. As yet no decision has been reached, although it has been practically decided to adopt the pay-as-you-enter type. It is desired to secure a car for the north and west side lines conforming closely to those used on the south side lines of the Chicago City Railway, in order to facilitate through routing, but it seems impossible to secure a standard car for the city because of the physical conditions of the Chicago Railways lines, where there are several undercrossings and curves which require a lower and narrower car than those of the other company. As a consequence the plans for putting through routes in operation will be considerably delayed. The Chicago City Railway Company has received 143 additional pay-as-you-enter cars, which will be placed in service on the Indiana avenue line as soon as additional track connections with the car house at Thirty-eighth street and Cottage Grove avenue can be completed.

## Traffic and Transportation

### Investigation into Service in Kansas City, Mo.

W. E. Kirkpatrick, vice-president of the Metropolitan Street Railway of Kansas City, Mo., has offered to furnish all information desired by the council committee which is investigating the schedules and physical condition of the property of the company. Mr. Kirkpatrick said in his letter to the committee:

"The tables furnished will be taken from the regular records of our company and subject to verification on the part of your honorable commission or any person assigned by you from the office of the city comptroller as suggested in your favor.

"Permit me to suggest that your inquiry may be made more thorough by a personal investigation of the service of public carriers in other cities of like character with Kansas City. To this end I suggest that a visit be made to such cities as you may designate for that purpose, and, if agreeable, that a representative of this company be permitted to attend with your committee and participate in such investigation."

### Hearing on Springfield, Mass., Fares.

The Massachusetts railroad commission held another hearing on February 4 on the petition for lower fares in Springfield, Mass. Bentley W. Warren, counsel for the Springfield Street Railway Company, declared that no other railway outside of Boston gives the people so much for their money as the Springfield company. The city had denied the company's petition for double tracks in order to relieve the traffic.

H. C. Page, vice-president and general manager of the company, said that he would not be willing to try the plan of selling 21 tickets for \$1.00 or 41 for \$2.00. Mr. Page said that if 21 tickets were sold for \$1.00 it would cost the company fully \$60,000 a year. When asked if he would sell tickets at reduced rates to workmen for use between 5:30 and 6:30 p. m. he said that the company could not, as the cars would be so crowded by women shoppers, who would manage to take advantage of the tickets, that conditions would be worse during the evening rush hours than now.

After an argument by Henry A. Booth, attorney for the petitioners, the hearing was closed.

### Preventing Passengers from Boarding Cars Before Terminal is Reached.

We have received from C. J. Franklin, general superintendent Portland (Ore.) Railway Light & Power Company, a copy of the bulletin issued recently to trainmen concerning the boarding of incoming cars on the Oregon Water Power & Railway division by passengers before the terminal at Portland is reached. An abstract of the order follows:

"Passengers on inbound cars are being seriously inconvenienced by persons boarding the cars for the outbound trip before it reaches the terminus of the road. By the time the car arrives at First and Alder streets (the terminus) it is so crowded with passengers who have boarded the cars for the outbound trip that the passengers who were on the car on the inbound trip experience considerable difficulty in getting off. Conductors will not permit persons to board incoming cars for outbound trips between Yamhill and Alder streets on First and Second streets. When at any point between Yamhill and Alder streets passengers desire to board the car the conductor will prevent them from doing so, telling them in a polite and gentlemanly way that they will have to board the car or train at the depot or pay the fare to the terminus. When the car arrives at First and Alder streets the conductor will stand on the ground at the rear of his car, after announcing from the rear platform, 'This way out,' and will direct parties desiring to board the car to do so at the opposite end. The motorman will keep both doors closed on the front platform until he arrives at First and Alder streets, when he will open the door opposite the depot and will not allow passengers to leave the car from the front end, but will allow passengers to board the car from that end, announcing upon his arrival at the depot to passengers in the car, 'Passengers off at rear end.'

"In order to assist motormen and conductors in carrying out these instructions, during the hours from 4:30 to 6:30 p. m. employes in full uniform will be detailed. They are for the purpose of assisting and not relieving the conductor or motorman from any responsibility in not carrying out the above instructions. Should it become necessary to use force to keep passengers from boarding the car at the above-named places

on the inbound trip, you will find a policeman stationed at the corner of each block and at First and Alder streets, upon whom you will call for assistance."

#### For Betterment of Service by Chicago Railways Company.

John M. Roach, president of the Chicago Railways Company, has issued a booklet to employes, calling their attention to what will be expected of them under the contract with the city involving the lines formerly owned by the Chicago, Union Traction Company. Mr. Roach says:

"Trainmen will be expected to conduct themselves at all times with the understanding that the public comes first, and courteous treatment of passengers will be insisted upon as an immediate improvement which does not need to wait for new cars or new rails. Show consideration for the comfort of passengers by attending to such things as the cleanliness, ventilation and heating of cars. Do not inconvenience the public by switching short of the ends of routes, unless it can be shown to be good railroading to do so.

"Conductors will be expected to reduce the number of accidents heretofore chargeable to their carelessness. Do not give the bell signals too quickly when persons are alighting from or boarding cars. Guard those who attempt to alight from or jump on moving cars. Collect fares more carefully and more promptly. Be careful to procure witnesses in all accident cases, and use good judgment in all things appertaining to your position as a representative of the company.

"There are many motormen who will be expected to handle their cars with better judgment hereafter and do their share toward reducing the number of accidents. Watch persons, especially small children, playing in or crossing the streets in front of your cars. Avoid collisions at intersecting street car crossings. Discontinue unnecessary conversations with passengers while your cars are in motion. Quit the reckless and thoughtless handling of electric and braking apparatus. Stop flattening wheels by the improper use of air brakes. Observe schedules and time points. Do not pass by passengers unnecessarily. Use good railroad judgment at all times.

"Station employes will be expected to keep our car equipment in better condition. Clean and disinfect all cars thoroughly. Make repairs more promptly. Get the annoying 'flat' wheels off the cars as fast as they develop.

"Remember that much will be expected from now on from the Chicago Railways Company and its employes and there should and must be a marked improvement. To the large number of competent, loyal men who are now working for this company we make this request: Study carefully the changed conditions which confront us all, and let each one do his duty to the best of his ability, to the end that we may build up a street railway system which will become a source of pride to our city and a cause of congratulation for all those who may have a part in the achievement."

**Revenue from Owl Cars in Des Moines, Ia.**—During the 27 days in December in which owl cars were operated by the Des Moines (Ia.) City Railway the gross revenue was \$622.51. During the entire month of January the gross revenue from this service was \$732.98.

**Hearing on Service Between Boston and Cambridge, Mass.**—The Massachusetts railroad commission held a hearing on February 6 on a petition of residents of Cambridge that the Boston Elevated Railway be required to make various changes in its service. The commission took the case under advisement.

**George Weston to Report on Chicago Elevated Loop Situation.**—George Weston, member of the board of supervising engineers Chicago traction, has been selected by Alderman M. J. Foreman, chairman of the committee on "Local Transportation" of the city council of Chicago, to prepare a report on the elevated loop situation.

**Modification of Increased Service Orders Requested.**—The Interborough Rapid Transit Company has asked for a modification of some of the orders for increased service issued by the New York public service commission, first district. The commission has ordered the Interborough Rapid Transit Company to begin on February 10 the operation of 22 additional trains during rush hours on the Third avenue elevated road.

**Freight and Express Privileges Desired.**—The selectmen of Longmeadow, Mass., held a hearing on January 29 on the petition of the Springfield Street Railway for permission to use its cars and tracks through the town as a common carrier of newspapers, baggage, express and freight. Henry C. Page, vice-president and general manager of the company, said that the trolley express in that vicinity was no longer in an experimental stage. He spoke of the advantages to small towns located near cities of the service afforded by the electric express, and of the benefits to farmers.

# Construction News

## FRANCHISES.

**Augusta, Ga.**—The Atlanta & Carolina Construction Company, Atlanta, Ga., has secured a 32-year franchise for the operation of its interurban cars in Augusta. The company is to pay the city \$1,666.66 annually for the privilege and the line must be completed within two years. Matthew Mason, vice-president and general manager, Atlanta, Ga. (Noted December 28, 1907.)

**Batavia, N. Y.**—Preliminary arrangements for a hearing to be called by the highway commissioners on the application of the Rochester Scottsville & Caledonia Electric Railroad Company, were made through the company's attorney, D. C. Salverdy of Rochester, on January 31. The company plans to build a line from Rochester to Leroy and extend it to Batavia, building on a private right of way. A hearing has been arranged for in Stafford on February 20. The Batavia hearing may be held the same day. A hearing will also be held in Leroy on February 18. (Noted December 7, 1907.)

**Chicago, Ill.**—An ordinance is now pending before the local transportation committee of the Chicago city council which provides for a consolidation of the Calumet Electric Street Railway and the South Chicago City Railway. The ordinance is modeled after those of the Chicago City Railway and the Chicago Railways Company and provides that the city shall receive 55 per cent of the net receipts. Provision is made for a thorough rehabilitation of the properties and for the construction of several extensions, but not for exchange of transfers with the Chicago City Railway. It is stated that the consolidation will be effected as soon as the ordinance is passed.

**Claremore, Okla.**—George Whytell of Claremore and Joseph McDermott of Virginia have secured a franchise to operate an electric railway in Claremore.

**Decatur, Ill.**—After more than a year of delay the city council has granted a franchise to the Decatur Sullivan & Mattoon Transit Company for an entrance into Decatur with its interurban line from Mattoon to Decatur by way of Sullivan, Ill. Right of way has been obtained and franchises secured in several of the towns along the proposed route and it is believed that construction work will be started as soon as the weather permits.

**Houghton, Mich.**—James T. Healy, Houghton, Mich., representing the South Range Street Railway Company, has applied for a franchise to build an electric line from Houghton to South Range, Mich. If granted it is stated that the line will be constructed and in operation inside of a year. It will serve a rich copper mining district in this section. C. C. Douglass and C. D. Hanchette also are interested.

**Walla Walla, Wash.**—The Washington & Oregon Traction Company will apply to the county commissioners on April 6 for permission to cross the county roads with its proposed 75-mile interurban line in southern Washington and extending into Oregon. (Noted November 16, 1907.)

## RECENT INCORPORATIONS.

**Baltimore & Pennsylvania Railway & Power Company.**—Incorporated in Maryland to build a railway from Reisterstown in Baltimore county, Maryland, through Carroll county and into Pennsylvania. Incorporators: William Massenheimer, Charles J. Wells, Jesse A. Davis, Henry M. Foster and C. Dickerson Day.

**Hancock & Lake Linden Traction & Power Company, Portland, Me.**—Incorporated in Maine to build traction and power lines. Capital stock, \$800,000. Incorporators: J. E. Manter, president; C. E. Eaton and M. W. Baldwin, all of Portland.

**Paris & Subiaco Traction Company, Paris, Ark.**—Incorporated in Arkansas to build a 5-mile electric line from Paris to a point at or near Subiaco, Logan county, where the monastery and college of the Benedictine order is located. Capital stock, \$60,000. Incorporators: D. J. Young, Conrad Elskan, G. G. Dandridge, Henry Stroup and Charles J. Jewett.

**Yakima Intervalley Electric Railroad, North Yakima, Wash.**—Incorporated in Washington to build an electric railway from North Yakima to Granger, Wash., in the Sunnyside valley. It is intended to complete the line in time to care for the grain and fruit crop of next fall. It will be 36 miles long and include Zillah and the Parker bottom in the route. Capital stock, \$1,000,000. Incorporators: Mayor Henry H. Lom-

bard, North Yakima; J. H. Thomas, A. B. Wilcox, C. H. Furman, George P. Eaton, R. E. Page and Walter N. Granger. (Noted February 8.)

**Indianapolis & South Bend Traction Company.**—Incorporated in Indiana to build an electric railway from South Bend to Indianapolis, serving the following towns and cities: Westfield, Sheridan, Kirkin, Michigantown, Burlington, Logansport, Rochester, Plymouth, Lafayette, Clarksville, Linton and Veedersburg, with branch lines from Delphi to Flora and Kokomo, from Frankfort to Tipton and from Lebanon to Noblesville, Ind. Capital stock, \$10,000. Incorporators: Robert H. Keller, John H. Keller and Edward N. Bowman, all of Indianapolis.

#### TRACK AND ROADWAY.

**Arkansas Valley Traction Company, La Junta, Colo.**—Surveys are being made and financial backing secured for the construction of this 12-mile interurban line from La Junta by way of Swink and New Dale to Rocky Ford, Colo. The company may issue \$100,000 of 6 per cent bonds but no contracts will be let until funds are available for pushing the construction work. Most of the right of way has been secured and franchises obtained in La Junta, Rocky Ford and Swink, as previously announced. It is proposed to equip the line with gasoline motor cars. J. E. Gauger, president, Rocky Ford; F. T. Lewis, chief engineer, La Junta. (Noted October 12, 1907.)

**Atlanta & Carolina Construction Company, Atlanta, Ga.**—Financial arrangements are being concluded and it is stated that construction work will be started on this proposed road about March 1. The line will connect Atlanta, Athens and Augusta, Ga., and will be equipped for passenger and freight business. The power house probably will be located at Athens. Matthew Mason, vice-president and general manager, Atlanta, Ga. (Noted December 28, 1907.)

**Blue Ridge Traction Company, Bethlehem, Pa.**—This company has filed notices of extensions from a point on the Walnutport-Davidsville road to Poplar Grove, Cherryville, Alliance, Weaversville and Bath; also from Alliance, where a bridge will be built, to Catasauga, a total distance of 16 miles. A. N. Brown, general manager, Bethlehem, Pa.

**Brownsville Masontown & Smithfield Street Railway, Masontown, Pa.**—Grading will be resumed on this proposed electric line between Brownsville and Smithfield, 20 miles, some time this month, surveys for which already have been made. About half a mile of grading has been completed between Masontown and West Masontown. The line will extend south by way of Masontown to New Geneva and from thence northeast by way of Smithfield to Uniontown, Pa., making a total distance of 36 miles. The route as planned requires the construction of several viaducts. Contracts will be awarded in February and March. W. J. Sheldon, president, McKeesport, Pa.; E. C. McCullugh, chief engineer, Uniontown. (Noted July 6, 1907.)

**Chambersburg Greencastle & Waynesboro Street Railway, Waynesboro, Pa.**—J. F. Geiser, electrical engineer and superintendent, writes that the line is being extended from the present terminus at Greencastle to Chambersburg, 11½ miles. Tracklaying and the erection of trolley poles and wires have been completed for about half the distance.

**Chicago City Railway.**—The Chicago board of supervising engineers has authorized the purchase of 8,000 tons of rails and other building materials for use in the reconstruction of this company's lines, which has been in progress for several months.

**Chicago South Bend & Northern Indiana, South Bend, Ind.**—It is stated that this company will let contracts and push its western extension from South Bend to Laporte, where connection will be made with a line now in operation between Laporte and Michigan City, Ind., with the intention of having cars in operation by next June. Cars and equipment for this branch are said to have been ordered. Samuel Riddle, general manager, South Bend, Ind. (Noted November 2, 1907.)

**Denver & Interurban Railway, Denver, Colo.**—Surveys have been made for the city lines in Boulder, Colo., which will be operated in connection with the electric line from Denver to Boulder. Cars are expected to be operating between these points by June 1.

**Dickinson & Southern Railway, Dickinson, N. D.**—This company is being organized to build and operate an electric railway from Dickinson, N. D., south to connect with the Chicago Milwaukee & St. Paul Railway.

**Donora & Eldora Street Railway, Pittsburg, Pa.**—Surveys have been made and right of way obtained for this proposed

electric railway which will be built between Donora and Eldora, Pa., 3.3 miles. Contracts will be let in the spring. A 350-foot viaduct will be built and 38,000 cubic yards of grading will be done. Gisli Gudmundson, chief engineer, Empire building, Pittsburg, Pa. (Noted November 30, 1907.)

**Elkins, W. Va.**—It is stated that the electric line which is being built from Elkins to Belington, W. Va., by J. C. McSpadden, will be completed this spring. With the completion of this line and the proposed extension of the Fairmount & Clarksburg Traction Company from Fairmount to Belington nearly the entire distance between Elkins, W. Va., and Pittsburg, Pa., 200 miles, will be covered by trolley lines, the only remaining gap being between Uniontown and Fairmount. The line from Elkins to Belington will be an independent line and will be operated by Mr. McSpadden when completed.

**Fayetteville, N. Y.**—The Fayetteville Gypsum Company has secured right of way for an electric line 1½ miles long which it proposes to build this spring from its quarries to the Erie canal. The road will be for freight service only. A power plant and a crushing plant will also be built. George E. Dougherty, superintendent.

**Ft. Dodge Emmetsburg & Spirit Lake Railway, Ft. Dodge, Ia.**—It is stated that the entire right of way for this proposed 116-mile interurban road will have been secured within a month and that construction work will be started in the spring. Much of the right of way has been donated and a considerable portion of the stock subscribed by residents along the proposed route. Financial arrangements are said to have been concluded with an eastern company and funds are now available for pushing the work as soon as weather permits. The line will connect with the Ft. Dodge Des Moines & Southern Railway, thus affording direct electric rail communication from Des Moines to the lake region of that section. M. H. Miller, vice-president, Ft. Dodge, Ia. (Noted December 28, 1907.)

**Ft. Worth Weatherford & Mineral Wells Interurban Construction Company.**—At a meeting held in Weatherford, Tex., on February 4 this company was formed for the purpose of building the Ft. Worth Weatherford & Mineral Wells Interurban Railway, which has been promoted by G. R. Turner of New Orleans, La. Considerable grading already has been done and it is expected that the road will be completed by January, 1909. G. M. Bowie, Weatherford, and J. T. Hill, Mineral Wells, were elected president and secretary respectively of the new company. Stuart Harrison, Ft. Worth; Charles McFarland, Weatherford; and Cicero Smith also are interested. (Noted February 1.)

**Goose Creek Railway & Power Manufacturing Company.**—Application for a charter will soon be made by this company for the purpose of building, equipping and operating a power generating plant on Goose Creek and operating an electric railway system, cotton factory and a cottonseed oil mill. D. M. Clark, Jesup, Ga., and D. G. Zeigler, Columbia, S. C., are attorney and architect and engineer, respectively. The capital stock will be \$200,000, to be increased later to \$500,000. Others interested are W. H. Whaley, F. E. Breen, S. E. Cohen, J. H. Wilkins, J. P. Breen, W. M. Roberson, J. T. Winn, A. L. Kicklighter and E. Crumney, all of Jesup, Ga.

**Grafton Traction Company, Grafton, W. Va.**—This company has placed in operation its 2½-mile electric railway which was started last summer. It is reported that another extension will be built this year. (Noted May 25, 1907.)

**Grand Central Traction Company, Indianapolis, Ind.**—Survey for this company's right of way through Warrick county, Indiana, has been completed and J. H. Hutchinsin, construction engineer, announces that work probably will begin on February 15. The survey extends from Evansville through Millersburg, Holland, French Lick and thence north to Indianapolis by way of Bloomington. (Noted December 21, 1907.)

**Kokomo Frankfort & Terre Haute Traction Company, Frankfort, Ind.**—This company was organized on February 3 for the purpose of constructing an interurban railway in Indiana. Articles of incorporation will be filed within a few days and the work of obtaining right of way and franchises will be started immediately. Capital stock, \$3,000,000. Officers were elected as follows: President, Dr. Oliver Gard, Frankfort; first vice-president, J. C. De Weese, Kokomo; second vice-president, D. W. Bolen, Indianapolis; secretary, E. B. Swift, Kokomo; treasurer, M. W. Eikenberry, Kokomo; general counsel, Judge J. V. Kent, Frankfort. W. H. Eikenberry, Russiaville; Albert E. Betts, Frankfort; and Adam Ridenhour, Forest, are also interested.

**Lima & Toledo Traction Company, Lima, O.**—Application for permission to build a drawbridge over Swan creek, near

the foot of Division street, in order to complete its entrance into Toledo, has been made by this company to the United States war department. The company has its own right of way, which is along the west bank of the old Miami & Erie canal, and by crossing the creek at this point would parallel the Clover Leaf and continue its tracks on the Wabash right of way, across South Eleventh street and thence into the downtown section.

**Lowell & Fitchburg Street Railway, Ayer, Mass.**—This company has applied to the Massachusetts railroad commission for permission to extend its tracks in Ayer, Mass., about 250 feet in order to connect with the line of the Fitchburg & Leominster Street Railway. This involves crossing the Boston & Maine Railroad tracks at grade. If the grade crossing is abolished the company agrees to pay the town's share of the cost of the improvement.

**Mexico Santa Fe & Perry Traction Company, Mexico, Mo.**—This company, which commenced grading on its proposed 27-mile electric railway between Mexico and Perry, Mo., by way of Molino and Santa Fe, last November, has completed three miles of grading. It is expected that the entire line will be in operation by September, 1908. An extension from Mexico to Columbia, Mo., probably will be built later. The plans call for a number of bridges, for which contracts will be let in the near future. J. M. Wolfe, Collinsville, Ill., has the contract for the grading, some of which has been sublet. S. L. Robison, president and general manager; C. L. Thon, chief engineer, Belleville, Ill. (Noted November 9, 1907.)

**Morgantown & Dunkard Valley Electric Railway, Morgantown, W. Va.**—Grading is in progress on this proposed 4-mile electric line from Morgantown to Star City, W. Va. The plans include a bridge 600 feet long. W. W. Smith, secretary and treasurer, Morgantown, W. Va.

**Northwestern Elevated Railroad, Chicago, Ill.**—It is announced that through service between Chicago and Evanston, Ill. over an electrified line of the Chicago Milwaukee & St. Paul Railway, will probably be established by May 1. Construction material and substation equipment is now ready for delivery as soon as the weather is favorable for the resumption of work. The work to be done includes the construction of the incline from the elevated to the surface tracks at Wilson avenue, the completion of stations and platforms, the equipment of the Evanston substation and a portion of the track work.

**Olney, Ill.**—At a meeting held recently in Olney a company was organized to build an electric railway from this city to Mt. Carmel, Ill., and across the Wabash river to Evansville, Ind. P. J. Kolb, Mt. Carmel, is interested.

**Pacific Coast Railway, San Luis Obispo, Cal.**—This company, which last year completed an extension of 2.1 miles from Betabel to Bonetti, Cal., is now building an electric railway between Santa Maria and Guadalupe, eight miles. A portion of the track is laid and it is hoped to have the line in operation by next summer. The new road will develop the oil fields to the south, connecting them with the Southern Pacific at Guadalupe. James Anderson, chief engineer. (Noted January 11.)

**Puget Sound Electric Railway, Tacoma, Wash.**—Construction has been started on the extension of this line from Tacoma to Puyallup and it is expected that cars will be operated within a few months. The right of way lies straight up the Puyallup valley through a rich farming section and will make a much shorter route than by the existing steam lines. After the road has been completed to Puyallup it will be continued to Sumner, McMillan, Alderton and Orting. W. S. Dimmock, manager, Tacoma, Wash.

**Rock Island Southern Railroad, Monmouth, Ill.**—This company has completed surveying its route between Monmouth and Oquawka, Ill., 17½ miles. F. H. Lanchshire, chief engineer, Davenport, Ia. (Noted May 4, 1907.)

**San Angelo, Tex.**—The project of building an electric street railway system in San Angelo is said to have been revived by Col. J. H. Ransome of Hereford, Tex., who secured the franchise in San Angelo. It is said that the site for a power house is being selected and that work will be started on the first mile of track in the near future in order to comply with the terms of the franchise which expires next September.

**Stuebenville & East Liverpool Railway & Light Company, Steubenville, O.**—Service was started on the new 30-mile interurban line of this company when a party of officials and guests made a trip over the line in special cars on February 10. The road is double-tracked the entire distance and is laid with 85-pound T-rails on stone ballast. It skirts the Ohio

river and serves the towns of Toronto, Empire and Wellsville between its Steubenville and East Liverpool termini. At Steubenville it connects with a 21-mile electric line reaching to Wheeling on the south, and at East Liverpool with the Ohio River Passenger Railway extending to Beaver, Pa., where connection is afforded with the Beaver Valley Traction Company under the control of the Pittsburg Railways Company. J. C. Rothery, general manager, Steubenville, O.

**Spokane & Inland Empire Railroad, Spokane, Wash.**—This company has awarded contracts to Grant Smith & Co., Rosalia, Wash., for the construction of its eastern division extension from Palouse, Wash., southward to Moscow, Idaho, 15½ miles.

**Twin City General Electric Company, Ironwood, Mich.**—Contracts for poles, ties and rails for an electric railway from Ironwood to Bessemer and Wakefield, Mich., have been let by this company, and as soon as the weather permits construction work will be started. E. D. Nelson, president and general manager, Ironwood, Mich.

**Washington Frederick & Gettysburg Railway, Frederick, Md.**—It is announced that the location of the route for this company's southern extension from Frederick by way of Buckeystown to the west of Sugarloaf mountain, has been selected. From the mountain it will pass through Dickinson station, Poolesville and Seneca, 31 miles, and cross the Potomac river at Great Falls, where it will connect with the Great Falls & Old Dominion Railway for entrance into Washington. D. Columbus Kemp, Frederick, Md., president; Theodore J. King, Washington, D. C., chief engineer. (Noted February 8.)

**West Chester & Wilmington Electric Railway.**—Announcement is made that the two companies of this name, incorporated under separate charters in Pennsylvania and Delaware, will be consolidated in the near future and a construction company organized to build the proposed line. Thomas E. O'Connell, West Chester, Pa., is president. (Noted December 28, 1907.)

**West Penn Railways, Connellsville, Pa.**—J. L. Fritsch, chief engineer, writes that tracklaying has been completed from Leckrone to Masontown, 2.3 miles, and that tracklaying and overhead work have been completed from Footdale to Orient, 2.5 miles. Surveys have been completed from Orient to Brownsville, 13.5 miles, and grading has been completed and overhead work is being erected between Orient and Merrittstown, 2 miles. Grading is in progress between Merrittstown and Brownsville. The overhead construction is of the bracket type.

**Wheatland Street Railway.**—This company has filed a notice of extension with the state department at Harrisburg, Pa., for 800 feet on Church street in Wheatland, and from Wheatland to West Middlesex, 2½ miles, two miles of which will be on private right of way.

**Winnipeg Electric Railway, Winnipeg, Man.**—This company is pushing the work on its 22-mile extension to Selkirk and it is expected that cars will be running by March 1. The trolley wires have been strung and the substations are nearly completed. The cars for the new road are being built in the shops of the company at Ft. Rouge. Two-car trains will be operated. W. A. Henderson, general manager, Winnipeg, Man.

#### POWER HOUSES AND SUBSTATIONS.

**Chambersburg Greencastle & Waynesboro Street Railway, Waynesboro, Pa.**—Joseph H. Geiser, electrical engineer and superintendent, writes that this company will increase the generating capacity of its power house at Waynesboro to furnish power for the extension from Greencastle to Chambersburg now being built. Sealed bids are asked on the following equipment, including installation: 500-kilowatt 2,300-volt 60-cycle three-phase steam turbine or engine-driven generating set; jet condenser and cooling tower; 30-kilowatt steam-driven exciter set and switchboard panel; also a 14-mile transmission line, 23,000 volts, three-phase, to be erected on existing poles; transformer and substation equipment complete; 10½ miles No. 0000 direct-current feeder, erected.

**Chicago South Bend & Northern Indiana Railway, South Bend, Ind.**—Since January 29 this company has used electric power from the Indiana & Michigan Electric Company's Hen Island plant, where a large dam has been constructed in the St. Joseph river at a cost of \$1,500,000.

**Macon Railway & Light Company, Macon, Ga.**—Orders are said to have been placed by this company for a new turbine and generator to be installed in its Macon power plant this spring. The new machinery will develop 2,500 horsepower and is designed for a 50 per cent overload in case of emergency. W. J. Massee, president, Macon, Ga.

## Personal Mention

Mr. Judson Bibb has been appointed general manager of the Sheridan Electric Light & Traction Company, Sheridan, Wyo.

Mr. John Z. Murphy, chief engineer of the Chicago Railways Company, has been appointed as the company's representative of the Chicago board of supervising engineers.

Mr. John T. Young, general manager of the Muskegon (Mich.) Traction & Lighting Company, has been elected a director of the company to succeed the late Thomas Munroe.

Mr. V. L. Havens has been appointed chief engineer of the Compania Limitada de Tranvias Electricos de Mexico, City of Mexico, Mex., succeeding Mr. Paul H. Evans, resigned.

Mr. C. E. Graves, who was formerly in the service of the Grand Trunk and Great Northern railways, has been appointed district passenger agent of the Niagara Gorge Railroad, with office at Toronto.

Mr. Osborne Shryock has been appointed superintendent of the Meadville Conneaut Lake & Linesville Trolley Company, Meadville, Pa., succeeding Mr. John Allen, resigned. He was formerly assistant in the company's shops.

Mr. H. D. Murdock has been appointed mechanical and electrical engineer of the Indianapolis & Louisville Traction Company at Scottsburg, Ind. Mr. Murdock formerly was in the mechanical department of the Brooklyn Rapid Transit Company.

Mr. J. Walter Ackerman has been appointed resident engineer of the Ithaca (N. Y.) Street Railway, with entire charge of the reconstruction work which is planned by the company. Mr. Ackerman came from Auburn, N. Y., where he was city engineer.

Mr. C. E. Palmer, who recently resigned as superintendent of the Cincinnati Northern Traction Company, northern division, as announced in our issue of January 18, has been appointed superintendent of railways of the Eastern Pennsylvania Railways, Pottsville, Pa.

Mr. J. B. Hanna writes that the report that he had resigned as president of the Chicago Lake Shore & South Bend Railway, as published in the Electric Railway Review of February 8, is incorrect and that he is completing the construction of the road as fast as possible.

Mr. Henry C. Dalton, who has been connected for a number of years with the Louisville & Southern Indiana Traction Company's street railway systems in Jeffersonville and New Albany, Ind., has been appointed general manager of the Boise & Interurban Railway at Boise, Idaho.

Mr. W. E. Boileau, assistant mechanical engineer of the New York West Chester & Boston Railway, under construction from New York to Portchester and White Plains, N. Y., has resigned to become general manager of the Chattanooga Electric Company, Chattanooga, Tenn.

Mr. E. E. Lillie has resigned as superintendent of the Spokane & Inland division of the Inland Empire System, Spokane, Wash., to become superintendent of car service of the Portland & Seattle and the Astoria & Columbia River railroads, with headquarters at Portland, Ore.

Mr. Fred A. Martin, formerly chief operating inspector of the New York Central Railroad, has been appointed general manager of the Minneapolis St. Paul Rochester & Dubuque Traction Company, which proposes to build an electric line from Minneapolis and St. Paul to Dubuque, Ia.

Mr. Frank H. Brown, Pawtucket, R. I., has been appointed superintendent of the Rhode Island Company's lines north of Providence, with supervision over 110 miles of track. He formerly was in charge of the Pawtucket Street Railway system and the interstate line from Pawtucket to Attleboro.

Mr. J. H. Hansen of New York City has been elected president of the Toledo & Chicago Interurban Railway, succeeding Mr. A. B. Shepard of Cleveland, who has resigned to re-enter the electrical supply business, with headquarters in Cleveland. Mr. Shepard will continue as a director of the company.

Mr. J. L. Heins has tendered his resignation as president of the Coney Island & Brooklyn Railroad, Brooklyn, N. Y. He has been in continuous service with this company and the Brooklyn City & Newton Railroad since 1884. He will remain a director of the company and at the solicitation of the board

of directors will act as its chairman and also be retained in a general advisory capacity. As chairman of the board he will have general charge of the road and continue to discharge the duties of president until a successor has been chosen.

Mr. George B. Hippee, heretofore treasurer and general manager of the Des Moines (Ia.) City Railway, has been elected president and treasurer of the company, to succeed the late Jefferson S. Polk, who died last November. Mr. A. G. Malsh, heretofore general superintendent, has been appointed general manager.

Mr. John S. Bleecker, for the past three years manager of the Paducah (Ky.) Traction Company, one of the Stone & Webster properties, has been transferred in a similar capacity to the Columbus Railroad at Columbus, Ga. He will be succeeded at Paducah by Mr. F. E. Reidhead, formerly manager of the Columbus property.

Mr. Watson Townsend, formerly assistant engineer of the Great Northern Railway, has been appointed chief engineer of the St. Paul Minneapolis & Seattle Electric Railway, St. Paul, Minn., which recently was incorporated to build an electric railway from St. Paul and Minneapolis, Minn., to the Pacific coast with branches to Fargo, N. D., and Aberdeen, S. D.

Mr. J. L. Nash, general foreman of the armature department of the Boston Elevated Railway, Boston, Mass., has resigned. Mr. Nash has been engaged in this work for a number of years, having served with the old American Electrical Company of New Britain, Conn., the Thompson-Houston Company and the General Electric Company. He has been with the Boston Elevated Company for the past 16 years.

Mr. C. A. Smith, whose appointment as superintendent of maintenance of way for the Georgia Railway & Electric Company at Atlanta, Ga., was recently announced in connection with several other changes in the personnel of the company,



C. A. Smith.

was born in Lawrence, Mass., in 1875. He was educated in the public schools of that city and later entered the civil engineering department of the Massachusetts Institute of Technology, where he graduated in 1899. In the fall of the same year he was appointed assistant engineer for Ford, Bacon & Davis, New York City, who at that time were constructing the Atlanta Rapid Transit Company's lines in Atlanta, Ga. He remained with this firm until the fall of 1905, serving successively as assistant engineer, superintendent of construction

and engineer in charge of construction work on various electric railway properties throughout the south. Since 1905 he has been connected with the Georgia Railway & Electric Company as engineer in the roadway department. In his new position as superintendent of maintenance of way he succeeds Mr. W. H. Glenn, who was appointed manager of railways, vice Mr. Thomas K. Glenn, resigned.

Announcement is made of the appointment of Prof. C. F. Harding as head of the school of electrical engineering of Purdue University. Professor Harding is a graduate of Worcester Polytechnic Institute and has had a broad practical training as an engineering teacher. His special training has been along the line of high-tension railway work and he was electrical engineer for the first railway of that character in New England. He has been engineer for the D. & W. Fuse Company of Providence, R. I., publication manager for the Ft. Wayne Electric Company, associate professor of electrical engineering at Cornell University and engineering expert for Stone & Webster of Boston.

Mr. Richard Hapgood, superintendent of tracks of the Boston Elevated Railway, has just observed his fiftieth anniversary as an active street railway man in Boston. He began as stableman on the old Union Railroad, Cambridge, in 1858; after several years of platform work he became superintendent of the Cambridge Railroad; left that position in 1885 to

# Financial News

spend two years in the west for his health; returned to become roadmaster of the Boston Consolidated Street Railway; succeeded in 1892 to the same position after the West End Street Railway was formed, and with the lease of that company by the Boston Elevated Railway assumed his present position. The first company he served built its own cars, costing \$850 and weighing 4,500 pounds. The tracks he now supervises carry electric semi-convertibles, weighing 56,000 pounds and costing ten times as much as the old horse cars.

Mr. S. A. Redding, heretofore electrical engineer of the Georgia Railway & Electric Company, Atlanta, Ga., has been appointed general superintendent of the electrical department of the company, effective on February 4. Mr. Redding is a native of Atlanta and is a graduate of the electrical engineering department of the Alabama Polytechnic Institute at Auburn, Ala. In 1894 he entered the service of the Georgia Electric Company at Atlanta, where he remained until January 1, 1895, when he resigned to go to Schenectady, N. Y., as a student in the practical electrical department of the General Electric Company. After three years of service with this company he was sent to Manaus, state of Amazonas, Brazil, which is 1,000 miles up the Amazon river, to install an electric lighting plant in that city. After completing the installation he was appointed chief engineer of the Manaus Electric Railway Company, where he remained until 1903, when he returned to Atlanta to take a position in the engineering department of the Georgia Railway & Electric Company. In the spring of 1906 he was appointed assistant electrical engineer and later electrical engineer, where he has remained until his present appointment. In his new position he will have charge of all generating stations, substations and wires and conduit, succeeding Mr. G. W. Brine, who had charge of these details before his recent appointment as general manager.

Mr. Peter C. Dolan, whose election as president of the Pittsfield (Mass.) Electric Street Railway was announced in our issue of February 1, has been identified with street railway interests since he was 22 years old. At that time he, together with his brother, P. H. Dolan, bought the controlling interests in the New Britain (Conn.) Traction Company, then operated by horse-power. Under their management the line was converted for electrical operation and is said to have been the first successful trolley system in the state of Connecticut. In 1891 the road was sold to the Connecticut Light & Power Company and in 1892 the Dolan brothers purchased the Pittsfield Street Railway, which had recently been converted into a trolley system, although the old single-truck horse-car equipment was still in use. Under their direction the road was improved and extended, a new office building, waiting stations and car barns were erected and more recently the new Seymour street power station has been built and equipped. Mr. Dolan is 50 years old. He was general manager of the company until his election as president to succeed the late Joseph Tueker.



Peter C. Dolan.

### Obituary.

Othniel F. Nichols, who from 1888 to 1895 was general manager and chief engineer of the Brooklyn Elevated Railroad, died at his home in Brooklyn, N. Y., on February 4. He was formerly chief engineer of the department of bridges of New York City and was connected with the construction of various

Murdock McAulay, superintendent of the Detroit Monroe & Toledo Short Line Railway at Monroe, Mich., died of apoplexy on February 11, aged 45 years. Mr. McAulay had been with the Detroit United Railway for a number of years, serving from 1901 to 1902 as carhouse foreman, and from 1903 to 1906 as assistant superintendent of its Orchard Lake division. On July 1, 1906, he was appointed assistant superintendent of the Detroit Monroe & Toledo Short Line, and on January 1, 1908, became superintendent of the road, succeeding Mr. E. B. Taylor, as announced in an earlier issue.

**Boston Elevated Railway.**—The committee on "Street Railways" of the Massachusetts legislature held a meeting on January 30 to consider the bill providing for absorption of the West End Street Railway by the Boston Elevated Railway. W. A. Bancroft, president of the Boston Elevated Railway, said that unless the bill should be passed, "instead of developing one company, we shall be developing two. Almost a million dollars' worth of real estate is lying idle now which we cannot sell—although we ought to sell it—owing to the provision that the property of the West End company must be returned at the end of the lease, 14 years from now, exactly as it was received by us." Frederick M. Bushnell of Stone & Webster testified to the enormous cost of operating the system as two roads over what it would be if they were consolidated.

**Chicago & Milwaukee Electric Railroad.**—Arthur Young & Co., public accountants, have been employed by the receivers to make a detailed report regarding the accounts of the company.

**Cleveland Southwestern & Columbus Railway, Cleveland, O.**—At the annual meeting of stockholders J. O. Wilson, the treasurer, was elected a director.

**International Railway System, Buffalo.**—Earnings for the quarter ended December 31, 1907, with comparisons, were as follows:

	1907.	1906.	1905.
Quarter ended December 31—			
Gross earnings .....	\$1,307,663	\$1,366,876	\$1,136,021
Operating expenses .....	843,715	724,842	702,954
Net earnings .....	\$ 463,948	\$ 642,034	\$ 433,067
Charges .....	351,101	295,730	288,047
Surplus .....	\$ 112,847	\$ 346,304	\$ 145,020

**Maryland Electric Railways, Baltimore, Md.**—The \$1,200,000 capital stock of this company has been listed on the Baltimore stock exchange.

**Metropolitan Street Railway, New York.**—The interest due on February 1 on the \$12,500,000 of general mortgage collateral trust 5 per cent bonds was not paid. Alexander J. Hemphill, Donald Mackay and Edward H. Ladd, Jr., will act as a protective committee representing the interests of holders of these bonds. The committee requests that information as to the amount of holdings of these bonds be sent to the Guaranty Trust Company of New York.

**Montreal Street Railway, Montreal, Can.**—Shareholders authorized on February 1 the issue of \$1,000,000 additional capital stock at 125 and the issue of £460,000 of 4½ per cent 14-year debentures.

**Ohio Electric Railway, Cincinnati, O.**—This company has absorbed the property of the Cincinnati Northern Traction Company. The Cincinnati Enquirer states in substance: "The merger has been approved by the directors and stockholders of both corporations. The completion of this consolidation will mean that the Schoepf interests will have under one direct management 700 miles of interurban track, with an additional 100 miles when construction work now under way is completed. This will leave the Schoepf properties in Ohio in two corporations, the Ohio Electric Railway, the interurban system, and the Ohio Traction Company, which controls the Cincinnati Traction Company. It is the intention to continue the Ohio Traction Company as a separate organization. The Cincinnati Northern Traction Company controls by lease the Cincinnati Dayton & Toledo Traction Company. This lease will be assigned to the Ohio Electric Railway. The road of the Cincinnati Northern company is being rebuilt. It extends from Spring Grove avenue, Cincinnati, to Dayton, about 60 miles, where it connects with the interurban lines which extend in four directions—to Columbus and Zanesville on the east, Toledo on the north and Richmond and Ft. Wayne on the west and northwest. The grading on the line which is under construction to Toledo has been fully completed and rails are now being laid."

**South Side Elevated Railroad, Chicago.**—Wallace Heckman has been elected a director to succeed William B. Walker.

**Third Avenue Railroad, New York.**—The Central Trust Company of New York has asked permission of the United States circuit court of New York to intervene as party defendants in the receivership of the subsidiary Forty-second Street Manhattanville & St. Nicholas Avenue Railway and Dry Dock East Broadway & Battery Railroad. The Central



Trust Company states that one of the last acts of the officers and directors of the Dry Dock company, who represented the New York City Railway, was to pay over to the receivers of the latter corporation checks aggregating \$20,000 for alleged indebtedness. Payment on the checks was immediately stopped, but \$8,000 had been collected, it was found. The trust company also states that payment was stopped on checks aggregating \$45,000, issued to the New York City Railway receivers by the Forty-second Street Company. Representatives of the trustees and holders of the first consolidated mortgage bonds of this company have been elected directors of various subsidiary lines.

**Toronto (Ont.) Railway.**—Gross earnings in 1907 were \$3,511,197, an increase of \$401,458, or 12.9 per cent. over 1906. Operating expenses were \$1,893,326, or 53.9 per cent of gross earnings. There was a surplus of \$122,781 after provision for all charges and for dividends. During the year the city of Toronto received from the company for taxes, percentages and pavement charges the sum of \$542,090.53, an increase of \$74,725.09 over the previous year.

**Twin City Rapid Transit Company, Minneapolis, Minn.**—M. B. Koon has been elected a director to succeed N. D. Munn.

**United Railways Company of St. Louis.**—At the annual meeting of stockholders on January 28 the directors were re-elected. The directors re-elected all the officers.

**United Railroads of San Francisco.**—Patrick Calhoun, the president, is quoted in the San Francisco Chronicle as confirming the report that he has negotiated the sale of \$3,500,000 of preferred stock, the proceeds of which, with \$1,500,000 arranged for previously, will make \$5,000,000 available for the construction of a new power plant, and reconstruction.

**West End Street Railway, Boston.**—The issue of \$700,000 of 15-year bonds, to bear not over 5 per cent interest, has been approved by the Massachusetts railroad commission.

**Wilmington & Edgemoor Electric Railway.**—Robert Glendinning & Co. of Philadelphia are offering at par and interest \$65,000 of first mortgage 5 per cent bonds. The bonds are guaranteed by the Wilmington (Del.) City Railway, the stock of which is now deposited as security for the Wilmington & Chester Traction Company 5 per cent bonds.

**Winnipeg Electric Railway.**—Gross earnings in 1907 were \$861,571, of which 5 per cent was paid to the city of Winnipeg.

**Winona Interurban Railway, Winona Lake, Ind.**—The capital stock has been increased to \$1,200,000 to permit the issue of \$600,000 of 6 per cent cumulative preferred stock on account of the construction of the Peru division, extending from Peru to Warsaw, 44 miles, of which 11 miles are now in operation and the remainder will be completed on June 1, 1908. The amount of bonds on the Peru division is \$850,000, and on the Goshen division \$750,000 bonds are outstanding. The common stock of this company is held in trust for the Winona Assembly.

**ELECTRIC RAILWAY EARNINGS.**

**American Railways Company, Philadelphia (Subsidiary Companies).**

Gross earnings—	1908.	1907.
January .....	\$ 209,287.28	\$ 210,716.55
July 1, 1907, to January 31, 1908. . .	1,780,859.40	1,701,548.62

**Seattle (Wash.) Electric Company.**

December—	1907.	1906.
Gross earnings .....	\$361,369.91	\$309,476.33
Operating expenses (including taxes). .	252,883.77	196,963.89
Net earnings .....	108,486.14	112,512.44
Interest charges .....	40,990.63	28,306.77
Balance .....	67,495.51	84,205.67
Bond sinking fund.....	4,583.34	4,583.37
Balance .....	62,912.17	79,622.30

**Dividends Declared.**

- Georgia Railway & Electric Company, Atlanta, Ga., common, quarterly, 1½ per cent.
- Grand Rapids (Mich.) Railway, preferred, quarterly, 1¼ per cent.
- Harrisburg (Pa.) Traction Company, 3 per cent.
- Philadelphia Company, Pittsburg, preferred, 2½ per cent.
- Union Street Railway, New Bedford, Mass., quarterly, 2 per cent.

The Havana Central Railroad, which operates an electric railway 70 miles long, between Havana and suburban towns, contemplates the building of 50 miles of additional track, a large terminal station and a number of piers. It is the intention of the company to operate, in the future, a ferry from Havana to Regla.

# Manufactures and Supplies

**ROLLING STOCK.**

**Mattoon City Railway, Mattoon, Ill.**, is in the market for one double-truck car.

**Third Avenue Railroad, New York**, is in the market for 50 new equipments for installation on its summer cars.

**Toledo Urban & Interurban Railway, Toledo, O.**, has purchased three sets of trucks from the Curtis Motor Truck Company of Decatur, Ill.

**Ft. Wayne & Springfield Railway, Decatur, Ind.**, has built in its own shops one refrigerator car. The specifications include the following details:

Weight .....	20,000 lb.	Width, inside .....	7 ft. 10 in.
Wheel base .....	5 ft.	Over all .....	8 ft. 4 in.
Length of body .....	36 ft.	Height, inside .....	8 ft.
Over vestibule .....	39 ft.	Body .....	Wood
Over all .....	40 ft.	Underframe .....	Wood

The special equipment includes Washburn couplers and English varnish.

**Los Angeles & Redondo Railway, Los Angeles, Cal.**, is building six open and closed section double-truck cars in its own shops at Redondo Beach, Cal. These cars are to be finished by June 1, 1908. The specifications include the following details:

Seating capacity.....	52 passengers	Length, over all .....	47 ft. 6 in.
Weight .....	50,000 lb.	Height, inside .....	8 ft.
Wheel base .....	5 ft. 10 in.	Sill to trolley base .....	9 ft. 2 in.
Width, inside .....	7 ft. 7 in.	Height track to trolley base .....	12 ft. 2 in.
Over all .....	8 ft. 5 in.	Body .....	Wood
Length of body .....	36 ft.	Underframe .....	Wood and metal
Over vestibule .....	46 ft. 6 in.		

Special Equipment.

Air brakes.....	Westinghouse	Hand brakes.....	St.
Center bearings .....	Baltimore ball bearing	Louis vertical ratchet wheel	
Control system .....	Westinghouse	Headlights .....	Mosher
Couplers .....	Norwood & Bonny automatic	Interior finish .....	Spanish cedar
Curtain fixtures.....	Forsyth	Journal bearings.....	Babbitt
Curtain material.....	Pantasote	Markers .....	Lintern
Fenders .....	Eclipse	Motors.....	4 Westinghouse 101
		Safety tread.....	Stanwood
		Seats .....	Wheeler

**Denver & Interurban Railroad, Denver, Colo.**, as reported in the Electric Railway Review of February 8, has placed an order with the St. Louis Car Company for eight double-truck closed motor cars with smoking and baggage compartments and four double-truck trailers. The contract was closed January 25, 1908, and delivery is to be made June 1, 1908. The specifications call for the following details:

Seating capacity—	Eight Motor Cars.		
Six cars.....	58 passengers	Height, inside.....	9 ft. 2¾ in.
Two cars.....	46 passengers	Sill to trolley base.....	10 ft. 6 in.
Weight .....	100,000 lb.	Height track to trolley base .....	14 ft. 3 in.
Wheel base .....	90 in.	Body .....	Wood
Length, over all .....	55 ft. 6 in.	Underframe .....	Metal
Width, inside .....	8 ft. 10½ in.		
Over all .....	10 ft. ¼ in.		

Four Trailers.

Seating capacity .....	58 passengers	Height, inside.....	9 ft. 2¾ in.
Weight .....	About 60,000 lb.	Sill to trolley base.....	10 ft. 3 in.
Wheel base .....	66 in.	Height track to trolley base .....	14 ft.
Length, over all .....	55 ft. 10 in.	Body .....	Wood
Width, inside .....	8 ft. 11½ in.	Underframe .....	Metal
Over all .....	10 ft. ¼ in.		

Special Equipment.

Air brakes .....	Westinghouse automatic	Journal boxes.....	Franklin
Bolster, body.....	Steel	Motors.....	4 Westinghouse
Bolsters, truck.....	Cast steel	Safety tread.....	Mason's carborundum
Brakeshoes .....	Sargent Diamond S	Sanders.....	Nichols-Lintern
Control system .....	Westinghouse	Seats .....	St. Louis
Curtain fixtures.....	Forsyth	Springs.....	Ry. Steel-Spring Co.
Curtain material.....	Pantasote	Trolley poles and attach-	
Hand brakes.....	Peacock	ments .....	Pantagraph
Heating system.....	Consolidated Car-Heating Co.	Trucks.....	Am. Loco. Co.
Journal bearings.....	Hewitt	Varnish .....	Murphy
		Trap doors.....	Edwards

**Twin City Rapid Transit Company, Minneapolis, Minn.,** has placed an order with the General Electric Company for 150 motor equipments. The car bodies will be built in the railway company's shops.

**Massillon Wooster & Mansfield Traction Company, G. A. Bartholomew, president, 1429 Williamson building, Cleveland, O.,** advises that it expects to order a portion of its rolling stock during the coming summer.

**New York New Haven & Hartford** has placed an order with the Westinghouse Electric & Manufacturing Company for six single-phase electric locomotives, which are to be duplicates of those now in use on this road and which have been described in detail in these columns.

**Rochester Syracuse & Eastern Railway, Syracuse, N. Y.,** was reported in the Electric Railway Review of February 8 to be in the market for two double-truck interurban cars. This order has practically been placed with the Cincinnati Car Company and will include the following details: Weight, 90,000 pounds; length of body, 43 feet 6 inches; length over all, 53 feet 6 inches; air brakes, Westinghouse; controlling system, Westinghouse multiple unit; motors, four Westinghouse, 125 horsepower; trucks, Baldwin.

#### TRADE NOTES.

**Allis-Chalmers Company, Milwaukee, Wis.,** has received orders recently for motors for the Lincoln (Neb.) Traction Company, Crane Company, Chicago, and Devoe & Reynolds, Chicago.

**Southern Car Company's** plant at High Point, N. C. was destroyed by fire on February 8. Twenty-three cars, almost completed, were burned. The loss is estimated at from \$80,000 to \$100,000.

**C. Lee Cook Manufacturing Company, Louisville, Ky.,** has recently installed in its plant a high-speed automatic engine, direct connected to a 50-kilowatt generator, which has several new features.

**Minneapolis Steel & Machinery Company, Minneapolis, Minn.,** has recently installed for the Mankato Electric Traction Company, Mankato, Minn., one of its 18 by 36 inch Corliss engines, direct connected to a 150-kilowatt Westinghouse generator.

**Robert McF. Doble, consulting and supervising engineer,** making a specialty of hydro-electric power development and transmission, formerly of San Francisco, Cal., announces the removal of his office from Colorado Springs to 528 Majestic building, Denver, Colo.

**Massachusetts Chemical Company, Walpole, Mass.,** reports a healthy reaction in business. The company has lined up many new customers for substantial contracts on its No. 264 tape and other brands, and the volume of business in Armalac shows that electric railways are getting their summer equipment into shape.

**Westinghouse Electric & Manufacturing Company's** reorganization committee has issued a synopsis of the plan for the readjustment of the company's debt. The committee calls the attention of creditors to the importance of the immediate deposit of their bonds, notes, claims or obligations, setting forth that if the plan can be speedily declared operative and an early termination of the receivership effected and the property and assets of the company promptly restored to its stockholders, the value of this great company and of its good will as a going concern will be preserved to the creditors and stockholders. The time to make deposits expires March 1.

**H. W. Johns-Manville Company, 100 William street, New York,** in accordance with its usual custom, held a convention of its branch managers in New York from January 29 to February 1. The managers of the various branches of the company throughout the United States were present at the meeting and a general discussion of the business affairs of the company took place. As a fitting wind-up of the convention a banquet was given to the managers at the Union League Club on Friday evening, January 31. The convention was undoubtedly a decided success by all present.

**G. Drouvé Company, Bridgeport, Conn.,** at the annual meeting of the directors, held February 3, 1903, elected G. Drouvé president and treasurer and William V. Dee secretary of the company. Mr. Dee, who recently resigned from The Railway Age to take an interest in the company, has been appointed general sales manager. The company manufactures the "Anti-Pluvius" skylight, of which 125,000 square feet has been installed on the Hoboken terminal of the Delaware Lackawanna & Western Railroad, and the Lovell window-operating device, now used in the shops of the New York

Central & Hudson River, Harmon, N. Y.; the Delaware Lackawanna & Western, Scranton, Pa.; and a number of other railroad shops; also Drouvé ventilators, drying stoves, etc.

**R. W. Marshall & Co. of New York,** after two years of much success with their Passburg vacuum drying and impregnating apparatus, have found it necessary to install a larger plant at their new factory, in addition to the present one, to properly care for increased business in this line. This new plant is one of the extremely large models, which, when in operation, about February 10, will enable them to impregnate more than 400 standard railway motor field coils a day. R. W. Marshall & Co. report that they are doing this work for practically all of the most important railways throughout the eastern territory, and are having remarkable success, which is due largely to the careful thought and study which the process has received at their hands. They will be glad to go into full detail with any railway company regarding this work, and will contract to impregnate all of their discarded field coils which have not been short-circuited, and also supply new ones on a very interesting basis. Their new factory is also fully equipped for making armature coils and overhauling and repairing all kinds of motors, controllers, large electrical machinery, etc.

#### ADVERTISING LITERATURE.

**Kalamazoo Railway Supply Company, Kalamazoo, Mich.—** A special catalogue is devoted to Root railway spring scrapers and fenders, a number of types of which are described and illustrated.

**Ohio Blower Company, Cleveland, O.—**A comprehensive catalogue, soon to be ready for distribution, will, it is stated, excel anything in this particular line, that of centrifugal steam and oil separators, cast-iron exhaust heads and gravity closing ventilators.

**T. H. Symington Company, Baltimore, Md., and Chicago, Ill.—**A recent publication is an attractive catalogue, briefly worded, but illustrating very fully by fine halftone cuts the various types of Symington journal boxes manufactured to suit different classes of service. The recently adopted standard of the American Street and Interurban Railway Association and several special types of journal boxes are illustrated. This company is the first producer of journal boxes to study the requirements of electric railway companies, with the result that the Symington box is said to be used on the majority of heavy electric trucks built in the past two years.

#### USE OF DOSSERT CONNECTORS.

Dossert solderless connectors, as illustrated in the accompanying cuts, are now being extensively used by the Chicago City Railway. The 2-way connector is being used to join



Solderless 2-Way Cable Connector.

cables of all sizes at points where there is no strain on the joint. As shown in the illustration, the ends of the cables to be joined pass into split double-cone compression sleeves,

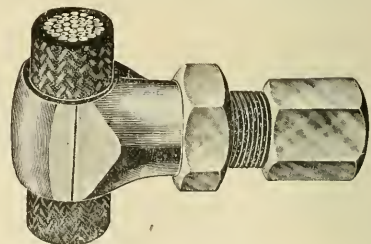

Cable Tap Connector.

which lie between a nipple and compression nuts at either end. When the parts are screwed together the compression sleeves are made to contract and grip the wire firmly, the action being like that of a wire chuck.

The Dossert cable tap connector is used for taps from the

feeder to the trolley wire. A substantial hook, carefully machined to fit the cable, is the principal part of this joint. The hook is large enough to give plenty of contact. The shank of the hook is drilled and threaded so as to form the nipple of the standard Dossert joint for the size of bleeder required. The casting which fits in the space between the cable and the base of the hook is held snugly in place by means of a jam nut. The hook is secured to the feeder cable with a vise-like grip and the copper wire, which is tapped onto the trolley wire, is inserted in the shank of the hook.

These connectors are manufactured by Dossert & Co., 242 and 244 West Forty-first street, New York.

#### SPECIALISTS IN RAILWAY LUMBER.

One of the lumber companies which has devoted practically all its attention since the organization to the railway business is the G. H. Barnes Hardwood Lumber Company of St. Louis, Mo.

In 1889 G. H. Barnes organized G. H. Barnes & Co. He was succeeded in 1896 by his son, G. H. Barnes, Jr., who is now president of the G. H. Barnes Hardwood Lumber Company. The other officers are M. D. Barnes, secretary, and M. H. Stiles, treasurer.

For 19 years the company and its predecessor have specialized on the railway business, handling all the different woods that this industry demands. In February, 1906, a yard was opened at Main and Warren streets, St. Louis, in which is carried a stock of walnut, mahogany, cherry, poplar, ash, hickory, white pine and plain and quarter-sawed oak. At the same time a supply of sawed and hewn ties is held in the country. The company has especial facilities for furnishing either white or red oak car stock, as well as bridge timber. In the St. Louis yards it is now carrying 1,500,000 feet of hardwood lumber and ties.

#### THE GRIP NUT.

The grip nut, as shown in the accompanying engraving, is a 1-piece self-locking nut designed to cure the loose and lost nut troubles. The distinctive feature of the grip nut is that it will not work loose no matter to what working stress, vibration or jar it is subjected. It is made of special steel and, as may be seen from the illustration, it is made with an arched section at the thread portion. It is tapped the same as an ordinary nut and then given a slight deflection along the crown of the arch, which changes the pitch of the threads in the arched section to a slight downward curve, while the threads in the straight portion remain in true plane with the

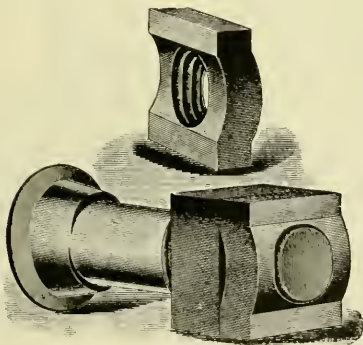

The Grip Nut.

bolt threads, causing it to grip the bolt threads with a positive friction lock, regardless of its contact with the main nut.

In ordinary double-nut practice the use of a check or jam nut, as commonly applied, results in making the first nut act simply as a washer, because the pressure of the upper nut when wrenched hard on the first nut forces the first nut down so that its threads have no pressure against the under side of the bolt threads and the second nut carries the load. The use of a grip nut as a second nut does not affect the holding power of the first nut. Its function is simply to prevent the first nut from backing off under vibration and working stress. The pressure of the threads in the arched position of the nut is against the upper side of the bolt threads, while

the pressure of the threads in the straight position of the nut is against the under side of the bolt threads. The grip nut thus insures full service from the first nut while giving additional load strength.

The grip nut when used as a second nut is applied with a wrench on top of the main nut and automatically locks itself positively and permanently on any part of the bolt to which it may be wrenched. It should not be wrenched so tightly against the main nut as to take the set or curve out of it, as it does not require to be jammed to hold. It causes no injury to the threads and can be readily removed with a wrench at will and used many times over. It requires no special thread, hole, slot or other change in the standard bolt, and does away with the use of ordinary nut locks, jam nuts, spring washers, cotter pins, keys or other auxiliary fastenings.

In addition to its use as a check nut the grip nut may be used as a single nut for any service within its own load strength and where the principal stress is on the bolt and not on the nut it has many advantages.

Nuts of this kind have been tested in severe service during the past three years and have fully demonstrated their usefulness and effectiveness on both steam and electric railways. They have been used extensively for the severe service of crossing frogs, switches, etc., and are especially adapted for holding absolutely tight nuts on bolts used in gear cases, split gears, motor axle bearings, armature bearings and at various other points on cars and trucks. The agency for electric railways has recently been taken by the Electric Service Supplies Company, Philadelphia, Chicago and Keokuk.

The grip nut is made in standard dimensions in both square and hexagon shapes.

#### STEEL WOOL JOURNAL PACKING.

Until very recent years no special engineering work has been devoted to the betterment of lubricating methods for electric railway journals and motor bearings. Of late, how-



Steel Wool Journal Packing.

ever, the increased service demanded of such journals and bearings has brought forth many types of special journal boxes and lubricating methods. These have grown more or less in favor, but have not by any means supplanted the formerly used oil and waste methods of lubricating car journals. One of the most important advancements in lubricating methods for the services mentioned has been the introduction of "Steel Wool Journal Packing," manufactured by W. Robertson & Co., fifth floor Great Northern building, Chicago. This material has been carried far beyond the experimental stage and is said to effect a saving of 33½ per cent in oil alone over former methods. Steel wool journal packing is suitable for armatures as well as for journal boxes and for such use is now in service on the South Side Elevated Railroad, Chicago, and other representative electric railways in the United States and abroad.

A brief description of this valuable material may be of interest. Steel wool journal packing is a mixture of 50 per cent of the best long fiber cotton waste and 50 per cent of steel wool, cut by special machinery from raw material manufactured from a special analysis. This produces a cutting low in carbon yet with ample resiliency to secure to this product sufficient spring to carry the weight of the oil and stand well up against the journal—and that, too, without packing the journal tightly.

It is the consensus of opinion that cotton waste has

greater capillarity for oil than wool. Used alone its tendency to sag, cake and roll renders it unsatisfactory. Steel wool overcomes these difficulties by imparting to the waste the necessary expansiveness, resiliency, flexibility and wearing qualities. Steel wool is a preventive of the formation of the metallic incrustation ever present on the surface in contact with the journal, which, as is well known, is fatal to proper lubrication and the cause of 60 per cent of all hot boxes.

The packing is always free and porous, allowing the dust and dirt to sift through it, and thence down to the bottom of the cellar of the journal box. This keeps the waste comparatively clean and is one of the reasons for its long life. That 90 per cent of the dust and dirt does not remain in the waste, but sifts through and is held in the bottom of the journal box, has been shown by tests covering a period of two years under extraordinary and adverse conditions. Only clean oil remains in the packing.

Steel wool journal packing is guaranteed by the manufacturer to keep its good condition and position for 15 months from the time it is applied. In other words, its shortest life is, with but little attention and no renewals, 15 months.

The hot box is reduced to the minimum and is positively overcome where it can be attributed to the fault of the packing. The success of this packing, as earlier stated, has been carried beyond the experimental stage, and is now a standard product in the warehouses of a number of lines.

#### STOVER 12-PASSENGER MOTOR CAR.

The accompanying engraving illustrates a new 30-horsepower motor car which accommodates 12 passengers, recently

to give service at times when the traffic would not warrant keeping the power house in operation this car is especially adapted. Logging roads have found it especially suited to their needs. Experiments made by the Stover company indicate that the car is very economical in the use of fuel, the consumption being not to exceed one gallon of gasoline for a run of from 12 to 15 miles.

The car is equipped with the Stover 4-cylinder gasoline engine which develops 30 horsepower. The cylinders are each  $4\frac{1}{2}$  inches in diameter and 5 inches in stroke. The details of design and particulars concerning materials used in the Stover motor are doubtless familiar to our readers, having been described in connection with illustrations of other cars built by this company which we have published recently. In connection with the motor the Hill precision oiler, driven mechanically by the engine, is used. The ignition is with an Exide storage battery, though the motor is so wired that a set of dry cells may be used in case of emergency.

The transmission is of the friction type and the car may be driven either forward or backward. The connection to the drive axle is by a Morse silent chain. The control of the car is by two levers, placed conveniently in front of the operator and mounted on the same post with brake wheel. One lever governs the amount of gas entering the cylinders of the motor through the carburetor and the other lever times the ignition. Ordinarily the car would be geared for 30 miles per hour with full load on level track.

The frame of the car is of heavy channels, and the body is suspended on long semi-elliptic springs. The wheels are of cast steel, mounted on steel axles with Hyatt roller bearings. Brakes are provided on all four wheels. The car is



Stover 12-Passenger Motor Car.

designed by the Stover Motor Car Company of Freeport, Ill. For small roads not electrically equipped and for short branch lines on which the traffic is periodic and not sufficient to justify the expense of electrification it has developed that there is often use for a car of this character on which the power cost is only for the time the car is actually in operation, and the manufacturer is confident that the field for the car is to be a large one. For night service on certain lines, such as branches to manufacturing plants which run all night during a part of the year, or in other cases where it is desirable

furnished with an acetylene headlight, nine inches in diameter; a complete carbide generator; oil tail lights are used.

W. H. S. Wright Supply Company, St. Paul, Minn., has been incorporated to conduct the business established by the late W. H. S. Wright. The officers of the company are B. W. Parsons, president and treasurer, and Mrs. W. H. S. Wright, secretary. The new concern has retained all the accounts handled by Mr. Wright, among them the St. Paul representation of the Railway Steel-Spring Company of New York.

# The Grip Nut

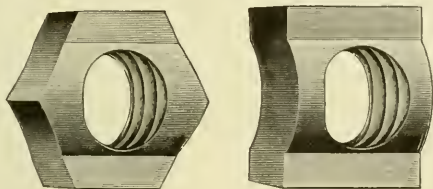

Among the various economies and advantages of the Grip Nut are:

Elimination of loose and lost holding nuts. Low cost. High individual load strength. Simplicity; no complexity of stock, as involved by the use of nut locks. Advantage in clearance over ordinary jam nuts. Absolute assurance of full service from holding nut, whether applied loosely or jammed up. Its "setting up" quality as elastic as a bolt thread. Reports received agree that **Grip Nuts** prolong the life of crossings, insulated joints and all equipment to which they are applied.

*Used by the United States Government.*

**Grip Nut Company**  
New York Chicago

# U.S. Metal & Mfg. Co.

25 Broad Street, New York

Pittsburg, 1509 Arrott Bldg. Chicago, 414 Railway Exchange

## Perfect <sup>Pressed</sup> Steel Car Replacer

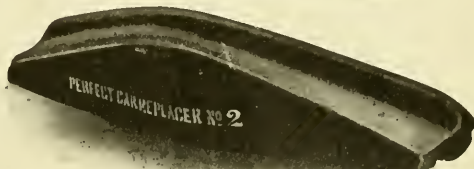

Size No. 2. For Interurban and Electric Railroads

Weight, 55 pounds per set. Will fit any size rail from 5 inches down.

3

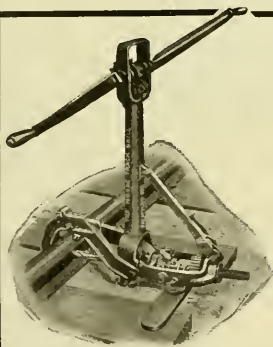

# The Moore Track Drill

does not interfere with traffic!

The shifting of one lever and a few seconds' time takes down the drill—the operation reversed makes it ready for work again.

This is only one of the many strong points about the Moore Track Drill that make it worth buying.

*Ask for descriptive catalogue.*



**Kalamazoo Railway Supply Co.** Kalamazoo Michigan

1

# Interchangeable?

Yes, it is the standard type selected by the A. S. & I. R. A. Standardization Committee. Its adoption on your road will bring not only **uniformity**, but **economy** as well.

The facts in the case sent on your request

**American Brake Shoe & Foundry Co.**  
New York Chicago Chattanooga MAHWAH, N. J.



The M. C. B. Christie Flanged Steel Back Brake Shoe for use on wheels with 3-inch tread and over.

5

# THE J. G. BRILL COMPANY, PHILADELPHIA, PA.

AMERICAN CAR COMPANY, ST. LOUIS, MO.

G. C. KUHLMAN CAR COMPANY, CLEVELAND, OHIO

JOHN STEPHENSON COMPANY, ELIZABETH, N. J.

WASON MANUFACTURING CO. SPRINGFIELD, MASS.

MAIN OFFICE: PHILADELPHIA, PA.  
LONDON OFFICE: 110 CANNON ST. E. C.  
PACIFIC COAST AGENTS: PIERSON  
ROEDING & CO., SAN FRANCISCO.  
AUSTRALIAN AGENTS: NOYES  
BROTHERS, SYDNEY. CABLES:  
"BRILL," PHILA., "AXLES" LONDON.

*CARS TRUCKS SEATS RATTAN SPRINGS SPECIALTIES SUPPLIES*

## FOR HIGH EFFICIENCY

The centrifugal pump is used in fire engines because it is the simplest and most effective means of producing pressure. It is used in the Brill power sprinkler for the same reason. The centrifugal pump is operated by a direct-connected motor (both located on the platform at one end of the car) and supplies pressure for distributing the water uniformly over fifty feet of roadway on each side of the track. The pump shaft has the only wearing surface in the entire mechanism, so no trouble is caused by heated parts. The amount and direction of the water is always under perfect control by the patented type of sprinkling head employed. Write for catalog.

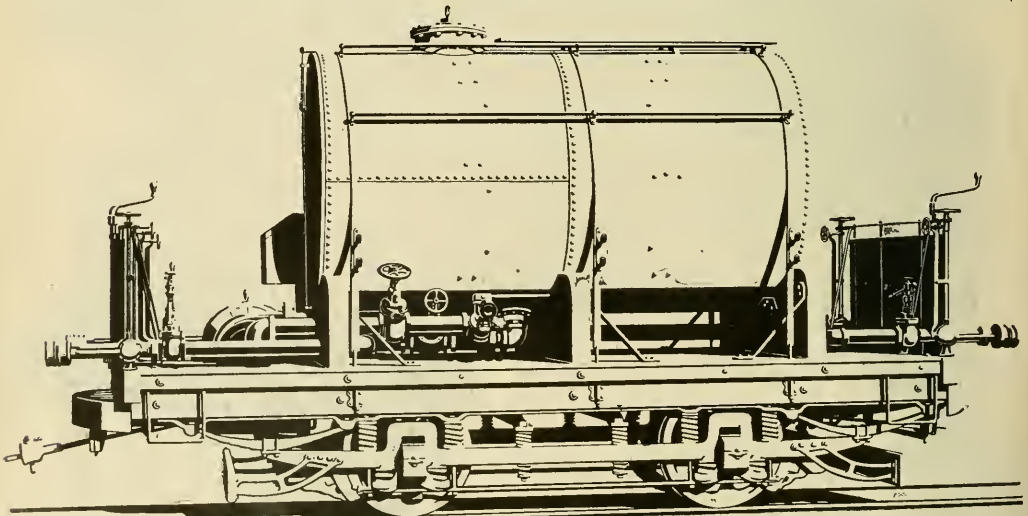

*THE BRILL CENTRIFUGAL SPRINKLER (PATENTED)*

# General Electric Company

## Hood Switch

Type MS-8

For Railway Equipments

Suitable for Equipments not exceeding 180 H. P. total.



## Enclosed Quick Break



SMALL

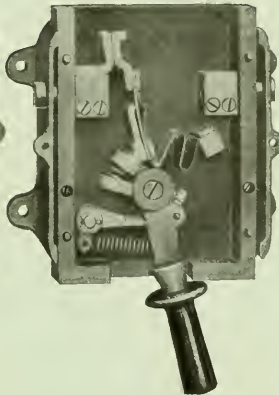

COMPACT



RELIABLE

**Quick Break:** Held closed by positive catch and forced open by compression spring. Cannot remain in any position except full-on or full-off.

**Insulation:** No "live" parts exposed. All working parts encased in fibre box.

**Operation:** Arc rupture quickly and positively enforced by magnetic blowout.

All parts readily accessible for repair and inspection.

1584

Chicago Office:  
Monadnock Building

Principal Office:  
**Schenectady, N. Y.**

Sales Offices in  
All Large Cities

**LUFKIN**

**MEASURING TAPES**  
are the choice of expert electrical engineers in all quarters of the globe. Absolute accuracy and the highest possible degree of durability make them especially adapted to Electric Railway Work.

New York, London, Eng., Windsor, Can.  
**THE LUFKIN RULE CO.**  
SAGINAW MICH., U. S. A.



**VOLTALAC**

**FOR INSULATING ARMATURE AND FIELD COILS**

Almost Every Big Electric Railway in the U. S. and Europe uses it.

**STANDARD VARNISH WORKS**  
LONDON NEW YORK CHICAGO



The Recording Fare Register Company

**New Haven, Conn.**



Repair your **Broken Motor Cases WITH THERMIT**

Pamphlet No. 35-Q gives full details.

**Goldschmidt Thermit Co.**  
90 West St., New York  
432-436 Folsom Street - San Francisco



# What Would It Be Worth

to know that your road was positively protected against collisions?

You could easily have the sense of security this knowledge would bring if your road invested in a Telegraph Signal equipment. The installation cost is smaller than you may imagine. One dollar a month per station pays the maintenance—that's mighty cheap safety insurance, isn't it? *Ask for the detailed facts, please.*

**Telegraph Signal Company, 282 State St., Rochester, N. Y.**



# Baltimore Center and Side Bearings

## FOR ELECTRIC TRUCKS

**Impossible to Clog Balls**



**No Lubrication Necessary**

**SAVES:** { FLANGE WEAR  
RAIL WEAR  
TRUCK REPAIRS

**DURABILITY:** { PROVEN UNDER HEAVIEST LOADS

BALTIMORE MD.

**THE T. H. SYMINGTON CO.**

CHICAGO ILL.



# Electric Railway Review

PUBLISHED EVERY SATURDAY.

FORMERLY THE STREET RAILWAY REVIEW.

THE WILSON COMPANY, CHICAGO.

160 Harrison Street, Chicago  
150 Nassau Street, New York  
1529 Williamson Bldg., Cleveland

VOL. XIX  
No. 8

CHICAGO, FEBRUARY 22, 1908

Whole No.  
252

Subscription: Domestic . . . \$2  
Foreign . . . \$5  
Canada . . . \$3.50

## America's Electric Railways

have made a good beginning for a prosperous year, and all indications point to a business better than that of the average year.

They will undoubtedly carry more passengers in more cars over more miles of track than they ever did before.

*This means more business for electric railway supply houses*, for new cars must be purchased to provide for a constantly increasing travel, as well as to replace antique equipment no longer fit for service. More track, too, both for new lines and for extensions of old roads. And, of course, more power plants and all that goes with them.

In Chicago alone many millions of dollars will be expended by the Chicago City Railway and the Chicago Railways Company under the recently accepted rehabilitation ordinances.

*Do you intend to get your share of 1908's business?*

The way to get it is to go after it—and don't overlook the fact that the most valuable and least expensive aid in going after business is advertising—*real* advertising. Because this kind of advertising will help, in a dozen different ways, to sell your goods, and will work for you all the time.

There are many other good reasons why it will pay you to do real advertising in the

## Electric Railway Review

best edited, illustrated and printed, most progressive, up-to-date and rapidly growing in its field.

# ARMATURE AND FIELD COILS

of a Special Manufacture and High Quality

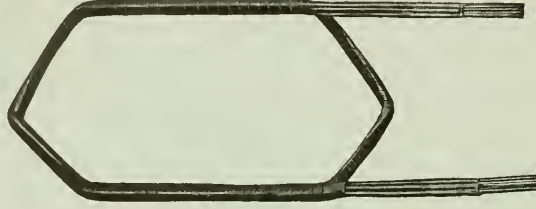

Armature Coils furnished by this Company have a special form of mica insulation. All coils are made to fit perfectly in slots without hammering and are thoroughly tested before leaving the factory.

Field Coils are placed under a vacuum, which removes all objectionable moisture. They are then impregnated with a solid compound which gives them high insulation and high heat resistance.

## ELECTRIC SERVICE SUPPLIES Co.

"Supplies for Every Electric Service"

MAYER & ENGLUND DEPT.  
PHILADELPHIA

NEW YORK

GARTON-DANIELS DEPT.  
KEOKUK

PITTSBURG

PORTER & BERG DEPT.  
CHICAGO

SAINT LOUIS

ATLANTA

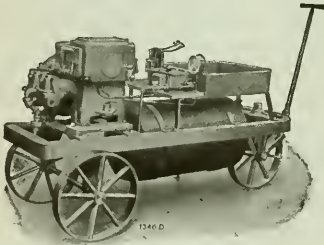

Portable Outfit with A-1 Compressor

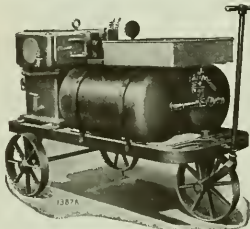

Portable Outfit with CC-3 Compressor

## National Portable Air Compressor Outfits

are especially adapted for service in car shops where compressed air is used for various operations such as drilling, chipping, riveting and for blowing dust and other matter out of car motors, car seats, etc. They are built in capacities of from 11 to 50 cubic feet of free air per minute. The 11 and 35 cubic foot sizes are illustrated herewith.

The small width of National Portable Outfits permits of their being taken through doors and other openings of much smaller width than the average.

Bulletin Sent on Request

## National Brake & Electric Co.

NEW YORK: 111 Broadway  
PHILADELPHIA:  
W. H. Goble, 1722 Westmoreland St.  
BOSTON: F. E. Huntress, 131 State St.

Milwaukee, U. S. A.

SAN FRANCISCO, CAL.: W. F. McEneny,  
69-71 First Street  
LONDON: 14 Great Smith St., Westminster

General Sales Office: 519 First National Bank Building, Chicago

# Westinghouse

## Repair Parts

Take No Risks

Have Westinghouse apparatus repaired only with Westinghouse material, by Westinghouse skilled labor, in the Westinghouse factory. You can not expect it to maintain its high standard if repaired with inferior material. Take no risks.

Our nearest office will give full information



Brush Holders

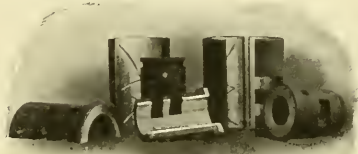

Bearings

## Westinghouse Electric & Mfg. Co.

Atlanta  
Baltimore  
Boston

Buffalo  
Chicago  
Cincinnati

Cleveland  
Dallas  
Denver

Detroit  
Kansas City  
Los Angeles  
Minneapolis

New Orleans  
New York  
Philadelphia

Pittsburg  
St. Louis  
Salt Lake City

San Francisco  
Seattle  
Syracuse

Canada: Canadian Westinghouse Co., Ltd., Hamilton, Ontario Mexico: G. & O. Braniff & Co., City of Mexico

## The Roney Stoker

The success of a stoker plant is generally a question of good engineering and an intelligent investigation of the conditions surrounding the proposed installation.



**We Suggest** if you are interested in mechanical stokers, either for new boilers or for a plant already in operation, that you make use of the extensive experience we can offer you in this important department of steam engineering.

Ask for Roney Stoker Catalogue

**The Westinghouse Machine Co.**  
Pittsburg, Pa.

## Are you still using hand brakes?

If so, save over 10% in the operating cost of your cars by substituting

## Westinghouse "AMM" Automatic Brakes

with quick-recharge, graduated-release, quick-service, high-pressure emergency features, and adapted to 1, 2, 3, 4 and 5 car train service.

Statistics indicate the saving to be over 10%; viz., with hand brakes the tendency is to drag brake shoes in crowded city streets, resulting in increased current consumption. In addition shorter schedules are possible with the "AMM" equipment.

Full particulars in Instruction Book T-5031.

## Westinghouse Traction Brake Co.

General Offices: Pittsburg, Pa.  
Chicago, St. Louis  
New York, Trinity Building, Ry. Exchange Building, 1932 N. Broadway  
For Canada: Canadian Westinghouse Co., Ltd., Hamilton, Ont.

## ALPHABETICAL INDEX TO ADVERTISEMENTS.

Advance Lumber Co.....16	Droué, The G. Co.....22	Milloy Electric Co., The.....7	Smith, Peter, Heater Co.....7
Allis-Chalmers Co.....23	Drummond Detective Agency.....	Model Stoker Co., The.....16	Speer Carbon Co.....14
Aluminum Co. of America.....11	Eclipse Railway Supply Co.....18	Morden Frog & Crossing Wks. 7	Standard Brake Shoe Co.....14
American Brake Shoe & Fdry. Co. ....22	Electric Railway Equipment Co. ....13	National Brake & Electric Co. 2	Standard Motor Truck Co.....14
American Electrical Works.....	Electric Ry. Improvement Co. 5	National Lock Washer Co.....16	Standard Steel Works.....18
American Frog & Switch Co. ....17	Electric Service Supplies Co. 2	National Pole Co.....16	Standard Underground Cable Co. ....12
Anderson, Albert & J. M., Mfg. Co. ....17	Engineers and Contractors.....14	Naugle Pole & Tie Co.....16	Standard Varnish Works.....7
Armstrong Oiler Co.....13	Fairbanks, Morse & Co.....	New York Switch & Crossing Co. ....13	Star Brass Works.....18
Arnold Company.....14	Ford, Bacon & Davis.....	Niles Car & Mfg. Co.....15	Stone & Webster Engineering Corporation.....14
Atlas Anchor Co.....13	Galena-Signal Oil Co.....11	Northern Engineering Works.....	Stuart-Howland Co.....21
Babcock & Wilcox Co.....12	General Electric Co.....25	Nuttall, R. D. Co.....	Symington, T. H., Co.....26
Baker, The Wm. C., Heating & Supply Co.....15	Goldschmidt Thermit Co.....14	Ohio Brass Co.....	Telegraph Signal Co.....23
Baldwin Locomotive Works.....13	Green Engineering Co.....	Okonite Co., Ltd.....	Trolley Supply Co.....7
Barbour-Stockwell Co.....	Green Fuel Economizer Co.....13	Pacific Coast Pole Co.....16	Under-Feed Stoker Co.....18
Barnes, G. H., Hardwood Lumber Co. ....16	Griffin Wheel Co.....13	Payson Co.....	United States Graphite Co., The.....9
Beidler, Francis, & Co.....16	Grip Nut Co.....23	Patten, Paul B.....21	U. S. Metal & Mfg. Co.....
Bellamy Vestlette Mfg. Co.....	Hagy, J. Milton, Waste Wks. 12	Pay-As-You-Enter Car Co.....9	Van Dorn & Dutton Co.....14
Berthold & Jennings.....16	Hale & Kilburn Mfg. Co.....16	Porter Mfg. Co., The.....21	Van Dorn, W. T., Co.....18
Blake Signal & Mfg. Co.....	Hartshorn, Stewart, Co.....	Power Specialty Car Co.....	Van Valkenburgh, E. C.....21
Bliss, R. Mfg. Co.....	Heine Safety Boiler Co.....21	Pressed Steel Car Co.....	Wanted and For Sale Cards.....
Bridgport Engine Works.....23	Heywood Bros. & Wakefield Co. ....	Queen & Co.....17	Washington Street Castings & Coupler Co.....23
Brill, The J. G. Co.....24	Holman, D. F., Ry. Tracklayer Co. ....	Rail Joint Co.....7	Watson-Stillman Co.....7
Brown, Harold P.....	Hope Webbing Co.....26	Railway Specialty & Supply Co. ....	Wendell & MacDuffie.....5
Brown Hoisting Machy. Co. 14	Humbird Lumber Co., Ltd.....	Recording Fare Register Co. 26	Westinghouse Elec. & Mfg. Co. ....3
Buckeye Engine Co.....21	Indestructible Fibre Co.....	Read, Francis, Co.....17	Westinghouse Traction Brake Co. ....3
Burnham, Williams & Co.....13	Jewett Car Co.....15	Register, A. L. & Co.....14	Weston Electrical Instrument Co. ....17
Byllesby, H. M., & Co.....18	Johann, F. A.....21	Reiter, G. C.....21	Wharton, Wm., Jr., & Co.....
Central Inspection Bureau.....14	Johns-Manville, H. W., Co. 5	Ridlon, Frank, Co.....	Wheler Condenser & Eng'g Co. ....
Chase-Shawmutt Co.....11	Kalamazoo Ry. Supply Co.....26	Roberts & Abbott Co.....	Wheel Truing Brake Shoe Co. ....14
Churchill Cedar Co.....16	Kilmear Manufacturing Co.....	Robertson, Wm., & Co.....22	White, J. G., & Co.....14
Cincinnati Car Co.....15	Linley Bros. Co., The.....16	Rodger Ballast Car Co.....14	White, J. G., & Co., The.....17
Cincinnati Frog & Switch Co. ....	Lorain Steel Co.....18	Rooke Automatic Register Co. 13	Wilson, J. G., Mfg. Co.....
Cleveland Armature Works.....23	Lord & Burnham Co.....21	Rositer, MacGovern & Co. 17	Wood, Guilford S.....12
Cleveland Frog & Cross. Co. ....	Lukin Rule Co.....26	Russell Car & Snow-Plow Co. 21	Woodman, R., Mfg. & Supply Co. ....
Collier, Barron G.....	Lumen Bearing Co.....21	S. E. Missouri Cypress Co.....16	Worcester, C. H., Co.....16
Columbia Construction Co.....	Macallen Co.....	St. Louis Car Co., Mansfield, O. ....	Zelnicke, Walter A., Supply Co. ....21
Consolidated Car Bender Co. 23	McGuire-Cummings Mfg. Co. ....	St. Louis Car Wheel Co.....14	
Consolidated Car-Heating Co. 14	Marshall, R. W., & Co., 95 Liberty St., New York.....	St. Louis Surfacer & Paint Co. ....21	
Contractors' Supply & Equipment Co. ....14	Marshall, R. W., & Co., 95 Liberty St., New York.....	Sanderson & Porter.....	
Cuiper Heater Co.....17	Massachusetts Chemical Co. 12	Saxton, New York.....	
Crane Co.....	Mevers, Fred J., Mfg. Co.....	Shimer & Chase Co.....14	
Craghead Engineering Co. 14	Mills, Fred J., Mfg. Co.....	Sheaff & Jastaad.....	
Curtain Supply Co.....14	Milner Anchor Co.....	Simmons, John, Co.....18	
Davis, The John, Co.....			
Dearborn Drug & Chemical Works.....17			
Detroit Graphite Co.....23			

## CLASSIFIED LIST OF ADVERTISERS.

Advertising Service.	Armature Lifts.	Bells and Gongs—Continued.	Bonds, Rail—Continued.
Van Valkenburgh, E. C., 2117 West One Hundred and Second St., Chicago.	Electric Service Supplies Co., 300 Plymouth Bldg., Chicago.	Kuhlman, The G. C., Car Co., Cleveland.	Goldschmidt Thermit Co., 43 Exchange Pl., New York.
Advertising, Street Car.	Asbestos Materials.	McGuire-Cummings Mfg. Co., Chicago.	Johns-Manville, H. W., Co., New York.
Collier, Barron G., Flat Iron Bldg., New York.	Johns-Manville, H. W., Co., New York.	Ohio Brass Co., Mansfield, O.	Ohio Brass Co., Mansfield, O.
Air Brakes—(See Brakes and Brake Parts).	Axles—(See Wheels and Axles).	Reiter, G. C., Canton, O.	Anderson, Albert & J. M., Mfg. Co., Boston.
Air Compressors—(See Compressors, Air).	Babbitt Metals—(See Alloys and Bearing Metals).	St. Louis Car Co., St. Louis, Mo.	Craghead Engineering Co., Cincinnati, O.
Alloys and Bearing Metals.	Badges and Buttons.	Stephenson, John, Co., Elizabeth, N. J.	Electric Railway Equipment Co., Cincinnati, O.
Brown, H. P., 120 Liberty St., New York.	Electric Service Supplies Co., 200 Plymouth Bldg., Chicago.	Western Electric Co., Chicago.	Electric Service Supplies Co., 200 Plymouth Bldg., Chicago.
General Electric Co., Schenectady, N. Y.	Recording Fare Register Co., New Haven, Conn.	Black Lead.	Johns-Manville, H. W., Co., New York, N. Y.
Harrison Elec. & Mfg. Co., 169 South St., New York.	Ballast Cars—(See Cars, Ballast).	Detroit Graphite Co., Detroit, Mich.	U. S. Graphite Co., Saginaw, Mich.
Lumen Bearing Co., Buffalo, N. Y.	Ball Bearings.	Mich.	
Ohio Brass Co., Mansfield, O.	Symington, T. H., Co., Baltimore, Md.	Block System—(See Signals).	
Ridlon, Frank, Co., 200 Summer St., Boston.	Bases—(See Trolley Poles and Fittings).	Blowers—(See Mechanical Draft).	
St. Louis Car Co., St. Louis, Mo.	Bearings.	Blue Printing Machines.	
Aluminum Wire, Etc.	Electric Service Supplies Co., 200 Plymouth Bldg., Chicago.	Buckeye Engine Co., Salem, O.	
Aluminum Co. of America, Pittsburg.	General Electric Co., Schenectady, N. Y.	Boilers.	
Anchor.	Harrison Elec. & Mfg. Co., 169 South St., New York.	Babcock & Wilcox Co., N. Y.	
Atlas Anchor Co., Cleveland, O.	Lumen Bearing Co., Buffalo, N. Y.	Fairbanks, Morse & Co., Chicago.	
Electric Service Supplies Co., 200 Plymouth Bldg., Chicago.	McGuire-Cummings Mfg. Co., Chicago.	Green Fuel Economizer Co., Matteawan, N. Y.	
Miller Anchor Co., Norwalk, O.	Marshall, R. W., & Co., 95 Liberty St., New York.	Heine Safety Boiler Co., 421 Olive St., St. Louis.	
Ohio Brass Co., Mansfield, O.	Nuttall, R. D. Co., Pittsburg.	Lord & Burnham, Irvington-on-Hudson, New York.	
Armatures and Coils, Winding and Repairing.	Ohio Brass Co., Mansfield, O.	Rositer, MacGovern & Co., 17 Battery Pl., New York.	
Cleveland Armature Works, Cleveland, O.	Ridlon, Frank, Co., 200 Summer St., Boston.	Battery Pl., New York.	
Electric Service Supplies Co., 200 Plymouth Bldg., Chicago.	Symington, T. H., Co., Baltimore, Md.	Boiler Cleaning Compound.	
General Electric Co., Schenectady, N. Y.	Van Dorn & Dutton Co., Cleveland, O.	Dearborn Drug & Chemical Works, Chicago.	
Harrison Elec. & Mfg. Co., 169 South St., New York.		Johns-Manville, H. W., Co., New York.	
Marshall, R. W., & Co., 95 Liberty St., New York.	Bells and Gongs.		
Ridlon, Frank, Co., 200 Summer St., Boston.	American Car Co., St. Louis.		
Stuart-Howland Co., Boston.	Brill, The J. G., Co., Philadelphia.		
	Electric Service Supplies Co., 1020-24 Filbert St., Phila.		

# WESTERN ELECTRIC

CHICAGO DENVER PITTSBURG COMPANY SAINT PAUL NEW YORK  
SAINT LOUIS PITTSBURG SAN FRANCISCO SEATTLE CINCINNATI ATLANTA  
SALT LAKE CITY LOS ANGELES KANSAS CITY PHILADELPHIA

The Buffalo Grip never lets go. It is the most popular tool of its class ever placed on the market because



BUFFALO GRIP WITH PULLEY

it grips the wire firmly and will not slip under the severest tension. It will not injure the softest wire. *Send today for circular and prices*

## Ten reasons why you should use the Victor Combination Meter



- 1.—It accomplishes the results of three ordinary meters—therefore saves price and switchboard space of two meters.
  - 2.—Gives volts, amperes, watts and horsepower readings on one dial at a glance. Eliminates possibility of error in calculation. Saves watching two meters to ascertain power consumption on fluctuating loads.
  - 3.—Indicates the most rapid fluctuations of pressure or load with unvarying accuracy.
  - 4.—Pays for itself in a short time by quick determination of conditions that produce the greatest economy in use of current.
  - 5.—Is permanent in calibration, dead beat and requires a minimum of energy to operate.
  - 6.—Can be left in circuit indefinitely at full rated capacity without danger to itself or error due to excessive heating.
  - 7.—Unaffected by temperature changes.
  - 8.—Shunts are interchangeable, and generate no thermo-electric motive force.
  - 9.—Is lighter than two single-unit meters, consequently easier to carry.
  - 10.—Is substantial in construction, dust-proof and handsomely finished.
- Made in two types—Portable and Switchboard. We'd like to send you catalog fully describing the Victor.

*Write nearest branch for catalog.*

### H. W. JOHNS-MANVILLE COMPANY



NEW YORK  
MILWAUKEE  
CHICAGO  
BOSTON  
PHILADELPHIA  
ST. LOUIS

PITTSBURG  
CLEVELAND  
BUFFALO  
BALTIMORE  
NEW ORLEANS  
KANSAS CITY

MINNEAPOLIS  
SAN FRANCISCO  
LOS ANGELES  
SEATTLE  
DALLAS  
LONDON 755

# A Portable Bonding Car

that will save a sum equal to its cost in six months' work. It does perfect bonding and rebonding by modern methods—

## Electric Brazing AND Copper Welding

*Our definition of perfect bonding is:*

An amalgamation of rail and bond possessing greatest conductivity and longest life, produced at least cost,

*May we tell you more bonding facts?*

### THE ELECTRIC RAILWAY IMPROVEMENT COMPANY

6005 Carnegie Ave. . . . CLEVELAND, OHIO

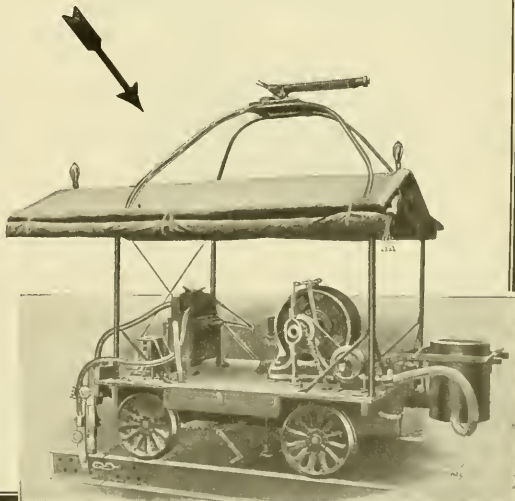

## CLASSIFIED LIST OF ADVERTISERS—Continued.

- Brakeshoes—Continued.**  
Brill, The J. G. Co., Philadelphia.  
Kuhlman, The G. C., Car Co., Cleveland.  
McGuire-Cummings Mfg. Co., Chicago.  
Marshall, R. W., & Co., 95 Liberty St., New York.  
St. Louis Car Co., St. Louis, Mo.  
Standard Brake Shoe Co., Aurora, Ill.  
Stephenson, John, Co., Elizabeth, N. J.  
Wason Mfg. Co., Springfield, Mass.  
Wharton, Wm., Jr., & Co., Philadelphia.  
Wheel Truing Brake Shoe Co., Detroit.
- Bridges.**  
Johann, F. A., 1624 Pierce Bldg., St. Louis.
- Bridge Timbers.**  
Beidler, Francis, & Co., Chgo.
- Bruahes, Motors and Dyanmos.**  
Electric Service Supplies Co., 200 Plymouth Bldg., Chicago.  
General Electric Co., Schenectady, N. Y.  
Ridlon, Frank, Co., 200 Summer St., Boston.  
Spear Carbon Co., St. Marys, Pa.
- Bumpers, Car.**  
American Car Co., St. Louis, Brll, The J. G. Co., Philadelphia.  
Kuhlman, The G. C., Car Co., Cleveland.  
St. Louis Car Co., St. Louis, Mo.  
Stephenson, John, Co., Elizabeth, N. J.  
Wason Mfg. Co., Springfield, Mass.
- Car House Doors.**  
Kinnear Mfg. Co., Columbus, O.  
Wilson, J. G., Mfg. Co., New York.
- Car Replacers.**  
Electric Service Supplies Co., 200 Plymouth Bldg., Chicago.  
Fairbanks, Morse & Co., Chgo.  
Kalamazoo Railway Supply Co., Kalamazoo, Mich.  
Ohio Brass Co., Mansfield, O.  
U. S. Metal & Mfg. Co., 25 Broad St., New York.
- Car Roof Paint, Canvas.**  
St. Louis Surface & Paint Co., St. Louis, Mo.
- Car Seats.**  
American Car Co., St. Louis, Brill, The J. G. Co., Philadelphia.  
Hale & Kilburn Mfg. Co., Philadelphia.  
Heywood Bros. & Wakefield Co., Wakefield, Mass.  
Kuhlman, The G. C., Car Co., Cleveland.  
St. Louis Car Co., St. Louis, Mo.  
Stephenson, John, Co., Elizabeth, N. J.  
Wason Mfg. Co., Springfield, Mass.
- Car Signs—(See Signs, Cars and Track).**
- Car Steps.**  
Electric Service Supplies Co., 200 Plymouth Bldg., Chicago.
- Car Trimmings—(See Trimmings, Car).**
- Cars, Ballast.**  
Rodger Ballast Car Co., Chgo.  
St. Louis Car Co., St. Louis, Mo.
- Cars, Dump.**  
Fairbanks, Morse & Co., Chgo.  
Rodger Ballast Car Co., Chgo.  
Russell Car & Snow-Plow Co., Ridgway, Pa.  
St. Louis Car Co., St. Louis, Mo.
- Cars, Passenger and Freight—Continued.**  
Kuhlman, The G. C., Car Co., Cleveland.  
McGuire-Cummings Mfg. Co., Chicago.  
Niles Car & Mfg. Co., Niles, O.  
Pressed Steel Car Co., Pittsburg.  
Rodger Ballast Car Co., Chgo.  
Russell Car & Snow-Plow Co., Ridgway, Pa.  
St. Louis Car Co., St. Louis, Mo.  
Standard Motor Truck Co., Pittsburg.  
Stephenson, John, Co., Elizabeth, N. J.  
Wason Mfg. Co., Springfield, Mass.
- Cars, Pay-As-You-Enter.**  
Pay-As-You-Enter Car Co., 26 Cortlandt St., New York.
- Cars, Rebuilt.**  
Detroit Carbuilding & Equipment Co., Detroit, Mich.
- Cars, Second-Hand.**  
Detroit Carbuilding & Equipment Co., Detroit, Mich.  
Marshall, R. W., & Co., 95 Liberty St., New York.  
Zeinicker, Walter A., Supply Co., St. Louis.
- Cars, Steel.**  
Pressed Steel Car Co., Pittsburg.  
St. Louis Car Co., St. Louis, Mo.  
Standard Motor Truck Co., Pittsburg.
- Castings, Brass.**  
Star Brass Works, Kalamazoo, Mich.
- Castings, Iron and Steel.**  
American Brake Shoe & Foundry Co., Mahwah, N. J.  
Green Engineering Co., Com'l Nat. Bk. Bldg., Chicago.  
Lorain Steel Co., Johnstown, Pa.  
National Brake & Electric Co., Milwaukee.
- Catchers—(See Trolley Retrievers and Catchers).**
- Cattle Guards.**  
Fairbanks, Morse & Co., Chgo.
- Cements, Cable and Transformer.**  
Massachusetts Chemical Co., Walpole, Mass.
- Circuit-Breakers.**  
Electric Service Supplies Co., 200 Plymouth Bldg., Chicago.  
General Electric Co., Schenectady, N. Y.  
Western Electric Co., Chicago.
- Coal Handling Machinery—(See Conveyors).**
- Coils—(See Armatures and Coils).**
- Commutators and Parts.**  
Cleveland Armature Works, Cleveland.  
Electric Service Supplies Co., 1020-24 Filbert St., Phila.  
General Electric Co., Schenectady, N. Y.  
Harrison Elec. & Mfg. Co., 169 South St., New York.  
Marshall, R. W., & Co., 95 Liberty St., New York.  
Ohio Brass Co., Mansfield, O.  
Stuart-Howland Co., Boston.
- Compressors, Air.**  
Fairbanks, Morse & Co., Chgo.  
General Electric Co., Schenectady, N. Y.  
National Brake & Electric Co., Milwaukee.  
Westhouse Traction Brake Co., Pittsburg.
- Concrete Mixers.**  
Contractors' Supply & Equip. Co., Chicago.
- Condensers.**  
Wheeler Con. & Eng. Co., New York.
- Conduits.**  
Electric Service Supplies Co., 200 Plymouth Bldg., Chicago.  
Western Electric Co., Chicago.
- Contractors.**  
Arnold Company, 181 La Salle St., Chicago.  
Bylesby H. M., Co., Am. Trust Bldg., Chicago.  
Columbia Construction Co., Milwaukee, Wis.  
Creaghead Engineering Co., Cincinnati, O.
- Contractors—Continued.**  
Green Engineering Co., Com'l Nat. Bk. Bldg., Chicago.  
Register, A. E. & Co., 112 N. Broad St., Philadelphia.  
McGure & Porter, 52 William St., New York.  
Sutton, E. A., Bladensburg R., Washington, D. C.  
Sheaf & Jaastad, 83 Broad St., Boston.  
Stone & Webster Engineering Corp., Boston.  
Wharton, Wm., Jr., & Co., Philadelphia.  
White, G. C., & Co., 49 Exchange Pl., New York.
- Controllers and Attachments.**  
Electric Service Supplies Co., 200 Plymouth Bldg., Chicago.  
General Electric Co., Schenectady, N. Y.  
Harrison Elec. & Mfg. Co., 169 South St., New York.  
Johns-Manville, H. W. Co., New York.  
Marshall, R. W., & Co., 95 Liberty St., New York.  
Western Electric Co., Chicago.  
Westinghouse Electric & Mfg. Co., Pittsburg.
- Conveyors and Coal Handling Machinery.**  
Green Engineering Co., Com'l Nat. Bk. Bldg., Chicago.  
Northern Engineering Works, Detroit, Mich.
- Cord, Bell and Trolley.**  
American Car Co., St. Louis, Brill, The J. G. Co., Philadelphia.  
Electric Service Supplies Co., 1020-24 Filbert St., Phila.  
Kuhlman, The G. C., Car Co., Cleveland.  
St. Louis Car Co., St. Louis, Mo.  
Stephenson, John, Co., Elizabeth, N. J.  
Stuart-Howland Co., Boston.  
Wason Mfg. Co., Springfield, Mass.
- Couplers, Car.**  
American Car Co., St. Louis, Brill, The J. G. Co., Philadelphia.  
Kuhlman, The G. C., Car Co., Cleveland.  
McGuire-Cummings Mfg. Co., Chicago.  
Ohio Brass Co., Mansfield, O.  
St. Louis Car Co., St. Louis, Mo.  
Stephenson, John, Co., Elizabeth, N. J.  
Van Dorn, W. T. Co., Paulina St., Chicago.  
Washburn, E. C., Minneapolis.  
Wason Mfg. Co., Springfield, Mass.
- Coverings, Pipe and Boiler.**  
Johns-Manville, H. W. Co., New York.
- Cranes, Hoists and Lifts.**  
American Car Co., St. Louis, Brill, The J. G. Co., Philadelphia.  
Brown Hoisting Machinery Co., Cleveland, O.  
Kuhlman, The G. C., Car Co., Cleveland.  
Northern Engineering Works, Detroit, Mich.  
Railway Specialty & Supply Co., Chicago.  
Stephenson, John, Co., Elizabeth, N. J.  
Van Dorn & Dutton Co., Cleveland, O.  
Wason Mfg. Co., Springfield, Mass.
- Cross Arms—(See Brackets and Cross Arms).**
- Crossing Gates—(See Gates and Guards).**
- Crossings, Track—(See Switches).**
- Curtains, Fixtures and Materials—Continued.**  
American Car Co., St. Louis, Brill, The J. G. Co., Philadelphia.  
Stephenson, John, Co., Elizabeth, N. J.  
Wason Mfg. Co., Springfield, Mass.
- Cylinder Oil.**  
Powell Specialty Co., 111 Broadway, N. Y.
- Derailing Devices.**  
American Frog & Switch Co., Hamilton, O.  
Cincinnati Frog & Switch Co., Cincinnati, O.  
Cleveland Frog & Crossing Co., Cleveland, O.
- Detective Agency.**  
Drummond Detective Agency, New York.
- Diaphragms.**  
Wood, G. S., Great Northern Bldg., Chicago.
- Doors and Fixtures.**  
American Car Co., St. Louis, Brill, The J. G. Co., Philadelphia.  
Kuhlman, The G. C., Car Co., Cleveland.  
St. Louis Car Co., St. Louis, Mo.  
Stephenson, John, Co., Elizabeth, N. J.  
Wason Mfg. Co., Springfield, Mass.
- Doors, Steel Rolling.**  
Kinnear Manufacturing Co., Columbus, O.  
Wilson, J. G., Mfg. Co., New York.
- Draft, Mechanical—(See Mechanical Draft).**
- Draft Rigging.**  
Van Dorn, W. T. Co., Chgo.
- Drills, Track.**  
Brown, H. P., 120 Liberty St., New York.  
Electric Service Supplies Co., 200 Plymouth Bldg., Chicago.  
Fairbanks, Morse & Co., Chgo.  
Kalamazoo Railway Supply Co., Kalamazoo, Mich.  
Marshall, R. W., & Co., 95 Liberty St., New York.  
Reed, Francis, Co., Worcester, Mass.  
Ridlon, Frank, Co., 200 Summer St., Boston.
- Drying Appliances.**  
Green Fuel Economizer Co., Matteawan, N. Y.
- Dynamos and Generators.**  
Cleveland Armature Works, Cleveland, O.  
Fairbanks, Morse & Co., Chgo.  
General Electric Co., Schenectady, N. Y.  
National Brake & Electric Co., Milwaukee, Wis.  
Rossiter, MacGovern & Co., 17 Battery Pl., New York.  
Westhouse Electric & Mfg. Co., Pittsburg, Pa.  
Westinghouse Electric & Mfg. Co., Pittsburg, Pa.
- Economizers, Fuel.**  
Green Fuel Economizer Co., Matteawan, N. Y.
- Electrical Instruments.**  
Electric Service Supplies Co., 200 Plymouth Bldg., Chicago.  
General Electric Co., Schenectady, N. Y.  
Johns-Manville, H. W. Co., New York.  
Queen & Co., Philadelphia.  
Western Electric Co., Chicago.  
Westinghouse Electric & Mfg. Co., Pittsburg, Pa.  
Wason Electrical Instrument Co., Newark, N. J.
- Electric Railway Supplies, General.**  
Cleveland Armature Works, Cleveland, O.  
Creaghead Engineering Co., Cincinnati, O.  
Electric Service Supplies Co., 200 Plymouth Bldg., Chicago.  
Fairbanks, Morse & Co., Chgo.  
General Electric Co., Schenectady, N. Y.  
Harrison Elec. & Mfg. Co., 169 South St., New York.  
Johns-Manville, H. W. Co., New York.  
Marshall, R. W., & Co., 95 Liberty St., New York.  
National Service Washer Co., Newark, N. J.  
Pantaote Co., 11 Broadway, New York.

# THE NEW CLIMAX HEADLIGHT

Motorman  
may change  
instantly  
from arc to  
incandescent

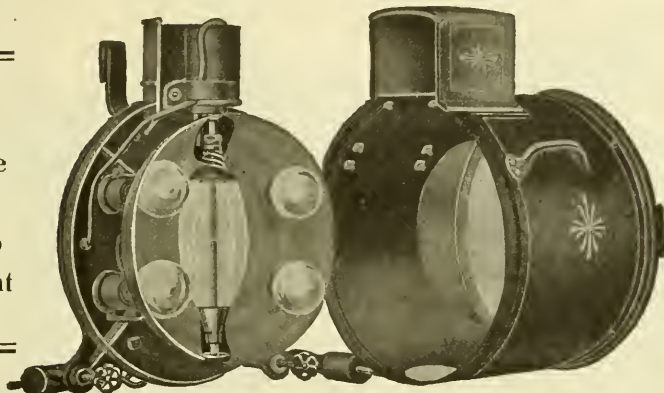

Throws  
a perfect  
light  
from 1,000  
to 1,500 feet

Write today for  
full information

**TROLLEY SUPPLY CO., Canton, Ohio**

## HOT WATER HEATERS for Cars

THE PETER SMITH HEATER CO., Detroit, Mich.

## MORDEN FROG AND CROSSING WORKS

MANUFACTURERS OF

618 The Rookery, Chicago

**Street Railway Special Track Work**

Works: SOUTH CHICAGO and CHICAGO HEIGHTS

"UNION" Track Jacks, Switches, Frogs, Crossings, Rail Braces, Etc.



CONTINUOUS JOINT

Over  
25,000  
miles  
in use



WEBER JOINT

Rolled  
from  
Best Quality  
Steel



WOLHAUPTER JOINT

Catalogs at Agencies  
Baltimore, Md. Portland, Ore.  
Boston, Mass. Seattle, Wash.  
Chicago, Ill. St. Paul, Minn.  
Denver, Colo. St. Louis, Mo.  
Pittsburg, Pa. Troy, N. Y.  
London, Eng. Montreal, Can.

HIGHEST AWARDS—Paris, 1900;  
Buffalo, 1901; St. Louis, 1904

Additional safety and economy in Track Maintenance has been proved by the use of Continuous, Weber and Wolhaupter base-supported rail joints—after ten (10) years' service, having a record of over 25,000 miles in use—the extent of which is evidence of their excellence.

**THE RAIL JOINT COMPANY**  
General Offices: 29 West 34th Street, New York City  
Makers of Rail Joints for Standard and Special Rail Sections, also Girders, Step or Compromise, and Insulating Rail Joints, protected by patents in United States and Foreign Countries.

## Hydraulic Motor Lifts

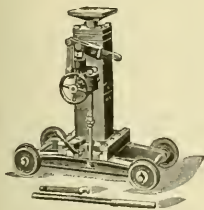

WE have different  
types of Hydraulic  
Motor Lifts for Street  
Railway use. Each one  
is thoroughly guaranteed.

SEND FOR SPECIAL RAILROAD CATALOGUE

**The Watson-Stillman Co.**

26 Cortlandt St.  
NEW YORK CITY

Branch } 453 The Rookery  
Office } CHICAGO, ILL.



Factory of The Milloy Electric Company  
Bucyrus, Ohio

## The Milloy Trolley Base

built in our new and specially equipped  
factory, insures a quality which will give ex-  
cellent service under ordinary and extraor-  
dinary conditions.  
The Milloy Base is unusually low, has even  
tension on high or low wire. Has no ful-  
crum, no friction, no oil, no center post.  
Always efficient. Particulars on request.

**THE MILLOY ELECTRIC COMPANY**  
Bucyrus, Ohio

## CLASSIFIED LIST OF ADVERTISERS Continued.

- Enamels.**  
Acme White Lead & Color Works, Detroit, Mich.  
St. Louis Surfer & Paint Co., St. Louis, Mo.
- Engine Apparatus.**  
Green Fuel Economizer Co., Matteawan, N. Y.
- Engineers and Contractors.**  
Arnold Company, Chicago.  
Byllesby, H. M., & Co., Chgo.  
Columbia Construction Co., Milwaukee, Wis.  
Ford, Bacon & Davis, New York.  
Register, A. L., & Co., Philadelphia.  
Roberts & Abbott Co., Cleveland, O.  
Sanderson & Porter, New York.  
Saxton, E., Washington, D. C.  
Sheaff & Jastad, Boston.  
Stone & Webster Eng. Corporation, Boston.  
White, J. G., & Co., New York.
- Engines, Gas and Oil.**  
Buckeye Engine Co., Salem, O.  
Fairbanks, Morse & Co., Chgo.  
Westinghouse Machine Co., Pittsburg.
- Engines, Hoisting.**  
Fairbanks, Morse & Co., Chgo.
- Engines, Steam.**  
Buckeye Engine Co., Salem, O.  
Rosalter, MacGovern & Co., 17 Battery Pl., New York.  
Westinghouse Machine Co., Pittsburg.
- Fans, Exhaust and Ventilating.**  
General Electric Co., Schenectady, N. Y.  
Green Fuel Economizer Co., Matteawan, N. Y.  
Western Electric Co., Chicago.  
Westinghouse Elec. & Mfg. Co., Pittsburg.
- Fare Boxes—(See Electric Railway Supplies).**
- Fare Registers and Register Fittings.**  
Electric Service Supplies Co., 200 Plymouth Bldg., Chicago.  
Recording Fare Register Co., New Haven, Conn.  
Rooke Automatic Register Co., Providence, R. I.
- Feedwater Apparatus.**  
Green Fuel Economizer Co., Matteawan, N. Y.  
Wheeler Condenser & Eng'g Co., New York.
- Feed Wire—(See Wire and Cables).**
- Fenders and Guards.**  
Consolidated Car Fender Co., Providence, R. I.  
Eclipse Railway Supply Co., Cleveland, O.  
Electric Service Supplies Co., 1020-24 Filbert St., Phila., Chgo.  
McGuire-Cummings Mfg. Co., Chicago.  
Marshall, R. W., & Co., 95 Liberty St., New York.
- Flangers, Snow.**  
McGuire-Cummings Mfg. Co., Chicago.  
Ohio Brass Co., Mansfield, O.  
Kalamazoo Railway Supply Co., Kalamazoo, Mich.  
Van Dorn & Dutton Co., Cleveland, O.
- Frogs—(See Switches, Frogs and Crossings).**
- Fuel Economizers—(See Economizers, Fuel).**
- Fuses and Fuse Devices.**  
Chase-Shawmutt Co., Newburyport, Mass.  
Electric Service Supplies Co., 200 Plymouth Bldg., Chicago.  
General Electric Co., Schenectady, N. Y.  
Johns-Manville, H. W., Co., New York.  
Western Electric Co., Chicago.  
Westinghouse Elec. & Manufacturing Co., Pittsburg.
- Gaskets, Bronze.**  
Power Specialty Co., 111 Broadway, New York.
- Gates and Guards.**  
Bliss, R., Mfg. Co., Pawtucket, R. I.  
Kalamazoo Railway Supply Co., Kalamazoo, Mich.
- Gear Cases.**  
Electric Service Supplies Co., 200 Plymouth Bldg., Chicago.  
General Electric Co., Schenectady, N. Y.  
Marshall, R. W., & Co., 95 Liberty St., New York.
- Gears and Pinions.**  
Electric Service Supplies Co., 200 Plymouth Bldg., Chicago.  
General Electric Co., Schenectady, N. Y.  
Marshall, R. W., & Co., 95 Liberty St., New York.  
Nuttall, R. D., Co., Pittsburg.  
Van Dorn & Dutton Co., Cleveland, O.
- Generators—(See Dynamos).**
- Gongs—(See Bells and Gongs).**
- Graphite.**  
Detroit Graphite Co., Detroit, Mich.  
U. S. Graphite Co., Saginaw, Mich.
- Graphite Paint—(See Paint).**
- Grates, Chain.**  
Green Engineering Co., Com'l Nat. Bk. Bldg., Chicago.
- Grease—(See Lubricants).**
- Grinders.**  
Brown, Harold P., 120 Liberty St., New York.
- Ground Connection Clamps.**  
Chase-Shawmutt Co., Newburyport, Mass.
- Guy Anchors—(See Anchors).**
- Harps, Trolley—(See Trolley Poles and Fittings).**
- Headlights.**  
Electric Service Supplies Co., 200 Plymouth Bldg., Chicago.  
Fairbanks, Morse & Co., Chgo.  
General Electric Co., Schenectady, N. Y.  
Ridlon, Frank Co., 200 Summer St., Boston.  
St. Louis Car Co., St. Louis, Mo.  
Stuart-Howland Co., Boston.  
Trolley Supply Co., Canton, O.
- Headlinings, Passenger Car.**  
Indestructible Fibre Car, 45 Broadway, New York.
- Heaters, Car, Electric.**  
Consolidated Car-Heating Co., Albany, N. Y.  
Johns-Manville, H. W., Co., New York.
- Heaters, Car, Hot Water, and Stoves.**  
Baker, The Wm. C., Heating & Sup. Co., New York.  
Cooper Heater Co., The Dayton, O.  
Electric Service Supplies Co., 1020-24 Filbert St., Phila.  
McGuire-Cummings Mfg. Co., Chicago.  
Smith, Peter, Heater Co., Detroit, Mich.
- Heating and Ventilating Apparatus—(See Mech. Draft).**
- Hoists—(See Cranes, Hoists and Lifts).**
- Hose Bridges.**  
Ohio Brass Co., Mansfield, O.
- Hydraulic Machinery.**  
Watson-Stillman Co., 26 Cortlandt St., New York.
- Inspection.**  
Central Inspection Bureau.
- Inspection Cars, Gasoline.**  
Stover Motor Car Co., Freeport, Ill.
- Instruments, Measuring and Testing—(See Electrical Instruments).**
- Insulating Tapes.**  
General Electric Co., Schenectady, N. Y.  
Harrison Elec. & Mfg. Co., 169 South St., New York.  
Johns-Manville, H. W., Co., New York, N. Y.  
Massachusetts Chemical Co., Walpole, Mass.  
Okonite Co., Ltd., 253 Broadway, New York.  
Western Electric Co., Chicago.
- Insulations and Insulating Material.**  
Anderson, A. & J. M., Mfg. Co., Boston.  
Creaghead Engineering Co., Cincinnati, O.
- Insulations and Insulating Materials—Continued.**  
Railway Equipment Co., Cincinnati, O.  
Electric Service Supplies Co., 200 Plymouth Bldg., Chicago.  
General Electric Co., Schenectady, N. Y.  
Johns-Manville, H. W., Co., New York.  
Macallen, The Co., Boston.  
Massachusetts Chemical Co., Walpole, Mass.  
Ohio Brass Co., Mansfield, O.  
Okonite Co., Ltd., 253 Broadway, New York.  
Ridlon, Frank Co., 200 Summer St., Boston.  
Standard Paint Co., 100 William St., New York.  
Standard Varnish Works, New York.  
Stuart-Howland Co., Boston.  
Western Electric Co., Chicago.
- Jacks.**  
American Car Co., St. Louis.  
Brill, The J. G., Co., Philadelphia.  
Electric Service Supplies Co., 200 Plymouth Bldg., Chicago.  
Fairbanks, Morse & Co., Chgo.  
Kalamazoo Railway Supply Co., Kalamazoo, Mich.  
Kuhlman, The G. C., Car Co., Cleveland.  
Marshall, R. W., & Co., 95 Liberty St., New York.  
Morden Frog & Crossing Co., Chicago.  
Stephenson, John, Co., Elizabeth, N. J.  
Wason Mfg. Co., Springfield, Mass.  
Watson-Stillman Co., 26 Cortlandt St., New York.
- Joints, Expansion—(See Steam Fittings).**
- Joints, Rail.**  
Goldschmidt Thermit Co., 43 Exchange Pl., New York.  
Rail Joint Co., 29 W. 34th St., New York.
- Joints, Welded—(See Rail Joints, Welded).**
- Journal Boxes.**  
American Car Co., St. Louis.  
Brill, The J. G., Co., Philadelphia.  
Kuhlman, The G. C., Car Co., Cleveland.  
McGuire-Cummings Mfg. Co., Chicago.  
St. Louis Car Co., St. Louis, Mo.  
Stephenson, John, Co., Elizabeth, N. J.  
Synges, T. H., Co., Baltimore, Md.  
Wason Mfg. Co., Springfield, Mass.
- Journal Lubricators—(See Lubricants).**
- Journal Packing, Steel Wool.**  
Robertson, Wm., & Co., Fifth Floor, Great Northern Bldg., Chicago.
- Lamps, Arc and Incandescent.**  
Anderson, A. & J. M., Mfg. Co., Boston.  
Electric Service Supplies Co., 200 Plymouth Bldg., Chicago.  
General Electric Co., Schenectady, N. Y.  
Ridlon, Frank Co., 200 Summer St., Boston.  
Stuart-Howland Co., Boston.  
Western Electric Co., Chicago.  
Westinghouse Electric & Mfg. Co., Pittsburg, Pa.
- Lamp Sockets.**  
Electric Service Supplies Co., 200 Plymouth Bldg., Chicago.  
General Electric Co., Schenectady, N. Y.  
Johns-Manville, H. W., Co., New York, N. Y.
- Lantern Globes.**  
Railway Specialty & Supply Co., Chicago.
- Lifting Magnets.**  
Porter Mfg. Co., 29 Griswold St., Detroit, Mich.
- Lifts—(See Cranes, Hoist and Lift).**
- Lightning Arresters.**  
Electric Service Supplies Co., 200 Plymouth Bldg., Chicago.  
General Electric Co., Schenectady, N. Y.  
Stuart-Howland Co., Boston.  
Western Electric Co., Chicago.  
Westinghouse Elec. & Manufacturing Co., Pittsburg.
- Line Material.**  
Anderson, A. & J. M., Mfg. Co., Boston.  
Creaghead Engineering Co., Cincinnati, O.  
Johns-Manville, H. W., Co., New York.  
Electric Ry. Equipment Co., Cincinnati, O.  
Electric Service Supplies Co., 200 Plymouth Bldg., Chicago.  
General Electric Co., Schenectady, N. Y.  
Macallen, The Co., Boston.  
Marshall, R. W., & Co., 95 Liberty St., New York.  
Recording Fare Register Co., New Haven, Conn.  
Stuart-Howland Co., Boston.  
Western Electric Co., Chicago.
- Lock and Nut Washers.**  
Grip Nut Co., 152 Lake St., Chicago.  
National Lock Washer Co., Newark, N. J.
- Lockers, Metal.**  
Electric Service Supplies Co., 200 Plymouth Bldg., Chicago.
- Locomotives.**  
Baldwin Locomotive Works, Philadelphia.  
Johann, F. A., 1624 Pierce Bldg., St. Louis.
- Locomotives, Electric.**  
American Car Co., St. Louis.  
Baldwin Locomotive Works, Philadelphia.  
Brill, The J. G., Co., Philadelphia.  
General Electric Co., Schenectady, N. Y.  
Kuhlman, The G. C., Car Co., Cleveland.  
McGuire-Cummings Mfg. Co., Chicago.  
Stephenson, John, Co., Elizabeth, N. J.  
Wason Mfg. Co., Springfield, Mass.  
Westinghouse Elec. & Manufacturing Co., Pittsburg.
- Locomotives, Gasoline.**  
Fairbanks, Morse & Co., Chgo.  
Stover Motor Car Co., Freeport, Ill.
- Lubricants.**  
Dearborn Drug & Chemical Works, Chicago.  
Detroit Graphite Co., Detroit, Mich.  
Galena-Signal Oil Co., Franklin, Pa.  
U. S. Graphite Co., Saginaw, Mich.  
Whitmore Mfg. Co., Cleveland, O.
- Lumber.**  
Barnes, G. H., Hardwood Lumber Co., St. Louis, Mo.  
Beldier, Francis, & Co., Chgo.  
Berthold & Jennings, St. Louis.  
Lindsay Bros. Co., Spokane, Wash.  
S-E, Missouri Cypress Co., Campbell, Mo.
- Magnets and Solenoids.**  
Porter Mfg. Co., 29 Griswold St., Detroit, Mich.
- Malleable Iron.**  
St. Louis Car Co., St. Louis, Mo.
- Measuring Tapes.**  
Lufkin Rule Co., Saginaw, Mich.
- Mechanical Draft.**  
Green Fuel Economizer Co., Matteawan, N. Y.
- Meters.**  
Johns-Manville, H. W., Co., New York, Mass.  
Queen & Co., Philadelphia.  
Weston Electrical Instrument Co., Newark, N. J.
- Molded Goods.**  
Massachusetts Chemical Co., Walpole, Mass.  
Wood, G. S., Great Northern Bldg., Chicago.
- Motor Cars, Gasoline.**  
Stover Motor Car Co., Freeport, Ill.
- Motors, Electric.**  
Cleveland Armature Works, Cleveland, O.  
Fairbanks, Morse & Co., Chgo.  
General Electric Co., Schenectady, N. Y.  
National Brake & Electric Co., Milwaukee.





***The Conductor is always on the rear platform of the Pay-As-You-Enter Car***

It is the business office of the company, where fares are paid before passengers enter and immediately receipted for by fare register. ¶ The conductor's constant presence on the platform totally eliminates that large and constantly increasing class of accidents arising from the starting of cars while passengers are in the act of boarding.

¶ Thus, you see, the Pay-As-You-Enter Car works two ways

- it insures the collection of all the revenue to which the company is entitled
- it conserves this revenue by eliminating a prolific source of damage claims

We license manufacturers and railways to build and use the Pay-As-You-Enter Car, the patents on which are owned by

**The Pay-As-You-Enter Car Company**

DUNCAN McDONALD  
President 26 Cortlandt Street, New York

THOS. W. CASEY  
Manager

## CLASSIFIED LIST OF ADVERTISERS—Continued.

- Motors, Electric—Continued.**  
 Rossiter, McGovern & Co., 17 Battery Pl., New York.  
 Western Electric Co., Chicago.  
 Westinghouse Elec. & Manufacturing Co., Pittsburgh.
- Nut Locks.**  
 Chase-Shawmut Co., Newburyport, Mass.  
 Grip Nut Co., 152 Lake St., Chicago.  
 National Lock Washer Co., Newark, N. J.  
 Railway Specialty & Supply Co., Chicago.  
 St. Louis Car Co., St. Louis, Mo.  
 U. S. Metal & Mfg. Co., 25 Broad St., New York.
- Nuts and Bolts.**  
 Grip Nut Co., 152 Lake St., Chicago.  
 Lorain Steel Co., Philadelphia  
 National Lock Washer Co., Newark, N. J.  
 Railway Specialty & Supply Co., Chicago.
- Oilers.**  
 Armstrong Oiler Co., 31st and Chestnut St., Philadelphia.
- Oils—(See Lubricants).**
- Overhead Equipment—(See Electric Railway Supplies).**
- Packings.**  
 Electric Service Supplies Co., 200 Plymouth Bldg., Chicago.  
 Johns-Manville, H. W., Co., New York.  
 Power Specialty Co., 111 Broadway, New York.
- Packing, Steel Wool Journal.**  
 Robertson, Wm., & Co., Fifth Floor Great Northern Bldg., Chicago.
- Paints.**  
 Detroit Graphite Co., Detroit.  
 Massachusetts Chemical Co., Walpole, Mass.  
 Standard Paint Co., 100 William St., New York.  
 St. Louis Surfacor & Paint Co., St. Louis, Mo.  
 U. S. Graphite Co., Saginaw, Mich.
- Pay-As-You-Enter Cars.**  
 Pay-As-You-Enter Car Co., 26 Cortland St., New York.
- Pipe Bends and Fittings—(See Steam Fittings).**
- Plumbago.**  
 Detroit Graphite Co., Detroit, Mich.  
 U. S. Graphite Co., Saginaw, Mich.
- Poles, Metal.**  
 Creaghead Engineering Co., Cincinnati, O.  
 Electric Railway Equipment Co., Cincinnati, O.  
 Electric Service Supplies Co., 200 Plymouth Bldg., Chicago.
- Poles and Ties, Wood.**  
 Advance Lumber Co., Cleveland, O.  
 Barnes, G. H., Hardwood Lumber Co., St. Louis, Mo.  
 Beldier, Francis, & Co., Chgo.  
 Berthold & Jennings, St. Louis.  
 Churchill Cedar Co., Spokane, Wash.  
 Humbird Lumber Co., Sand Point, Idaho.  
 Linsley Bros. Co., Spokane, Wash.  
 National Pole Co., Escanaba, Mich.  
 Naugle Pole & Tie Co., 226 La Salle St., Chicago.  
 Pacific Coast Pole Co., Spokane, Wash.  
 S-E. Missouri Cypress Co., Campbell, Mo.  
 Worcester, C. H., Co., Tribune Bldg., Chicago.
- Promoters of Railway Projects.**  
 Shimer & Chase Co., Omaha, Neb.
- Punches—(See Ticket Punches).**
- Rail Benders.**  
 Electric Service Supplies Co., 200 Plymouth Bldg., Chicago.  
 Fairbanks, Morse & Co., Chgo.
- Rail Bonds—(See Bonds, Rail).**
- Rail Bonds, Flexible.**  
 Chase-Shawmut Co., Newburyport, Mass.
- Rail Drills—(See Drills, Track).**
- Rail Feed Wire—(See Wire and Cables).**
- Rail Joints and Chairs—(See Joints, Rail).**
- Rail Joints, Welded.**  
 Goldschmidt Thermit Co., 43 Exchange Pl., New York.  
 Lorain Steel Co., Philadelphia.
- Rails, New.**  
 Lorain Steel Co., Philadelphia.  
 New York Switch & Crossing Co., Hoboken, N. J.  
 Wharton, Wm., Jr., & Co., Philadelphia.
- Rails, Relaying.**  
 Zelnicker, Walter A., Supply Co., St. Louis.
- Railway Equipment.**  
 Johann, F. A., 1624 Pierce Bldg., St. Louis.
- Railway Volocepedes.**  
 Fairbanks Morse & Co., Chgo.  
 Kalamazoo Railway Supply Co., Kalamazoo, Mich.
- Registers and Fittings—(See Fare Registers).**
- Relays.**  
 Weston Electrical Instrument Co., Newark, N. J.
- Roofing.**  
 Johns-Manville, H. W., Co., New York.
- Rubber Goods, Mechanical.**  
 Wood, G. S., Great Northern Bldg., Chicago.
- Rubber Preservative.**  
 Wood, G. S., Great Northern Bldg., Chicago.
- Sand Apparatus.**  
 American Car Co., St. Louis.  
 Brill, The J. G., Co., Philadelphia.  
 Electric Service Supplies Co., 200 Plymouth Bldg., Chicago.  
 Kuhlman, The G. C., Car Co., Cleveland.  
 Marshall, R. W., & Co., 95 Liberty St., New York.  
 Ohio Brass Co., Mansfield, O.  
 Ridion, Frank, Co., 200 Summer St., Boston.  
 St. Louis Car Co., St. Louis, Mo.  
 Stephenson, John, Co., Elizabeth, N. J.  
 Wason Mfg. Co., Springfield, Mass.
- Sash Balances and Fixtures.**  
 National Lock Washer Co., Newark, N. J.
- Sash Operating Devices.**  
 Drouve, The G., Co., Bridgeport, Conn.  
 Lord & Burnham, Irvington-on-Hudson, New York.
- Seats, Car—(See Car Seats).**
- Shade Rollers—(See Curtains, Fixtures and Materials).**
- Shutters, Steel Rolling.**  
 Kinnear Manufacturing Co., Columbus, O.
- Signals.**  
 Blake Signal & Manufacturing Co., Boston.  
 Telegraph Signal Co., Rochester, N. Y.
- Signal Supplies.**  
 Railway Specialty & Supply Co., Chicago.
- Skylights.**  
 Drouve, The G., Co., Bridgeport, Conn.  
 Lord & Burnham, Irvington-on-Hudson, New York.
- Snow Plows, Sweepers and Scrapers.**  
 American Car Co., St. Louis.  
 Brill, The J. G., Co., Philadelphia.  
 Kalamazoo Railway Supply Co., Kalamazoo, Mich.  
 Kuhlman, The G. C., Car Co., Cleveland.  
 McGuire-Cummings Mfg. Co., Chicago.  
 Russell Car & Snow-Plow Co., Ridgway, Pa.  
 Stephenson, John, Co., Elizabeth, N. J.  
 Wason Mfg. Co., Springfield, Mass.
- Sockets, Waterproof.**  
 Johns-Manville, H. W., Co., New York.
- Solder Paste.**  
 Chase-Shawmut Co., Newburyport, Mass.
- Splicing Compounds and Materials.**  
 Massachusetts Chemical Co., Walpole, Mass.
- Springs.**  
 American Car Co., St. Louis.  
 Brill, The J. G., Co., Philadelphia.  
 Kuhlman, The G. C., Car Co., Cleveland.  
 McGuire-Cummings Mfg. Co., Chicago.  
 Marshall, R. W., & Co., 95 Liberty St., New York.  
 Railway Steel Spring Co., 71 Broadway, New York.  
 St. Louis Car Co., St. Louis, Mo.  
 Stephenson, John, Co., Elizabeth, N. J.  
 Wason Mfg. Co., Springfield, Mass.
- Sprinkling Cars.**  
 American Car Co., St. Louis.  
 Brill, The J. G., Co., Philadelphia.  
 Kuhlman, The G. C., Car Co., Cleveland.  
 McGuire-Cummings Mfg. Co., Chicago.  
 Stephenson, John, Co., Elizabeth, N. J.  
 Wason Mfg. Co., Springfield, Mass.
- Stage Pockets and Plugs.**  
 Chase-Shawmut Co., Newburyport, Mass.
- Steam Apparatus.**  
 Green Fuel Economizer Co., Matteawan, N. Y.
- Steam Fittings, Etc.**  
 Crane Co., Chicago.  
 Davis, The John, Co., Chgo.  
 Simmons, John, Co., 110 Centre St., New York.  
 Power Specialty Co., 111 Broadway, New York.
- Steel Cars.**  
 American Car Co., St. Louis.  
 Brill, The J. G., Co., Philadelphia.  
 Kuhlman, The G. C., Car Co., Cleveland.  
 St. Louis Car Co., St. Louis, Mo.  
 Stephenson, John, Co., Elizabeth, N. J.  
 Wason Mfg. Co., Springfield, Mass.
- Steel Tapes.**  
 Luffkin Rule Co., Saginaw, Mich.
- Stokers.**  
 Babcock & Wilcox Co., 85 Liberty St., New York.  
 Green Engineering Co., Com'l Nat. Bk. Bldg., Chicago.  
 Model Stoker Co., Dayton, O.  
 Under-Feed Stoker Co. of Am., Chicago.  
 Westinghouse Machine Co., Pittsburgh.
- Storage Batteries—(See Batteries).**
- "Strike-Breakers."**  
 Drummond Detective Agency, 3 Ann St., New York.
- Superheaters.**  
 Power Specialty Co., 111 Broadway, New York.
- Switches, Frogs and Crossings.**  
 American Frog & Switch Co., Hamilton, O.  
 Barbour-Stockwell Co., Cambridgeport, Mass.  
 Cincinnati Frog & Switch Co., Cincinnati, O.  
 Cleveland Frog & Crossing Co., Cleveland, O.  
 Fairbanks, Morse & Co., Chgo.  
 Lorain Steel Co., Philadelphia.  
 Morden Frog & Crossing Co., Rookery, Chicago.  
 New York Switch & Crossing Co., Hoboken, N. J.  
 Railway Specialty & Supply Co., Chicago.  
 Wharton, Wm., Jr., & Co., Philadelphia.
- Switchboards and Switchboard Instruments.**  
 Anderson, A. & J. M., Mfg. Co., Boston.  
 Chase-Shawmut Co., Newburyport, Mass.  
 General Electric Co., Schenectady, N. Y.  
 Western Electric Co., Chicago.  
 Westinghouse Electric & Mfg. Co., Pittsburgh.  
 Weston Electrical Instrument Co., Newark, N. J.
- Tapes and Webbing.**  
 Hope Webbing Co., Providence, R. I.  
 Johns-Manville, H. W., Co., New York.  
 Massachusetts Chemical Co., Walpole, Mass.  
 Okonite Co., Ltd., 253 Broadway, New York.
- Testing Instruments.**  
 Queen & Co., Philadelphia.  
 Weston Electrical Instrument Co., Newark, N. J.
- Test Lamps, Pocket.**  
 Chase-Shawmut Co., Newburyport, Mass.
- Ticket Choppers and Destroyers.**  
 Patten, Paul B., Salem, Mass.
- Ticket Punches.**  
 Meyers, Fred J., Mfg. Co., Hamilton, O.  
 Woodman Mfg. & Sup. Co., Boston.
- Ties and Poles, Wood—(See Poles and Ties).**
- Timber.**  
 Beldier, Francis, & Co., Chgo.  
 Linsley Bros. Co., Spokane, Wash.  
 S-E. Missouri Cypress Co., Campbell, Mo.
- Tools, Pneumatic—(See Pneumatic Tools).**
- Track Cleaners and Scrapers.**  
 American Car Co., St. Louis.  
 Brill, The J. G., Co., Philadelphia.  
 Kalamazoo Railway Supply Co., Kalamazoo, Mich.  
 Kuhlman, The G. C., Car Co., Cleveland.  
 McGuire-Cummings Mfg. Co., Chicago.  
 Marshall, R. W., & Co., 95 Liberty St., New York.  
 Ohio Brass Co., Mansfield, O.  
 Stephenson, John, Co., Elizabeth, N. J.  
 Van Dorn & Dutton Co., Cleveland, O.  
 Wason Mfg. Co., Springfield, Mass.
- Track Drills—(See Drills, Track).**
- Tracklaying Machinery.**  
 Holman, D. F., Ry. Tracklayer Co., 1102 Ellsworth Bldg., Chicago.
- Track Tools.**  
 Electric Service Supplies Co., 200 Plymouth Bldg., Chicago.  
 Kalamazoo Railway Supply Co., Kalamazoo, Mich.
- Trimblings, Car.**  
 American Car Co., St. Louis.  
 Brill, The J. G., Co., Philadelphia.  
 Curtain Supply Co., Park Row Bldg., New York.  
 Kuhlman, The G. C., Car Co., Cleveland.  
 National Lock Washer Co., Newark, N. J.  
 St. Louis Car Co., St. Louis, Mo.  
 Stephenson, John, Co., Elizabeth, N. J.  
 Wason Mfg. Co., Springfield, Mass.  
 Wood, G. S., Great Northern Bldg., Chicago.
- Trolley Guards.**  
 Automatic Trolley Guard Co., 291 Elliott Sq., Buffalo, N. Y.  
 Electric Service Supplies Co., 200 Plymouth Bldg., Chicago.
- Trolley Poles and Fittings.**  
 General Electric Co., Schenectady, N. Y.  
 Johns-Manville, H. W., Co., New York.  
 Marshall, R. W., & Co., 95 Liberty St., New York.  
 Star Brass Works, Kalamazoo, Mich.

# New Type "O B" Governor

This governor is of the pneumatic type, light, compact, substantial and positive in its action. It can be placed in any position either inside or under the car, and it will operate equally well on either alternating or direct current. A few of its advantages are:

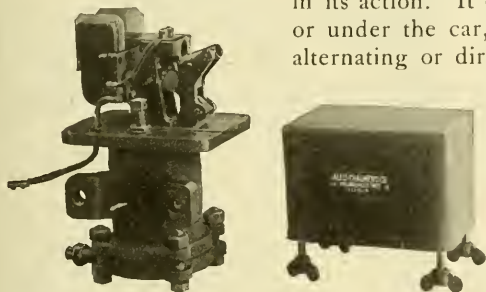

- There are fewer parts than in any other pneumatic or oil pneumatic governor made.
- Range can be changed without disconnecting the governor or any part thereof, excepting removing cover.
- There are no small ports, slides, delicate check or pin valves.
- No oil to carbonize or leak out over car floor.
- No piston packing rings to wear out and leak.
- No delicate springs to require frequent adjustment. In fact, the governor can be installed, taken apart and reassembled by any ordinary car barn repairman or helper.

To all users of Christensen Air Brakes, as well as brake equipments of other types, we are prepared to offer our "O B" governor on sixty days' trial. The price is reasonable, and an allowance will be made when governors of older types are to be replaced.

*Let us ship you one on trial*

**ALLIS-CHALMERS CO., Milwaukee, Wis.**

## Galena-Signal Oil Company

FRANKLIN, PA.

THEIR SPECIALTIES

**STREET RAILWAY LUBRICATION** including both rolling stock and power house equipment.

Same skillful expert supervision given in this service as in steam railway service has produced very satisfactory results. The business of our Street Railway Department has increased beyond every expectation. In 1906 this department sold ten times the number of barrels of oil sold by the same department in 1903.

We are under contract with many of the largest street and interurban railways of the country.

We guarantee cost per thousand miles in street railway service when conditions warrant it.

Write to Franklin, Pennsylvania, for further particulars.

**STEAM RAILWAY LUBRICATION** Sole manufacturers of the celebrated Galena Coach, Engine and Car Oils for steam railway lubrication. Sibben's Perfection Valve Oil for cylinder lubrication, and Perfection Signal Oil for use in railway signal lanterns.

**GALENA RAILWAY SAFETY OIL** Made especially for use in headlights, cab, classification and tail lights, and for switch and semaphore lamps. Burns equally well with the long time as with the one-day burner; with or without chimney as the burner requires. Is pure water white in color; high fire test, low cold test, and splendid gravity.

CHAS. MILLER, President

## Shawmut Soldered Bond Cap

to make over your  
PLUG BONDS

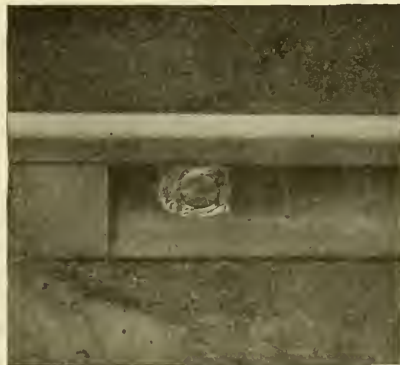

Why not look this up

**CHASE-SHAWMUT CO.**

Newburyport, Mass.

## CLASSIFIED LIST OF ADVERTISERS—Continued.

- Trolley Retrievers and Catchers.  
Electric Service Supplies Co.,  
1020-24 Filbert St., Phila.  
Milroy Electric Co., Bucyrus, O.  
Ridlon, Frank, Co., 200 Sum-  
mer St., Boston.  
Trolley Supply Co., Canton, O.
- Trolley Wagons.  
Kalamazoo Railway Supply  
Co., Kalamazoo, Mich.
- Trolley Wheels—(See Trolley  
Poles and Fittings).
- Trolley Wire—(See Wire and  
Cables).
- Trolleys, Track.  
Cleveland Armature Works,  
Cleveland, O.
- Trucks, Car.  
American Car Co., St. Louis.  
Baldwin Locomotive Works,  
Philadelphia.  
Brill, The J. G., Co., Phila-  
delphia.  
Kuhlman, The G. C., Car Co.,  
Cleveland.  
McGuire-Cummings Mfg. Co.,  
Chicago.  
St. Louis Car Co., St. Louis,  
Mo.  
Standard Motor Truck Co.,  
Pittsburg, Pa.  
Standard Varnish Works, New  
York City.  
Stephenson, John, Co., Eliza-  
beth, N. J.
- Trucks, Car—Continued.  
Van Dorn & Dutton Co.,  
Cleveland, O.  
Wason Mfg. Co., Springfield,  
Mass.
- Turbines.  
General Electric Co., Schene-  
cady, N. Y.  
Westinghouse Machine Co.,  
Pittsburg, Pa.
- Valves—(See Steam Fittings).
- Varnish.  
Electric Service Supplies Co.,  
200 Plymouth Bldg., Chicago.  
Harrison Elec. & Mfg. Co., 163  
South St., New York.  
Marshall, R. W., & Co., 95  
Liberty St., New York.  
Massachusetts Chemical Co.,  
Walpole, Mass.  
Milroy Electric Co., Bucyrus, O.  
Nuttall, R. D., Co., Pittsburg.  
Ridlon, Frank, Co., 200 Sum-  
mer St., Boston.  
Standard Paint Co., 100 Will-  
iam St., New York.  
Star Brass Works, Kalamaza-  
oo, Mich.  
Trolley Supply Co., Canton, O.  
Wallace Supply Co., Chicago.  
Westinghouse Electric & Mfg.  
Co., Pittsburg, Pa.
- Ventilators.  
Drouvé, The G., Co., Bridge-  
port, Conn.  
Lord & Burnham, Irvington-  
on-Hudson, New York.
- Vestiettes.  
Bellamy Vestiette Mfg. Co.,  
Cleveland, O.
- Waste, Cotton and Wool.  
Hagy, J. Milton, Waste Wks.,  
Philadelphia, Pa.  
Railway Specialty & Supply  
Co., Chicago.
- Water Softening Apparatus.  
Dearbourn Drug & Chemical  
Works, Chicago.
- Wheels and Axles.  
American Car Co., St. Louis.  
Brill, The J. G., Co., Phila-  
delphia.  
Griffin Wheel Co., Chicago.  
Kuhlman, The G. C., Car Co.,  
Cleveland.  
Lorain Steel Co., Philadelphia.  
McGuire-Cummings Mfg. Co.,  
Chicago.  
Marshall, R. W., & Co., 95  
Liberty St., New York.  
Railway Steel-Spring Co.,  
New York.  
St. Louis Car Co., St. Louis,  
Mo.  
St. Louis Car Wheel Co., St.  
Louis.  
Standard Steel Works, Phila-  
delphia.  
Stephenson, John, Co., Eliza-  
beth, N. J.  
Wason Mfg. Co., Springfield,  
Mass.
- Wheel Grinders.  
Wheel Truing Brake Shoe Co.,  
Detroit, Mich.
- Window Fixtures.  
Drouvé, The G., Co., Bridge-  
port, Conn.
- Wiping Rags.  
Hagy, J. Milton, Waste Wks.,  
Philadelphia, Pa.
- Wire, Aluminum.  
Aluminum Co. of America,  
Pittsburg, Pa.
- Wire, Insulated.  
Aluminum Co. of America,  
Pittsburg, Pa.  
American Electrical Works,  
Providence, R. I.  
General Electric Co., Schene-  
cady, N. Y.  
Okonite Co., Ltd., 253 Broad-  
way, New York.  
Standard Underground Cable  
Co., Pittsburg, Pa.  
Stuart-Howland Co., Boston.
- Wire and Cables.  
Aluminum Co. of America,  
Pittsburg, Pa.  
American Electrical Works,  
Providence, R. I.  
Bridgeport Brass Co., Bridge-  
port, Conn.  
General Electric Co., Schene-  
cady, N. Y.  
Okonite Co., Ltd., 253 Broad-  
way, New York.  
Standard Underground Cable  
Co., Pittsburg, Pa.



## TROLLEY WIRE, BARE COPPER CABLES WEATHERPROOF WIRE AND CABLES

RUBBER COVERED CABLES AND LEAD COVERED UNDERGROUND CABLES  
FOR ANY SERVICE. WRITE US FOR SPECIAL PRICES AT THIS TIME  
STANDARD UNDERGROUND CABLE CO.

Pittsburg New York Boston St. Louis San Francisco Chicago  
Philadelphia Los Angeles Atlanta

## RUBBER and COCOA MATTING

GUILFORD S. WOOD

ELECTRIC RAILWAY  
NECESSITIES

Great Northern Bldg., Chicago

## Your Wife Will Laugh

if you tell her that you purchase electric  
tape by the pound. When *she* goes shop-  
ping, yardage and quality direct her. Our

No. 264 ELECTRIC TAPE

is the *highest quality obtainable* and the  
greatest yardage per pound. *But don't*  
*lose sight of the yardage.*

Your jobber will supply you if you insist.

*Write for quotations.*

MASSACHUSETTS CHEMICAL COMPANY

Operates  
Walpole Varnish Works  
Walpole Rubber Works

PLANT: WALPOLE, MASS.

“The Oasis in the Desert of Waste”

## Motor Packing Waste

No dirt or grit  
All long strands and satisfaction

The J. Milton Hagy Waste Works

433 Spruce Street, Philadelphia

## THE BABCOCK & WILCOX COMPANY

85 Liberty Street, New York

Babcock & Wilcox ——— Stirling ——— A & T Horizontal ——— Cahall Vertical

# WATER TUBE STEAM BOILERS

STEAM SUPERHEATERS

Works: Bayonne, N. J. Barberton, Ohio.

MECHANICAL STOKERS

BRANCH OFFICES:

BOSTON, Delta Bldg.  
PHILADELPHIA, 1110-1112 North American Bldg.  
SAN FRANCISCO, 85 First Street  
PITTSBURGH, Farmers Deposit Nat. Bank Bldg.  
NEW ORLEANS, 343 Baronne St.

DENVER, 410 Seventeenth St.  
SALT LAKE CITY, 313 Adas Block  
WASHINGTON, Colorado Building  
CHICAGO, Marquette Bldg.  
ATLANTA, GA., 1132 Candler Bldg.

CLEVELAND, 706 New England Bldg.  
MEXICO CITY, 7 Avenida Juárez  
HAVANA, CUBA, 116½ Calle de la Habana  
LOS ANGELES, 321 Trust Bldg.  
CINCINNATI, O., Traction Bldg.



Passenger  
Paying  
Fare

Every nickel collected is registered before reaching the conductor's hand when you use the

# Rooke Automatic Fare Collector

The Rooke System is a revolution in fare-collecting methods, and as far superior to old systems as the trolley car is to the horse car.

Why not ask us to prove it?

**Rooke Automatic Register Co.**  
PROVIDENCE RHODE ISLAND

# TUBULAR POLES IRON OR STEEL



FOR  
ELECTRIC  
RAILWAYS  
ELECTRIC  
LIGHTING CO'S  
SIGNAL  
TELEPHONE  
TELEGRAPH  
TRANSMISSION  
LINE  
AND  
CATENARY  
SUSPENSION  
LINE

**ELECTRIC RAILWAY EQUIPMENT CO.**  
General Office: CINCINNATI-O-U-S-A  
Shops: READING PA - WHEELING WVA

Avoid  
Accidents  
By Using  
This  
Switch

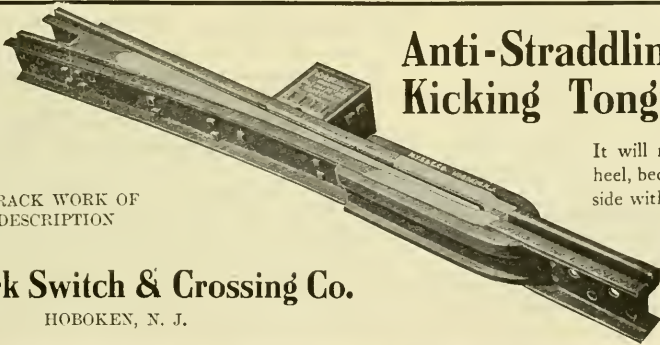

# Anti-Straddling or Anti-Kicking Tongue Switch

SPECIAL TRACK WORK OF  
EVERY DESCRIPTION

**New York Switch & Crossing Co.**  
HOBOKEN, N. J.

It will not drive down at the heel, because it is held to either side with a spring tension and firmly down on its bed. A car can not straddle this tongue.

WRITE FOR SPECIAL  
CIRCULAR

FOUNDRIES  
CHICAGO DETROIT  
DENVER ST. PAUL  
TACOMA BOSTON  
KANSAS CITY  
GENERAL OFFICES  
WESTERN UNION BLDG.  
CHICAGO

**GRIFFIN WHEEL COMPANY**  
CHILLED IRON  
**Car Wheels**  
OF EVERY DESCRIPTION  
FOR ALL CLASSES OF SERVICE  
IRON OR STEEL AXLES. REFITTING A SPECIALTY

**THE ARNOLD COMPANY**  
 ENGINEERS-CONSTRUCTORS  
 ELECTRICAL - CIVIL - MECHANICAL  
 181 LABALLE STREET  
 CHICAGO

**A. L. REGISTER & CO.**  
 Engineers and General Contractors--Electric Railways  
 112 North Broad St. PHILADELPHIA, PA. Established 1889

**H. M. Bylesby & Company**  
 Incorporated  
 ENGINEERS  
 American Trust Bldg., Chicago  
 Design, Construct and Operate  
 Railway, Light, Power and  
 Hydraulic Plants EXAMINATIONS AND  
 REPORTS

**SHIMER & CHASE CO.**  
 Experienced Promoters of Electrical Railway Projects  
 Correspondence Solicited  
 OMAHA, NEB.

**CENTRAL INSPECTION BUREAU**  
 Inspection of Rails, Ties, Cars, Motors, Bridges, Buildings, Etc.  
 17 STATE STREET - - - - NEW YORK CITY

**LINE MATERIAL**  
 ELECTRIC SUPPLIES FOR RAILWAYS, POWER PLANTS, ETC.  
 THE CREGHEAD ENGINEING CO., 348 Main Street, Cincinnati, Ohio

**J. G. WHITE & COMPANY**  
 INCORPORATED  
**Engineers, Contractors**  
 43-49 Exchange Place, New York, N. Y.  
 41-43 Wall Street  
 Principal Philippine Office: Manila, P. I.

**SMITH CONCRETE MIXER**  
 does the work better, quicker, cheaper and lasts longer.  
**CONTRACTORS' SUPPLY & EQUIPMENT COMPANY**  
 Old Colony Building, Chicago 170 Broadway, New York 9

**THE CURTAIN SUPPLY CO.**  
 CAR CURTAINS  
 CHICAGO, 85-93 Ohio Street 1819 Park Row Bldg., NEW YORK

**Complete Plants for the Rapid  
 Handling of Material**  
 Every Sort of Hoisting Apparatus  
**BROWN HOISTING MACHINERY CO.** Cleveland, Ohio

**ELECTRIC HEATERS** For All Classes  
 of Cars  
 New York Consolidated Car-Heating Co. Chicago

**GEARS AND PINIONS**  
 FOR ALL TYPES OF MOTORS  
**THE VAN DORN & DUTTON CO., CLEVELAND, OHIO**

  
 Repair your **Broken Motor Cases**  
 WITH THERMIT  
 Pamphlet No. 36-Q gives full details.  
**Goldschmidt Thermit Co.**  
 90 West St., New York  
 432-436 Folsom Street - - - - St. Louis, Mo.

SPRINGS—TIRES—STEEL-TIRED WHEELS  
**RAILWAY STEEL-SPRING CO.**  
 General Offices: 71 Broadway, New York

**BRAKESHOES**  
 STANDARD  
 BRAKESHOE COMPANY  
 GEN'L OFFICES & WORKS - AURORA, ILL. - CHICAGO OFFICE 315 BY EXCH.

  
**SPEER**  
 HIGH GRADE  
 BRUSH  
 ST. MARYS - PA.

**HART** CONVERTIBLE  
 BALLAST, GONDOLA  
 AND CONSTRUCTION **CAR**  
 RODGER BALLAST CAR CO., Railway Exchange, CHICAGO

**RE-ENFORCED SPOKE WHEELS**  
 For City and Suburban Cars  
**ST. LOUIS CAR WHEEL CO., St. Louis, Mo.**

**STONE & WEBSTER ENGINEERING  
 CORPORATION**  

---

**CONSTRUCTING ENGINEERS**  

---

 147 MILK STREET, BOSTON  
 ELECTRIC RAILWAY, LIGHT & POWER PLANTS  
 WATER POWER DEVELOPMENTS

**E. SAXTON**  
**CONTRACTOR**  
 SPECIALTIES:  
 CONDUIT ELECTRIC RAILWAYS  
 TROLLEY LINES  
 CITY AND SUBURBAN  
 CONDUIT SYSTEMS, ETC.  
 OFFICE, 841 BLADENSBURG ROAD, WASHINGTON, D. C.  
 Long Distance Telephone, East 887

# FOR SALE. FOR QUICK DELIVERY

## 6 55-ft. Passenger, Baggage and Smoking Car Bodies

Main Compartment 26' 0"  
 Smoking " 10' 6"  
 Baggage " 10' 0"  
 Seating Capacity, 54

## 8 60-ft. Passenger, Baggage and Smoking Car Bodies

Main Compartment 28' 6"  
 Smoking " 11' 0"  
 Baggage " 8' 0"  
 Seating Capacity, 58

## 5 52-ft. Passenger and Smoking Car Bodies — Double End

Seating Capacity, 60

## 3 52-ft. Passenger and Baggage Car Bodies — Double End

Seating Capacity, 56

## 2 50-ft. Express Car Bodies

*Write or wire us for further information.*

# The Jewett Car Co. Newark Ohio

## THE MIGHTY MIDGET HOT WATER CAR HEATER

Adapted for Large Electric Cars and Long Distance Lines. Exclusively used on Largest Electric Systems. Ask for Catalog

THE WILLIAM C. BAKER HEATING & SUPPLY CO., 143 LIBERTY STREET NEW YORK



## NILES CARS

(The Electric Pullmans)

LARGE, FAST INTERURBANS  
OUR SPECIALTY

Niles Car & Mfg. Co.

Works: NILES, OHIO

Sales Office: J. A. HANNA CO.  
312 Electric Bldg., Cleveland, Ohio

## CAR BODIES

Of All Types

## TRUCKS

To Suit

## CINCINNATI CAR COMPANY

CINCINNATI, OHIO



STANDARD SEMI-CONVERTIBLE—For Use All the Year

**THE NATIONAL LOCK WASHER CO.,** NEWARK, N. J.  
 Curtains - Curtain Fixtures - Sash Locks - Sash Balances - Nut Locks  
 CHICAGO OFFICE: 419 MONADNOCK BLOCK

**The Lindsley Brothers Company**  
 Producers and Shippers of **WESTERN CEDAR POLES** and Manufacturers of **RED FIR CROSS ARMS**  
 Eastern Sales Office, Monadnock Bldg., CHICAGO SPOKANE, WASHINGTON

WRITE TO **MODEL STOKER COMPANY** DAYTON OHIO  
 for detailed information about the best  
**AUTOMATIC SMOKELESS FURNACE**

**G. H. BARNES HARDWOOD LUMBER CO.**  
 Office and Yard: Main and Warren Sts., ST. LOUIS, MO.  
 Ties, Car Oak, Poplar, Ash, Cherry, Plain and Quartered Oak

**C. H. WORCESTER CO.**  
**CEDAR POLES**  
 PRODUCERS AND WHOLESALERS  
 Suite 1710 Tribune Building - - CHICAGO

**Idaho Cedar Poles**  
 PACIFIC COAST POLE CO. SPOKANE, WASH.

For prompt deliveries of  
**Cedar Poles** Red or White  
 write either office today.  
**NATIONAL POLE COMPANY**  
 EVERETT, WASH. ESCANABA, MICH.

We are Producers and Wholesale Dealers in Western  
**CEDAR POLES**  
 Yards in Washington, Idaho, Montana and British Columbia  
 WRITE US FOR DELIVERED PRICES  
**CHURCHILL CEDAR CO.,** Box 1409, Spokane, Wash.

**CHESTNUT POLES**  
 Cedar, Oak and Chestnut Ties  
 FROM OUR OWN TIMBER LANDS  
**THE ADVANCE LUMBER CO.**  
 CLEVELAND, OHIO

We have in our Chicago Yard available for **RUSH SHIPMENTS** a SE-  
**LECTED STOCK** of **POLES** and **TIES**  
**NAUGLE POLE AND TIE CO.**  
 Chicago Office, 226 La Salle Street

**Electric Railway Material**  
 of every description  
**F. P. HARRISON ELECTRIC & MFG. CO.**  
 (Incorporated) NEW YORK  
 169-170 South St.

**POLES** and **PILING**  
 20,000 35s and 40s  
 Ready to Ship at Once  
**S-E. Missouri Cypress Co.,** Campbell, Mo.

**WHITE CEDAR POLES**  
 Large Stock 14 to 65 ft.  
 Prompt Shipment  
**YARDS:**  
 Menominee, Mich.  
 Escanaba, Mich.  
 Superior, Wis.  
 Deer River, Minn.  
**FRANCIS BEIDLER & CO.**  
 Chicago, Ill.

**BERTHOLD & JENNINGS**  
 LUMBERMEN'S BLDG. SAINT LOUIS, MO.  
**TIMBERS**  
 L. L. Pine, Oak  
**POLES**  
 Cedar, Cypress, Chestnut  
**TIES**  
 Oak, Cypress, Chestnut



# THE BOILERS WILL BE OUT OF SERVICE

a much shorter time for washing, thereby requiring very much less labor, to say nothing of the saving in fuel and the increased efficiency of the boilers, if the incrusting solids and other deleterious salts in the water are acted upon by **Dearborn Compounds** and their injurious properties destroyed. Send us gallon sample of your feed water for analysis.

## Dearborn Drug & Chemical Works

WM. H. EDGAR, FOUNDER

299 BROADWAY, NEW YORK      POSTAL TELEGRAPH BLDG., CHICAGO



Established 1877.



### ALBERT & J. M. ANDERSON MFG. CO.,

Makers of

**ELECTRICAL APPLIANCES:  
SWITCHES, SWITCHBOARDS,  
TIME SWITCHES, LINE MATERIAL,  
COPPER CASTINGS (75%) CONDUCTIVITY.**  
289-293 A ST., BOSTON, MASS., U. S. A.

Branches:

New York, 135 Broadway.      Chicago, 175 Dearborn Street.

Agencies:

Boston, Pettingell-Andrews Co.      San Francisco, Eccles & Smith Co.  
New York, R. W. Marshall & Co.      Atlanta, Newcomer-Manly Co.  
St. Louis, J. C. White.      Denver, E. M. Measiter.  
Toronto, Ont., H. J. Surtees.



## Queen Testing Sets

"The Recognized Standard"

Voltmeters  
Ammeters  
Switchboard  
and Portable  
Alternating  
and Direct  
Current



Queen Acme Testing Set

U. S. Standard Testing Sets  
Rail Bond Testers  
Galvanometers, etc., etc.  
Electrical Instruments for All Purposes

**QUEEN & CO., Inc., Philadelphia, Pa.**

Another road writes as follows:

"Answering your question of recent date. Your material is all that you claim for it. It is a perfect lubricant. The benefits derived are far in excess of any other material that we have used in the past. It is most excellent."

**The Whitmore Manufacturing Company**  
Cleveland, Ohio, U. S. A.

## WESTON Standard Portable Direct-Reading

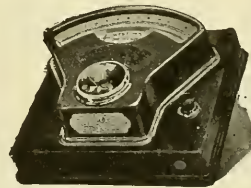

Voltmeters  
Millivoltmeters  
Voltammeters  
Ammeters  
Milliammeters  
Ohmmeters  
Ground Detectors  
and Circuit Testers

Our STATION VOLTMETERS and AMMETERS are unsurpassed in point of extreme accuracy and lowest consumption of energy.

### WESTON ELECTRICAL INSTRUMENT CO.

Main Office and Works: Waverly Park, Newark, N. J.

London Branch: Audrey House, Ely Place, Holborn. Paris, France: E. H. Cadot, 12 Rue St. Georges. New York Office: 74 Cortlandt St. Berlin: European Weston Electrical Instrument Co., Ritterstrasse, No. 88.

## TRACK DRILLS

MADE IN TWO SIZES

With automatic friction feed. Lower gears cased in to protect them from dirt.

Send for circular and prices.

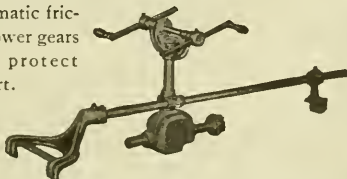

**FRANCIS REED CO. WORCESTER, MASS.**

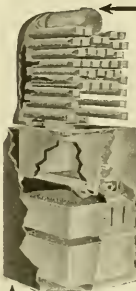

10c per day

will heat that car if you use a COOPER HEATER

Ask for descriptive matter

The Cooper Heater Co., Dayton, Ohio

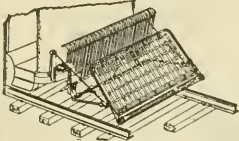

**ECLIPSE  
Life Guard**

Manufactured by the  
ECLIPSE RAILWAY SUPPLY CO.  
Cleveland, Ohio



**Time is Money**

That is one reason why the  
Atlas Anchor is so popular.

Get a Working Model Free.

THE ATLAS ANCHOR CO., Cleveland, Ohio

For CABLE, ELECTRIC and  
ELEVATED CARS

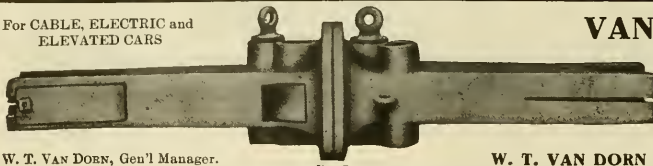

**VAN DORN AUTOMATIC  
COUPLERS**

The records go farther than talk.  
Look up the records.  
Send for booklet of information on Couplings.

W. T. VAN DORN, Gen'l Manager. No. 5

W. T. VAN DORN COMPANY, 1076 S. Paulina Street, CHICAGO

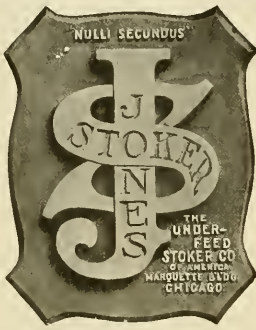

NULLI SECUNDUS

**J  
STOKER  
CO.**

THE UNDER-FEED  
STOKER CO.  
OF AMERICA  
WABUSH ST. CHICAGO



WE NOW MAKE 75% OF THE TROLLEY WHEELS.  
WE WANT TO MAKE THE OTHER 25%.

THE STAR BRASS WORKS  
KALAMAZOO, MICH.



**BALDWIN LOCOMOTIVE WORKS**  
BURNHAM, WILLIAMS & CO., PHILADELPHIA, PA., U. S. A.

Builders of **LOCOMOTIVES OF EVERY DESCRIPTION**  
Including ELECTRIC LOCOMOTIVES and

**ELECTRIC TRUCKS**

Truck built for Indianapolis, New Castle & Toledo Electric Railway Company.

**STANDARD STEEL WORKS,** HARRISON BUILDING PHILADELPHIA, PA.

SOLID FORGED ROLLED AND STEEL TIRED WHEELS ELLIPTIC AND COIL SPRINGS

mounted on axles and fitted with Motor Gears for Electric Railway Service



**PIPE FITTINGS  
AND VALVES**

FOR THE  
HEATING AND PLUMBING TRADE

TRADE  MARK

**JOHN SIMMONS CO.**

104-110 Centre Street, NEW YORK

**THE LORAIN STEEL COMPANY**

Girder Rails and High Tee Rails  
High-Grade Special Track Work

GENERAL OFFICES  
THE PENNSYLVANIA BUILDING, PHILADELPHIA, PA.

# ST. LOUIS CAR CO. ST. LOUIS-MO.

ILLUSTRATED herewith is one of twelve single-end combination passenger, smoking and baggage compartment cars for the Pittsburgh, Harmony, Butler and Newcastle Railway. These cars are of the St. Louis Car Company's semi-steel frame construction. Principal dimensions: total length, 46 feet; rear platform, 4 feet 5 inches; main passenger compartment, 22 feet 9½ inches; smoking compartment, 7 feet 8½ inches; baggage compartment, 10 feet 4 inches, including motorman's cab.

The sides are constructed with 12 window sashes and one baggage door. The lower sashes are arranged to raise, while the upper sashes are stationary. The side sashes are glazed with plate glass and the upper and deck sashes with opalescent glass.

The passenger compartment has 15 St. Louis Car Company's stationary seats, upholstered in brown plush with high head roll. In the rear of this compartment is a saloon, the side walls of which are covered with metal up to the window capping. The smoking compartment has six stationary seats, upholstered in dark green leather. The baggage compartment has three folding seats to be used when there is no baggage.

The motorman's cab is separated from the baggage compartment by an iron pipe railing. In the cab is a hot water heater on the left side of the motorman.

The cars are equipped with St. Louis Car Company's illuminated signs on the front of cars, vertical brake wheels on the front end and St. Louis Car Company's self-releasing brake handles on the rear end. They are mounted on high-speed trucks with air brakes and air sanders.



MADE IN THE LARGEST AND BEST EQUIPPED FACTORY OF ITS KIND IN THE WORLD

# CLASSIFIED ADVERTISEMENTS

Undisplayed advertisements are inserted under this heading at the uniform rate of one cent a word; minimum charge twenty-five cents. Replies directed to this office will be forwarded when required to any address in the United States, Canada or Mexico without extra charge. Advertisements received at the Chicago office by 9 a. m. Thursday will appear in the issue for the same week.

## POSITIONS WANTED.

An experienced business getter and manager would like to secure position as traffic manager for large electric system. Highest references. Address "No. 548," care of Electric Railway Review, Chicago.

Master mechanic wants position with interurban city road; medium-sized preferred. Wide and thorough experience in all branches; can also do armature winding and switchboard work. Address "No. 542," care Electric Railway Review, Chicago.

Experienced master mechanic desires position. Has thorough knowledge of high-speed electric railway equipment, on third rail or trolley. Is good executive, tactful and able to organize work of departments. Best of references furnished. Will consider position with high-speed interurban or city railway. Address "No. 550," care Electric Railway Review, Chicago.

Young man, 30 years of age, who has nearly completed a course of "Electric Lighting and Railway" in the International Correspondence Schools, desires position which will give him practical experience in power house and switchboard work. Willing to start at a nominal salary. Address "No. 536," care of Electric Railway Review, Chicago.

Position by draftsman; have had nine years' experience in electric railway work, instrument work, mechanical and electrical drafting. Experience: assistant to master mechanic and inspector of car construction, equipment and maintenance; track work and buildings. Also familiar with operation. Thoroughly reliable. Address "No. 549," care of Electric Railway Review, Chicago.

Position wanted—The manager of a large railway, lighting and gas plant must make a change in his position owing to an unfavorable climate. Has held managerial positions for 10 years and is thoroughly familiar with the construction, organization and operation of electric railways. Correspondence solicited. Exceptional references. Address "No. 533," care of Electric Railway Review, Chicago.

## POSITIONS WANTED.

Position as auditor wanted by a young man of experience in street railway and electric light accounting. Best of references as to character and ability. Address "No. 545," care Electric Railway Review, Chicago.

Position as auditor or assistant wanted by a young single man. Thoroughly experienced in railway, gas and lighting accounting. Now employed. Address "No. 544," care of Electric Railway Review, Chicago.

Position as superintendent of city or interurban line wanted by a man of 15 years' experience in both construction and operation. Best of references as to ability and habits. Open for engagement after February 1. Address "No. 541," care Electric Railway Review, Chicago.

An engineer, experienced in the handling and organizing of station crews, with 10 years' experience as chief engineer in both construction and operation, as well as reconstructing old ones on a modern basis. All voltages up to 15,000, both railway and lights. Salary or per cent, depends on results. I am looking for a reputation as well as salary. Address "No. 536," care of Electric Railway Review, Chicago.

Mechanical and electrical engineer, 14 years' experience. Experienced in power station design and for 14 months acting superintendent of power stations on one of the largest street railway systems in America. At liberty April 1. Desires superintendent of power or similar position. Would open office in Boston as New England representative of responsible manufacturer. Address "No. 546," care Electric Railway Review, Chicago.

## POSITIONS OPEN.

Superintendents, street railway, machine shop, car works, power house, engineers, electrical and mechanical, draftsmen, electrical and mechanical. Salaries, \$300 to \$5,000. Other positions open. Write, HAP-GOODS, 305 Broadway, New York, or 1010 Hartford Bldg., Chicago.

## POSITIONS OPEN.

Wanted—Electrical salesman who is selling to street railways to take important side line. J. W. Morrison, 29 Griswold street, Detroit, Mich.

## MISCELLANEOUS WANTS.

Want to buy second-hand equipment, machinery or material? A card inserted in the Electric Railway Review, stating just what you want, will bring immediate response. The cost is small—only \$1.20 an inch (measuring 1 inch deep by 1½ inches wide) per insertion. Send orders to Electric Railway Review, 160 Harrison St., Chicago.

What have you to sell in the way of second-hand equipment, machinery or material? Buyers read the "For Sale" cards on the following page and there is the place to tell your story. "For Sale" cards are inexpensive—only \$1.20 an inch (measuring 1 inch deep by 1½ inches wide) per insertion. Special rates on contracts for 100 inches or more to be used within one year. Now is the time to send your order to Electric Railway Review, 160 Harrison St., Chicago.

## BOOKS AND PUBLICATIONS.

Wanted—Copy of the Electric Railway Review of January 12, 1907, in good condition. State price in your answer. Address "No. 530," care of Electric Railway Review, Chicago.

We want your friends to read the Electric Railway Review. You will do them—and us—a favor by sending their addresses. We will gladly mail free sample copies. Electric Railway Review, 160 Harrison Street, Chicago.

Wanted—Copy of the Street Railway Review of August, 1903 (Vol. XIII), also complete sets of Vols. X and XI (1900 and 1901). State price, condition and whether latter two volumes are bound or unbound. Address "Street," care of Electric Railway Review, Chicago.

## BOOKS AND PUBLICATIONS.

Ask us about any book on electric railway and allied subjects. We publish some and sell all that are in print. The Wilson Company, 160 Harrison Street, Chicago.

Copies of the Street Railway Review of January and February, 1906, are wanted. Name condition and price. Address "No. 535," care of Electric Railway Review, Chicago.

Copies of the Street Railway Review of March and April, 1904, in good condition for binding are wanted. State price sent postpaid. Address "No. 543," care Electric Railway Review, Chicago.

If interested in any phase of steam transportation, you will find every detail covered fully and accurately in The Railway Age. It is the leader and acknowledged authority in this field. Ask for free sample copies. The Railway Age, 160 Harrison Street, Chicago.

A copy of "The Motorman and His Duties," the standard handbook on the theory and practice of electric car operation, is worth many times its cost to every man interested in the subject. Send for 16-page pamphlet of sample pages. The Wilson Company, 160 Harrison Street, Chicago.

Interstate commerce national legislation to July 1, 1906, is fully covered in our reference pamphlet. It contains the full text of the act to regulate commerce as amended, including the Elkins and Hepburn acts, and of the supplementary act relating to the testimony of witnesses before the Interstate Commerce Commission. It also contains the texts of the expedition act, the anti-trust act of 1890, the employers' liability act and the safety equipment laws. Difference in type shows the parts expunged from and the parts added to the interstate commerce and Elkins acts by the Hepburn act. This pamphlet is of special value to railway men and lawyers. Mailed prepaid for 25 cents in stamps or coin. Special prices for quantities. The Wilson Company, 160 Harrison St., Chicago.

## If You Have a Position for a High Grade Man

you can quickly secure his services in one of two ways

- by answering "Positions Wanted" advertisements on this page, or
- by advertising on this page under the heading, "Positions Open"

*Either plan will prove a winner—try it now*

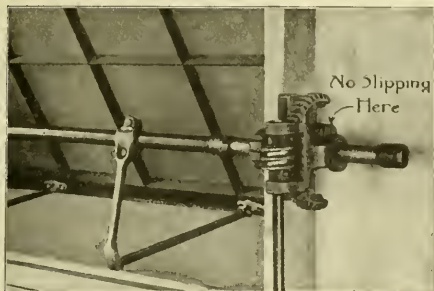

## The Ventilation

of your Shops, Foundries and Car-Barns is made especially effective by a speedy, positive and easily manipulated

## Sash Operating Apparatus

which automatically locks the sash at any position. *Let us send you our catalogue*

**LORD & BURNHAM COMPANY**  
Irvington-on-Hudson, N. Y.

## Gongs For Street Cars Bells

G. C. REITER, Canton, Ohio



## E. C. Van Valkenburgh

Promotional Advertising  
for Electric Railways

2117 West 102d Street : Chicago

*A definite plan—good copy—careful attention to detail—these are the essential features of Van Valkenburgh Advertising Service.*

## We've eliminated machine work in Lumen Metal Mold Axle Bearings.

Our claim that these bearings will effect a saving of about 30 per cent is worth investigating. Write us—today!

Buffalo **LUMEN BEARING CO.** Toronto

## GREEN FUEL ECONOMIZER CO.

Sole builders of the Green Fuel Economizer in the United States. Also Fans, Blowers and Exhausters, Steam Heating Coils and the Green Air Heater. Heating, Ventilating and Mechanical Draft Apparatus. Send for Book "SV" on Fuel Economy and Fan Catalogue.

**GREEN FUEL ECONOMIZER CO.,** Matteawan, N. Y.

## Coach and Car Roof Paint

"Metal" Canvas Preserver—Priming Coat  
"Metal" Canvas Roof Paint—Other Coats



**ST. LOUIS SURFACER & PAINT COMPANY**  
St. Louis, U. S. A.

**R.W. MARSHALL & CO.**  
95 and 97 Liberty St., NEW YORK  
Second-Hand Machinery and Equipment  
**ELECTRIC RAILWAY MATERIALS**

**RAILS**  
*Locomotives Cars Etc.*  
*Bought & Sold*  
*Walter A. ZELNICKER Supply Co.*  
12 ST. LOUIS

**FOR SALE CHEAP!**  
One 1422 eight-wheel locomotive  
Ten 34-foot 50,000 capacity flat cars  
Two Greenleaf turntables  
10 box cars, 40 and 50,000 capacity  
80 Good Second-hand Bridges  
Specifications and Blue Prints on application  
**F. A. JOHANN**  
1624 Pierce Bldg., St. Louis, Mo.

## FOR SALE: Three Car Bodies and Three Pairs of Double Trucks

with or without electric equipment and air brakes; all new and never used. Compelled to sell, as these cars will not operate over a leased line by reason of their width and length.

**R. W. MARSHALL & CO.,** 97 Liberty St., New York, N. Y.

## HEINE SAFETY BOILER CO.

421 OLIVE STREET, ST. LOUIS, MO.

Manufacturers of WATER TUBE BOILERS

### NO SNOW TO DELAY CARS

The Russell Snow-Plow is used by more than 50 roads to maintain schedules and prevent blockades. Russell Car & Snow-Plow Co., Ridgway, Pa. Wendell & MacBride, Cortlandt St., New York; C. A. Raiston, Fisher Bldg., Chicago; Robinson & Cary Co., Saint Paul.

**IF YOU HAVE A RUSSELL**

## ROSSITER, MACGOVERN & CO. (Inc.)

90 West Street, New York

**ENGINES** Boilers, Locomotives, Cars,

New and

**GENERATORS**

2nd Hand

Transformers, Railway, A. C. & D. C. **MOTORS**

## SOLENOIDS AND MAGNETS

for any purpose; lift and travel guaranteed.

Special electrical work and motors.

**THE PORTER MFG. CO.,** 29 Griswold St., Detroit, Mich.

**INSULATING VARNISHES**  
(BAKING; AIR-DRYING)  
**COMPOUNDS**  
**TAPE**

**P&B**

Possess the Highest Insulative Efficiency.  
**The Standard Paint Co.**  
100 William St.  
New York.



## PATTEN TICKET DESTROYER

Don't burn your used tickets. Destroy them, and avoid fraud. Remember, it is difficult to get a man to destroy anything of value to him. Sell the old stock—it will soon pay for machine. In use on the Boston & Northern R. R., Old Colony St. Ry. Co., Brockton St. Ry. Co., Waterbury El. Co., Bridgeport Traction Co., Buffalo Ry. and others. Write for circular.

**PAUL B. PATTEN**

78 Lafayette Street - SALEM, MASS., U. S. A.

## POLE PAINTS

that insure economy through exceptional durability. Let us send you a color card.

**Detroit Graphite Company**  
DETROIT, MICH.  
Dept. S.

## Do away with the Hot Box Habit on your road

by using STEEL WOOL JOURNAL PACKING—the perfect packing that has accomplished this result on many roads

*Send now for a free sample and test it*

**WM. ROBERTSON & COMPANY**

General Office: Great Northern Bldg., CHICAGO  
Factory: 75 S. Jefferson St., BATTLE CREEK, MICH.

10

## It Pays →

to buy this type of brake shoe—the kind approved by the A. S. & I. R. A. Standardization Committee.

We would like to give you figures based on facts that prove it! Write

**American Brake Shoe & Foundry Co.**  
New York Chicago Chattanooga MAHWAH, N. J.

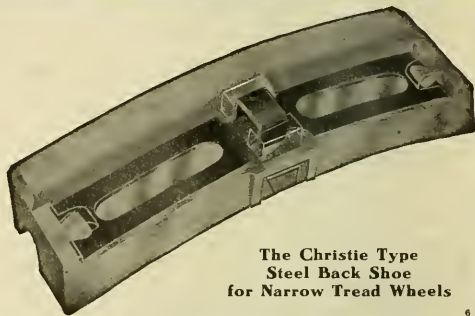

The Christie Type  
Steel Back Shoe  
for Narrow Tread Wheels

6

Wherever perfect ventilation is desired  
—there's the place to install

## The Lovell Window and Shutter Operating Device

With it any number of sash up to 500 feet are operated from one station. As the operating station is always placed on the wall at end or side of building, the windows may be quickly closed in case of fire, while people are leaving the building.

There are many other excellent points we would like to tell you about.

Send us drawings or blue prints, or tell us the length of your runs and number of sash to be operated and height of sash from floor, and we will cheerfully furnish estimate for the apparatus f. o. b. cars, or erected complete.

**THE G. DROUVÉ CO.**

BRIDGEPORT, CONN., U. S. A.  
Western Office, 40 Dearborn Street, Chicago

## A Generally Useful Portable Motor

\$65

It will pay for  
itself quickly.

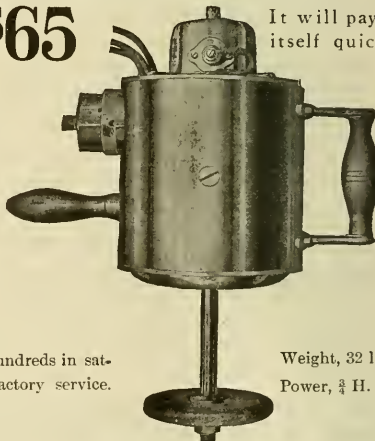

Hundreds in satisfactory service.

Weight, 32 lbs.

Power,  $\frac{3}{4}$  H. P.

Order now for early delivery

**Cleveland Armature Works**  
Cleveland, Ohio

23

# Electric Railway Review

PUBLISHED EVERY SATURDAY BY THE WILSON COMPANY, CHICAGO

Entered as second-class matter January 5, 1907, at the postoffice at Chicago, Ill., under the act of March 3, 1879.

160 Harrison Street, Chicago  
150 Nassau Street, New York  
1529 Williamson Bldg., Cleveland

VOL. XIX  
No. 8

CHICAGO, FEBRUARY 22, 1908.

Whole No.  
272

Subscription: Domestic . . . \$2  
Foreign . . . \$5  
Canada . . . \$3.50

The introduction of the pay-as-you-enter fare collection plan has brought good results in more than one way. The new scheme has worked successfully wherever cars designed for it have been put into service, and to the credit of the new system it must be said that several quite severe tests have successfully been under-

**Doing  
Double  
Duty.**

gone. So much for the pay-as-you-enter car serving its intended mission. A second and even more widespread benefit comes about as a result of the publicity given the new system by the newspapers and its promoters. We venture the statement that there is hardly an electric railway manager who has not considered for his own property whether or not its cars and passenger handling methods are the best to be had—and these considerations must make for better results. Various managers and superintendents are now, with renewed vigor, attacking the fare collecting problem. This study will surely bring about beneficial results through means peculiar to individual properties. Therefore we say that the introduction of an improved fare collecting plan has performed a double mission.

The use of tickets involves a danger of loss from counterfeiting or theft, as the recent experience of the Washington Rail-

**Protection in  
Engraved  
Tickets.**

way & Electric Company at Washington, D. C., has shown. When printed lithographic or other mechanically produced tickets are used the danger from counterfeiting will be materially reduced if water-marked or other protective papers and cardboards are used. But even with these duplication or a reasonably close imitation can be effected and it may be only after a large number of counterfeit tickets have been used that the fraud will be detected. The most reliable protection is engraved tickets, the plates for which it is practically impossible to duplicate. The geometrical lathe work can be reproduced only by those having expensive machinery and the hand tooling is practically impossible to duplicate exactly. Because expensive machinery and highly skilled labor are required for the production of engraved tickets they are more expensive than other sorts. After the initial expense the cost, however, is not materially higher when the additional safeguard in their use is taken into consideration. With them the danger from counterfeiting is practically eliminated and owing to the precautions exercised by the reputable engraving companies the danger from theft of plates is very small.

The duties of the superintendent of rolling stock and shops on any large system should be such that he may have ample time to thoughtfully consider economies—small,

**Saving  
Oil and  
Brakeshoes.**

perhaps, for each unit, but of considerable amount when all the equipments of the road are summed. When a superintendent has his full time occupied with humdrum routine work it is hardly possible for him to give to the economy problem the thought which it warrants. As an example of how profitable it is to study some particular class of expenditure, we recall that on one of the large city systems operating

about 2,000 cars, no special study had been made of car oiling and brakeshoes until about a year ago. At that time the department head in charge of rolling stock employed an assistant to whom the especial duty was assigned of lowering the unit costs for the oil and brakeshoes. It was expected that his wages at \$150 a month would more than be paid out of the savings anticipated. The expectations have been met. About a year ago armature bearings were oiled regularly once in five days. Careful attention to the details of the work and an especially watchful inspection have resulted in these same bearings receiving oil but once every three or four weeks. Similar attention has been paid to the inspection, adjustment and reversing of brakeshoes so that during the last six months the life of brakeshoes has been increased 6 per cent.

The purchasing department of an electric railway must ever be on its guard. In a paper on the subject "Selection of

**Troubles of  
the Coal  
Dealer.**

Coal," by E. G. Bailey, chief of coal testing department A. D. Little's laboratory, Boston, Mass., presented before the New England Street Railway Club during the past week, the speaker not only recited the various difficulties with which the coal miner is confronted in his attempts to deliver uniform grades of coal, but also gave his audience some valuable suggestions about determining the value of coal both before and after purchasing. A purchaser should not base his judgment entirely upon price and quality, whether these characteristics are gained by measuring the heat units or evaporation of power. Besides these qualities there are certain practical things that must be considered, such as delivery and the question of spontaneous combustion. A definite money value cannot be placed on these, but each purchaser is called upon to exert his own judgment. When a contract for coal has been made the purchaser should take every means to assure himself that he gets the value contracted for. This may seem like an unnecessary caution, but, as the speaker assured his audience, the most honest coal dealer cannot always deliver the quality of coal contracted for.

The Market Street Elevated Railway of Philadelphia, Pa., includes in its design many features of especial engineering

**Special  
Operating  
Signals.**

interest. These have, from time to time, been described in the Electric Railway Review and elsewhere in the technical press. Of interest, however, to operating men is a detail seldom made use of in any railway and one which we are assured adds greatly to the reliability of schedules, meanwhile reducing to a minimum the power demand. It will be remembered that on account of various permanent structures the profile of this road is uneven. The trains leaving the subway under the business portion of the city must climb a rather severe grade to reach the level of the elevated structure. A little farther on in the journey these trains dip under the elevated structure of a steam railway and so on, until the western portion of the city is reached, the trains must alternately ascend and descend short grades. To assist the motorman in maintaining schedules, meanwhile

obtaining the desirable features earlier mentioned, there are placed, at properly located points along the right of way, signs indicating to the motorman that he shall turn on or off his power as he passes a particular sign. Inasmuch as the equipments are operated in multiple-unit trains with motors on each car, the variation in the length of a train does not affect the acceleration, either negative or positive; and it is found that this small detail contributes largely to the success of maintaining the trains on schedule time, as well as assuring that the power is not unnecessarily wasted by a thoughtless motorman. Probably there are but few situations where a similar practice could be used throughout the length of the road, but on the other hand there is, undoubtedly, no road that could not find a number of locations along its route at which, if such signs were placed, a direct gain could be obtained.

---

### THE LOST CAPITAL ACCOUNT IN CLEVELAND.

---

Valuation of the Cleveland Electric Railway will determine the true extent of its "lost capital account," to which reference has been made repeatedly in the negotiations that have been in progress in Cleveland since December 4. F. H. Goff, the arbitrator representing the Cleveland Electric Railway, speaks of the extent of this lost account as due to a misguided but sincere belief that the city of Cleveland would willingly grant a renewal of franchises when they expired. Throughout the years when advantage was taken of these franchises it was assumed by the company that its right to continue to operate in the streets of Cleveland would be conceded without hesitation by the municipality, and that the existing large investment would indefinitely constitute a capital asset of great value. Such an assumption, always unsafe, has proved particularly distressing in Cleveland, where Mayor Johnson, with a fortune made from the promotion of street railways, pictured the traction question as the sole political issue before the voters, promoted an independent company to harass the Cleveland Electric Railway and has zealously protected the investment in the competing line. Such conditions may not develop soon again in any large city of this country; but, as Mr. Goff has indicated, it was thought a few years ago that the Cleveland Electric Railway would have only a peaceable renewal of its franchises to arrange.

Until the final figures are determined it is impossible for anyone to do more than guess what the amount of the difference between the capitalization of the road and the agreed value of the property will be; Mr. Goff and Mayor Johnson have been wise in endeavoring to discourage speculation in the stock by making this fact plain. That the discrepancy will be serious, however, is clear.

The outstanding stock of the Cleveland Electric Railway is \$23,400,000, all of one class. The three outstanding issues of bonds aggregate \$9,026,000, maturing as follows: On July 1, 1909, \$2,026,000; on March 1, 1910, \$1,000,000; on March 1, 1913, \$6,000,000. The total outstanding capitalization, therefore, is \$32,426,000. In the issue of the Electric Railway Review of February 1, 1908, an account of the work accomplished upon the valuation up to that time was published; and later developments have been given in subsequent issues. With nearly all of the items of the physical property agreed upon, the total agreed value so far is \$14,319,924; but there still remain to be settled the value of auditor's stores, including rails, ties and track, and the amount which shall be allowed for overhead charges. Pending the final decision upon these questions, H. J. Davies, secretary of the Cleveland Electric Railway, and Prof. Edward W. Bemis, representing the city, are engaged upon the work of determining the value of the unexpired franchises. As was to be expected, more wide differences of opinion have developed over this feature of the valuation than over any other. The worth of the unexpired franchises is to be computed by determining the earning power of the various lines

and capitalizing the net earnings. The Cleveland Electric Railway would be willing to allow 60 per cent for operating expenses (including depreciation) and taxes, but Mayor Johnson thinks that the rate should be 65. Compromise upon 62.5 per cent has been suggested, but it is probable that a special investigation will be made before a definite agreement is concluded upon this point.

It is apparent that there must be a number of arbitrary decisions concerning the value of franchises. Mayor Johnson wants to assume that the Cleveland Electric Railway has suffered a depreciation in the value of its franchises because its original monopoly in urban business has been destroyed by the franchises granted by the city council, under his direction, to the lines which he has promoted. While this competition has been a source of trouble to the Cleveland Electric Railway, it must be admitted that without the paternal and unfair assistance of the city administration of Cleveland the competition would never have reached a point where it would have been worthy of respectful consideration. The standards of the service and the equipment of the Forest City Railway, notwithstanding the fostering care of the city officials, have been far below the standards of the Cleveland Electric Railway. In speaking of his desire that the new arrangement shall permit the financing of future extensions on an economical basis, Mr. Goff has urged that the security franchise to be granted to the Cleveland Electric Railway shall be sufficiently broad in terms to assure the protection of abundant capital; and he has emphasized the fact that in the reconstruction and extension of the property no construction of the character of that of the Forest City Railway will be allowed. It should be recognized that the Forest City Railway has added to the burdens of the Cleveland Electric Railway not because it had great resources or an enterprise which promised to yield abnormally large profits, for neither of these conditions was true of the property, but because Mayor Johnson was able to pervert the power of the city council; if this legislative body had not used its authority to bolster the operations of the independent company, and city time and labor had not been given free of cost, the competitive effect upon the Cleveland Electric Railway would have been very slight. Shorn of the backing of the mayor of Cleveland the Forest City Railway would soon be forced to show the inadequacy of its resources to provide a service equal to, or closely approaching, that offered by the Cleveland Electric Railway, and to clear up the question as to the profit or loss which would result from its operations on a low-fare basis if proper accounting methods were followed. The widespread acceptance of these facts makes it seem likely that Mayor Johnson has raised the talk of the effect of competition in order to "help the trade."

The present experience of the Cleveland Electric Railway illustrates the dangers of limited urban franchises. Attempts to secure renewals of such franchises may be met by insurmountable obstacles. When municipalities urge the construction of new lines and offer franchises thereof extending beyond the maturity of the rights held by terminal lines in congested districts, companies should resist the bait unless they are assured that the rights of outlying properties are substantially protected by franchise privileges in the central district. The only positive safeguard against the "lost capital account," when the right of a company to furnish transportation service in an urban community is based upon limited franchises, is the creation of a reserve fund to provide for the amortization of the investment.

---

Samuel Kahn of the San Antonio Gas & Electric Company, editor of the Southwestern Electrical and Gas Association question box for 1908, is sending out invitations for questions for the next convention question box. The convention is to be held at El Paso, Tex.



ANNUAL REPORTS.

Chicago City Railway.

The report of the Chicago City Railway for 1907 is made up in new form because the company operated for 11 months of the year under the ordinance providing for a distribution of net earnings with the city. The income account shows:

Passenger receipts (January excluded).....	\$7,460,634.96
Receipts from other sources (January excluded).....	102,059.20
Gross earnings .....	\$7,562,694.16
Operating expenses, taxes, renewals and interest on capital investment, as approved by board of supervising engineers.....	6,410,272.66
Net earnings for 11 months.....	\$1,152,421.50
City's proportion, 55 per cent, as per ordinance..	633,831.83
Company's proportion, 45 per cent.....	\$ 518,589.67
Invested in capital as certified by board of supervising engineers .....	1,116,386.77
Income from operation for 11 months.....	\$1,634,976.44
Other income from January operation, etc., net.....	281,581.88
Net income .....	\$1,916,558.32
Dividends .....	1,215,000.00
Surplus .....	\$ 701,558.32
Value of property December 31, 1907, as per certificate of board of supervising engineers....	\$28,168,980.58
Percentage of annual income on above valuation (based on 11 months' operation).....	6.33
Percentage of net income upon capital stock at par.....	10.64

In his statement T. E. Mitten, the president, says:

Three hundred cars of the new pay-as-you-enter type have been purchased, 150 of which have been placed in service, resulting in almost entirely eliminating the large number of accidents brought about by passengers attempting to board or leave moving cars. The proportion of fares collected to passengers carried has also been materially increased, due to the collection of fares by conductor upon the rear platform.

The entire number of double-truck cars required to be supplied under the ordinance during the 3-year period has now been secured. The company has 805 double-truck cars and 251 single-truck cars, making 1,056 cars required by ordinance.

A total of 31.5 miles of new track has been reconstructed during the past year under the provisions of the ordinance, of which 10 miles were in replacement of cable tracks.

Three new modern substations, suitably located for the distribution of power, have been placed in service.

Two new car stations of large capacity and modern equipment are practically completed, which when in use will make possible the systematic and economical inspection and cleaning of cars.

The result of operation of your property for 1907 comprises 11 months' operation under the partnership arrangement and one month (January) for individual account.

The passenger earnings for the year were \$8,087,000.88, an increase of 4.1 per cent. The average fare was unchanged, namely, 3.1 cents per passenger carload.

As the operating expenses for 11 months of the year were arbitrarily fixed at 70 per cent, to comply with the provisions of the ordinance, there is no opportunity for comparison with the results of previous years.

It is a source of gratification that as the provisions of the settlement ordinance, by which the city participates in the net earnings of the company, become more generally understood, the public and the city authorities are showing an increasing willingness to co-operate with the management in removing obstructions to rapid transit and in such of its other undertakings as have clearly for their purpose the improvement of the service.

The number of fare passengers increased 3.99 per cent in 1907 over 1906 and the number of transfer passengers showed an increase of 2.69 per cent. The increase in the total number of passengers was 3.5 per cent. Traffic statistics follow:

	1907.	1906.	1905.
Fare passengers .....	162,422,148	156,177,363	145,500,483
Transfer passengers .....	97,171,371	94,623,106	87,911,785
Fare and transfer passengers.....	259,593,519	250,800,469	233,412,268
Percentage of transfer to fare passengers .....	59.83	60.59	60.42
Miles of single track.....	244.30	242.56	219.14

# Communications

## MEXICO STREET RAILWAYS.

To the Editors:

Many derogatory accounts have been given and published of the bad condition of street railways in the city of Mexico. So much have I seen and heard of this kind that upon my arrival here recently I was happily surprised to find a system, with very few exceptions, quite as much up to date as may be found in any city of the same size in the United States. And I will say further that, considering the conditions, especially the class of people the management has to contend with, it is remarkable what is being accomplished. I am certain that those in charge have not been given sufficient credit for what they have done and are doing.

To begin with, all employees in subordinate positions, as well as many of those in positions of trust, are natives. Nearly all speak and understand only the Spanish language. I was told that in the great shops of the Compania Limitada de Tranvias Electricos de Mexico only two men, the master mechanic and his assistant, could speak English. Both are Americans, as are many of the heads of departments. Mexicans, however, are fast fitting themselves for the higher positions and eventually will become the actual operators.

The lower classes, from which the great majority of employees must be selected, are as a rule ignorant, dirty, stupid



Fare Receipt Used in Mexico City.

and short on morals. They have no ideas of responsibility, own nothing but the scant clothing on their backs and perhaps a blanket, which is used for a bed. From such material the management is making responsible, clean and orderly motormen, conductors, clerks, machinists, carpenters, painters, electrical workers, etc. It is no easy task, but it is being done by the establishment of all sorts of ways and means to teach and compel honesty, morality and cleanliness, such as schools for instruction, baths, barber shop, reading rooms, lockers and a tailor to press and clean their clothes, all of which are absolutely free to the men (no games have yet been put in).

Notwithstanding all this it will and does take a long while to make the ordinary native a good, orderly, appreciative employe. It is the right course, however, and is bearing rich fruit in the north. One example I must mention simply to illustrate the patience required in operating in Mexico, where nothing is done today, but promised tomorrow.

Many conductors, after quite a long service on certain lines, do not know the names of the streets they run on, nor the names of the cross streets, hence never dream of calling out any stops. One must know by some means where he wants to go and what car to take before he gets aboard or else he will be sure to go the wrong way. Conductors only collect fares and attend to the trolley. They have no care for the passenger; it makes no difference how he or she gets off or on, except sometimes they will give the starting bell. The motorman generally watches carefully, however, and has mirrors at each side of him so that he can see what is going on behind without turning his head.

The conductors are not entirely to blame for not calling

the names of the streets, because many streets change their names every block or two, although running in straight line.

Fares are collected by the conductor, who gives a thin paper ticket to the passenger, punched with the date. Inspectors board cars at many places, examining tickets in the hands of the passengers to see that they have been properly issued. Should the conductor have missed a fare the passenger is promptly obliged to pay and get his ticket, which, like all the others, the inspector either punches or tears partly in two. This plan is good and works well, especially on cars where several rates are charged to different places. It is quite similar to the system used in London and other parts of England on tramways and buses. On a few lines the regular American fare register is used; but, although inspectors are used with this system, I am quite sure it does not equal the ticket in fare collection.

The tickets used are printed at the company's head office. The counting, checking and caring for all tickets are done at the printing office. Smoking is permitted on all cars and in all places in and about the car offices, shops, banks, and, in fact, everywhere except in the churches. Several attempts have been made to stop the smoking on the inside of cars, but they have failed.

The motorman seems to understand his business very well and is much more careful than in the United States. This is quite necessary, because the peons and people generally on the narrow streets are the most careless that I have ever seen, both in walking and driving. Stops are always made before crossing a street intersection and the rule for passengers to board by the rear and alight by the front step is well enforced. No one is permitted to ride with the motorman, but the rear platform is almost always crowded; hence the management does not believe the pay-as-you-enter car would be a success in this city, on account of its large platforms.

The front doors of the cars are painted the same color as the car body so as to protect the sight of the motorman at night. Many of the cars of this company are single-ended, turning on loops. All cars pass around loops in the great plaza in front of the celebrated cathedral. This is a great convenience to the public, as it is the real center of the city. Should one make a mistake it is easily remedied by remaining on the same car, which, although it probably will return by another street, will inevitably reach the plaza. The reason for using different streets for the return trip is that generally they are too narrow to accommodate street cars with double track and vehicular traffic also; so only one track is laid on the street, and that usually from three to four feet between the curb line and the nearest rail.

The company has several cars already built without monitor roofs, with ventilators along the top similar to the General Electric gasoline-electric car, illustrated on page 110 (January 25, 1908), of your valuable journal. These cars seem to give perfect satisfaction and the difference in style is not noticed, while both cost and weight have been cut down considerably.

T. J. NICHOLL.

Mexico City, February 13, 1908.

The Western Ohio Railway has arranged, in connection with the New York Chicago & St. Louis Railroad, an excursion to Cleveland on February 22. The route is via the Western Ohio Railway to Mortimer, where connection is made with the steam road for the balance of the trip to Cleveland. Round-trip rates were as follows from points on the Western Ohio road: Wapakoneta, \$2.50; Cridersville, \$2.25; Lima, \$2.00; Beaver Dam, \$2.00; Bluffton, \$1.80; Rawson, \$1.55. The return tickets are good until and including the regular train leaving Cleveland at 7:33 p. m. on February 24. In advertising this excursion by poster, Charles F. Price, general passenger agent Western Ohio Railway, called attention to various attractions at Cleveland theaters.

### ELECTRIC PARK CAR HOUSE—UNITED RAILWAYS & ELECTRIC COMPANY.

A car house embodying many features of advanced design has just been completed by the United Railways & Electric

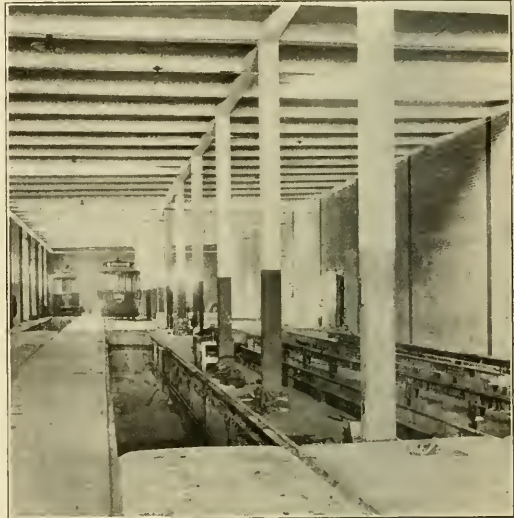

Electric Park Car House—View in One Bay, Showing Depressed Floor Between Pits.

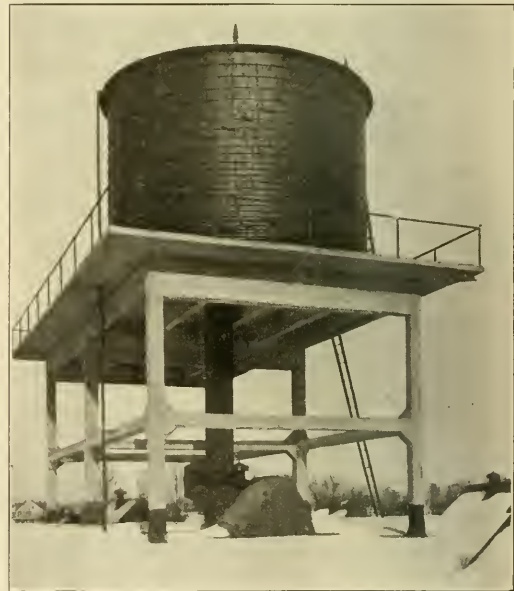

Electric Park Car House—Concrete Support for Tanks on Roof.

Company of Baltimore, Md. The new car house is located at Electric Park, about 12 miles from the business district of that city, and will serve the cars on several lines operating radially into Baltimore. Accompanying engravings reproduced

from line drawings and photographs show in a very complete way the structure just completed and several of its prominent features. Messrs. Simonson & Pietsch, architects, Baltimore, had charge of the design and erection of the structure under the guidance of H. H. Adams, superintendent of shops.

The new Electric Park car house, as shown in the accompanying ground plan, comprises five bays with a frontage of 213 feet 6 inches. Four of these bays have a length of 294 feet 4 inches; the fifth bay, somewhat shorter in length, is subdivided into rooms to be occupied as follows: Car dis-

stands close to the street line and that by a special arrangement of track work a large proportion of the switches and frogs from the leads to the car house tracks fall under cover. This special arrangement of tracks leaves unoccupied by tracks a triangular portion of the floor space at the front of each bay. These spaces have been used for storage purposes. At the front of one bay is a special fireproof room in which are taps for the oil supply. The oil for immediate use is not kept in the building, but is stored in a 120-gallon tank buried outside of the building line in front of the oilroom

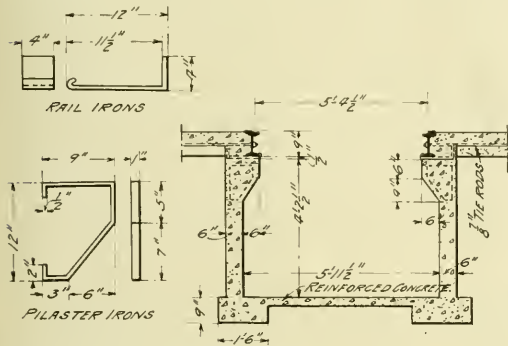

Electric Park Car House—Pit Detail.

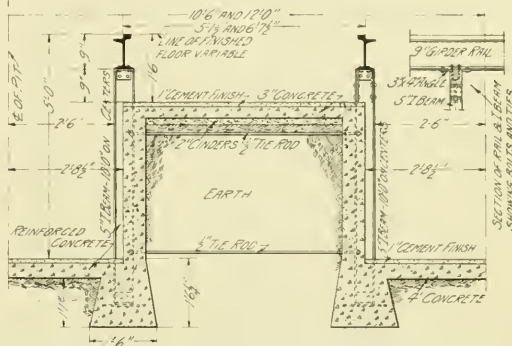

Electric Park Car House—Pit Detail with Depressed Floor.

patcher, line superintendent, motormen and conductors, toilet, locker, assembly, shop and boiler house. Each of the four long bays has four tracks extending from end to end. The total trackage in the four sections is sufficient to store one hundred and eight 45-foot cars.

The building construction of this car house conforms

just mentioned. A steel-concrete stairway leads to a small storeroom above the oilroom. The triangular space at the front of the second bay is divided into two rooms, in one of which sand is stored; the other is set apart for the use of the car cleaners. A stairway over the sandroom affords convenient access to the roof of the car house. In the third bay



Electric Park Car House—View of Exterior.

closely to that recently adopted as standard by the United Railways & Electric Company. The foundations, floors and roof structures are all of concrete, reinforced where necessary. The side, end and curtain walls in this car house are of brick. A considerable amount of cut stone has been used for decorating the front of the building. Seven skylights built in the concrete roof serve to illuminate each bay. The monitors supporting these skylights are built of concrete slabs, the glass being held in a copper-covered framework. The window openings in the side walls have sheet metal sashes.

It will be noted from the ground plan that the car house

a similar space is utilized entirely for sand storage, and in the fourth bay the triangular floor space not occupied by the tracks is set off from the interior of the car house by a fireproof wall through which there is no opening. This room forms a very convenient place for oil storage. It may be entered only from the exterior of the building through a special fireproof door.

To provide an emergency water supply a large tank has been mounted on a reinforced concrete tower above the roof of the two middle bays. One of the accompanying engravings shows this tower with the tank upon it. The upper floor of

the tower is of sufficient area to accommodate another tank of a size equal to that already installed. Leading from the tank are pipes connecting with hose outlets placed systematically about the building.

Three of the bays are provided with inspection pits built according to the detail drawings presented herewith. It will be noted from the illustrations that the floor between the pits is depressed and that the rails are carried on structural steel

emptied by a motor-driven centrifugal pump mounted on the floor of the small shop adjacent to the inspection bay.

**A CORRECTION.**

In the issue of the Electric Railway Review of February 8, page 179, we published what purported to be the names of certain standing committees of the recently organized American Street and Interurban Railway Traffic and Transportation Association. This publication was entirely premature and unintentional so far as the authorities of the association were concerned. Certain names were given to the editor in confidence as a draft of the committees, and the memoranda covering that draft were by inadvertence construed as "copy" in the office during the absence of the editor. We desire in this public manner to give expression of our regret at this occurrence and to state that the fault was entirely our own and that neither Secretary Swenson of the American association nor any of the officers of the new association were in any way guilty of the discourtesy of this publication prior to the notification of the individuals of their appointment. We sincerely regret the occurrence and trust that the parties concerned, as well as our readers, will accept our apologies.

**High-Tension Direct-Current Railway in Switzerland.**

An electric railway connecting the city of Bellinzona, Switzerland, with Mesocco is interesting, since the electrical supply is at 1,500 volts direct current. The power station for supplying the railway is at Cebbia, just above Mesocco, on the Moesa river, where there is a fall of nearly 1,000 feet. The length of the road is nearly 20 miles. The grades are heavy and 50-ton trains are hauled over the line at a speed of 12½ miles an hour. A dam across the river forms a reservoir from which a pipe line runs to the power station, where there are two 1,000-horsepower turbines, each coupled to a three-phase generator on one side and a direct-current generator on the other. The three-phase generators are rated at 420 kilowatts, 10,000 volts, 50 cycles. The direct-current generators are rated at 275 kilowatts, 1,600 volts. Direct current is supplied direct to the trolley wire at Mesocco, while the high-tension alternating current

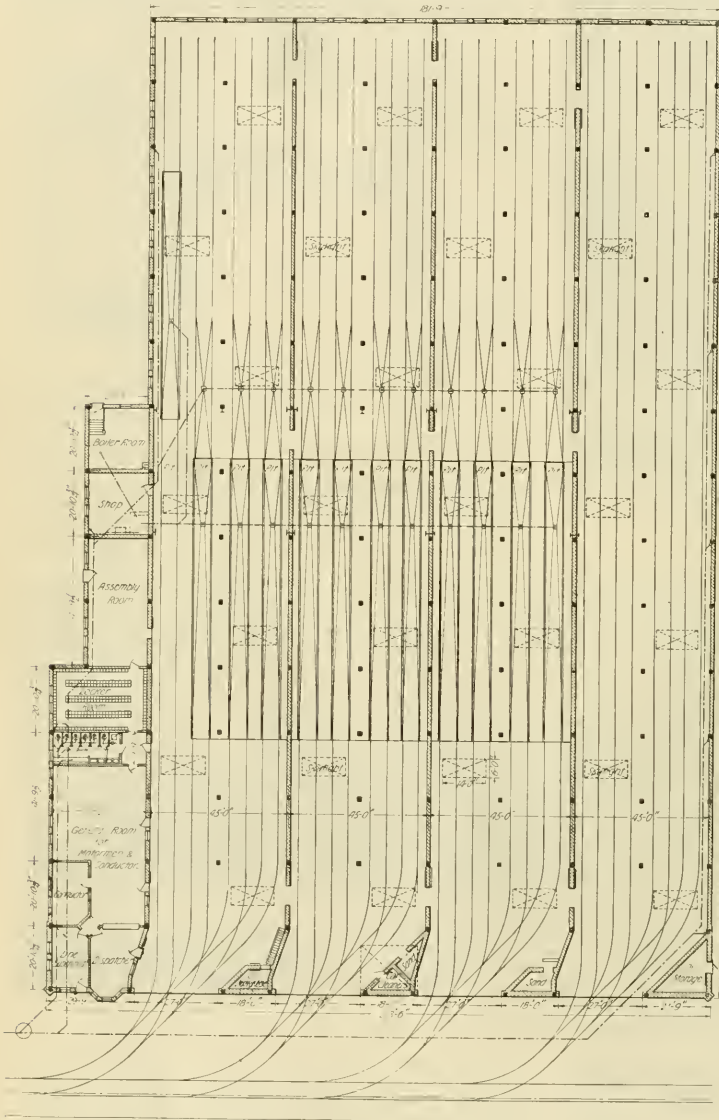

**Electric Park Car House—Floor Plan.**

posts. This detail of construction affords more room and better light for car inspection and the making of light repairs. Each pit has installed in it radiating coils connecting with the steam piping of a system that heats the entire structure. The pits and also the washing floor at the rear of the pits are provided with drainage traps leading to sumps which are

is transmitted to a substation, where it is transformed, by means of motor generators, to direct current at 1,500 volts. There are two of these sets, each with an output of 400 horsepower. The motor cars are about 45 feet long, each equipped with four motors, one on each axle.—Railway and Engineering Review.

### MEETING OF INDIANA RAILROAD COMMISSION AND OPERATING OFFICIALS OF ELECTRIC RAILWAYS.

A notable conference was held between the Indiana railroad commission and representatives of electric railways on Tuesday of this week at the Indiana state house, Indianapolis. The meeting was called by the following circular:

It being the duty of the railroad commission "to keep informed as to the condition of railroads and railways, and the manner in which they are operated with reference to the security and accommodation of the public," an inquiry and investigation is hereby instituted as to the rules for operating and dispatching cars, and as to the qualifications of motormen and conductors, on the traction lines of this state.

The managers, superintendents and dispatchers of said railroads are, therefore, requested and directed to appear before the commission for conference and information upon these subjects, and for the purpose of formulating and adopting uniform operating rules and practices, and for providing for the instruction of conductors and motormen in their rules and duties, and to take such other steps for safe operation and the prevention of accidents as may be agreed on or ordered.

In response to the invitation of the commission a large number of operating officials of electric railways were present when the meeting was called to order at 10 a. m. by Union B. Hunt, chairman of the commission.

#### Representatives of Commission and Companies.

Representing the commission there were present, besides Mr. Hunt, the other members of the commission, C. V. McAdams and W. J. Wood; also Alexander Shane, chief inspector; D. E. Matthews, inspector; Charles B. Riley, the secretary; and L. E. Morton, the clerk. Among the representatives of electric railways present were the following:

Indiana Union Traction Company—H. A. Nicholl, general manager; C. A. Baldwin, superintendent of transportation; C. S. Keever, division superintendent at Muncie; M. W. Surratt, superintendent Tipton division; C. W. Drago, dispatcher Tipton division; J. B. Buris, dispatcher, Anderson; A. G. Snell, chief clerk to superintendent of transportation.

Ft. Wayne & Wabash Valley Traction Company—C. D. Emmons, general manager; R. T. Gunn, superintendent of transportation; F. I. Hardy, superintendent interurban division.

Angola Railway & Power Company—S. A. Wood, vice-president.

Chicago South Bend & Northern Indiana Railway—Charles G. Lohman, superintendent; W. T. Durbin, director; R. R. Hayes, chief dispatcher.

Ohio Electric Railway—A. Benham, assistant district manager.

Evansville & Mt. Vernon Electric Railway and Evansville & Eastern Electric Railway—C. H. Batlin, general manager.

Evansville & Southern Indiana Traction Company—F. M. Durbin, general manager.

Evansville Suburban & Newburg Railway—Gus Mulhausen, general manager.

Indianapolis & Cincinnati Traction Company—Charles L. Henry, receiver; George S. Henry, traffic manager; G. D. Nicoll, mechanical and electrical engineer; Oscar Lively, trainmaster; D. A. O'Mara, chief dispatcher.

Indianapolis Crawfordville & Western Traction Company—A. H. Stockton, acting general manager; J. E. Hoffman, train dispatcher.

Kokomo Marion & Western Traction Company—H. P. Martsoff, superintendent of transportation.

Marion Bluffton & Eastern Traction Company—C. W. Clark, superintendent.

Terre Haute Indianapolis & Eastern Traction Company—C. C. Reynolds, general manager; G. K. Jeffries, superintendent eastern division; C. L. Demeree, chief dispatcher eastern division; R. W. Reynolds, superintendent northwestern division; C. E. Morgan, superintendent Brazil, Danville and Martinsville division; M. B. Goodykoontz, chief dispatcher Brazil, Danville and Martinsville division; F. B. Byrd, chief dispatcher Brazil division.

Toledo & Chicago Interurban Railway—A. J. Purinton, manager; G. M. Patterson, general freight and passenger agent.

Winona Interurban Railway—H. S. Dickey, general superintendent; C. O. Sullivan, assistant superintendent.

Indianapolis Columbus & Southern Traction Company and Indianapolis & Louisville Traction Company—A. A. Anderson, general manager. Indianapolis & Louisville Traction Company

—R. J. Thompson, assistant secretary and treasurer, D. C. Ward, trainmaster; Ed Ray, dispatcher. Indianapolis Columbus & Southern Traction Company—W. A. Carson, assistant general manager; L. Brown and C. Wells, dispatchers.

Louisville & Northern Railway & Lighting Company and Louisville & Southern Indiana Traction Company—F. E. Cole, general superintendent.

Lake Shore Electric Railway—L. K. Burge, superintendent. Muncie & Portland Traction Company—C. M. Witt, chief dispatcher.

#### Address of Chairman Hunt.

In further explanation of the purpose of the meeting Chairman Hunt made a brief statement, an abstract of which follows:

From reports made by our inspectors, resulting from inspections made and information gathered in other ways, there seems to be quite a variety of methods and systems in practice on the various electric lines in this state in regard to rules governing the movement of trains and for the control of employes in various departments; in other words, there appears to be a deplorable lack of uniformity. With the hope that these conditions might be improved the commission issued the circular calling this meeting.

It is not necessary to make a detailed statement of the various methods in vogue because the gentlemen here assembled are probably more conversant with these conditions than either the commission or its inspectors. On some roads the rules and practices are so lax as to make opportunities for errors that might result disastrously.

While traction lines are in their infancy, yet, with the experience that the officials have had in railroad operation, they should be able to formulate a much better system; the commission cannot formulate the system for you. It will not attempt to do so, but suggests that you call to this work your best talent and best thought and give to it such careful attention as will ultimately bring about the desired results. Conventions have been called in other states and rules have been formulated and compiled. We have before us a copy of the rules adopted by the Central Electric Railway Association at Columbus, O., on September 6, 1907, which has been furnished by a line in this state which is now operating under these rules; and, as far as we have been able to determine, they are the most satisfactory now in use. They are, however, far from complete, and our inspectors call attention to many places where they think the rules can be improved.

Rule No. 152 says: "Train orders must be addressed to those who are to execute them, naming the place and," etc. We call attention to the fact that this rule specifically says that they must name the place, while the forms adopted for the train orders give everything in numbers, leaving room for doubt and opportunities for mistakes.

Rule No. 144 provides "that all trains must approach meeting points"; and it occurs to us that it would be better should this rule read "passing points." A more complete examination of these rules will probably develop many other improvements that might be made.

In addition to the defects mentioned this code of rules includes nothing in regard to the maintenance of way department, which should be fully protected.

The work of formulating rules will, much of it, necessarily have to be performed by committees to be appointed in a manner to be determined by you.

In the discussion of all these matters, such as rules, car orders, qualification of motormen and conductors, and all other matters that may come up for consideration, I hope all the members of this conference will feel perfectly free to express themselves, for it is only by full expressions, both from the railroad officials and the commission, that a proper and satisfactory understanding can be arrived at.

William J. Wood, member of the commission, spoke of the feeling that a great many of the accidents which take place might easily have been prevented and said he believed that the meeting could take such action in the adoption of uniform rules as would anticipate remedial legislation that might go too far. He thought that no similar meeting had ever been held between representatives of electric railways and a state railroad commission, and he believed its work could be made of great benefit to the roads and to the state. Mr. Wood added that he drafted in 1889 the first charter for an interurban road in the state, the Evansville Suburban & Newburg Railway, and that he was its first manager. He added that this road, which was represented at the meeting by Gus Mulhausen, the general manager, had never killed or injured a passenger. Of the two who had been killed, not passengers,

one was a trespasser on the property of the company. This company operates partly by electricity and in part by steam.

#### Work of the Inspectors.

Chairman Hunt then called upon Mr. Shane, the chief inspector of the commission, to address the meeting. Mr. Shane was formerly superintendent of roadway and track of the Toledo St. Louis & Western Railroad and has been connected with steam railways since 1867. He has as his assistants D. E. Matthews and C. A. Prehle, who were formerly in the transportation department of the Pennsylvania Railroad. Mr. Shane investigates matters relating to the physical property and to operation. Mr. Matthews investigates all accidents and assists in inquiries into methods of operation. Mr. Prehle inspects the equipment. The assistance of Prof. E. O. Gorman of Purdue University and of various engineers is sometimes secured by the commission.

In addressing the meeting Mr. Shane said that the majority of railroad men were developed at the expense of the railroads, and that as the companies had paid for the experience which fitted their men to fill positions of responsibility, the railroads should profit by it. He said that some roads had no rules and others showed great improvement in their methods of operation. He emphasized the fact that railways could not be held responsible for accidents which took place because people trespassed on railway property. His experience had demonstrated that 90 per cent of the accidents were due to carelessness and lack of efficiency, rather than to any deficiency in equipment. Considering the traffic and age of the electric roads they were in very good condition, but a great many details needed attention and were receiving it from the more progressive companies. Mr. Shane declared that the official who placed in effect rules for the government of employees and did not see that they were carried out set an example that destroyed discipline and demoralized the organization. He recognized that it was very difficult to establish discipline, because the greatest penalty a railway could inflict is discharge or suspension of employees. He said that a law should be passed providing a penalty for employees of electric railways who neglect to observe rules, and that the companies should be able to call upon the state to assist in the enforcement of rules.

#### Roads Must Take Initiative.

W. T. Durbin, former governor of Indiana and director of the Chicago South Bend & Northern Indiana Railway, said that the people are taking more notice of accidents than ever before and that if the railways do not take the initiative the general assembly of the state will act. He declared that passengers have a right to feel that the companies have a system of discipline that in large measure will prevent accidents.

Mr. Shane was asked to enumerate some of the defects he had noticed. He spoke of the omission of warning signs at crossings and said that many switches had no lights. He mentioned also the lack of signals and the existence of improperly located and displayed signals, but said that there was no place where he could take exceptions to the condition of the track. He suggested that rules for trainmen and maintenance of way employees be divided into two books.

The following committee was then appointed to frame, during the noon recess, a definite programme: C. D. Emmons, Ft. Wayne & Wabash Valley Traction Company, chairman; H. A. Nicholl, Indiana Union Traction Company; Fletcher M. Durbin, Evansville & Southern Indiana Traction Company; Charles G. Lohman, Chicago South Bend & Northern Indiana Railway; S. A. Wood, Angola Railway & Power Company. Mr. Shane and Mr. Matthews, representing the commission, were to meet with the committee.

#### Report of the Committee.

At the afternoon session the committee made the following report:

It is the sense of your committee that the good work of

the railroad commission and its inspectors be endorsed by this conference, and in furtherance of the objects and in order to aid them further in their work for the betterment of the operation and maintenance of the interurban roads of this state, we recommend the appointment of two committees consisting of five members each, to be appointed by the chairman of the railroad commission from among the representatives of the various traction companies, Mr. Shane and Mr. Matthews to serve on both committees in addition to the five members named by the chairman; one committee to investigate and report on operating train rules, using as a basis for such rules the standard code of rules adopted by the Central Electric Railway Association at Columbus, O., on September 19, 1907, and the other committee on maintenance of way, including roadway and overhead construction, these reports to be made at a future conference to be called by the chairman of the commission.

In accordance with the report of the committee Chairman Hunt appointed two committees to continue the work, as follows, Mr. Shane and Mr. Matthews acting as the representatives of the commission on both committees:

Committee on "Maintenance of Way Rules"—A. A. Anderson, Indianapolis & Louisville Traction Company; T. B. McMath, Terre Haute Indianapolis & Eastern Traction Company; J. J. Brennan, Ft. Wayne & Wabash Valley Traction Company; J. W. Moore, Indianapolis & Cincinnati Traction Company; W. C. Sparks, Indiana Union Traction Company.

Committee on "Rules for Trainmen"—C. D. Emmons, Ft. Wayne & Wabash Valley Traction Company; H. A. Nicholl, Indiana Union Traction Company; Charles G. Lohman, Chicago South Bend & Northern Indiana Railway; C. C. Reynolds, Terre Haute Indianapolis & Eastern Traction Company; F. M. Durbin, Evansville & Southern Indiana Traction Company.

The chairmen of the committees will call meetings as soon as possible. After rules are framed copies will be mailed to all the companies interested in order that the rules may be considered carefully before the next conference is called. Before adjournment Mr. Hunt thanked the officials of the electric railways for their presence and interest in the conference.

#### CAR WIRING CABLES IN STOCK.

To facilitate the quick repairing of the wiring under the cars of the Oakland Traction Company, George St. Pierre, master mechanic, keeps on hand a stock of cables with wires

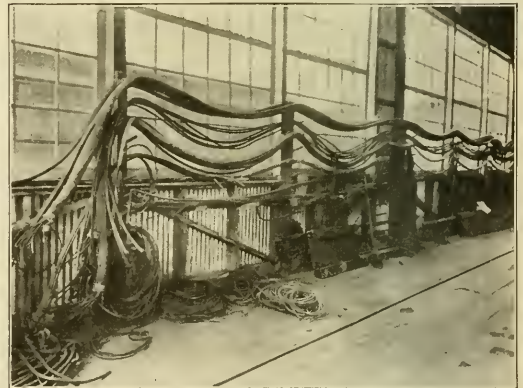

Oakland Traction Company—Method of Storing Supply of Car Wiring Cables Ready for Immediate Use.

drawn in, as shown in the accompanying illustration. During odd times these cables are made up with the proper number of wires so arranged that in the event of a burnout on an operating car its main wiring may be quickly torn out and at once replaced by a complete group of wires inclosed in a waterproof hose.

A bill has been introduced in the New Jersey legislature to require that the third-rail on electric roads be protected throughout its entire length.

**MOVEMENT TO INCREASE FARES IN MASSACHUSETTS.**

The Electric Railway Review has received letters from officials of various electric railways in Massachusetts which include detailed information concerning the movement to increase urban and interurban fares in that state. The communications follow:

**Worcester Consolidated Street Railway.**

E. G. Connette, general manager Worcester Consolidated Street Railway, Worcester, Mass., writes as follows: "Our rate is five cents within the city limits with universal transfer and on our suburban lines we have 5-cent zone limits, which are determined by the number of towns through which the lines operate. I consider the method of establishing fare zones on suburban lines unequal and inconsistent. In some instances the zone covers a mile in distance, while in others it covers six miles, depending to a large extent upon the town lines; and in a number of cases the revenue per car-mile scarcely pays operating expenses. The only uniform method for fares on suburban lines is to establish the fares on a mileage basis. The prices of material and labor used in the operation and maintenance of electric lines have been constantly increasing with a constant public clamor for reduction of fares and extension of fare limits. The tributary population on a large number of the suburban lines is insufficient to sustain the operation and the maintenance with present conditions without regard to a fair return for the capital invested in the property, and an advance in the rate of fares or the shortening up of the fare limits will become absolutely necessary to perpetuate the existence of these lines. We have some poor suburban territory, but have no definite plan for changing the rates at the present time."

**Blue Hill Street Railway.**

Stone & Webster of Boston write as follows concerning the increase in fare made by the Blue Hill Street Railway, Canton, Mass., of which they are general managers: "The rate of fare was advanced from five to six cents on January 5 of the current year. It is too early to be sure what the final result of this increase will be, but, so far, it has increased the gross earnings over the corresponding period last year by 8 or 10 per cent, while we would normally expect some decrease on account of local conditions. We believe there are other small roads in Massachusetts which are contemplating a similar increase of fares, and have no doubt but that it will be tried in many instances."

**Milford & Uxbridge Street Railway.**

W. L. Adams, superintendent Milford & Uxbridge Street Railway, Milford, Mass.: "Our rates are from one to two cents a mile. While we do not think that the rates are as much as they should be in some places, we do not contemplate changing them at present."

**Boston Elevated Railway.**

C. S. Sergeant, vice-president Boston Elevated Railway: "Our rate is limited by our charter to five cents, so that there is no question with us of increase or diminution of rate."

**Boston & Northern Street Railway.**

P. F. Sullivan, Boston & Northern Street Railway, Boston: "Our fares are usually five cents, with transfer privilege in each city and each town. The interurban rates are about 1 cent to 1¼ cents per mile." Mr. Sullivan spoke on "Street Railway Conditions with Reference to Rates of Fare in Massachusetts" at the dinner of the Massachusetts Street Railway Association at Boston on February 12, and said in part: "In the matter of changing rates of fare to meet changed conditions it seems to me that in the case of the smaller companies, they must either increase the unit of fare or surrender their charters and remove their tracks, for the longer they continue business the greater will be their indebtedness and the less valuable will be the material to be sold. If they increase the unit of fare the amount must be determined in each case. In the case of the larger and older companies, if they maintain the present unit of fare in the larger cities they will be compelled to reduce transfer privileges and increase the unit of fare on the rural lines, not to a rate based upon distance, but to a rate based upon conditions in the particular locality. It is neither justice nor good business that companies honestly capitalized and honestly managed should not have a fair return on the capital invested under the Massachusetts laws and subject to their control and regulations. If they cannot improve present conditions, if they cannot get a better return than they do at present, then they cannot obtain

capital for future improvements, or the companies will be forced to remove the tracks from non-paying lines."

**Concord Maynard & Hudson Street Railway**

John W. Ogden, superintendent Concord Maynard & Hudson Street Railway, Maynard, Mass.: "There is no doubt that suburban roads, in the east at any rate, must raise their fares or give up business. There is no reason why the investors in these enterprises should not receive an adequate return on their investments, as in any other business. The people, in my mind, are becoming of the same opinion, but they need more education on the subject, and I think more newspaper work ought to be done in educating them. The continual increases in prices of all materials that enter into the construction and operation of railways, together with the continued legislation against street railways, make it absolutely impossible for the investors to get a fair return for their investment at present rates of fare. The people are continually demanding additional privileges and favors from the companies. Educate the people to stop trying to make laws to burden the roads to such an extent that they will be obliged finally to pull up their tracks. Our rate of fare is five cents. We regard it as inadequate; the haul is too long. Rates should be at least 1.5 to 1.75 cents per mile on the average. We have not yet changed our fares, but we shall do so about March 1; the details are not yet settled."

**CENTRAL ELECTRIC RAILWAY ASSOCIATION STANDING COMMITTEES.**

President F. D. Carpenter of the Central Electric Railway Association has just announced the following standing committees for the year 1908:

**Subjects.**

- H. A. Nicholl, chairman, general manager Indiana Union Traction Company, Anderson, Ind.
- E. C. Spring, general superintendent Dayton Covington & Piqua Traction Company, West Milton, O.
- F. W. Coen, vice-president Lake Shore Electric Railway, Norwalk, O.
- J. C. Rothery, general manager East Liverpool Traction & Light Company, East Liverpool, O.
- A. A. Anderson, general manager Indianapolis Columbus & Southern Traction Company, Columbus, Ind.

**Insurance.**

- H. N. Staats, chairman, vice-president American Railway Insurance Company, Cleveland, O.
- H. J. Davies, secretary Cleveland Electric Railway, Cleveland, O.
- H. P. Clegg, president Dayton & Troy Electric Railway, Dayton, O.

**Finance.**

- C. N. Wilcoxon, chairman, general manager Cleveland Southwestern & Columbus Railway, Cleveland, O.
- George Whysall, general manager Columbus Delaware & Marion Railway, Marion, O.
- W. G. Irwin, vice-president Indianapolis Columbus & Southern Traction Company, Columbus, Ind.
- F. D. Norviel, general passenger and freight agent Indiana Union Traction Company, Anderson, Ind.
- H. E. Vordermark, auditor Ft. Wayne & Wabash Valley Traction Company, Ft. Wayne, Ind.

**Standardization.**

- R. C. Taylor, chairman, superintendent motive power Indiana Union Traction Company, Anderson, Ind.
- W. S. Townsend, master mechanic East Liverpool Traction & Light Company, East Liverpool, O.
- F. Heckler, superintendent motive power and cars Lake Shore Electric Railway, Fremont, O.
- M. Baxter, master mechanic Western Ohio Railway, Lima, O.
- W. A. Gibbs, division manager Ohio Electric Railway, Newark, O.
- L. Clark, master mechanic Indianapolis Traction & Terminal Company, Indianapolis, Ind.

**Publicity.**

- George Davis, chairman, associate editor Electric Traction Weekly, Cleveland, O.
- R. Hitt, associate editor Street Railway Journal, Chicago, Ill.
- E. B. Grimes, Ohmer Fare Register Company, Dayton, O.
- L. E. Gould, editor Electric Railway Review, Chicago, Ill.

**Transportation.**

F. J. J. Sloat, chairman, division manager Ohio Electric Railway, Dayton, O.  
 F. T. Hepburn, district manager Lima & Toledo Traction Company, Lima, O.  
 Irwin Fullerton, auditor Detroit United Railway, Detroit, Mich.  
 Charles G. Lohman, superintendent Chicago South Bend & Northern Indiana Railway, South Bend, Ind.  
 J. W. Brown, superintendent transportation West Penn Railways, Connellsville, Pa.

**Vigilance.**

A. A. Anderson, chairman, general manager Indianapolis Columbus & Southern Traction Company, Columbus, Ind.  
 C. D. Emmons, general manager Ft. Wayne & Wabash Valley Traction Company, Ft. Wayne, Ind.  
 T. J. Ferneding, vice-president Dayton & Xenia Transit Company, Dayton, O.  
 F. A. Davis, president and general manager Scioto Valley Traction Company, Columbus, O.  
 G. W. Parker, general express agent Detroit United Railway, Detroit, Mich.  
 F. J. Green, vice-president and general manager Springfield Troy & Piqua Railway, Springfield, O.

**Supply.**

J. F. Ohmer, chairman, Ohmer Fare Register Company, Dayton, O.  
 S. D. Hutchins, Westinghouse Traction Brake Company, Columbus, O.  
 L. J. Drake, Jr., Galena-Signal Oil Company, Indianapolis, Ind.  
 W. H. Bloss, Ohio Brass Company, Indianapolis, Ind.  
 F. H. Strieby, General Electric Company, Cincinnati, O.

**PRACTICAL REPAIR SHOP KINKS.**

BY H. P. CLARKE, NEW YORK CITY RAILWAY.

Modern methods and up-to-date appliances yield handsome returns in the electrical shop of today. Considerable thought has been expended along these lines in the electrical

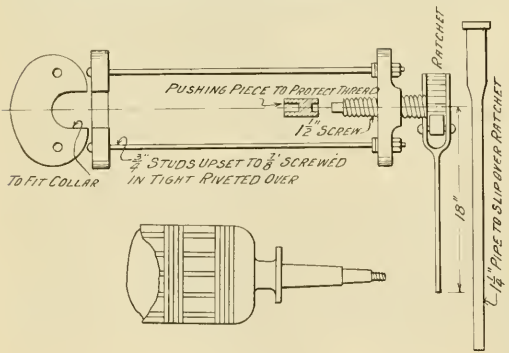

Figure 1.

shops of the New York City Railway Company. In designing shop tools and appliances two important factors must be kept in view. They must be handy and light. Anything cumbersome will soon be cast aside and primitive methods resorted to.

The removal of thrust collars from armature shafts, loosening and tightening commutators, removing and tightening the clamping ring from G.E.-1,000 armatures, etc., are all simple operations in themselves, yet difficult and costly without suitable appliances.

The device illustrated herewith for removing collars from G.E.-1,000 armatures is very simple. A horseshoe flange with two studs and a ratchet at the business end will do the work in a "jiffy." The removal of collars from Westinghouse armatures is not so simple, especially if the coils are in the armature, the space between the collar and coils being so

small that considerable difficulty will be experienced in designing a rig that will exert a force of 15 tons and not injure the coils. This has been accomplished with a rig as shown in Figure 2. For this purpose a pattern was carefully worked out and cast in steel, forming a split ring to clamp over the collar with two 3/4-inch bolts, using a ratchet for working the screw. With this rig collars can be taken off without trouble. It will do the work on either end of the armature by simply using a longer pushing piece.

For commutator work, back heads on G.E.-1,000 armatures, etc., ratchets are used also; the armature in all cases is rotated and the nut held fast. For G.E.-1,000 armatures a wrench is used as shown in Figure 4. This device readily adjusts itself to any variation in the pin holes and a light wooden post with a slot through the upper end takes the strain exerted by the ratchet applied to the taper end of the

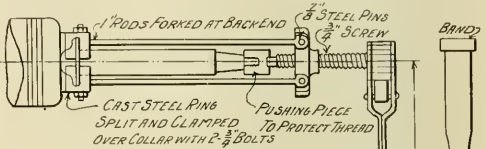

Figure 2.

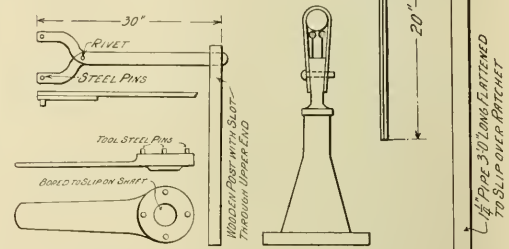

Figure 3.

Figure 4.

Figure 5.

armature shaft. This ratchet is made from an old pinion with the tops of the teeth turned off, and reduced to about half length, the small end of the pinion being used. The teeth are about two inches long.

For commutator work similar devices are employed, except that they are much heavier. A wrench for handling screw rings is shown in Figure 3. With this rig commutators can be loosened or tightened without trouble and loose commutators become a thing of the past. For commutator work the stand is secured to the floor, a stirrup is dropped over the shaft and the pin slipped in as shown. By this means all danger of throwing the armature out of the stand is avoided.

Secretary Travis H. Whitney of the New York public service commission of the first district has given out the report of accidents upon railroads within its jurisdiction during the month of January, 1908. The total number of accidents was 3,921, and the total number of persons killed 44, against 3,993 accidents and 51 killed in December. Detailed figures for January follow:

Car collisions .....	170
Persons and vehicles struck by cars.....	934
Boarding .....	479
Alighting .....	416
Contact with electricity.....	34
Other accidents .....	1,888

Total .....	3,921
The accidents are classified as follows:	
Passengers .....	1,444
Persons not passengers .....	570
Employs .....	486



PAY-AS-YOU-ENTER CARS FOR MEXICO.

The Toronto Railway Company is building in its shops at Toronto 20 pay-as-you-enter cars for the Monterey Railway Light & Power Company of Monterey, Nuevo Leon, Mexico.

The cars are of special interest in that they are of the double-center entrance type, that is, having central side entrances on both sides of car, which feature in connection with the length of car required special construction of the underframing throughout.

In appearance the completed car resembles two cars con-

referred to consists of the two outer side sills. These sills are formed of heavy channel beams running the entire length of the car and are offset vertically at the entrances to receive the platform flooring and provide for easy access for the passengers. The sills are reinforced between corner posts of each car by heavy oak fillers, to which are secured the end and cross sills, side posts, flooring, etc.

The end sills—four in number—are of heavy oak. To the outer end sills is attached a channel beam of the same height as the side sill beams. This channel, having its ends flanged and bent at right angles, is securely bolted to the

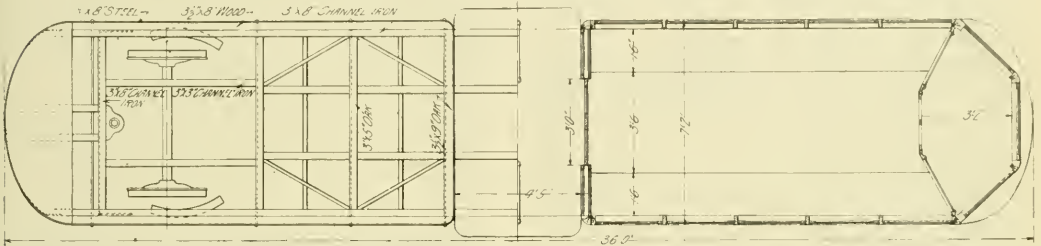

Pay-As-You-Enter Cars for Monterey, Mex.—Floor Plan and Framing.

nected together under a single roof, each car being of the closed type and separated one from the other by the centrally located platform or vestibule.

This design of "Jim Crow" car is common in Mexico, where it is the custom for the "peons" and second-class

side channels and serves the additional and unique purpose of receiving the king bolt of the maximum traction trucks. The inner end sills are reinforced by heavy corner angle plates secured to the side channels. The center longitudinal sills are also formed of channels, but of small dimensions, and



Pay-As-You-Enter Cars for Monterey, Mex.—Exterior View, Showing Center Side Entrance.

passengers to occupy only the rear car or compartment. The first-class passengers ride separately in the forward compartment, which is also occupied by the motorman, the car being "single-ended."

The car is 36 feet in length, 7 feet 1 inch in width over side sheathing and 12 feet 6 inches in height. It will be noted that the car is unusually narrow, which is accounted for by the narrow streets of the Mexican city, the track gauge being standard.

Upon reference to the accompanying drawing it will be seen that the principal feature of the special underframing

laid horizontally with flanges up to receive the floor fillers. Cross sills are of wood and are trussed with rods inserted in grooves in the sill and extend through the side sills, being bolted on the outside.

The circular bulkheads are protected with 1/2 by 6 inch steel bands. These bands extend back along the side of the car a considerable distance, being securely fastened to the outside of the side channel and forming a base for the side sheathing.

The ends of the car are also circular in shape and present a very neat and attractive appearance, especially in the car

interior, the deck being of the monitor type. This feature also provides a greater capacity for the car. The seats of both compartments are of rattan and run longitudinally, the seats in the rear compartment being continuous around the circular end.

The motorman is neatly partitioned off in the forward compartment, the partition being of substantial oak framing, in which are inserted drop sashes to provide for ventilation and light. The partition is also provided with a centrally located door having a glass panel.

The forward compartment is finished in antique oak rubbed down to an egg shell gloss. The rear compartment is finished in white ash. The general finish of the car exterior is of cherry in the vertical side sheathing.

As the climate of Mexico is extremely warm the car is designed after the semi-convertible plan; the upper or transom sashes raise into the roof, while the lower sashes drop into side pockets, the opening of which is covered with neatly finished arm rests.

An interesting feature of the car is the vestibule, located between the compartments and used in connection with the pay-as-you-enter system of fare collection. The collection box, which is about a foot square and similar to the "chop boxes" in use at the New York elevated and subway stations, is located in the center of the platform and is permanently attached thereto. As entrance to the car is made on either side or both an upright hand railing divides the platform laterally. A space of about 2½ feet is allowed between the end supports of the hand railings and the box on both sides for passengers and conductor. The purpose of the railings is to separate the passengers for their respective compartments. Each compartment is provided with wide sliding double doors. As the conductor's duties require him to remain at all times on the platform, the car is equipped with trolley retrievers. Cars are fitted with signal lights in front, designating routes by the color system.

The cars are for city use entirely and were designed by M. Power, master car builder of the Toronto Railway Company.

#### CHANGES IN FARES IN MASSACHUSETTS.

(FROM THE SPRINGFIELD (MASS.) DAILY REPUBLICAN.)

The Springfield Street Railway Company is not the only one among the strongly located trolley concerns which is leaning toward heroic remedies. On both of the great aggregations of lines running north and south of Boston, the fare limits are being cut down, while the Blue Hill Street Railway, running from Boston to Canton and Stoughton, has increased its unit of fare from five to six cents. On the Newton system free transfer privileges were cut down some time ago. Very possibly the service on these and other lines is being contracted also; but the feature of retrenchment measures on the roads around Boston seems to be an increase of charges through reduction of fare limits and transfer privileges, while with the local street railway company it is a reduction of service, none too adequate before, on which the public has come to depend.

Either method of strengthening the financial position of the companies will arouse public protest, but it may be questioned whether the course of least resistance will not be found along the line of free transfer privileges, in which most of our street railway companies have acted very generously. It is further to be admitted that some of the single-fare stages are very long and might in extreme cases be reasonably reduced. Something is to be said on behalf of the American practice of charging one fare without much regard for distance. Its distributive effect upon a city's population in the matter of residence is great and healthful. But the English method of grading fares by broad distance zones is juster, since the cost of transportation varies roughly according to distance. From the general financial position of the electric railway companies in this state, it is apparent that a tendency is likely to develop toward the English plan of a closer grading of fares according to distance. But in doing this the companies will have to act considerably of those vested residence interests which have grown up on the basis of present charges, and they will also be asked to remember that five cents is not necessarily to be regarded as a minimum charge.

#### THE HUDSON RIVER TUNNEL SYSTEM.

The first of the Hudson & Manhattan Railroad Company's tunnels under the Hudson river will be opened to the public on February 25. The part of the route now to be opened consists of a twin tube tunnel extending from Hoboken, N. J., to Sixth avenue and Nineteenth street, New York, a distance of nearly three miles.

Passenger stations in Manhattan will be located as follows: Christopher and Greenwich streets, where connection will be made with the Ninth avenue elevated line; Christopher street and Sixth avenue, where connection will be made with the Sixth avenue elevated; and in Sixth avenue, at Fourteenth, Nineteenth, Twenty-third, Twenty-eighth and Thirty-third streets. At the Hoboken terminal direct connection is made with the Delaware Lackawanna & Western Railroad.

Eight-car trains, electrically propelled, will be run continuously through the tunnel and the time between Hoboken and Nineteenth street, New York, will be about 10 minutes.

The cars are made entirely of steel, absolutely fireproof and differ materially from any others now used in the metropolitan district. They have large sliding side doors in the



Hudson River Tunnel—First Signal Station.

middle, as well as at either end, and the platforms at the terminal stations are so arranged that passengers enter and leave the cars at the same time from opposite sides.

The doors of the cars are operated by compressed air and no signal bells are used. When the last door in the train is securely closed the motorman receives an electric flash signal and starts the train. The cars have only side seats and are equipped with steel rods set vertically at frequent intervals to aid passengers to steady themselves when the trains are crowded. These cars were fully described in the *Electric Railway Review* of June 15, 1907, page 782.

Throughout the system, which comprises 18 miles of under-river and underground railroad, the stations are designed with a view to comfort, permanency and beauty. They are made large enough to provide for growth of traffic in the future. All parts of the stations are constructed either of concrete or metal, so that there is no possibility of fire.

The tunnels will be well ventilated, as each train acts as a piston, forcing the air ahead of it and drawing in a fresh supply from the surface as it proceeds.

The tunnels in the Hoboken-Manhattan section, as in all parts of the system, are made of steel rings, coated with concrete, bolted together and set in place as the boring shield, working in compressed air, opened the way for them. The in-

terior diameter of the tubes is 15 feet 3 inches. The depth of the tunnels below the surface of the Hudson river varies from 60 to 90 feet. The depth of earth and rock between the roof of the tunnel and the water ranges from 15 to 40 feet. The two tubes are entirely separate and are about 30 feet apart for the greater part of the distance under the river.

A complete description of the New York tunnel system while under construction was published in the Electric Railway Review of November, 1906, page 893. The system of the Hudson & Manhattan Railroad may be described by dividing it into four sections, all of which are connected and also brought into direct connection with other principal transportation lines on both sides of the river. The first section is the part about to be opened and generally known as the north tunnels. The second section, or south tunnels, nearly completed, extends from Cortlandt and Fulton streets, New York, to Jersey City, where a large terminal station has been built in the solid rock directly beneath the present structure of the Pennsylvania Railroad station. The third section is a transverse tunnel running along the New Jersey shore of the Hudson, 1 1/4 miles, connecting the terminal in Jersey City with that in Hoboken. This section taps all of the trunk and local transportation lines on the Jersey shore between the two points and serves as an important feeder to the under-river tubes. The principal point in this line is at the Erie terminal. The fourth section is a branch line running from Jersey City to Newark. This extends underground through the populous district of Jersey City and then comes to the surface and continues over the tracks of the Pennsylvania road to Newark. Another spur of the underground system, now being constructed in Manhattan, runs from Sixth avenue, east under Ninth street, and will connect with the Interborough Rapid Transit Company's subway near Astor place.

Within a radius of 15 miles from the city hall in New York there are 1,800,000 persons who will be directly benefited by the under-river railroads. The regular single fare through the tunnels will be five cents.

**Terminal Structure.**

Perhaps the most interesting and important point in the tunnel system is the 22-story structure located at Church and Cortlandt streets, known as the Hudson Terminal buildings, which occupies the larger part of two city blocks. From the train platforms, two stories below the street level, one may proceed by underground and under-river routes to any part of Greater New York. The tunnels come in under the structure about 30 feet below the street level, forming a loop with platforms and approaches of sufficient dimensions to accommodate 1,000 persons a minute. The building has 52 elevators and is fireproof.

The men who have been prominent in carrying out the work are: Walter G. Oakman, president of the construction company, known as the Hudson Companies; William G. McAdoe, president of the Hudson & Manhattan Railroad Company; and Pliny Fisk and William M. Barnum of the banking house of Harvey Fisk & Sons. The engineering features were worked out by Charles M. Jacobs, chief engineer, and J. Vipond Davies, deputy chief engineer. During a part of the time since the work began as many as 6,500 men have been employed at one time. The cost of the system when fully completed will be about \$70,000,000. The entire system is expected to be in operation during the coming summer.

The value of a developed water power is stated by Charles T. Main, mill engineer and architect, of Boston, to be as follows: "If the power can be run cheaper than steam, the value is that of the power, plus the cost of plant, less depreciation. If it cannot be run as cheaply as steam, considering its cost, etc., the value of the power itself is nothing, but the value of the plant is such a sum as could be paid for it new, which would bring the total cost of running down to the cost of steam power, less depreciation. That is, it is worth just what can be gotten out of the plant and no more."

**CHANGES IN TICKET SYSTEM OF INDIANAPOLIS & CINCINNATI TRACTION COMPANY.**

The Indianapolis & Cincinnati Traction Company, Indianapolis, has made some changes in its ticket system for an account of which we are indebted to George S. Henry, the traffic manager.

On January 29 the conductors of this company began to issue fare receipts to all passengers, either for ticket or cash payments. A formal notice concerning the change, posted for the information of passengers, stated: "This company reserves the right to collect fare to destination from any passenger not holding a receipt properly punched. Examine receipts. Keep receipts unless called for by an authorized inspector or by the conductor. Claims for overcharge and the like will not be entertained unless claimant presents a proper receipt or memorandum of its number in case it has been surrendered to the company."

The fare receipt, as illustrated herewith, is in two parts. These parts, folded, are issued to conductors in book form. One punch suffices for the part which is given to the passenger



**Changes in Indianapolis & Cincinnati Tickets—Form of Ticket.**

46000			STATIONS			46000		
Cash	Ticket	From To	Cash	To From	Ticket	Cash	Ticket	From To
05	India	apolis	05	05	05	05	05	05
10	Keyt	Ave.	10	10	10	10	10	10
15	North	1	15	15	15	15	15	15
20	Stops	45, 61	20	20	20	20	20	20
25	Five	Points	25	25	25	25	25	25
30	Stops	9, 10	30	30	30	30	30	30
35	N. B.	Bellet	35	35	35	35	35	35
40	Stops	12, 13, 14, 15	40	40	40	40	40	40
45	Act	ion	45	45	45	45	45	45
50	Stops	16	50	50	50	50	50	50
55	Brook	field	55	55	55	55	55	55
60	Stops	17	60	60	60	60	60	60
65	Stops	18	65	65	65	65	65	65
70	Stops	19	70	70	70	70	70	70
75	Stops	20	75	75	75	75	75	75
80	Stops	21	80	80	80	80	80	80
85	Stops	22	85	85	85	85	85	85
90	Stops	23	90	90	90	90	90	90
95	Stops	24	95	95	95	95	95	95
1.00	Stops	25	1.00	1.00	1.00	1.00	1.00	1.00
1.05	Stops	26	1.05	1.05	1.05	1.05	1.05	1.05
1.10	Stops	27	1.10	1.10	1.10	1.10	1.10	1.10
PASS	Stops	28	PASS	PASS	PASS	PASS	PASS	PASS
Pres	Stops	29	Pres	Pres	Pres	Pres	Pres	Pres
Transp	Stops	30	Transp	Transp	Transp	Transp	Transp	Transp
Mult	Stops	31	Mult	Mult	Mult	Mult	Mult	Mult
Prop	Stops	32	Prop	Prop	Prop	Prop	Prop	Prop

**Changes in Indianapolis & Cincinnati Tickets—Fare Receipt.**

and the part retained by the conductor for his report. Additional notice to passengers regarding the receipts is in the cars in the form of a poster stating that "the conductor is required to give each passenger one receipt. Examine and keep receipts unless called for by the conductor or an inspector."

The use of this form of fare receipt follows the introduction of tickets by Mr. Henry in July last, which are sold at a discount. These tickets are issued in denominations of five cents and multiples. More than one ticket may be used to make up a total required for transportation, but if a ticket representing a large amount is tendered for a ride, no change will be given. For instance, three 10-cent tickets will be

accepted for a fare of 30 cents, but if a 30-cent ticket is tendered for a 10-cent ride the balance will not be refunded by the company. Prior to the introduction of this form of ticket the cash fares collected by conductors on one division amounted to 44 per cent of the total fares, and on the other division the percentage was 38. A steady decline in these figures took place from July to December. By the latter month but 26 per cent of all the fares represented cash payments to conductors. With the new system of fare receipts the percentage is becoming still lower.

In discussing the advantages of these changes Mr. Henry said: "They make it possible to secure an absolute check on the traffic."

**PROGRAMME FOR ANNUAL MEETING OF IOWA ASSOCIATION.**

Announcement is made by L. D. Mathes, secretary and treasurer Iowa Street and Interurban Railway Association, that the 1908 convention will be held at the Savery hotel, Des Moines, Ia., on April 23 and 24. The following papers will be read:

- "Re-enforced Concrete in Electric Railway Construction," by N. M. Starke of Des Moines, Ia.
- "Depreciation," by L. D. Mathes, manager Union Electric Company, Dubuque, Ia.
- "Claims—Methods of Handling Same by Electric Railways," by Arthur W. Gross, general claim agent Omaha & Council Bluffs Street Railway, Omaha, Neb.
- "Handling Fares on Interurban Railways," by P. P. Crafts, general manager Iowa & Illinois Railway Company, Clinton, Ia., and Pittsburg Railways Company, Pittsburg, Kan.

There will be a general discussion on the subject, "Advertising by Electric Railways." This subject has not been especially assigned to any individual but a number of members will be prepared to discuss it.

Mr. Mathes states that ample space will be provided for manufacturers who desire to make exhibits, and that for the use of this space there will be no charge. The association, in conjunction with the Iowa Electrical Association, has rented the ballroom of the hotel, which will provide ample accommodations for exhibitors. Allotment of exhibition space may be secured by application to W. G. Owen, general superintendent Des Moines City Railway, Des Moines, Ia.

The entertainment feature will be taken care of by the officials of the Des Moines City Railway, the Inter-Urban Railway and the Des Moines Edison Light Company.

**Trussed Roofs.**

Bulletin No. 16 of the engineering experiment station of the University of Illinois has just appeared. It briefly presents the results of several years' study of trussed roofs by N. Clifford Ricker, professor of architecture. About 50 trusses of a selected type and of different proportions and arrangement were designed in long-leaf pine and steel and changed until the assumed and actual weights of the trusses agreed. Other trusses were likewise designed in white pine and steel and a few constructed entirely of steel. To perform this work as conveniently and as rapidly and accurately as possible it became necessary to devise simplified formulas and tables, with a systematic method of treatment, all of which are fully explained in the pamphlet. The results illustrated are mostly shown in graphic tables for ready appreciation. The most important features are a new formula for the weights of trusses; per cent of weight to be added for connections; most economical ratio of depth to span of truss; distance between trusses; number of purlins per panel; and dimensions of panels. It was found that white pine and steel trusses are about 10 per cent lighter than those of long-leaf pine and steel; also that, if carefully designed, steel trusses from 100 to 200

feet span have about the same weight as those of white pine and steel. It is believed that this bulletin will be valuable and suggestive to all persons interested in the design and construction of trussed roofs. Copies may be obtained gratis upon application to the director, engineering experiment station, Urbana, Ill.

**ALLOWABLE LENGTH OF FLAT SPOTS ON CAR AND LOCOMOTIVE WHEELS.\***

BY E. L. HANCOCK, PURDUE UNIVERSITY.

In the absence of experimental data as to the impact to which rails are subjected because of flat spots on car and locomotive wheels, the author has made a theoretical analysis. The development of a formula for the energy with which a flat wheel strikes the rail is as follows:

Let the diagram represent the wheel, of radius, r, having a flat of length, d. Represent the velocity of the train by v. At any instant it may be considered that the kinetic energy of

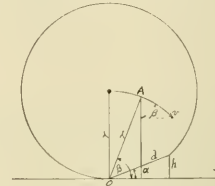

the wheel, with its weight, considered as rotating about the point, O, is the same as if the mass supported by the wheel be regarded as concentrated at its center, that is, its kinetic energy is  $\frac{1}{2} Mv^2$ , where M is the combined mass of the car and wheel and v is the velocity of train. When the flat spot is in contact with the track the center of the wheel is at the point A, distant below the original position approximately  $\frac{1}{4} h$ ,

which is equal to  $d^2 \div 4D$ , where d is the length of the flat spot and D is the diameter of the wheel. At the point A the mass has a downward velocity equal to  $v \cos \beta$ .

But  $\cos \beta$  equals  $d \div D$ , so that the kinetic energy with which M strikes the rail is  $\frac{1}{2} Mv^2 \cos^2 \beta = \frac{Mv^2 d^2}{2D^2}$ , where v is

the velocity of train in feet per second, d the length of flat spot in feet and D the diameter of the wheel in feet.

It is assumed that the permissible kinetic energy of the blow caused by the flat spot should not exceed the kinetic energy with which the top strikes a rail in the prescribed drop test. Hence the energy of the impact as deduced is equated to 380,000 foot-pounds, the energy of a 2,000-pound weight falling through 19 feet.

The weight upon a car wheel being assumed to be 10,000 pounds and the diameter of the wheel 33 inches, the formula becomes  $d = \frac{29.4}{v}$  ..... (A)

While the energy of impact will be slightly increased by reason of the action of gravity increasing the velocity of the mass during the fall through the distance of A below the center, approximately  $\frac{h}{4}$ , it is found that this is so small as not appreciably to affect the results.

A formula corresponding to (A) for a 72-inch driving wheel, assuming a load of 25,000 pounds on the driver, is  $d = \frac{40.6}{v}$  ..... (B)

The following table shows the values of d for various speeds:

Speed v, in m. p. h.— d in ft.	Length of Flat Spot Permissible, d.	
	33-inch wheel—Formula A. Factor of safety of 10, d in in.	72-inch wheel—Formula B. Factor of safety of 10, d in in.
10.....	2.90	4.87
20.....	1.42	2.03
30.....	0.96	1.35
40.....	0.73	1.01
50.....	0.59	0.81
60.....	0.49	0.67
70.....	0.42	0.58
80.....	0.36	0.50
90.....	0.32	0.45
100.....	0.29	0.41

\*Abstract of paper presented before the Indiana Engineering Society, January 17, 1908.

## RECENT ELECTRIC RAILWAY LEGAL DECISIONS.

BY J. L. ROSENBERGER, LL. B., OF THE CHICAGO BAR.

**No Liability for Injuries from Ordinary and Usual Movements of Cars.**

Howard v. Louisville Railway Company, 105 Southwestern Reporter, 932.—The court of appeals of Kentucky says that it is not able to agree with counsel that an instruction was open to objection which stated that if the plaintiff, after she boarded the car in safety, fell against a seat by reason of the ordinary and usual movements of the car in starting, they should find for the defendant. Ordinary and usual movements of the car in starting might have caused the plaintiff to lose her balance and fall, but, if so, the company would clearly not be liable. They are only negligent and responsible for injuries when the car starts in an unusual or violent manner, and not in the ordinary way.

**Ordinance Restricting Speed Applies to Territory Added to Municipality.**

Deneen v. Houghton County Street Railway Company, 113 Northwestern Reporter, 1126.—The supreme court of Michigan says that a village ordinance was passed when the defendant company was granted a franchise to build its road upon certain streets in the village of Hancock, which contained the provision: "Said cars shall after sunset be provided with proper signal lights, shall be properly heated in cold weather, and shall be run at a rate of speed not exceeding eight miles an hour within the limits of said village." The place where the plaintiff was injured was not within the village at the time the grant was made, and the defendant acquired its right to construct and operate its road at that point from other sources. It was contended that the ordinance did not become operative as to that locality by the subsequent extension of the village limits; in other words, it was the contention that the defendant might lawfully operate its road in compliance with its vested right, acquired from the outlying township, subject to the obligation of complying with such police regulation as should be made by the village after acquiring jurisdiction of this territory. But the court is of the opinion that this provision of the ordinance was intended for the protection of the citizens, and that it was in the nature of a police regulation, although it might also have aided in establishing contractual relations, and that actions for personal injuries due to its breach, and alleged as such (as in this case), might be brought by the injured person. Manifestly, then, the ordinance in question, restricting the defendant's right to run its cars faster than eight miles an hour, was admissible in evidence in this case. It is the general rule that a general ordinance applies to all territory within the corporate limits at the time of its passage, and becomes effective in additional territory when such is attached.

**Liability from Ownership of Car Regardless of Control of Railway.**

Chaffe and Another v. Consolidated Railway Company, 82 Northeastern Reporter, 497.—The supreme judicial court of Massachusetts says it was urged in this personal injury case that, notwithstanding an admission that at the time of the accident the plaintiffs "were passengers upon a car of the defendant," there was no evidence as to who was operating the car, or in control of the railway. But if the details were meager it was beyond conjecture that the defendant, described in the writ as a railway company, owned a car running over a line of street railway, operated by electricity, in which the plaintiffs in common with others were being transported. It received and undertook to carry the plaintiffs in this car over the line of track on which it ran, and the use to which the car was put, with the conditions of operation unexplained,

warranted the inference that the defendant at the time offered this means of transportation to those who wished to avail themselves of such facilities.

If the plaintiffs were passengers, in a car provided by the defendant, it had engaged to exercise such reasonable diligence for their safety during transportation as the nature of the business required.

Another car variously described as a work or flat car preceded the car in which the plaintiffs were riding, when, as it approached a portion of the track in which there was a rising grade, the forward car, being then a short distance in advance, slid on the rails and suddenly descending came into collision with the passenger car, causing the accident. It was said that there was a failure of evidence to connect the defendant with the management of the work car. But the plaintiffs having shown the collision, this fact until explained by the company was some evidence of negligence, as the jury could find that in the ordinary course of affairs it would not have happened if proper precautions had been taken. If negligence was found, then the defendant was responsible to the plaintiffs for the resulting injury to which it voluntarily had exposed them, even if the work car and the railway were under the control of another corporation.

**Liability for Injury in Alighting of Person Boarding Car "Not in Service."**

Ahern v. Minneapolis Street Railway Company, 113 Northwestern Reporter, 1019.—The supreme court of Minnesota says that the evidence in this case tended to show, among other things, that at about dusk the plaintiff was waiting for an easterly bound car, when one approached, slowed down as it neared the crossing, and when it was about 15 feet east thereof it came to a stop and the motorman opened the gates to take on passengers. The plaintiff got on the car, and, as her testimony tended to show, when she was in the door of the car the conductor called to her, "This car takes no passengers," and repeated it, from which she understood that he intended that she should get off, which she started to do, but when she was on the bottom step of the car, in the act of stepping to the ground, the car started forward, the gates began to close, and she was thrown to the ground.

The conductor and motorman each testified that on the trip they discovered that the air brake of the car was broken, and the sign "Not in Service" was turned up and was plainly visible at the time the car reached the crossing. The plaintiff testified that she did not see the sign, and there was no evidence that she did, except the fact that it was displayed. In this connection the defendant urged that it was error for the court to sustain the plaintiff's objection to the defendant's offer to show by the motorman that: "He did it [opened the gates] wholly involuntarily, simply as a matter of habit, without in any way intending to invite any one as a passenger upon his disabled car." But the ruling was correct, for the intention of the motorman and his supposed involuntary act, of which the plaintiff was not advised, could not affect her rights.

The supreme court also holds that the correct statement of the law applicable to this case was contained in instructions which told the jury what would constitute the plaintiff a passenger on the car, and to the effect that if, in what the motorman and conductor did and failed to do in stopping the car and opening the gates, she had reason to believe that the car at that time was intended to carry passengers, and, so believing, she in good faith boarded the car, she was, for the purposes of this case, a passenger on the car, and continued to be until she was given a reasonable time and opportunity to leave it in safety; and, further, if she saw the sign "Not in Service" on the car, still, in view of all the evidence, it was a question for the jury whether or not she had good reason to believe and did believe in good faith that the car carried passengers.

# News of the Week

## Progress of the Cleveland Negotiations.

Mayor Johnson of Cleveland and F. H. Goff, representing the Cleveland Electric Railway, on February 17 decided on a method of determining the valuation of the Cleveland Electric Railway's unexpired city franchises. It was decided to settle on an average length of life of the franchises and to compute the value for the entire city system on the basis of car-mile earnings. Harry Bunning, chief engineer of the Forest City Railway, has computed the average life of the franchises as 3.26 years, using the car-mile earnings in 1906 to determine the relative importance of the lines. Henry J. Davies, secretary of the Cleveland Electric Railway, estimates the average life at 4.4 years. It was also agreed that a division should be made between the city and suburban lines on the basis of the average length of haul.

It has been decided to issue a call for stockholders' meetings of both companies as soon as possible, in order that they may be ready to pass upon the results of the negotiations when concluded.

## Proposal to Divert Chicago's Traction Profit.

It has been suggested that the money received by the city of Chicago from the street railways be diverted for current needs of the city. The water department is in urgent need of funds and the aldermen who favor using the payments of the traction companies to meet the requirements of this department argue that the money could be advanced as a loan.

Walter L. Fisher, special traction counsel for the city, expressed himself as follows on the subject:

"I think it would be an inexcusable mistake to use this money for anything else than traction purposes. We need it for the subways. It was intended when the ordinances were passed that the share from their net receipts due the city should be used for street railway purposes. This plan should be rigidly adhered to, as to pursue any other course would simply mean a breach of faith with the people. If the money is used in building the subways the ultimate cost of the street railway properties to the city—provided the latter takes them over—would be so much the less, as the subways are bound to come."

## Indiana Union Traction Company Declines to Arbitrate Strike.

The Indiana Union Traction Company has declined to arbitrate its differences with the Amalgamated Association of Street and Electric Railway Employees, who declared a strike on January 1 because the company signed a contract with a rival organization, the Brotherhood of Interurban Trainmen. On February 14 a committee representing the strikers called on President A. W. Brady of the company and asked for a settlement of the strike by arbitration. They also submitted a petition to this effect, signed by 1,800 business men. Mr. Brady's reply, declining the proposition, was sent to each person who had signed the petition, with a statement that the company had signed a contract with the Brotherhood and consequently could make no new contract. Mr. Brady's letter reads in part as follows:

"No question of wages, hours, working conditions or unadjusted grievances was involved. Of the total number of motormen and conductors in the service of the company previous to January 1, 1908, only about one-third were dissatisfied with the course followed by the company, the other two-thirds having remained and still remaining at their work. In the interurban service but 10 per cent of the motormen and conductors left their work; that is, only about 20 out of a total of over 200.

"The company was compelled to employ new men to take the places of the men who voluntarily left their work on or about January 1, and all cars have been regularly operated for a number of weeks past. The company cannot in fairness to these new men adopt any course which would lead to their discharge in order to find places for the men who walked out, and who since have endeavored to harass and obstruct the company in many ways, including the illegal attempt to establish a boycott. At the same time, the company will, as openings arise, treat with any old employees seeking re-employment without discrimination because of their having participated in the mistake of the strike."

## Legislation Affecting Electric Railways.

**District of Columbia.**—A bill has been drafted by Corporation Counsel Thomas of Washington which gives the commissioners of the District of Columbia the powers of a public service commission with jurisdiction over railroads, traction

companies, electric light, heat and power companies and telephone companies. The commission is given power to regulate the rates, service and stock and bond issues, to have access to all books and records and to investigate accidents, order improvements in property or service, etc. Such companies are required to make annual reports to the commission and may be required to publish all rates and schedules. Provision is made that every public service corporation shall maintain such facilities as required by the commissioners, who may fix prices, rates and charges, in the absence of any specific law. Every public service corporation may be required to publish all service schedules, rates and tariffs. No public service corporation shall, according to the bill, increase its capital stock or issue bonds without first obtaining the approval of the commission, which shall keep informed as to the general conditions, capitalization and franchises of the corporations. In addition to the reports now required by law, annual reports shall be made by the corporations of such matters as may be required by the commission. The commission is empowered to issue or revoke permits or licenses, and to make or alter rules or regulations it may reasonably see fit.

**New York.**—An organization of the allied real estate interests of New York has had introduced in the legislature an amendment to the rapid transit law which permits the public service commission to ask for bids for the operation of subways, built by the city, the term of the lease to be limited to 35 years, with right of renewal for 25 years; or for the construction and operation of a subway under a 25-year franchise, the city to have the right to revoke the franchise at any time on payment of the cost of construction.

**Ohio.**—The Howe bill, providing for a state commission to value the property of public service corporations for taxation, which was recently defeated by the senate, has been reintroduced in a new form, which does not apply to electric railways or telephone companies. Mr. Howe has introduced another bill which gives city councils the right to fix, by franchise ordinance, the rates of street and interurban railways.—The Stockwell bill, which proposed to give city councils authority to regrant street railway franchises upon their expiration to new companies without the necessity of securing property owners' consents, was defeated in the house on February 13.

## Rapid Transit Affairs in New York.

Henry B. Seaman, chief engineer of the New York public service commission, has submitted a report on the Brooklyn bridge conditions in which he says that the new improvements at the Manhattan terminal, which were described in the Electric Railway Review of February 1, 1908, page 154, are a failure and recommends a restoration of the 6-car shuttle service, which he says would give a greater seating capacity than the through elevated cars. Mr. Seaman recommends that all cars used for the bridge service should have side doors, that the elevated trains should be increased to 8 or 10 cars, that the transfer station at Sands street should be enlarged, and that the Brooklyn Rapid Transit Company should increase its rolling stock by the addition of more commodious cars, provided with automatic signals to notify the motorman as soon as the doors are closed.

Bridge Commissioner Stevenson has severely criticized the report, saying that the new terminal arrangements have greatly relieved the congestion at the Brooklyn end of the bridge, although the congestion at the Manhattan end cannot be entirely removed until the Manhattan bridge is completed.

The commission has issued an order to the Union Railway of the Bronx to show cause why it should not completely overhaul its rolling stock and remedy a large number of defects reported by the commission's inspectors. A. W. McLimont, electrical engineer for the commission, has made a report, based on an inspection covering 46 days, that the company's rolling stock is in a most defective condition, which he ascribes to a lack of systematic and competent supervision.

Mr. McLimont summarizes the result of his inspection of the cars of the company as follows: Cars operated, 127; cars inspected, 112; cars with defective dashboards, 32; with broken headlights, 27; with insecure or broken steps, 43; with doors in need of repairs, 51; with curtains missing or in a dilapidated condition, 62; with windows in need of repair, 35; with controller faults, 37; with motor troubles, 29; with wiring troubles, 69; with defective trucks, 14; with bodies out of line, 23; with heat left on in barn, 36; with seats in bad condition, 25; with gear troubles, 67. The report also criticizes the overhead construction, which it says is badly in need of overhauling because maintenance has been so neglected and repairs so badly done that the service is impaired and there is danger from defective wiring.

At a hearing on February 13 the Interborough Rapid Transit Company was required to show cause why the temperature in the elevated cars should not be kept above 60

degrees. A report of one of the commission's inspectors showed that two-thirds of the cars inspected were at a temperature below 50 degrees.

On February 13 the commission held the first of a series of conferences with the chief executive and operating officials of all the various city railroads, with the idea of securing co-operation for increasing the adequacy of service without the necessity of formal orders and hearings. Although no definite conclusions were announced it was reported that the conference had been of great benefit in promoting an exchange of ideas. Mr. Wilcox, chairman of the commission, stated that his conception of adequate service included a seat for every passenger during non-rush hours. The railroad men agreed with this idea in general.

The commission has issued an order requiring the Interborough company to show cause why the subway cars should not be built with side doors. Bion J. Arnold of Chicago, who is preparing for the commission a report on subway conditions, has tentatively recommended side doors and has suggested a hearing on this question.

The board of estimate held a hearing on February 14 on the plans for the Broadway-Lexington avenue subway, but final consideration was postponed.

**American Association Bulletin.**—There has just been issued from the office of Secretary Swenson Bulletin No. 101 of the American Street and Interurban Railway Association. This is an especially important bulletin containing valuable information relative to platform expenses.

**American Institute of Electrical Engineers, Ithaca Section.**—Charles F. Scott, consulting engineer of the Westinghouse Electric & Manufacturing Company, was the guest of the Ithaca section on Friday, February 7, and gave a talk on the subject of "Limitations in High-Tension Transmission."

**Old Denver Franchise Held Valid.**—Judge Lewis of the United States district court at Denver on February 14 handed down a decision that a franchise granted in 1885 to the Denver Electric & Cable Railway, which was succeeded by the Denver City Tramway, and which made no provision as to its length of term, is still a valid contract, provided it has been lived up to by the company.

**Chicago Car Cases Dismissed.**—On motion of the city of Chicago the Illinois supreme court on February 13 entered an order dismissing the appeal of the city in cases against the Chicago City Railway and the receivers of the Chicago Union Traction Company involving alleged violations of the "public comfort" ordinances in regard to overcrowding and failure to keep the cars at the proper temperature.

**American Institute of Electrical Engineers, Chicago Section.**—At a meeting of the Chicago section of the American Institute of Electrical Engineers on Tuesday evening of this week Garrett T. Seeley, engineer of maintenance of the South Side Elevated Railroad, Chicago, presented an interesting paper, illustrated by lantern slides, on "The Extensions and Improvements of the South Side Elevated Railroad."

**American Institute of Electrical Engineers, Pittsfield Section.**—At the seventh meeting of the Pittsfield section of the American Institute of Electrical Engineers, held at the Hotel Wendell on February 6, 1908, H. J. Berg gave a talk on "The Phenomena Occurring on High-Voltage Power Transmission Lines." His remarks were accompanied with a number of diagrams and formulae, and actual figures obtained by tests made under operating conditions were given.

**Seeks Injunction Against Operation of Interurban Cars.**—The city attorney of Terre Haute, Ind., has filed a petition for an injunction against the Terre Haute Indianapolis & Eastern Traction Company to restrain it from operating its interurban cars through the city and from erecting poles and wires for commercial lighting. It is claimed that the company has not secured the consent of the city for the operation of interurban cars or for doing a commercial lighting business.

**Race Separation Law in Oklahoma.**—The new law requiring the separation of races on railways and street railways in Oklahoma went into effect on February 16. On the Oklahoma City Railway the cars are not provided with separate compartments and signs were posted to indicate the seats reserved for negroes. It is reported that much dissatisfaction was manifested by the white people when the cars were crowded and that many violated the law and the company's regulations by taking the seats reserved for negroes rather than remain standing.

**Municipal Ownership Proposed in San Francisco.**—A petition signed by 14,616 voters of San Francisco has been submitted to the board of supervisors asking it to submit to the

people at a special election the question whether the municipality should acquire the franchises and property of the United Railroads, the California Street Cable Railroad and two telephone companies, paying for the property by a bond issue. The charter requires a special election when requested by 15 per cent, or 8,715, of the voters. The validity of the signatures is yet to be tested.

**Work on Air Line Stopped.**—The Chicago-New York Electric Air Line Railroad, so widely advertised as the "10-dollar 10-hour" line from Chicago to New York, is reported to be in financial difficulties through failure to dispose of its stock, even at bargain rates. B. A. Mapledoram, chief engineer, has resigned, and the construction work in the vicinity of Laporte, Ind., has been practically abandoned. The road has been constructed 12 miles west of Laporte to Westville, 15 miles east of Gary, Ind., which President Miller now announces will be the western terminus of the line instead of Chicago.

**Western Society of Engineers.**—At an extra meeting of the Western Society of Engineers, held on February 19, Wilson E. Symons, manager Pioneer Truck Company, presented a paper entitled "The Passing of the Steam Locomotive." The author traced the development of both steam and electric traction and reached the conclusion that all methods of transportation, including steam and electric railways, canalized rivers and canals, will be required to serve the needs of the country, and would be extended and further improved in the future. He believed the electrification of steam railways in and near large centers of population was desirable as an important step toward the solution of the smoke question.

**Weathering of Coal.**—In a bulletin, No. 17, of the engineering experiment station of the University of Illinois, the subject of "The Weathering of Coal" is discussed by S. W. Parr and N. D. Hamilton. The bulletin relates to the weathering of coal and losses in fuel values which accompany storage under various conditions. The information heretofore available concerning the behavior of coal in storage is exceedingly meager. The results of tests, as outlined in this bulletin, add materially to the information available and open a way for a better understanding of matters pertaining to weathering, spontaneous combustion and other difficulties which attend the storage of coal in large masses. Deterioration has been studied with samples maintained in the open air, under cover at varying temperatures, in air-tight containers and in the submerged conditions.

**Recent Accidents.**—Eight persons were killed and 16 were injured last Saturday evening when a car of the Toledo & Western Railway was struck by a fast train of the Cleveland Cincinnati Chicago & St. Louis Railway, running over the tracks of the Michigan Central, at the crossing at West Toledo. At this point the Toledo & Western tracks cross the parallel tracks of the Michigan Central and of the Lake Shore & Michigan Southern railways, which are about 50 feet apart. There is no interlocking. The motorman of the electric car was killed and reports as to the exact circumstances differ. The conductor stated that his view of the train was partially obscured by a freight train on the Lake Shore tracks and that he did not see it coming until too late to stop the car. He said that the crossing bell did not ring. The car was struck in the center and was thrown for a considerable distance. The Ohio railroad commission has been making an investigation of the accident. At the coroner's investigation on Wednesday the testimony of the flagman at the crossing placed the blame on the dead motorman. He said that both he and the conductor had given signals with lanterns to stop the car, but that the motorman apparently paid no attention to them.—In a head-on collision between two cars of the Washington & Rockville Railroad on a steep grade near Rockville, Md., on February 13, several persons were injured. The accident is said to have been due to imperfect operation of the electric signal system. Both cars were badly wrecked.—A special passenger car on the Puget Sound Electric Railway collided with the rear of a freight train near Seattle, Wash., on February 13, seriously injuring four passengers and slightly injuring many others. The freight train had stopped, on account of a broken trolley wire, during a heavy fog and before a flagman could be sent back it was struck by the passenger car.—One man was killed and three injured in an accident to a construction car and trailer on the Omaha & Council Bluffs Street Railway at Omaha, Neb., on February 14. The accident occurred on a new piece of track down a steep incline. The rails were covered with snow and the cars got beyond the control of the motorman, running down hill to the end of the track, where the cars piled up. The motorman and three construction men were crushed in the wreckage.—Six passengers and a motorman were severely injured in a head-on collision between two cars of the Public Service Railway near Hackensack, N. J., on February 14.

# Traffic and Transportation

## James Dalrymple on Transfers.

The Cleveland Leader has been publishing a series of interviews with James Dalrymple, manager of the Glasgow corporation tramways. Concerning the transfer system Mr. Dalrymple is quoted as saying:

"With your system of transfers your average ride is more than twice as long as ours, and, therefore, I don't believe that you can reduce fares below five cents and expect to make a profit or even to pay expenses. I think the company must lose money on many of the long rides in Cleveland for a nickel fare. That is unfair to the company."

## For Prevention of Accidents in Boston.

In pursuance of its endeavor to prevent accidents the Boston Elevated Railway has suggested rules for the guidance of drivers of vehicles, and it asks the co-operation of the public in the observance of the rules, which are as follows:

"1. Never cross a highway without first making sure that there is no other vehicle near enough to cause a collision.

"2. Never turn suddenly to a track when a car is approaching from either direction.

"3. Always cross streets and turn corners at a moderate rate of speed.

"4. In turning into another street do not 'cut the corner,' but make a full turn, keeping as far as possible to the right.

"5. Be sure your horse is, or engine and brakes are, under perfect control, especially where the streets are crooked; where the view is obstructed; or when passing cars which passengers are entering or leaving.

"6. Remember that a street car is confined to the track and that the motorman cannot turn out or stop his car instantly when 'cut off.'

"7. Do not rely upon the motorman to save you from the consequences of your own carelessness. He may not be able to do so.

"8. Where practicable keep on the right of the road and as far from the track as safety requires.

"9. Never turn upon a track in front of a car without first signaling the motorman your intention in time for him to make it safe for you to do so without risk.

"10. Remember that constant vigilance is the price of safety."

## Rate Sheet of Twin City Lines.

The first rate sheet issued by the Twin City Rapid Transit Company in printed form has been received from A. W. Warnock, general passenger agent. It gives the rates for chartered cars and steamboat and special excursions on the interurban lines, effective on February 10.

No cars will be chartered to leave Minneapolis for Lake Minnetonka points, or vice versa, or to leave St. Paul for Stillwater, or vice versa, later than midnight. Among the rates quoted between Minneapolis and Lake Minnetonka are: "Excursion tickets for 50 or more persons, from ticket office to Excelsior, Tonka Bay or Deephaven and return, using regular service and good only on date stamped on face, 35 cents. For parties holding these tickets additional service to regular schedule will be provided on basis of 50 passengers to car. In case of failure to provide passengers, as per agreement, a charge of \$2.50 per car will be made for each car furnished but not used. Regular 25-ride commutation ticket, \$4.50. Students' 25-ride commutation ticket, sold only during school season, \$3.25."

Other provisions of the rate sheet are as follows:

"Unless otherwise stated, all car rates provide for the use of large standard cars with load limited to capacity.

"All rates provide for a layover at destination of not to exceed five hours, after which a charge of \$1.00 will be made for every hour or fraction thereof. Time to be consumed and total amount to be paid must be decided upon at time of charter.

"None of the following rates will apply to Sundays, holidays or any time when the service is taxed by large gatherings.

"All rates quoted are from any point on downtown 'loops.' A charge of \$2.50 will be made for a 1-way or a round trip on any one local line in connection with any other trip given below."

**Reduction in Fare to Chicago Suburb.**—The Chicago Consolidated Traction Company has accepted a 20-year franchise from the village of River Forest and, in accordance with its terms, will reduce the fare between that village and Chicago from 10 to 5 cents.

**No Seat No Fare Authority Denied.**—City Solicitor Northup of Toledo, O., has rendered an opinion that the city council has not the authority to compel the Toledo Railways & Light Company to furnish a seat to every person who is required to pay a fare.

**No Seat No Fare Ordinance.**—An ordinance has been introduced into the city council of Portland, Ore., to compel the Portland Railway Light & Power Company to furnish sufficient cars to give every passenger a seat or to carry free those who are forced to stand.

**Information Furnished to Kansas City Committee.**—The Metropolitan Street Railway Company of Kansas City, Mo., has furnished all the information requested by the committee of the city council which is investigating the schedules and physical property of the company.

**Plan for Department of Transportation in Chicago Abandoned.**—The committee on "Local Transportation" of the city council of Chicago has abandoned the plan of creating a department to act on transportation matters, and the office of traction expert, which is now held by M. B. Hereley, will be continued.

**Lower Fares Asked in Atlanta, Ga.**—A hearing was to have been held by the Georgia railroad commission on February 11 on a petition urging that the Georgia Railway & Electric Company of Atlanta, Ga., be compelled to sell eight tickets for 25 cents, but a postponement until February 27 was announced.

**Schedules in Savannah, Ga.**—The Savannah (Ga.) Electric Company has presented to the city council of Savannah the report of the investigations by J. F. Vaughn into the schedules of the various roads. G. J. Baldwin, president of the company, stated that the separation of the races in the cars had cost the company a loss of \$50,000.

**Existence of Interurban Express Company to be Terminated.**—Notice has been given that the existence of the Interurban Express Company, which conducts an express business between Louisville, Ky., and New Albany and Jeffersonville, Ind., on behalf of the Louisville & Southern Indiana Traction Company and the Louisville & Northern Railway & Lighting Company, will be terminated on March 5. After that date the freight business will be conducted directly by the companies under the jurisdiction of the interstate commerce commission.

**Rates Between Springfield and Decatur, Ill.**—B. R. Stephens, general traffic manager Illinois Traction System, Springfield, Ill., writes in regard to a report that very low rates would be made from Springfield to Decatur, Ill.: "I presume you have reference to the meetings of Evangelist Sunday at Decatur. We are not making any special rates to Decatur for these meetings with the exception of the usual Sunday rates, which are \$1.00 from Springfield, \$1.00 from Bloomington and \$1.25 from Champaign round trip. We make these rates at all times; they have been in effect since the road was placed in operation."

**Advertising the Marion Flyer.**—An illustrated postal card has been issued by the Indiana Union Traction Company, Anderson, Ind., as an advertisement of its "Marion Flyer." There are two illustrations on the card, one of the interior of the car and the other of the exterior. The car is a chair car and excess fare is charged. For the trip from Indianapolis to Marion, 73 miles, the fare is \$1.25 single ride, including 20 cents excess fare; the round-trip rate is \$2.30. The time required for the trip from Indianapolis to Marion is two hours and 35 minutes. No stop is made between Anderson and Indianapolis, a distance of 39 miles.

The Chicago board of supervising engineers, in charge of the rehabilitation of the traction lines of the city, states that it may be a year before all the through routes specified in the ordinances passed last February can be placed in operation, although some of the routes can be made available in a short time. The tracks and curves of the Chicago Railways Company are not in a condition to permit the operation of the large double-truck cars used by the Chicago City Railway on the south side and there are many subways at railroad crossings which are two low for the south side cars. The Chicago City Railway owns a large number of small single-truck cars which could be used for through routing and members of the city council's committee on local transportation have advocated using these cars until changes can be made that will permit the operation of the larger cars. The board has fixed the general dimensions for the 400 new cars to be ordered by the Chicago Railways Company, providing for a narrower and lower car than those used by the Chicago City Railway Company.



# Construction News

## FRANCHISES.

**Citronelle, Ala.**—It is announced that C. A. Elkins, representing a syndicate which proposes to build an electric railway from Citronelle to Mobile, Ala., 30 miles, has secured a franchise for the operation of the line through Citronelle. A franchise also will be sought in Mobile for building the line from One-Mile Creek to Three-Mile Creek, the last-named of which is the northern boundary of the limits of Mobile. Later the county commissioners will be asked for right of way over the county road.

**Greenville, Pa.**—State Senator James M. Campbell of Mercer, Pa., representing a company which proposes to build an electric line from Greenville to Mercer and Sharon, has applied for a franchise in Greenville. Senator Campbell is said to have announced that the line would be built and that the first section to be constructed would be the Greenville line followed later by a line connecting Sharon and Mercer, Pa.

**Ocean City, N. J.**—A franchise has been granted to the Atlantic City & Ocean City Railroad to lay its tracks on Eighth street to the Boardwalk, thus giving a continuous track from the Atlantic City boardwalk to the Ocean City boardwalk.

## RECENT INCORPORATIONS.

**San Francisco & Bay Counties Railway, Oakland, Cal.**—Incorporated in California for the purpose of extending the San Francisco Oakland & San Jose Railway (Key Route) from its present terminus in Oakland to San Jose, connecting with San Francisco by a ferry system. The road will extend from Emeryville through Oakland, Piedmont, Hayward and on to San Jose, 60 miles from San Francisco. A preliminary survey was made several months ago. Two branch lines, one from Oakland to Northbrae,  $4\frac{1}{2}$  miles, and another from Oakland to Claremont,  $3\frac{1}{2}$  miles, also are planned. It is stated that the new company is ready to start construction work as soon as the permanent route has been decided. Capital stock, \$250,000. Incorporators: F. M. Smith, A. E. Herron, Oakland; George E. Pratt, Berkeley; F. C. Havens, Dennis Seales, Piedmont, Cal.

## TRACK AND ROADWAY.

**Accomac Power & Traction Company, Onancock, Va.**—James D. Lalor, 1330 Arch street, Philadelphia, Pa., chief engineer of this proposed interurban line, writes that surveys have been completed and that grading will be started in about 60 days. The line will be for passenger and freight service and will serve the towns of Onancock, Tasley, Accomac, Tompkins Bay and Battle Point, Va., a total distance of  $8\frac{1}{2}$  miles. The bracket and cross-suspension type of overhead construction will be used. Plans and specifications are being prepared. No contracts have been let. Headquarters, Onancock, Va.

**Atlanta Norcross & Gainesville Electric Railway, Gainesville, Ga.**—H. D. Jacquish writes that this company, which proposes to build an electric railway from Atlanta to Gainesville, Ga., 50 miles, via Chamblee, Doranville, Duluth, Suwanee and Buford, has completed surveys from Atlanta to Norcross, 18 miles, and has applied for a charter. E. Philbrick, chief engineer, Baldwin, Ga.

**Bayou Teche Railway & Light Company, New Iberia, La.**—It is stated that 238 tons of steel rails are en route by water for the use in constructing this road between New Iberia and Jeannette, La., and that other material is on the ground. Work will be started in the near future. H. H. Fine, superintendent. (Noted January 18.)

**Boston Elevated Railway, Boston, Mass.**—The Boston transit commission has announced that it probably will be six months before the Washington street subway will be ready to turn over to the Boston Elevated Railway Company for operation. While the work is progressing satisfactorily in all departments, much remains to be done and it is believed that it will not be finished before next summer. The work of installing the electrical equipment, however, probably will be started by the company some time before the subway is completed.

**Brownsville Carmichaels & Waynesburg Railway, Masontown, Pa.**—This company, which is the Green county division of the Brownsville Masontown & Smithfield Street Railway, will soon be incorporated to build a 58-mile system of interurban roads in Green and Washington counties, Pennsylvania. It will be a single-phase line and will be constructed by the

Masontown Construction Company, Masontown, Pa. The route in Green county is as follows: From Waynesburg east to Carmichaels and north by way of Jefferson to Rice's Landing. The route in Washington county includes Clarksville, Zollarsville and Bentleyville. A line also will be built from a point on the Monongahela river opposite Rice's Landing northeast to Brownsville in Fayette county. It is expected that work will be started this spring on the 15-mile section between Waynesburg and Rice's Landing. Several franchises have been secured by W. J. Sheldon, president, McKeesport, Pa., who also is president of the Brownsville Masontown & Smithfield Street Railway. It is stated that later the two roads probably will be consolidated. (Noted September 28, 1907.)

**Calumet & Lac la Belle Traction & Power Company, Calumet, Mich.**—Surveys have been completed and part of the right of way obtained for the construction of this proposed 10 $\frac{1}{4}$ -mile electric railway from Calumet to Mohawk, Mich., and from Calumet to a point in Keweenaw county on Lake Superior. About two miles of subgrade have been completed, poles and ties are now being purchased and orders will be placed for steel the latter part of April. The greater part of the work will be done by the company, although contracts for a portion of the work have been let. H. J. Vivian, president; Earl K. Stewart, chief engineer, Calumet, Mich. (Noted January 18.)

**Capital Traction Company, Washington, D. C.**—A bill providing for an extension of this company's line from its present terminus at Fifth street and Nichols avenue, Congress Heights, along the avenue and the Livingstone road to Shepherds Landing, has been submitted by the commissioners to Representative Smith, chairman of the house district committee, with a request for enactment.

**Central Arkansas Electric Railways Company, Pine Bluff, Ark.**—A. M. Van Auken, chief engineer, writes that this company is now locating the permanent route for its interurban line from Pine Bluff to Little Rock and Hot Springs, 90 miles. About 20 miles of grading has been completed and work will be resumed in June. It is not expected that the present management will complete the line. As soon as financial arrangements have been made the contract for the construction of the road will be let to one of the large engineering and contracting companies. The power house of the company will be located at Junction City, near Sheridan, in Grant county, where large coal deposits are located. J. A. Holmes, president, Pine Bluff, Ark.; D. H. Saunders, vice-president; T. M. Hooker, secretary and attorney; F. L. Cramer, treasurer.

**Cleveland Southwestern & Columbus Railway, Cleveland, O.**—With the exception of ballasting, the 15-mile section of this company's Cleveland Ashland & Mansfield extension between Ashland and Mansfield, O., has been completed, and it is expected that cars will be operated by April 1. About 15 miles of grading east from Mansfield has been done and work on this section will be resumed about the first of April. C. N. Wilcoxon, general manager, Cleveland, O.

**Dallas Interurban Electric Railway, Dallas, Tex.**—This company, which was incorporated in Texas several months ago to build 30 miles of street railway in Dallas and interurban lines from Dallas to Sherman, Denison, Greenville, Terrell and Tyler, Tex., has elected officers as follows: Henry Dorsey, president; I. J. Willingham, first vice-president; Robert Ralston, second vice-president; M. H. Wolfe, third vice-president; S. A. Stemmons, secretary; W. W. Caruth, treasurer; W. H. Clark and W. T. Henry, general counsel.

**Des Moines & Sioux City Railway, Lake City, Ia.**—A. O. Anderson, secretary of this company, writes that a partial organization of this company which proposes to build an electric railway serving Des Moines, Sac City, Storm Lake and Lake City, Ia., was effected on February 18 at a meeting of delegates from these cities. The following officers were elected: President, S. N. Elwood, Sac City; vice-president, M. H. Miller, Ft. Dodge; secretary, A. O. Anderson, Lake City; treasurer, E. M. Bailey, Sac City. He states that at present the organization is not sufficiently advanced to let contracts for the engineering work. Preliminary plans are under way. The headquarters of the company will be at Lake City, Ia.

**Des Moines Winterset & Creston Electric Railway, Des Moines, Ia.**—At a meeting of the executive committee held last week the resignation of A. E. Park, who has been general manager since this road was organized early in 1906, was accepted. E. B. Steere, vice-president of the company, was elected general manager to succeed him.

**Elkins Electric Railroad, Elkins, W. Va.**—This company has completed its line in Elkins and is now grading at a point about two miles out of Elkins. Surveys have been completed

as far as Harding and the work is to be pushed as fast as the weather will permit.

**Evansville Mt. Carmel & Olney Interurban Railway.**—At a meeting held at Grayville, Ill., by those interested in the construction of an interurban railway from Olney, Ill., to Evansville, Ind., it was decided to incorporate the new company under the above name. The road will serve Evansville, Cynthiana, Mt. Carmel, Lancaster and Olney. Aden Knopp, Olney, Ill., is president; G. W. Courter, Mt. Carmel, is secretary. Others interested are: C. J. Seibert, E. O. Lockyer, Jacob Laubscher, Evansville; E. B. Bixley, Thomas Newell, Cynthiana; J. O. Smith, J. F. Seibert, Lancaster; Aden Knopp, J. F. Hyatt, F. N. Boyer, Olney.

**Freeport, Ill.**—Right of way is being secured by Frank Zinnel for the construction of an interurban railway from Freeport southwest to Savanna, Ill., by way of Florence, Shannon, Lanark and Mt. Carroll, Ill. If the line is built it will form, by means of the existing electric lines, a direct connection from Chicago to the Mississippi river by way of Elgin, Belvidere, Rockford and Freeport.

**Gary & Interurban Railroad, Gary, Ind.**—It is reported that this company has suspended construction work on its proposed line in Gary.

**Illinois Traction System, Champaign, Ill.**—The Illinois railroad and warehouse commission has ordered this company to construct an elevated crossing over the tracks of the Chicago & Alton and Illinois Central railroads for its line entering the city of Lincoln. The crossing is required to be completed by October 1.

**Interstate Electric Railway, St. Joseph, Mo.**—It is announced that this company expects to start grading this spring on its proposed electric line from St. Joseph to Kansas City, Mo., by way of Dearborn and Liberty. Right of way has been secured. Smith H. Bracey, 1606 Tribune building, Chicago, will have charge of the construction. (Noted June 15, 1907.)

**Inter-Urban Railway, Des Moines, Ia.**—We are advised by F. S. Cummins, chief engineer, that the report that this company is contemplating an extension from Woodward to Ogden, Ia., as published in the Electric Railway Review of February 8, is incorrect.

**Los Angeles Pacific Company, Los Angeles, Cal.**—Right of way for the proposed extension of this company's Hollywood line through Cahuenga pass toward Toluca, Burbank and Glendale, Cal., has been secured. The building of this line is believed to be a part of the joint plans of the Los Angeles Pacific and the Southern Pacific companies to electrify all of the local lines of the steam road in the vicinity of Los Angeles, and to bring the large fruit growing and farming districts of southern California into trolley as well as steam connection with Los Angeles. The proposed line will follow as closely as possible the county highway through Cahuenga pass to Toluca, where it crosses the Southern Pacific's local line from Chatsworth park on the coast through Canoga, Reseda, Encino and Toluca to Burbank and Glendale and from there into the city. The company has five years in which to construct the line, but it is believed that it will be completed and in operation much before that time.

**Milwaukee (Wis.) Electric Railway & Light Company.**—It is announced that work on the extension from Oconomowoc to Watertown, Wis., will be resumed as soon as the weather will permit and completed as soon as possible.

**New York & North Shore Traction Company.**—The first 10 miles of this company's proposed electric line from Mineola to Roslyn, by way of Port Washington, N. Y., is said to have been completed. A franchise for six miles additional from Roslyn to the New York City line has been secured and a franchise covering six more miles from the New York City line to Flushing has been applied for. At Flushing it will connect with the New York & Queen's County Railway for entrance to Forty-second street on Manhattan island by way of the Steinway tube. (Noted July 6, 1907.)

**North Midland Electric Railway, London, Ont.**—The work of surveying the route of this railway has been started. Two surveys will be taken, one via Bryanston and the other via Thorndale, the terminus at present being Stratford. It is estimated that the Thorndale route will save the erection of two bridges, at London and Devizes, and an outlay by the company of at least \$70,000. A. E. Welch of London, Ont., will leave shortly for London, Eng., with the object of financing the project.

**Puget Sound International Railway & Power Company.**—This company, which was incorporated last summer by the Stone & Webster interests to build an extensive system of interurban railways in the state of Washington and to im-

prove its existing street and interurban lines, is now securing options on the right of way over an alternate route by way of Belfast and Lake Samish from Burlington to Bellingham, Wash. By this alternate route the distance between these points will be shortened about two miles. The entire distance which this section of the system will cover from Seattle to Bellingham is 97 miles. (Noted June 22, 1907.)

**St. Joseph & Stratford Radial Railway.**—We are advised that a company to be organized under the above name proposes to build an electric railway from St. Joseph to Stratford, Ont., and that our item of February 8, page 190, connecting this proposed line with the Ontario West Shore Electric Railway is incorrect.

**St. Louis Montesano & Southern Railway, St. Louis, Mo.**—This company has begun construction work by erecting the poles for its proposed electric line on the Lemay ferry road. The line will connect St. Louis and Joplin, Mo., crossing the Meramec river, and when completed will be 65 miles long. Charles W. Gutke, 5727 Von Versen avenue, St. Louis, Mo., is president. (Noted October 19, 1907.)

**Seattle, Wash.**—F. X. Waldron & Co., Seattle, Wash., are said to be promoting the construction of an electric railway on Vashon island, from its northern to its southern extremity, 12 miles. At either end of the island connection will be afforded by fast running ferries to Seattle on the north and Tacoma on the south. The distance by water would be about 12 miles, making a total length of 24 miles by this route between the two cities as against 29 miles by the present water route, 39 miles by the existing interurban routes and 42 miles by the Northern Pacific. It is stated that the road will cost about \$350,000, of which enough has been subscribed to warrant starting construction work as soon as franchises have been obtained. It will be practically an air line and the grade is said not to exceed 3 per cent. Application has been made by the promoters to the county commissioners for a 40-year franchise in King county and when this has been secured incorporation papers will be filed and work started on the island.

**Spokane & Inland Empire Railroad, Spokane, Wash.**—J. P. Graves, president, has made a proposition to the directors of the Lewiston & Southeastern Electric Railway of Lewiston, Idaho, to acquire that company's property and franchises, reimburse the stockholders for the money expended in surveys, etc., and to build the proposed road from Lewiston to Grangeville and Nez Perce, Idaho. The plans are conditional on the success of Mr. Graves' financial negotiations. The Lewiston & Southeastern, of which G. W. Thompson is president, has acquired valuable franchises in Lewiston and elsewhere, and has completed surveys and considerable grading.

**Washington Railway & Electric Company, Washington, D. C.**—Preliminary surveys for the extension of the Washington & Rockville Railroad, which is controlled by the Washington Railway & Electric Company, from its present terminus in Rockville to the extreme western limits of the city, were started on February 12. The route will lie along the main street of Rockville. It is understood that later on the road will be extended west to Gaithersburg, about five miles. H. W. Fuller, general manager, Washington, D. C.

**Waterloo Cedar Falls & Northern Railway, Waterloo, Ia.**—This company contemplates building an extension from the business district of Waterloo to Sans Souci, an amusement park, 2½ miles. M. L. Newton is chief engineer.

#### POWER HOUSES AND SUBSTATIONS.

**Des Moines (Ia.) City Railway.**—At the annual meeting last week plans were discussed for increasing the capacity of the company's power house by 1,500 horsepower.

**Great Northern Railway.**—Contractors will begin work early in March on a hydro-electric plant at Leavenworth, Wash., west of Spokane. The plant will furnish power to run trains over the mountains from Leavenworth to Skykomish, and will be one of the largest in Washington. Four electric generators, each having a capacity of 1,300 horsepower, will be installed. The company has been working in Tumwater canyon more than six months preparing a suitable site for the plant and sidetracks.

**Lewiston Augusta & Waterville Street Railway, Lewiston, Me.**—This company has let contracts for the electrical equipment of two substations to the General Electric Company, Schenectady, N. Y. The stations will be located at Vassalboro and Monmouth, Me. E. D. Reed, general manager, Lewiston, Me. (Noted January 18.)

**Waterloo Cedar Falls & Northern Railway, Waterloo, Ia.**—It is reported that this company will install one 400-kilowatt generator and an additional water tube boiler. M. L. Newton is chief engineer.

## Personal Mention

Mr. P. F. Cassidy has been appointed claim attorney for the Uxbridge & Blackstone Street Railway Company, Uxbridge, Mass.

Mr. J. P. Clark has been appointed assistant to President M. W. Mills of the Michigan United Railways, with office at Jackson, Mich., with full authority to act for the president. Mr. J. M. Bramlette, general manager, will still have full charge of the operation of the road, reporting to the president or to the assistant to the president.

Mr. W. J. Dunston has been appointed master mechanic of the Sterling Dixon & Eastern Electric Railway, effective on February 1. He formerly was connected for five years with the Jacksonville (Ill.) Railway & Light Company and since April, 1906, has been master mechanic of the Winnebago Traction Company at Oshkosh, Wis.

Mr. Joseph Colvin, superintendent and purchasing agent of the Washington Alexandria & Mt. Vernon Railway, with headquarters at Alexandria, Va., has been transferred to the general offices of the company at Philadelphia. He will be succeeded at Alexandria by Mr. R. W. King, a brother of Mr. C. P. King, president of the company.

Mr. H. E. Chubbuck, general manager of the Illinois Valley Railway, Ottawa, Ill., has been appointed superintendent of the Wichita (Kan.) Railroad & Light Company, succeeding Mr. W. B. Morrison, resigned. This is one of the properties owned by the McKinley interests, with which Mr. Chubbuck has been identified in Illinois since 1897.

Mr. J. S. McWhirter has resigned as superintendent of car equipment of the Mahoning & Shenango Railway & Light Company at Youngstown, O., to accept a similar position with the Third Avenue Railroad, New York City. Mr. McWhirter was for a number of years connected with the Brooklyn Rapid Transit Company and the Interborough Rapid Transit Company of New York.

At the annual meeting of the Chicago City Railway on February 17 Mr. Thomas E. Mitten was re-elected president; Mr. R. B. Hamilton, secretary and purchasing agent, was elected vice-president; Mr. F. D. Hoffman, treasurer, was elected secretary also; Mr. J. J. Duck was retained as auditor; Mr. Simon R. Flynn, president of the National Live Stock Bank, was elected a director to succeed Mr. S. M. Felton, resigned.

Mr. S. W. Huff, general manager of the Virginia Passenger & Power Company, Richmond, Va., has been elected president of the Coney Island & Brooklyn Railroad, Brooklyn, N. Y., effective on March 1, succeeding Mr. John L. Heins, resigned, as noted in our issue of last week. Mr. Huff is a graduate of the electrical engineering department of Cornell University and has been with the Virginia Passenger & Power Company since July, 1902. He was formerly assistant superintendent of the Baxter Electric Motor & Manufacturing Company, Baltimore, Md., and later became general manager of the street railway lines in Raleigh, N. C. He also at various times has been connected with the electric railroads of Baltimore, San Francisco and Philadelphia.

Mr. J. S. Pevear has been appointed superintendent of the St. Paul lines of the Twin City Rapid Transit Company, succeeding Mr. Fenwick E. Low, resigned on account of ill health. Mr. Pevear has been connected with the General Electric Company in construction and operation work for seven years, for the past year and a half with the Chicago office of the company. Mr. Lowe has been superintendent of the St. Paul lines for about a year and was previously for one year chief clerk to the general manager. He was formerly for several years general agent of the Pullman Company at Minneapolis. Mr. G. Brigger, superintendent of the Minneapolis lines of the Twin City Rapid Transit Company, has resigned on account of ill health, after 12 years' service in that position. Mr. P. W. Gerhardt, who was recently appointed assistant to the general manager, will succeed Mr. Brigger temporarily as acting superintendent.

### Obituary.

J. A. Carothers, for a number of years president of the Bloomington Pontiac & Joliet Electric Railway, died at his home in Pontiac, Ill., on February 19, aged 45 years. His control of the road was terminated last fall when it was acquired by the Fisher interests of Joliet for the purpose of offering it to Dwight, Ill. At the time of his death Mr. Carothers was president of the Pontiac Light Heat & Power Company.

## Financial News

**Camden & Trenton Railway, Camden, N. J.**—William F. Sadler, Jr., of Trenton, N. J., was appointed receiver for this company on February 18 by Vice-Chancellor Walker of Trenton. The proceedings for the appointment of a receiver were begun by Henry V. Massey of Philadelphia, who filed a bill making the following allegations: That the Camden & Trenton line has been operated at a loss for a long period, the deficit for 1907 having been \$46,558.90; that on January 1, 1907, the general deficit was \$66,951.37, and that it now amounts to \$115,000; that the company has other debts and losses aggregating, with the foregoing, about \$200,000; that the company defaulted on November 1, 1907, in the payment of interest on its first mortgage bonds, amounting to \$17,750, and also defaulted on January 1, 1908, in the payment of interest on its general mortgage bonds, amounting to \$15,562; and further that the company is unable to meet maturing obligations. The bill charges that the officers of the New York-Philadelphia Company, which controls the property, have "so recklessly mismanaged the Camden & Trenton Railway that they have entirely destroyed its credit and have produced a condition of insolvency."

**Chicago City Railway.**—S. M. Felton has resigned as a director on account of his removal from Chicago and S. R. Flynn, president of the National Live Stock bank of Chicago, has been elected to succeed him.

**Chicago Lake Shore & South Bend Railway, South Bend, Ind.**—A trust deed has been filed with the Cleveland Trust Company, as trustee, to secure an issue of \$6,000,000 of 5 per cent 40-year first mortgage bonds, dated August 15, 1907. Issues of \$5,000,000 of common stock and \$1,000,000 of preferred non-cumulative stock have been authorized.

**Chicago & Milwaukee Electric Railroad.**—Bion J. Arnold has been employed by the receivers to estimate the cost of completing the road to Milwaukee, supplementing the report of the engineers of the company.—George M. Seward, receiver for A. C. Frost & Co., states that Ravinia park will be operated next year as usual. It is said that the property may be leased to a private corporation.

**Chicago Railways Company.**—A stipulation has been filed in the United States circuit court at Chicago, extending the time for deposit of the stocks and bonds of the Chicago Union Traction Company and underlying roads until August 1, so that holders who have not previously assented to the reorganization plan now have an opportunity to participate.

**Exeter Hampton & Amesbury Street Railway, Exeter, N. H.**—In accordance with a decree entered by the superior court of New Hampshire on November 7, 1907, the property of this company will be sold on March 10.

**Ft. Wayne & Wabash Valley Traction Company, Ft. Wayne, Ind.**—Gross earnings in 1907 were \$1,283,722, an increase of \$191,076 over 1906. Expenses were \$746,036, an increase of \$87,576. Net earnings were \$537,686, an increase of \$105,500. Other income was \$58, a decrease of \$102. Total income was \$537,744, an increase of \$105,398. Interest and taxes were \$427,314, an increase of \$63,082. The surplus was \$110,430, an increase of \$42,316.

**Gray's Harbor Railway & Light Company, Aberdeen, Wash.**—The \$150,000 of first mortgage 6 per cent bonds held in reserve has been issued, making the total amount outstanding \$500,000. Gross earnings in 1907 were \$193,744. Operating expenses and taxes amounted to \$105,273, leaving net earnings of \$88,471. Interest charges were \$24,719, leaving a surplus of \$63,752.

**Indiana Union Traction Company.**—Earnings in the year 1907 were as follows: Gross earnings, \$2,089,232.50; operating expenses, \$1,111,198.48; net earnings, \$978,034.02; interest on Union Traction Company of Indiana, Indianapolis Northern Traction Company, Muncie Hartford & Ft. Wayne Railway and other underlying bonds, also taxes, \$728,115; net income, \$249,919.02; dividends on stocks of Union Traction Company of Indiana and Muncie Hartford & Ft. Wayne Railway, and interest on Indiana Union Traction Company bonds, \$229,896.66; surplus, \$20,022.36.

**Interborough-Metropolitan Company.**—T. P. Shonts, the president, has issued a statement to shareholders, which shows that there was a balance in the income account on December 31, 1906, of \$524,924; there was added to this amount in 1907 \$3,052,151 dividends on Interborough Rapid Transit Company stock owned, \$1,495,900 dividends received from Metropolitan Street Railway stock before the appointment of receivers, and

\$205,500 interest on bank balances, making a total for all items of \$5,278,485. Interest paid and accrued during the year on Interborough-Metropolitan  $4\frac{1}{2}$  per cent collateral trust bonds amounted to \$3,052,125, the two dividends paid on Interborough-Metropolitan preferred stock amounted to \$1,143,500, expenses were \$212,184, and taxes \$103,760, making total disbursements of \$4,511,569. The surplus in the income account on December 31, 1907, was therefore \$766,916. The miles of track of companies comprising the Interborough-Metropolitan system were: Interborough Rapid Transit Company subway, 72.48 miles; Interborough Rapid Transit Company elevated, 118.05 miles; surface lines owned or controlled by Interborough Rapid Transit Company, 154.03 miles; New York City Railway and subsidiary companies, 519.46 miles; total (single track), 864.02 miles. Mr. Shonts adds: "The earnings of the Interborough Rapid Transit Company continue good; the surplus for the year ending June 30, 1907, after the payment of all interest charges, the guaranteed dividend on Manhattan Elevated Railway Company stock and dividends on its own stock, being \$566,443, as against \$281,290 for the previous year, an increase of \$285,053. The surplus for the last six months of the calendar year shows a gain over the corresponding period of last year, and the under-river section of the Brooklyn extension, which was opened for operation on January 9, 1908, is adding to this surplus at the estimated rate of \$700,000 per annum. It is also anticipated that a further increase will result from the opening of the remainder of the Brooklyn extension about April 1, 1908." The balance sheet of the Interborough-Metropolitan Company shows \$4,545,000 notes payable. The principal assets are stated as follows: Interborough Rapid Transit Company capital stock, at cost in securities of this company, \$104,563,042; Metropolitan Street Railway Company capital stock, at cost in securities of this company, \$68,684,455; Metropolitan Securities Company capital stock, at cost in securities of this company, \$28,329,695.

**Louisville (Ky.) Railway.**—Gross earnings in 1907 were \$2,668,146 and operating expenses were \$1,551,949, leaving a balance of \$1,116,197. Taxes were \$216,000 and interest charges amounted to \$368,126. The surplus after the payment of dividends was \$35,334.

**Macon (Ga.) Railway & Light Company.**—Gross earnings in 1907 were \$355,387, as compared with \$290,345 in 1906. Net earnings were \$149,266, as compared with \$105,002. Interest and taxes were \$67,260, as compared with \$59,547. The surplus in 1907, after provision for dividends, was \$64,990, as compared with a surplus of \$28,440 in 1906.

**Manchester & Derry Street Railway, Manchester, N. H.**—A trust deed has been given to the American Trust Company of Boston, as trustee, to secure an issue of \$500,000 of first mortgage 20-year 5 per cent bonds. The bonds are guaranteed, principal and interest, by the Manchester Traction Light & Power Company.

**Toledo & Chicago Interurban Railway, Toledo, O.**—James D. Mortimer has been appointed receiver for this road by Judge Heaton of the Allen county circuit court at Kendallville, Ind.

**United Railways & Electric Company, Baltimore, Md.**—The agreement for deposit of the stock will expire on February 25, 1908, and Alexander Brown, H. Crawford Black and F. A. Furst have been requested by holders of a large amount of stock to act as trustees under a new agreement to continue in force until May, 1911.

#### ELECTRIC RAILWAY EARNINGS.

##### Aurora Elgin & Chicago Railroad.

	1908.	1907.
Gross receipts	\$92,984.99	\$88,892.60
Operating expenses	58,902.39	56,167.77
Net earnings	35,081.60	32,724.83
Deductions	28,532.34	26,491.65
Surplus	6,549.26	6,233.18

##### United Railways of St. Louis.

	1908.	1907.
Gross earnings and other income	\$827,398	\$826,337
Expenses, taxes and depreciation	554,359	577,870
Net earnings	273,039	248,467
Charges	233,354	231,541
Net income	39,585	16,926

#### Dividends Declared.

American Railways Company, Philadelphia, quarterly,  $1\frac{1}{2}$  per cent.

Columbus (O.) Railway, common, quarterly,  $1\frac{1}{4}$  per cent.

Kansas City Railway & Light Company, preferred, quarterly,  $1\frac{1}{4}$  per cent.

# Manufactures and Supplies

#### ROLLING STOCK.

**Third Avenue Railroad, New York,** has ordered 50 closed and 25 open double-truck cars from The J. G. Brill Company.

**Lawrence County Railroad, Little Rock, Ark.,** under construction from Hoxie, Ark., to Smithville, Ark., is in the market for one passenger motor car.

**Aurora Elgin & Chicago Railroad, Chicago,** has placed an order with the McGuire-Cummings Manufacturing Company for two sets of trucks, to be placed under old cars.

**St. Paul City Railway, St. Paul, Minn.,** will receive 12 new cars on March 1. These cars are being built in the shops of the Twin City Rapid Transit Company, at Minneapolis.

**Interborough Rapid Transit Company** will have to show cause to the public service commission of New York why all cars bought in the future, as well as those now in operation, should not be equipped with side doors. Counsel to the commission has been asked to cite reasons, if any, why an order of the sort should not be issued.

**Chicago Railways Company, Chicago,** is authorized by the board of supervising engineers to secure bids on 400 pay-as-you-enter cars, constructed in accordance with the following general specifications. The detailed specifications are to be prepared by the chief engineer of the board and approved by the board before the order is placed. The center aisle is to be not less than 23 inches wide. All cross seats are to be not less than 36 inches in length and are to be cushioned. The height of the cars from top of rail to top of trolley board is to be not less than 11 feet 8 inches, nor more than 11 feet 10 inches. The length over the end posts of the car bodies shall be not less than 32 feet nor more than 32 feet 5 inches. The length of platform shall be 8 feet  $4\frac{1}{2}$  inches and the length of the cars over all not less than 48 feet 9 inches nor more than 49 feet 2 inches. The width over all is to be not less than 8 feet 9 inches. The diameter of wheels is to be 34 inches for steel wheels and 33 inches for cast-iron wheels. The distance between wheel centers must be 4 feet 6 inches and the distance between center pins of trucks 20 feet to 20 feet 5 inches.

#### SHOPS AND BUILDINGS.

**Roanoke Railway & Electric Company, Roanoke, Va.**—This company has sold to the Norfolk & Western Railway the property on Earnest avenue, near the center of Roanoke, on which its car barn and power station are located, the consideration being \$40,000 cash and three small parcels of land on Walnut street adjoining its new power station, which is practically completed. The electric railway company is to remove the buildings and their contents from the property sold the Norfolk & Western, but retains possession for 18 months. During that time the electric company will build a new and modern car barn on Walnut street.

**Williamsport (Pa.) Passenger Railway.**—It is reported that this company is contemplating the erection of a new repair shop.

#### TRADE NOTES.

**Quincy-Manchester-Sargent Company** has removed its general offices from 90 West street, New York, to its factory at Plainfield.

**A. P. Bowen,** who has been purchasing agent of the Western Steel Car & Foundry Company and the Anniston Car Company, on February 15 also assumed the duties of purchasing agent of the Pressed Steel Car Company.

**Charles T. Mordock,** member of the board of expert engineers of the Stone & Webster Engineering Corporation at Boston, Mass., has been transferred to the Chicago office of the company in the First National Bank building.

**C. A. Denman,** whose resignation as superintendent of the Cleveland & Garrettsville division of the Eastern Ohio Traction Company, Cleveland, was announced in our issue of January 4, is now located with the Perfection Pipe Company at Toledo, O.

**Paul B. Patten, Salem, Mass.,** manufacturer of the ticket-destroying machine which has been found so necessary by the large street and interurban railways in this country, reports that the machine is being recognized as the best device for its purpose by officials in many parts of the world. The West Indies Electric Company, Limited, Kingston, Jamaica, in re-

fitting the road after the earthquake, bought these machines. J. G. White & Co. ordered an outfit for the Manila Street Railway. The Reading Tramways Company of Reading, England, and the street railway company at Sydney, N. S. W., have recently installed machines.

**Western Wire Sales Company**, 356 Dearborn street, Chicago, has been sold to a new organization, the officers of which are: Richard Wick, president; Fred B. Keller, secretary and treasurer; and F. W. Page, sales manager. J. Allen Haines and A. Conro Fiero formerly owned this company.

**Zelnicker Crayon Works**, St. Louis, Mo., has just put on the market a new crayon called the "Suremark." This name was adopted, the company states, because the new crayon makes a sure mark that will remain on any surface, particularly highly polished ones, such as tin, brass, glass, paper, etc. The yellow is particularly good for marking iron castings.

**Louis J. Bergdoll and George F. Pawling** announce that they have formed a partnership under the firm name of Bergdoll & Pawling, with offices at Broad and Wood streets, Philadelphia. The new firm will engage in engineering and contracting work in structural steel and iron. Mr. Pawling was formerly contracting engineer for the Belmont Iron Works.

**John A. Roebling's Sons Company**, Trenton, N. J., on February 5 lost one of its rope shops. The company states that compared with the other shops the one destroyed was of minor importance and the productive capacity of the remaining shops will enable it to continue its usual prompt shipments of wire rope. The shop will be rebuilt immediately.

**Alfred Box & Co.**, Front and Poplar streets, Philadelphia, have been awarded the contract for the crane equipment of a power station and two substations of the Coney Island & Brooklyn Railroad for which Ford, Bacon & Davis, New York, are engineers. A 30-ton capacity hand-power traveling crane will be installed in the central power station now under construction at Smith and Ninth streets, and 10-ton traveling cranes in the two substations located at King's highway and at Sanford street.

**William Jennings Company**, El Paso, Tex., mechanical and electrical engineer and dealer in railway and general supplies, has recently been organized by William Jennings, who resigned on October 31, 1907, as mechanical and electrical superintendent of the Los Angeles Interurban Railway and the Pacific Electric Railway of Los Angeles, Cal. Prior to going to Los Angeles Mr. Jennings was for about 19 years superintendent of motive power and machinery of the Mexican International Railroad.

**Dossert & Co.**, New York, are making further large shipments of their solderless 2-way connectors, to be used in the wiring of the 35 seat passenger cars now being completed by the Pressed Steel Car Company at McKees Rocks, Pa., for the Pennsylvania Railroad. These cars will be used on the main line between New York and Chicago. They will be electrically lighted and no solder will be used in the splicing. The Dossert joints are installed in junction boxes underneath the car floors, where the No. 0000 feeder cables are connected up.

**Chicago Pneumatic Tool Company**, Chicago, at its annual meeting held in Jersey City, N. J., on February 17, submitted a report for the year 1907. The income account was as follows: Profits, \$848,007; depreciation, repairs and renewals, \$161,577; written off for developing new tools, \$15,018; net profits, \$671,412; bond interest, \$115,000; interest on mortgage assumed, \$2,129; sinking fund instalment, \$50,000; earned on stock, \$504,283; dividends, 3 per cent, \$190,063; surplus, \$314,219. From the surplus of \$878,409 on hand on December 31, 1907, there was appropriated \$100,000 for foreign subsidiary companies and \$84,554 for special depreciation on plants and investments. The balance, added to the foregoing surplus for 1907, made a total surplus of \$1,008,074.

**Railway Specialty & Supply Company**, Chicago agent of the Pittsburg Lamp Brass & Glass Company, states that the bulk of the signal glass, lenses and roundels in the yards of the new Washington terminal is Kopp signal glass. The photometric limits were selected after a series of joint conferences and tests by the signal officials of the Pennsylvania Railroad and Baltimore & Ohio. It is said that at night this yard presents one of the finest displays of signal illumination that can be seen anywhere. The range of the lights and the purity of their hue, both of which are responsible to a large degree for the efficiency of any signal, are especially prominent. The Railway Specialty & Supply Company states that these results are practically due to the elaborate care given in the production and examination of the glass. Each piece is subjected to four tests before shipment and goes out with its individual photometric value as determined from these

tests marked upon it. This prevents lenses of inaccurate construction or any glass of poor hue or improper illuminating power finding a place in a signal installation equipped with Kopp glass.

**The J. G. Brill Company's** report for the year ended December 31, 1907, shows the largest business in the history of the company. The gross business was \$9,211,825. This included the results of the operation of the company's five plants at Philadelphia, St. Louis, Cleveland, Elizabeth, N. J., and Springfield, Mass. The Springfield plant was not acquired by the Brill interests until April, so the gross earnings it contributed are for nine months. The company charged off for depreciation \$120,411 and for repairs to buildings, machinery and tools, \$180,250, leaving a net profit of \$1,368,949. Out of this \$228,725 was paid in dividends on the preferred stock and \$146,849 in dividends on the common stock, leaving a surplus of \$993,375, which was credited to surplus. The total surplus account is now \$1,703,104.

**Electric Traction Supply Company**, St. Louis, Mo., following its general policy of expansion, has established an office at 1200-1202 Fisher building, Chicago, in charge of Frank D. Willis. The Chicago office will look after the northwest territory, including northern Illinois, Iowa, Minnesota, Wisconsin, Michigan and northern Indiana, and Mr. Willis will take occasion to visit this territory at an early date. The establishing of this office will facilitate the handling of business in this territory and enable patrons of the company to secure more prompt service. Mr. Willis has been representing the Sterling-Meaker Company of Newark, N. J., in the west for a number of years, and as the Electric Traction Supply Company has been appointed agent for the eastern company, he will continue to sell Sterling-Meaker products, in addition to the large line furnished by his new connection.

**Wynn Meredith**, member of the American Institute of Electrical Engineers, has become a partner in the firm of Sanderson & Porter and will have charge of the western office which they have opened in the Union Trust building, San Francisco, Cal. After a technical training at the University of Illinois Mr. Meredith in 1888 became engaged in the construction and operation of lighting and railway properties. He was actively connected with the engineering and operation of the electrical plant of the World's Fair at Chicago in 1893, and the California fair in 1894, subsequently becoming associated with Messrs. Hasson & Hunt, and later a member of the firm of Hunt, Dillman, Meredith & Allen, San Francisco, Cal. During 15 years' residence in California Mr. Meredith has been engaged in general engineering work and prominently identified with many of the important hydro-electric and transmission developments on the Pacific coast, in the United States and Canada.

**General Electric Company**, Schenectady, N. Y., in order to provide for the heavy demand for Edison lamps, and to take care of the new developments in Gem, Tantalum and Tungsten lamps, has in the past year built four new factories at East Boston, Toledo, O., Ft. Wayne, Ind., and Newark, N. J. The factory at Toledo is confined to the production of Gem filament lamps; the Newark factory to Tungsten lamps only, and the factories at East Boston and Ft. Wayne to the regular carbon filament lamps. In addition the General Electric Company has erected a new factory building at Harrison, N. J., adjoining the present lamp factory, which is devoted to the production of Tungsten lamps. Besides these new factories the main factory at Harrison, N. J., continues its large output of carbon and Gem filament lamps. The total productive facilities of the General Electric Company now aggregate 60,000,000 lamps a year, so that it is in excellent position to supply all demands from customers.

**Dearborn Drug & Chemical Works.**—Robert F. Carr and several of his associates in the Dearborn Drug & Chemical Works have purchased the holdings in the Dearborn Drug & Chemical Works of the estate of the late William H. Edgar, who died two years ago, and the following officers have been chosen: Robert F. Carr, president and general manager; George R. Carr, vice-president; Grant W. Spear, vice-president; William B. McVicker, vice-president and eastern manager; J. D. Purcell, assistant general manager; W. A. Converse, assistant secretary and chemical director; R. R. Browning, assistant treasurer; A. E. Carpenter, superintendent. C. M. Eddy's holdings were also taken over, he desiring to devote all of his time to his personal business interests. Robert F. Carr became connected with the company very soon after it was organized, entering the business shortly following his graduation in chemistry from the University of Illinois in 1893; for the past 10 years he has been vice-president and general manager of the company, and for most of that time, especially the last few years, has been actively in charge of the business and organization. George R. Carr has been con-

nected with the company since he graduated from the University of Illinois in chemistry in 1901. He has occupied the position of assistant general manager of the company for the past four years, devoting his time largely to the railroad department of the business. G. W. Spear, who is a graduate in mechanical engineering, University of Illinois, entered the business in 1895. He has been one of the vice-presidents of the company for five years, in charge of the branch offices in the central district of the United States, having his headquarters at the general offices in Chicago. William B. McVicker has been connected with the company for 13 years, having during most of that time been at the head of the eastern department; for several years he has been second vice-president and eastern manager, having charge of the general eastern offices at 299 Broadway, New York, and the eastern branches reporting to New York, including Havana, Cuba. W. A. Converse, who was elected to the position of assistant secretary, in addition to the office of chemical director, which he has previously held, has been in charge of the laboratories for the past 12 years. Mr. Converse's ability as a chemist is well known. He has for several years been secretary of the Chicago section of the American Chemical Society. J. D. Purcell, the new assistant general manager, has represented the company in the railroad department for five years. R. R. Browning, assistant treasurer, has held a similar position for some years, having been with the company since 1896. A. E. Carpenter, superintendent, has had charge of the manufacturing department for many years, and is the oldest employe in the service of the Dearborn company. The preparations manufactured by the Dearborn company for the treatment of boiler waters, both in stationary and railroad service, are most generally used. The scientific methods originated by the company's laboratories of treating each water individually, as per requirements, after analysis, has made it possible for Dearborn preparations to give the highest efficiency with all classes of boiler feed supplies.

**Power Specialty Company**, 111 Broadway, New York, manufacturer of the Foster patent steam superheater, has secured among recent contracts the following, covering installation of this superheater in the boilers indicated: Home Electric Light & Steam Heating Company, Tyrone, Pa., 840 horsepower in Stirling boilers; Torresdale Filtration Plant, Philadelphia (second order), 900 horsepower in Heine boilers; Western Clock Manufacturing Company, La Salle, Ill. (second order), 300 horsepower in return tubular boilers; Bernheimer & Schwartz Brewing Company, New York, 1,900 horsepower in Heine boilers; Garden City Company, Garden City, L. I., 200 horsepower in return tubular boilers; National Sugar Refining Company, Yonkers, N. Y., 1,134 horsepower in Babcock & Wilcox boilers. It has also sold Foster superheaters of the independently fired type to the New Jersey Zinc Company, University of West Virginia, Abendroth & Root Manufacturing Company and the Seacoast Canning Company. This latter company has within the past year equipped seven of its plants with the Foster superheater, installed in return tubular type of boilers.

#### ADVERTISING LITERATURE.

**Railway Specialty & Supply Company**, Chicago, Ill.—Bulletin S-211/ illustrates and describes pin and block "Rapid" wire joints, which are especially adapted to signal work.

**American Spiral Pipe Works**, Chicago, Ill.—A new catalogue is devoted to spiral riveted pipe, forged steel pipe flanges and hydraulic and exhaust steam supplies. A large number of illustrations are used effectively.

**Boston Gear Works**, Norfolk Downs, Mass.—Catalogue E1, recently issued, contains quite complete information about standard gears, also chains, sprockets, bearings, steering devices, etc. Many valuable tables are included.

**Trussed Concrete Steel Company**, Detroit, Mich.—A calendar is being mailed to architects, contractors and engineers on which is printed a table of properties of rib metal which will prove of value to the trade. A section of the ribbed metal is fastened to the face of the calendar.

**Northwestern Expanded Metal Company**, 930-950 Old Colony Building, Chicago.—Booklet No. 26, recently issued, entitled "Theory and Tests of Reinforced Concrete Beams," explains the theory of beam stresses in concrete by dealing separately with the tension flange, the compression flange and the web and describes tests made on beams provided with web reinforcement. Beginning with the knowledge that web stresses are present in a concrete beam similar to those in a steel beam or girder, it is shown that to secure an entirely satisfactory reinforcement, provision must be made for these tensile, compressive and shearing stresses in the web. The booklet further explains the system devised for reinforcing in every diagonal direction against these web stresses and gives results of actual tests made.

#### CATENARY CONSTRUCTION AND BONDS ON THE OREGON ELECTRIC RAILWAY.

The Oregon Electric Railway has now been completed between Portland and Salem, Ore., a distance of 50 miles. The road is constructed in a very substantial manner. A considerable number of cuts and fills were required to obtain the uniform grade of 2.65 per cent out of Portland, through the difficult country immediately adjacent. The road crosses the Willamette river on a 4-span steel bridge, each span being 200 feet long. With its trestle approaches this bridge has a total length of 3,800 feet. South of the Willamette river there is an 18-mile tangent, nearly level. The track structure consists of 70-pound T-rails laid on gravel ballast. All water courses are crossed on pile trestles, making ample provision for the heavy flows of surface water experienced in this region.

Power is purchased from the Portland Railway Light & Power Company and delivered at Oregon City over a 9-mile transmission line connecting with the railway. There are four substations on the railway, each equipped with a 500-kilowatt rotary converter. The transmission line carries current at 33,000 volts pressure and at a frequency of 33 cycles. The trolley voltage is 600.

Eight 60-foot motor cars with four 75-horsepower General Electric motors each, and two General Electric locomotives



Oregon Electric Railway—Overhead Construction on Curve.

with four 160-horsepower motors each, constitute the present rolling stock equipment.

#### Overhead Construction.

It was required that the overhead construction should be of as high a standard as the roadway and track, the materials should be of the best quality, the design good and all the parts strong enough to stand operation of heavy trains at high speeds. The Ohio Brass Company's catenary was selected to fulfill these severe conditions. All the fittings of this manufacture are of steel, reinforced by galvanized malleable castings.

Catenary construction was used to support the trolley wire, as the actual expense would then be but little more than for ordinary direct-current overhead construction. This fact is at once apparent. Fewer poles and brackets are required for the 150-foot spans than for the 100 to 115 foot spans used in ordinary construction. The 3-wire transmission line of No. 2 aluminum is strung on the same poles that support the trolley line, 2-part insulators being used.

Bracket construction is used principally for carrying the overhead, but a small number of cross spans were also found necessary. The brackets consist of a steel T-bar supported by a  $\frac{3}{8}$ -inch steel rod. The T-bar rests in a malleable socket casting fastened to the pole with lag screws, and the supporting rod is attached to an adjustably mounted malleable casting near the outer end of the bracket arm. A porcelain in-

ulator for supporting the catenary cable is mounted on a malleable iron pin, which slips over the T-bar.

A  $\frac{7}{16}$ -inch high-strength steel messenger cable supports the No. 0000 grooved trolley wire, with hangers spaced 10 feet apart. Each hanger consists of a  $\frac{1}{2}$ -inch steel bolt, which is screwed into a 5-inch trolley clip at one end, and into a messenger clip at the other. All the parts are galvanized.

For guying on curves a porcelain strain insulator is fastened to the pole by two  $\frac{3}{8}$ -inch eyebolts. From the insulator a  $\frac{1}{4}$ -inch stranded steel cable extends to two loops or bridges attached to the two nearest catenary hangers. All poles on curves are guyed, and, where necessary, guy stubs are employed. The porcelain strain insulators for holding the curve are then placed either on the line poles or on the guy stubs, depending on which are on the outside of the curve. This construction obviates the use of compression members in any

inches long was made with two hooks hung from a bolt through the bar, one inch from its end. These hooks were so designed that they would fit under the lower edge of the bond terminal. With this device a leverage of 48 to 1 was obtained on the broad under surface of the bond terminal, so that the foreman of the bonding gang, with an ordinary single-handed pull, could bring the shearing stress on the soldered surface to approximately 1,500 pounds per square inch. If the bond stood this shearing stress a satisfactory union between the bond and the head of the steel rail was assumed. The bond terminal, when well soldered, should fall at a shearing stress of approximately 3,000 pounds per square inch.

One of the important advantages of the "G-D" bond was exemplified during construction work, i. e., the safety of this bond against ordinary derailments, even where the bolt heads had been sheared off. The car, heavily loaded, was derailed and sheared off the bolts on about 10 angle plates, but the bonds were hardly touched. The angle plates had thrown the wheels far enough away from the bonds so that the beveled edge of the bond presented no direct bearing surface for the wheel, and the bond was consequently not stripped off, only the base of the contact area being slightly marked.

During the installation of these bonds under favorable weather conditions, 14 men were able to put on from 300 to 325 bonds a day when fully supplied with material and not subject to delays.

The "G-D" bonds above described were applied during the construction period. Frequent steam construction trains were operated, and the condition of the wheels on the construction cars was bad, as is usual in such cases. No trouble with the bonds was experienced. The wedge-shaped terminals exposed so little surface on top that guttered or flat wheels would not touch them.

In addition to 16,000 "G-D" bonds placed on this road, 450 of the Ohio Brass Company's type "G-F" Form 3 bonds were used in city streets. This is the ordinary type of soldered bond placed under the fishplates.

The construction of the road was in the hands of the Willamette Construction Company, a construction organization of W. S. Barstow & Co., New York. R. L. Donald was chief engineer in charge and F. S. Drake superintendent of construction.

#### SOLENOIDS AND MAGNETS FOR SPECIAL USES.

In electric railway work there are many automatic and labor-saving devices. Quite a number of these are, or might well be, controlled electrically. Frequently various switches, regulators, dampers and similar devices are made in local shops and for their operation electrical circuits are wired so that the apparatus may be remotely controlled. It is not uncommon that electro-magnets are used for the distant means of control when solenoids would answer the purpose much better and be cheaper to install. It is also true that both magnets and solenoids would doubtless be used to a greater extent in home-made devices if it were feasible to properly construct them so that they would perform their duties more reliably. Frequently when a solenoid for a special duty is needed there is no engineer available to immediately make the calculations as to the necessary length and diameter required and the amount and kind of wire to be used, so that the coil will perform its exact duty and neither overheat nor waste power.

The usual method followed in building such a coil is to design it by guesswork and it may be said that nine times out of ten the resulting solenoid will not exactly meet the conditions. It probably is found that although the solenoid and plunger have sufficient travel and lift, they will become useless from overheating, due to the unfamiliarity of the designer with this class of work.

Solenoids and magnets can be constructed by rule and their characteristics determined exactly. Such coils can be built to do the required work without the assistance of levers, cogs, etc., so that the power can be exerted direct. Frequently a well-designed coil will in this manner do away with many small mechanical parts otherwise found necessary. The mechanic or inventor who may be desirous of using a quick operated electrical device remotely controlled will find a valuable assistant in the solenoid or magnet which his ability may not warrant him in attempting to construct.

The Porter Manufacturing Company, 29 Griswold street, Detroit, Mich., is a specialist in the construction of solenoid and magnet coils. This company builds the coils according to definite specifications and is ready to guarantee that the finished coil will be the minimum size to perform the work required with the stated current and pressure.

The specifications necessary to be given when solenoids are to be designed follow: 1. Maximum and minimum voltage of current to be used. 2. Travel of the armature or plunger. 3. Pull to be exerted. 4. Maximum time the current is to be

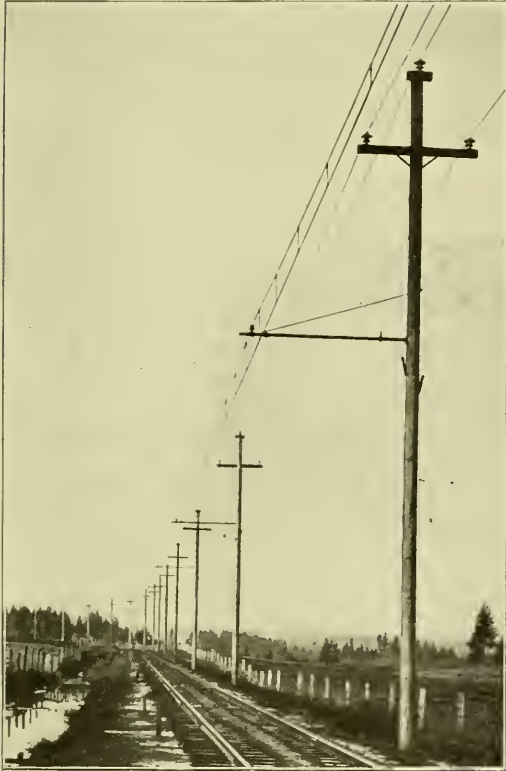

Oregon Electric Railway—Overhead Construction on Tangent.

part of the catenary—a very desirable feature in a high-speed interurban road.

The accompanying illustrations, showing the details of overhead construction on curves and tangents, were made from photographs taken before the ballast was placed on the roadbed.

#### Track Bonding.

The bonds used on the new road are Ohio Brass Company's type "G-D," sold through Pierson, Roeding & Co., Pacific coast agents. These are soldered to the ball of the rail. This bond is made of a continuous copper strip wound in a flat coil at the ends and formed so as to have a wedge-shaped terminal at each end. The completed bond is of the general shape of the letter "U." The terminals are formed with small ridges on the surface which is applied to the rail. These ridges hold the bond away from the rail slightly, so as to form a pocket for the solder.

An item of interest in connection with the bonding work was the method of testing the bonds immediately after installation, and as soon as the rail had cooled. A steel bar 48

fed to the coils. 5. Intervening time between operation of the coils. These are simple specifications that anyone desiring a coil can easily determine and it is said that with these few characteristics at hand solenoids and magnets can be designed for a variety of purposes not generally known.

#### NEW CARS FOR THE PITTSBURG HARMONY BUTLER & NEW CASTLE RAILWAY.

The Pittsburg Harmony Butler & New Castle Railway of Pittsburg, Pa., which now has under construction a line to connect the cities named in the title, has recently received from the St. Louis Car Company 12 single-end combination passenger, smoking and baggage compartment cars, one of which is illustrated in the accompanying halftone engraving.

Some of the principal dimensions are as follows:

Total length, 46 feet; rear platform, 4 feet 5 inches; main passenger compartment, 22 feet 9½ inches; smoking compartment, 7 feet 8½ inches; baggage compartment, 10 feet 4 inches, including motorman's cab.

The cars are of the St. Louis Car Company's semi-steel frame construction. The side sills are composed of 5 by 8 inch yellow pine, reinforced with 6 by 8 inch channels, the center sills of 6-inch I-beams, weighing 12¼ pounds per foot, with yellow pine fillers. The intermediate sills are of yellow pine, 4½ by 6 inches; the end sills are of 6 by 8 inch



New Car for the Pittsburg Harmony Butler & New Castle Railway.

oak, and the platform sills, of which there are four at the rear end, are of 3¼ by 8 inch oak, reinforced by 6 by 1 inch plates, extending from the bumpers through the bolsters. The bolsters are of the trussed type, made of ¾ by 10 inch and 1 by 10 inch steel plates. All sills extend through from the end sill at the rear to the bumper at the front end, there being only a drop at the rear end.

The sides are constructed with 12 window sashes and one baggage door. The lower sashes are arranged to raise, while the upper sashes are of Gothic design and are stationary, extending over the two lower sashes. The side sashes are glazed with plate glass and the upper and deck sashes with opalescent glass.

In the regular passenger compartment are 15 St. Louis Car Company's stationary seats, upholstered in brown plush with high head roll. The saloon is located in the rear of this compartment. A water cooler is set in an alcove from the outside. The side walls of the saloon are covered with mottled up to the window capping. The smoking compartment has six stationary seats, upholstered in dark green leather. The baggage compartment has three folding seats to be used when there is no baggage to be cared for. Parcel racks are placed in the main and smoking compartments.

An iron pipe railing separates the motorman's cab from the baggage compartment. A hot water heater is placed on the left side of the motorman.

The interior finish of the main compartment is mahogany with inlaid marquetry decoration. The ceilings are semi-empire, finished in pea green, with gold ornamentations.

Illuminated signs, vertical brake wheels and self-releas-

ing brake handles, all furnished by the St. Louis Car Company, are included in the equipment, and the cars are mounted on high-speed trucks, with air brakes and air sanders.

#### NEW WESTON INSTRUMENTS.

The Weston Electrical Instrument Company, Newark, N. J., has recently developed and perfected a number of new measuring instruments. Among these are two new lines intended for use as ammeters and voltmeters on direct-current switchboards, designated as the Eclipse. These are of the soft iron or electro-magnetic type, and were given the name Eclipse to avoid confusing them with the Weston permanent magnet switchboard instruments. The features to which attention is especially directed are the absence of working error, chamber error and magnetic lag.

Other new lines are the Model 151 voltmeter and Model 156 ammeter for alternating-current switchboards. The claims made for these instruments are that they have no inductance error, no discernible working error, no chamber error, that they are entirely dead-beat and have remarkably uniform scales.

New portable alternating-current voltmeters and ammeters are designated as Model 155. The voltmeters for potentials up to and including 300 volts are 7 by 7½ by 3¼ inches. Those for higher potentials up

to 750 volts are 7½ by 8¾ by 3¼ inches. The ammeters and mill-ammeters have the same dimensions as the smaller size of voltmeter. The portable ammeters include instruments adapted to give a full scale deflection with one ampere and instruments adapted to give full scale deflection with 300 amperes. They may be used on alternating circuits having a potential difference not greater than 2,300 volts; above this current transformers must be used. The same claims for accuracy are made for portable instruments as for the others to which reference has been made.

Another new instrument is a wire chief's voltmeter intended for use in telephone exchanges. A specialty for use in switchboard work is the new design of Weston swinging bracket, which is composed of three main parts—a bracket plate to be bolted to the angle iron frame or face of the switchboard; a swinging arm which is supplied in lengths of 15 or 24 inches, according to conditions, and one of a series of sliding adapters which vary in shape and size to conform to the dimensions of the instrument to be attached.

The Boston Elevated Railway will begin construction of the terminal station for its new Forest Hills elevated extension, in Forest Hills square, about the middle of March. Steel for this work has been ordered and is on the way to Boston. The station was approved a number of weeks ago by the railroad commission as a temporary affair, because plans for connection with the Boston & Providence Interurban Electric Railroad at or near this point have not yet become sufficiently definite to allow the permanent form of terminal to be fixed. Alteration of the present Dudley street terminal by adding platforms and rearranging tracks to allow way stops at that point by through Forest Hills trains, will be taken up a few weeks later. The station at Eggleston square, a way station on the extension, is about the only other large piece of construction yet to be taken up on this new line. The main structure and track are already completed from Dudley street to the edge of Forest Hills square.

The Georgia Railway & Electric Company has announced that work will be started this summer on its proposed extension to Buckhead, Ga.



# The Grip Nut

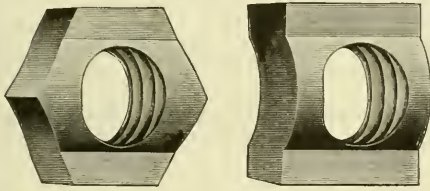

**Among the various economies and advantages of the Grip Nut are:**

Elimination of loose and lost holding nuts. Low cost. High individual load strength. Simplicity; no complexity of stock, as involved by the use of nut locks. Advantage in clearance over ordinary jam nuts. Absolute assurance of full service from holding nut, whether applied loosely or jammed up. Its "setting up" quality as elastic as a bolt thread. Reports received agree that **Grip Nuts** prolong the life of crossings, insulated joints and all equipment to which they are applied.

*Used by the United States Government.*

**Grip Nut Company**  
New York Chicago

# Equip your line with the Telegraph Signal System

—then your dispatcher will be in constant touch with every car and train on the line

—with the result that accidents will be prevented, traffic facilitated and schedules adhered to more closely



Write us for the facts

**Telegraph Signal Company**  
282 State Street - Rochester, N. Y.

# Washburn "M" Type Traction Coupler Strongest, Simplest and Cheapest Traction Coupler Ever Made

Illustration shows two "M" Type couplers on a forty-five degree curve and coupled with a short cast link as used on cars having a short wheel base. For longer cars a longer link casting is furnished, giving any amount of distance between cars, and affording the desired clearance when traveling curves.

*Ask for new catalogue of traction devices.*

**Washburn Steel Castings & Coupler Co.**  
MINNEAPOLIS, MINN.

Western Agents: Tweedy, Hood & Finlen, 2014 Fisher Bldg., Chicago Canadian Agent: John Taylor, Montreal

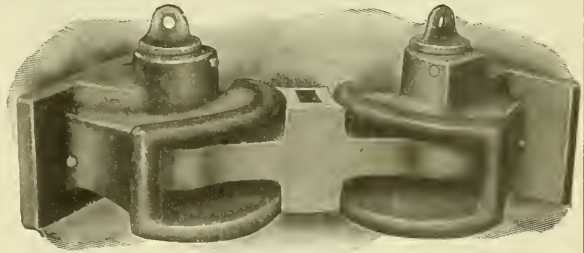

# "Not an Experiment"

The Providence Fender has been in successful operation on hundreds of roads for 13 years, and has proved itself reliable under all conditions of Street Railway service.

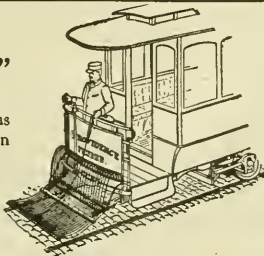

**CONSOLIDATED CAR FENDER COMPANY**

Office and Factory: PROVIDENCE, R. I.

Branch Office: 110 E. Twenty-third St., New York

European Agents: Comptoir d'Electricite, 6, Rue Boudreau, Paris, France

# ALUMINUM

## Railway Feeders

And all kinds of **Electrical Conductors**

Aluminum Feeders are less than one-half the weight of copper feeders and are of equal conductivity and strength. If installed wire or cable is required, high grade insulation is guaranteed.

*Write for prices and full information.*

**Aluminum Company of America**  
PITTSBURGH, PA.

Formerly The Pittsburgh Reduction Company

## THE J. G. BRILL COMPANY, PHILADELPHIA, PA.

AMERICAN CAR COMPANY, ST. LOUIS, MO.  
 G. C. KUHLMAN CAR COMPANY, CLEVELAND, OHIO  
 JOHN STEPHENSON COMPANY, ELIZABETH, N. J.  
 WASON MANUFACTURING CO. SPRINGFIELD, MASS.

MAIN OFFICE: PHILADELPHIA, PA.  
 LONDON OFFICE: 110 CANNON ST. E. C.  
 PACIFIC COAST AGENTS: PIERSON  
 ROEDING & CO. SAN FRANCISCO.  
 AUSTRALIAN AGENTS: NOYES  
 BROTHERS. SYDNEY. CABLES:  
 "BRILL," PHILA., "AXLES" LONDON.

*CARS TRUCKS SEATS RATTAN SPRINGS SPECIALTIES SUPPLIES*

## SAFE SUMMER SERVICE

The "Narragansett" is the right car for handling crowds safely in excursion service and is the only practical double-truck open car. The width over all is the same as a single-step open car as the upper step is on the flange of a Z-bar sill and within the line of the posts. The best possible arrangement of the running board of a single step car with the minimum height of floor is 19½ inches to board and 17 inches to floor. The same height in the "Narragansett" is divided into 16, 13 and 7½ inches. Companies which have used "Narragansett" cars for a number of years have recently reported that they have had no accidents. Women, children and elderly persons can get in and out easily and quickly. The Z-bar sills make it the strongest open car ever built. The arrangement does not reduce the length of the seats. Write for catalog.

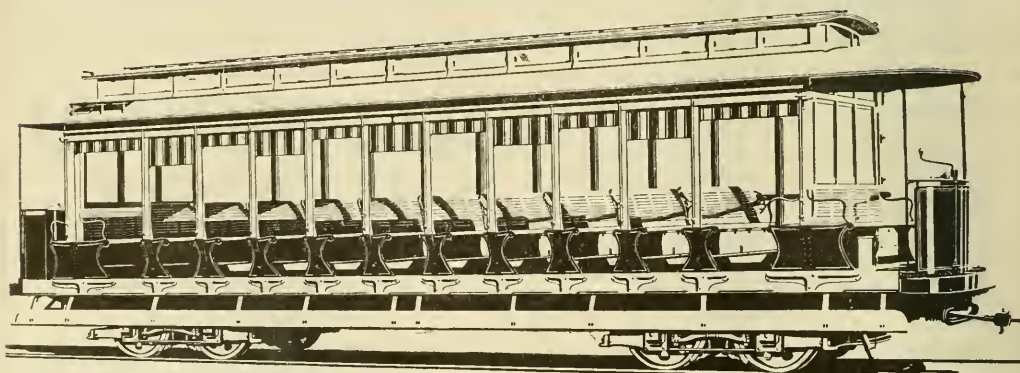

*THE BRILL "NARRAGANSETT" CAR (PATENTED)*

# General Electric Company



## Commutating Pole Railway Motors



### Mechanical Design

The superior mechanical design of G. E. Commutating Pole Railway Motors provides the most rugged and easily maintained apparatus of this nature yet developed.

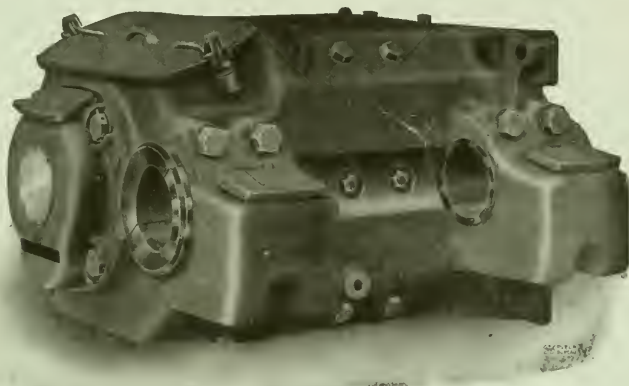

G. E. 205-100 h.p. Commutating Pole Railway Motor.

In the design of G. E. Railway Motors, special attention has been given to the subject of accessibility in regard to repairs and inspection. Conveniently placed hand-holes with gasketed covers permit easy access to commutator and brushes. In the smaller sizes the bottom part of frame swings down into pit for inspection or removal of parts. The armature in the large sizes is easily inserted or removed through the bored opening in the end of frame. All similar parts in different motors of any type are interchangeable. A readily accessible and easily handled motor means a saving of time in the repair shop.



**Quality of Equipment  
determines  
Quality of Service**



1583

**Chicago Office:**  
Monadnock Bldg.

**Principal Office:**  
**Schenectady, N. Y.**

**Sales Offices in  
all large cities**

**When buying steel measuring tapes**

for absolutely accurate work it's worth while seeing to it that they were made by

**THE LUFKIN RULE CO.**  
SAGINAW, MICH., U. S. A.

New York  
London, England  
Windsor, Canada



The  
Recording  
Fare Register  
Company



New  
Haven,  
Conn.

**VALVES—FITTINGS—STEAM SPECIALTIES**  
**CRANE CO.**  
CHICAGO  
ESTABLISHED 1855

**HOPE TAPES AND WEBBINGS**  
ARE THE BEST  
WRITE FOR SAMPLES AND PRICES  
HOPE WEBBING CO., Providence, R. I.

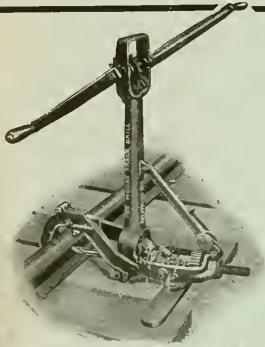

**The Moore Track Drill**

does not interfere with traffic!

The shifting of one lever and a few seconds' time takes down the drill—the operation reversed makes it ready for work again.

This is only one of the many strong points about the Moore Track Drill that make it worth buying.

*Ask for descriptive catalogue.*

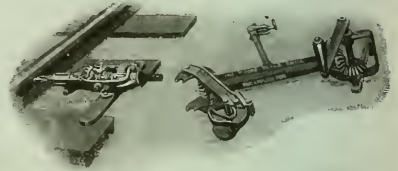

**Kalamazoo Railway Supply Co.** Kalamazoo Michigan

THE  
**SYMINGTON JOURNAL BOX**  
FOR ELECTRIC TRUCKS

Now Standard on the Majority of Modern Electric Trucks of M. C. B. or Special Type

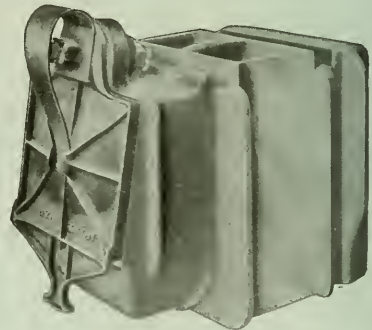
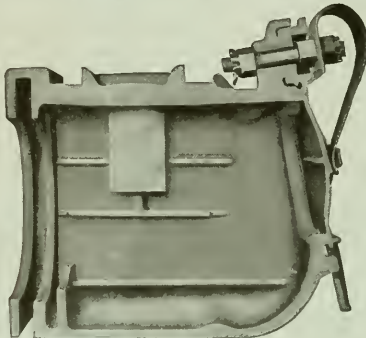

**Special Notice!**

WE ARE PREPARED TO FURNISH AT ONCE  
THE **STANDARD JOURNAL BOXES** OF  
THE AMERICAN STREET AND INTERURBAN RAILWAY ASSOCIATION

BALTIMORE  
MD.

**THE T. H. SYMINGTON CO.**

CHICAGO  
ILL.

# Electric Railway Review

PUBLISHED EVERY SATURDAY.

FORMERLY THE STREET RAILWAY REVIEW.

THE WILSON COMPANY, CHICAGO.

160 Harrison Street, Chicago  
150 Nassau Street, New York  
1529 Williamson Bldg., Cleveland

VOL. XIX  
No. 9

CHICAGO, FEBRUARY 29, 1908

Whole No.  
253

Subscription: Domestic . . . \$2  
Foreign . . . \$5  
Canada . . . \$3.50

## An Unusual Opportunity

presents itself right now to business men who have sufficient brain and nerve to determine upon a proper course of action and then stick to it until success is achieved!

The plain facts are that many supply houses in every line have deemed it wise to let electric railway buyers get the impression that they are no longer alive and keen for business. These supply houses have done this in different ways, but principally by discontinuing their advertising on the mistaken theory that the electric railways of America have ceased buying permanently.

Nothing could be further from the facts, for these electric railways will carry more passengers in more cars over more miles of track in 1908 than ever before. This means a good business—better than the average year—for the supply houses.

Now, if these things are true—and any level-headed optimist will agree that they are true—there could not possibly be a better opportunity for men of brain and nerve to gain pre-eminence in the electric railway supply business.

And the *first step* in gaining pre-eminence is *to command the attention* of electric railway buyers. The most effective and the least expensive way of accomplishing this, and at the same time securing standing and prestige, is by doing *real* advertising. And this means telling the facts back of your goods sensibly, attractively and persistently in the

## Electric Railway Review

*The way is clear—the door is open—why not enter and progress toward pre-eminence in your chosen field?*

## Railway Motor Armature Coils

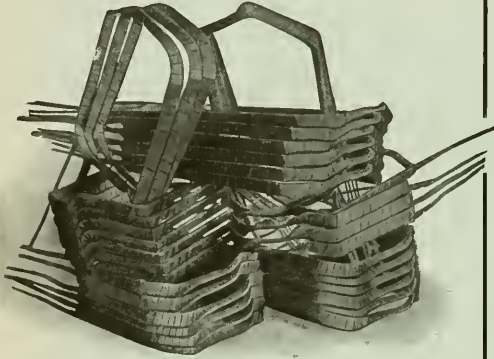

We make them, and make them right, at a fair price  
Tell us your needs and we'll tell you the price

### Cleveland Armature Works

Cleveland, Ohio

America's Greatest Armature Winding, Commutator and Field Works

13

## TRADE **WALKOVER** MARK Car Seat

Gives more room, more comfort, and more money value than any other seat made.

No. 99A  
In Rattan



Notice its superior construction and substantial appearance. Specify and insist on our seats for your new Electric Cars; they cost less, in the end, than the worthless imitations sometimes offered instead.

### The Hale & Kilburn Mfg. Co.

PHILADELPHIA

NEW YORK

CHICAGO

WASHINGTON

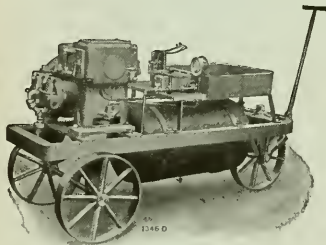

Portable Outfit with A-1 Compressor

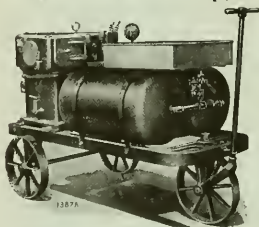

Portable Outfit with CC-3 Compressor

## National Portable Air Compressor Outfits

are especially adapted for service in car shops where compressed air is used for various operations such as drilling, chipping, riveting and for blowing dust and other matter out of car motors, car seats, etc. They are built in capacities of from 11 to 50 cubic feet of free air per minute. The 11 and 35 cubic foot sizes are illustrated herewith.

The small width of National Portable Outfits permits of their being taken through doors and other openings of much smaller width than the average.

Bulletin Sent on Request

## National Brake & Electric Co.

NEW YORK: 111 Broadway  
PHILADELPHIA:  
W. H. Goble, 1722 Westmoreland St.  
BOSTON: F. E. Huntress, 131 State St.

Milwaukee, U. S. A.

SAN FRANCISCO, CAL.: W. F. McKenny,  
69-71 First Street  
LONDON: 14 Great Smith St., Westminster

General Sales Office: 519 First National Bank Building, Chicago

# Westinghouse

## Steam Turbines

### Long Runs

In a Western manufacturing plant an inspection was recently made of a 500 K. W. Westinghouse Turbine Generating Unit, which had been in operation twenty-four hours a day for four months under almost continuous overloads. The machine was found to be in excellent condition ready for another protracted run. Over a dozen other satisfied purchasers have reported runs of equal or greater length.

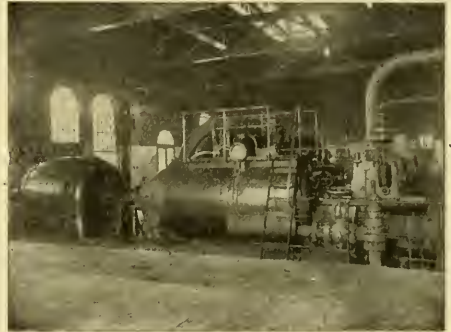

For particulars, Catalogue 7002.

## The Westinghouse Machine Co.

Steam Turbines, Steam Engines, Gas Engines, Gas Producers, Storage Batteries and The Roney Stoker

New York, 10 Bridge Street  
Boston, 131 State Street  
Atlanta, Candler Building  
St. Louis, Chemical Building

Pittsburg, Westinghouse Building  
Cleveland, New England Building  
Chicago, 171 La Salle Street  
Cincinnati, Traction Building

Philadelphia, North American Building  
Denver, McPhee Building  
San Francisco, Hunt, Mirk & Co.



### Portable Meters

Ammeters, Voltmeters, Single and Polyphase Wattmeters; Single and Polyphase Power-Factor Meters; Frequency Meters; Lamp Testing Volt-Wattmeters; Rotating Standard Integrating Wattmeters; Series and Voltage Transformers.

Will do the work of two of any other make

Circular 1104 gives particulars.

### Westinghouse Electric & Mfg. Co.

Atlanta Cincinnati Kansas City New York Salt Lake City  
Baltimore Cleveland Los Angeles Philadelphia San Francisco  
Boston Dallas Minneapolis Pittsburg Seattle  
Buffalo Denver New Orleans St. Louis Syracuse  
Chicago Detroit Mexico: G. & O. Braniff & Co., City of Mexico  
Canada: Canadian Westinghouse Co., Ltd., Hamilton, Ont.



### To Maintain Fast Schedules

and close headways, air brakes are absolutely essential; with hand brakes it is impossible, owing to the extra caution required in operation and additional time required in stopping cars. No other brake possesses so many valuable features as the Westinghouse "A M M" automatic, graduated-release, quick-recharge, quick-service, high-pressure emergency brake for 1,2,3,4 and 5 car train service.

Instruction Pamphlet No. T-5031 gives a detailed and fully illustrated description of the A. M. M. Equipment.

Westinghouse Traction Brake Co.  
PITTSBURG, PA.

## ALPHABETICAL INDEX TO ADVERTISEMENTS.

Advance Lumber Co. ....24	Drummond Detective Agency.30	Model Stoker Co. ....23	Speer Carbon Co. ....23
Allis-Chalmers Co. ....19	Eclipse Railway Supply Co. ....18	Morden Frog & Crossing Wks. .	Standard Brake Shoe Co. ....23
Aluminum Co. of America, .	Electric Railway Equipment .	National Brake & Electric Co. 2	Standard Motor Truck Co. ....14
Co. ....30	Electric Ry. Improvement Co.26	National Lock Washer Co. ....30	Standard Paint Co. ....21
American Electrical Works.30	Electric Service Supplies Co.,	National Pole Co. ....24	Standard Steel Works. ....13
American Frog & Switch Co.24	Engineers and Contractors.22	Naugle Pole & Tie Co. ....24	Standard Underground Cable
Anderson, Albert & J. M.,	Fairbanks, Morse & Co. ....	New York Switch & Crossing	Co. ....23
Mfg. Co. ....17	Ford, Bacon & Davis. ....	Co. ....	Standard Varnish Works. ....22
Armstrong Oiler Co. ....21	Galena-Signal Oil Co. ....11	Niles Car & Mfg. Co. ....15	Star Brass Works. ....18
Arnold Company ....18	General Electric Co. ....29	Northern Engineering Works. .	Stone & Webster Engineering
Atlas Anchor Co. Shoe & Fdry. .	Goldschmidt Thermit Co. ....23	Nuttall, R. D., Co. ....	Corporation ....22
Automatic Trolley Guard Co. 5	Green Engineering Co. ....25	Ohio Brass Co. ....	Stuart-Howland Co. ....
Babcock & Wilcox Co. ....12	Green Fuel Economizer Co. ....	Okonite Co., Ltd. ....11	Symington, T. H., Co. ....27
Baker, Wm. C., Heating &	Griffin Wheel Co. ....33	Pacific Coast Pole Co. ....24	Telegraph Signal Co. ....19
Supply Co. ....15	Hagy, J. Milton, Waste Wks. .12	Pantasote Co. ....25	Trolley Supply Co. ....
Baldwin Locomotive Works.18	Hale & Kilburn Mfg. Co. ....	Patten, Paul B. .	Under-Feed Stoker Co. ....18
Barbour-Stockwell Co.	Hartshorn, Stewart, Co. ....22	Pay-As-You-Enter Car Co. ....9	United States Graphite Co.,
Barnes, G. H., Hardwood	Heine Safety Boiler Co. ....21	Porter Mfg. Co. ....23	U. S. Metal & Mfg. Co. ....13
Lumber Co. ....24	Heywood Bros. & Wakefield	Pressed Steel Car Co. ....25	Van Dorn & Dutton Co. ....23
Beidler, Francis & Co. ....22	Co. ....	Queen & Co. ....17	Van Dorn, W. T., Co. ....25
Bellamy Vestette Mfg. Co. ....22	Holman, D. F., Ry. Tracklayer	Rail Joint Co. ....23	Van Valkenburg, E. C. ....23
Berthold & Jennings. ....	Co. ....22	Railway Specialty & Supply	Wanted and For Sale Cards. .
Blake Signal & Mfg. Co. ....	Humbird Lumber Co., Ltd. ....24	Co. ....23	20, 21
Bliss, R. Mfg. Co. ....15	Indestructible Fibre Co. ....	Railway Steel-Spring Co. ....25	Washington Steel Castings &
Bridgeport Brass Co. ....	Jewett Car Co. ....15	Recording Fare Register Co. ....30	Chaulper Co. ....27
Brill, J. G., Co. ....28	Johann, F. A. ....21	Register, A. C., & Co. ....22	Watson-Stillman Co. ....30
Brown, Harold P., Co. ....19	Johns-Manville, H. W., Co. 5	Reiter, G. ....22	Wendell & MacDuffie. ....
Brown Hoisting Machy. Co. ....22	Joseph, Isaac, Iron Co. ....21	Ridlon, Frank, Co. ....19	Western Electric Co. ....5
Buckeye Engine Co. ....	Kalamazoo Ry. Supply Co. ....27	Roberts & Abbott Co. ....22	Westinghouse Elec. & Eng'g
Burnham, Williams & Co. ....18	Kinnear Manufacturing Co. ....26	Robertson, Wm., & Co. ....19	Co. ....3
Bylesby, H. M., & Co. ....22	Linsley Bros. Co. ....24	Rodger Ballast Car Co. ....22	Weston Electrical Instrument
Central Inspection Bureau. ....22	Lorain Steel Co. ....18	Rooke Automatic Register Co. ....13	Co. ....17
Chase-Shawmut Co. ....11	Lord & Burnham Co. ....25	Rossiter, MacGovern & Co.	Wharton, Wm., Jr., & Co. ....
Churchill Cedar Co. ....24	Lubin Rule Co. ....39	(Inc. ....21	Wheeler, J. W., & Co. ....22
Cincinnati Car Co. ....	Lumen Bearing Co. ....23	Russell Car & Snow-Plow Co.21	Co. ....22
Cleveland Armature Works. 2	Macallen Co. ....	S.-E. Missouri Cypress Co. ....24	Wheel Truing Brake Shoe
Cleveland Frog & Cross. Co.24	McGuire-Cummings Mfg. Co.18	St. Louis Car Co. ....7	Co. ....17, 23
Collier, Barron G. ....23	Marshall, R. W., & Co. ....95	St. Louis Car Wheel Co. ....23	Whitmore Mfg. Co. ....17
Columbia Construction Co. ....	Massachusetts Chemical Co.12	St. Louis Surfacar & Paint	Wilson, J. G., Mfg. Co. ....26
Consolidated Car Pender Co.19	Meyers, Fred J., Mfg. Co. ....22	Co. ....	Wood, Guilford S., Co. ....12
Consolidated Car-Heating Co.23	Miller Anchor Co. ....18	Sanderson & Porter. ....12	Woodman, R. Mfg. & Supply
Contractors' Supply & Equip-	Milloy Electric Co. ....30	Shimer & Chase Co. ....22	Co. ....
ment Co. ....	Belts and Gongs—Continued.	Sheaff & Jastaad. ....18	Worcester, C. H., Co. ....24
Cooper Heater Co. ....17	McGuire-Cummings Mfg. Co.,	Simmons, John, Co. ....18	Zelnicke, Walter A., Supply
Crane Co. ....23	Chicago. ....	Smith, Peter, Heater Co. ....23	Co. ....21
Craghead Engineering Co. ....32	Ohio Brass Co., Mansfield, O.		
Curtain Supply Co. ....22	Reiter, G. C., Canton, O.		
Davis, John, Co. ....13	St. Louis Car Co., St. Louis,		
Dearborn Drug & Chemical	Mo. ....		
Works ....17	Stephenson, John, Co., Eliza-		
Drouvé, G., Co. ....	beth, N. J. ....		
	Wason Mfg. Co., Springfield,		
	Mass. ....		
	Western Electric Co., Chicago.		

## CLASSIFIED LIST OF ADVERTISERS.

Advertising Service.	Asbestos Materials.	Bells and Gongs—Continued.	Bonds, Rail—Continued.
Van Valkenburg, E. C., 2117	Johns-Manville, H. W., Co.,	McGuire-Cummings Mfg. Co.,	Goldschmidt Thermit Co., 43
West One Hundred and Second	New York.	Chicago.	Exchange Pl., New York.
St., Chicago.	Axles—(See Wheels and Axles).	Ohio Brass Co., Mansfield, O.	Johns-Manville, H. W., Co.,
Advertising, Street Car.	Babbitt Metals—(See Alloys and	Reiter, G. C., Canton, O.	New York.
Collier, Barron G., Flat Iron	Bearing Metals).	St. Louis Car Co., St. Louis,	Ohio Brass Co., Mansfield, O.
Bldg., New York.	Badges and Buttons.	Mo. ....	Brackets and Cross Arms.
Air Brakes—(See Brakes and	Electric Service Supplies Co.,	Stephenson, John, Co., Eliza-	Anderson, Albert & J. M.,
Brake Parts).	200 Plymouth Bldg., Chicago.	beth, N. J. ....	Mfg. Co., Boston
Air Compressors—(See Com-	Recording Fare Register Co.,	Mass. ....	Craghead Engineering Co.,
pressors, Air).	New Haven, Conn.	Western Electric Co., Chicago.	Cincinnati, O.
Alloys and Bearing Metals.	Ballast Cars—(See Cars, Bal-	Black Lead.	Electric Railway Equipment
Brown, H. P., 120 Liberty St.,	last).	U. S. Graphite Co., Saginaw,	Co., Cincinnati, O.
New York.	Ball Bearings.	Mich. ....	Electric Service Supplies Co.,
General Electric Co., Schene-	Symington, T. H., Co., Balti-	Block System—(See Signals).	200 Plymouth Bldg., Chicago.
cady, N. Y.	more, Md.	Blowers—(See Mechanical Draft)	Johns-Manville, H. W., Co.,
Lumen Bearing Co., Buffalo,	Bases—(See Trolley Poles and	Blue Printing Machines.	New York, N. Y.
N. Y.	Fittings).	Buckeye Engine Co., Salem, O.	Linsley Bros. Co., Spokane,
Ohio Brass Co., Mansfield, O.	Bearings.	Boilers.	Wash.
Ridlon, Frank, Co., 200 Sum-	Electric Service Supplies Co.,	Babcock & Wilcox Co., N. Y.	Ohio Brass Co., Mansfield, O.
mer St., Boston.	200 Plymouth Bldg., Chicago.	Fairbanks, Morse & Co., Chi-	Ridlon, Frank, Co., 200 Sum-
St. Louis Car Co., St. Louis,	General Electric Co., Schene-	cago.	mer St., Boston.
Mo.	cady, N. Y.	Green Fuel Economizer Co.	Western Electric Co., Chicago.
Aluminum Wire, Etc.	Lumen Bearing Co., Buffalo,	Matteawan, N. Y.	Brakes and Brake Parts.
Aluminum Co. of America,	N. Y.	Heine Safety Boiler Co., 421	Allis-Chalmers Co., Milwau-
Pittsburg.	McGuire-Cummings Mfg. Co.,	Olive St., St. Louis.	kee, Wis.
Anchors.	Chicago.	Lord & Burnham, Irvington-	American Car Co., St. Louis.
Atlas Anchor Co., Cleveland, O.	Chicago.	on Hudson, New York.	Bril, The J. G., Co., Phila-
Electric Service Supplies Co.,	Marshall, R. W., & Co., 95	Boiler Cleaning Compound.	delphia.
200 Plymouth Bldg., Chicago.	Liberty St., New York.	Dearborn Drug & Chemical	Electric Service Supplies Co.,
Müller Anchor Co., Norwalk, O.	Nuttall, R. D., Co., Pittsburg.	Works, Chicago.	200 Plymouth Bldg., Chicago.
Ohio Brass Co., Mansfield, O.	Ohio Brass Co., Mansfield, O.	Johns-Manville, H. W., Co.,	General Electric Co., Schene-
Armatures and Coils, Winding	Ridlon, Frank, Co., 200 Sum-	New York.	cady, N. Y.
and Repairing.	mer St., Boston.	Bonds, Rail.	Kuhlman, The G. C., Car Co.,
Cleveland Armature Works,	Symington, T. H., Co., Balti-	Brown, H. P., 120 Liberty St.,	Cleveland.
Cleveland, O.	more, Md.	New York.	McGuire-Cummings Mfg. Co.,
Electric Service Supplies Co.,	Van Dorn & Dutton Co.,	Chase-Shawmut Co., New-	Chicago.
200 Plymouth Bldg., Chicago.	Cleveland, O.	buryport, Mass.	National Brake & Electric Co.,
General Electric Co., Schene-	Belts and Gongs.	Electric Railway Improvement	Milwaukee.
cady, N. Y.	American Car Co., St. Louis.	Co., Cleveland, O.	Stephenson, John, Co., Eliza-
Marshall, R. W., & Co., 95	Brill, The J. G., Co., Phila-	Electric Service Supplies Co.,	beth, N. J.
Liberty St., New York.	delphia.	200 Plymouth Bldg., Chicago.	Wason Mfg. Co., Springfield,
Ridlon, Frank, Co., 200 Sum-	Electric Service Supplies Co.,	General Electric Co., Schene-	Mass.
mer St., Boston.	100-24 Filbert St., Phila.	cady, N. Y.	Westinghouse Traction Brake
Stuart-Howland Co., Boston.	Kuhlman, The G. C., Car Co.,		Co., Pittsburg, Pa.
Armature Lifts.	Cleveland.		Brakeshoes.
Electric Service Supplies Co.,			American Brake Shoe & Fdry.
200 Plymouth Bldg., Chicago.			Co., Mahwah, N. J.
			American Car Co., St. Louis.
			Barbour-Stockwell Co., Cam-
			bridgeport, Mass.



*"It puts the wheel on the wire"*

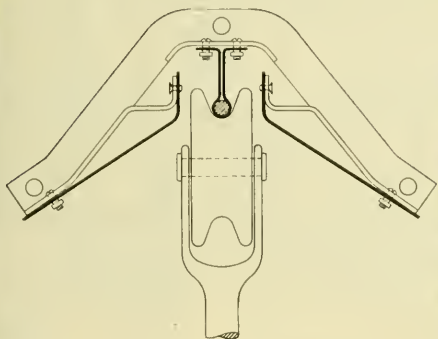

# Automatic Trolley Guard

is just the device you have been looking for to enable your motormen to have absolute control of cars at dangerous places.

Its use positively prevents accidents and delays due to wild trolley poles at steam railway crossings, subway and under crossings, and on curves, bridges, etc. Its installation in car houses will prevent fires and reduce insurance.

Automatic Trolley Guard furnishes perfect constant contact; cannot arc or burn; has no unraveling material; is light, rigid, strong; is of sectional construction, making handling and erection easy; is adaptable to any curve or radius; permits trolley wheel to rotate freely without striking sides.

May we send you a list of roads upon which the Automatic Trolley Guard is in successful service?

**Automatic Trolley Guard Co.**  
391-393 ELLICOTT SQUARE  
Buffalo, N. Y.

## A Remarkable Tape



Jomanco is a remarkable friction tape because:

A magnifying glass won't show any lumps.

A strong light won't show any pin holes.

A strip will hold 50 pounds weight by its own friction.

Every roll of

### JOMANCO

contains just the yardage you pay for.

Examine hundreds of rolls and you will find one just the same as the other.

Try it and see. We'll send you a sample without charge.

Write nearest Branch for sample and booklet of Jomanco Tape.

**H. W. JOHNS-MANVILLE CO.**



NEW YORK  
MILWAUKEE  
CHICAGO  
BOSTON  
PHILADELPHIA  
ST. LOUIS

PITTSBURG  
CLEVELAND  
BUFFALO  
BALTIMORE  
NEW ORLEANS  
KANSAS CITY

MINNEAPOLIS  
SAN FRANCISCO  
LOS ANGELES  
SEATTLE  
DALLAS  
LONDON 751

## WESTERN ELECTRIC

CHICAGO DENVER PITTSBURG SAINT PAUL NEW YORK  
ST. LOUIS CINCINNATI KANSAS CITY ATLANTA  
SAN FRANCISCO SEATTLE SALT LAKE CITY LOS ANGELES PHILADELPHIA

Write this down  
on your memorandum pad

Western Electric Company carries in stock a complete line of Trolley Overhead Material and Electric Street Railway Supplies insulated with the well known

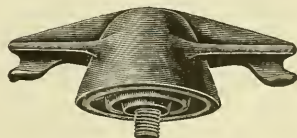

TRADE  
**ELECTROSE**  
MARK.

INSULATION

Prompt deliveries on your largest orders

## CLASSIFIED LIST OF ADVERTISERS—Continued.

- Brakeshoes—Continued.**  
Brill, The J. G. Co., Philadelphia.  
Kuhlman, The G. C., Car Co., Cleveland.  
McGuire-Cummings Mfg. Co., Chicago.  
Marshall, R. W. & Co., 95 Liberty St., New York.  
St. Louis Car Co., St. Louis, Mo.  
Standard Brake Shoe Co., Aurora, Ill.  
Stephenson, John, Co., Elizabeth, N. J.  
Wason Mfg. Co., Springfield, Mass.  
Wharton, Wm., Jr., & Co., Philadelphia.  
Wheel Truing Brake Shoe Co., Detroit.
- Bridges.**  
Johann, F. A., 1624 Pierce Bldg., St. Louis.
- Bridge Timbers.**  
Beidler, Francis, & Co., Chgo.
- Brushes, Motor and Dynamo.**  
Electric Service Supplies Co., 200 Plymouth Bldg., Chicago.  
General Electric Co., Schenectady, N. Y.  
Ridlon, Frank, Co., 200 Summer St., Boston.  
Speer Carbon Co., St. Marys, Pa.
- Bumpers, Car.**  
American Car Co., St. Louis.  
Brill, The J. G. Co., Philadelphia.  
Kuhlman, The G. C., Car Co., Cleveland.  
St. Louis Car Co., St. Louis, Mo.  
Stephenson, John, Co., Elizabeth, N. J.  
Wason Mfg. Co., Springfield, Mass.
- Car House Doors.**  
Kinnear Mfg. Co., Columbus, O.  
Wilson, J. G., Mfg. Co., New York.
- Car Replacers.**  
Electric Service Supplies Co., 200 Plymouth Bldg., Chicago.  
Fairbanks, Morse & Co., Chgo.  
Kalamazoo Railway Supply Co., Kalamazoo, Mich.  
Ohio Brass Co., Mansfield, O.  
U. S. Metal & Mfg. Co., 25 Broad St., New York.
- Car Roof Paint, Canvas.**  
St. Louis Surfacor & Paint Co., St. Louis, Mo.
- Car Seats.**  
American Car Co., St. Louis.  
Brill, The J. G. Co., Philadelphia.  
Hale & Kilburn Mfg. Co., Philadelphia.  
Heywood Bros. & Wakefield Co., Wakefield, Mass.  
Kuhlman, The G. C., Car Co., Cleveland.  
St. Louis Car Co., St. Louis, Mo.  
Stephenson, John, Co., Elizabeth, N. J.  
Wason Mfg. Co., Springfield, Mass.
- Car Signs—(See Signs, Cars and Track).**
- Car Steps.**  
Electric Service Supplies Co., 200 Plymouth Bldg., Chicago.
- Car Trimmings—(See Trimmings, Car).**
- Cars, Ballast.**  
Rodger Ballast Car Co., Chgo.  
St. Louis Car Co., St. Louis, Mo.
- Cars, Dump.**  
Fairbanks, Morse & Co., Chgo.  
Rodger Ballast Car Co., Chgo.  
Russell Car & Snow-Plow Co., Ridgway, Pa.  
St. Louis Car Co., St. Louis, Mo.
- Cars, Passenger and Freight.**  
American Car Co., St. Louis.  
Brill, The J. G. Co., Philadelphia.  
Cincinnati Car Co., Cincinnati.  
Detroit Carbuilding & Equipment Co., Detroit, Mich.  
Electric Railway Improvement Co., Cleveland, O.  
Fairbanks, Morse & Co., Chgo.  
Jewett Car Co., Newark, O.  
Johann, F. A., 1624 Pierce Bldg., St. Louis.
- Cars, Passenger and Freight—Continued.**  
Kuhlman, The G. C., Car Co., Cleveland.  
McGuire-Cummings Mfg. Co., Chicago.  
Niles Car & Mfg. Co., Niles, O.  
Pressed Steel Car Co., Pittsburg.  
Rodger Ballast Car Co., Chgo.  
Russell Car & Snow-Plow Co., Ridgway, Pa.  
St. Louis Car Co., St. Louis, Mo.  
Standard Motor Truck Co., Pittsburg.  
Stephenson, John, Co., Elizabeth, N. J.  
Wason Mfg. Co., Springfield, Mass.
- Cars, Pay-As-You-Enter.**  
Pay-As-You-Enter Car Co., 26 Cortland St., New York.
- Cars, Rebuilt.**  
Detroit Carbuilding & Equipment Co., Detroit, Mich.
- Cars, Second-Hand.**  
Detroit Carbuilding & Equipment Co., Detroit, Mich.  
Marshall, R. W. & Co., 95 Liberty St., New York.  
Zelnicke, Walter A., Supply Co., St. Louis.
- Cars, Steel.**  
Pressed Steel Car Co., Pittsburg.  
St. Louis Car Co., St. Louis, Mo.  
Standard Motor Truck Co., Pittsburg.
- Castings, Brass.**  
Star Brass Works, Kalamazoo, Mich.
- Castings, Iron and Steel.**  
American Brake Shoe & Foundry Co., Mahwah, N. J.  
Green Engineering Co., Com'l Nat. Bk. Bldg., Chicago.  
Lorain Steel Co., Johnstown, Pa.  
National Brake & Electric Co., Milwaukee.  
Washburn Steel Castings & Coupler Co., Minneapolis.
- Catchers—(See Trolley Retrievers and Catchers).**
- Cattle Guards.**  
Fairbanks, Morse & Co., Chgo.
- Cements, Cable and Transformer.**  
Massachusetts Chemical Co., Walpole, Mass.
- Circuit-Breakers.**  
Electric Service Supplies Co., 200 Plymouth Bldg., Chicago.  
General Electric Co., Schenectady, N. Y.  
Western Electric Co., Chicago.
- Coal Handling Machinery—(See Conveyors).**
- Colls—(See Armatures and Colls).**
- Commutators and Parts.**  
Cleveland Armature Works, Cleveland.  
Electric Service Supplies Co., 1020-24 Filbert St., Phila.  
General Electric Co., Schenectady, N. Y.  
Marshall, R. W. & Co., 95 Liberty St., New York.  
Ohio Brass Co., Mansfield, O.  
Stuart-Howland Co., Boston.
- Compressors, Air.**  
Fairbanks, Morse & Co., Chgo.  
General Electric Co., Schenectady, N. Y.  
National Brake & Electric Co., Milwaukee.  
Westinghouse Tracton Brake Co., Pittsburg.
- Concrete Mixers.**  
Contractors' Supply & Equip. Co., Chicago.
- Condensers.**  
Wheeler Con. & Eng. Co., New York.
- Corduits.**  
Electric Service Supplies Co., 200 Plymouth Bldg., Chicago.  
Western Electric Co., Chicago.
- Contractors.**  
Arnold Company, 181 La Salle St., Chicago.  
Byles, H. M., Co., Am. Trust Bldg., Chicago.  
Columbia Construction Co., Milwaukee, Wis.  
Creighton Engineering Co., Cincinnati, O.
- Contractors—Continued.**  
Green Engineering Co., Com'l Nat. Bk. Bldg., Chicago.  
Register, A. L. & Co., 112 N. Broad St., Philadelphia.  
Sanderson & Porter, 52 William St., New York.  
Saxton, E., 841 Bladensburg, Washington, D. C.  
Shea & Jaastad, 93 Broad St., Boston.  
Stone & Webster Engineering Corp., Boston.  
Wharton, Wm., Jr., & Co., Philadelphia.  
White, J. C., & Co., 49 Exchange Pl., New York.
- Controllers and Attachments.**  
Electric Service Supplies Co., 200 Plymouth Bldg., Chicago.  
General Electric Co., Schenectady, N. Y.  
Johns-Manville, H. W., Co., New York.  
Marshall, R. W. & Co., 95 Liberty St., New York.  
Western Electric Co., Chicago.  
Westinghouse Electric & Mfg. Co., Pittsburg.
- Conveyors and Coal Handling Machinery.**  
Green Engineering Co., Com'l Nat. Bk. Bldg., Chicago.  
Northern Engineering Works, Detroit, Mich.
- Cord, Bell and Trolley.**  
American Car Co., St. Louis.  
Brill, The J. G. Co., Philadelphia.  
Electric Service Supplies Co., 1020-24 Filbert St., Phila.  
Kuhlman, The G. C., Car Co., Cleveland.  
St. Louis Car Co., St. Louis, Mo.  
Stephenson, John, Co., Elizabeth, N. J.  
Stuart-Howland Co., Boston.  
Wason Mfg. Co., Springfield, Mass.
- Couplers, Car.**  
American Car Co., St. Louis.  
Brill, The J. G. Co., Philadelphia.  
Kuhlman, The G. C., Car Co., Cleveland.  
McGuire-Cummings Mfg. Co., Chicago.  
Ohio Brass Co., Mansfield, O.  
St. Louis Car Co., St. Louis, Mo.  
Stephenson, John, Co., Elizabeth, N. J.  
Van Dorn, W. T., Co., Paulina St., Chicago.  
Washburn Steel Castings & Coupler Co., Minneapolis.  
Wason Mfg. Co., Springfield, Mass.
- Coverings, Pipe and Boiler.**  
Johns-Manville, H. W., Co., New York.
- Cranes, Hoists and Lifts.**  
American Car Co., St. Louis.  
Brill, The J. G. Co., Philadelphia.  
Brown Hoisting Machinery Co., Cleveland, O.  
Kuhlman, The G. C., Car Co., Cleveland.  
Northern Engineering Works, Detroit, Mich.  
Railway Specialty & Supply Co., Chicago.  
Stephenson, John, Co., Elizabeth, N. J.  
Van Dorn & Dutton Co., Cleveland, O.  
Wason Mfg. Co., Springfield, Mass.
- Cross Arms—(See Brackets and Cross Arms).**
- Crossing Gates—(See Gates and Guards).**
- Crossings, Track—(See Switches).**
- Curtains, Fixtures and Materials.**  
American Car Co., St. Louis.  
Brill, The J. G. Co., Philadelphia.  
Curtain Supply Co., 93 Ohio St., Chicago.  
Electric Service Supplies Co., 200 Plymouth Bldg., Chicago.  
Hartshorn, Stewart Co., East Newark, N. J.  
Kuhlman, The G. C., Car Co., Cleveland.  
Marshall, R. W. & Co., 95 Liberty St., New York.  
National Lock Washer Co., Newark, N. J.  
Pantazote Co., 11 Broadway, New York.
- Curtains, Fixtures and Materials—Continued.**  
St. Louis Car Co., St. Louis, Mo.  
Stephenson, John, Co., Elizabeth, N. J.  
Wason Mfg. Co., Springfield, Mass.
- Cylinder Oil.**  
Power Specialty Co., 111 Broadway, N. Y.
- Derailing Devices.**  
American Frog & Switch Co., Hamilton, O.  
Cleveland Frog & Crossing Co., Cleveland, O.
- Detective Agency.**  
Drummond Detective Agency, New York.
- Diaphragms.**  
Wood, G. S., Great Northern Bldg., Chicago.
- Doors and Fixtures.**  
American Car Co., St. Louis.  
Brill, The J. G. Co., Philadelphia.  
Kuhlman, The G. C., Car Co., Cleveland.  
St. Louis Car Co., St. Louis, Mo.  
Stephenson, John, Co., Elizabeth, N. J.  
Wason Mfg. Co., Springfield, Mass.
- Doors, Steel Rolling.**  
Kinnear Manufacturing Co., Columbus, O.  
Wilson, J. G., Mfg. Co., New York.
- Draft, Mechanical—(See Mechanical Draft).**
- Draft Rigging.**  
Van Dorn, W. T., Co., Chgo.  
Washburn Steel Castings & Coupler Co., Minneapolis.
- Drills, Track.**  
Brown, H. P., 120 Liberty St., New York.  
Electric Service Supplies Co., 200 Plymouth Bldg., Chicago.  
Fairbanks, Morse & Co., Chgo.  
Kalamazoo Railway Supply Co., Kalamazoo, Mich.  
Marshall, R. W. & Co., 95 Liberty St., New York.  
Reed, Francis, Co., Worcester, Mass.  
Ridlon, Frank, Co., 200 Summer St., Boston.
- Drying Appliances.**  
Green Fuel Economizer Co., Matteawan, N. Y.
- Dynamics and Generators.**  
Cleveland Armature Works, Cleveland, O.  
Fairbanks, Morse & Co., Chgo.  
General Electric Co., Schenectady, N. Y.  
National Brake & Electric Co., Milwaukee, Wis.  
Rossiter, MacGovern & Co., 17 Battery Pl., New York.  
Western Electric Co., Chicago.  
Westinghouse Electric & Mfg. Co., Pittsburg, Pa.
- Economizers, Fuel.**  
Green Fuel Economizer Co., Matteawan, N. Y.
- Electrical Instruments.**  
Electric Service Supplies Co., 200 Plymouth Bldg., Chicago.  
General Electric Co., Schenectady, N. Y.  
Johns-Manville, H. W., Co., New York.  
Queen & Co., Philadelphia.  
Western Electric Co., Chicago.  
Westinghouse Electric & Mfg. Co., Pittsburg, Pa.  
Weston Electrical Instrument Co., Newark, N. J.
- Electric Railway Supplies, General.**  
Cleveland Armature Works, Cleveland, O.  
Creighton Engineering Co., Cincinnati, O.  
Electric Service Supplies Co., 200 Plymouth Bldg., Chicago.  
Fairbanks, Morse & Co., Chgo.  
General Electric Co., Schenectady, N. Y.  
Johns-Manville, H. W., Co., New York.  
Marshall, R. W. & Co., 95 Liberty St., New York.  
Ohio Brass Co., Mansfield, O.  
Stuart-Howland Co., Boston.  
Western Electric Co., Chicago.

# ST. LOUIS CAR CO. ST. LOUIS-MO.

**I**LLUSTRATED herewith is one of twelve single-end combination passenger, smoking and baggage compartment cars for the Pittsburgh, Harmony, Butler and Newcastle Railway.

These cars are of the St. Louis Car Company's semi-steel frame construction. Principal dimensions: total length, 46 feet; rear platform, 4 feet 5 inches; main passenger compartment, 22 feet 9½ inches; smoking compartment, 7 feet 8½ inches; baggage compartment, 10 feet 4 inches, including motorman's cab.

The sides are constructed with 12 window sashes and one baggage door. The lower sashes are arranged to raise, while the upper sashes are stationary. The side sashes are glazed with plate glass and the upper and deck sashes with opalescent glass.

The passenger compartment has 15 St. Louis Car Company's stationary seats, upholstered in brown plush with high head roll. In the rear of this compartment is a saloon, the side walls of which are covered with metal up to the window capping. The smoking compartment has six stationary seats, upholstered in dark green leather. The baggage compartment has three folding seats to be used when there is no baggage.

The motorman's cab is separated from the baggage compartment by an iron pipe railing. In the cab is a hot water heater on the left side of the motorman.

The cars are equipped with St. Louis Car Company's illuminated signs on the front of cars, vertical brake wheels on the front end and St. Louis Car Company's self-releasing brake handles on the rear end. They are mounted on high-speed trucks with air brakes and air sanders.



MADE IN THE LARGEST AND BEST EQUIPPED FACTORY OF ITS KIND IN THE WORLD

## CLASSIFIED LIST OF ADVERTISERS—Continued.

- Enamels.**  
Acme White Lead & Color Works, Detroit, Mich.  
St. Louis Surfer & Paint Co., St. Louis, Mo.
- Engine Apparatus.**  
Green Fuel Economizer Co., Matteawan, N. Y.
- Engineers and Contractors.**  
Arnold Company, Chicago.  
Byllesby, H. M., & Co., Chgo.  
Columbia Construction Co., Milwaukee, Wis.  
Ford, Bacon & Davis, New York.  
Register, A. L. & Co., Philadelphia.  
Roberts & Abbott Co., Cleveland, O.  
Sanderson & Porter, New York.  
Saxton, E., Washington, D. C.  
Sheaff & Jaastad, Boston.  
Stone & Webster Eng. Corporation, Boston.  
White, J. G., & Co., New York.
- Engines, Gas and Oil.**  
Buckeye Engine Co., Salem, O.  
Fairbanks, Morse & Co., Chgo.  
Westinghouse Machine Co., Pittsburg.
- Engines, Hoisting.**  
Fairbanks, Morse & Co., Chgo.
- Engines, Steam.**  
Buckeye Engine Co., Salem, O.  
Rossiter, McGovern & Co., 17 Battery Pl., New York.  
Westinghouse Machine Co., Pittsburg.
- Fans, Exhaust and Ventilating.**  
General Electric Co., Schenectady, N. Y.  
Green Fuel Economizer Co., Matteawan, N. Y.  
Western Electric Co., Chicago.  
Westinghouse Elec. & Mfg. Co., Pittsburg.
- Fare Boxes—(See Electric Railway Supplies).**
- Fare Registers and Register Fittings.**  
Electric Service Supplies Co., 200 Plymouth Bldg., Chicago.  
Recording Fare Register Co., New Haven, Conn.  
Rooke Automatic Register Co., Providence, R. I.
- Feedwater Apparatus.**  
Green Fuel Economizer Co., Matteawan, N. Y.  
Wheeler Condenser & Eng'g Co., New York.
- Feed Wire—(See Wire and Cables).**
- Fenders and Guards.**  
Consolidated Car Fender Co., Providence, R. I.  
Eclipse Railway Supply Co., Cleveland, O.  
Electric Service Supplies Co., 1020-24 Filbert St., Phila.  
McGuire-Cummings Mfg. Co., Chicago.  
Marshall, R. W., & Co., 95 Liberty St., New York.
- Flangers, Snow.**  
McGuire-Cummings Mfg. Co., Chicago.  
Ohio Brass Co., Mansfield, O.  
Kalamazoo Railway Supply Co., Kalamazoo, Mich.  
Van Dorn & Dutton Co., Cleveland, O.
- Frogs—(See Switches, Frogs and Crossings).**
- Fuel Economizers—(See Economizers, Fuel).**
- Fuses and Fuse Devices.**  
Chase-Shawmut Co., Newburyport, Mass.  
Electric Service Supplies Co., 200 Plymouth Bldg., Chicago.  
General Electric Co., Schenectady, N. Y.  
Johns-Manville, H. W., Co., New York.  
Western Electric Co., Chicago.  
Westinghouse Elec. & Manufacturing Co., Pittsburg.
- Gaskets, Bronze.**  
Power Specialty Co., 111 Broadway, New York.
- Gates and Guards.**  
Blisa, R., Mfg. Co., Pawtucket, R. I.  
Kalamazoo Railway Supply Co., Kalamazoo, Mich.
- Gear Cases.**  
Electric Service Supplies Co., 200 Plymouth Bldg., Chicago.  
General Electric Co., Schenectady, N. Y.  
Marshall, R. W., & Co., 95 Liberty St., New York.
- Gears and Pinions.**  
Electric Service Supplies Co., 200 Plymouth Bldg., Chicago.  
General Electric Co., Schenectady, N. Y.  
Marshall, R. W., & Co., 95 Liberty St., New York.  
Nuttall, R. D., Co., Pittsburg.  
Van Dorn & Dutton Co., Cleveland, O.
- Generators—(See Dynamos).**
- Gongs—(See Bells and Gongs).**
- Graphite.**  
U. S. Graphite Co., Saginaw, Mich.
- Graphite Paint—(See Paint).**
- Greases, Chain.**  
Green Engineering Co., Com'l Nat. Bk. Bldg., Chicago.
- Grease—(See Lubricants).**
- Grinders.**  
Brown, Harold P., 120 Liberty St., New York.
- Ground Connection Clamps.**  
Chase-Shawmut Co., Newburyport, Mass.
- Guy Anchors—(See Anchors).**
- Harps, Trolley—(See Trolley Poles and Fittings).**
- Headlights.**  
Electric Service Supplies Co., 200 Plymouth Bldg., Chicago.  
Fairbanks, Morse & Co., Chgo.  
General Electric Co., Schenectady, N. Y.  
Ridlon, Frank, Co., 200 Summer St., Boston.  
St. Louis Car Co., St. Louis, Mo.  
Stuart-Howland Co., Boston.  
Trolley Supply Co., Canton, O.
- Headlinings, Passenger Car.**  
Indestructible Fibre Co., 45 Broadway, New York.
- Heaters, Car, Electric.**  
Consolidated Car-Heating Co., Albany, N. Y.  
Johns-Manville, H. W., Co., New York.
- Heaters, Car, Hot Water, and Stoves.**  
Baker, The Wm. C., Heating & Sup. Co., New York.  
Cooper Heater Co., The, Dayton, O.  
Electric Service Supplies Co., 1020-24 Filbert St., Phila.  
McGuire-Cummings Mfg. Co., Chicago.  
Smith, Peter, Heater Co., Detroit, Mich.
- Heating and Ventilating Apparatus—(See Mech. Draft).**
- Hoists—(See Cranes, Hoists and Lifts).**
- Hose Bridges.**  
Ohio Brass Co., Mansfield, O.
- Hydraulic Machinery.**  
Watson-Stillman Co., 26 Cortlandt St., New York.
- Inspection.**  
Central Inspection Bureau.
- Inspection Cars, Gasoline.**  
Stover Motor Car Co., Freeport, Ill.
- Instruments, Measuring and Testing—(See Electrical Instruments).**
- Insulating Tapes.**  
General Electric Co., Schenectady, N. Y.  
Johns-Manville, H. W., Co., New York, N. Y.  
Massachusetts Chemical Co., Walpole, Mass.  
Okonite Co., Ltd., 253 Broadway, New York.  
Western Electric Co., Chicago.
- Insulations and Insulating Material.**  
Anderson, A. & J. M., Mfg. Co., Boston.  
Creshead Engineering Co., Cincinnati, O.
- Insulations and Insulating Materials—Continued.**  
Electric Railway Equipment Co., Cincinnati, O.  
Electric Service Supplies Co., 200 Plymouth Bldg., Chicago.  
General Electric Co., Schenectady, N. Y.  
Johns-Manville, H. W., Co., New York, N. Y.  
Massachusetts Chemical Co., Walpole, Mass.  
Ohio Brass Co., Mansfield, O.  
Okonite Co., Ltd., 253 Broadway, New York.  
Ridlon, Frank, Co., 200 Summer St., Boston.  
Standard Paint Co., 100 William St., New York.  
Standard Varnish Works, New York.  
Stuart-Howland Co., Boston.  
Western Electric Co., Chicago.
- Jacks.**  
American Car Co., St. Louis.  
Brill, The J. G., Co., Philadelphia.  
Electric Service Supplies Co., 200 Plymouth Bldg., Chicago.  
Fairbanks, Morse & Co., Chgo.  
Kalamazoo Railway Supply Co., Kalamazoo, Mich.  
Kuhlman, The G. C., Car Co., Cleveland.  
Marshall, R. W., & Co., 95 Liberty St., New York.  
Morden Frog & Crossing Co., Chicago.  
Stephenson, John, Co., Elizabeth, N. J.  
Wason Mfg. Co., Springfield, Mass.  
Watson-Stillman Co., 26 Cortlandt St., New York.
- Joints, Expansion—(See Steam Fittings).**
- Joints, Rail.**  
Goldschmidt Thermit Co., 43 Exchange Pl., New York.  
Rail Joint Co., 29 W. 34th St., New York.
- Joints, Welded—(See Rail Joints, Welded).**
- Journal Boxes.**  
American Car Co., St. Louis.  
Brill, The J. G., Co., Philadelphia.  
Kuhlman, The G. C., Car Co., Cleveland.  
McGuire-Cummings Mfg. Co., Chicago.  
St. Louis Car Co., St. Louis, Mo.  
Stephenson, John, Co., Elizabeth, N. J.  
Symington, T. H., Co., Baltimore, Md.  
Wason Mfg. Co., Springfield, Mass.
- Journal Lubricators—(See Lubricators).**
- Journal Packing, Steel Wool.**  
Robertson, Wm., & Co., Fifth Floor, Great Northern Bldg., Chicago.
- Lamps, Arc and Incandescent.**  
Anderson, A. & J. M., Mfg. Co., Boston.  
Electric Service Supplies Co., 200 Plymouth Bldg., Chicago.  
General Electric Co., Schenectady, N. Y.  
Ridlon, Frank, Co., 200 Summer St., Boston.  
Stuart-Howland Co., Boston.  
Western Electric Co., Chicago.  
Westinghouse Electric & Mfg. Co., Pittsburg, Pa.
- Lamp Sockets.**  
Electric Service Supplies Co., 200 Plymouth Bldg., Chicago.  
General Electric Co., Schenectady, N. Y.  
Johns-Manville, H. W., Co., New York, N. Y.
- Lantern Globes.**  
Railway Specialty & Supply Co., Chicago.
- Lifting Magnets.**  
Porter Mfg. Co., 29 Griswold St., Detroit, Mich.
- Lifts—(See Cranes, Hoist and Lift).**
- Lightning Arresters.**  
Electric Service Supplies Co., 200 Plymouth Bldg., Chicago.  
General Electric Co., Schenectady, N. Y.  
Stuart-Howland Co., Boston.  
Western Electric Co., Chicago.  
Westinghouse Elec. & Manufacturing Co., Pittsburg.
- Line Material.**  
Anderson, A. & J. M., Mfg. Co., Boston.  
Creshead Engineering Co., Cincinnati, O.  
Johns-Manville, H. W., Co., New York, N. Y.  
Electric Ry. Equipment Co., Cincinnati, O.  
Electric Service Supplies Co., 200 Plymouth Bldg., Chicago.  
General Electric Co., Schenectady, N. Y.  
Macallen, The Co., Boston.  
Massachusetts Chemical Co., Walpole, Mass.  
Ohio Brass Co., Mansfield, O.  
Okonite Co., Ltd., 253 Broadway, New York.  
Ridlon, Frank, Co., 200 Summer St., Boston.  
Standard Paint Co., 100 William St., New York.  
Standard Varnish Works, New York.  
Stuart-Howland Co., Boston.  
Western Electric Co., Chicago.
- Lock and Nut Washers.**  
National Lock Washer Co., Newark, N. J.
- Lockers, Metal.**  
Electric Service Supplies Co., 200 Plymouth Bldg., Chicago.
- Locomotives.**  
Baldwin Locomotive Works, Philadelphia.  
Johns-Manville, H. W., Co., 1624 Pierce Bldg., St. Louis.
- Locomotives, Electric.**  
American Car Co., St. Louis.  
Baldwin Locomotive Works, Philadelphia.  
Brill, The J. G., Co., Philadelphia.  
General Electric Co., Schenectady, N. Y.  
Kuhlman, The G. C., Car Co., Cleveland.  
McGuire-Cummings Mfg. Co., Chicago.  
Stephenson, John, Co., Elizabeth, N. J.  
Wason Mfg. Co., Springfield, Mass.  
Westinghouse Elec. & Manufacturing Co., Pittsburg.
- Locomotives, Gasoline.**  
Fairbanks, Morse & Co., Chgo.  
Stover Motor Car Co., Freeport, Ill.
- Lubricants.**  
Dearborn Drug & Chemical Works, Chicago.  
Galena-Signal Oil Co., Franklin, Pa.  
U. S. Graphite Co., Saginaw, Mich.  
Whitmore Mfg. Co., Cleveland, O.
- Lumber.**  
Barnes, G. H., Hardwood Lumber Co., St. Louis, Mo.  
Elder, Francis, & Co., Chgo.  
Berthold & Jennings, St. Louis.  
Lindsay Bros. Co., Spokane, Wash.  
S-E, Missouri Cypress Co., Campbell, Mo.
- Magnets and Solenoids.**  
Porter Mfg. Co., 29 Griswold St., Detroit, Mich.
- Malleable Iron.**  
St. Louis Car Co., St. Louis, Mo.
- Measuring Tapes.**  
Lufkin Rule Co., Saginaw, Mich.
- Mechanical Draft.**  
Green Fuel Economizer Co., Matteawan, N. Y.
- Meters.**  
Johns-Manville, H. W., Co., New York.  
Queen & Co., Philadelphia.  
Weston Electrical Instrument Co., Newark, N. J.
- Molded Goods.**  
Massachusetts Chemical Co., Walpole, Mass.  
Wood, G. S., Great Northern Bldg., Chicago.
- Motor Cars, Gasoline.**  
Stover Motor Car Co., Freeport, Ill.
- Motors, Electric.**  
Cleveland Armature Works, Cleveland, O.  
Fairbanks, Morse & Co., Chgo.  
General Electric Co., Schenectady, N. Y.  
National Brake & Electric Co., Milwaukee.

# Street Railway Business

in the cities has far outgrown the antiquated methods of horse car days, as evidenced by great improvements in every line, except only in the handling of passengers. All companies save those which have adopted modern

## Pay-As-You-Enter Cars

still cling to the collect-fares-on-suspicion method.

But the fact is, the best conductor that ever lived cannot get every fare on a crowded car. Then why discipline conductors for failing to do something that absolutely cannot be done under old methods? ¶ Why not adopt up-to-date **Pay-As-You-Enter Cars** and

- get a fare from every passenger
- relieve the conductor from the necessity of carrying an ever-changing mental diagram of passengers paying fares
- insure increased safety of operation by reason of having the conductor on the rear platform at all times
- furnish passengers a much more satisfactory service by reason of faster time and closer adherence to schedules.



Let us demonstrate these facts to you.

We license manufacturers and railways to build and use the Pay-As-You-Enter Car, the patents on which are owned by

**The Pay-As-You-Enter  
Car Company** 26 Cortlandt Street  
NEW YORK, N. Y.

Duncan McDonald, Pres. Thos. W. Casey, Mgr.



## CLASSIFIED LIST OF ADVERTISERS—Continued.

- Motors, Electric—Continued.**  
 Rossiter, MacGovern & Co., 17 Battery Pl., New York.  
 Western Electric Co., Chicago.  
 Westinghouse Elec. & Manufacturing Co., Pittsburg.
- Nut Locks.**  
 Chase-Shawmut Co., Newburyport, Mass.  
 National Lock Washer Co., Newark, N. J.  
 Railway Specialty & Supply Co., Chicago.  
 St. Louis Car Co., St. Louis, Mo.  
 U. S. Metal & Mfg. Co., 25 Broad St., New York.
- Nuts and Bolts.**  
 Lorain Steel Co., Philadelphia.  
 National Lock Washer Co., Newark, N. J.  
 Railway Specialty & Supply Co., Chicago.
- Oilers.**  
 Armstrong Oiler Co., 31st and Chestnut St., Philadelphia.
- Oil—(See Lubricants).**
- Overhead Equipment—(See Electric Railway Supplies).**
- Packings.**  
 Electric Service Supplies Co., 200 Plymouth Bldg., Chicago.  
 Johns-Manville, H. W., Co., New York.  
 Power Specialty Co., 111 Broadway, New York.
- Packing, Steel Wool Journal.**  
 Robertson, Wm., & Co., Fifth Floor Great Northern Bldg., Chicago.
- Paints.**  
 Massachusetts Chemical Co., Walpole, Mass.  
 Standard Paint Co., 100 William St., New York.  
 St. Louis Surface & Paint Co., St. Louis, Mo.  
 U. S. Graphite Co., Saginaw, Mich.
- Pay-As-You-Enter Cars.**  
 Pay-As-You-Enter Car Co., 26 Cortland St., New York.
- Pipe Bends and Fittings—(See Steam Fittings).**
- Plumbago.**  
 U. S. Graphite Co., Saginaw, Mich.
- Poles, Metal.**  
 Creaghead Engineering Co., Cincinnati, O.  
 Electric Railway Equipment Co., Cincinnati, O.  
 Electric Service Supplies Co., 200 Plymouth Bldg., Chicago.
- Poles and Ties, Wood.**  
 Advance Lumber Co., Cleveland, O.  
 Barnes, G. H., Hardwood Lumber Co., St. Louis, Mo.  
 Beldler, Francis & Co., Chgo.  
 Berthold & Jennings, St. Louis.  
 Churchill Cedar Co., Spokane, Wash.  
 Humbird Lumber Co., Sand Point, Idaho.  
 Lindsley Bros. Co., Spokane, Wash.  
 National Pole Co., Escanaba, Mich.  
 Naugle Pole & Tie Co., 226 La Salle St., Chicago.  
 Pacific Coast Pole Co., Spokane, Wash.  
 S-E. Missouri Cypress Co., Campbell, Mo.  
 Worcester, C. H., Co., Tribune Bldg., Chicago.
- Promoters of Railway Projects.**  
 Shimer & Chase Co., Omaha, Neb.
- Punches—(See Ticket Punches).**
- Rail Benders.**  
 Electric Service Supplies Co., 200 Plymouth Bldg., Chicago.  
 Fairbanks, Morse & Co., Chgo.
- Rail Bonds—(See Bonds, Rail).**
- Rail Bonds, Flexible.**  
 Chase-Shawmut Co., Newburyport, Mass.
- Rail Drills—(See Drills, Track).**
- Rail Feed Wire—(See Wire and Cables).**
- Rail Joints and Chairs—(See Joints, Rail).**
- Rail Joints, Welded.**  
 Goldschmidt Thermit Co., 43 Exchange Pl., New York.  
 Lorain Steel Co., Philadelphia.
- Rails, New.**  
 Lorain Steel Co., Philadelphia.  
 New York Switch & Crossing Co., Hoboken, N. J.  
 Wharton, Wm., Jr., & Co., Philadelphia.
- Rails, Relaying.**  
 Zelnicker, Walter A., Supply Co., St. Louis.
- Railway Equipment.**  
 Johann, F. A., 1624 Pierce Bldg., St. Louis.
- Railway Velocipedes.**  
 Fairbanks Morse & Co., Chgo.  
 Kalamazoo Railway Supply Co., Kalamazoo, Mich.
- Registers and Fittings—(See Fare Registers).**
- Relays.**  
 Weston Electrical Instrument Co., Newark, N. J.
- Roofing.**  
 Johns-Manville, H. W., Co., New York.
- Rubber Goods, Mechanical.**  
 Wood, G. S., Great Northern Bldg., Chicago.
- Rubber Preservative.**  
 Wood, G. S., Great Northern Bldg., Chicago.
- Sand Apparatus.**  
 American Car Co., St. Louis.  
 Brill, The J. G., Co., Philadelphia.  
 Electric Service Supplies Co., 200 Plymouth Bldg., Chicago.  
 Kuhlman, The G. C., Car Co., Cleveland.  
 Marshall, R. W., & Co., 95 Liberty St., New York.  
 Ohio Brass Co., Mansfield, O.  
 Ridlon, Frank, Co., 200 Summer St., Boston.  
 St. Louis Car Co., St. Louis, Mo.  
 Stephenson, John, Co., Elizabeth, N. J.  
 Wason Mfg. Co., Springfield, Mass.
- Sash Balances and Fixtures.**  
 National Lock Washer Co., Newark, N. J.
- Sash Operating Devices.**  
 Drouvé, The G. Co., Bridgeport, Conn.  
 Lord & Burnham, Irvington-on-Hudson, New York.
- Seats, Car—(See Car Seats).**
- Shade Rollers—(See Curtains, Fixtures and Materials).**
- Shutters, Steel Rolling.**  
 Kinnear Manufacturing Co., Columbus, O.
- Signals.**  
 Blake Signal & Manufacturing Co., Boston.  
 Telegraph Signal Co., Rochester, N. Y.
- Signal Supplies.**  
 Railway Specialty & Supply Co., Chicago.
- Skylights.**  
 Drouvé, The G. Co., Bridgeport, Conn.  
 Lord & Burnham, Irvington-on-Hudson, New York.
- Snow Plows, Sweepers and Scrapers.**  
 American Car Co., St. Louis.  
 Brill, The J. G., Co., Philadelphia.  
 Kalamazoo Railway Supply Co., Kalamazoo, Mich.  
 Kuhlman, The G. C., Car Co., Cleveland.  
 McGuire-Cummings Mfg. Co., Chicago.  
 Russell Car & Snow-Plow Co., Ridgway, Pa.  
 Stephenson, John, Co., Elizabeth, N. J.  
 Wason Mfg. Co., Springfield, Mass.
- Sockets, Waterproof.**  
 Johns-Manville, H. W., Co., New York.
- Solder Paste.**  
 Chase-Shawmut Co., Newburyport, Mass.
- Splicing Compounds and Materials.**  
 Massachusetts Chemical Co., Walpole, Mass.
- Springs.**  
 American Car Co., St. Louis.  
 Brill, The J. G., Co., Philadelphia.  
 Kuhlman, The G. C., Car Co., Cleveland.  
 McGuire-Cummings Mfg. Co., Chicago.  
 Marshall, R. W., & Co., 95 Liberty St., New York.  
 Railway Specialty & Supply Co., 71 Broadway, New York.  
 St. Louis Car Co., St. Louis, Mo.  
 Stephenson, John, Co., Elizabeth, N. J.  
 Wason Mfg. Co., Springfield, Mass.
- Sprinkling Cars.**  
 American Car Co., St. Louis.  
 Brill, The J. G., Co., Philadelphia.  
 Kuhlman, The G. C., Car Co., Cleveland.  
 McGuire-Cummings Mfg. Co., Chicago.  
 Stephenson, John, Co., Elizabeth, N. J.  
 Wason Mfg. Co., Springfield, Mass.
- Stage Pockets and Plugs.**  
 Chase-Shawmut Co., Newburyport, Mass.
- Steam Apparatus.**  
 Green Fuel Economizer Co., Matteawan, N. Y.
- Steam Fittings, Etc.**  
 Crane Co., Chicago.  
 Davis, The John, Co., Chgo.  
 Simmons, John, Co., 110 Centre St., New York.  
 Power Specialty Co., 111 Broadway, New York.
- Steel Cars.**  
 American Car Co., St. Louis.  
 Brill, The J. G., Co., Philadelphia.  
 Kuhlman, The G. C., Car Co., Cleveland.  
 St. Louis Car Co., St. Louis, Mo.  
 Stephenson, John, Co., Elizabeth, N. J.  
 Wason Mfg. Co., Springfield, Mass.
- Steel Tapes.**  
 Lufkin Rule Co., Saginaw, Mich.
- Stokers.**  
 Babcock & Wilcox Co., 85 Liberty St., New York.  
 Green Engineering Co., Com'l Nat. Bk. Bldg., Chicago.  
 Model Stoker Co., Dayton, O.  
 Under-Feed Stoker Co. of Am., Chicago.  
 Westinghouse Machine Co., Pittsburg.
- Storage Batteries—(See Batteries).**
- "Strike-Breakers."**  
 Drummond Detective Agency, 3 Ann St., New York.
- Superheaters.**  
 Power Specialty Co., 111 Broadway, New York.
- Switches, Frogs and Crossings.**  
 American Frog & Switch Co., Hazleton, O.  
 Barbour-Stockwell Co., Cambridgeport, Mass.  
 Cleveland Frog & Crossing Co., Cleveland, O.  
 Fairbanks, Morse & Co., Chgo.  
 Lorain Steel Co., Philadelphia.  
 Morden Frog & Crossing Co., Rookery, Chicago.  
 New York Switch & Crossing Co., Hoboken, N. J.  
 Railway Specialty & Supply Co., Chicago.  
 Wharton, Wm., Jr., & Co., Philadelphia.
- Switchboards and Switchboard Instruments.**  
 Anderson, A. & J. M., Mfg. Co., Boston.  
 Chase-Shawmut Co., Newburyport, Mass.  
 General Electric Co., Schenectady, N. Y.  
 Western Electric Co., Chicago.  
 Westinghouse Electric & Mfg. Co., Pittsburg.  
 Weston Electrical Instrument Co., Newark, N. J.
- Tapes and Webbing.**  
 Hope Webbing Co., Providence, R. I.  
 Johns-Manville, H. W., Co., New York.  
 Massachusetts Chemical Co., Walpole, Mass.  
 Okonite Co., Ltd., 253 Broadway, New York.
- Ticket Punches.**  
 Meyers, Fred J., Mfg. Co., Hamilton, Mo.  
 Woodman Mfg. & Sup. Co., Boston.
- Ties and Poles, Wood—(See Poles and Ties).**
- Timber.**  
 Beldler, Francis & Co., Chgo.  
 Lindsley Bros. Co., Spokane, Wash.  
 S-E. Missouri Cypress Co., Campbell, Mo.
- Tools, Pneumatic—(See Pneumatic Tools).**
- Track Cleaners and Scrapers.**  
 American Car Co., St. Louis.  
 Brill, The J. G., Co., Philadelphia.  
 Kalamazoo Railway Supply Co., Kalamazoo, Mich.  
 Kuhlman, The G. C., Car Co., Cleveland.  
 McGuire-Cummings Mfg. Co., Chicago.  
 Marshall, R. W., & Co., 95 Liberty St., New York.  
 Ohio Brass Co., Mansfield, O.  
 Stephenson, John, Co., Elizabeth, N. J.  
 Van Dorn & Dutton Co., Cleveland, O.  
 Wason Mfg. Co., Springfield, Mass.
- Track Drills—(See Drills, Track).**
- Tracklaying Machinery.**  
 Holman, D. F., Ry. Tracklayer Co., 1102 Ellisworth Bldg., Chicago.
- Track Tools.**  
 Electric Service Supplies Co., 200 Plymouth Bldg., Chicago.  
 Kalamazoo Railway Supply Co., Kalamazoo, Mich.
- Trimming, Car.**  
 American Car Co., St. Louis.  
 Brill, The J. G., Co., Philadelphia.  
 Curtain Supply Co., Park Row Bldg., New York.  
 Kuhlman, The G. C., Car Co., Cleveland.  
 National Lock Washer Co., Newark, N. J.  
 St. Louis Car Co., St. Louis, Mo.  
 Stephenson, John, Co., Elizabeth, N. J.  
 Wason Mfg. Co., Springfield, Mass.  
 Wood, G. S., Great Northern Bldg., Chicago.
- Trolley Guards.**  
 Automatic Trolley Guard Co., 391 Ellicott Sq., Buffalo, N. Y.  
 Electric Service Supplies Co., 200 Plymouth Bldg., Chicago.
- Trolley Poles and Fittings.**  
 General Electric Co., Schenectady, N. Y.  
 Johns-Manville, H. W., Co., New York.  
 Marshall, R. W., & Co., 95 Liberty St., New York.  
 Star Brass Works, Kalamazoo, Mich.



**TRADE MARK**  
Registered U. S. Patent Office

# The Standard for Rubber Insulation

RAILWAY FEED WIRES insulated with OKONITE are unequalled for flexibility, durability and efficiency, and are in use by the leading Electric Street Railway Companies. OKONITE is preferred above any other insulation for Car Wiring, Telegraph and Telephone Purposes

**Okonite Wires, Okonite Tape, Manson Tape, Candee Weatherproof Wires**

SAMPLES AND ESTIMATES ON APPLICATION

## THE OKONITE Co., Ltd.,

WILLARD L. CANDEE, H. DURANT CHEEVER, Managers.  
GEORGE T. MANSON, Gen'l Supt.; W. H. HODGINS, Secretary.

253 Broadway, NEW YORK

# Galena-Signal Oil Company

FRANKLIN, PA.

THEIR SPECIALTIES

**STREET RAILWAY LUBRICATION** including both rolling stock and power house equipment.

Same skillful *expert supervision* given in this service as in steam railway service has produced very satisfactory results. The business of our Street Railway Department has increased beyond every expectation. In 1906 this department sold ten times the number of barrels of oil sold by the same department in 1903.

We are under contract with many of the largest street and interurban railways of the country.

We guarantee cost per thousand miles in street railway service when conditions warrant it.

Write to Franklin, Pennsylvania, for further particulars.

**STEAM RAILWAY LUBRICATION** Sole manufacturers of the celebrated

*Galena Coach, Engine and Car Oils* for steam railway lubrication. *Sibley's Perfection Valve Oil* for cylinder lubrication, and *Perfection Signal Oil* for use in railway signal lanterns.

**GALENA RAILWAY SAFETY OIL** Made especially for use in headlights, cab, classification

and tail lights, and for switch and semaphore lamps. Burns equally well with the long time as with the one-day burner; with or without chimney as the burner requires. Is pure water white in color; high fire test, low cold test, and splendid gravity.

CHAS. MILLER, President

# Shawmut Soldered Bond Cap

to make over your  
PLUG BONDS

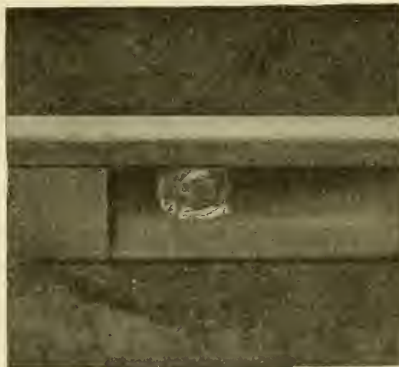

Why not look this up

**CHASE-SHAWMUT CO.**

Newburyport, Mass.

## CLASSIFIED LIST OF ADVERTISERS—Continued.

- Trolley Retrievers and Catchers. Electric Service Supplies Co., 1020-24 Filbert St., Phila.  
Milloy Electric Co., Bucyrus, O.  
Ridlon, Frank, Co., 200 Summer St., Boston.  
Trolley Supply Co., Canton, O.
- Trolley Wagons. Kalamazoo Railway Supply Co., Kalamazoo, Mich.
- Trolley Wheels—(See Trolley Poles and Fittings).
- Trolley Wire—(See Wire and Cables).
- Trolleys, Track. Cleveland Armature Works, Cleveland, O.
- Trucks, Car. American Car Co., St. Louis.  
Baldwin Locomotive Works, Philadelphia.  
Brill, The J. G., Co., Philadelphia.  
Kuhlman, The G. C., Car Co., Cleveland.  
McQuire-Cummings Mfg. Co., Chicago.  
St. Louis Car Co., St. Louis, Mo.  
Standard Motor Truck Co., Pittsburg, Pa.  
Standard Varnish Works, New York City.  
Stephenson, John, Co., Elizabeth, N. J.
- Trucks, Car—Continued. Van Dorn & Dutton Co., Cleveland, O.  
Wason Mfg. Co., Springfield, Mass.
- Turbines. General Electric Co., Schenectady, N. Y.  
Westinghouse Machine Co., Pittsburg, Pa.
- Valves—(See Steam Fittings).
- Varnish. Electric Service Supplies Co., 200 Plymouth Bldg., Chicago.  
Harrison Elec. & Mfg. Co., 169 South St., New York.  
Marshall, R. W., & Co., 95 Liberty St., New York.  
Massachusetts Chemical Co., Walpole, Mass.  
Milloy Electric Co., Bucyrus, O.  
Nuttall, R. D., Co., Pittsburg-Ridlon, Frank, Co., 200 Summer St., Boston.  
Standard Paint Co., 100 William St., New York.  
Star Brass Works, Kalamazoo, Mich.  
Trolley Supply Co., Canton, O.  
Wallace Supply Co., Chicago.  
Westinghouse Electric & Mfg. Co., Pittsburg, Pa.
- Ventilators. Drouvé, The G. Co., Bridgeport, Conn.  
Lord & Burnham, Irvington-Hudson, New York.
- Vestettes. Bellamy Vestlette Mfg. Co., Cleveland, O.
- Waste, Cotton and Wool. Hagy, J. Milton, Waste Wks., Philadelphia, Pa.  
Railway Specialty & Supply Co., Chicago.
- Water Softening Apparatus. Dearborn Drug & Chemical Works, Chicago.
- Wheels and Axles. American Car Co., St. Louis.  
Brill, The J. G., Co., Philadelphia.  
Griffin Wheel Co., Chicago.  
Kuhlman, The G. C., Car Co., Cleveland.  
Lorain Steel Co., Philadelphia.  
McGuire-Cummings Mfg. Co., Chicago.  
Marshall, R. W., & Co., 95 Liberty St., New York.  
Railway Steel-Spring Co., New York.  
St. Louis Car Co., St. Louis, Mo.  
St. Louis Car Wheel Co., St. Louis.  
Standard Steel Works, Philadelphia.  
Stephenson, John, Co., Elizabeth, N. J.  
Wason Mfg. Co., Springfield, Mass.
- Wheel Grinders. Wheel Truing Brake Shoe Co., Detroit, Mich.
- Window Fixtures. Drouvé, The G., Co., Bridgeport, Conn.
- Wiping Rags. Hagy, J. Milton, Waste Wks., Philadelphia, Pa.
- Wire, Aluminum. Aluminum Co. of America, Pittsburg, Pa.
- Wire, Insulated. Aluminum Co. of America, Pittsburg, Pa.  
American Electrical Works, Providence, R. I.  
General Electric Co., Schenectady, N. Y.  
Okonite Co., Ltd., 253 Broadway, New York.  
Standard Underground Cable Co., Pittsburg, Pa.  
Stuart-Howland Co., Boston.
- Wire and Cables. Aluminum Co. of America, Pittsburg, Pa.  
American Electrical Works, Providence, R. I.  
Bridgeport Brass Co., Bridgeport, Conn.  
General Electric Co., Schenectady, N. Y.  
Okonite Co., Ltd., 253 Broadway, New York.  
Standard Underground Cable Co., Pittsburg, Pa.

**"METALSTEEL" PAINT**

Best Steel Protective and Rust Preventive for all Metal Surfaces.



ST. LOUIS SURFACER & PAINT COMPANY  
St. Louis, U. S. A.

10

**Plain and Inlaid LINOLEUM**

GUILFORD S. WOOD  
ELECTRIC RAILWAY NECESSITIES  
Great Northern Bldg., Chicago

4

**Your Wife Will Laugh**

if you tell her that you purchase electric tape by the pound. When she goes shopping, yardage and quality direct her. Our No. 264 ELECTRIC TAPE

is the highest quality obtainable and the greatest yardage per pound. But don't lose sight of the yardage.

Your jobber will supply you if you insist.

Write for quotations.

MASSACHUSETTS CHEMICAL COMPANY

Operates  
Walpole Varnish Works  
Walpole Rubber Works

PLANT: WALPOLE, MASS.

**In Buying Waste It is Important to Know—**

FIRST—That it is free from dirt and grit.

SECOND—That it is easy to pack.

THIRD—That it is made up of all long strands.

FOURTH—That it will absorb the oil in a manner insuring a free and even lubrication.

Hagy Waste meets specific conditions and ordinary ones

**The J. Milton Hagy Waste Works**

433 Spruce Street

Philadelphia

4

**THE BABCOCK & WILCOX COMPANY**

85 Liberty Street, New York

Babcock & Wilcox ——— Stirling ——— A & T Horizontal ——— Cahall Vertical

**WATER TUBE STEAM BOILERS**

STEAM SUPERHEATERS

Works: Bayonne, N. J. Barberton, Ohio.

MECHANICAL STOKERS

BRANCH OFFICES:

BOSTON, Delta Bldg.  
PHILADELPHIA, 1110-1112 North American Bldg.  
SAN FRANCISCO, 63 First Street  
PITTSBURGH, Farmers Deposit Nat. Bank Bldg.  
NEW ORLEANS, 343 Baronne St.

DENVER, 410 Seventeenth St.  
SALT LAKE CITY, 313 Atlas Block  
WASHINGTON, Colorado Building  
CHICAGO, Marquette Bldg.  
ATLANTA, GA., 1132 Candler Bldg.

CLEVELAND, 706 New England Bldg.  
MEXICO CITY, 7 Avenida, Juarez  
HAVANA, CUBA, 1164 Calle de la Habana  
LOS ANGELES, 321 Trust Bldg.  
CINCINNATI, O., Traction Bldg.



# U.S. Metal & Mfg. Co.

25 Broad Street, New York

Pittsburg, 1509 Arrott Bldg. Chicago, 414 Railway Exchange

## Columbia Lock Nuts

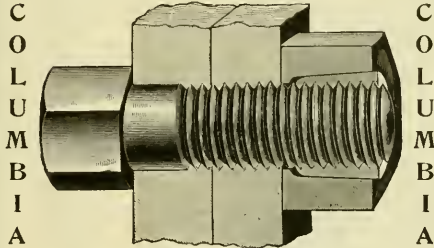

Columbia Lock Nut on Bolt

It is effective and indispensable on locomotives, pitmans, wrists, king bolts, rail joints, fish plates, piston rods, cylinder heads, steam pumps, and, in fact, all kinds of machinery. It is also invaluable on railroad cars, carriages, wagons, automobiles, axles, steam pipes, flanges, etc.

SEND FOR CATALOG AND PRICE LIST

# TUBULAR POLES IRON OR STEEL



FOR  
ELECTRIC RAILWAYS  
ELECTRIC LIGHTING CO'S  
SIGNAL )  
TELEPHONE )  
TELEGRAPH )  
          SERV  
          VICE  
TRANSMISSION  
LINES  
AND  
CATENARY  
SUSPENSION  
LINES

**ELECTRIC RAILWAY EQUIPMENT CO.**  
General Office: CINCINNATI-O-U-S-A  
Shops: READING PA - WHEELING WVA

This 14-inch Hochfeldt Eclipse Combination Back Pressure and Relief Valve was installed three years ago in the boiler plant of the Chicago City Railway, located at 77th and Vincennes Road, and is operating with best results.

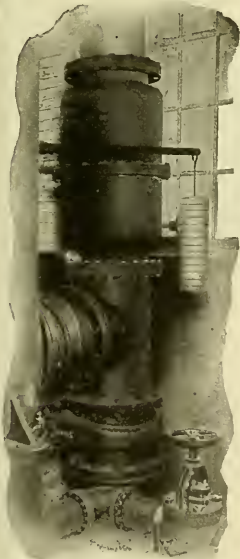

**THE JOHN DAVIS COMPANY**  
HALSTED 22<sup>ND</sup> AND UNION STS - CHICAGO

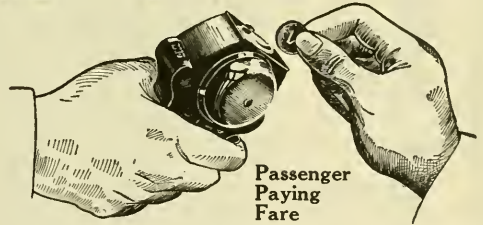

Every nickel collected is registered before reaching the conductor's hand when you use the

## Rooke Automatic Fare Collector

The Rooke System is a revolution in fare-collecting methods, and as far superior to old systems as the trolley car is to the horse car.

Why not ask us to prove it?

**Rooke Automatic Register Co.**  
PROVIDENCE RHODE ISLAND

# Standard "City and Suburban" High Speed Double Truck "Short Wheel Base"

TYPE O-50

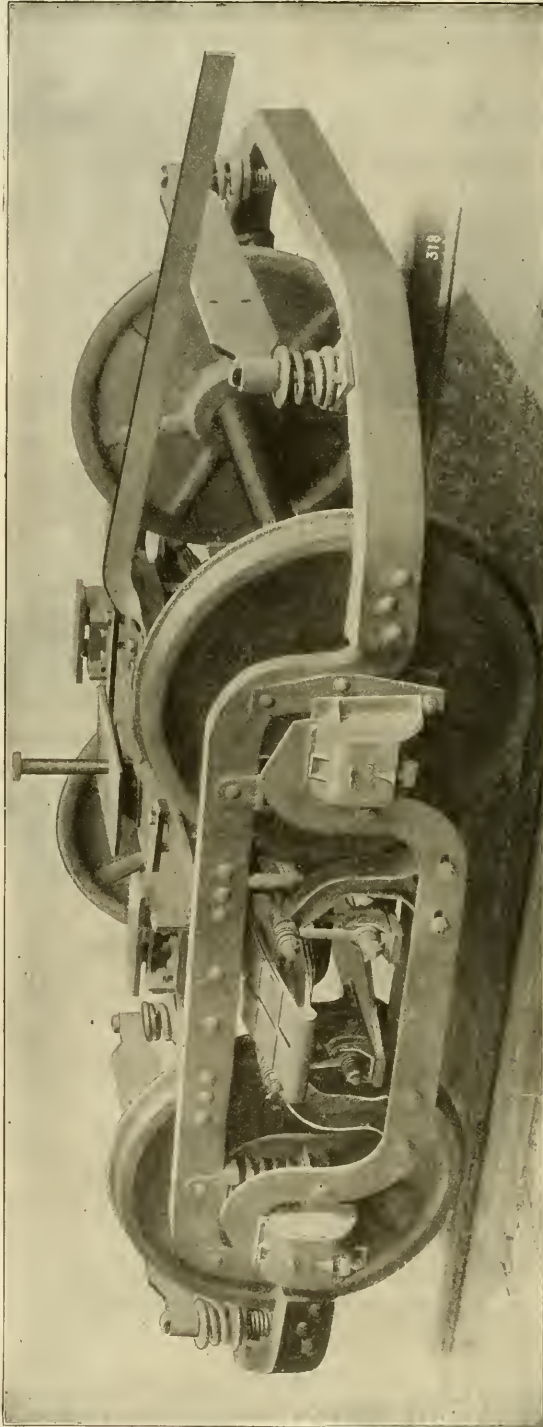

Our new plant is equipped with the most modern truck building machinery and the very best quality of material and workmanship is used in the manufacture of these trucks. M. C. B. standard principles are followed. Frames are made from rolled open hearth steel without welds. We are prepared to build trucks in accordance with purchaser's designs and specifications.

**Standard Motor Truck Company, Frick Bldg., Pittsburg, Pa.**

New York Office: 170 Broadway

Works: New Castle, Pa.

Chicago Office: Fisher Bldg.

# FOR SALE. FOR QUICK DELIVERY

## 6 55-ft. Passenger, Baggage and Smoking Car Bodies

Main Compartment 26' 0"  
 Smoking " 10' 6"  
 Baggage " 10' 0"  
 Seating Capacity, 54

## 8 60-ft. Passenger, Baggage and Smoking Car Bodies

Main Compartment 28' 6"  
 Smoking " 11' 0"  
 Baggage " 8' 0"  
 Seating Capacity, 58

## 5 52-ft. Passenger and Smoking Car Bodies — Double End

Seating Capacity, 60

## 3 52-ft. Passenger and Baggage Car Bodies — Double End

Seating Capacity, 56

## 2 50-ft. Express Car Bodies

*Write or wire us for further information.*

# The Jewett Car Co. Newark Ohio

### THE MIGHTY MIDGET

## HOT WATER CAR HEATER

Adapted for Large Electric Cars and Long Distance Lines. Exclusively used on Largest Electric Systems. Ask for Catalog

THE WILLIAM C. BAKER HEATING & SUPPLY CO., 143 LIBERTY STREET NEW YORK



## NILES CARS — THE ELECTRIC PULLMANS

LARGE, FAST INTERURBANS  
 OUR SPECIALTY

### NILES CAR & MFG. COMPANY

WORKS: NILES, OHIO  
 Sales Office: J. A. HANNA CO., 312 Electric Bldg., Cleveland, O.

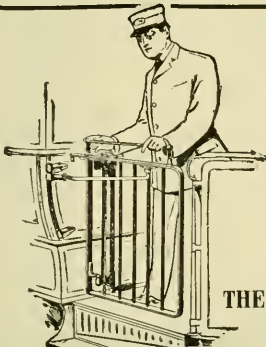

## Over 46,500 of Wood's Car Gate

Patented U. S. and Canada

### Equipments Now in Use

Do not bother passengers. Easy to operate. Light, strong, serviceable. Simple to apply on all styles of cars.

Ask for Prices

THE R. BLISS MFG. CO., Pawtucket, R.I., U.S.A.

New York Office, National Novelty Corporation, 826 Broadway

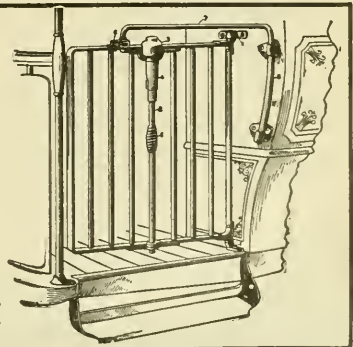

# How to Use Advertising Space

**O**NE-HALF PAGE of space in the Electric Railway Review measures  $5\frac{1}{16}$  by  $7\frac{1}{16}$  inches—the exact size of this panel—or it may be used in a space  $3\frac{1}{2}$  by  $10\frac{1}{4}$  inches.

Half pages are ample for advertising many lines of business and will carry strong, attractive advertisements. The cost of such space for one year (52 issues) is \$875.

Aside from running a half page of either shape every week, there are other ways of using the space to advantage:

## Plan No. 1

Use 2 pages in some one issue, either as the first gun in your campaign, or at a time (such as before conventions) when you have something special to say. Then use 11 full pages—one in each of the other months; also 12 half pages—one each month. Quarter-page advertisements would complete the remaining 28 insertions.

## Plan No. 2

Use 8 full pages and 28 half pages (36 issues), which would give you three advertisements of this kind each month. You could lead off with full pages, or you could bunch them at convention time, or at any other season when most valuable to you. Quarter-page advertisements would make up the remaining 16 insertions.

Copy should be changed each insertion, and we will help you do it. You buy the space and our Advertisers' Copy Service (free to all advertisers) will co-operate in the preparation of real advertising, the kind that helps sell goods.

If you do not like either plan, tell us your objections and we will make another.

Electric Railway Review 160 Harrison St. Chicago

# Dearborn Water Purifying Reagents

Increase the efficiency and the years of service of steam boilers by keeping them in good condition internally. Gallon sample of the water required for analysis before preparing treatment.

## Dearborn Drug & Chemical Works

ROBT. F. CARR, PRESIDENT

299 BROADWAY, NEW YORK POSTAL TELEGRAPH BLDG., CHICAGO



Established 1877.



### ALBERT & J. M. ANDERSON MFG. CO.,

Makers of

**ELECTRICAL APPLIANCES:**  
SWITCHES, SWITCHBOARDS,  
TIME SWITCHES, LINE MATERIAL,  
COPPER CASTINGS (75% CONDUCTIVITY).  
289-293 A ST., BOSTON, MASS., U. S. A.

Branches:

New York, 135 Broadway. Chicago, 175 Dearborn Street.

Agencies:

Boston, Pettingell-Andrews Co. San Francisco, Eccles & Smith Co.  
New York, R. W. Marshall & Co. Atlanta, Newcomer-Manry Co.  
St. Louis, J. C. White. Denver, E. M. Messiter.  
Toronto, Ont., H. J. Surtees.



## Queen Testing Sets

"The Recognized Standard"

Voltmeters  
Ammeters  
Switchboard and Portable  
Alternating and Direct Current

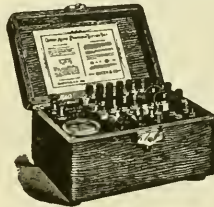

Queen Acme Testing Set

U. S. Standard Testing Sets  
Rail Bond Testers  
Galvanometers, etc., etc.  
Electrical Instruments for All Purposes

QUEEN & CO., Inc., Philadelphia, Pa.

## Whitmore's Gear Protective Composition

produces everything that we guarantee it to do. Ask for the names of those who have had experience with it. They will have no other.

The Whitmore Manufacturing Company  
Cleveland, Ohio, U. S. A.

## WESTON Electrical Instrument Co.

Main Office and Works:  
WAVERLY PARK, NEWARK, N. J.

Illuminated  
Dial Station  
Instruments



SEND FOR NEW CATALOGUE

Berlin—European Weston Electrical Instrument Co., Ritterstrasse, No. 88  
Paris, France—E. H. Cadot, 12 Rue St. Georges  
London—Andrey House, Ely Place, Holborn  
New York Office—74 Cortlandt St.



## THE WHEEL TRUING BRAKE SHOE

quickly repairs the crippled wheel and does it while the wheel is running. No argument is needed. Practical railroad men take in the situation at a glance. That is why we sell so many. Best material. Best workmanship. Great experience in this line of work. Low prices.

The Wheel Truing Brake Shoe Co.  
DETROIT, MICHIGAN

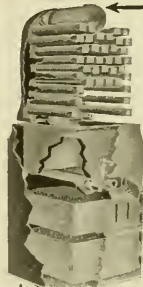

## A Cooper Heater

will heat eight cars satisfactorily for the same cost of operating one car with the electric heater. It pays for itself.

Ask us to prove it

The Cooper Heater Co., Dayton, Ohio

**Mc GUIRE-CUMMINGS MFG. CO.**  
**SPECIALITIES IN RAILWAY EQUIPMENT**  
**CARS, TRUCKS, SPRINKLERS, SNOW SWEEPERS, ETC.**  
**CHICAGO**



**ECLIPSE  
Life Guard**

Manufactured by the  
**ECLIPSE RAILWAY SUPPLY CO.**  
 Cleveland, Ohio



**It's Great!**  
 Have you received a working  
 model of the Atlas Anchor?  
 Ask for one—free.  
**THE ATLAS ANCHOR CO.,** Cleveland, Ohio



**THE UNDER-FEED  
STOKER CO.**  
 OF AMERICA  
 MANUFACTURED IN  
 CHICAGO.



**THE STAR BRASS WORKS**  
 KALAMAZOO, MICH.

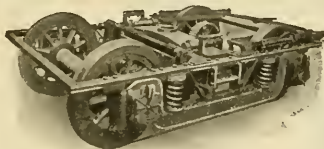

**BALDWIN LOCOMOTIVE WORKS**  
 BURNHAM, WILLIAMS & CO., PHILADELPHIA, PA., U. S. A.

Builders of **LOCOMOTIVES OF EVERY DESCRIPTION**  
 Including **ELECTRIC LOCOMOTIVES** and  
**ELECTRIC TRUCKS**

Truck built for Indianapolis, New Castle & Toledo Electric Railway Company.

**STANDARD STEEL WORKS,** HARRISON BUILDING PHILADELPHIA, PA.  
**SOLID FORGED ROLLED AND STEEL TIERED WHEELS** ELLIPTIC AND COIL SPRINGS  
 mounted on axles and fitted with Motor Gears for Electric Railway Service



**PIPE FITTINGS  
AND VALVES**  
 FOR THE  
**HEATING AND PLUMBING TRADE**

TRADE  MARK

**JOHN SIMMONS CO.**  
 104-110 Centre Street, NEW YORK

**THE LORAIN STEEL COMPANY**

**Girder Rails and High Tee Rails**  
**High-Grade Special Track Work**

GENERAL OFFICES  
**THE PENNSYLVANIA BUILDING, PHILADELPHIA, PA.**

# Trolley Catchers

THE RIDLON No. 2



Made  
a  
little  
stronger  
than  
the  
service  
requires

Composed of minimum number of parts—all made of malleable iron—particular attention being given the few wearing parts.

*Catchers sent on 30 days' trial*

**FRANK RIDLON COMPANY**  
200 Summer St., Boston, Mass.

Pacific Coast Representatives:  
**THE H. M. ESTES CO.**  
GENERAL OFFICE, SAN FRANCISCO, CAL.  
Branch Offices: Los Angeles, Cal. Portland, Ore.

1

# Plastic Rail Bond Durability

When you see one you think of the other.

A bond that shows but 5 per cent depreciation after eleven years' severe service has earned the right to be known as the

## Durable Rail Bond

The plug type can be installed without disturbing the pavement or removing the angle plate.

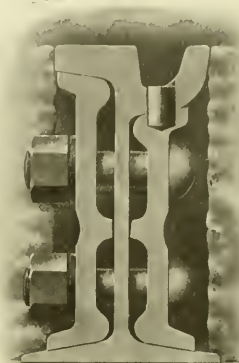

**When Put,  
Stays Put!**

This shows you how.

**HAROLD P. BROWN,**  
*The Bond Expert,*  
120 LIBERTY STREET, NEW YORK.

# STEEL WOOL JOURNAL PACKING

really is superior to and far more economical than all other kinds of packing. A comparative test under hard service will prove this to your complete satisfaction.

*We will gladly furnish a liberal sample*

**WM. ROBERTSON & COMPANY**

General Office: Great Northern Bldg., CHICAGO  
Factory: 75 S. Jefferson St., BATTLE CREEK, MICH.

11

# The SIGNAL SYSTEM

that prevents accidents, facilitates traffic and promotes adherence to schedules

is made by the

**Telegraph Signal Co.**  
82 State St., Rochester, N. Y.

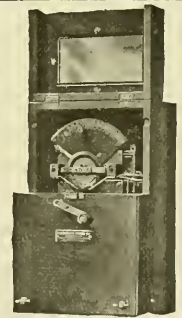

# "Not an Experiment"

The Providence Fender has been in successful operation on hundreds of roads for 13 years, and has proved itself reliable under all conditions of Street Railway service.

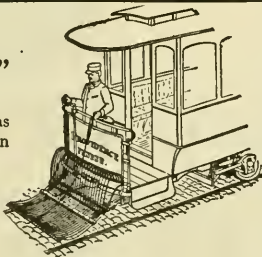

**CONSOLIDATED CAR FENDER COMPANY**

Office and Factory: PROVIDENCE, R. I.  
Branch Office: 110 E. Twenty-third St., New York  
European Agents: Comptoir d'Electricite, 6, Rue Boudreau, Paris, France

# ALUMINUM

## Railway Feeders

And all kinds of **Electrical Conductors**

Aluminum Feeders are less than one-half the weight of copper feeders and are of equal conductivity and strength. If insulated wire or cable is required, high grade insulation is guaranteed.

*Write for prices and full information.*

**Aluminum Company of America**  
PITTSBURGH, PA.

Formerly The Pittsburgh Reduction Company

# CLASSIFIED ADVERTISEMENTS

Undisplayed advertisements are inserted under this heading at the uniform rate of one cent a word; minimum charge twenty-five cents. Replies directed to this office will be forwarded when required to any address in the United States, Canada or Mexico without extra charge. Advertisements received at the Chicago office by 9 a. m. Thursday will appear in the issue for the same week.

## POSITIONS WANTED.

An experienced business getter and manager would like to secure position as traffic manager for large electric system. Highest references. Address "No. 545," care of Electric Railway Review, Chicago.

Position as auditor wanted by a young man of experience in street railway and electric light accounting. Best of references as to character and ability. Address "No. 545," care of Electric Railway Review, Chicago.

Position as auditor or assistant wanted by a young single man. Thoroughly experienced in railway, gas and lighting accounting. Now employed. Address "No. 544," care of Electric Railway Review, Chicago.

Expert armature winder on all types of G. E. and Westinghouse motors is open for a position. Live, up-to-date man, capable of handling men. Excellent habits. A-1 references. Address "No. 552," care of Electric Railway Review, Chicago.

Position by draftsman; have had nine years' experience in electric railway work. Instrument work, mechanical and electrical drafting. Experience; assistant to master mechanic and inspector of car construction, equipment and maintenance; track work and buildings. Also familiar with operation. Thoroughly reliable. Address "No. 549," care of Electric Railway Review, Chicago.

Mechanical and electrical engineer, 14 years' experience. Experienced in power station design and for 14 months acting superintendent of power station railway systems in America. At liberty April 1. Desires superintendent of power or similar position. Would open office in Boston as New England representative of responsible manufacturer. Address "No. 546," care of Electric Railway Review, Chicago.

## POSITIONS WANTED.

Experienced master mechanic desires position. Has thorough knowledge of high-speed electric railway equipment, on third rail or trolley. Is good executive, tactful and able to organize work of departments. Best of references furnished. Will consider position with high-speed interurban or city railway. Address "No. 550," care of Electric Railway Review, Chicago.

Position wanted—The manager of a large railway, lighting and gas plant must make a change in his position owing to an unfavorable climate. Has held managerial positions for 10 years and is thoroughly familiar with the construction, organization and operation of electric railways. Correspondence solicited. Exceptional references. Address "No. 539," care of Electric Railway Review, Chicago.

## POSITIONS OPEN.

Wanted—Electrical salesman who is selling to street railways to take important side line. J. W. Morrison, 29 Griswold street, Detroit, Mich.

Salesmen with technical knowledge, machinery and electrical installation, also auditors and accountants. Salaries \$1,500 to \$5,000. Ambitious men write us, RAPGOODS, 805 Broadway, New York, or 1010 Hartford Bldg., Chicago.

## MISCELLANEOUS WANTS.

Want to buy second-hand equipment, machinery or material? A card inserted in the Electric Railway Review, stating just what you want will bring immediate response. The cost is small—only \$1.20 an inch (measuring 1 inch deep by 1½ inches wide) per insertion. Send orders to Electric Railway Review, 160 Harrison St., Chicago.

## MISCELLANEOUS WANTS.

What have you to sell in the way of second-hand equipment, machinery or material? Buyers read the "For Sale" cards on the following page and there is the place to tell your story. "For Sale" cards are inexpensive—only \$1.20 an inch (measuring 1 inch deep by 1½ inches wide) per insertion. Special rates on contracts for 100 inches or more to be used within one year. Now is the time to send your order to Electric Railway Review, 160 Harrison St., Chicago.

## BOOKS AND PUBLICATIONS.

Wanted—Copy of the Electric Railway Review of January 12, 1907, in good condition. State price in your answer. Address "No. 530," care of Electric Railway Review, Chicago.

We want your friends to read the Electric Railway Review. You will do them—and us—a favor by sending their addresses. We will gladly mail free sample copies. Electric Railway Review, 160 Harrison Street, Chicago.

Wanted—Copy of the Street Railway Review of August, 1903 (Vol. XIII), also complete sets of Vols. X and XI (1900 and 1901). State price, condition and whether latter two volumes are bound or unbound. Address "Street," care of Electric Railway Review, Chicago.

Copies of the Street Railway Review of January and February, 1906, are wanted. Name condition and price. Address "No. 535," care of Electric Railway Review, Chicago.

Copies of the Street Railway Review of March and April, 1904, in good condition for binding are wanted. State price sent postpaid. Address "No. 548," care of Electric Railway Review, Chicago.

## BOOKS AND PUBLICATIONS.

Wanted—Copies of the Street Railway Review of April, 1900, May, 1901, and August, 1903. State price and condition. Address "No. 553," care of Electric Railway Review, Chicago.

Ask us about any book on electric railway and allied subjects. We publish some and sell all that are in print. The Wilson Company, 160 Harrison Street, Chicago.

If interested in any phase of steam transportation, you will find every development covered fully and accurately in *The Railway Age*. It is the leader and acknowledged authority in this field. Ask for free sample copies. *The Railway Age*, 160 Harrison Street, Chicago.

A copy of "The Motorman and His Duties," the standard handbook on the theory and practice of electric car operation, is worth many times its cost to every man interested in the subject. Send for 16-page pamphlet of sample pages. The Wilson Company, 160 Harrison Street, Chicago.

Interstate commerce national legislation to July 1, 1906, is fully covered in our reference pamphlet. It contains the full text of the act to regulate commerce as amended, including the Elkins and Hepburn acts, and of the supplementary act relating to the testimony of witnesses before the Interstate commerce commission. It also contains the texts of the expedition act, the anti-trust act of 1890, the employers' liability act and the safety equipment laws. Difference in type shows the parts expunged from, and the parts added to, the Interstate commerce and Elkins acts by the Hepburn act. This pamphlet is of special value to railway men and lawyers. Mailed prepaid for 25 cents in stamps or coin. Special prices for quantities. The Wilson Company, 160 Harrison St., Chicago.

# The Man The Job

—who wants a job—

—that wants a man—

can get together through the medium of a want ad in the

## Electric Railway Review

The cost is small—only one cent a word per insertion, with a minimum charge of 25 cents. Replies may come in our care, if you like, to be forwarded without charge.

Read the advertisements on this page. If you don't see what you want, ask for it!



FOR SALE:

# Beautiful Summer Resort

With natural lake Serves 40,000 people

Located half way between two prosperous cities on line of inter-urban road and two steam railways.

Can be purchased now at a reasonable price.

Address "No. 551"

Care of ELECTRIC RAILWAY REVIEW, Chicago

**R.W. MARSHALL & CO.**  
 95 and 97 Liberty St., New York  
 Second-Hand Machinery and Equipment  
**ELECTRIC RAILWAY MATERIALS**

**RAILS**  
*Locomotives Cars Etc*  
*Bought & sold*  
*Water & ZELNICKER supply Co.*  
 ST. LOUIS

**FOR SALE CHEAP!**  
 One 14222 eight-wheel locomotive  
 Ten 34-foot 50,000 capacity flat cars  
 Two Greenleaf turntables  
 70 box cars, 40 and 50,000 capacity  
 80 Good Second-hand Bridges  
 Specifications and Blue Prints on application  
**F. A. JOHANN**  
 1624 Pierce Bldg., St. Louis, Mo.

**FOR SALE: Three Car Bodies and Three Pairs of Double Trucks**  
 with or without electric equipment and air brakes; all new and never used. Compelled to sell, as these cars will not operate over a leased line by reason of their width and length.  
**R. W. MARSHALL & CO., 97 Liberty St., New York, N. Y.**

**FOR SALE CHEAP**  
**200 Second Hand STREET CAR BODIES**  
 Vestibule and Open, in elegant condition.  
 Also 1,000 New Car Folding Gates and 300 Car Stoves  
**THE ISAAC JOSEPH IRON CO. OF CHICAGO** 1247 First National Bank Building.

**HEINE SAFETY BOILER CO.**  
 421 OLIVE STREET, ST. LOUIS, MO.  
 Manufacturers of WATER TUBE BOILERS

**NO SNOW TO DELAY CARS**  
 The Russell Snow-Flow is used by more than 50 roads to maintain schedules and prevent blockades.  
 Russell Car & Snow-Plow Co., Ridgway, Pa.  
 Wendell & MacDuffie, Cortlandt St., New York; C. A. Halston, Fisher Bldg., Chicago; Robinson & Cary Co. Saint Paul.  
**IF YOU HAVE A RUSSELL**

**ROSSITER, MACGOVERN & CO. (Inc.)**  
 90 West Street, New York  
**ENGINES** Boilers, Locomotives, Cars,  
New and **GENERATORS** 2nd Hand  
**MOTORS**  
 Transformers, Railway, A. C. & D. C.

<b>P &amp; B INSULATING VARNISHES</b>	Possess the highest insulative efficiency. Meet every requirement in electrical work.
Send for Literature and prices.	<b>P &amp; B ELECTRICAL COMPOUNDS</b>
<b>THE STANDARD PAINT COMPANY,</b> 100 WILLIAM ST., NEW YORK.	<b>P &amp; B INSULATING TAPE</b>
BRANCHES: CHICAGO, ST. LOUIS, KANSAS CITY, PHILADELPHIA, BOSTON, NEW ORLEANS.	

**For Sale** Cards produce results in the Electric Railway Review

# Armstrong Journal Oiler

SAVES OIL SAVES MONEY  
 PREVENTS HOT BOXES



A Perfect Journal Lubricator

Will last several seasons without renewal, like waste; and can not shake away from the journal. Catalogue and trial sample for the asking.

**Armstrong Oiler Co.**  
 31st and Chestnut Streets - PHILADELPHIA

**OHIO BRASS COMPANY**  
 MANSFIELD, OHIO Agents West of Pennsylvania

**THE ARNOLD COMPANY**  
 ENGINEERS-CONSTRUCTORS  
 ELECTRICAL - CIVIL - MECHANICAL  
 101 LA SALLE STREET  
 CHICAGO

**A. L. REGISTER & CO.**  
 Engineers and General Contractors--Electric Railway  
 112 North Broad St. PHILADELPHIA, PA. Established 1889

**SHIMER & CHASE CO.**  
 Experienced Promoters of Electrical Railway Projects  
 Correspondence Solicited OMAHA, NEB.

**H. M. Bylesby & Company**  
 Incorporated  
 ENGINEERS  
 American Trust Bldg., Chicago

**CENTRAL INSPECTION BUREAU**  
 Inspection of Rails, Ties, Cars, Motors, Bridges, Buildings, Etc.  
 17 STATE STREET - - - NEW YORK CITY

Design, Construct and Operate  
 Railway, Light, Power and  
 Hydraulic Plants

EXAMINATIONS AND  
 REPORTS

**LINE MATERIAL**  
 ELECTRIC SUPPLIES FOR RAILWAYS, POWER PLANTS, ETC.  
 THE CREAGHEAD ENGINEERING CO., 348 Main Street, Cincinnati, Ohio

**J. G. WHITE & COMPANY**  
 INCORPORATED  
**Engineers, Contractors**  
 43-49 Exchange Place,  
 41-43 Wall Street New York, N. Y.  
 Principal Philippine Office: Manila, P. I.

**THE CURTAIN SUPPLY CO.**  
 CAR CURTAINS  
 CHICAGO, 85-93 Ohio Street 1819 Park Row Bldg., NEW YORK

**HARTSHORN'S SPRING SHADE ROLLERS**  
 Used the World Over Wherever Cars are Run  
  
 STEWART HARTSHORN CO.  
 EAST NEWARK, N. J.

**Complete Plants for the Rapid  
 Handling of Material**  
 Every Sort of Hoisting Apparatus  
**BROWN HOISTING MACHINERY CO.** Cleveland, Ohio

**Gongs** For Street Cars **Bells**  
 G. C. REITER, Canton, Ohio

**HART CONVERTIBLE BALLAST GONDOLA AND CONSTRUCTION CAR**  
**RODGER BALLAST CAR CO.,** Railway Exchange, CHICAGO

**The Roberts & Abbott Co.**  
 E. P. ROBERTS ENGINEERS W. H. ABBOTT  
**Electric Railways, Light and Power**  
 Complete Industrial Plants Water Power Development  
 CLEVELAND CHICAGO PHILADELPHIA BALTIMORE

**TRACKLAYING BY MACHINERY**  
 SIMPLE, RAPID AND ECONOMICAL  
**D. F. HOLMAN RAILWAY TRACKLAYER CO.,** 1102 Elsworth Bldg., Chicago

**Surface, Jet and Barometric Condensers  
 Edwards Air Pumps Centrifugal Pumps  
 Water Cooling Towers**  
**Wheeler Condenser & Engineering Company**  
 West and Cedar Streets, NEW YORK Works, CARTERET, N. J.  
 Mosadnock Block, CHICAGO, ILL.

THE  
**Bellamy Vestlette**  
 For Street Railway Conductors  
**ABSOLUTELY SAFE. Money cannot be  
 lost or stolen from these pockets  
 OVER 150,000 IN USE**  
 Saves the price of a coat yearly. Conductor's  
 uniform always presentable. Adopted as a part  
 of the uniform by over 200 Street Railway Com-  
 panies. Price \$2.00, sent to any address prepaid,  
 where we have no agent. Agents wanted on  
 every line.  
**The Bellamy Vestlette Mfg. Co.,** Cleveland, O.  
 and A. F. JURY, 285 Yonge St., Toronto, Canada  
 Patented April 27, 1897



**The Fred. J. Meyers  
 Mfg. Co.** Hamilton, O.  
 Largest Manufacturers in the World of  
 "TICKET and CONDUCTOR"  
**PUNCHES**  
 Send for catalog of 75 dif-  
 ferent styles of punches  
 with 1000 different dies.  
 Write for special prices.

**E N G I N E E R S**

who wish to be numbered among the  
 elect should be represented on this page

The cost is small—ask us about it

**ELECTRIC RAILWAY REVIEW**  
 160 Harrison Street, Chicago

**VOLTALAC**  
 TRADE MARK  
**FOR INSULATING ARMATURE  
 AND FIELD COILS**  
 Almost Every Big Electric Railway  
 in the U. S. and Europe uses it  
**STANDARD VARNISH WORKS**  
 LONDON NEW YORK CHICAGO

**CAR ADVERTISING** — *Barron & Collier*  
**ALMOST EVERYWHERE**  
 Flat Iron Building, New York.

THE RAILWAY SPECIALTY AND SUPPLY CO. **WHERE? CAN WE USE SMITH IMPROVED NUTS ON CROSSINGS** Great Northern Building CHICAGO

**HOT WATER HEATERS for Cars**  
 THE PETER SMITH HEATER CO., Detroit, Mich.

**BRAKESHOOES**  
 STANDARD BRAKESHOE COMPANY  
 GEN'L OFFICES & WORKS - AURORA, ILL. CHICAGO OFFICE 319 IVY EXCH.

**GEARS AND PINIONS**  
 FOR ALL TYPES OF MOTORS  
 THE VAN DORN & DUTTON CO., CLEVELAND, OHIO

**RE-ENFORCED SPOKE WHEELS**  
 For City and Suburban Cars  
 ST. LOUIS CAR WHEEL CO., St. Louis, Mo.

**GRIFFIN WHEEL CO.**  
 CHICAGO  
 CHILLED IRON CAR WHEELS IRON OR STEEL AXLES

**WHEEL TRUING BRAKE SHOES**  
 Repair Crippled Wheels While Running  
 THE WHEEL TRUING BRAKE SHOE CO., Detroit, Mich.

WRITE TO **MODEL STOKER COMPANY** DAYTON OHIO  
 for detailed information about the best  
**AUTOMATIC SMOKELESS FURNACE**

**VALVES—FITTINGS—STEAM SPECIALTIES**  
**CRANE CO.**  
 CHICAGO  
 ESTABLISHED 1855

**THERMIT WELDING FOR RAIL JOINTS**  
 Fully described in pamphlet No. 13-Q.  
**Goldschmidt Thermit Co.**  
 90 West St., New York  
 432-436 Folsom Street - San Francisco



You buy and scrap 25 per cent less material when you use  
**Ideal Trolley Wheels!**  
 Unlike the cast wheels you have used in many other important particulars, too. Write for detailed description.  
 Buffalo **LUMEN BEARING CO.** Toronto

**SOLENOIDS AND MAGNETS**  
 for any purpose; lift and travel guaranteed.  
 Special electrical work and motors.  
**THE PORTER MFG. CO.** 29 Griswold Street DETROIT, MICH.



**CONSOLIDATED CAR-HEATING COMPANY**  
 NEW YORK CHICAGO  
**Office and Station Heaters** **ELECTRIC HEATERS** **Independent Vestibule Heaters**  
 For All Classes of Cars

**Over 25,000 miles in use** **Rolled from Best Quality Steel**





**CONTINUOUS JOINT** **WEBER JOINT** **WOLHAUPTER JOINT**

**Catalogs at Agencies**  
 Baltimore, Md. Portland, Ore.  
 Boston, Mass. Seattle, Wash.  
 Chicago, Ill. St. Paul, Minn.  
 Denver, Colo. St. Louis, Mo.  
 Pittsburg, Pa. Troy, N. Y.  
 London, Eng. Montreal, Can.

HIGHEST AWARDS—Paris, 1900; Buffalo, 1901; St. Louis, 1904

**THE RAIL JOINT COMPANY**  
 General Offices: 29 West 34th Street, New York City  
 Makers of Rail Joints for Standard and Special Rail Sections, also Girder, Step or Compromise, and Insulating Rail Joints, protected by patents in United States and Foreign Countries.

Additional safety and economy in **Track Maintenance** has been proved by the use of Continuous, Weber and Wolhaupter base-supported rail joints—after ten (10) years' service, having a record of over **25,000 miles** in use—the extent of which is evidence of their excellence.

**The Lindsley Brothers Company**  
 Producers and Shippers of **WESTERN CEDAR POLES** and Manufacturers of **RED FIR CROSS ARMS**  
 Eastern Sales Office, Monadnock Bldg., CHICAGO SPOKANE, WASHINGTON

**G. H. BARNES HARDWOOD LUMBER CO.**  
 Office and Yard: Main and Warren Sts., ST. LOUIS, MO.  
 Ties, Car Oak, Poplar, Ash, Cherry, Plain and Quartered Oak

One cent a word for want ads in the  
 Electric Railway Review

**C. H. WORCESTER CO.**  
**CEDAR POLES**  
 PRODUCERS AND WHOLESALERS  
 Suite 1710 Tribune Building CHICAGO

**Idaho Cedar Poles**  
 PACIFIC COAST POLE CO. SPOKANE, WASH.

If you want **POLES** Michigan or  
 good Western Cedar  
 at the right prices and prompt delivery, write us.  
**NATIONAL POLE COMPANY**  
 SEATTLE, WASH. ESCANABA, MICH.

We have in our Chicago Yard avail-  
 able for **RUSH SHIPMENTS** a **SE-**  
**LECTED STOCK OF POLES and TIES**  
**NAUGLE POLE AND TIE CO.**  
 Chicago Office, 226 La Salle Street

**CHESTNUT POLES**  
 Cedar, Oak and Chestnut Ties  
 FROM OUR OWN TIMBER LANDS  
**THE ADVANCE LUMBER CO.**  
 CLEVELAND, OHIO

**HUMBIRD LUMBER CO., Ltd.**  
**Cedar Poles AND Piling**  
 SANDPOINT, IDAHO.

We are Producers and Wholesale Dealers in Western  
**CEDAR POLES**  
 Yards in Washington, Idaho, Montana  
 and British Columbia  
 WRITE US FOR DELIVERED PRICES  
**CHURCHILL CEDAR CO.,** Box 1409, Spokane, Wash.

**POLES and PILING**  
 20,000 35s and 40s  
 Ready to Ship at Once  
**S-E. Missouri Cypress Co.,** Campbell, Mo.

**THE AMERICAN FROG & SWITCH CO.,** HAMILTON, OHIO  
 SPECIAL TRACK WORK FOR ELECTRIC RAILWAYS

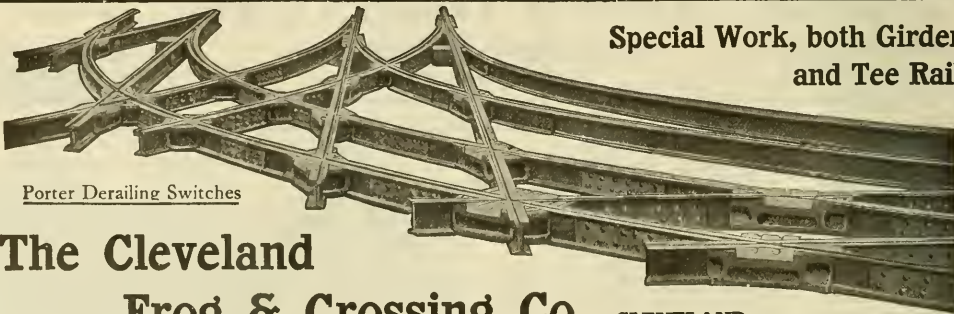

Porter Derailing Switches

Special Work, both Girder  
 and Tee Rail

**The Cleveland  
 Frog & Crossing Co.,** CLEVELAND

**M**OST people have about all they can do to keep track of their own business—that is why it is necessary to tell them about yours.

It is only by telling them about the attractions of your road and your territory—telling them systematically and frequently—that you can keep them interested and obtain the maximum amount of business.

The Van Valkenburgh Advertising Service helps you to tell your story systematically, convincingly and economically. Let's talk the matter over.



**E. C. Van Valkenburgh**  
**Promotional Advertising**  
**for Electric Railways**  
 2117 West 102d Street, Chicago

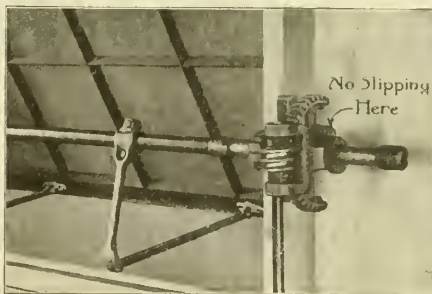

**The Ventilation**

of your Shops, Foundries and Car-Barns is made especially effective by a speedy, positive and easily manipulated

**Sash Operating Apparatus**

which automatically locks the sash at any position. *Let us send you our catalogue*

**LORD & BURNHAM COMPANY**  
 Irvington-on-Hudson, N. Y.

**FOSTER SUPERHEATERS**

INSURE UNIFORM SUPERHEAT OF TEMPERATURE SPECIFIED

**POWER SPECIALTY COMPANY**  
 111 Broadway, New York

**Railway Steel-Spring Co.**

GENERAL OFFICES: 71 Broadway, NEW YORK

Springs  
 Steel-tired Wheels  
 Latrobe Motor Wheel Tires

BRANCHES: Chicago, Detroit, Louisville, Mexico City, St. Louis, St. Paul, Washington

**GREEN TRAVELING LINK GRATES**

- Highest Capacity
- Highest Efficiency
- Automatic Smokeless
- Labor Saving
- Cheap Fuel

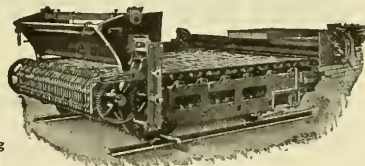

**GREEN ENGINEERING CO.**

Main Office: Commercial National Bank Bldg., Chicago, Ill.  
 BRANCH OFFICES: Pittsburgh : St. Louis : St. Paul : Louisville  
 General Foundry Work a Specialty

**Advertise in the Electric Railway Review**

To get an employe.  
 To secure a job.  
 To sell second-hand machinery, cars, etc.

Want Ads cost only one cent a word per insertion. Special rates on "For Sale" Cards—ask about them.

**Pantasote**

The National Standard for Car Curtains and Car Upholstery.

**AGOSOTE HEADLINING**

The only headlining made in one solid piece. Will not separate, warp or blister. Waterproof and homogeneous.

**THE PANTASOTE COMPANY**

707 Fisher Building, Chicago, Ill. 11 Broadway, New York

# ROLLING DOORS

In Steel, Wood or Bronze

FOR CAR BARNs, FREIGHT SHEDS, ETC.

Made by the

**JAS. G. WILSON MFG. CO.**

New York Office: 3 W. 29th Street

ESTABLISHED 1876

Incorporated 1903

# TRACK DRILLS

MADE IN TWO SIZES

With automatic friction feed. Lower gears cased in to protect them from dirt.

Send for circular and prices.



**FRANCIS REED CO.** WORCESTER, MASS.

# Kinnear STEEL Rolling Doors FOR CAR HOUSES



Operate Easily, Speedily, Satisfactorily and are very durable. Write for Catalog

**The Kinnear Manfg. Co.**

COLUMBUS, OHIO

BOSTON  
85 WATER ST.

CHICAGO  
112 CLARK ST.

PHILADELPHIA  
1011 CHESTNUT ST.

# Satisfaction Always Follows BONDING or REBONDING

when done by the modern and economical methods—

## Electric Brazing and Copper Welding

Their superiority can be easily demonstrated on your own road if you give us the opportunity.

Names of users cheerfully furnished. Ask them whether they are satisfied.



**THE ELECTRIC RAILWAY IMPROVEMENT COMPANY**

6005 Carnegie Avenue

CLEVELAND, OHIO

# Electric Railway Review

PUBLISHED EVERY SATURDAY BY THE WILSON COMPANY, CHICAGO

Entered as second-class matter January 5, 1907, at the postoffice at Chicago, Ill., under the act of March 3, 1879.

160 Harrison Street, Chicago  
150 Nassau Street, New York  
1529 Williamson Bldg., Cleveland

VOL. XIX  
No. 9

CHICAGO, FEBRUARY 29, 1908.

Whole No.  
253

Subscription: Domestic . . . \$2  
Foreign . . . \$5  
Canada . . . \$3.50

The new 50-mile interurban line of the Oregon Electric Railway Company, which has just been completed between Portland and Salem, Ore., appears to have every opportunity for a most successful future. From the illustrations accompanying the description of the new road on another page of this issue, it will be noted

## A New Road with a Future.

that the construction is of an especially substantial nature throughout. As the road is to be operated in direct competition with an important steam railroad, which it closely parallels for the entire distance, its success depends on its possessing all the advantages of the steam road, together with the additional benefits, such as low rates and frequent service, which are incident to the electric railway. The Oregon Electric Railway has therefore been constructed and is operated according to steam railroad practice under the management of men whose experience has been in that field of transportation. Although the population between terminals is only that of a thickly settled agricultural community, the fact that the road connects the capital and the metropolis of the state seems to assure a good passenger traffic from the start, especially in view of the fact that the competing steam service is inadequate, and the opportunities for developing a large freight business in such a productive region as the Willamette valley seem almost unlimited.

Mr. Arnold's report to the public service commission at New York recommending the use of additional side doors on the

## Car Design and Traffic Capacity.

Interborough subway cars illustrates in a most convincing way the immense importance of studying the relations between car design and carrying capacity. If the estimate is correct that the average express

train stop in the subway can be cut from 55 to 30 seconds, it is clear that here will be a great saving in time ordinarily wasted. It has been shown repeatedly that the best powers of expensive equipment—motors of great capacity, quick-acting brakes and carefully designed and adjusted automatic multiple-unit control—cannot be utilized properly in maintaining a high schedule speed unless the length of station stops is short. The root of the whole trouble of service delays and overcrowding on city lines where train service handles the traffic is this problem of stops. Given the extra side doors, the pay-as-you-enter features of progressive movement in the subway car and smooth approaching and departing movements on the platforms ought to be readily secured. It practically is impossible to keep clear the platforms of cars without side doors, as passengers can always offer the excuse that they intend to leave at the next station. By putting in end side doors, however, there is no question that the entering platforms would be much freer, in many cases clear, since passengers will pass rapidly into the empty car vestibule and can move at once into the space which has been made vacant by the leaving passengers. In dealing with traffic problems of this character the most apparently trivial conditions are liable to assume great importance. A small feature which affects one passenger favorably or adversely carries large weight when multiplied by many thousands of repetitive occurrences per day. Neither car nor station design can be

separately considered. Control of the traffic both inside and outside the car may perhaps never be ideally perfect, but there is room for a great deal of further study along hopeful lines.

The conference between the members of the Railroad Commission of Indiana and the operating officials of electric railroads within that state on February 18 was

## Uniformity in Rules in Indiana.

not called in response to any great public outcry against corporate management. If it had been arranged as a sequel to a senseless cry against the railways, there would not be the promise of fruitful results from co-operation which now exists. As the report of the meeting in last week's issue of the Electric Railway Review indicated, the commission had ascertained, primarily, the complete absence of uniformity in operating rules of the different roads in the state. Its knowledge had been gathered largely by inspectors who were trained in railway service, the chief of whom, Mr. Shane, commendably stated that the railways were entitled to benefit from the experience of employes who received their valuable training and education while in the railway service. It is right that rules, the simpler the better, should be framed for the government of employes, and the committees have a serious task before them to recommend practices which will be adaptable to the varying needs of all the roads in the state. But a good start has been made, and when the reports of the committees are presented and adopted by the roads of the state, their effect should be, if employes are obedient, to lessen the risk of accidents and eliminate the chance that some day, through a combination of unfortunate developments, court proceedings will take place that would be a source of eternal regret.

While the manifest advantages of electricity as a motive power and the economy of propelling a large number of units

## Limitations of Electric Power.

by power generated at a central station are universally recognized, it is easy to lose sight of the occasional drawbacks inherent in this method of propulsion. This fact is well brought out in a recent editorial in The Chicago Daily Tribune in commenting upon two recent accidents on important electric railroads in which traffic was entirely suspended for a considerable period of time, in each case as the result of a trifling mishap. In the first case, on a Chicago elevated road, one of the main feeder cables supplying a section of the main line became grounded during a storm through a cracked insulator and traffic over some two miles of line was tied up for about two hours until the source of the trouble could be located and the defect repaired. In the second case, in the New York subway, a stray bit of iron caused a short circuit from the third rail to the track rail, keeping the passengers in fear and in darkness and the trains at a standstill on a large section of the road for over an hour. Such incidents not only indicate the necessity for the most vigilant inspection on electric roads in order to insure uninterrupted service, but they should also increase our admiration for those who have so successfully harnessed such a difficult form of energy to handle as electricity and made it serve their

purposes, to the everlasting benefit of humanity. As the Tribune expresses it: "These things being considered, the wonder is that the electrically operated roads have so few accidents of the sort rather than that an occasional delay comes to disturb schedules."

The recent report of the Boston transit commission upon the subject of traffic congestion in the streets is of interest to electric railways operating in cities handicapped by the lack of wide thoroughfares.

**Street Traffic Congestion in Boston.** The narrow and crooked streets in Boston are constantly a great handicap to the handling of surface traffic by the Boston Elevated Railway. The report charges practically all the congestion on the streets to blocking by teams. The removal of certain cars from the streets upon the completion of the underground routes will tend to reduce congestion, but if the vehicular traffic is properly handled there is little doubt that the whole situation will be vastly improved. The transit commission urges the prompt removal of snow; the separation on certain routes of heavy and light teaming traffic; the restriction of curb markets and push carts; the relocation of certain express offices on broad streets not traversed by electric cars; denial of permits for stands of teams and carriages on congested streets; restriction of hours of delivering coal and ice, collecting refuse, etc.; regulation of the movement and stopping of slow and fast vehicular travel on narrow streets, and the confinement of traffic on certain streets to one direction of motion. The benefits of freer movement inside the congested district of a city are far-reaching, for the result is a stimulation of travel all along the line, both for short riding and between suburban points and the business center.

#### INCREASES IN FARES.

The movements to increase rates of fare on various urban and interurban electric railways are born of necessity. Many incidental causes of such movements will appear, but none is more important in its bearing on the industry as a whole than the failure to appreciate that maintenance charges, although light in the earliest years of an expanding electric railway system, are certain to become an insistent and necessary factor in operating expenses, and that the lapse of franchises must be reckoned with.

The most recent general movement for advances in fares has taken place in Massachusetts, where, with indeterminate franchises and strict laws governing the issue of securities, there has been a deplorable failure to realize profits from investments in street railways. The unit of fare on the Lexington & Boston Street Railway was increased from five to six cents on February 1, 1908. This company operates 32 miles of track and connects Waltham, Lexington, Concord, Billerica, Arlington, Bedford and Wolburn. The Blue Hill Street Railway, which operates 19.6 miles of track from a connection with the Boston Elevated Railway at Mattapan through Canton to Stoughton, increased its rate of fare from five to six cents on January 5 last. Stone & Webster, general managers of this road, state (Electric Railway Review of February 22, 1908, page 237) that as a result of this change the gross earnings have increased so far 8 to 10 per cent, while in view of other conditions a decrease would naturally be expected. The Taunton & Pawtucket Street Railway has also increased its rates.

In its application the theory that the rate is what the traffic will bear relates more to freight rates than to passenger rates, and to steam railways more than to electric railways. The urban street railway fare is usually set at not over five cents for a single ride. This amount has been arbitrarily fixed in strange disregard of any principles and without rela-

tion to the length of haul, density of traffic or term of franchise, but it is not more inconsistent than the rates established with the opening of many interurban railways. A rate of one cent per mile on an interurban road, for instance, must be admittedly inadequate or adequate in the beginning. If the rate is presumed to be inadequate it presupposes either (1) increase in the density of traffic to a point which will make such a rate profitable or (2) advances in rates when traffic has been drawn from competitive sources and the territory has been built up. If such a rate was permitted because the management of the property did not appreciate that the true cost of operating would include heavy charges under maintenance for renewals and replacements, the result would be unfortunate alike for the owners, creditors and passengers of the railway. If the management advertised rates that were known to be inadequate while the purchase of a right of way was in process of negotiation, there would be great risk of the establishment of such rates as the consideration for limited-term franchises granted by municipalities. Such franchise-bound rates would thereafter be the maximum gross revenue possible on parts of the system, although there might be flexibility concerning rates on other parts of lines. Where rates are inadequate at the commencement of operation and an anticipated density of traffic fails to materialize, increases must be made when they are lawful unless the enterprise is to fail. Resort is not infrequently had to advances in rates because of unexpected traffic poverty of the section traversed, but increases are sometimes made in pursuance of a policy, framed in advance, to establish low rates and leave them in force while the territory is undergoing a certain measure of development, the plan being to increase rates later. Such a policy is unwise for the reason that it antagonizes the public and may lead to permanent bad feeling.

The attitude and the decisions of the Massachusetts railroad commission on the subject of fares have not been hostile to the railways. In its thirty-ninth annual report, covering the year ended June 30, 1907, the commission states that "among the smaller companies, especially those serving sparsely settled communities, the period has arrived when considerable sums of money must be spent for repairs and renewals. Many have been unable to earn a sufficient sum above their operating expenses and fixed charges to place them in the dividend paying class and the problem in operation will be not only that of paying dividends, but of making renewals of track and replacements of rolling stock without impairment of capital." The commission also mentions the essential connection between an adequate service and a fair return upon money invested and suggests to the companies the wisdom of proper provision in the present for the inevitable needs of the future. Recent decisions of the commission respecting changes in fares are consistent with its policy as here set forth. In a decision rendered on April 27, 1906, concerning the action of the Boston & Northern Street Railway Company, which had increased the cash fare between Melrose Highlands and Boston from 5 to 10 cents, at the same time placing on sale 10-trip tickets for 75 cents, the commission held that no railway "can carry passengers nine miles for five cents over an interurban railway constructed, maintained and operated like this, and at the same time out of earnings pay \* \* \* a fair return upon investment."

To consider only the cost of operation—i. e., conducting transportation and general expense—disregarding the inevitable expense of maintenance of way and structures and equipment, is to invite disaster. From the moment of operation of an electric railway the property begins to depreciate, and provision for a loss which is undeniable should be made. If the operating expenses fail to make provision for the loss of capital investment which occurs with the passage of time, they do not accurately show the cost of furnishing the transportation service for which the company was organized and its investment made; and neither the owners of the property



nor the people in the communities served can be given an accurate statement of the true cost of providing the service. It follows that when such figures are used as the basis for determining rates, disappointment and disillusion must almost certainly result.

Some of the interurban railways in the central west are confronting the same problem of inadequate fares which has arisen in Massachusetts. It is possible that realization of the necessity for increases in fares would not have occurred at this time had it not been for the decline in traffic which is now reported by most lines.

If increases in passenger fares are inevitable there is no wiser time to announce them than now. The conditions of traffic and general business afford a justification for such a step, which should be appreciated by the public and any public commissions that assume jurisdiction over such matters.

**ANNUAL REPORTS.**

**Chicago & Oak Park Elevated Railroad.**

The deficit of the Chicago & Oak Park Elevated Railroad in the year ended June 30, 1907, after provision for taxes, interest and rentals, was \$63,945. This amount is less than the deficit in any one of the three preceding years. The principal results of operation compare as follows:

Year ended June 30—	1907.	1906.	1905.
Gross earnings .....	\$892,569	\$890,554	\$842,944
Operating expenses .....	527,180	505,538	505,929
Net earnings .....	\$365,389	\$385,016	\$337,015
Interest, taxes, etc. ....	429,334	477,794	447,862
Deficit .....	\$ 63,945	\$ 92,778	\$110,847
Operating expenses, per cent of gross earnings .....	59.07	56.77	60.02

The detailed statement presented to stockholders by Clarence A. Knight, the president, shows an increase in gross passenger earnings of \$6,229 and a decrease in miscellaneous earnings of \$4,214. The change in the latter item was due to a loss in the revenue from advertising, news and vending privileges and rentals from real estate. Mr. Knight attributes the small increase in passenger earnings to the electrification of the Madison street surface line of the Chicago Union Traction Company and introduction upon that line of modern cars, and also to the service afforded by modern cars on the Lake street surface line. Mr. Knight states:

Our passenger earnings have increased at the various stations beyond the 4-mile zone and show a decrease inside of that zone. That is, our passenger earnings increased from Fortieth street west, and decreased from Fortieth street east. Another factor which resulted in the loss of passengers was the removal of the plant of Sears, Roebuck & Co. from the line of this company. A loss of traffic may also be accounted for by the lack of facilities upon the Union loop. The loop company has been endeavoring to obtain an extension of the platforms of the loop stations and other improvements, which would greatly facilitate the movement of trains around the loop.

The cost of conducting transportation was \$404,731, or 45.3 per cent of gross earnings, an increase of \$13,088 over the previous year. The larger expenditure is due in part to a new wage arrangement with employes in the train service. The maintenance expenditures were as follows: Equipment, \$50,550; way and structure, \$21,405. Taxes were \$47,973. The outstanding notes payable amounted on June 30, 1907, to \$2,174,500. Interest charges increased \$8,984 over the preceding year, largely as a result of the prevailing higher rates of interest.

The train mileage for the year ended June 30, 1907, was 1,678,229 miles, and for the preceding year it was 1,620,208 miles. The car mileage was 4,968,900 miles, and for the preceding year it was 4,868,240.

The management hopes during the coming year to extend the road through the territory lying west of Oak Park, believ-

ing that such an extension would add sufficient traffic to wipe out the annual deficit.

**Louisville Railway Company.**

Operating expenses and taxes of the Louisville (Ky.) Railway Company absorbed 66.3 per cent of gross earnings and other income in 1907, as compared with 60.3 per cent in the preceding year. In his report to the stockholders T. J. Minary, the president, states that while the results were affected by the strikes and general business situation, the results should be entirely satisfactory when compared with those of companies in other cities which have experienced similar troubles. The figures for three years compare as follows:

	1907.	1906.	1905.
Gross earnings and other income .....	\$2,668,146	\$2,592,996	\$2,355,820
Operating expenses and taxes .....	1,767,948	1,563,314	1,422,952
Net earnings .....	\$ 900,198	\$1,029,682	\$ 932,868
Charges .....	368,126	350,271	351,504
Net divisible income .....	\$ 532,072	\$ 679,411	\$ 581,364
Preferred dividends .....	125,000	125,000	125,000
Balance .....	\$ 407,072	\$ 554,411	\$ 456,364
Common dividends .....	371,738	471,706	376,707
Surplus .....	\$ 35,334	\$ 82,705	\$ 79,657
Special appropriations .....	16,327	70,000	65,000
Surplus .....	\$ 19,007	\$ 12,705	\$ 14,657

The gross earnings and other income in 1907 were derived from the following sources: From city passengers, \$2,497,467; from interurban passengers, \$128,126; other income, \$42,553. Taxes amounted to \$216,000. Mr. Minary mentioned several matters of interest to the shareholders. The company has acquired the franchise for a new double track which will be used by the Northern Indiana Traction Company for its entrance to the city. Fifty new cars were added to the equipment, and the car house and repair shops have been enlarged and improved.

**A WARNING.**

To the Editors:

The accompanying item, if published in your paper, will be of interest to all your railway patrons. Two crooks have worked this company and its friends for timetable advertisements. A number paid for the advertisements in advance.

All railroad officials should beware of the "Official Folder Timetable" man. His mission is to see you on important business. He offers to supply you for a year with timetables free of charge, you allowing him to advertise in the same. He agrees to pay you 15 per cent of the net receipts in consideration for a letter of introduction. He presents to you letters of introduction containing the signatures of prominent railway officials and you are to copy one of these letters. This letter seems very simple, but, by signing it, you make him your special representative. This letter is the "joker" and binds you to fulfill whatever agreements he sees fit to make. He collects cash for the advertisements from whomsoever he can and leaves his victims for you to satisfy.

It is the duty of someone to catch and punish these crooks.

THOMAS HAWKEN,

General Manager Rockland Thomaston & Camden Street Railway.

Rockland, Me., February 22, 1908.

The Duluth Street Railway Company has removed its general offices from the power house building to a new office building at the northeast corner of Twenty-seventh avenue west and Superior street. The office building has been in process of erection since early last fall. It is located on the corner of the block containing the car barn and the company's shops. The general offices have been maintained at the old power house ever since the company began the use of electricity for its motive power.

THE OREGON ELECTRIC RAILWAY.

On February 1 the Oregon Electric Railway Company opened for operation the first portion of its proposed system, an interurban line connecting the cities of Portland and Salem, Ore., a distance of 59.72 miles. The company was incorporated on May 15, 1906, under the laws of Oregon, and absorbing at that time the Willamette Valley Traction Company, which held franchises covering part of the present right of way. The capital stock of the company is \$10,000,000. During the next few months it is proposed to extend the line from Portland to Hillsboro and Forest Grove, 22 miles. An ultimate extension from Salem up the Willamette valley as far south as Eugene is also contemplated, which will make a total of 135 miles.

The accompanying map shows the location of the line. From the Jefferson street terminal in Portland the line runs almost directly south, paralleling a line of the Southern Pacific Company to a point about 2½ miles south of Portland, thence turning west through a magnificent farming country to Garden Home. From Garden Home the line runs south again to Tualatin, where it crosses the Southern Pacific and then continues through fertile land to Wilsonville, at which point it crosses the Willamette river on a steel bridge 110 feet above the low water line, thence making a tangent of 19½ miles through small forests and fertile farming country to a point near Chemawa, at which point it again turns south through Chemawa and toward Salem.

While the only intermediate towns of any size are Tualatin and Wilsonville, the entire section traversed is a

traditions of the Indians, this idea will be carried out to a certain extent in the advertising of the road.

As the line ends for the present at Mill street in the city of Salem permanent terminal facilities at that point are being arranged for. At Jefferson street, Portland, the company owns an entire city block. On one corner of this block a building has been erected which contains six storerooms, a waiting room, baggage and express room and ticket office. The remainder of the block is to be used for a freight house, team tracks and other terminal purposes that may be required.

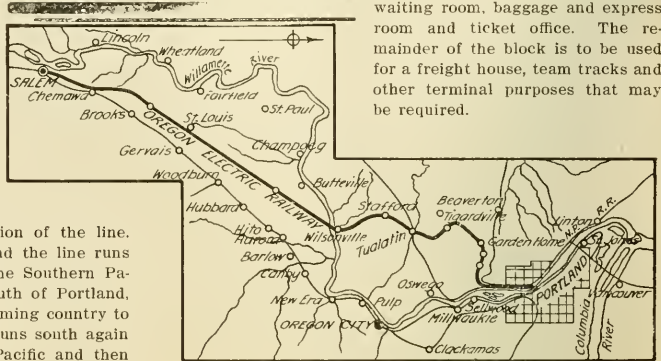

Oregon Electric Railway—Map of Present Line.

This new interurban line is the outcome of the steady growth of business and population in the Willamette valley, which is very fertile and produces great quantities of fruit, hops, grain and vegetables, besides forest products, etc. The demand for better passenger service between Portland and Salem was principally instrumental in bringing the road into



Oregon Electric Railway—Long Timber Trestle on Curve Near Portland, 100 Feet High.



Oregon Electric Railway—Steel Deck Bridge over the Willamette River at Wilsonville.

thickly settled farming community and there will be numerous stations established at cross roads. Under the schedule which was put into effect at the time of the opening of the road there are 21 stations, including the terminals of Portland and Salem. In naming the new stations the management has selected names of Indian origin. Inasmuch as the Willamette valley occupies a prominent place in the early history of Oregon, especially in connection with the movements and

existence. The service between these cities will be quicker, cheaper and more frequent than is at present maintained on the competing steam road, and it is expected that the electric company's equipment will be taxed to its capacity. Salem being the capital of the state and Portland the metropolis the daily traffic between the two places is quite heavy at all seasons, but especially so during the sessions of the legislature and at the time of the state fair at Salem. On one day

during state fair week last year the Southern Pacific Company was obliged to turn away over 2,000 passengers at Portland on account of lack of equipment and service.

#### Sources of Traffic.

For some time the Southern Pacific Company has been unable to take care of traffic offered in this district. Freight shippers have suffered because of the inability of the railroad company to furnish sufficient cars, or to move cars promptly. The passenger service has also been unsatisfactory by reason



Oregon Electric Railway—19½-Mile Tangent.

of the trains being habitually late and overcrowded, making the running time far behind the schedule between valley points and Portland. The Oregon Electric Railway will do much to relieve this situation at points served by both lines. The electric line crosses the Southern Pacific Company's west side line at Tualatin and runs parallel to the main line practically



Oregon Electric Railway—Long Timber Trestle Near Portland.

the entire distance from Wilsonville to Salem at a distance of from one to four miles, so that it will be possible for most shippers in this territory to deliver their products or for passengers to travel via either line.

In the past much of the fruit crop of this region has been wasted on account of the inability of the farmers to get it to market, but with this new outlet this fruit can be easily and profitably marketed. It is also expected that there will be several canneries erected along this line to utilize the fruit which does not find a ready market. Already large farms along the line are being divided into 5 and 10 acre patches for truck gardening and fruit culture. Moreover,

the onion raising industry is rapidly becoming an important factor in Willamette valley activity and there will be considerable business derived from this source all along the line. Hops are also grown extensively in this section and it will require considerable equipment to move them as well as to transport the pickers when the crop is ready to harvest.

The commodity which will probably require the greatest attention from the management will be cordwood. There are large tracts of woodland adjacent to the line where the timber is not heavy enough for logging but which can be profitably cut into cordwood and shipped to Portland, where there is a constant demand for it. One shipper alone offered 1,300 cars of this class of freight. One sawmill is already located on the line at Tualatin and there are good prospects of more in the near future.

Freight will be interchanged with steam roads at connecting points. Arrangements have been made with the United



Oregon Electric Railway—Transmission Bracket and Catenary Construction on Curve.

Railways Company in Portland for the handling of freight cars between the Jefferson street terminals of the Oregon Electric Railway and the North Portland terminals of the Northern Pacific Railway, Spokane Portland & Seattle Railway and the Harriman lines. As the United Railways Company's track runs directly through the wholesale district of Portland this will afford a splendid opportunity for the wholesale houses to ship direct to points in the Willamette valley. At present there are twelve 400-foot and two 600-foot spurs, also ten 400-foot and four 600-foot passing tracks for the accommodation of freight and the handling of passenger trains, besides the team tracks and terminal yards at Jefferson street, Portland, and the yards near Salem.

Aside from the advantages to be derived in the way of regular freight and passenger business the new road will add another facility for reaching the many points of interest around Portland. This city is already noted for the many enjoyable side trips which are at the disposal of its citizens and the many tourists which visit the northwest every year.

The snow covered peaks in the Cascade mountains can be seen from all parts of the valley on a clear day. The summit of the coast range of mountains can be seen on the west, while in between lies the broad fertile valley studded with farms and woodlands and intersected by sparkling streams which have their source in the perpetual snow of the mountains. An excellent view of Portland is obtained from the hill near South Portland and on clear days Mt. Hood, Mt. Adams, Mt. St. Helens and Mt. Rainier are in full view. An especially pleasing view is that looking down the Willamette river toward Mt. Hood from the Wilsonville bridge. The Oregon Electric Line traverses some of the most picturesque portions of this valley and makes it an easy matter for picnic parties to spend a day in the country.

#### Track and Roadway.

The track and roadbed have been constructed throughout in accordance with the highest standards of steam railroad practice. The small number of curves and grades and the substantial character of the bridges and trestles make it possible to operate with safety at a high rate of speed. The heaviest grade on the line is one of  $2\frac{1}{2}$  per cent over a hill just outside the city limits of Portland; none of the other grades exceeds 1 per cent. Including city streets there are only 50 curves and 85 per cent of the track, including a  $19\frac{1}{2}$ -mile stretch south of Wilsonville, is on tangent. The sharpest curve is 8 degrees.

The track is standard gauge and is laid with 70-pound rails on fir ties. The bonds are of the Ohio Brass Company's "G-D" type. These were described in last week's issue of the *Electric Railway Review*, page 253. The track is now being ballasted with 2,300 cubic yards of gravel per mile. A large number of cuts and fills were required. The slope of the



Oregon Electric Railway—Standard Local Passenger Station.

embankment on fills is  $1\frac{1}{2}$  to 1 and in cuts 1 to 1. There are 38 pile trestles. At Wilsonville the road crosses the Willamette river on a steel bridge of four 200-foot spans, with a total length, including trestle approaches, of 3,800 feet.

#### Power.

Power for the operation of the line is purchased from the Portland Railway Light & Power Company and transmitted from its power plant at Oregon City to the railway over a 9-mile transmission line, carrying current at 33,000 volts pressure and a frequency of 33 cycles. The current is converted to the operating pressure of 600 volts in four substations, equipped with 500-kilowatt six-phase 600-volt rotary

converters and the necessary switchboards and transformers, all of General Electric manufacture. The substation buildings, one of which is illustrated herewith, are of concrete and are 36 by 42 feet in size.

The overhead construction is of the catenary type, the No. 0000 trolley wire being suspended from a  $\frac{3}{8}$ -inch galvanized steel messenger cable, supported by 9-foot 9-inch T-bar brackets from poles set 150 feet apart on tangent and 100 feet apart on curves. The poles also carry the transmission line and the telephone and telegraph wires. The overhead construction, which was supplied by the Ohio Brass Company, was completely described in last week's issue, page 253.

#### Rolling Stock.

The rolling stock equipment of the new road comprises eight passenger motor cars, two electric freight locomotives



Oregon Electric Railway—Standard Concrete Substation.

and 15 freight cars. An order has been placed for 25 flat cars and 25 box cars to supplement the other freight equipments. As shown by the accompanying illustrations, the passenger cars are large equipments of an especially pleasing design. These cars were built by the Jewett Car Company, Newark, O.

The length of the car from bumper to bumper is 57 feet 8 inches. The car body is 9 feet wide over posts and when mounted is 13 feet  $7\frac{1}{4}$  inches high from rail to trolley board. The interior of the car is divided into three compartments: a baggage compartment with four folding seats, a smoking compartment with four fixed and four reversible seats and a general compartment with three fixed and 16 reversible seats. The toilet compartment occupies a corner next to the rear door. As the cars are arranged for single-end operation the motorman will be entirely shut off from the passengers. His cab is provided with a 24-inch door on one side only. The baggage compartment has two sliding side doors each 3 feet 6 inches wide. The doors in the interior partitions and in the rear bulkhead swing on hinges.

Each car body is mounted on Baldwin heavy M. C. B. type trucks with steel wheels and Symington journal boxes. Each car is equipped with M. C. B. coupler heads and one locomotive pilot. The electrical equipment of each car includes four 75-horsepower General Electric motors with multiple-unit control. The brake equipment is the Westinghouse Traction Brake Company's A M R schedule with quick-acting triple valve, quick recharge, quick service and graduated release features. A No. 3 direct-current air compressor and a slack adjuster are included in the brake equipment. The cars are equipped

with De France air sanders. The locomotives are double-ended, of 50 tons weight and are equipped with two 160-horsepower General Electric motors and pantagraph current collectors.

A 60 by 135 foot car house is located at South Portland and a smaller one at Salem.

**Operation.**

Trains are to be operated in accordance with the standard code of rules of the American Railway Association. All signals, markers, etc., will also conform to those in general use on steam roads. The dispatchers' office is located at Portland and standard telegraphic train orders will be used. A tele-

mileage ticket is issued at 2½ cents per mile and family commutation tickets are sold at 2 cents per mile. In addition there are reduced week-end rates and special rates for school children will be established.

The construction of the road was in the hands of the Willamette Construction Company, a construction organization of the engineering firm of W. S. Barstow & Co. of New York and Portland. R. L. Donald was chief engineer in charge and F. S. Drake superintendent of construction.

The officers of the Oregon Electric Railway are: President, George Barclay Moffat, New York; vice-president and general manager, Guy W. Talbot, Portland; secretary, traffic manager and auditor, George F. Nevins, Portland; assistant

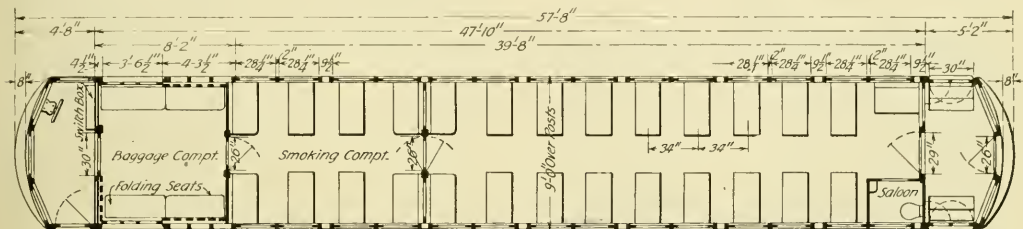

Oregon Electric Railway—Floor Plan of 3-Compartment Passenger Car, Showing Seating Arrangement and Principal Dimensions.

phone line has also been provided for use as an auxiliary. The policy of the company is to insist on good and regular service. The dispatching system has been very carefully arranged and all trainmen who enter the service are required to pass a thorough examination in the rules of the American Railway Association besides a rigid physical examination.

As soon as the ballasting is completed the company will establish a schedule of 10 trains per day in each direction between Portland and Salem. Three trains in each direction

secretary, Francis C. Schwab, New York; treasurer, Henry W. Brower, New York; assistant treasurer, C. H. Still, Portland; superintendent, C. A. Coolidge, Portland. The general offices of the company are located in the Corbett building on the corner of Fifth and Morrison streets, Portland.

The Illinois Traction System, which was recently ordered to build an elevated crossing over the tracks of the Illinois Central and Chicago & Alton railroads for the entrance to Lin-

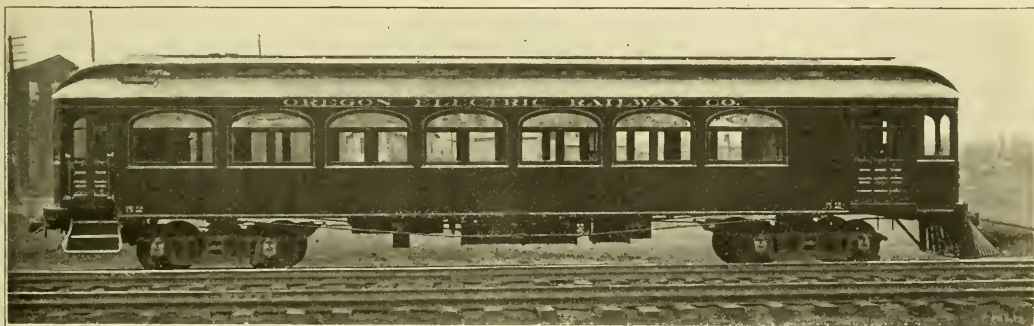

Oregon Electric Railway—Single-End Passenger Car with Three Compartments.

will be limited trains making no stops between terminals. It is expected to make the running time of the limiteds 1 hour and 30 minutes and of the locals 2 hours and 10 minutes. At present 1-car trains are used, but it is planned to eventually operate multiple-unit trains of two and three cars each.

**Rates.**

The local 1-way tickets will be sold on a basis of three cents per mile, or \$1.50 for the entire distance, which, on account of the shorter mileage, is less than the Southern Pacific rate of \$1.65. The round-trip rate between Portland and Salem is \$2.75 and in general the round-trip rates are 5 per cent less than the sum of the 1-way fares. A 1,000-mile

coln, Ill., of its Lincoln-Mackinaw line, has secured permission to build a temporary line at grade so that passengers may enter the city without transferring to the city cars. It is stated that as soon as the temporary track is laid the company's sleeping cars from East St. Louis will be run through to Peoria instead of stopping at Springfield as at present.

The Seattle Electric Company is making practical tests of various kinds of fenders for the purpose of deciding upon the type which will minimize accidents. Tests have been conducted at the company's shops at Georgetown, Wash., and those which have given promise of proving satisfactory have been attached to cars.

**THE NEW YORK SUBWAY CAR.**

BY BION J. ARNOLD, CONSULTING ENGINEER, CHICAGO.

[This report on "The Subway Car" is a part of a general report on the present subway system of the Interborough Rapid Transit Company of New York. The report, presented here in abstract, is made for the public service commission of the first district, state of New York, to serve which Mr. Arnold has been retained in a consulting capacity. A preliminary report, including suggestions for facilitating traffic, was presented in the Electric Railway Review for December 7, 1907, page 892.—Eds.]

**The Present Car.**

That part of the subway which presumably is of the greatest interest to the traveling public is the design and operation of the car. The car equipment at the present time consists of 500 composite cars in which some wood is used, 300 all-metal, strictly fireproof cars, and 50 additional all-metal cars which have been ordered recently and are now being delivered, making a total of 850 cars. All of the cars are practically the same size, with seats and doors similarly arranged. Each car is 51 feet 2 inches over all in length and 8 feet 7 inches in width, and is provided with 52 seats, 16 of which are cross seats near the center of the car, with the other 36 seats placed longitudinally near the ends. The cars are as long as the curvature of the tracks will admit, and as wide at the top as the clearance on critical curves will allow. All the cars have closed vestibule platforms, with sliding doors, instead of the usual gates. Figure 1 indicates the seating plan and the general dimensions of the car.

On account of the excessive use of the doors, the present

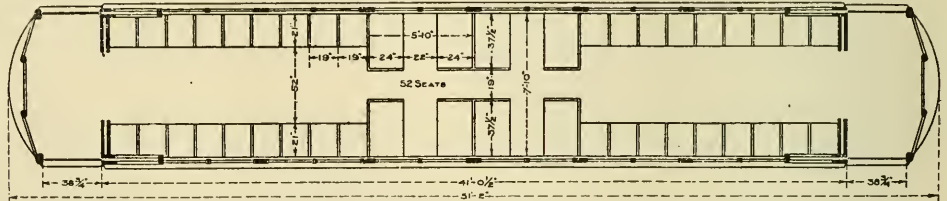

New York Subway Cars—Figure 1—Present Subway Car, Showing Seating Arrangement and Single Doors at Ends.

type of car, which ordinarily gives satisfactory service, has proved to be extremely inadequate for the subway.

Since the opening of the tunnels to Borough hall, Brooklyn, on January 10, 1908, a schedule or timetable has been prepared calling for 40 express trains per hour between Ninety-sixth street and Brooklyn bridge during the rush periods. The delays of the trains at the station platforms, however, have seriously interfered with the carrying out of the improved schedule. As soon as the demand for seats increases beyond a certain limit the supply of seats begins to decrease.

The present arrangement of loading and unloading passengers through the same end doors of the cars is the chief cause for the inefficient operation during the rush-hour period. The unloading usually requires from 15 to 30 seconds, and in extreme cases 50 seconds during the most congested period at the principal points of transfer.

An analysis of the average time required by an express train at a station platform during the height of the rush hours shows the following figures:

	Average, seconds.
To open doors of cars after train has stopped.....	2
To unload an average of 163 passengers through 14 doors (15 to 50 seconds).....	20
To load an average of 206 passengers through 14 doors (15 to 30 seconds).....	20
To close the car doors and give the signal, by means of bell rope to motorman.....	13
<hr/>	
Total average time of express trains at station plat- forms between stopping and starting during the height of the rush hours.....	55

**Defects.**

Two of the defects which stand out prominently in the operation of the subway are, first, the excessive use of the

transfer privilege and, second, the use of the same end doors in the cars for both the entering and the leaving passengers. Apparently the only permanent way to improve these conditions is either to reduce or abandon the transfer privilege, or to change the cars. While it may be contended that such convenient means of transferring at so many points should not have been provided, it is my opinion that this principle, having been established, cannot now be withdrawn, and that the only remedy, therefore, is to change the cars. To state the case briefly, the principal defect in the present car is due to the fact that a definite and ready circulation of traffic is not provided for and that owing to the lack of sufficient doors properly located the maximum carrying capacity of the car cannot be easily and quickly reached.

**Possible Improvements.**

If the present arrangement of signals is retained, the only possible way to secure an increase in the capacity of the subway from 30 trains per hour to 40 trains per hour is to scrap or use elsewhere the entire subway car body equipment and build new cars at an expense of at least \$5,000,000, and to rearrange the present platforms, which is practically prohibitive.

If, on the other hand, the signal system can be improved in such a way that even the present trains can be passed through the stations on a headway of 105 seconds (1 3/4 minutes) it will require only a comparatively simple alteration in the car to reduce the allowed stop of 50 seconds to 35 seconds and thus secure the 15 seconds' saving which will make the desired 90-second headway possible. The most economical and efficient, as well as the quickest way, therefore, to secure a capacity of 40 trains per hour in the subway is to improve the signal system (as recommended in my report of January 13, 1908) and at the same time alter the present cars sufficiently to limit the platform waits to a maximum of 35 seconds.

To secure this result it is evident that the loading and the

unloading must be carried on at the same time. Some improvement should also be expected from the use of pneumatic door handling equipment and an electric door signal. These changes should easily bring the actual wait at the station platform down to the following figures:

	Seconds.
To open doors after train is stopped.....	2
To unload 163 passengers through 14 doors, and to load 206 passengers through separate doors, both processes being carried on at the same time.....	20
To close doors and give signal to motorman.....	8

Total average time of trains at express stations during rush hours should not exceed..... 30

No change should be allowed which will reduce the total number of seats per hour now provided by the subway cars. The rule should be that the increased number of seats made available by the extra cars must be at least equal to the total number eliminated on account of the space occupied by the extra doors.

If 40 trains of eight cars each are passed through a station each rush hour, each car having additional doors to provide for the more comfortable and rapid handling of the passengers, it will require but 40 seats per car to provide the same number of seats that are at present supplied by thirty 8-car trains per hour. The new cars, therefore, should not have less than 40 seats. Any greater number of seats than 40 per car will indicate a corresponding increase in the total number of seats available.

A successful car for the present subway should possess as many as possible of the following requirements:

1. Separate entrances and exits.
2. A space which can be cleared so as to be ready to quickly receive the passengers boarding a car.
3. Convenient means of circulation inside the car.
4. Standing room space contiguous to the exits.
5. As many cross seats as practicable.

6. Exit and entrance doors sufficiently removed from each other to allow for the car stopping convenient to guiding rails on the platforms.

7. Doors located so as to minimize the danger from open spaces at curve platforms.

The various cars may be classified in accordance with the number of doors in the sides of the cars as follows:

- Cars with central side door and end doors.
- Cars with two quarter side doors.
- Cars with three doors near center.
- Cars with multi side doors.
- Cars with double doors near ends.

Each one of these types may have seats of either the longitudinal, the cross "back to back," or of the "walkover" style, or a combination of two or more styles.

**Cars with Central Side Door and End Doors.**

The present cars could be altered to provide central side doors. I have made a number of studies of details of con-

struction and general arrangement of seats applicable to a car of this type. Cars of this type have been in use on the Brooklyn bridge shuttle trains for many years. They have recently been introduced for subway and elevated service in Boston and Philadelphia, and have been adopted by the Hudson Companies for use in the new tunnels between Manhattan and Jersey City. The successful use of the central side door car in ter-

fourth the length of the car from the end, is sometimes advocated. This type of car would have as many doors as the present end door car, but the doors dividing the car into quarters would give the quarter door car the advantage of providing the shortest average distance from the door to the seat. This car would therefore cause the passengers to occupy the center of the car and thus use the entire length of the car more effectively than it is now used in the present end door type.

The location of the train guards would be a problem with this type of car, as these guards could not work to advantage from between the cars as at present. If future subways could be constructed sufficiently in advance of the demand for them, then the type of car shown in Figure 2 could be used to good advantage, and cross seats could be substituted for the longitudinal seats. Under present conditions, however, there would be a temptation to move in the other direction and fold up the longitudinal seats during rush hours, thus providing increased standing capacity.

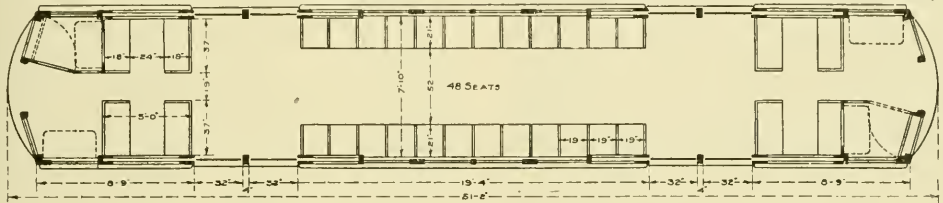

New York Subway Cars—Figure 2—Car with Quarter Side Doors, Cross and Longitudinal Seats.

struction and general arrangement of seats applicable to a car of this type. Cars of this type have been in use on the Brooklyn bridge shuttle trains for many years. They have recently been introduced for subway and elevated service in Boston and Philadelphia, and have been adopted by the Hudson Companies for use in the new tunnels between Manhattan and Jersey City. The successful use of the central side door car in ter-

Cars with three doors near center would lend themselves conveniently to an effective system of platform guard rails, but the center door would be a disadvantage at curved platforms.

**Cars with Multi Side Doors.**

Cars of this type are in successful use in the suburban

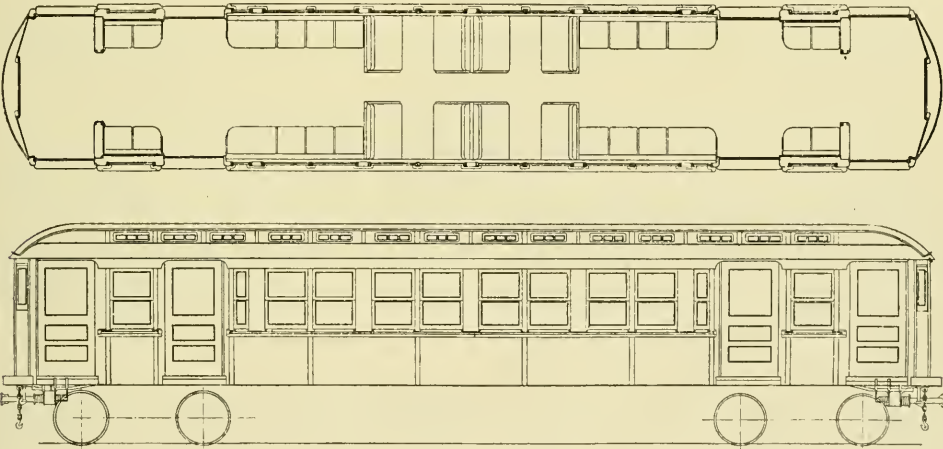

New York Subway Cars—Figure 3—Recommended Type—Present Car After Being Altered into a Car with Double Doors Near Ends.

mination work, however, does not furnish a precedent which demonstrates that this type of car would be satisfactory under subway conditions, whereas the failure of the center door car on the Boston subway to reduce the length of stop to much less than the time required in the New York subway, even with the present end door cars, does not furnish any encouragement toward rebuilding the present subway cars so as to provide them with central doors. To get the full benefit of the introduction of central doors in the sides of the cars, it would be necessary to extend each platform at least 50 feet.

**Car with Two Quarter Side Doors.**

Upon roads where the traffic is not as heavy as in the subway, a type of car with two doors, each located about one-

service of the Illinois Central Railroad in Chicago. These cars are 72 feet long over all, and 10 feet 6 inches wide over the sheathing. There are 12 sliding doors on each side, opening on a level with the platform, and two doors on each side, opening to steps which are used at stations where there are no high platforms. An electric signal apparatus is connected with the doors so that a signal is automatically transmitted to the engineer when the last door in the train is closed by the conductor.

It is fair to assume that with an S-door car in the subway passengers would be unloaded and loaded at the rate of not more than four persons per second per car. Without an attendant for each door it is difficult to see how the use of the multi side door car in the subway would reduce the present

time of loading and unloading by more than one-half; that is, the present rate of passenger movement of two persons per car per second maintained with the present end door car might possibly be increased to four passengers per car per second with the multi side door car.

The final serious objection to the multi side door car in the present subway is the fact that practically the entire car bodies now in use would necessarily either be scrapped or used elsewhere, as it would be practically impossible to re-build them so as to provide eight side doors on each side of each car.

#### Cars with Double Doors Near Ends Recommended.

Without weakening the present car, or adding materially to its weight, it is possible to introduce additional side doors, one near each end of each side of the car and as near as practicable to the present end doors, the distance between the doors being at least sufficient to furnish a pocket for the sliding doors.

It will be seen by referring to Figure 3 that these additional doors can be added without disturbing the present seating arrangement of the car to any great extent. It is true that the introduction of these doors will make it necessary to remove eight seats from each car, but the operation of the cars in actual service will make it possible to pass so many more cars through the subway that the loss of eight seats in each car will be more than offset by the additional seats in the added cars, and the extra standing room, so convenient to the separate exit, is a feature which will decrease the station waits, and thereby increase the schedule speed.

This car provides a separate space for leaving passengers to collect around the exit doors without blocking the space

doors, located near the ends approximately, as shown in Figure 3.

I recommend this car for the following reasons:

(a) The double door space at each end of the car will greatly reduce the present station waits.

(b) The separate exits and entrances will remove the present uncomfortable conflict at the car doors.

(c) The present cars can be altered into this type of car without detracting from their structural strength, or materially altering the present seating arrangement.

(d) The result in increased carrying capacity due to the changes will abundantly justify the investment.

(e) This is the only type of car with additional doors that will not materially increase the present trouble due to curved platforms.

(2) That all cars be provided with either pneumatic or other means for quickly opening and closing the doors and with signals, which will automatically indicate to the motorman when the last door is closed.

(3) That all new cars be of metal and provided with seats more economically arranged.

(4) That when the cars of the double end door type are put into service, a system of platform railings, similar to that shown in Figure 4, be provided to direct the passengers.

(5) That for future subways a wider car should be considered. This car may be a multi side door car, if separate platforms can be arranged for each class of trains, and if the stations can be designed to control the flow of passengers at the entrance to the platform, instead of directly at the car doors. If, however, it is found that it is impracticable to design stations with sufficient room for waiting passengers independent of the station platforms, it will probably be found that

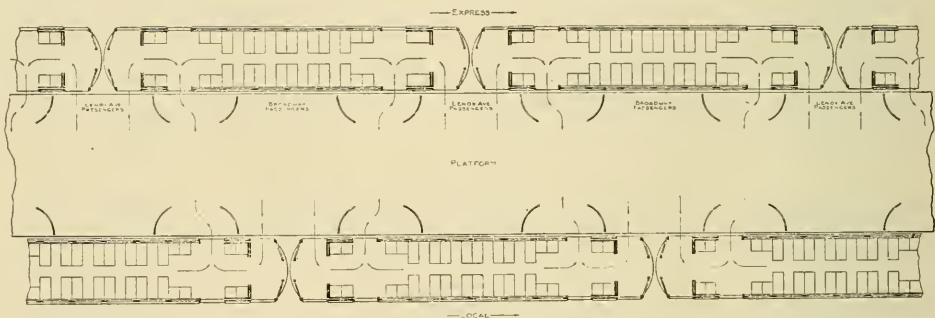

New York Subway Cars—Figure 4—Arrangement of Guiding Rails on Station Platforms, to be Used in Connection with Recommended Type.

which should be provided for the passengers entering the car. The result will be that passengers will move in and out much more quickly than at present, and the movement of passengers into the car will facilitate the movement of passengers out of the car.

There is no reason why a rate of flow of passengers in and out of the car amounting to at least five passengers per car per second should not be expected with this car with double doors near the end, and this rate is fully as good as the experience in Chicago would lead us to expect from the multi side door cars, even with eight doors distributed the entire length of the car.

Both the exit and the entrance doors are directly under the eye of the guard. This car lends itself readily to the introduction of platform railings at all of the more important station platforms. These railings can be arranged as shown in Figure 4, which will indicate at once the advantages of collecting the passengers who are waiting for a train at definite loading points, thus leaving the remaining parts of the platform free and ready to receive the unloading passengers.

The present cars can be changed to conform to this arrangement for an expense of about \$2,000 for each steel car, and about \$1,500 for each composite car.

For the present subway this car seems to me to possess more advantages and fewer disadvantages, both from the standpoint of the public and the operating company, than any other type, and its use will increase the capacity of the subway sufficiently to fully justify the expense of altering the present cars into cars of this type.

My recommendations, summarized, are as follows:

(1) That every car used in regular passenger service in the present subway be provided with two additional side

doors near the ends.

(6) That if it is found that future subways cannot be built without the occasional use of curved platforms, the cars for these future subways should be designed so as to allow the station platforms to extend under the car in such a way that the necessity for sliding platforms will be obviated.

#### New Pay-As-You-Enter Cars in Service in Chicago.

The Chicago City Railway Company on Wednesday of this week placed 100 new pay-as-you-enter cars in service on the Indiana avenue line. The new service was successful from the start, as most of the passengers have become familiar with the pay-as-you-enter system since 125 cars of that type were put in operation on the parallel Cottage Grove avenue line in November. The company's officials state that the pay-as-you-enter car is no longer regarded as an experiment, but as a complete success. The new cars replace 85 double-truck cars of the older type, which were transferred to the State street line. The old State street cars have been sent to the shops to be remodeled, with longer platforms, so they may be easily converted into pay-as-you-enter cars if it is decided to do so at a later time. The new cars are like those previously furnished the company by The J. G. Brill Company, which were described in the Electric Railway Review of September 21, 1907, page 332.

Besides carrying the mail on the Peoria-Bloomington line the Illinois Traction Company is carrying pouches from East St. Louis to Springfield, Springfield to Decatur, Decatur to Danville and from Peoria to Springfield.



NEW CARS CHICAGO RAILWAYS COMPANY.

The board of supervising engineers Chicago traction has just completed its specifications for the 300 cars to be purchased for use on the Chicago Railways Company's north and

8 feet 10½ inches high from bottom of side sills to top of trolley board. The maximum height of the body bolster above the top of the rail is indicated as 30 inches.

The windows will be arranged to raise into the roof, affording a 29-inch window opening. The height of trolley board above the rail is 11 feet 8 inches. The accompanying drawings show an elevation, a floor plan with seating arrangement and a vertical cross section with general dimensions.

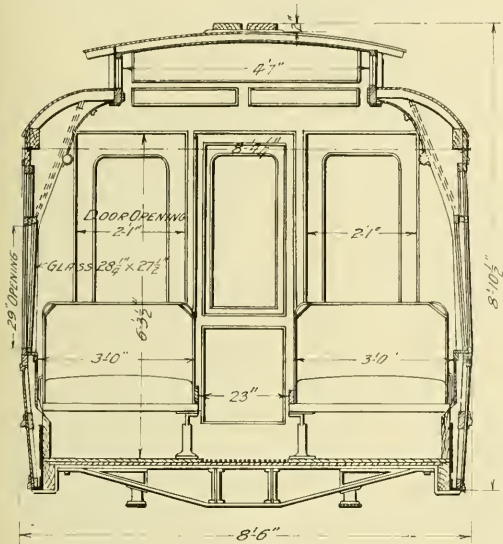

Chicago Railways Cars—Vertical Cross Section.

Surface Finish on Concrete Construction.

In a recent paper M. C. Tuttle, secretary of the Aberthaw Construction Company of Boston, gave the results of some of the experience of this company in concrete construction, particularly as relates to the finish of concrete surfaces. Briefly told, the different finishes and their characteristics are as follows:

Granolithic finish secured by careful troweling furnishes a good protection, is water-tight, but is not always satisfactory in appearance.

Rough picked work gives a pleasing surface with some variation in color, and if properly done is not injurious in its general effect upon the construction. It is particularly adapted to landscape and ornamental work.

A rubbed mortar surface can be obtained by the use of water and carborundum stone. This is an excellent finish for factory buildings and the like. It costs no more than picking.

An air blast finish can be given by inexperienced men with fair economy. This method was used by the Aberthaw Construction Company in finishing the stadium at Harvard University.

A hammered surface obtained by the use of the ordinary many bladed stone hammer gives a good finish for detail work and for concrete block.

Sulphuric acid is sometimes rubbed into the surface with a steel brush and the cement particles thereby dissolved away from the rest of the material, bringing out the color very effectively.

west side lines. It will be noted from the accompanying illustrations that these cars are to be of the pay-as-you-enter type. The car from bulkhead to bulkhead is 32 feet 5 inches long

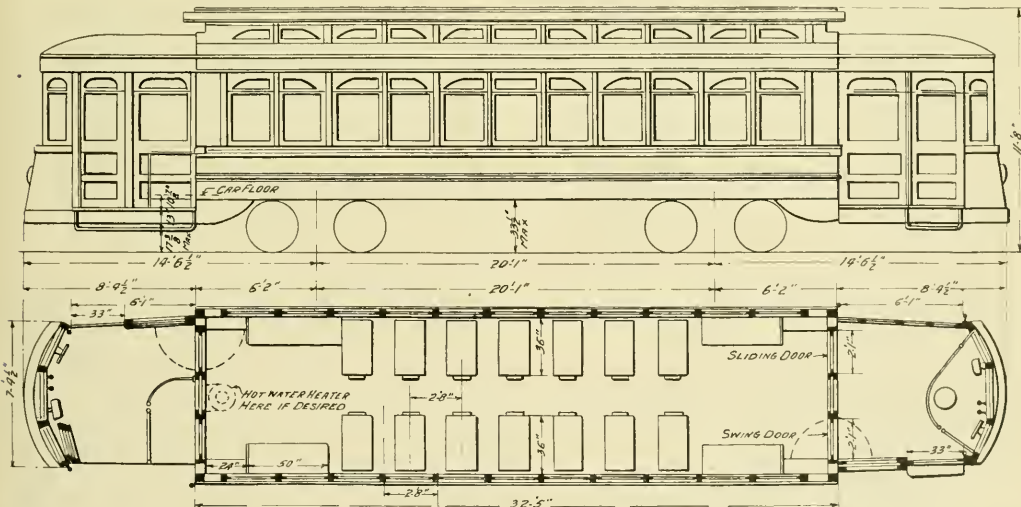

Chicago Railways Cars—Floor Plan and Elevation.

with two platforms, each 8 feet 4½ inches long, arranged for double-end operation with details quite similar to those in service on the new pay-as-you-enter cars of the Chicago City Railway. The car body is 8 feet 6 inches wide over all and

Mr. Tuttle considers that in the future there will be less attempt to shape the concrete in molds corresponding to the finished size. It will be cheaper to make them smaller and plaster the surface, or use some other means of finishing.

ACCOUNTING CIRCULAR OF THE INTERSTATE COMMERCE COMMISSION.

Circular No. 20 of the Accounting Series, which pertains to electric railways, has just been issued by the interstate commerce commission, though dated January 10. It contains a discussion by Prof. H. C. Adams, in charge of the division of statistics and accounts of the commission, an abstract of which follows:

Acting under the authority conferred by the twentieth section of the act to regulate commerce, as amended June 29, 1906, the interstate commerce commission has undertaken to prescribe a standard system of accounts for steam railways, electric railways, express companies, sleeping car companies, carriers by water (as described in the act) and pipe lines. In view of the nature of this task, and of the public interest involved, the commission regards it as essential that the same fundamental accounting principles should be applied to all the above agencies of transportation, and that the classifications of revenues and expenses should be the same, so far, at least, as the general accounts are concerned.

It should be distinctly understood that the interstate commission represents the interests of the states, as well as its own interests, in this effort to develop a uniform system of accounts for electric lines. There are at the present time 30 states the laws of which give to state railway commissions or other legally constituted bodies, jurisdiction over electric railways, and this circular is issued after correspondence with, and approval of, the representatives of the state governments. This being recognized, it is evident that this is the only practical means of attaining the results regarded as essential by both federal and state governments.

This circular, addressed to accounting officers of electric railways, conforms to the method of procedure followed in the case of all other carriers for which it is proposed to prescribe a standard system of accounts. It is recognized that the co-operation of practical accountants is essential for arriving at the best results, and, as a means of obtaining this co-operation, circulars have been issued asking specific questions, or, as in the case of this circular, tentative classifications have been submitted, accompanied by a request for criticisms and suggestions. In no other way is it possible to bring the knowledge and experience of practical accountants to bear upon the problem in hand.

The tentative classification of operating expenses is drawn on a plan which indicates four different classes of accounts, viz.: First, general accounts, indicated by a prefix of Roman numerals; second, subgeneral accounts indicated by a prefix of capital letters; third, primary accounts, indicated by a prefix of Arabic numerals; fourth, subprimary accounts, which are optional with carriers, and are to be indicated by small letters.

The general accounts are for use in grouping the items into a condensed form of report, it being understood that in all statements, Group I and Group II under General Account IV "Transportation expenses" shall be shown as separate items. The subgeneral accounts are provided for the use of small electric lines whose operations are not of such magnitude as to warrant greater detail in accounting; such companies are to be designated as those having a gross annual revenue of less than \$50,000. The primary accounts are provided for use of the larger lines, including all those having a gross annual revenue of \$50,000 or over. Provision is made for subprimary accounts in case a further subdivision of the primary accounts is desired by the individual carriers or by state commissions; but the interstate commission refrains at this time from prescribing any further subdivision of the accounts than is indicated by the primary accounts.

Abbreviated Classification.

The following analysis shows the accounts to be kept by the smaller lines. The reports required of them will call for an accurate statement of expenses assignable to the subgeneral accounts as indicated by capital letters:

- I. Maintenance of way and structures:
  - A. Maintenance of way.
  - B. Maintenance of electric line.
  - C. Maintenance of buildings and structures.
  - D. Maintenance of service equipment.
  - E. Availability maintenance expenses.
  - F. Adjustment accounts—maintenance of way.
- II. Maintenance of equipment:
  - G. Maintenance of revenue equipment.
  - H. Maintenance of electric equipment of revenue equipment.
  - I. Depreciation estimate—revenue equipment.
  - J. Maintenance of power apparatus.

- K. Miscellaneous maintenance of equipment expenses.
- L. Adjustment accounts—maintenance of equipment.
- III. Traffic expenses:
  - M. Traffic expenses.
- IV. Transportation expenses:
  - Group I.—Power.
    - N. Power manufactured.
    - O. Power purchased.
    - P. Adjustment accounts—power.
  - Group II.—Operation of cars.
    - Q. Wages of car operators.
    - R. Other car operating expenses.
    - S. Injuries and damages.
    - T. Adjustment accounts—transportation.
- V. General expenses:
  - U. General expenses.
  - V. Adjustment accounts—general expenses.

The operating expense accounts proposed for the larger lines are stated in the tentative classification [published elsewhere in this issue.—Eds.], and by comparing the above list of subgeneral accounts with the primary accounts of the classification, the relation of the rules of accounting for the large and the small lines becomes evident. The general accounts are the same for both, but there are 116 primary accounts provided for large lines as against 22 subgeneral accounts for small lines.

Moreover, the small lines are to follow the text descriptive of the primary accounts provided for the large lines, which can easily be done, for the reason that each subgeneral account is in fact a grouping of primary accounts.

The depreciation accounts provided in this classification have been stated as follows: First, depreciation accounts for application to equipment; second, depreciation accounts for application to maintenance of way and structures. Depreciation accounts for maintenance of way and structures have not as yet been prescribed for steam carriers, and their appearance in this classification does not mean that it has been finally decided to require them of electric carriers. Provision has been made for them in the tentative classification herewith submitted, in order that those carriers that desire to charge depreciation on other property than equipment may exercise that liberty in proper form; also that any state commission desiring to prescribe depreciation charges for all classes of property may do so in proper form and in strict harmony with the general system of accounts prescribed for all agencies of transportation.

Joint Facilities.

Particular attention is called to the joint facilities accounts (see accounts Nos. 45, 46, 66, 67, 104, 105, 115 and 116), which are provided in order:

1. To state the operating expenses of each carrier under its own primary accounts without reference to any service rendered by it to another carrier or to any service rendered by another carrier to it; or, in other words, to permit that the participation of any carrier in the operations of another carrier may, by means of the joint facility accounts, be so shown that a combined statement of the operating expenses of all carriers would represent neither more nor less than their true expenses of operation.

2. To exclude from revenues the amounts paid by one company to another for service furnished which do not properly represent revenue derived from the public.

3. To exclude from operating expenses such amounts paid as represent the use of capital.

A payment for use of tracks and power (including rent, cost of power and other operating expense) is subject to analysis which should result in determining what portion is assignable to each of the following classes: (1) Use of capital (or rent); (2) maintenance expenses; (3) transportation expenses; (4) administrative expenses (if any). The determining of these elements will enable both a lessor and a lessee company to handle the subject properly, the lessor company crediting and the lessee company debiting its accounts as follows: (1) Rent, income account; (2) maintenance expenses, Accounts 45 and 46; (3) transportation expenses, Accounts 104 and 105; (4) administrative expenses, Accounts 115 and 116.

By excluding from operating expenses the cost representing the use of outside capital the result is that the amount stated as operating expenses represents the operating cost incident to the employment of the capital to which it corresponds, and by specifically separating all capital charges from operating expenses the relative and proper correspondence is preserved.

This method of accounting is particularly applicable to the needs of the commissions in determining the results of specific capital employed, and also in assembling statistics

## TENTATIVE CLASSIFICATION OF OPERATING EXPENSES OF ELECTRIC RAILWAYS.

## I. Maintenance of Way and Structures.

- A. Maintenance of Way.
1. Ballast.
  2. Ties.
  3. Rails.
  4. Rail fastenings.
  5. Frogs, switches and special work.
  6. Underground construction.
  7. Paving.
  8. Roadway and track.
  9. Tunnels.
  10. Bridges, trestles and culverts.
  11. Over and under grade crossings.
  12. Grade crossings, fences, catwalks and signs.
  13. Signals and interlocking plants.
  14. Telegraph and telephone lines.
  15. Other maintenance of way expenses.
- Depreciation estimate "Roadway."
- B. Maintenance of Electric Line.
- Transmission Lines—
17. High-tension transmission lines.
- Distribution System—
18. Overhead feeders.
  19. Underground feeders.
  20. Track bonding.
- Conductors—
21. Overhead trolley lines.
  22. Third-rail conductors.
  23. Underground conductor rails.
  24. Miscellaneous electric line expenses.
- Depreciation estimate "Electric Line."
- C. Maintenance of Buildings and Structures.
25. Power generating plant buildings.
  27. Power substation buildings.
  28. General offices.
  29. Car houses and shops.
  30. Stations, waiting rooms and other buildings.
  31. Docks and wharves.
  32. Miscellaneous buildings and structures expenses.
- Depreciation estimate "Buildings and Structures."
- D. Maintenance of Service Equipment.
34. Snow equipment.
  35. Work cars.
  36. Electric locomotives (utility).
  37. Miscellaneous service equipment.
  38. Depreciation estimate "Service Equipment."
- E. Availability Maintenance Expenses.
39. Care of track.
  40. Removal of snow, sand and ice.
  41. Cleaning, sprinkling and oiling roadbed.
  42. Injuries to persons.
  43. Other miscellaneous maintenance expenses.
- F. Adjustment Accounts—Maintenance of Way.
44. Other than railway operation—Cr.
  45. Maintaining joint tracks, yards and other facilities—Dr.
  46. Maintaining joint tracks, yards and other facilities—Cr.

## II. Maintenance of Equipment.

- G. Maintenance of Revenue Equipment.
47. Passenger cars—repairs.
  48. Combination cars—repairs.
  49. Express cars—repairs.
  50. Mail cars—repairs.
  51. Freight cars—repairs.
  52. Locomotives—repairs.
- H. Maintenance of Electric Equipment of Revenue Equipment.
53. Electric equipment of passenger cars—repairs.
  54. Electric equipment of combination cars—repairs.
  55. Electric equipment of express cars—repairs.
  56. Electric equipment of mail cars—repairs.
  57. Electric equipment of freight cars—repairs.
  58. Electric equipment of locomotives—repairs.
- I. Depreciation Estimate—Revenue Equipment.
59. Depreciation estimate "Revenue Equipment."
- J. Maintenance of Power Apparatus.
60. Power generating plant equipment.
  61. Power substation equipment.
- K. Miscellaneous Maintenance of Equipment Expenses.
62. Shop machinery and tools.
  63. Other equipment expenditures.
- Depreciation estimate "Maintenance of Shop and Power Apparatus."

## L. Adjustment Accounts—Maintenance of Equipment.

65. Other than railway operations—Cr.
66. Maintaining joint equipment—Dr.
67. Maintaining joint equipment—Cr.
68. Equipment borrowed—Dr.
69. Equipment loaned—Cr.

## III. Traffic Expenses.

- M. Traffic Expenses.
70. Soliciting and administering.
  71. Advertising and attractions.
  72. Traffic supplies and expenses.

## IV. Transportation Expenses.

## Group I.—Power.

- N. Power Manufactured.
73. Fuel for power generating plant employees.
  74. Fuel for power generating plants.
  75. Water for power generating plants.
  76. Lubricants for power generating plants.
  77. Other supplies and expenses of power generating plants.
  78. Operating substations.
- O. Power Purchased.
79. Purchased power.

## P. Adjustment Accounts—Power.

80. Power transferred—Cr.
81. Other than railway operations—Cr.

## Group II.—Operation of Cars.

- Q. Wages of Car Operators.
82. Passenger motormen.
  83. Passenger conductors.
  84. Passenger trainmen.
  85. Freight, express and other motormen.
  86. Freight, express and other conductors.
  87. Freight, express and other trainmen.
- R. Other Car Operating Expenses.
88. Superintendence.
  89. Interlockers, block and other signals—operation.
  90. Telegraph and telephone—operation.
  91. Stationery and printing.
  92. Clearing wrecks.
  93. Station employes.
  94. Station supplies and expenses.
  95. Car supplies and expenses.
  96. Car house employes.
  97. Car house expenses.
  98. Express service.
  99. Other transportation expenses.
  100. Insurance.
- S. Injuries and Damages.
101. Loss and damage.
  102. Damage to property.
  103. Injuries to persons.
- T. Adjustment Accounts—Transportation.
104. Operating joint tracks, yards and other facilities—Dr.
  105. Operating joint tracks, yards and other facilities—Cr.

## V. General Expenses.

- U. General Expenses.
106. Salaries and expenses of general officers.
  107. Salaries and expenses of clerks and attendants.
  108. General office supplies and expenses.
  109. Law expenses.
  110. Insurance.
  111. Relief department expenses.
  112. Pensions.
  113. Stationery and printing.
  114. Other expenses.
- V. Adjustment Accounts—General Expenses.
115. General administration joint tracks, yards and other facilities—Dr.
  116. General administration joint tracks, yards and other facilities—Cr.
- Clearing Accounts.
- Shop expenses.
  - Store expenses.
  - Stable expenses.
  - Work equipment—operation.
  - Insurance.
  - Injuries to persons.

into totals which will represent the service to the public and remedy a definite and long-felt deficiency in the subject which these particular accounts meet.

This circular is submitted to the electric carriers for consideration and criticism, and in order that the replies received may be as definite and concise as possible, the following specific information is requested: Name of company; number of miles of line operated; number of cars operated under normal conditions; what limit, in your opinion, should be used as a line of demarcation indicating the distinction between a large and a small company? What would be the approximate aggregate charge to operating expenses for the year ending June 30, 1908, resulting from the application of the theory of depreciation to the equipment of your company as outlined in this classification? Explain in detail the method by which you arrive at the amount stated. What is the present surplus (or deficit) from operation of your company, and in what particular years did it accumulate? Please give a list of joint facilities involved in the operations of your company. Do you consider the principles involved in the joint facility accounts as applicable to electric railway carriers?

Professor Adams also invites general criticisms and says

that it is not intended that the answers made to the inquiry should be confined to the specific questions enumerated. Replies to the circular are desired in duplicate, one copy to be forwarded to Elmer M. White, secretary American Street and Interurban Railway Accountants' Association, Birmingham, Ala., and the other copy to Professor Adams. It is desired that replies be made not later than March 28, 1908.

## Text of Depreciation Accounts.

The text of the tentative classification of operating expenses states under "Depreciation Estimate, 'Roadway,'" that "depreciation charges on maintenance of way property are not required at this time by the interstate commission. It is arranged, however, in this classification to introduce this account to provide rules for computing depreciation charges on maintenance of way property for the guidance of those carriers that desire to make such depreciation charges, and for the use of such commissions of the various states as may

prescribe them." Optional accounts are therefore inserted for the various classes of property included under maintenance of way. The same statement and optional accounts are presented touching electric lines, and buildings and structures.

Formal depreciation accounts for the different classes of equipment as presented as part of the tentative classification. Under primary account No. 59 the subaccount (a) Depreciation Estimate—"Passenger Cars" is divided as follows:

(a-1) Passenger cars—estimate:

This account includes a monthly charge of one-twelfth of . . . per cent per annum of the original cost (estimated, if not known) of passenger cars, to provide a fund for replacement when retired.

Note.—Where, in the opinion of the carrier company, depreciation can be more accurately estimated by basing the estimate upon the service rendered by the property, such method of estimate may be permitted, in case the carrier company first files with the . . . commission a statement of the rule or principle upon which it will base its estimates of depreciation, subject to disapproval by the commission.

(a-2) Passenger cars—renewals:

This account includes the original cost (estimated, if not known) of all passenger cars condemned, destroyed or sold, less:

Amount previously charged for depreciation up to date of retirement; plus

Scrap value of salvage or the amount received from sale of passenger cars retired.

Note A.—Passenger cars permanently retired from service but held, pending disposition, should be written out of service through this account, and carried in an appropriate material account at a nominal valuation or at actual scrap value, if determinable.

The circular also contains the discussion relating to depreciation which is published in the classification of operating expenses prescribed for steam railways.

The tentative classification for construction expenditures is changed only slightly from that published in the Electric Railway Review of December 21, 1907, page 958.

**THROUGH ROUTES RECOMMENDED FOR CHICAGO ELEVATED LOOP.**

Ford, Bacon & Davis of New York have completed the investigation started last June at the request of M. B. Starring, president of the Northwestern Elevated Railroad of Chicago, concerning the subject of improvement of the terminal facilities and especially the enlargement of the capacity of the Union Elevated loop. This firm has submitted a summary of its conclusions, which has been transmitted to the authorities of the city of Chicago by Mr. Starring. An abstract follows:

**Through Routing.**

Based on a detailed examination we believe that a plan of through routing can be adopted, even under diversified ownership, which will be more convenient for the traveling public than the present operation around the loop and will increase largely the number of cars that can be operated through this terminal district during the rush hours.

This plan contemplates through routing only between the Northwestern Elevated Railroad and the South Side Elevated Railroad, inasmuch as we believe it would be impracticable in addition to through route from the north and south sides to the west side, and through travel in the latter direction can be accommodated by means of transfers. The operation of the west side lines can be made more satisfactory to the public by the operation of loop trains of the Humboldt park and Logan square branches of the Metropolitan West Side Elevated Railway to the loop over Lake street by means of a connection between the Metropolitan and Lake street structures near Paulina and Lake street. This would shorten the time of travel between these branches and points on the loop and would also enable the Metropolitan company to operate into the loop more trains than at present.

The plan for through routing between the north and south sides contemplates the operation of such through-routed trains in both directions on both sides of the loop, supplemented, for the benefit of the west side, by an exchange of transfers without the payment of additional fare, between cars coming from the west side and these through-routed trains.

This plan of routing in conjunction with the lengthening

of platforms, rearrangement of station stops and the operation of 6-car trains upon all roads, will enable the operation at the peak of the rush hour of trains at the rate of 1,164 cars per hour, as compared with the recent rush-hour operation at the rate of 588 cars per hour upon which our calculations were based, which practically doubles the present operation on the loop. We see no reason why 7 and 8 car trains should not be operated ultimately.

**Auxiliary Terminals.**

In addition to the increase of terminal capacity above outlined, the Northwestern Elevated Railroad should build an auxiliary stub terminal as contemplated, at North Water street, which would provide stub terminal facilities, which are now used by the other three elevated companies. This stub terminal can later, if deemed desirable, be supplemented by an additional stub terminal crossing the river at Dearborn street, which latter would be a reserve against accident to the present Wells street bridge.

The use of these stub terminals will provide sufficient terminal capacity for the passenger traffic of your company until such time as a subway can be constructed from the north to south side in which the city shall provide space for your trains. We believe that by the time such subway is constructed the elevated traffic will have increased sufficiently to warrant the use both of the present loop, the stub terminals and the subway. We have taken into consideration in our recommendations in this particular the history of electric railway transportation systems, not only in Chicago, but also in New York and other large cities, where it has been found impossible to construct such terminal facilities fast enough to keep up with the increase in passenger traffic.

**PRIZES FOR RETAINING FARE RECEIPTS.**

With a view to interesting passengers and encouraging them to retain their fare receipts, the Conestoga Traction Company, Lancaster, Pa., has introduced the practice of giv-

Jan.	Feb.	Mar.	Apr.	May	June	July	Aug.	Sept.	Oct.	Nov.	Dec.	17	18	19	20	21	22	23	24	25	26	27	28	29	30	31	16
<b>Receipt for Fare Paid to Conductor</b>																											
To be given to passenger																											
<b>Conestoga Traction Company</b>																											
Not redeemable																											
Not good for passage																											
<i>Edgar Lipt</i> Manager																											
5652																											
<b>New Holland 15 10 15 20 25 30 35 Terre Hill</b>																											

<b>New Holland 15 10 15 20 25 30 35 Terre Hill</b>																											
<b>Conductors Will Return This Coupon</b>																											
With Report																											
<b>Conestoga Traction Company</b>																											
Not redeemable																											
Not good for passage																											
<i>Edgar Lipt</i> Manager																											
5652																											
Jan.	Feb.	Mar.	Apr.	May	June	July	Aug.	Sept.	Oct.	Nov.	Dec.	17	18	19	20	21	22	23	24	25	26	27	28	29	30	31	16

**Conestoga Traction Company—New Fare Receipt.**

ing away each month \$25 worth of transportation to persons holding receipt numbers announced by the company at the end of each month. One of these fare receipts is reproduced herewith. On the reverse side of that half of the receipt given to the passengers is the following announcement:

**"Keep This Receipt."**

"It may entitle you to FIVE DOLLARS' worth of transportation. On the first day of each month this company will give away to holders of CASH FARE RECEIPTS five coupon books, each containing one hundred 5-cent coupons, good for passage on all our suburban lines. Watch for the lucky numbers."

## SOUTH SIDE ELEVATED RAILROAD EXTENSIONS AND IMPROVEMENTS.\*

BY GARRETT T. SEELEY, ENGINEER OF MAINTENANCE.

The opening of the stock yards branch in the early spring will mark the completion of the programme of extensions and improvements that has been in progress on the South Side Elevated Railroad in Chicago for the last five years. Previous to this the system consisted of a double-track road extending from Sixty-third street and Jackson Park avenue, where in 1893 was located a terminal station in the World's Fair grounds, to a connection with the union loop at Van Buren street. This is a distance of 8.56 miles and the total single-track mileage, including the yard at Sixty-first street, was 21.14 miles.

The new construction work in brief was as follows: Extensions to Englewood, Kenwood and the stock yards; the construction of a third track for express service; the construction of yards for the storage of cars; the addition of 150 new cars; and increased facilities for the production and distribution of power.

When fully completed the system will consist of 46.13 miles of single track—including yards and sidings, more than double the former mileage. (A description of the new construction work and of the details of the steel structure appeared in the Electric Railway Review of August 31, 1907, page 251.)

The track construction follows, in general, the standard as adopted on all the elevated lines in the city, except that

utilize the middle track from 7 a. m. to 9:30 a. m., and southbound express trains from 4:50 p. m. to 6:30 p. m. The trains attain a maximum speed of 35 miles per hour and make the run between Congress street and Forty-third street in about 10 minutes—a distance of 4.39 miles, which is at the average speed of 26.3 miles per hour.

The construction of this part of the new work was very slow and expensive. It involved shifting all the curves, rebuilding every station, moving the platforms and, at several places, shifting the entire structure to suit local conditions.

### Signaling System.

To give protection to the large number of express trains running at a high rate of speed on the middle track, a system of electro-pneumatic block signals has been installed by the Union Switch & Signal Company. The blocks have a maximum length of 1,400 feet, with shorter blocks where the speed is reduced at curves and near terminals. These signals consist of dwarf signal stands of the same design as those at the interlocking plants. The signal arm is held in a clear position when the block is not occupied by the action of compressed air, and when the air is released the arm moves to the horizontal or danger position by the action of a heavy coil spring.

The signals are governed by track circuits. One track rail is insulated both from the structure and from the opposite track rail, and is divided into sections by insulated rail joints. The other track rail is a common ground for the return propulsion current and for the signal circuit. The insulated rail is then connected to a 6-cell storage battery through the proper resistances, and through a relay to the signals govern-



South Side Elevated Railroad—Sixty-third Street Storage Yards.

screw spikes have been used to secure the track rail. It was found that the common square track spike so crushed and destroyed the wood fiber in being driven that decay quickly set in, and that ties that were perfectly sound in the middle were so rotten under the rail as to require removal. In applying the screw spike a hole is first bored in the tie the size of the body of the spike, and when it is screwed down the threads press into the fiber of the wood, completely filling the hole and resisting a pulling effort equal to the strength of the spike itself. The track rail is 80-pound A. S. C. E. standard, with "Continuous" rail joints and laid on flat tieplates,  $\frac{3}{8}$  inch thick, with a shoulder on the side of the outer edge of the base of the rail.

All junctions and terminals have been equipped with interlocking plants to control the switches and signals. At Sixty-ninth street is located a mechanical interlocking plant, all the rest being electro-pneumatic installations built by the Union Switch & Signal Company. With the completion of the stock yards branch there will be in all a total of 11 electro-pneumatic interlocking plants in service, and 5 mechanical plants, a total for both classes of 16, 14 of which are in daily service.

### Express Track.

The third track for express service extends from Forty-third street to Twelfth street. Northbound express trains now

ing the section. The differences in potential between the two rails is about five volts, and when a train passes an insulated joint and enters a block it short-circuits the two rails and the signal goes to danger. As long as any pair of wheels is in the block the signal remains at danger, and as soon as the rear end of the train passes the insulated joint at the end of the block the relay picks up and the signal at the entrance to the block clears.

### Storage Yards.

Until the construction of the new extensions the only storage yard for cars was at Sixty-first street. This yard was a wooden structure and had trackage for only about 180 cars, the rest being stored on the middle track on Sixty-third street. The condition of the yard structure was such that it required the expenditure of large sums of money for maintenance and was a constant source of danger from fire. So it was replaced by a yard of steel construction on concrete foundations.

On the Englewood branch a steel yard five tracks wide has been built with a capacity for 100 cars. For the protection of cars from fire in this yard a fire car has been built and equipped. (This car was described and illustrated in the Electric Railway Review of November 9, 1907, page 764.) A similar car has been built for the yard on the Kenwood branch and one will be built for the stock yards branch.

In the Sixty-first street yard a 4-inch water main, with frequent standpipes, extends the length of the yard. This is connected to an electric fire pump, located in the shop, that may be started at a moment's notice and a pressure of 60

\*Abstract of a paper presented before the American Institute of Electrical Engineers, Chicago Section, February 18, 1908.

pounds per square inch afforded immediately. A steel yard with a capacity of 42 cars has been built at the end of the Kenwood branch at Forty-second street. The yard for the stock yards branch, also of steel construction, will allow the storage of 60 cars. On the main line between Calumet and Prairie avenues track room for over 280 cars has been provided. All the tracks are laid on the surface, connection with the elevated structure being made by a concrete and steel incline across Sixty-third street. The tracks for storing cars are all located east of the incline track. Just south of Sixty-third street a large area has been reserved for the construction of new shops.

The space west of the incline track is used for the storage of track material and coal. A connection has been made with the Lake Shore & Michigan Southern Railway, over which all material and coal can be switched into the yard and then transferred to any point by electric locomotives. Room is afforded for the storage of from 10,000 to 15,000 tons of coal. This coal is unloaded from the cars by a revolving locomotive crane operated by steam. It will operate a 10-ton load at 12 feet radius and a 3½-ton load at 30 feet radius. The clamshell bucket has a capacity of 1½ cubic yards and will handle one ton of coal at each operation.

The tracks are so arranged that the crane can unload from the railroad car and either dump the coal on the ground or load it into the elevated railroad's coal cars. During the elevation of the Chicago Junction Railway tracks at Fortieth street all the coal for the power house was delivered in this manner for a period of several months. The clamshell bucket will remove about 90 per cent of the coal from an ordinary flat bottom coal car. One crane man and two laborers in 10 hours can unload and load into other cars ten 50-ton cars, and can accomplish about 50 per cent more if storing the coal on the ground.

#### Car Equipment.

The present equipment of the road consists of 400 passenger and 14 work and coal cars.

Originally there were 180 trailer cars, hauled by steam



South Side Elevated Railroad—Coal Tracks in Rear of Power House.

locomotives, but in 1898 the road was electrified and 150 of the old trailer cars were converted into motor cars. These cars were equipped with two G.E.-57 motors, placed on one new motor truck, one of the old Baldwin trailer trucks being retained. The Sprague multiple-unit system of control was adopted and it is interesting to note that this was the first time that the multiple-unit system had received a practical test. But the idea of equipping each car with motors of sufficient power to propel itself—all the cars in a train being controlled from the head car and all acting as a unit—appealed so strongly to the operating department and to the consulting engineers that it was decided to adopt this system without its practicability having been demonstrated in actual service.

From 1900 to 1903 seventy additional cars were purchased, equipped with G.E.-73 motors of 75-horsepower capacity each and with the Sprague multiple-unit system of control.

In 1905 the last lot of 150 cars was ordered and these have all been put in service. These cars are 46 feet 5½ inches long over buffer timbers, with a seating capacity of 52. The electrical equipment consists of two Westinghouse-121 motors, rated at 90 horsepower at 550 volts. The control system is the Westinghouse multiple-unit system. The trucks were manufactured by the Baldwin Locomotive Works, one motor being installed on each truck of the car.

Although the two systems of motor control differ so radically in their method of operation, the new equipment has



South Side Elevated Railroad—Crane for Handling Coal in Yards.

been so designed that the two classes of cars work together perfectly, and it makes no difference how many cars of one system are in the same train with cars equipped with the other system.

#### Power House.

All the power necessary for the operation of the road is generated at the power plant at Fortieth and State streets, being aided by two storage battery installations, one at Fifteenth and State streets and the other at Sixty-first street and Calumet avenue. The power plant is located very nearly at the center of distribution of the road as a whole, being four miles from the loop and five miles from the end of the Englewood branch. In 1905 additional land was purchased and the company now owns the entire block from Thirty-ninth to Fortieth street, between State street and the elevated structure. The building was enlarged and two new units were added, space being provided for a third. The new units are 2,000-kilowatt Allis-Chalmers vertical cross-compound condensing Corliss engines, direct-connected to General Electric direct-current generators. The total capacity of the power plant at present is 11,700 kilowatts rated capacity, or 17,550 kilowatts on a 2-hour rating.

There are a few features of especial interest in connection with the switchboard and feeder installation and the manner of equalizing the generators. The old switchboard was of the double polarity type; that is, a switchboard on which the positive, negative and equalizer buses are installed. This type, at the time the old switchboard was installed, represented the very best design. On the switchboard were located the positive, negative and equalizer switches, thus necessitating all these cables from the generator to be brought to the switchboard, as well as the feeders to be taken away. When the extension of the power house was decided upon the installation of two 2,000-kilowatt units made it necessary with the old switchboard to run twenty 1,500,000-circular mil cables to the switchboard, besides the new feeders required to distribute their output. The distance from these generators to

the switchboard, and the changes necessary to install them, made it very expensive. After making a careful estimate of the cost to connect the new generators with the old switchboard and to install a new switchboard of the single-polarity type, it was found that there was very little difference in cost, while the advantages were all in favor of single polarity, so it was decided to install the latter type. With the old arrangement the machines were equalized on the positive side; with the new or single-polarity type of switchboard the generators are equalized on negative side, only the positive leads being taken to the switchboard.

There are no negative conductors in close proximity to the positive cables. In order to test the lead covering of the cables for any leakage of current each cable is connected to the contacts from the dial head of a rheostat, so that by connecting up a voltmeter to the arm of the rheostat and connecting to ground, each cable may be quickly tested. This is done once each day.

Coal may be supplied to the power house from two different sources. The Chicago Junction Railway has an elevated right of way in Fortieth street, just south of the power house, and from this an elevated spur has been built along the east side of the building. Above and just east of this is a spur from the elevated railroad, on which may be switched a coal train from the Sixty-third street yard. Under these tracks a wooden coal chute has been so built that coal dumped from



South Side Elevated Railroad—Long Station Platform on Kenwood Extension.

either track runs on to a Robins belt conveyor that conveys the coal to the crusher pits and thence into the house. (A view of the coal tracks is presented herewith.)

There is room for seven 50-ton cars on the lower track and for five 30-ton cars on the upper track. The lower track is supplied with a 100-ton Howe track scale.

#### Storage Batteries.

Until 1905 the railroad company had a storage battery located in a room under the Twelfth street station. The conditions were such that the battery could not be enlarged, so a new building was constructed at Fifteenth and State streets.

This building is a 2-story brick structure with concrete and steel floors and roof, fireproof throughout. The old Twelfth street battery was removed to the upper floor and enlarged by the addition of new plates to a capacity of 1,200 kilowatts, and on the lower floor was installed a battery of 1,000 kilowatts capacity in tanks of sufficient size to admit of increasing it to 2,000 kilowatts capacity for one hour. These batteries, as well as the one at Sixty-first street, were purchased from the Electric Storage Battery Company of Philadelphia.

The acid fumes are carried away by two methods. On the side walls below the ceiling are located openings that lead into ducts built in the wall and carried up to openings located just under the coping of the fire walls. Also in the ceiling are located numerous openings that lead into ducts that are carried to a house located on the roof, in which an electrically

driven fan in a separate chamber draws out the acid fumes and discharges them into the open air.

The operation of this battery is a great aid to the power station. It has a capacity sufficient to practically supply the peak load of the north end. In its operation it varies from a discharge of 5,500 amperes to a charge of 2,000 amperes, making the station load for the north end practically uniform.

The storage battery at Sixty-first street is located on the ground floor of the south end of the car repair shops. It was originally installed in 1898, and during the last year was rebuilt and is now practically a new battery. It now consists of 275 cells of G-51 type of the Electric Storage Battery Company, with special deep cells.

This battery is used in connection with a motor-driven booster, manufactured by the Western Electric Company. The booster has a guaranteed output continuously of 1,600 amperes at 70 volts and a momentary load of 3,000 amperes at 60 to 110 volts.

#### Feeder System and Bonding.

The positive feeder cables are carried in the cable box between the tracks. The feeder system is divided at the power house switchboard into four sections: First, the main line north of Thirty-ninth street; second, the main line south of Thirty-ninth street, including Englewood; third, the Kenwood line; and fourth, the "stock yards" line.

The third rail is fed at each station through quick-break switches, in such manner that the third rail carrying capacity is utilized for the purpose of conducting the power. On the main line the third rail is 40 pounds per yard.

The feeders running north from the power house are eight in number, with a total cross sectional equivalent of 9,000,000 circular mils, all of copper, partly bare and partly with weatherproof covering. By reason of the installation of the enlarged storage battery at Fifteenth street, it was not necessary to increase the feeder capacity on the north end.

The feeders running south are nine in number, with a total cross sectional equivalent of 11,500,000 circular mils. All of these are copper except two, which were installed the last year. These are aluminum, with triple-braided weatherproof covering, each with a carrying capacity equivalent to 1,500,000 circular mils in copper.

With the exception of the copper cable purchased for temporary use during the construction of the third track all the new cable purchased was aluminum, partly bare and partly with triple-braided weatherproof insulation. In all 177,000 pounds of aluminum were purchased.

On the Englewood branch the feeder cables are entirely of aluminum. The joints in the cables are made by slipping aluminum sleeves over the two ends to be joined and compressing the sleeve with a hydraulic press of 25 tons capacity. This pressure is sufficient to make a perfect union between the metal of the cable and of the sleeve.

The third rail on the Englewood branch is the ordinary steel T-rail, weighing 40 pounds to the yard. It is bonded with two No. 0000 compressed terminal bonds, applied in the web of the rail. The joint plates are the common fishplates fastened with four bolts. The 80-pound running rail is bonded with one No. 0000 compressed terminal bond, 10 inches long, applied in the web of the rail.

The steel structure is used in connection with the four running rails, as a conductor for the return current. Each track rail is connected to the structure every 400 feet by one No. 0000 compressed terminal bond. It is necessary to bond the steel structure at each expansion joint. At these points each girder is bonded to the corresponding girder beyond the expansion joint by two No. 0000 stranded bonds with Crown pin-driven terminals, and three soldered bonds of about 400,000 circular mils. This makes a total of eight No. 0000 cable bonds and 12 soldered bonds for the four girders at each expansion joint. The soldered bonds are flat strips of soft copper  $\frac{1}{8}$  inch thick, 2 inches wide and 22 inches long. The ends of the bonds are first tinned and then the girder is tinned at the point of application. The bond is then securely riveted to the girder by a  $\frac{3}{8}$ -inch flat-head iron rivet. Heat is applied and the bond soldered to the iron. The iron rivet holds the bond so that the vibration and strain due to contraction will not break the soldered connection.

The manner of connecting the feeders to the third rail is as follows: At each station is located a switchbox mounted on a concrete base through which enter five conduits. The third rail is broken opposite each box on each track, and each end is connected to a busbar in the switchbox through a quick-break 1,000-ampere switch. The busbar is connected to the feeder cable by a 1,000,000-circular-mil cable. In this way the third rail is utilized as a feeder and yet any section may be cut dead by opening one switch at each end.

At the crossover between Vincennes avenue and Grand boulevard there is an outrider in the third rail located between

the Chicago Junction track and the elevated tracks. To lessen the danger to trainmen from this source, an automatic cutout has been installed through which this outrider is fed. The east end of the outrider is free from any connections and the west end is fed from the third rail on the opposite side of the track through a contactor or switch, such as is used on the Sprague-General Electric type M control. The contactor is normally open and the rail dead.

When a train approaches the crossover the first shoe on the leading car energizes the outrider, which sends a current through the solenoid of the contactor, closing the switch. The outrider is then fed from the third rail on the other side of the track, and the cars passing the crossover may draw current. A train length beyond this outrider in such manner that when the first shoe of the leading car strikes this incline, the circuit through the solenoid of the contactor is opened and the outrider is dead until the next train passes. A circuit of lights has been so installed in the end of the contactor box that they are lighted as long as the outrider is charged. This device has been installed over two months and has given perfect satisfaction.

Both the third rail and track rails are bonded to the full capacity of the rail with two 500,000-circular-mil concealed bonds, 15 inches long, with Crown pin-driven terminals. To give better contact between bond terminals and the rail, both terminals and rail have been coated with Brown's mercury amalgam. This was done because of the good condition of bond terminals in the original installation of third rail in 1898, on which the bonds were treated in this manner.

The structure, track and stations were designed and constructed under the direction of C. V. Weston, then chief engineer of the company. The additions to the power house, feeder system and storage battery installations were planned and constructed under the supervision of Sargent & Lundy as consulting engineers.

**INCREASED FARES IN MASSACHUSETTS.**

In last week's issue of the Electric Railway Review letters were published from officials of electric railways in Massachusetts bearing on the movement to increase fares in that state. Additional statements have been received as follows:

**Taunton & Pawtucket Street Railway Company.**

Arthur C. Ralph, general manager Taunton & Pawtucket Street Railway, Taunton, Mass.: "Our property was started and operated for seven years on a fare of about one cent per mile, which has been found by actual experience, with the most rigid economy, to be insufficient to pay fixed charges and operating expenses. This state of affairs, of course, could not always continue, as we were not putting aside anything for depreciation or paying our stockholders anything on their investment. We finally decided to raise the fare to about 1 1/4 cents per mile, which was done on February 1, with, so far, quite satisfactory results. We did this by inserting another fare limit where we were carrying people between six and seven miles, most of the way through a sparsely settled community, for five cents. There has not been any great amount of fault found thus far and we believe there will not be, so long as we maintain our present and past good service. We think this is the situation: Keep cars and roadbed in good physical condition, cars clean and warm, and maintain a schedule upon which patrons can absolutely depend, and the price of the ride will not be seriously considered so long as it is within reason, but the minute the property gets run down physically and the schedule is irregular the road becomes unpopular, not only with the patrons of the road, but with its own employees, who will then turn in and help the public to give the road a 'black eye'; then attempt to raise the fares and every man, woman and child on the line will insist on making all the trouble possible. Street railways in Massachusetts have always had too low fares as a rule. We believe a fare should be regulated by distances, rather than a changeable unit. There is no doubt that a 5-cent unit is a convenient one from the standpoint of both the traveling public and the street railway and that people can be carried farther for five cents through a thickly settled territory than through a thinly settled one. It seems certain that a great many roads in this state must do something to increase their revenue, and that quickly, or go into the hands of receivers. Many of them had more burdens than they could carry, before the prices of supplies and labor advanced. Now they are showing a greater deficit each year and becoming physical wrecks besides. There is no state in the union that has a greater number of able street railway men, but they are unable to 'get blood out of a stone' or make

'water flow up hill.' Why not raise the fares by some means? Has any human being a valid argument against it?"

**Gardner Westminister & Fitchburg Street Railway.**

C. A. Jeffs, superintendent Gardner Westminister & Fitchburg Street Railway, Gardner, Mass.: "On the line from Gardner to Fitchburg, over 14 miles, this company operates 11 miles, on which we charge 20 cents fare. The Fitchburg & Leominster Street Railway takes our cars on its line into Fitchburg, charging five cents additional fare, making 25 cents from Fitchburg to Gardner, with transfers at the Fitchburg terminal. We have not made any changes in fares yet and hope the conditions will be such that we will not have to make any. The fare is about the same as that of the average road running in an open country and seems to be satisfactory to all passengers. I am not sure in my own mind about an increased fare. It might cause enough decrease in riding to offset the increase in fare."

**CAR DEFECT REPORT.**

About the first of the present year, H. H. Adams, superintendent of shops United Railways & Electric Company, Baltimore, put into use the report blank shown in the accompany-

Form L. 22, Revised, 11-9-07

**THE UNITED RAILWAYS AND ELECTRIC CO.**  
OF BALTIMORE.

**MOTORMAN'S REPORT OF CONDITION OF CAR.**

Car No. \_\_\_\_\_ Date \_\_\_\_\_ 190 \_\_\_\_\_ A. M. or P. M. Line \_\_\_\_\_

Length of Detention \_\_\_\_\_ Men's \_\_\_\_\_ Place of Trouble \_\_\_\_\_

Motorman \_\_\_\_\_ No. \_\_\_\_\_ Conductor \_\_\_\_\_ No. \_\_\_\_\_

Make check mark through appropriate defect to be reported. If the defect cannot be easily located, give in addition particulars which will assist in locating trouble. Report on be made out in duplicate, and both copies sent to Dispatcher, who MUST immediately forward original to Shop Foreman. If case this defect is such as to allow the car to remain in service, this Report must be handed to open car lot in store.

CAR BODY TROUBLE		CAR BODY TROUBLE - Continued		ELEC. EQUIPMENT TROUBLE	
End Door	Sand Box	Armature		Motor Flashed	
Broken Glass	Signs	" Backed		" Leads	
Ventilator	Hand Straps	" Rod or Handle		Controller	
Platform Gate	Register			Fuse Box	
" Chain	" Rod or Handle			Hood Switch	
Draw Bar	Curtains			Trolley Base	
Coupling Link	Grab Handles			" Pole	
Car Seats	Guard Rails			" Wheel	
Car Dirty	Signal Lamp			" Rope	
Signal Bell				Gear	
Bell Cord				" Case	
Electric Bell				Light Circuit	
Gong				Headlight	
Brake Staff or Handle				Resistance	
Fender				Trolley Retriever	
Dash				Light Switches	
Engineer Valve				Air Switches	
Air Gauge					
Car Stop					

REMARKS: \_\_\_\_\_

Sign \_\_\_\_\_ Motorman \_\_\_\_\_

IF CAR IS IN GOOD ORDER, sign in full here. \_\_\_\_\_ Motorman \_\_\_\_\_

1012 Federal Mail 608 Co., Bal. Jan. 14, 1909, Jan. 6, 1907.

**United Railways & Electric Company—Motorman's Report for Car Defects.**

ing illustration. It will be noted that this is a complete yet simple report on which, by means of check marks, the motorman can turn in a statement of the condition of his car. The report blanks are made into pads of convenient thickness. Each sheet of one of these pads comprises two blanks similar to that shown, one of which is backed with manifold carbon, so that it is a simple task to fold one half of a sheet over the other half and thereby obtain duplicate copies of each trouble report. Both copies are sent to the dispatcher, who immediately forwards the original to the shop foreman.

The British Columbia Electric Railway of Victoria, B. C., is installing a complete water system for fire protection, using standard hydrants and nozzles, on its properties in that city, and has purchased from the Allis-Chalmers-Bullock Company at Vancouver an 8-inch 2-stage Worthington turbine pump direct connected to a 150-horsepower 2,200-volt three-phase 60-cycle Allis-Chalmers-Bullock induction motor, also an electrically driven dry vacuum pump.



PROPOSED DESIGN FOR A PAY-AS-YOU-ENTER CAR.

The accompanying engraving represents a design for a pay-as-you-enter car invented by Charles B. Price of Pittsburg, Pa. The design was patented on September 13, 1904, but was considered too radical by the street railway men to whom it was submitted at that time. The design presents a number of interesting features which are radically different from the pay-as-you-enter cars which have been used in Montreal and have recently been placed in successful operation in Chicago and Buffalo.

This car is designed to make the pay-as-you-enter plan one of easy and practical operation; to secure the collection of every fare and a sure accounting for each fare collected; and to provide a safe exit for every passenger directly under the eye of the conductor, thus relieving the motorman of the necessity of watching the passengers.

To effect the first of these objects, rear and front platforms are abolished and the only entrance to the car is by a side platform, not too wide, say 28 inches in width, and long enough to accommodate about 15 people or as many more as may be thought best. The pressure of one passenger back of another moves everyone forward toward the conductor, who is stationed in an inclosure near the center of the car.

The second object is gained by the passage of each person through a registering turnstile, controlled by the conductor, who, after the collection of each fare, pushes a spring bolt which releases the turnstile and allows it to make a quarter turn while the passenger enters the car, his fare being thus registered.

The third feature is the central exit, directly alongside the conductor's box. The departure of passengers thus proceeds simultaneously with the entrance of other passengers.

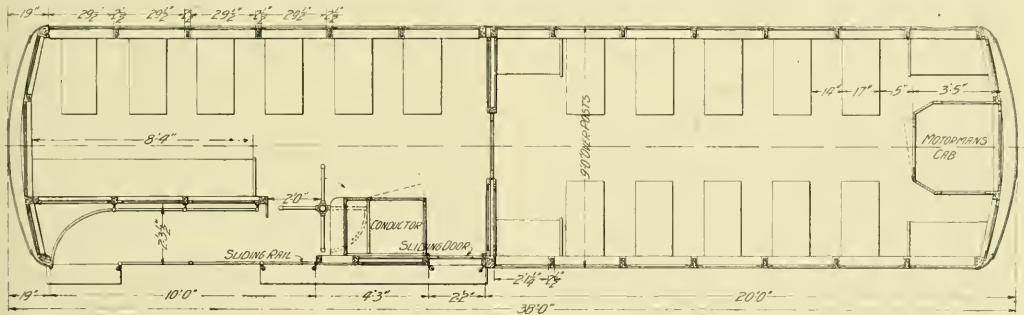

Design for a Pay-As-You-Enter Car with Side Entrance.

neither conflicting with the other; and when all passengers have boarded or left the car the conductor, from his controlling position, can give a push button signal to the motorman.

Among other advantages is the possibility of abolishing the signal cords, which are now used to ring up fares and communicate with the motorman, and which are a frequent source of trouble with drunken and unruly passengers; also, the central entrance and central exit make it possible to divide cars into two compartments, one for smokers, if desired, or, in some localities, into white and colored compartments.

The central position of the conductor is claimed to be an advantage, inasmuch as he is in the best position to observe, and, if necessary, to regulate, his passengers. His box should have a sliding door opening on the street, so that he can readily move to the rear of the car when necessary to adjust the trolley or to the front of the car when necessary to personally flag a grade crossing of a steam railroad.

USEFUL MOTOR CABLE JUNCTION SCHEME.

The accompanying sketch shows a device used in the shops of the Consolidated Railways Light & Power Company, Wilmington, N. C., which does away with the former method of tagging, taping and untaping the four motor connections whenever a car has to be jacked up for truck removal. The troubles from grounded wires due to wear on the truck frame, motor casing and cuts from the side bearings are also done away with. The motor cable is neatly taped up to a junction

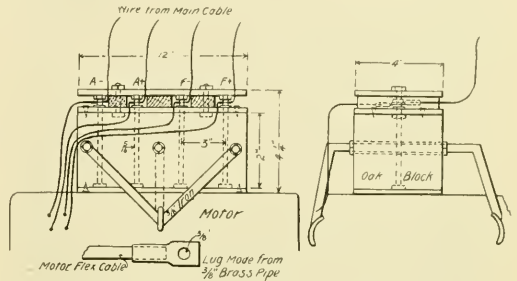

Method of Making Motor Connections.

box, where the wires spread out to receive their respective bolts or binding posts. The car cable wires are then led in on the other side of the motors, which makes it practically impossible to have any trouble from that source.

The box is made of oak and the bolts are insulated with 1/4-inch fiber, top and bottom. The lugs are simply pressed

out of 3/8-inch brass pipe and stamped according to their respective wires from the motors and car cable, so that an apprentice can connect up a set of motors with no trouble. The useful junction scheme was designed and adapted for use in the shops of this company by F. B. Culp, master mechanic, and has been found to effect a considerable saving in both time and labor, with but little cost. The device is used on the Westinghouse Nos. 56 and 112 motors with advantage.

The Indiana Union Traction Company, which has been running a single car over the streets of Alexandria, has asked permission to abandon the service, leaving the people to depend upon the interurban cars. The city authorities and the people generally are opposed to this plan and assert that the interurban company is making such change on account of the claim of \$1,000 against the company for damage alleged to have been caused to the mains of the municipal water plant by electrolysis, due to current escaping from the company's road.

# News of the Week

## Trial on Account of Charleston Interurban Accident.

Eight directors, officers and employes of the Central Illinois Traction Company were arraigned before the district court at Charleston, Ill., on February 24, charged with manslaughter and criminal negligence in connection with the collision on the Charleston-Mattoon interurban line on August 30, 1907, in which 18 persons were killed and a large number injured. The men who were indicted are: Judge Peter S. Grosscup, Arthur W. Underwood, Francis S. Peabody and Marshall W. Sampsell of Chicago, directors; President E. A. Potter of Chicago; Superintendent Fred Moore, Charleston; and B. F. McClara and Charles Botts, Charleston, the motormen of the two cars involved.

All of the accused pleaded not guilty and a motion was made to quash the indictments as faulty. The two principal counts on which the charge of criminal negligence is based are that the directors failed to prescribe adequate rules for the operation of the road and that they failed to exercise sufficient caution in the selection of employes. Levy Mayer of Chicago, attorney for the directors, argued the motion to quash the indictments and cited authorities to show that the duties of directors as required by law apply only to corporate powers and not to the physical management of the property. He held that the responsibility for the operation of a road rests with the executive officers in control and that the directors are not personally responsible in actions resulting from accidents. Arguments were also presented on Tuesday and Wednesday by counsel for the officers and for the employes. On Wednesday the state's attorney for Coles county made his address for the prosecution, holding that the directors are personally responsible and should take an active part in the management of the property. The arguments for the state were ended on Thursday and the case was again taken up by the defense.

## Rapid Transit Affairs in New York.

William R. Willcox, chairman of the New York public service commission of the first district, has issued a statement in which he summarizes the work of the commission since July 1, 1907, as follows:

It has increased the service on the surface, elevated and subway lines from 7 to 60 per cent.

It has ordered a general overhauling of the surface car lines.

It has redrawn the original plans of the Fourth avenue (Brooklyn) subway, making it larger, and has completed plans for the sixth section of that work.

It has changed and enlarged the plans of the subway loop connecting the three bridges on the east side so that it corresponds to the Fourth avenue subway in Brooklyn.

It has completed plans for the Broadway and Lexington avenue and of the Canal street subways, making them fit in a general underground transportation system that is destined to cover the entire city.

With reference to new lines of transit it has completed such plans that if the board of estimate appropriates money for their carrying out there will be going on within four months three times as much subway work as has ever been under way at one time in this city.

The commission has adopted resolutions calling upon the New York New Haven & Hartford Railroad, which controls the New York Westchester & Boston and the New York & Port Chester franchises, to tell why the work on the Westchester road has been discontinued since 1906, when the work will be resumed, when the section from One Hundred and Seventy-seventh street to the city line will be completed and in operation and also the probable time of the finishing of the road from the city line to the Westchester terminal.

The engineers of the public service commission have announced that the extension of the Brooklyn subway from the borough hall to the Flatbush avenue terminal of the Long Island Railroad will be opened for operation about July 1.

August Belmont, chairman of the board, Theodore P. Shonts, president, and George W. Wickersham, counsel, of the Interborough-Metropolitan Company, held a conference with Chairman Willcox of the public service commission on February 20 in regard to the Belmont tunnel, owned by the New York & Long Island Railroad, which is controlled by the Interborough. The tunnel is ready for operation but the company has no franchise. Negotiations are now said to be pending for a purchase of the tunnel by the city and it was understood that the conference had to do with a conditional plan for operating the tunnel. Chairman Willcox has addressed a reply to a resolution of the legislature, asking what the commission

had done toward opening the tunnel, in which he says: "If the New York & Long Island Railroad Company has forfeited its corporate rights and franchises, the commission is without present power to compel the operation of the tunnel, and, pending the final determination of the rights of the parties to the litigation, any attempt to do so would be premature and improper."

Comptroller Metz has announced that the city has no money to expend for subways in Manhattan and the Bronx at this time. He says that the city's available funds are all required for other public improvements that have been contracted for and that the city was committed to building the Fourth avenue Brooklyn subway, which would cost about \$8,000,000 a year, before it started any other lines. In speaking to a delegation from the Bronx which advocated extensions of transit facilities, he said they ought not to expect the roads to build further extensions without charging an additional 5-cent fare, and that as soon as the people would agree to the additional fare additional lines would be forthcoming.

## Holding Company Plan in Cleveland.

Several plans are under consideration for turning over the property of the Cleveland Electric Railway to the proposed holding company. If the pending negotiations result in a settlement it is planned that there shall be a consolidation of the Cleveland Electric Railway and the Forest City Railway, which may be brought about by an issue of Cleveland Electric Railway stock for the property of the Forest City Railway Company, then a renewal to the Cleveland Electric Railway Company of all franchises of both companies for a period of 25 years, at a rate of fare to be agreed upon, this renewal franchise being denominated in the negotiations a "security" franchise, and then, contemporaneously with the passing of the security franchise, a lease to the Municipal Traction Company, or other corporation, of all the street railway property of the city, at a rental of 6 per cent upon the value of all the physical property and of all the now existing franchises (not the security franchise) of the Cleveland Electric Railway Company. It is possible, however, that instead of a consolidation of the Cleveland Electric Railway and the Forest City Railway, or a purchase by the Cleveland Electric Railway Company of the property of the Forest City Railway Company, a new corporation to purchase the property of both companies will be formed, and a lease made by the new corporation to the Municipal Traction Company or other holding company, the stock of the new corporation being equal in amount to the value of the physical property and franchises.

Mayor Johnson and F. H. Goff reached an agreement on February 20 on a plan for ascertaining the average life of all the franchises within the city. A part of this general agreement was a concession by the mayor that the franchises affecting the East Fifty-fifth street line from Broadway, S. E., to the lake did not expire till 1914, in return for the concession by the company that the other portion of the line had no earning power beyond the date of expiration of the Hamm avenue grant. It was also conceded that the Burton line should be given no earning power beyond the date of expiration of the main grant.

Differences still exist on the length of life to be credited the portion of the St. Clair line now in the city, and also that of the Euclid main line. The mayor offered to concede half the time asked by the Cleveland Electric and also offered to allow the additional year on the Euclid Heights line alone. Neither proposition was accepted by Mr. Goff and it was finally decided to proceed with the computation and determine the differences in dollars and cents.

## Legislation Affecting Electric Railways.

Virginia.—The legislature has passed and the governor has approved the bill repealing the law which prohibited the paralleling of the Richmond Fredericksburg & Potomac Railroad, and this leaves the way open for the building of the proposed Fredericksburg & Southern Railway, in which Frank J. Gould and others are interested.

New York.—The Wagner 5-cent fare bill, the purpose of which is to secure a single 5-cent fare from Brooklyn to Coney Island, N. Y., was recommitted to the assembly railroad committee on February 1 on the ground that the public service commission has jurisdiction over the matter.

District of Columbia.—The house of representatives on February 22 passed the bill permitting the Anacostia & Potomac River Railroad, the City & Suburban Railway, the Washington Railway & Electric Company and the Capital Traction Company to extend their tracks to the new union station. The bill requires the companies to issue universal transfers and gives the district commissioners authority to regulate the service of the roads. The Capital Traction Company is also authorized to build an extension into the northeast section of the city. An amendment requiring the companies to provide

separate compartments for white and colored passengers was defeated by a vote of 140 to 159. An amendment requiring the companies to establish 3-cent fares was also defeated. The senate has refused to concur on the house amendments to the bill and has appointed a conference committee.—Senator Gallinger and Representative Smith have introduced a bill, at the request of the district commissioners, which constitutes the commissioners as a public service commission, with full power to regulate the rates, service and capital issues of all public service corporations within the district. The principal provisions of the bill, as drafted by the corporation counsel of Washington, were published in last week's issue, page 244.

**St. Louis Electrical Show.**—The first St. Louis Electrical Show will be held in the First Regiment Armory April 18 to 25, 1908, under the management of the Trades Exposition Company, 618 Mermod and Jaccard building, St. Louis.

**Jurisdiction of Chicago Municipal Courts in Personal Injury Suits.**—The Illinois supreme court has rendered a decision that the jurisdiction of the municipal courts of Chicago in personal injury suits is not limited to cases involving amounts less than \$1,000.

**Kansas City Public Utilities Commission Plan Defeated.**—The lower house of the Kansas City council on February 12 defeated an ordinance to provide for the appointment of a city public utilities commission, consisting of three members appointed by the mayor and two by the city council.

**The Variable Speed Motor.**—The Wisconsin branch of the American Institute of Electrical Engineers, Madison, Wis., held a meeting on February 27 at which J. B. Storey, engineer Northern Electrical Manufacturing Company, presented a paper on the "History and Development of the Variable Speed Motor."

**American Institute of Electrical Engineers.**—The Armour Institute of Technology branch of the American Institute of Electrical Engineers will, on March 12, listen to a paper on "Chicago Traction Problems," by R. H. Rice of the board of supervising engineers Chicago traction. On March 19 the programme includes a paper on "An Electrically Controlled Interlocking System," by E. W. Adams.

**Discontinuance of Stops Sustained.**—The federal court at Indianapolis has issued a perpetual injunction restraining the commissioners of Hancock county, Indiana, from interfering with the operation of the Indianapolis & Eastern Traction Company over the national road. The company recently discontinued several stops on the line and the commissioners ordered it to restore the stops under penalty of having the tracks and poles removed.

**Decision on Manner of Alighting from Cars.**—In a personal injury case against the Omaha & Council Bluffs Street Railway, in which the company's defense was that the woman was injured in stepping off a street car backward in direct violation of rules posted in the car, the supreme court of Nebraska has rendered a decision that it cannot take cognizance of the correct or incorrect manner of alighting from a car and that a passenger may alight in any way he chooses without prejudicing his right to recover damages.

**The Suburban Railway Club.**—The Suburban Railway Club was organized by officers and employes of the Boston Suburban Electric Companies of Newton, Mass., on January 6, for the purpose of promoting good fellowship and exchange of ideas among its members for the good of the service. On February 3 the club held a second meeting at Newton, at which the members were addressed by J. H. Neal, auditor of disbursements, and John Lindall, superintendent of rolling stock and shops, both of the Boston Elevated Railway.

**Missouri Electric Light, Gas and Street Railway Association.**—Charles Z. Pierson, secretary, St. Charles, Mo., writes that the next meeting of the Missouri Electric Light, Gas and Street Railway Association will be held at the Marquette hotel, St. Louis, Mo., April 23 to 25, the date having been selected so as to give the members an opportunity to visit the first St. Louis electrical show, which will be held under the management of the Trades Exposition Company, April 18 to 25. The programme of the meeting has not yet been announced.

**Recent Accidents.**—It is reported that 15 passengers were injured on February 21 at Northboro, Mass., when a car of the Worcester Consolidated Street Railway jumped the track and struck a large tree.—On February 22 an interurban car of the Cambridge Power Light & Traction Company, while stalled on a trestle near Cambridge, O., because the trolley wheel had left the wire, was struck by a city car which was following at a high rate of speed. The forward car was badly wrecked and one passenger was killed and 15 injured.—In a collision between two interurban cars of the Inter-Urban Railway at

Moran Junction, Ia., on February 25, the motorman and five passengers were injured. Defective brakes on the rear car, allowing it to collide with the car ahead, which was standing at the junction at Moran, are said to have caused the accident.

**Illinois Traction System Trainmen Required to Pass Examination.**—Employes of the Illinois Traction System, whose duties are connected with the operation of cars, will hereafter be required to pass an examination similar to that required by the steam railroads. The men at present employed are now being examined on their knowledge of the rules and of the car equipment and as to their hearing, eyesight and general physical condition, and all applicants for positions in the future will undergo similar tests. Schools of instruction are also being established.

**Des Moines Franchise Case.**—Judge Howe of the Iowa state court at Des Moines has handed down a decision in the quo warranto cases brought by the civic league, that the Des Moines City Railway must file an answer within 30 days showing what franchise it is operating under. The decision of Judge McPherson of the United States district court that the company's franchise is perpetual has been appealed to the supreme court. It is stated that the company will secure an injunction against Judge Howe's decision until the supreme court has passed upon the appeal.

**Race Separation Law Causes Trouble.**—Both the railroads and street railways of Oklahoma have met with difficulties in attempting to enforce the new law requiring the separation of white and colored passengers, which went into effect on February 16. The Muskogee Electric Traction Company has had trouble with the negroes, who have in many cases refused to accept the seats assigned to them and there has been considerable disorder. In Oklahoma City the Oklahoma Railway Company had trouble with the white people, who object to standing while there are seats in the negro section.

**Continuation of Grade Crossing Permits.**—The Massachusetts railroad commission has granted a continuation of the permit whereby the Holyoke Street Railway maintains a grade crossing with the Boston & Maine Railroad at Race street, Holyoke, to December 1, 1909. Similar extension has been granted the Old Colony Street Railway, crossing the New York New Haven & Hartford Railroad at Central street, East Bridgewater, and Dean street in Taunton. In addition to previous conditions the board now requires that the companies shall notify it seasonably of any substantial increase in the traffic over the crossings.

**Hudson River Tunnel Opened.**—In accordance with the plan announced in our issue of last week the north tunnels of the Hudson & Manhattan Railroad were officially opened on February 25. At 3:40 p. m. a train of eight cars, bearing officials and guests of the company, some 800 in number, and including the governors of New York and New Jersey, left the New York terminus at a signal telegraphed from Washington by President Roosevelt. At Hoboken there were appropriate exercises and in the evening a dinner at Sherry's concluded the official celebration. The first regular train left the New York terminus at midnight.

**Central Electric Accounting Conference Committee.**—M. W. Glover, chairman of the Central Electric Accounting Conference, Cincinnati, O., has appointed the following committee to obtain samples of interline freight, ticket and claim account blanks in use on the different lines and to prepare recommendations as to the most suitable forms of blanks for use, the report to be presented at the next meeting of the conference. W. B. Wright, auditor Indianapolis & Cincinnati Traction Company; C. B. Baker, freight auditor Western Ohio Railway; T. C. Dodd, freight claim agent Terre Haute Indianapolis & Eastern Traction Company.

**Attitude of Employes to the Public.**—President John I. Beggs of the Milwaukee Electric Railway & Light Company delivered an address on Tuesday evening at a social meeting of the employes and their friends at the Public Service building. Mr. Beggs said that public sentiment regarding the company depends largely upon the kind of treatment the public is accorded by the employes, who necessarily reflect the attitude of the company itself and its management. "I appeal to the ladies present," he said, "to inspire the workers in the employ of this company to render the company at all times cheerful, enthusiastic service." He told the men to believe in their employer or to leave, for, he declared, the company is absolutely dependent upon its employes for the treatment the public receives.

**Specifications for Engines and Boilers.**—On February 4 the Purdue branch of the American Institute of Electrical Engineers held a discussion on specifications for engines and boilers. Prof. C. H. Benjamin, who led the discussion, divided

specifications into two general classes: The first a general specification of size and type of machine to be supplied, which he called the owner's specification; the second, a more detailed specification made by the manufacturer of a machine he has to offer, and is known as builder's specification and may become the basis of a contract. The owner's specifications should be clear and be confined to indispensable qualifications. The contract in itself should be a simple affair and entirely devoid of technical language. It should state that the builder agrees to deliver at such a time and place a machine according to specifications and guarantee to operate satisfactorily, for which he is to receive payment in accordance with stated conditions. To become a contract this must be accepted by the buyer.

**Wage Controversy in Des Moines.**—It is reported that the wage controversy between the Des Moines City Railway Company and its employes is reaching a crisis. An arbitration committee composed of a representative of the company and a representative of the employes has had the question under consideration for several days without being able to agree and a list of seven names, presented by the men, from which to choose a third arbitrator, has been rejected by the company. The contract with the car men provides for an adjustment of the wage scale for the ensuing year on February 12. The men have demanded a scale of 23, 25 and 28 cents per hour for the three grades of employes, an increase of about 35 per cent, which the company considers exorbitant, considering the present business conditions. The executive committee of the car men's union has been given authority to call a strike at its discretion. The arbitration committee has been furnished statements of the company's financial condition and operating expenses in support of the claim that the company cannot increase wages at the present time.

**Public Service Dinner of the American Institute of Electrical Engineers.**—At the annual dinner of the American Institute of Electrical Engineers, held in New York on February 19, addresses were delivered by Theodore P. Shouts, president of the Interborough-Metropolitan Company, who spoke on "The Electric Railways and the Public"; Frederick Stevens, chairman of the public service commission of the second district, who spoke on "The State Control of Public Service, Past and Present"; and Walter C. Kerr, president of Westinghouse, Church, Kerr & Co., who spoke on "The Ethics of Public Service." Mr. Kerr said in part: "To be effective, public service commissions must be supported. To be supported they must be right. Public service is essentially a monopoly, and thus ethics must be based to a considerable extent on this premise. We may talk about competition all that we please, but in the last analysis it will be found that the evils of competition are, as a rule, greater than their benefits. For this reason we permit by franchise only a limited competition, and often we permit too much. Competition is a panacea to which the ignorant fly for help."

**Minnesota Commission Wants Jurisdiction over Electric Roads.**—The Minnesota railroad commission, in its annual report, recommends that its jurisdiction over electric railways be increased. The report says in part: "Under a recent decision of the supreme court, a certain character of suburban electric railway seems to be placed under the jurisdiction of the commission. In this connection it is contended by some authorities that the jurisdiction would not extend to that portion of the line within the corporate limits of any village or city. It will be apparent that supervision limited as this would limit it, would be entirely impracticable and useless. Undoubtedly these electric lines will in many cases be owned and operated by steam railways, and, in the judgment of the commission, the best interests of the state will be served by placing electric railways under the jurisdiction of the commission. We therefore recommend legislation to that end." The commission also recommends "that legislation be enacted requiring all parties who may desire to build extensions or new lines of railroads, regardless of the motive power to be used, to secure the written consent of the commission upon application setting out in detail the contemplated improvement and after public hearing, the object being to prevent the unnecessary duplication of roads or building of unnecessary lines."

An electric generator in a smelting plant at West Jordan, Utah, is said to have been in constant operation, 24 hours a day, for nearly four years and a half, with a single interruption, which was due to a broken pulley, for which the generator was in no way responsible.

The Chicago South Bend & Northern Indiana Railway is preparing to make improvements at its amusement park near Goshen, Ind., on the Elkhart river.

# Traffic and Transportation

Bulletins for the Public in Baltimore.

The new policy adopted by William A. House, president of the United Railways & Electric Company of Baltimore, includes the publication of bulletins regarding the service in the advertising columns of Baltimore daily newspapers. These advertisements have attracted a great deal of attention from the public and have received favorable comment from the newspapers. In Bulletin No. 1 it was stated that "we are making friends with the people of Baltimore," and complaints and suggestions were invited. Bulletin No. 2 discussed the rush-hour problem in this way:

"We are always at work on this problem. We first increased our equipment to the maximum. We next doubled the carrying capacity of the cars themselves. Then we asked for the right to use German street. Now we start cars every day from all sections of the city up to the limit of the capacity of the congested streets, and timed to reach the crowded sections when the rush is on. Any further increase in the service on the lines operated on these streets would mean a blockade."

In Bulletin No. 3 the company said in reference to the transfer system:

"Before the various consolidations which resulted in placing the street railways here under one management, transfers were given only between lines of the same company, and some companies charged three cents for this privilege.

"Shortly after 1899, when the last consolidation took place, the legislature gave this company the right to charge five cents full fare and three cents for children throughout the city on the condition that free transfers would be given inside the city. The company put into effect a universal transfer system on July 1, 1900. Since that date the number of transfer points has grown steadily. By 1902 there were 142 transfer points, and by April 1, 1907, the number had increased to 186, an addition of 44 points. There are at present 195 transfer points, while the 'privileges of transfer'—i. e., the number of lines to which transfers may be had at these points—equals 1,622.

"Over 334,000,000 transfers have been used since this law went into effect. That is to say, about 40 per cent of all passengers take transfers.

"It is only fair that people should not ride twice for one fare, and reasonable regulations are necessary to prevent this. The only restrictions we make on the transfer privilege are such as are necessary for our own protection to prevent those economically inclined from getting a return trip at our expense. No fair-minded man can say that such restrictions are unreasonable. We know, however, that every arrangement is subject to improvements, and we have men at work constantly studying the transfer system.

"It is our business and intention to give you the best street car service that can be had, and we point to these figures as proof of what we have done in this most important particular. What we ask you to do is to read your transfer. If it is not good on a certain line, do not blindly censure us; think out the reason for yourself, and you will find, we hope, that in every case the reason is not an arbitrary one, but a matter of necessity for self-protection."

**Illinois Traction System Makes Contract with Express Company.**

The Illinois Traction System has made a contract with the United States Express Company providing that the electric railway shall transport over its lines business of the express company. B. R. Stephens, general traffic manager Illinois Traction System, in a letter regarding the contract, says:

"This contract goes into effect on April 1. The United States Express Company will handle its business via our lines. This does not mean that the express company will take over any of the business which we term express operated by the Illinois Traction System. The revenue under the contract is to be a percentage of the gross earnings, with a minimum amount guaranteed per year."

The American Express Company has closed a contract for handling its express business over the lines of the Ft. Dodge Des Moines & Southern Railroad, Ft. Dodge, Ia. The arrangement went into effect on February 13.

**Changes in Service Approved by the Court.**—Judge Lacombe of the United States circuit court, New York, has approved certain changes made in the operation of cars by the receiver for the Forty-second Street Manhattanville & St. Nicholas Avenue Railway. Judge Lacombe says that the receiver has decided to confine the service of its cars to its own lines, instead of using them to increase the service on the lines

of other roads. His road is now insufficiently supplied with cars, and by calling in cars from outside service he will be able forthwith to obtain better service on his own line, and he expects to still further increase that service with additional cars as soon as he can purchase them.

**Fare to Coney Island.**—The New York public service commission, first district, entered an order on February 21 requiring the Brooklyn Rapid Transit Company to show cause why the fare between Manhattan and Brooklyn and Coney Island should not be reduced from 10 to 5 cents.

**Good Record at Ft. Wayne, Ind., During Snowstorm.**—Although the fall of snow was extremely heavy at Ft. Wayne and between that point and Lafayette, Ind., during the blizzard of last week, the greatest delay the Ft. Wayne & Wabash Valley Traction Company experienced on any train was 50 minutes.

**Complaint Regarding Brooklyn Rapid Transit Service.**—The New York public service commission, first district, has issued an order requiring the Brooklyn Rapid Transit Company to answer the complaint of citizens that the service west of Luna park is defective and that to reach their homes people living there have to pay 15 cents fare or walk about a mile.

**Brazil, Ind., Merchants Complain Regarding Fares.**—Merchants of Brazil, Ind., have filed a complaint with the Indiana railroad commission concerning the rates of the Terre Haute Indianapolis & Eastern Traction Company. The bill charges unjust discrimination against the city of Brazil and in favor of Terre Haute. The commission is asked to readjust the rates.

**Through Routes in Chicago.**—Three of the through routes for which provision is made in the Chicago City Railway and the Chicago Railways Company ordinances will be established in Chicago soon. In order to facilitate the operation of cars on these routes the companies will use small cars temporarily. The large cars could not be used without considerable delay while subways under railroads are being prepared.

**Abuse of Transfers in Philadelphia.**—In an endeavor to stop the abuse of the time limit on transfers the Philadelphia Rapid Transit Company has posted the following notice in its cars: "On account of abuse of transfer ticket privileges the public is hereby notified that conditions printed on such tickets will be strictly enforced, and in future conductors will be held accountable for proper issue and acceptance of transfer tickets."

**Order Designed to Reduce Accidents.**—The Fitchburg & Leominster Street Railway, Fitchburg, Mass., has recently announced an order which the management believes will minimize accidents to passengers leaving moving cars. The order provides that conductors, on approach to a stop, shall stand on the rear platform at the platform exit, facing the front, with left hand on front grab handle and right on the rear handle, preventing exit until the car stops. This order has been in effect several weeks and is working admirably.

**Hearing on Petition to Carry Freight.**—The Fitchburg & Leominster Street Railway, Fitchburg, Mass., was given a hearing on February 24 on its petition to carry freight in Lunenburg, by the selectmen of that town. There was a unanimous expression favoring granting the petition without any restrictions, save what may be exacted by the state railway commissioners. Final action will be taken at a regular meeting of the selectmen on February 29. If the petition is granted it is not unlikely that similar petitions will be presented in Leominster and Fitchburg.

**Service in New Orleans.**—Joseph H. Le Grange, vice-president New Orleans (La.) Railway & Light Company, has written a letter to Mayor Behrman of New Orleans in reply to a complaint regarding the service. The letter says that while some of the cars of the company do not present the appearance desired, financial conditions have prevented the company from buying new equipment and have made it necessary to repair the cars now in use. The directors, however, have directed the purchase of a large number of new cars, which will be obtained as soon as possible. Mr. Le Grange also states that the company now has in operation on all its lines more cars than are required by its franchises, and adds: "The public is perhaps not aware that each time the streets become flooded and electric cars are compelled to run through water reaching the motors, the armatures are burned out and the cars put out of service. On one particular occasion an unusually heavy rainfall during a short period of time put upward of 50 cars out of service and entailed heavy expense and inconvenience until the cars could be repaired and again placed in service."

# Construction News

## FRANCHISES.

**Shelbyville, Ill.**—The franchise granted two years ago to the Capital Circuit Traction Company, which proposed to build a line encircling Indianapolis, has been forfeited because the company failed to begin construction by February 20, 1908.

**South Waverly, Pa.**—The Sayre Railway Company, Sayre, Pa., has applied for a 37-year franchise to build and operate a single-track electric railway in South Waverly, Pa., to be completed and in operation by December 7, 1908.

## INCORPORATIONS.

**Shreveport Suburban Railway, Shreveport, La.**—Incorporated in Louisiana with a capital stock of \$50,000. John Lorenz, president; J. B. Atkins, secretary and treasurer. S. A. Guy, Shreveport, also is interested. Work already has been started on the line. The road will extend to Marshall, Tex. (Noted January 18.)

## TRACK AND ROADWAY.

**Bloomington Pontiac & Joliet Electric Railway, Pontiac, Ill.**—H. A. Fisher, president, writes that this line will be extended this year from Pontiac to Chenoa, 10 miles, and possibly to Lexington, 9 miles farther south.

**Boston Waltham & Western Electric Railroad, Waltham, Mass.**—The Massachusetts railroad commission at a hearing last week considered arguments for and against the proposed plan of this company to build an electric railway from Waltham to Marlboro, Mass., 23 miles. The opposition urged that as the company proposed to buy power from the Newton Street Railway and would in other ways be governed by street railway conditions it was not included in the jurisdiction of the commission under the electric railway law of 1906. Charles E. Stevens is interested.

**Calumet & Lac la Belle Traction & Power Company, Calumet, Mich.**—E. K. Stewart, Calumet, Mich., general manager of this company, writes that construction work on its proposed line between Calumet and Mohawk, Mich., will be started as soon as the weather permits. (Noted January 18.)

**Chicago South Bend & Northern Indiana Railway, South Bend, Ind.**—We are advised that grading is practically completed on the extension of this line from South Bend to La Porte, Ind., 27 miles. The route includes the following towns: South Bend, Pine Lake, Lydic, New Carlisle, Terre Coupe, Rolling Prairie and La Porte. Samuel Riddle, general manager, South Bend, Ind. It is currently reported that the Murdock syndicate, controlling this company, is about to close a deal for the assets and franchises held by the Chicago-New York Electric Air Line Railroad. This would give the Murdocks possession of the franchises in Gary and enable the syndicate to carry out its long-contemplated plan of constructing a line from La Porte to Chicago and at the same time provide street railway facilities for the city of Gary.

**Dallas (Tex.) Consolidated Electric Street Railway.**—This company has applied to the board of commissioners of Dallas for a permit to lay a second track on Ackard street, between Jackson and Canton streets, and for several changes in switches and sidings.

**Franklin, Pa.**—Residents of the Sugar Creek valley, Pennsylvania, are desirous of securing an electric line to connect Franklin and Cambridge Springs, and it is stated that they would be glad to co-operate to this end in securing the necessary right of way.

**Jefferson (Ia.) Interurban Railway.**—Articles of incorporation are being prepared by this company for the purpose of building an interurban railway out of Jefferson. It is stated that 25 business men have subscribed \$100 each for the expenses of preliminary surveys which are to be started at once.

**Johnstown (Pa.) Passenger Railway.**—It is reported that construction work is to be started soon on a 2-mile extension from Johnstown to Southmont, Pa. G. Nelson Smith, chief engineer.

**Joliet & Southern Traction Company, Joliet, Ill.**—H. A. Fisher, president, writes that this company's plans for construction work for the coming season are rapidly taking shape and that it is expected to finish the Blue Island extension from New Lenox, the present eastern terminus, through to

Blue Island and possibly to Chicago Heights, with a branch to Frankfort. It is also expected to build south from Joliet as far as Wilmington, a distance of 16 miles.

**Lake View Traction Company, Memphis, Tenn.**—H. E. Craft, vice-president, is quoted as saying that construction on the line from Memphis to Lake View will be started early in April. The line to Clarksdale, Miss., will not be undertaken until after the completion of the first portion of the line.

**Little Falls, Minn.**—F. E. Cawley, Minneapolis, Minn., is said to be promoting an electric railway from Little Falls to a point south of Gregory, Minn., on the Minneapolis St. Paul & Sault Ste. Marie Railway, about seven miles.

**Matamoras & Santa Cruz Railway.**—It is reported that a St. Louis syndicate headed by S. W. Fordyce has purchased this 3-mile horse car line, running from the ferry on the Rio Grande river opposite Brownsville, Tex., to Matamoras, Mexico, and will electrify it. It is also stated that the syndicate will build a bridge across the river.

**Milwaukee & Fox River Valley Railroad, Fond du Lac, Wis.**—This company has filed amended articles of incorporation making a change in its proposed route. It is now proposed to build from Milwaukee through the counties of Milwaukee, Washington, Ozaukee, Sheboygan, Manitowish, Calumet, Winnebago and Outagamie to Appleton, Wis., with a branch from Fond du Lac northeasterly through the counties of Fond du Lac and Calumet, Wisconsin. John Saemann of Sheboygan is president. (Noted December 28, 1907.)

**Mogollon, N. M.**—It is stated that the Ernestine Mining Company of Mogollon is planning to build an 8-mile electric line for the purpose of hauling lumber from a new lumber district which it intends to develop in that section. E. Craig, president.

**Muskogee (Okla.) Electric Traction Company.**—This company expects to place contracts within the next few weeks for the construction of 2½ miles of track. R. D. Long, general manager, Muskogee, Okla.

**Oklahoma Railway, Oklahoma City, Okla.**—Announcement is made that this company has completed its 8-mile extension to Britton, Okla., and will begin operating cars this month. It is stated that the company now proposes to extend its line from Britton to Edmond, five miles, and later to Guthrie, 16 miles. John W. Shartel, vice-president. (Noted November 9, 1907.)

**Oley Valley Railway, Reading, Pa.**—Announcement is made that this company intends to complete an extension between Boyertown and Pottstown, Pa., about nine miles.

**Peninsular Railway, Bartow, Fla.**—It is announced that this company has secured additional right of way for a proposed 37-mile extension to Tampa, Fla. The company has built eight miles of electric line from Bartow to Mulberry and it is proposed to begin work on the new line in a short time. W. H. Evers, Bartow, Fla., is chief engineer.

**Pittsburg Canonsburg & Washington Electric Railway, Pittsburg, Pa.**—Contracts for grading have been let for the construction of this proposed line as follows: From East Canonsburg to Van Eman, two miles, W. H. Murdoch, Pittsburg; from Thompsonville to Clifton, 1½ miles, W. J. Payne & Sons, Pittsburg; from Clifton to Castle Shannon, two miles, Samuel Gamble, Carnegie, Pa. Bridges are to be built at East Canonsburg, Van Eman, Thompsonville and Clifton. The line will be built from Washington, Pa., to Pittsburg, by way of Canonsburg, Thompsonville, Castle Shannon and West Liberty, a total distance of 31 miles. The company is a subsidiary of the Pittsburg Railways. Grading was started in November, 1907. F. Uhlenhaut, president.

**Pittsburg Lisbon & Western Railroad, Pittsburg, Pa.**—It is reported that this company contemplates the extension of its road from Darlington, Beaver county, and also intends to electrify its line for the entire distance from Lisbon, O., to the Beaver valley, where a connection will be made at Morado with the proposed New Castle & Beaver Falls Electric Railway, thus giving connection with New Castle and Youngstown. N. B. Billingsley, president, Lisbon, O.

**Sioux City Traction Company, Sioux City, Ia.**—It is stated that this company will relay about four miles of track in the near future. (Noted July 20, 1907.)

**Toronto (Ont.) Railway.**—The city of Toronto has made application to the Ontario legislature for an act to amend the acts respecting the Toronto Railway, so as to make it clear that the company has not the right to lay tracks on the Toronto streets without the city's consent. This has been brought about by a long course of litigation between the city

and the company, through all the Canadian courts to the judicial committee of the privy council.

**United Traction Company, Reading, Pa.**—It is stated that this company is planning to build an extension from Womelsdorf to Myerstown, Pa., during the coming year, by which a direct route from Reading to Harrisburg by trolley will be afforded. Walter A. Rigg, general manager, Reading, Pa.

**Vincennes Traction & Light Company, Vincennes, Ind.**—This company is said to be contemplating an expenditure of about \$100,000 in improvements to its property. George E. Henry, general manager, Vincennes, Ind.

**Wabash Valley Railroad.**—It is reported that this company, which recently was organized to build an interurban railway in Illinois and Indiana, will begin construction in the spring. It is intended to operate the line with gasoline electric motors. It will serve the following towns: Danville, Ill.; Clinton, Newport, Hillsdale, Cayuga and Perysylvia, Ind., with a possible connection later with Terre Haute. D. C. Johnson, Clinton, Ind., president; W. S. Lewis, Clinton, vice-president; E. S. Aikman, Newport, Ind., secretary; H. B. Davis, Newport, treasurer. (Noted January 11.)

**Warren-Bisbee Railway, Bisbee, Ariz.**—It is reported that this line, which now connects Warren and Bisbee, Ariz., a distance of five miles, will be extended to Douglas, a distance of eight miles.

**Wichita (Kan.) Railroad & Light Company.**—This company expects to double-track about three miles of its line during the coming summer. The old single track is to be removed and relaid with 60-pound 6-inch T-rails. H. E. Chubbuck, general manager, Ottawa, Ill.

**Winona Interurban Railway, Winona Lake, Ind.**—It is reported that this company is preparing to extend its track in Goshen, Ind., north on Ninth street to the factory district.

#### POWER HOUSES AND SUBSTATIONS.

**Bowling Green (Ky.) Railway.**—It is reported that this company is building a new power station. H. D. Fitch, general manager, Bowling Green.

**Chicago & Joliet Electric Railway, Joliet, Ill.**—We are officially advised that the report published in our issue of February 1, 1908, page 163, that this company proposed to erect a new power station and install new apparatus in several of its substations is entirely incorrect, as the company has no such plans under contemplation.

**Indianapolis Columbus & Southern Traction Company, Seymour, Ind.**—A. A. Anderson, general manager, writes that it is planned to install a 1,000-kilowatt generator in the power station at Edinburg, Ind., and to put in new substations at Southport and Franklin, dispensing with the one now in operation at Greenwood, which will give an improved distribution of power.

**Mobile (Ala.) Light & Railroad Company.**—The new power house of this company at Mobile, Ala., is now nearing completion. It will be equipped with a 1,200-kilowatt generator, driven by an Allis-Chalmers Corliss engine, operating condensing on steam at 160 pounds pressure. An overhead system of coal handling will also be installed.

**Port Arthur (Ont.) Electric Street Railway.**—The city council has completed arrangements with the Kaministiquia Power Company for a supply of 700 horsepower, to be used for lighting and for the operation of the municipal street railway.

**United Traction Company, Reading, Pa.**—This company is said to be planning the addition of water and steam driven units to its power station at Klappertal, Pa., so that the operation of the plant will not be affected by low water conditions. Walter A. Rigg, general manager, Reading, Pa.

**Wausau Street Railroad, Wausau, Wis.**—We are advised by Neal Brown, president, that this company expects to develop a large water power in the vicinity of Wausau, the rights for which it has recently purchased from the Joseph Dessert Lumber Company. The power site is known as the Mosinee water power located in the village of Mosinee, 13 miles south of Wausau. It will develop this power very soon and, in addition to what is used for the operation of its railroad, expects to have a large surplus for sale. It will develop and sell this power electrically at prices ranging from a minimum of \$15 per horsepower per year upward. The company expects to engage in an extensive canvass for customers who will build manufacturing institutions and use this power. Money for the development of power has been raised. The Mosinee water power has 4,000 miles of the Wisconsin river drainage area tributary to it.

## Personal Mention

Mr. H. C. Green has resigned as superintendent of the Muncie & Portland Traction Company, Portland, Ind.

Mr. S. E. Mahan has resigned as assistant claim agent of the Twin City Rapid Transit Company.

Mr. Hugh McCloskey has been elected chairman of the board of directors of the New Orleans (La.) Railway & Light Company.

Mr. H. A. Fisher of Joliet, Ill., has been elected president of Bloomington Pontiac & Joliet Electric Railway, which was acquired last fall by the Fisher interests.

Mr. George Keegan, secretary of the American Street and Interurban Railway Manufacturers' Association, was married on February 20 to Miss Mary Cecilia Brennan of New York City.

Mr. George Fielder, general manager of the Chatham Wallaceburg & Lake Erie Railway, Chatham, Ont., has resigned. He will be succeeded by Mr. D. A. Gordon, M. P., of Wallaceburg, Ont.

Mr. John J. Cleary has been elected treasurer of the Escanaba (Mich.) Electric Street Railway, succeeding Mr. John K. Stack, who has been elected president to succeed Mr. A. R. Moore, resigned.

Mr. H. B. Ritz has been appointed passenger agent and manager of Myers Lake park at Canton, O., controlled by the Northern Ohio Traction & Light Company of Akron, O. He succeeds Mr. W. D. Harris.

Mr. H. E. Farrington, formerly master mechanic of the United Railroads of San Francisco, has been appointed superintendent of car repairs of the Boston & Northern Street Railway, with headquarters at Chelsea, Mass.

Mr. Frank M'Coy has been appointed general manager of the Allegheny Valley Street Railway and the Allegheny Valley Light Company at Tarentum, Pa. Mr. M'Coy formerly represented the St. Louis Car Company at Pittsburg, Pa.

Mr. Arthur L. Smith, whose resignation as superintendent of the Central Kentucky Traction Company and the Lexington Railway was announced in our issue of January 11, has accepted a position with the Cincinnati Northern Traction Company, Cincinnati, O.

Mr. James L. Sullivan of Worcester, Mass., has been appointed purchasing agent of the Berkshire Street Railway, succeeding Mr. Richard T. Lawless. Mr. Daniel E. Burgess will succeed Mr. George R. Scarritt, whose resignation on February 1 as roadmaster of the company was announced in our issue of February 8.

Mr. Thomas Green has been appointed superintendent of the Cincinnati Newport & Covington Light & Traction Company, Covington, Ky., succeeding the late James R. Ledyard. Mr. Jefferson Mains has been appointed general foreman and in this capacity will discharge some of the duties heretofore assigned to the superintendent.

Mr. J. M. Andrew was elected president of the Indianapolis & Louisville Traction Company, Louisville, Ky., at the annual meeting of stockholders and directors, held in Scottsburg, Ind., several days ago. He succeeds Mr. John C. Mayo, who was elected chairman of the executive committee. Mr. James C. Chaplin was elected first vice-president to succeed Mr. John E. Greeley, who was made assistant to the president. The other officers were re-elected.

Mr. J. C. Huston has been appointed superintendent of the Detroit Monroe & Toledo Short Line Railway, effective at once, with headquarters at Monroe, Mich., succeeding the late Murdock McAulay, whose death occurred on February 11. Mr. Huston formerly was a conductor on the Detroit Ypsilanti Ann Arbor & Jackson Railway, and more recently has been car house foreman of the Detroit Monroe & Toledo. Mr. Fred M. Benson, who has been conductor on the line since it began operation, has been appointed assistant superintendent with headquarters at Monroe.

Mr. W. G. Meloon, general manager of the Atlantic Shore Line Railway at Portsmouth, N. H., has resigned to accept another position with A. H. Bickmore & Co., New York City, the present owners of the property. Mr. Meloon's retirement is due to the ill health of his wife, who is obliged to seek another climate, and it is understood that he will become associated with one of the southern or western properties of the company. Mr. Meloon came to Portsmouth several years

ago as superintendent of the old Portsmouth Kittery & York electric road, serving through four successive changes in ownership, and has been instrumental in its development from a comparatively small road to its present system of over 100 miles of track, controlling the Portsmouth Dover & York Street Railway, which is a consolidation of the Berwick Elliot & York, Portsmouth Kittery & York and the Kittery & Elliot Street railways.

Mr. George W. Brine, who recently was elected vice-president and general manager of the Georgia Railway & Electric Company, Atlanta, Ga., has been connected with electric lighting and railway properties since 1890. He was born in Cambridge, Mass., on September 9, 1867. In 1890 he accepted a position as assistant bookkeeper for the southern district of the Edison General Electric Company, with headquarters at Atlanta, Ga. He retained this position until the consolidation of the Edison General Electric Company and the Thomson-Houston Electric Company into the General Electric Company, when he went to New York and later to Boston, in the employ of the new company. He returned to Atlanta in 1892 as auditor of the southern office of the General Electric Company, and on January 15, 1894, he resigned to become cashier of the Georgia Electric Light Company, later being elected secretary-treasurer and manager. In April, 1902, when all of the railway and lighting properties of Atlanta were consolidated Mr. Brine was elected vice-president, treasurer and manager of the electrical department of the Georgia Railway & Electric Company, into which the old companies were merged, which position he held until his recent election as vice-president and general manager. Mr. Brine is also president of the Atlanta Gas Light Company.

Mr. Harold U. Wallace has resigned as president of the Wallace-Coates Engineering Company, Chicago, Ill., to become general manager of the Chicago Lake Shore & South Bend

Railway, a new high-speed single-phase line that is now being completed between South Bend, Ind., and Kensington, Ill., at which point it connects with the Illinois Central Railroad. Mr. Wallace was born on November 15, 1872. He was educated at the Chicago Manual Training School and at Purdue University. He entered railway service in 1888 and from January 1, 1894, to March, 1905, was connected with the Illinois Central Railroad in various capacities in the engineering and transportation departments, from April, 1900, to September, 1902, as division superintendent, and from September, 1902, to

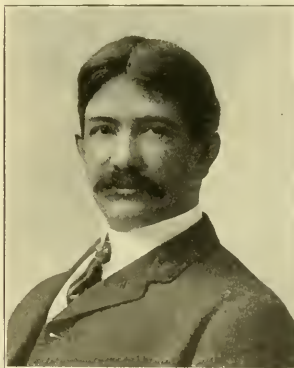

Harold U. Wallace.

March, 1905, as chief engineer. He then left the Illinois Central to engage in the contracting business and was connected with Thomas Phee & Co., railroad contractors, of Chicago, until July, 1905, when he was made third vice-president of J. G. White & Co. of New York. For the past two years he has been president of the Wallace-Coates Engineering Company. Mr. Wallace is a son of Mr. John F. Wallace, formerly chief engineer of the isthmian canal commission. He is a member of the American Railway Engineering and Maintenance of Way Association, the Engineers' Club of Chicago and the Engineers' Club of New York.

Mr. J. P. Clark, whose appointment as assistant to President M. W. Mills of the Michigan United Railways, Jackson, Mich., was announced in the Electric Railway Review of February 22, 1908, has been engaged in the construction and management of street and interurban railways for the past 18 years. His railway experience dates from 1890, when he was appointed manager of the West Side Street Railway of Kansas City, Kan. In 1895 he went to Tacoma, Wash., as general manager of the Tacoma Traction Company. During his connection with this company Mr. Clark had charge of the rebuilding of the property and electrifying the steam road operated at that time in connection with the traction company's line. He then became manager of the Seattle Traction Company, Seattle, Wash., and later, when all of the lines of that city were consolidated, Mr. Clark had charge of their reconstruction. He resigned from this position to become

general manager of Stone & Webster's Terre Haute Electric Company, with charge of the city and suburban lines and lighting plants. In January, 1903, he was transferred to the Dallas property of this company as general manager of the Dallas Electric Corporation. In October, 1903, he was appointed general manager of the Ft. Wayne & Wabash Valley Traction Company, resigning shortly after to superintend the construction of a branch line for the Indiana Union Traction Company from Marion to Huntington, Ind. After completing this work he was appointed chief engineer for the executive committee of the Bergen County Gas & Electric Company of New Jersey, in the construction and organization of this property. He later engaged as western manager and chief engineer for W. N. Coler & Co. of New York City. Since that time Mr. Clark has served as general manager of the Jackson Consolidated Traction Company and as general manager of the Detroit Ypsilanti Ann Arbor & Jackson Railway.

Mr. S. W. Huff, whose election as president of the Coney Island & Brooklyn Railroad, Brooklyn, N. Y., to succeed Mr. J. L. Heins, was announced in our issue of February 22, is a native of Virginia and a graduate of the electrical engineering department of Cornell University. He has been connected for a number of years with various electric railway companies throughout the east, south and west, his first work having been with the Union Railway Company of Richmond, Va. In 1891 he was appointed assistant superintendent of the Baxter Electric Motor & Manufacturing Company of Baltimore, Md., where he remained until his appointment as general manager of the street railway lines at Raleigh, N. C. Two years later he returned to Baltimore as general superintendent of the Baxter company and later was appointed electrical engineer of the Columbia & Maryland Railway Company, which was engaged in the construction of a line between Baltimore and Washington. Upon the consolidation of the railway lines in Baltimore Mr. Huff was appointed master mechanic of the United Railways & Electric Company, subsequently being promoted to electrical and mechanical engineer. He was afterward engineer and operating expert for the syndicate controlling the San Francisco street railways and later became general manager and acting president. In July, 1902, he was appointed general manager of the railway department of the Virginia Passenger & Power Company at Richmond, Va., in charge of its Richmond and Manchester lines and later was appointed general manager of the company, with entire charge of its railway lines, light and power departments, where he has since remained.



S. W. Huff.

## OBITUARY.

Thomas Carson Barr of Orange, N. J., for the past 20 years associated in the development of street railways in New Jersey, died at his home in Orange on February 26 from Bright's disease, aged 50 years. In 1889 Mr. Barr became interested in the street railways of Newark, N. J., having previously been president of the People's Passenger Railway, Philadelphia, Pa. With other capitalists he purchased all the Newark lines with the exception of the South Orange avenue line, incorporating them into the Newark Passenger Railway Company, which later was changed to the Consolidated Traction Company and still later to the North Jersey Street Railroad, of which the Public Service Corporation is the present owner. He was for a time associated with the Worcester, Mass., street railway properties, but returned to New Jersey, where he was elected president of the Elizabeth Plainfield & Central Jersey Railway. At the time of the organization of the Public Service Corporation Mr. Barr was made a director of the company.

S. F. Angus, who formerly was prominently identified with electric railway work, died at Detroit, Mich., last week. He was one of the promoters and chief owners of the Toledo Fremont & Norwalk Railroad, now a part of the Lake Shore Electric Railway, and the Detroit Ypsilanti Ann Arbor & Jackson Railway, now the Detroit Jackson & Chicago Railway.

## Financial News

**Chicago Railways Company.**—The Northern Trust Company, the Harris Trust & Savings bank and the Merchants' Loan & Trust Company of Chicago have offered for sale \$2,500,000 of first mortgage 5 per cent bonds at 93½ and interest. The earnings of the lines comprised in the system were as follows in 1907: Gross earnings, \$10,538,822.09; operating expenses, including taxes, \$7,654,419.13; net earnings, \$2,884,402.96. The capitalization comprises \$100,000 capital stock, upon which participation certificates are based; the \$5,000,000 first mortgage bonds which will be issued in 1908; and \$37,500,000 consolidated mortgage bonds. In a letter to the underwriters of the bonds now offered for sale Henry A. Blair, chairman of the board of directors of the railway, says: "The company owns and operates, without surface competition, 303 miles, single track, on the north and west sides of the city, and under the terms of the franchise these properties will be reconstructed, re-equipped and maintained in a manner which will give to the 1,550,000 people in the territory served by the company the finest service that money and the best engineering ability can secure. The territory served is densely populated and is constantly growing, thus permitting very profitable extensions to the company's present system. In view of the extensive improvements to be made immediately to the company's property and opportunities for future development, largely increased earnings are confidently expected." The trust agreement under which the participation certificates are issued provides for the control of the company by the following trustees: A. C. Bartlett, Charles H. Hulburd, Albert A. Sprague, Chauncey Keep and Charles G. Daves. During the life of the first mortgage bonds a "Finance" committee will have direct supervision of the finances of the company, vacancies in this committee to be filled only upon the written approval of the Harris Trust & Savings Bank, Chicago, trustee for the first mortgage bonds. The present personnel of the committee is as follows: Chauncey Keep, Henry A. Blair and B. A. Eckhart.

**Cleveland Southwestern & Columbus Railway, Cleveland.**—Gross earnings from operation in 1907 were \$756,898, an increase of \$111,048 over 1906. Operating expenses were \$440,035, an increase of \$76,178. Net earnings were \$316,863, an increase of \$34,870. Charges, etc., were \$205,455, an increase of \$26,203. The net income was \$111,408, an increase of \$8,667. The operating ratio in 1907 was 58.13 per cent, as compared with 56.33 per cent in 1906. Car-mile results compare as follows:

Per car-mile, cents—	1907.	1906.	Increase.
Gross earnings .....	25.43	24.25	1.08
Operating expenses .....	14.78	13.72	1.06
Net earnings .....	10.65	10.63	0.02
Deductions .....	6.91	6.76	0.15
Net income .....	3.74	3.87	*0.13

\*Decrease.

**Cleveland Electric Railway.**—Gross earnings in 1907 were \$5,731,056, as compared with \$5,882,589 in 1906 and \$5,303,086 in 1905. During more than four months of 1907 the company operated at an average fare of 3.6 cents, selling tickets at the rate of seven for 25 cents and issuing double transfers. These adverse conditions naturally affected the gross earnings.

**Coney Island & Brooklyn Railroad, Brooklyn.**—The New York public service commission, first district, has approved an issue of \$50,000 bonds to meet the cost of 10 new cars.

**Georgia Railway & Electric Company, Atlanta, Ga.**—Gross earnings from all sources in 1907 were \$3,309,341, as compared with \$2,894,924 in 1906. Net earnings were \$1,646,059 in 1907 and \$1,467,073 in 1906. Fixed charges were \$784,675, as compared with \$635,637. Dividends on the preferred stock aggregated \$120,000 in each year. Common stock dividends in 1907 amounted to \$428,448, as compared with \$390,949 in 1906. The surplus in 1907 was \$312,936, as compared with \$320,487.

**Interborough Rapid Transit Company, New York.**—The New York public service commission, first district, has approved the inclusion in the original cost of construction of approximately \$190,000 of 4 per cent city bonds to be used to settle damage claims arising at the time the Park avenue subway tunnel was changed to the east side of the street. The holders of the bonds are not to market them for at least six months.

**Lancaster & York Furnace Street Railway, Lancaster, Pa.**—This company has reduced its capital stock from \$280,000 to \$170,000, and has issued \$150,000 bonds.



# Manufactures and Supplies

## ROLLING STOCK.

**New York-Philadelphia Company, Philadelphia.**—Following the receivership of the subsidiary Camden & Trenton Railway of Camden, N. J., J. Kearney Rice was appointed receiver for the New York-Philadelphia Company by Judge Lanning of the United States circuit court at Trenton, N. J. Judge Lanning also appointed David F. Carver of Newark, N. J., receiver for two other subsidiary roads, the Trenton & New Brunswick Railroad and the New Jersey Short Line Railroad. The New York-Philadelphia Company was incorporated in New Jersey in 1904 and owned the entire capital stocks of the Trenton & New Brunswick and the New Jersey Short Line roads and a majority of the stock of the Camden & Trenton road. The latter leases the Trenton Terminal Railroad.

**Northampton (Mass.) Street Railway.**—The issue of \$175,000 additional capital stock at 110 per share has been approved by the Massachusetts railroad commission. The proceeds will be used to retire floating debt.

**Rochester (N. Y.) Railway.**—Gross earnings in the quarter ended December 31, 1907, were \$630,968, as compared with \$580,930 in the corresponding quarter of 1906. Expenses were \$569,713, as compared with \$410,932. Net earnings were \$60,355, as compared with \$169,998. Total income was \$62,851, against \$179,663. After provision for charges there was a deficit of \$43,252 in the 1907 quarter, as compared with a surplus of \$77,893 in the 1906 quarter.

**Twin City Rapid Transit Company, Minneapolis.**—This company has sold to William A. Read & Co. of New York \$1,000,000 of the joint 5 per cent consolidated bonds of the Minneapolis Street Railway and the St. Paul City Railway.

**United Traction Company, Albany, N. Y.**—Gross earnings in the quarter ended December 31, 1907, were \$496,938, as compared with \$472,974 in the corresponding quarter of 1906. Expenses were \$352,449, as compared with \$302,641. Net earnings were \$144,489, as compared with \$170,333. The final surplus after charges was \$76,343, against \$84,791.

**West End Street Railway, Boston.**—This company has sold \$700,000 of 4½ per cent 15-year bonds, dated January 1, 1908, to a syndicate composed of Parkinson & Burr, Blake Brothers & Co. and E. H. Rollins & Sons.

**West Penn Railways Company, Pittsburgh.**—Gross earnings in 1907 were \$1,603,100, an increase of \$193,607 over the previous year. Expenses were \$841,767, an increase of \$67,791. Net earnings were \$761,333, a gain of \$125,816. Charges amounted last year to \$416,734. The final surplus after the payment of dividends on the preferred stock amounted to \$207,099, an increase of \$87,404.

**Windsor Essex & Lake Shore Rapid Railway, Kingsville, Ont.**—Shareholders will vote on March 2 on an agreement for the sale of \$750,000 bonds, and the procuring of \$60,000 to complete the railway to Leamington.

## ELECTRIC RAILWAY EARNINGS.

### Montreal Street Railway.

January—	1908.	1907.
Total earnings .....	\$285,515.36	\$271,956.42
Operating expenses .....	202,503.94	189,497.60
Net earnings .....	83,011.42	82,458.82
Total charges .....	45,955.10	40,163.13
Surplus .....	37,056.52	42,293.69
Expenses—Per cent of earnings....	70.93	69.63

### Northern Ohio Traction & Light Company, Akron, O.

January—	1908.	1907.
Gross earnings .....	\$126,125.78	\$125,191.09
Operating expense .....	81,892.36	79,581.26
Net earnings .....	44,233.42	45,609.83
Fixed charges .....	42,501.88	41,339.46
Surplus for stock .....	1,731.54	4,270.37

### Dividends Declared.

Chicago City Railway, quarterly, 1½ per cent.  
Grand Rapids (Mich.) Railway, common, quarterly, 1 per cent.

Northern Texas Electric Company, Ft. Worth, Tex., preferred, 3 per cent.

Rochester (N. Y.) Railway & Light Company, preferred, quarterly, 1¼ per cent.

Terre Haute (Ind.) Traction & Light Company, preferred, 3 per cent.

Whatcom County Railway & Light Company, Bellingham, Wash., preferred, 3 per cent.

The Municipal Traction Company of Cleveland is rebuilding a car for the purpose of making an experiment with the pay-as-you-enter method of fare collection.

**San Antonio Traction Company, San Antonio, Tex.,** will buy 10 semi-convertible cars.

**Bowling Green Railway, Bowling Green, Ky.,** is in the market for two single-truck cars.

**Chicago & Southern Traction Company, Chicago,** will purchase two express cars and one sprinkler.

**Petaluma & Santa Rosa Railway, Petaluma, Cal.,** will buy 10 box cars and 5 flat cars within the next few weeks.

**Illinois Valley Railway, La Salle, Ill.,** has purchased three center aisle open cars from the Danville Car Company.

**New Bedford & Onset Street Railway, New Bedford, Mass.,** has bought an express car from J. M. Jones' Sons.

**Quincy Horse Railway & Carrying Company, Quincy, Ill.,** has ordered one center aisle open car from the Danville Car Company.

**Montgomery Traction Company, Montgomery, Ala.,** has ordered eight double-truck convertible cars from The J. G. Brill Company.

**Portland Railway Light & Power Company, Portland, Ore.,** is building a double-truck passenger car, 40 feet long over all, in its own shops.

**Galesburg Railway & Light Company, Galesburg, Ill.,** has placed an order with the Danville Car Company for six semi-convertible, semi-steel, double-truck cars.

**New Orleans Railway & Light Company, New Orleans, La.,** at a recent meeting of the board of directors, authorized the purchase of a number of cars.

**Winnebago Traction Company, Oshkosh, Wis.,** which was reported in the Electric Railway Review of February 8 to be in the market for new cars, will place an order for six.

**Frederick W. Whitridge,** receiver for the Dry Dock East Broadway & Battery Railroad and the Forty-second Street Manhattanville & St. Nicholas Avenue Railroad, was authorized on February 26 by Judge Lacombe of the United States circuit court to issue certificates to the amount of \$100,000 for the purchase of 25 new cars for the Dry Dock East Broadway & Battery Railroad; also to issue certificates to the amount of \$200,000 to pay for 50 new cars for the Forty-second Street Manhattanville & St. Nicholas Avenue Railroad.

**Illinois Central Electric Railway, Canton, Ill.,** as reported in the Electric Railway Review of February 1, has placed an order with the Danville Car Company for two semi-convertible cars. The contract was closed January 25 and delivery is to be made by April 1. The specifications include the following details:

Seating capacity .....	44 passengers	Height inside .....	7 ft. 6 in.
Weight .....	About 34,000 lb.	Sill to trolley base ..	9 ft. 2 in.
Wheel base .....	4 ft.	Height track to trolley base ..	7 ft. 6 in.
Length of body .....	30 ft.	.....	12 ft.
Over vestibule .....	41 ft.	.....	.....
Length over all .....	41 ft.	.....	.....
Width inside .....	7 ft. 3 in.	.....	.....
Over all .....	8 ft. 2 in.	.....	.....
Special Equipment.			
Curtain material ..	Pantasote	Motors .....	4 G.E.-80
Hand brakes ..	Peacock	Trucks .....	Brill
Headlights ..	Anderson-Smith		

## SHOPS AND BUILDINGS.

**Williamsport (Pa.) Passenger Railway.**—Ernest H. Davis, general manager, writes that this company proposed building a new car house, but has postponed the plan until business conditions improve.

**St. Louis Montezano & Southern Railway, St. Louis, Mo.**—This company is reported to have purchased property near the St. Louis city limits on which to erect a passenger station and car house. C. A. Gutke, president.

**Denver & Interurban Railroad, Denver, Colo.**—This road has been issued a building permit for a brick and stone car house on Market street, between Twenty-second and Twenty-third avenues, Denver. The cost is estimated at \$20,000.

## TRADE NOTES.

Arthur West, formerly chief engineer of the Westinghouse Machine Company, Pittsburg, severed his connection with that company on January 31.

Western Electric Company, Chicago, at a meeting of directors in Chicago on February 19, elected J. I. Waterbury of New York and W. H. Miner of Chicago directors to succeed H. A. Halligan and J. W. Johnston, resigned.

Sterling-Meaker Company of Newark, N. J., is shipping 60 Sterling brakes to Bangkok, Siam. The same firm is also furnishing the New York City Railway with 100 Sterling fenders this week and will supply them with 150 more in the near future.

Wisconsin Engine Company, Corliss, Wis., manufacturer of Corliss steam, gas and pumping engines and air and gas compressors, has opened a branch office in the Candler building, Atlanta, Ga. Julius M. Dashiell has been appointed sales manager.

Weber Gas Engine Company, Kansas City, Mo., is building two 150-horsepower 3-cylinder vertical gas engines, to be direct connected to two 100-kilowatt generators, for the Kansas City & Olathe Electric Railway. These engines will be operated by gas from the company's wells.

J. A. Fay & Egan Company, Cincinnati, O., at its annual meeting elected the following directors: T. P. Egan, S. P. Egan, Clifford Egan, Frank Egan, L. G. Robinson, Rudolph Kleybolte, A. A. Faber, Joseph Rawson and John E. Bruce. Mr. Faber, treasurer, succeeded W. H. Doane, who resigned as a director. All the old officers were re-elected.

Flexible Mesh Rail Bond Company, 114 Woodard street, Ypsilanti, Mich., has appointed J. L. Millsbaugh manager of the sales department, effective February 1. Mr. Millsbaugh was for a number of years associated with the operating department of the Detroit Ypsilanti Ann Arbor & Jackson Railway and has a large acquaintance among railway men.

Frank R. Coates, formerly chief engineer of the Chicago Great Western Railway and more recently a member of the firm of Wallace-Coates Engineering Company, has become associated with the Stone & Webster Engineering Corporation, constructing engineer of Boston, Mass., and will have charge of the contracting department. His headquarters will be at 147 Milk street, Boston.

Quincy-Manchester-Sargent Company was reported in last week's issue as having removed its general offices from 90 West street, New York, to Plainfield, N. J. This is an incorrect statement in that the company has merely located the headquarters of the machinery department at Plainfield, the sales department still remaining at 90 West street, New York. The headquarters for the track department and for the car and engine department are in the Old Colony building, Chicago.

Southern Railway Supply Company, 417 Walnut street, St. Louis, Mo., has been incorporated with a capital stock of \$5,000, fully paid. It has bought the good will and agencies of the H. F. Vogel Contracting & Railway Supply Company, and will conduct a railway supply business, paying particular attention to the electric railway field. Joseph A. Buse is president, Ered Kraushaar, vice-president, and J. F. Bartman, secretary and treasurer. Mr. Bartman was formerly manager of the H. F. Vogel Contracting & Railway Supply Company.

Chase-Shawmut Company, Newburyport, Mass., has placed upon the market the Shawmut rail bond protector, a device designed to protect both the soldered and plug type of bond from being sheared off by wagon wheels, damaged by paving stones or ballast, injured by track crews, and to discourage theft. This protector is made of heavy steel securely fastened to rail by means of bolts, which hold the fishplate in place thus making an application of the simplest nature. It is of such shape as to allow inspection of the bond without removal of the fishplates and can be applied to either new or old rails at a minimum cost without impeding traffic.

Allis-Chalmers Company, Milwaukee, Wis., has stocked and equipped two of the great machine shop units at the West Allis works, known as shops 5 and 6, for the building of large electrical machines, particularly those intended for direct connection to the various forms of prime movers which constitute a large part of the product of this company. Heretofore the large electric generators for driving by gas engine, steam turbine, water wheel or Corliss engine have been built exclusively at the company's works in Cincinnati, O. The construction of a part of these large machines in Milwaukee gives much needed room for the manufacture of motors, transformers and small generators at Cincinnati and does away

with the former necessity of shipping heavy engine shafts to the electrical works, to be fitted and keyed to the rotors of engine type generators. On the other hand, the West Allis works are better equipped, through large experience in the building of big equipments, to handle the heavy parts. To indicate the type of work which has already been turned out at West Allis, shipment was recently made of two 2,000-kilowatt 6,600-volt 25-cycle three-phase alternators, which were sent to the Homestead works of the Carnegie Steel Company. These alternators are for direct connection to 34 by 54 inch Allis-Chalmers twin tandem gas engines, also products of the West Allis works. A third alternator was recently shipped to the central furnaces of the American Steel & Wire Company. This machine was a 1,000-kilowatt 13,200-volt 25-cycle three-phase unit, designed for direct connection to a 34 by 42 inch Allis-Chalmers gas engine. These three generators were the first to be completed and shipped from the new shops, and others, including a 6,500-kilowatt unit, will follow in rapid succession during the next few weeks.

Dossert & Co., New York, announce that they have received what is probably the largest order for terminal lugs ever used on a single installation in this country. The material is for use in the wiring of the immense terminal buildings at Cortlandt, Church and Fulton streets, New York, of the Hudson & Manhattan Railway Company operating the tunnels under the Hudson river, which have just been opened to the public. These terminals are all of the Dossert solderless type, comprising front connection, back connection, angle and swivel lugs, and range in size from 2,000,000 circular-mils down to No. 4 cable. Part of the order comes from the Westinghouse Electric & Manufacturing Company of Pittsburg, Pa., and is for lugs to be used on their fuse blocks, inclosed type, 61 to 600 amperes. Approximately 1,000 Dossert solderless lugs are required for the switchboards and panel boards of these great twin buildings.

William V. Dee, who was recently elected secretary and general sales agent of the G. Drouvé Company, Bridgeport, Conn., was for 16 years connected with The Railway Age. He



William V. Dee.

He recently acquired an interest in the G. Drouvé Company on terms which opened up an alluring prospect for a young man, so that, while his old associates in The Railway Age office were sorry to see ties of many years' standing severed, they rejoice at Mr. Dee's good fortune and join with all his friends in congratulations and good wishes. Mr. Dee is in every sense of the term a self-made man. He began his creditable career with The Age as an office boy. He was unusually precocious and learned his duties and duties higher up rapidly. His promotion began the moment he began work. From the position of office boy he soon graduated into a clerkship; then he became a solicitor of subscriptions; from that it was but a step to soliciting advertising, and almost before we knew it "Colonel" Dee was assistant manager of the New York office under a wise and fatherly preceptor, F. S. Dinsmore. At an age when many boys are coddled and spoiled Dee bore the responsibilities of a man. He cared for and in large measure supported a widowed mother with several children younger than himself and through it all he was always cheerful, faithful, loyal and manly. He has earned by conscientious hard work and persistence a success that is more than praiseworthy for a man of 25 years of age, and those who know him best know that he has hardly started up the ladder of success.

## ADVERTISING LITERATURE.

Railway Specialty & Supply Company, Chicago, Ill.—Bulletin S-118, which supersedes S-147, is devoted to the arc lamp lightning arrester in its special application to signal apparatus.

H. W. Johns-Manville Company, 100 William Street, New York, N. Y.—A recently issued leaflet is devoted to asbestos

roll fire felt, which is especially recommended for use where insulation is required to resist very high temperatures.

**Western Electric Company, 259 South Clinton Street, Chicago, Ill.**—Bulletin No. 5352 is a neat and comprehensive publication showing a complete line of fan motors, practically all standard types of which are illustrated and described. The cover is both unique and handsome.

**Weber Gas Engine Company, Kansas City, Mo.**—Under the title of "Governors that Govern," a neat leaflet has been issued which answers the question, "Will a gas engine drive an electric generator and furnish steady light?" The ability of Weber gas engines to do this is graphically demonstrated by text and diagram.

**Allis-Chalmers Company, Milwaukee, Wis.**—Lighting transformers are described in Bulletin No. 1061.—A complete description of type K direct-current motors is contained in Bulletin No. 1057—information regarding compound engines, from the first and famous "Centennial" engine to present-day Reynolds-Corliss engines, is shown in Bulletin No. 1512.

**Sprague Electric Company, 527 West Thirty-fourth Street, New York, N. Y.**—Among recent publications are Bulletin No. 107, devoted to continuous-current direct-driven type S generators for lighting and power; Bulletin No. 224, describing type D direct-current motors; Bulletin No. 310 (superseding No. 301), exploiting direct-current motors for operating ventilating fans and blowers; Bulletin No. 507 (superseding No. 505), the subject of which is flexible steel-armored hose for steam or compressed air.

**Murray Iron Works Company, Burlington, Ia.**—An unusually handsome publication is Catalogue No. 60, recently issued. It is descriptive of Murray safety water tube boilers, the details of which are most carefully illustrated by a number of fine half-tones and line drawings. Ten of the large pages show buildings of widely varying kinds located in different cities and equipped with Murray boilers. The introduction calls attention to the fact that the company has been in its present location for the past 38 years.

**Universal Portland Cement Company, Chicago, Ill., and Pittsburg, Pa.**—A recent bulletin shows views of a number of important structures built wholly or in part of Universal Portland cement. The most prominent is Montgomery Ward & Co.'s new Chicago building, located at Chicago avenue and the river, said to be the largest reinforced concrete structure in the world. The building covers approximately  $3\frac{1}{4}$  acres, has eight stories and a basement, and 100,000 barrels of cement were used in its construction.

**General Electric Company, Schenectady, N. Y.**—Recently issued bulletins include No. 4544, the subject of which is continuous-current railway switchboards of the following types: Generator panels, including circuit-breakers and equalizer switch panels, rotary converter panels, feeder panels for one circuit, feeder panels for two circuits with one ammeter per panel, and feeder panels for two circuits with two ammeters per panel. The various forms of apparatus used in connection with the panels, details of construction, etc., are described and illustrated, and complete tables giving catalogue numbers, capacities, etc., and dimension sketches, are given.—Bulletin No. 4563 is devoted to an improved type of switch indicator known as the SI-104. It is neat in design, strong, weather-proof and insect-proof, and every possible precaution has been taken to insure reliable operation.—Bulletin No. 4558 describes a line of isolated plant switchboard panels with circuit-breakers. The panels provide for controlling 125-volt generators of from 5 to 120 kilowatt capacity, and 250-volt generators of from 10 to 240 kilowatt capacity, and are made for controlling from two to six feeder circuits.—Bulletin No. 4564 describes low-pressure air compressors rated from 0.88 to 4 pounds per square inch and from capacities of 750 to 10,000 cubic feet of free air per minute.

#### SHAWMUT AUXILIARY BOND.

As a means of increasing the efficiency of plug and pin bonds the Chase-Shawmut Company, Newburyport, Mass., presents the Shawmut "Auxiliary" bond—a copper cap with rail-engaging flange filled with solder, heated and applied to end of bond, and thus by giving additional contact surface reducing to a minimum the resistance at the rail joint. A recent test made with "Auxiliary" bonds applied on new plug bonds just installed showed that an improvement of over 15 per cent in conductivity resulted. With a bond 15 per cent better than a new plug bond available, having the advantage of a permanent metallic union, as contrasted with pressure contact alone, the Chase-Shawmut Company believes that railroads will appreciate this means toward cost reduction.

#### GABA SASH RETAINER AND ANTI-RATTLER.

The accompanying illustrations show the mechanism of an improved sash retainer for use on car windows, patented by M. H. Gaba, and manufactured by the Patterson Tool &

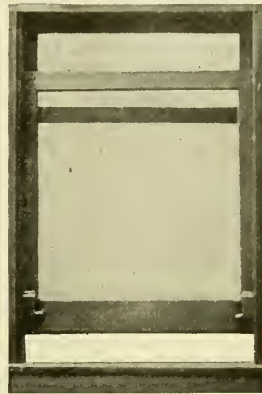

Window Partly Raised.

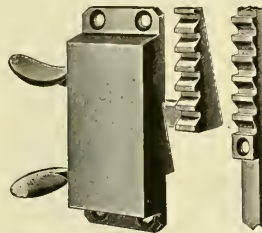

Lock and Lock Strip.

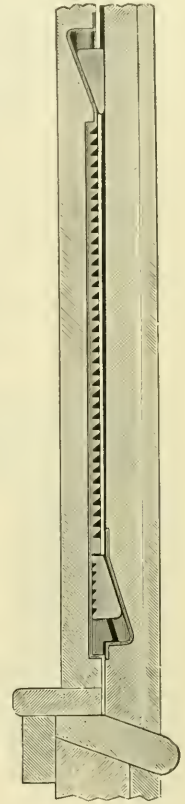

Gaba Sash Retainer.

Supply Company of Dayton, O. With this arrangement the ratchets are inclosed in the window casing and do not show in the interior of the car, and this absence of rough surfaces improves materially the appearance of the car and at the same time makes it easier to keep the window casings clean.

The principle of the device is apparent from the sectional view and the engraving showing the lock separately. Pressing the thumb piece of the lock draws downward the triangular toothed member of the lock, which is guided by the lock casing and moved out so it can clear the ratchet strip. The sash being raised and the lock released, the toothed block meshes with the rack and holds the sash in place.

The weight of the sash coming on the inclined surface of the toothed block, the latter acts as a wedge to hold the sash against the outer casing, making the joint tight and preventing rattling. At the top a triangular block, shown in the sectional view, serves the same purpose. When the sash is lowered the wedge of the lock, actuated by a spring, is pressed up and holds the sash against the outer casing.

This device can be applied to any car without changing sashes or strips.

**Arthur S. Partridge, 421 Olive Street, St. Louis, Mo.**—Schedule No. 18, issued under date of February 27, is an attractive showing of a large number of generators and other electric railway machinery, together with a list of interurban and city cars, all ready for immediate sale and delivery.

### NOVEL USE OF A SCREW PUMP BY NEW ORLEANS RAILWAY & LIGHT COMPANY.

The new Claiborne station of the New Orleans Railway & Light Company, New Orleans, La., which recently has been extended and rebuilt, has among its many interesting features one which relates to the condensing apparatus and the means taken to prevent the sediment from the Mississippi river from being drawn into the condenser intakes.

Four 72-inch pipes have been provided to serve the condenser intake and discharge. They are all extended through the levee, three being installed under the boiler room and one placed under the railway tracks between the boiler room and the levee. The pipes are made in 30-foot lengths of ½-inch riveted steel, protected by a coating  $\frac{1}{8}$  inch thick, applied by dipping the sections into a hot compound.

For the purpose of removing sand and silt from the water pipes water jets have been installed at 10-foot intervals in the bottom of the pipes, and by a system of valves the intake and discharge may be connected at the station end with an Allis-Chalmers motor-driven screw pump, so located as to secure a flow of from 8 to 10 feet per second through the pipes. When the cleaning is to be done the jets are first operated to loosen the deposit, which is then worked out by the flow from the pump. The pump is driven by means of a 700-horsepower 550-volt induction motor directly coupled to it. Messrs. Sanderson & Porter, engineers, New York City, were in charge of the design and construction of the power station.

### BLAKE SIGNALS WITH OIL LIGHTS.

In order to meet the requirements of single-phase electric roads and steam railroads the Blake Signal & Manufacturing Company has developed the type of signal shown in the accom-

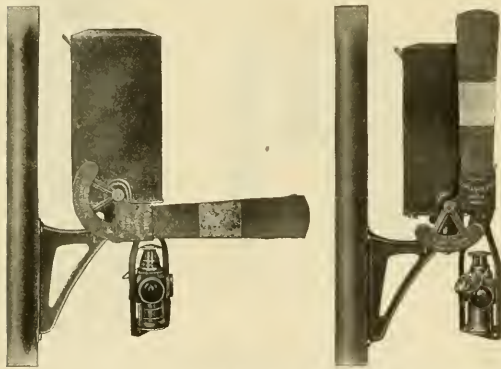

Blake Signals—Semaphore Blade and Lamp in Stop and Clear Positions.

panying engravings. These signals are similar in every detail to the well-known Blake dispatcher's signals for telephone train dispatching, now in use on many 500-volt interurban electric roads, except the signal light for use after dark. On 500-volt trolley lines the most effective as well as simplest and cheapest method of getting the light for night use is to connect the 500-volt trolley or feeder to an incandescent lamp circuit through a certain amount of resistance, said circuit being closed by a substantial knife blade switch when the semaphore is set in the horizontal position. With single-phase lines or steam railroads this comparatively low voltage electric current is not available at the line signal and it becomes necessary to devise some other means for getting the necessary signal light for night use.

This has been accomplished by supporting a standard 4-lens railway switch lamp on a substantial hanger, the shaft of which goes up through the base of the signal. The end of this shaft is so connected with the semaphore shaft that when the semaphore drops to the horizontal position the lamp shaft and lamp are given a quarter turn so that where the lamp shows a white or green light up and down the track when the semaphore is in the vertical or "clear" position, it will show a red light up and down the track when the semaphore is set to the horizontal or "stop" position.

The weight of the hanger and lamp is supported on a spiral so that not only does the weight of the lamp assist,

rather than retard, the dropping of the semaphore to the horizontal position, but should the rod or pin connecting the lamp shaft with the semaphore shaft be broken the lamp would of its own weight make a quarter turn and show a red light. This is on the side of safety and makes it impossible for the lamp to show anything but red when the semaphore is set at danger. As with all switch lamps, whether fork or socket type, it is impossible for a lamp to be put up showing the wrong light, that is, a light at variance with the position of the semaphore.

All of the working parts of this lamp hanger are under the signal cover, where they are thoroughly protected against the weather. It is this type of signal which has been furnished for the Annapolis branch of the Washington Baltimore & Annapolis Railroad, described and illustrated in the Electric Railway Review for February 15, 1908, page 200.

### ELECTRICALLY HEATED GLUE POTS.

The Westinghouse Electric & Manufacturing Company is putting on the market a line of improved electrically heated glue pots that represent the application of electricity in the



Electrically Heated Glue Pot for Bench Use.

simplest and most convenient form. The pots are made in 2-quart and 4-quart sizes, in both portable and bench types. There is nothing to get out of order or to require any more attention than is given the ordinary glue pot.

The pots themselves are of seamless drawn copper with brass bail and wiper rod. The water bath is made of seamless copper, and the heating element, which is wrapped around the lower portion, is inclosed in a water-tight tin envelope. The water bath is provided with a patent circulating device, which gives it the maximum heating efficiency. This device consists of a hollow ring, the lower end of which is closed by a diaphragm having a central opening. This confines the heating action to the thin film of water outside of the device, and sets up a rapid circulation in the water, which brings the glue up to the working temperature in a short time.

To further promote economical heating the pots are provided with heat regulating switches, by means of which the glue can rapidly be brought to the desired temperature, and then maintained there by a lower temperature of current.

A 4-quart, portable pot is one of the sizes made. The illustration shows a bench pot with the cover in place, giving an unobstructed working surface on the bench. The glue pot and water bath are hung underneath, so as to be out of the way. When the pot is in use the cover is hung on the hook underneath the table.

Electrically heated dry glue pots are made for those industries where the water bath glue pot is undesirable.

It is reported that the Boise & Interurban Railway, Boise, Idaho, has purchased a 22-acre tract of land to be equipped for an amusement park. The new tract is on the interurban line of the company adjoining Pierce park. W. E. Pierce, president, Boise, Idaho.



# The Moore Track Drill

does not interfere with traffic!

The shifting of one lever and a few seconds' time takes down the drill—the operation reversed makes it ready for work again.

This is only one of the many strong points about the Moore Track Drill that make it worth buying.

*Ask for descriptive catalogue.*



**Kalamazoo Railway Supply Co.** Kalamazoo Michigan

**T**HE MAIN FEATURE of this coupler is its great strength and simplicity. In fact, it makes a coupling joint that is as strong as, if not stronger than, the cars themselves. It will be noted that the head has heavy coupling faces, and, with the great width of the link and heavy reinforcing ribs on the outside of the head, lateral breakage due to curvature strains is impossible. The heavy lock and its bearing both at the top and bottom give the strongest kind of a locking device.

*Ask for new catalogue of traction devices.*

**Washburn Steel Castings & Coupler Co.**  
MINNEAPOLIS, MINN.

# Washburn "K" Type Traction Coupler



Western Agents:  
TWEEDY, HOOD & FINLEN, 204 Fisher Bldg., Chicago  
Canadian Agent: JOHN TAYLOR, Montreal

15

# Baltimore Center and Side Bearings

FOR ELECTRIC TRUCKS

**Impossible  
to Clog  
Balls**

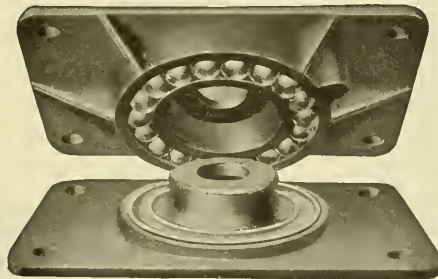

**No  
Lubrication  
Necessary**

**SAVES:** { FLANGE WEAR  
RAIL WEAR  
TRUCK REPAIRS

**DURABILITY:** { PROVEN  
UNDER  
HEAVIEST  
LOADS

BALTIMORE  
MD.

**THE T. H. SYMINGTON CO.**

CHICAGO  
ILL.

# THE J. G. BRILL COMPANY, PHILADELPHIA, PA.

AMERICAN CAR COMPANY, ST. LOUIS, MO.  
 G. C. KUHLMAN CAR COMPANY, CLEVELAND, OHIO  
 JOHN STEPHENSON COMPANY, ELIZABETH, N. J.  
 WASON MANUFACTURING CO. SPRINGFIELD, MASS.

MAIN OFFICE: PHILADELPHIA, PA.  
 LONDON OFFICE: 110 CANNON ST. E. C.  
 PACIFIC COAST AGENTS: PIERSON  
 ROEDING & CO., SAN FRANCISCO.  
 AUSTRALIAN AGENTS: NOYES  
 BROTHERS, SYDNEY. CABLES:  
 "BRILL," PHILA., "AXLES" LONDON.

*CARS TRUCKS SEATS RATTAN SPRINGS SPECIALTIES SUPPLIES*

## FOR HIGH EFFICIENCY

The centrifugal pump is used in fire engines because it is the simplest and most effective means of producing pressure. It is used in the Brill power sprinkler for the same reason. The centrifugal pump is operated by a direct-connected motor (both located on the platform at one end of the car) and supplies pressure for distributing the water uniformly over fifty feet of roadway on each side of the track. The pump shaft has the only wearing surface in the entire mechanism, so no trouble is caused by heated parts. The amount and direction of the water is always under perfect control by the patented type of sprinkling head employed. Write for catalog.

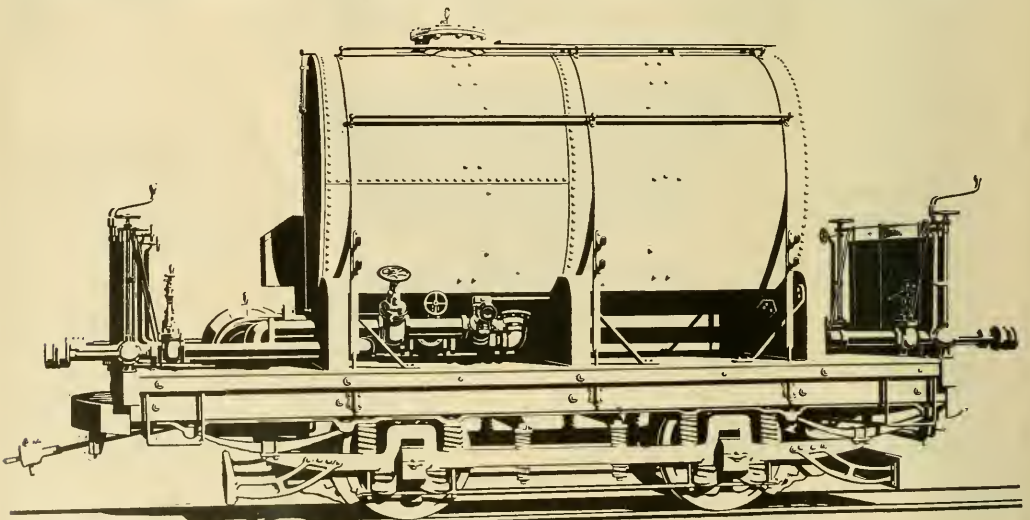

*THE BRILL CENTRIFUGAL SPRINKLER (PATENTED)*

# General Electric Company



## Commutating Pole Railway Motors



### Mechanical Design

The superior mechanical design of G. E. Commutating Pole Railway Motors provides the most rugged and easily maintained apparatus of this nature yet developed.



G. E. 205-100 h.p. Commutating Pole Railway Motor.

In the design of G. E. Railway Motors, special attention has been given to the subject of accessibility in regard to repairs and inspection. Conveniently placed hand-holes with gasketed covers permit easy access to commutator and brushes. In the smaller sizes the bottom part of frame swings down into pit for inspection or removal of parts. The armature in the large sizes is easily inserted or removed through the bored opening in the end of frame. All similar parts in different motors of any type are interchangeable. A readily accessible and easily handled motor means a saving of time in the repair shop.



**Quality of Equipment  
determines  
Quality of Service**



1583

**Chicago Office:**  
Monadnock Bldg.

**Principal Office:**  
**Schenectady, N. Y.**

**Sales Offices in  
all large cities**

# AMERICAN ELECTRICAL WORKS

PROVIDENCE, R. I.

## BARE AND INSULATED ELECTRIC WIRE

New York Office, 26 Cortlandt St. Chicago Office, 135 Adams St.  
MONTREAL BRANCH: Eugene F. Phillips Electrical Works, Limited.



Wherever absolute accuracy is demanded the best steel measuring tapes to use are those made by

**THE LUFKIN RULE CO.**

SAGINAW, MICH., U. S. A.

New York  
London, England  
Windsor, Canada

The Recording Fare Register Company



New Haven, Conn.

# THE NATIONAL LOCK WASHER CO., NEWARK, N. J.

Curtains - Curtain Fixtures - Sash Locks - Sash Balances - Nut Locks  
CHICAGO OFFICE: 419 MONADNOCK BLOCK

## It Pays

to buy this type of brake shoe—the kind approved by the A. S. & I. R. A. Standardization Committee.

We would like to give you figures based on facts that prove it! Write

### American Brake Shoe & Foundry Co.

New York Chicago Chattanooga MAHWAH, N. J.

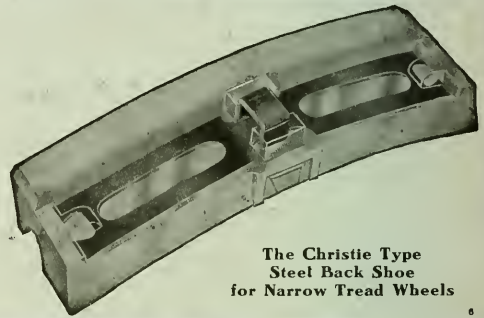

The Christie Type Steel Back Shoe for Narrow Tread Wheels



Factory of The Milloy Electric Company Bucyrus, Ohio

## The Milloy Trolley Base

built in our new and specially equipped factory, insures a quality which will give excellent service under ordinary and extraordinary conditions.

The Milloy Base is unusually low, has even tension on high or low wire. Has no fulcrum, no friction, no oil, no center post. Always efficient. Particulars on request.

**THE MILLOY ELECTRIC COMPANY**  
Bucyrus, Ohio

## Hydraulic Jacks

The different styles and sizes of Watson-Stillman Jacks number 400. No matter what your particular job may be, we have the hydraulic jack to handle it with greatest convenience, dispatch and economy.

No matter whether the load is lighter or heavy, we have the tool. Every Watson-Stillman tool is guaranteed.

Send for Jack Catalogue and you will see a sure way out of your Jack troubles.

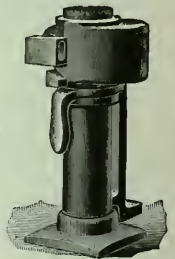

### THE WATSON-STILLMAN CO.

Main Office, 26 Cortlandt Street, New York City  
Branch Office, 453 The Rookery, Chicago, Ill.

# Drummond's Detective Agency

RAILWAY WORK A SPECIALTY

A. L. DRUMMOND, GENERAL MANAGER, EX-CHIEF U. S. SECRET SERVICE, NEW YORK.



# Electric Railway Review

PUBLISHED EVERY SATURDAY.

FORMERLY THE STREET RAILWAY REVIEW.

THE WILSON COMPANY, CHICAGO.

160 Harrison Street, Chicago  
150 Nassau Street, New York  
1529 Williamson Bldg., Cleveland

VOL. XIX  
No. 10

CHICAGO, MARCH 7, 1908

Whole No. 254  
Subscription: Domestic . . . \$2  
Foreign . . . \$5  
Canada . . . \$3.50

## History will repeat itself

*in the year or two following 1907,  
just as it did in the years after 1893*

Many concerns that thought they couldn't afford to advertise because business was slack will find that when brisk buying begins *they have been forgotten*. This was true after '93, and it surely will be true after '07, for the easiest thing in this big, busy world is to be forgotten after you have dropped out of sight!

Somehow it always happens that the fellows who get the bulk of the business after a period of depression are the very ones who would never admit that the country was headed straight to commercial disaster, but who kept right on oiling the business machinery and persistently advertising that they were ready to do business at any time.

Generally the concerns that do these sensible things are of comparatively small but well managed resources, officered by business men of brain and nerve. They are quick to grasp the unusual opportunity presented when old-established and widely known concerns voluntarily withdraw from the field in which they have established themselves only after long years of hard work.

In this repetition of history there is a lesson both for the old concern that has discontinued its advertising, or is thinking of doing so, and for the newer concern that is advertising in a small way or not at all—and that lesson is "*the time to advertise is all the time you want to do business!*"

And the way to advertise to keep in front in the electric railway supply business, now and all the time, is by telling the facts back of your goods sensibly, attractively and persistently in the

## Electric Railway Review

*Wouldn't it be better to stay in the band wagon at the head of the procession, rather than to mingle with the stragglers at the rear?*

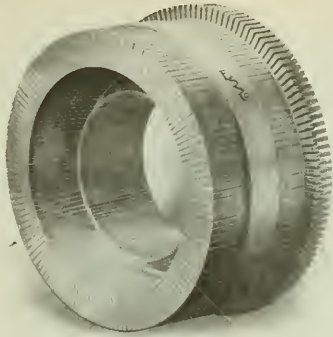

## BETTER QUALITY OF Assembled Commutator Segments

The segments are drawn to the exact edgewise taper and size of the finished segment, from pure hard drawn copper bars, dense and smooth. The bar thus formed is punched or sawn to the shape desired. These segments are exactly true in taper, have a uniform gauge and are as hard as it is possible to make them. This means highest possible conductivity and an absolutely uniform wearing surface. Only selected soft Canadian amber mica is used for insulation. This grade of mica wears down evenly with the copper. All mica is subjected to electrical tests before being assembled. We shall be pleased to quote prices on this high grade of Assembled Commutator Segments.

### ELECTRIC SERVICE SUPPLIES CO.

Railway Material & Electrical Supplies

MAYER & ENGLUND DEPT.  
PHILADELPHIA

GARTON-DANIELS DEPT.  
KEOKUK

PORTER & BERG DEPT.  
CHICAGO

NEW YORK

PITTSBURG

SAINT LOUIS

ATLANTA

## For Public Utility Corporations

### PREVENTION OF ACCIDENTS AND BREAKDOWNS

should be the first consideration in street railway power plants. Crane cast steel valves and fittings cost more, but they cannot be ruptured under any conditions met with in practice, and the extreme high temperatures of superheated steam do not affect them. Then, too, steel valves and fittings are cheaper in the long run, as they last indefinitely without repairs.

## CRANE STEEL VALVES

These valves have pure nickel seats and nickel-steel stems. As nickel has the same co-efficient of expansion as steel, seats cannot work loose. Nickel does not deteriorate under excessive temperatures, while bronze and other alloys fail at about 600° Fahrenheit. With proper usage the stems and seats should last as long as valve bodies.

All parts of our steel valves are made in our own works under the most rigid inspection and tests, which insure castings of uniform quality.

We solicit correspondence regarding  
steel valves and fittings.

**CRANE CO.**  
CHICAGO  
ESTABLISHED 1855

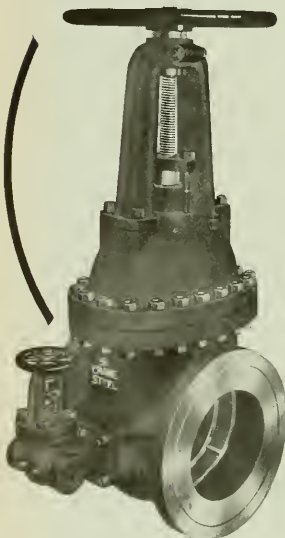

# Westinghouse

## Protective Apparatus

Static discharges are imminent in any season. Westinghouse Arresters will protect your apparatus in all seasons.

We illustrate the "Electrolytic," which has many distinctive features.

It can be used indoors or out.

It limits the voltage.

It has the lowest equivalent spark-gap.

It has no fine wire or carborundum rod resistances to burn out.

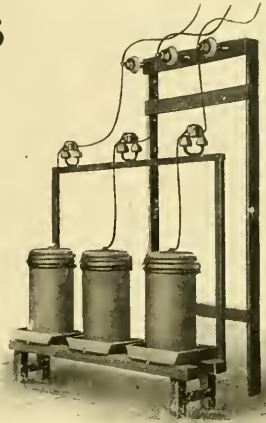

Our Circular 1146 contains a fully illustrated description of Electrolytic Arresters; get a copy from our nearest office.

## Westinghouse Electric & Mfg. Co.

Atlanta  
Baltimore  
Boston

Buffalo  
Chicago  
Cincinnati

Cleveland  
Dallas  
Denver

Detroit  
Kansas City  
Los Angeles  
Minneapolis

New Orleans  
New York  
Philadelphia

Pittsburg  
St. Louis  
Salt Lake City

San Francisco  
Seattle  
Syracuse

Canada: Canadian Westinghouse Co., Ltd., Hamilton, Ontario Mexico: G. & O. Braniff & Co., City of Mexico

## Automatic Pressure Gas Producers

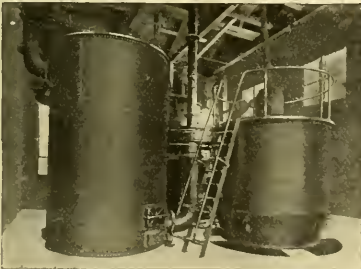

### A Comparison

The cost of handling the fuel for a Westinghouse Gas Producer Plant is much less, and the amount of fuel required but a fraction of that used for a steam plant of equal capacity. Furthermore there are no grates to burn out, and the fuel is fed and the ashes discharged by gravity alone.

You can read all about Westinghouse Gas Producers in Publication No. 707. Any one of our offices will mail you a copy.

**The Westinghouse Machine Co.**  
Pittsburg, Pa.



## A Flat Wheel

and the resulting evil effects upon a car and its equipment are usually due to poor braking facilities. There is no excuse for flat wheels on cars equipped with

### Westinghouse "AMM" Automatic Brakes

which enable any competent motorman to graduate the application and release of the brakes without danger of locking the wheels. The "AMM" equipment also possesses automatic quick-recharge, graduated-release, quick-service, high-pressure-in-emergency features, each having a peculiar value. Full particulars in Instruction Book T5031.

**Westinghouse Traction Brake Co.**  
Pittsburg, Pa.

ALPHABETICAL INDEX TO ADVERTISEMENTS.

Advance Lumber Co. ....23  
 Allis-Chalmers Co. ....22  
 Aluminum Co. of America. ....21  
 American Brake Shoe & Fdry. Co. ....13  
 American Electrical Works. ....13  
 American Frog & Switch Co. ....13  
 Anderson, Albert & J. M., Mfg. Co. ....19  
 Armstrong Company. ....22  
 Arnold Company. ....22  
 Atlas Anchor Co. ....18  
 Automatic Trolley Guard Co. ....17

Babcock & Wilcox Co. ....23  
 Baker, Wm. C., Heating & Supply Co. ....14  
 Baldwin Locomotive Works. ....18  
 Harbour-Stockwell Co. ....18  
 Barnes, G. H., Hardwood Lumber Co. ....23  
 Beidler, Francis, & Co. ....23  
 Bellamy Vestlette Mfg. Co. ....23  
 Berthold & Jennings. ....23  
 Blake Signal & Mfg. Co. ....23  
 Bliss, R., Mfg. Co. ....23  
 Bridgeport Brass Co. ....23  
 Brill, J. G., Co. ....26  
 Brown, Harold P. ....22  
 Brown Hoisting Machy. Co. ....22  
 Buckeye Engine Co. ....21  
 Burnham, Williams & Co. ....18  
 Bylesby, H. M., & Co. ....23

Central Inspection Bureau. ....23  
 Chase-Shawmut Co. ....19  
 Churchill Cedar Co. ....23  
 Cincinnati Car Co. ....23  
 Cleveland Armature Works. ....24  
 Cleveland Frog & Cross. Co. ....23  
 Collier, Barron G. ....23  
 Columbia Construction Co. ....18  
 Consolidated Car Pender Co. ....14  
 Consolidated Car-Heating Co. ....22  
 Contractors' Supply & Equipment Co. ....22  
 Cooper Heater Co. ....14  
 Crane Co. ....22  
 Craghead Engineering Co. ....23  
 Curtain Supply Co. ....19

Davis, John, Co. ....23  
 Dearborn Drug & Chemical Works. ....17  
 Dessert & Co. ....19

Drouvé, G. Co. ....13  
 Drummond Detective Agency. ....13

Eclipse Railway Supply Co. ....18  
 Electric Railway Equipment Co. ....13  
 Electric Ry. Improvement Co. ....28  
 Electric Service Supplies Co. ....2  
 Engineers and Contractors. ....22

Fairbanks, Morse & Co. ....18  
 Ford, Bacon & Davis. ....18

Galena-Signal Oil Co. ....17  
 General Electric Co. ....27  
 Green Engineering Co. ....27  
 Green Fuel Economizer Co. ....28  
 Griffin Wheel Co. ....22

Hagy, J. Milton, Waste Wks. ....12  
 Hale & Kilburn Mfg. Co. ....23  
 Hartshorn, Stewart, Co. ....23  
 Heine Safety Boiler Co. ....17  
 Hervey Bros. & Wakefield Co. ....23  
 Holman, D. F., Ry. Tracklayer Co. ....23  
 Hope Wheel Co. ....22  
 Humbird Lumber Co., Ltd. ....23

Indestructible Fibre Co. ....23

Jewett Car Co. ....14  
 Johann, F. A. ....21  
 Johns-Manville, H. W., Co. ....5  
 Joseph, Isaac, Iron Co. ....21

Kalamazoo Ry. Supply Co. ....25  
 Kinnear Manufacturing Co. ....23

Linsley Bros. Co. ....22  
 Lorain Steel Co. ....18  
 Lord & Burnham Co. ....21  
 Lufkin Rule Co. ....28  
 Lumen Bearing Co. ....22

Macallen Co. ....16  
 McGuire-Cummings Mfg. Co. ....23  
 Marshall, R. W., & Co. ....21  
 Massachusetts Chemical Co. ....12  
 Meyers, Fred J., Mfg. Co. ....23  
 Miller Anchor Co. ....23

Milloy Electric Co. ....16  
 Model Stoker Co. ....22  
 Morden Frog & Crossing Wks. ....22

National Brake & Electric Co. ....7  
 National Lock Washer Co. ....24  
 National Pole Co. ....23  
 Naugle Pole & Tie Co. ....23  
 New York Switch & Crossing Co. ....25  
 Niles Car & Mfg. Co. ....14  
 Northern Engineering Works. ....14  
 Nuttall, R. D., Co. ....23

Ohio Brass Co. ....5  
 Okonite Co., Ltd. ....24

Pacific Coast Pole Co. ....23  
 Pantasote Co. ....23  
 Patten, Paul B. ....23  
 Pay-As-You-Enter Car Co. ....9  
 Porter Mfg. Co. ....21  
 Power Specialty Co. ....21  
 Pressed Steel Car Co. ....23

Queen & Co. ....28

Rail Joint Co. ....20  
 Railway Specialty & Supply Co. ....23  
 Railway Steel-Spring Co. ....21  
 Recording Fare Register Co. ....22  
 Register, A. L., & Co. ....22  
 Reiter, G. C. ....22  
 Ridlon, Frank, Co. ....19  
 Roberts & Abbott Co. ....22  
 Robertson, Wm., & Co. ....19  
 Rodger Ball & Car Co. ....22  
 Rooke Automatic Register Co. ....15  
 Rossiter, MacGovern & Co. ....23  
 (Inc.) ....21  
 R-S-E. Russell Car & Snow-Plow Co. ....21

S-E. Missouri Cypress Co. ....23  
 St. Louis Car Co. ....22  
 St. Louis Car Wheel Co. ....22  
 St. Louis Surfacer & Paint Co. ....23  
 Sanderson & Porter. ....23  
 Saxton, E. ....23  
 Shlmer & Chase Co. ....23  
 Sheaff & Jastaad. ....23  
 Simmons, John, Co. ....18

Smith, Peter, Heater Co. ....22  
 Speer Carbon Co. ....22  
 Standard Brake Shoe Co. ....22  
 Standard Motor Truck Co. ....15  
 Standard Paint Co. ....23  
 Standard Steel Works. ....18  
 Standard Underground Cable Co. ....12  
 Star Brass Works. ....18  
 Stone & Webster Engineering Corporation. ....23  
 Ford, Bacon & Davis. ....18  
 Synnington, T. H., Co. ....25

Telegraph Signal Co. ....24  
 Trolley Supply Co. ....16

Under-Feed Stoker Co. ....18  
 U. S. Metal & Mfg. Co. ....23

Van Dorn & Dutton Co. ....22  
 Van Dorn, W. T., Co. ....18  
 Van Valkenburgh, E. C. ....23

Wanted and For Sale Cards. ....21

Washburn & Coupler Co. ....25  
 Watson-Stillman Co. ....16  
 Wendell & MacDuffie. ....23  
 Westinghouse Traction Brake Co. ....3  
 Westinghouse Elec. & Mfg. Co. ....3  
 Westinghouse Machine Co. ....3  
 Western Electric Co. ....3  
 Weston Electrical Instrument Co. ....28  
 Wheeler Condenser & Eng'g Co. ....23  
 Wheel Truing Brake Shoe Co. ....22  
 White, J. G., & Co. ....22  
 Whitmore Mfg. Co. ....19  
 Wilson, J. G., Mfg. Co. ....22  
 Wood, Guilford S. ....12  
 Woodman, B., Mfg. & Supply Co. ....23  
 Worcester, C. H., Co. ....23

Zelicker, Walter A., Supply Co. ....21

CLASSIFIED LIST OF ADVERTISERS.

Advertising Service.  
 Van Valkenburgh, E. C., 2117 West One Hundred and Second St., Chicago.

Advertising, Street Car.  
 Collier, Barron G., Flat Iron Bldg., New York.

Air Brakes—(See Brakes and Brake Parts).

Air Compressors—(See Compressors, Air).

Alloys and Bearing Metals.  
 Brown, H. P., 120 Liberty St., New York.  
 General Electric Co., Schenectady, N. Y.  
 Lumen Bearing Co., Buffalo, N. Y.  
 Ohio Brass Co., Mansfield, O.  
 Ridlon, Frank, Co., 200 Summer St., Boston.  
 St. Louis Car Co., St. Louis, Mo.

Aluminum Wire, Etc.  
 Aluminum Co. of America, Pittsburg.

Anchor.  
 Atlas Anchor Co., Cleveland, O.  
 Electric Service Supplies Co., 200 Plymouth Bldg., Chicago.  
 Miller Anchor Co., Norwalk, O.  
 Ohio Brass Co., Mansfield, O.

Armatures and Coils, Winding and Repairing.  
 Cleveland Armature Works, Cleveland, O.  
 Electric Service Supplies Co., 200 Plymouth Bldg., Chicago.  
 General Electric Co., Schenectady, N. Y.  
 Marshall, R. W., & Co., 95 Liberty St., New York.  
 Ridlon, Frank, Co., 200 Summer St., Boston.  
 Stuart-Howland Co., Boston.

Armature Lifts.  
 Electric Service Supplies Co., 200 Plymouth Bldg., Chicago.

Asbestos Materials.  
 Johns-Manville, H. W., Co., New York.

Axles—(See Wheels and Axles).

Babbitt Metals—(See Alloys and Bearing Metals).

Badges and Buttons.  
 Electric Service Supplies Co., 200 Plymouth Bldg., Chicago.  
 Recording Fare Register Co., New Haven, Conn.

Ballast Cars—(See Cars, Ballast).

Ball Bearings.  
 Symington, T. H., Co., Baltimore, Md.

Bases—(See Trolley Poles and Fittings).

Bearings.  
 Electric Service Supplies Co., 200 Plymouth Bldg., Chicago.  
 General Electric Co., Schenectady, N. Y.  
 Lumen Bearing Co., Buffalo, N. Y.  
 McGuire-Cummings Mfg. Co., Chicago.  
 Marshall, R. W., & Co., 95 Liberty St., New York.  
 Nuttall, R. D., Co., Pittsburg, Ohio  
 Ohio Brass Co., Mansfield, O.  
 Ridlon, Frank, Co., 200 Summer St., Boston.  
 Symington, T. H., Co., Baltimore, Md.  
 Van Dorn & Dutton Co., Cleveland, O.

Bells and Gongs.  
 American Car Co., St. Louis.  
 Brill, The J. G., Co., Philadelphia.  
 Electric Service Supplies Co., 1929-24 Phila. St., Phila.  
 Kuhlman, The G. C., Car Co., Cleveland.

Bells and Gongs—Continued.  
 McGuire-Cummings Mfg. Co., Chicago.  
 Ohio Brass Co., Mansfield, O.  
 Reiter, G. C., Canton, O.  
 St. Louis Car Co., St. Louis, Mo.  
 Stephenson, John, Co., Elizabeth, N. J.  
 Wason Mfg. Co., Springfield, Mass.  
 Western Electric Co., Chicago.

Block System—(See Signals).

Blowers—(See Mechanical Draft).

Blue Printing Machines.  
 Buckeye Engine Co., Salem, O.

Boilers.  
 Babcock & Wilcox Co., N. Y.  
 Fairbanks, Morse & Co., Chicago.  
 Green Fuel Economizer Co., Mattawan, N. Y.  
 Heine Safety Boiler Co., 421 Olive St., St. Louis.  
 Lord & Burnham, Irvington-on-Hudson, New York.  
 Rossiter, MacGovern & Co., 17 Battery Pl., New York.

Boiler Cleaning Compound.  
 Dearborn Drug & Chemical Works, Chicago.  
 Johns-Manville, H. W., Co., New York.

Bonds, Rail.  
 Brown, H. P., 120 Liberty St., New York.  
 Chase-Shawmut Co., Newburyport, Mass.  
 Electric Railway Improvement Co., Cleveland, O.  
 Electric Service Supplies Co., 200 Plymouth Bldg., Chicago.  
 General Electric Co., Schenectady, N. Y.  
 Johns-Manville, H. W., Co., New York.  
 Ohio Brass Co., Mansfield, O.

Brackets and Cross Arms.  
 Anderson, Albert & J. M., Mfg. Co., Boston.  
 Craghead Engineering Co., Cincinnati, O.  
 Electric Railway Equipment Co., Cincinnati, O.  
 Electric Service Supplies Co., 200 Plymouth Bldg., Chicago.  
 Johns-Manville, H. W., Co., New York, N. Y.  
 Linsley Bros. Co., Spokane, Wash.  
 Ohio Brass Co., Mansfield, O.  
 Ridlon, Frank, Co., 200 Summer St., Boston.  
 Stuart-Howland Co., Boston.  
 Western Electric Co., Chicago.

Brakes and Brake Parts.  
 Allis-Chalmers Co., Milwaukee, Wis.  
 American Car Co., St. Louis.  
 Brill, The J. G., Co., Philadelphia.  
 Electric Service Supplies Co., 200 Plymouth Bldg., Chicago.  
 General Electric Co., Schenectady, N. Y.  
 Kuhlman, The G. C., Car Co., Cleveland.  
 McGuire-Cummings Mfg. Co., Chicago.  
 National Brake & Electric Co., Milwaukee.  
 Stephenson, John, Co., Elizabeth, N. J.  
 Wason Mfg. Co., Springfield, Mass.  
 Westinghouse Traction Brake Co., Pittsburg, Pa.

Brakeshoes.  
 American Brake Shoe & Fdry. Co., Mahwah, N. J.  
 American Car Co., St. Louis.  
 Harbour-Stockwell Co., Cambridgeport, Mass.  
 Brill, The J. G., Co., Philadelphia.  
 Kuhlman, The G. C., Car Co., Cleveland.  
 McGuire-Cummings Mfg. Co., Chicago.



W. E.  
**D. C. GENERATORS**

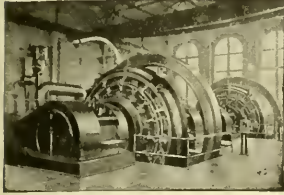

have the highest average or all-day efficiency

One of the reasons is because we use laminated cast-in pole pieces.

There are many other good reasons that our Bulletin No. 5112-C will tell you all about. Write today.

PROMPT DELIVERIES

**The First Cost of a Roofing is a Secondary Consideration**



A cheap roofing is the dearest in a long run.

If it requires painting or coating every year or two, it will cost

more in the end than the highest priced roofing.

**J-M ASBESTOS ROOFING**

is low in first cost and requires no painting or coating, therefore is the "cheapest-per-year" roofing. It is not affected by acids, chemical fumes, gases, salt air, heat or cold. Being made of Asbestos, an indestructible mineral, it is also a perfect fire resistant.

Write nearest branch for sample and catalogue 302.

**H. W. JOHNS-MANVILLE CO.**

Manufacturers of Asbestos and Magnesia Products, Asbestos Roofings, Packings, Electrical Supplies, Etc.



- |              |             |               |
|--------------|-------------|---------------|
| NEW YORK     | PITTSBURG   | MINNEAPOLIS   |
| MILWAUKEE    | CLEVELAND   | SAN FRANCISCO |
| CHICAGO      | BUFFALO     | LOS ANGELES   |
| BOSTON       | BALTIMORE   | SEATTLE       |
| PHILADELPHIA | NEW ORLEANS | DALLAS        |
| ST. LOUIS    | KANSAS CITY | LONDON 701    |

Send for catalogue No. 7, which describes "All Wire" bonds and bonding tools, pages 173 to 228.

**Strong at the Shoulder and Crimp**

A FEATURE THAT ADDS TO THE LIFE OF

**"All Wire" Rail Bonds**

¶ Note that the body of the bond is of stranded copper cable. Each individual strand is spiral in form and follows *an easy curve* even at points where the bond is sharply crimped. Each strand is therefore free to move in any direction, and *stresses* due to vibration or expansion and contraction are *evenly distributed throughout the bond*. ¶ The bond terminal being formed directly from the body portion, the shoulder is not weakened by burning of the strands due to soldering or welding on a terminal.

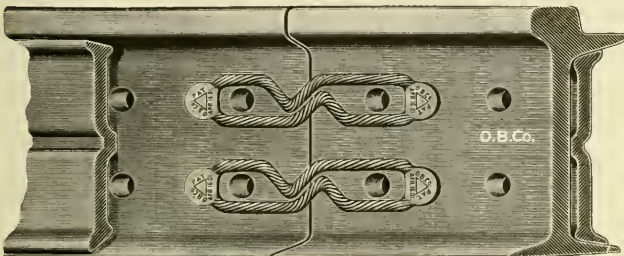

Rail double bonded under fishplate with type F, Form 3 "All Wire" Compressed Terminal Bonds.

**The Ohio Brass Co.**  
Mansfield, Ohio

NEW YORK: 43-49 Exchange Place  
CHICAGO: 321 Dearborn Street  
ST. LOUIS: 10 North Fourth Street  
Burt Gellatly, 336 Fourth Ave., Pittsburgh  
Pierson, Roeding & Co., San Francisco, Los Angeles, Seattle.

## CLASSIFIED LIST OF ADVERTISERS—Continued.

- Brakeshoes—Continued.**  
 Marshall, R. W., & Co., 95 Liberty St., New York.  
 St. Louis Car Co., St. Louis, Mo.  
 Standard Brake Shoe Co., Aurora, Ill.  
 Stephenson, John, Co., Elizabeth, N. J.  
 Wason Mfg. Co., Springfield, Mass.  
 Wharton, Wm., Jr., & Co., Philadelphia.  
 Wheel Truing Brake Shoe Co., Detroit.
- Bridges.**  
 Johann, F. A., 1624 Pierce Bldg., St. Louis.
- Bridge Timbers.**  
 Beldier, Francis, & Co., Chgo.
- Brushes, Motor and Dynamo.**  
 Electric Service Supplies Co., 200 Plymouth Bldg., Chicago.  
 General Electric Co., Schenectady, N. Y.  
 Ridlon, Frank, Co., 200 Summer St., Boston.  
 Speer Carbon Co., St. Marys, Pa.
- Bumpers, Car.**  
 American Car Co., St. Louis.  
 Brill, The J. G., Co., Philadelphia.  
 Kuhlman, The G. C., Car Co., Cleveland.  
 St. Louis Car Co., St. Louis, Mo.  
 Stephenson, John, Co., Elizabeth, N. J.  
 Wason Mfg. Co., Springfield, Mass.
- Car House Doors.**  
 Kinnear Mfg. Co., Columbus, O.  
 Wilson, J. G., Mfg. Co., New York.
- Car Replacers.**  
 Electric Service Supplies Co., 200 Plymouth Bldg., Chicago.  
 Fairbanks, Morse & Co., Chgo.  
 Kalamazoo Railway Supply Co., Kalamazoo, Mich.  
 Ohio Brass Co., Mansfield, O.  
 U. S. Metal & Mfg. Co., 25 Broad St., New York.
- Car Roof Paint, Canvas.**  
 St. Louis Surfacer & Paint Co., St. Louis, Mo.
- Car Seats.**  
 American Car Co., St. Louis.  
 Brill, The J. G., Co., Philadelphia.  
 Hale & Kilburn Mfg. Co., Philadelphia.  
 Heywood Bros. & Wakefield Co., Wakefield, Mass.  
 Kuhlman, The G. C., Car Co., Cleveland.  
 St. Louis Car Co., St. Louis, Mo.  
 Stephenson, John, Co., Elizabeth, N. J.  
 Wason Mfg. Co., Springfield, Mass.
- Car Signs—(See Signs, Cars and Track).**
- Car Steps.**  
 Electric Service Supplies Co., 200 Plymouth Bldg., Chicago.
- Car Trimmings—(See Trimmings, Car).**
- Cars, Ballast.**  
 Rodger Ballast Car Co., Chgo.  
 St. Louis Car Co., St. Louis, Mo.
- Cars, Dump.**  
 Fairbanks, Morse & Co., Chgo.  
 Rodger Ballast Car Co., Chgo.  
 Russell Car & Snow-Plow Co., Ridgway, Pa.  
 St. Louis Car Co., St. Louis, Mo.
- Cars, Passenger and Freight.**  
 American Car Co., St. Louis.  
 Brill, The J. G., Co., Philadelphia.  
 Cincinnati Car Co., Cincinnati.  
 Detroit Carbuilding & Equipment Co., Detroit, Mich.  
 Electric Railway Improvement Co., Cleveland, O.  
 Fairbanks, Morse & Co., Chgo.  
 Jewett Car Co., Newark, O.  
 Johann, F. A., 1624 Pierce Bldg., St. Louis.  
 Kuhlman, The G. C., Car Co., Cleveland.  
 McGuire-Cummings Mfg. Co., Chicago.  
 Niles Car & Mfg. Co., Niles, O.
- Cars, Passenger and Freight—Continued.**  
 Pressed Steel Car Co., Pittsburg.  
 Rodger Ballast Car Co., Chgo.  
 Russell Car & Snow-Plow Co., Ridgway, Pa.  
 St. Louis Car Co., St. Louis, Mo.  
 Standard Motor Truck Co., Pittsburgh.  
 Stephenson, John, Co., Elizabeth, N. J.  
 Wason Mfg. Co., Springfield, Mass.
- Cars, Pay-As-You-Enter.**  
 Pay-As-You-Enter Car Co., 26 Cortland St., New York.
- Cars, Rebuilt.**  
 Detroit Carbuilding & Equipment Co., Detroit, Mich.
- Cars, Second-Hand.**  
 Detroit Carbuilding & Equipment Co., Detroit, Mich.  
 Joseph, Isaac, Iron Co., Chicago, Ill.  
 Marshall, R. W., & Co., 95 Liberty St., New York.  
 Zelnicker, Walter A., Supply Co., St. Louis.
- Cars, Steel.**  
 Pressed Steel Car Co., Pittsburg.  
 St. Louis Car Co., St. Louis, Mo.  
 Standard Motor Truck Co., Pittsburgh.
- Castings, Brass.**  
 Star Brass Works, Kalamazoo, Mich.
- Castings, Iron and Steel.**  
 American Brake Shoe & Foundry Co., Mahwah, N. J.  
 Green Engineering Co., Com'l Nat. Bk. Bldg., Chicago.  
 Lorain Steel Co., Johnstown, Pa.  
 National Brake & Electric Co., Milwaukee.  
 Washburn Steel Castings & Coupler Co., Minneapolis.
- Catchers—(See Trolley Retrievers and Catchers).**
- Cattle Guards.**  
 Fairbanks, Morse & Co., Chgo.
- Cements, Cable and Transformer.**  
 Massachusetts Chemical Co., Walpole, Mass.
- Circuit-Breakers.**  
 Electric Service Supplies Co., 200 Plymouth Bldg., Chicago.  
 General Electric Co., Schenectady, N. Y.  
 Western Electric Co., Chicago.
- Coal Handling Machinery—(See Conveyors).**
- Coils—(See Armatures and Coils)**
- Commutators and Parts.**  
 Cleveland Armature Works, Cleveland.  
 Electric Service Supplies Co., 1020-24 Filbert St., Phila.  
 General Electric Co., Schenectady, N. Y.  
 Marshall, R. W., & Co., 95 Liberty St., New York.  
 Ohio Brass Co., Mansfield, O.  
 Stuart-Howland Co., Boston.
- Compressors, Air.**  
 Fairbanks, Morse & Co., Chgo.  
 General Electric Co., Schenectady, N. Y.  
 National Brake & Electric Co., Milwaukee.  
 Westinghouse Traction Brake Co., Pittsburg.
- Concrete Mixers.**  
 Contractors' Supply & Equip. Co., Chicago.
- Condensers.**  
 Wheeler Con. & Eng. Co., New York.
- Conduits.**  
 Electric Service Supplies Co., 200 Plymouth Bldg., Chicago.  
 Western Electric Co., Chicago.
- Connectors, Solderless.**  
 Dossert & Co., 242 W. Forty-first St., New York.
- Contractors.**  
 Arnold Company, 181 La Salle St., Chicago.  
 Blythe, H. M., Co., Am. Trust Bldg., Chicago.  
 Columbia Construction Co., Milwaukee, Wis.  
 Craghead Engineering Co., Cincinnati, O.
- Contractors—Continued.**  
 Green Engineering Co., Com'l Nat. Bk. Bldg., Chicago.  
 Register & Co., 112 N. Broad St., Philadelphia.  
 Sanderson & Porter, 52 William St., New York.  
 Saxton, E. G., 841 Eldensburg R., Washington, D. C.  
 Sheaff & Jaastad, 83 Broad St., Boston.  
 Storer Webster Engineering Corp., Boston.  
 Wharton, Wm., Jr., & Co., Philadelphia.  
 White, J. G., & Co., 49 Exchange Pl., New York.
- Controllers and Attachments.**  
 Electric Service Supplies Co., 200 Plymouth Bldg., Chicago.  
 General Electric Co., Schenectady, N. Y.  
 Johns-Manville, H. W., Co., New York.  
 Marshall, R. W., & Co., 95 Liberty St., New York.  
 Westinghouse Electric & Mfg. Co., Pittsburg.
- Conveyors and Coal Handling Machinery.**  
 Green Engineering Co., Com'l Nat. Bk. Bldg., Chicago.  
 Northern Engineering Works, Detroit, Mich.
- Cord, Bell and Trolley.**  
 American Car Co., St. Louis.  
 Brill, The J. G., Co., Philadelphia.  
 Electric Service Supplies Co., 1020-24 Filbert St., Phila.  
 Kuhlman, The G. C., Car Co., Cleveland.  
 St. Louis Car Co., St. Louis, Mo.  
 Stephenson, John, Co., Elizabeth, N. J.  
 Stuart-Howland Co., Boston.  
 Wason Mfg. Co., Springfield, Mass.
- Couplers, Car.**  
 American Car Co., St. Louis.  
 Brill, The J. G., Co., Philadelphia.  
 Kuhlman, The G. C., Car Co., Cleveland.  
 McGuire-Cummings Mfg. Co., Chicago.  
 Ohio Brass Co., Mansfield, O.  
 St. Louis Car Co., St. Louis, Mo.  
 Stephenson, John, Co., Elizabeth, N. J.  
 Van Dorn, W. T., Co., Painesville, Ohio.  
 Washburn Steel Castings & Coupler Co., Minneapolis.  
 Wason Mfg. Co., Springfield, Mass.
- Coverings, Pipe and Boiler.**  
 Johns-Manville, H. W., Co., New York.
- Cranes, Hoists and Lifts.**  
 American Car Co., St. Louis.  
 Brill, The J. G., Co., Philadelphia.  
 Brown, H. P., 120 Liberty St., New York.  
 Electric Service Supplies Co., 200 Plymouth Bldg., Chicago.  
 Fairbanks, Morse & Co., Chgo.  
 Kalamazoo Railway Supply Co., Kalamazoo, Mich.  
 Marshall, R. W., & Co., 95 Liberty St., New York.  
 Ridlon, Frank, Co., 200 Summer St., Boston.
- Drying Appliances.**  
 Green Fuel Economizer Co., Matteawan, N. Y.
- Dynamos and Generators.**  
 Cleveland Armature Works, Cleveland, O.  
 Fairbanks, Morse & Co., Chgo.  
 General Electric Co., Schenectady, N. Y.  
 National Brake & Electric Co., Milwaukee, Wis.  
 Rossiter, MacGovern & Co., 17 Battery Pl., New York.  
 Western Electric Co., Chicago.  
 Westinghouse Electric & Mfg. Co., Pittsburg, Pa.
- Economizers, Fuel.**  
 Green Fuel Economizer Co., Matteawan, N. Y.
- Electric Instruments.**  
 Electric Service Supplies Co., 200 Plymouth Bldg., Chicago.  
 General Electric Co., Schenectady, N. Y.  
 Johns-Manville, H. W., Co., New York.  
 Queen & Co., Philadelphia.  
 Western Electric Co., Chicago.  
 Westinghouse Electric & Mfg. Co., Pittsburg, Pa.  
 Weston Electrical Instrument Co., Newark, N. J.
- Electric Railway Supplies, General.**  
 Cleveland Armature Works, Cleveland, O.  
 Craghead Engineering Co., Cincinnati, O.  
 Electric Service Supplies Co., 200 Plymouth Bldg., Chicago.  
 Fairbanks, Morse & Co., Chgo.  
 General Electric Co., Schenectady, N. Y.  
 Johns-Manville, H. W., Co., New York.  
 Marshall, R. W., & Co., 95 Liberty St., New York.  
 Ohio Brass Co., Mansfield, O.  
 Stuart-Howland Co., Boston.  
 Western Electric Co., Chicago.
- Curtains, Fixtures and Materials—Continued.**  
 St. Louis Car Co., St. Louis, Mo.  
 Stephenson, John, Co., Elizabeth, N. J.  
 Wason Mfg. Co., Springfield, Mass.
- Cylinder Oil.**  
 Power Specialty Co., 111 Broadway, N. Y.
- Derailing Devices.**  
 American Frog & Switch Co., Hinton, Mo.  
 Cleveland Frog & Crossing Co., Cleveland, O.
- Detective Agency.**  
 Drummond Detective Agency, New York.
- Diaphragms.**  
 Wood, G. S., Great Northern Bldg., Chicago.
- Doors and Fixtures.**  
 American Car Co., St. Louis.  
 Brill, The J. G., Co., Philadelphia.  
 Kuhlman, The G. C., Car Co., Cleveland.  
 St. Louis Car Co., St. Louis, Mo.  
 Stephenson, John, Co., Elizabeth, N. J.  
 Wason Mfg. Co., Springfield, Mass.
- Doors, Steel Rolling.**  
 Kinnear Manufacturing Co., Columbus, O.  
 Wilson, J. G., Mfg. Co., New York.
- Draft, Mechanical—(See Mechanical Draft).**
- Draft Rigging.**  
 Van Dorn, W. T., Co., Chgo.  
 Washburn Steel Castings & Coupler Co., Minneapolis.
- Drills, Track.**  
 Brown, H. P., 120 Liberty St., New York.  
 Electric Service Supplies Co., 200 Plymouth Bldg., Chicago.  
 Fairbanks, Morse & Co., Chgo.  
 Kalamazoo Railway Supply Co., Kalamazoo, Mich.  
 Marshall, R. W., & Co., 95 Liberty St., New York.  
 Ridlon, Frank, Co., 200 Summer St., Boston.
- Drying Appliances.**  
 Green Fuel Economizer Co., Matteawan, N. Y.
- Dynamos and Generators.**  
 Cleveland Armature Works, Cleveland, O.  
 Fairbanks, Morse & Co., Chgo.  
 General Electric Co., Schenectady, N. Y.  
 National Brake & Electric Co., Milwaukee, Wis.  
 Rossiter, MacGovern & Co., 17 Battery Pl., New York.  
 Western Electric Co., Chicago.  
 Westinghouse Electric & Mfg. Co., Pittsburg, Pa.
- Economizers, Fuel.**  
 Green Fuel Economizer Co., Matteawan, N. Y.
- Electric Instruments.**  
 Electric Service Supplies Co., 200 Plymouth Bldg., Chicago.  
 General Electric Co., Schenectady, N. Y.  
 Johns-Manville, H. W., Co., New York.  
 Queen & Co., Philadelphia.  
 Western Electric Co., Chicago.  
 Westinghouse Electric & Mfg. Co., Pittsburg, Pa.  
 Weston Electrical Instrument Co., Newark, N. J.
- Electric Railway Supplies, General.**  
 Cleveland Armature Works, Cleveland, O.  
 Craghead Engineering Co., Cincinnati, O.  
 Electric Service Supplies Co., 200 Plymouth Bldg., Chicago.  
 Fairbanks, Morse & Co., Chgo.  
 General Electric Co., Schenectady, N. Y.  
 Johns-Manville, H. W., Co., New York.  
 Marshall, R. W., & Co., 95 Liberty St., New York.  
 Ohio Brass Co., Mansfield, O.  
 Stuart-Howland Co., Boston.  
 Western Electric Co., Chicago.

# National Air Brakes

Type "N"

## Oil Pneumatic Governors



Type "N" Governor Entirely Dissected.

The Type "N" Governor is a pneumatic governor without complicated levers or magnetic blowout system and has no delicate parts in its construction. The fewness and simplicity of its parts are illustrated above. When assembled there are no parts hidden from view and removal of the cover gives access to every part for inspection or repairs. All working parts are entirely immersed in oil, preventing rust and corrosion and insuring long life.

Write for descriptive Bulletin 375.

**National Brake & Electric Co.**  
Milwaukee, U. S. A.

NEW YORK: 111 Broadway

PHILADELPHIA:

W. H. Goble, 1722 Westmoreland St.

General Sales Office

519 First National Bank Building

CHICAGO

BOSTON: F. E. Huntress, 131 State Street

SAN FRANCISCO, CAL.:

W. F. McKenny, 69-71 First Street

LONDON: 14 Great Smith St., Westminster

## CLASSIFIED LIST OF ADVERTISERS—Continued.

- Enamels.**  
Acme White Lead & Color Works, Detroit, Mich.  
St. Louis Surfacer & Paint Co., St. Louis, Mo.
- Engine Apparatus.**  
Green Fuel Economizer Co., Matteawan, N. Y.
- Engineers and Contractors.**  
Arnold Company, Chicago.  
Byllesby, H. M., & Co., Chgo.  
Columbia Construction Co., Milwaukee, Wis.  
Ford, Bacon & Davis, New York.  
Register, A. L., & Co., Philadelphia.  
Roberts & Abbott Co., Cleveland, O.  
Sampson & Porter, New York  
Saxton, E., Washington, D. C.  
Sheaff & Jaastad, Boston.  
Stone & Webster Eng. Corporation, Boston.  
White, J. S., & Co., New York.
- Engines, Gas and Oil.**  
Buckeye Engine Co., Salem, O.  
Fairbanks, Morse & Co., Chgo.  
Westinghouse Machine Co., Pittsburg.
- Engines, Hoisting.**  
Fairbanks, Morse & Co., Chgo.
- Engines, Steam.**  
Buckeye Engine Co., Salem, O.  
Rossiter, MacGovern & Co., 17 Battery Pl., New York.  
Westinghouse Machine Co., Pittsburg.
- Fans, Exhaust and Ventilating.**  
General Electric Co., Schenectady, N. Y.  
Green Fuel Economizer Co., Matteawan, N. Y.  
Western Electric Co., Chicago.  
Westinghouse Elec. & Mfg. Co., Pittsburg.
- Fare Boxes—(See Electric Railway Supplies).**
- Fare Registers and Register Fittings.**  
Electric Service Supplies Co., 200 Plymouth Bldg., Chicago.  
Recording Fare Register Co., New Haven, Conn.  
Rooke Automatic Register Co., Providence, R. I.
- Feedwater Apparatus.**  
Green Fuel Economizer Co., Matteawan, N. Y.  
Wheeler Condenser & Eng'g Co., New York.
- Feed Wire—(See Wire and Cables).**
- Fenders and Guards.**  
Consolidated Car Fender Co., Providence, R. I.  
Eclipse Railway Supply Co., Cleveland, O.  
Electric Service Supplies Co., 1020-24 Filbert St., Phila.  
McGuire-Cummings Mfg. Co., Chicago.  
Marshall, R. W., & Co., 95 Liberty St., New York.
- Flangers, Snow.**  
McGuire-Cummings Mfg. Co., Chicago.  
Ohio Brass Co., Mansfield, O.  
Kalamazoo Railway Supply Co., Kalamazoo, Mich.  
Van Dorn & Dutton Co., Cleveland, O.
- Frogs—(See Switches, Frogs and Crossings).**
- Fuel Economizers—(See Economizers, Fuel).**
- Fuses and Fuse Devices.**  
Chase-Shawmut Co., Newburyport, Mass.  
Electric Service Supplies Co., 200 Plymouth Bldg., Chicago.  
General Electric Co., Schenectady, N. Y.  
Johns-Manville, H. W., Co., New York.  
Western Electric Co., Chicago.  
Westinghouse Elec. & Manufacturing Co., Pittsburg.
- Gaskets, Bronze.**  
Power Specialty Co., 111 Broadway, New York.
- Gates and Guards.**  
Bliss, R., Mfg. Co., Pawtucket, R. I.  
Kalamazoo Railway Supply Co., Kalamazoo, Mich.
- Gear Cases.**  
Electric Service Supplies Co., 200 Plymouth Bldg., Chicago.  
General Electric Co., Schenectady, N. Y.  
Marshall, R. W., & Co., 95 Liberty St., New York.
- Gears and Pinions.**  
Electric Service Supplies Co., 200 Plymouth Bldg., Chicago.  
General Electric Co., Schenectady, N. Y.  
Marshall, R. W., & Co., 95 Liberty St., New York.  
Nuttall, R. D., Co., Pittsburg.  
Van Dorn & Dutton Co., Cleveland, O.
- Generators—(See Dynamoes).**
- Gongs—(See Bells and Gongs).**
- Graphite Paint—(See Paint).**
- Grates, Chain.**  
Green Engineering Co., Com'l Nat. Bk. Bldg., Chicago.
- Grease—(See Lubricants).**
- Grinders.**  
Brown, Harold P., 120 Liberty St., New York.
- Ground Connection Clamps.**  
Chase-Shawmut Co., Newburyport, Mass.
- Guy Anchors—(See Anchors).**
- Harps, Trolley—(See Trolley Poles and Fittings).**
- Headlights.**  
Electric Service Supplies Co., 200 Plymouth Bldg., Chicago.  
Fairbanks, Morse & Co., Chgo.  
General Electric Co., Schenectady, N. Y.  
Ridlon, Frank, Co., 200 Summer St., Boston.  
St. Louis Car Co., St. Louis, Mo.  
Stuart-Howland Co., Boston.  
Trolley Supply Co., Canton, O.
- Headlinings, Passenger Car.**  
Indestructible Fibre Co., 45 Broadway, New York.
- Heaters, Car, Electric.**  
Consolidated Car-Heating Co., Albany, N. Y.  
Johns-Manville, H. W., Co., New York.
- Heaters, Car, Hot Water, and Stoves.**  
Baker, The Wm. C., Heating & Sup. Co., New York.  
Cooper Heater Co., The, Dayton, Ohio.  
Electric Service Supplies Co., 1020-24 Filbert St., Phila.  
McGuire-Cummings Mfg. Co., Chicago.  
Smith, Peter, Heater Co., Detroit, Mich.
- Heating and Ventilating Apparatus—(See Mech. Draft).**
- Holsts—(See Cranes, Holsts and Lifts).**
- Hose Bridges.**  
Ohio Brass Co., Mansfield, O.
- Hydraulic Machinery.**  
Watson-Stillman Co., 26 Cortlandt St., New York.
- Inspection.**  
Central Inspection Bureau.
- Inspection Cars, Gasoline.**  
Stover Motor Car Co., Freeport, Ill.
- Instruments, Measuring and Testing—(See Electrical Instruments).**
- Insulating Tapes.**  
General Electric Co., Schenectady, N. Y.  
Johns-Manville, H. W., Co., New York, N. Y.  
Massachusetts Chemical Co., Walpole, Mass.  
Okonite Co., Ltd., 253 Broadway, New York.  
Western Electric Co., Chicago.
- Insulations and Insulating Material.**  
Anderson, A. & J. M., Mfg. Co., Boston.  
Craghead Engineering Co., Cincinnati, O.
- Insulations and Insulating Materials—Continued.**  
Electric Railway Equipment Co., Cincinnati, O.  
Electric Service Supplies Co., 200 Plymouth Bldg., Chicago.  
General Electric Co., Schenectady, N. Y.  
Johns-Manville, H. W., Co., New York.  
Macallen, The, Co., Boston.  
Massachusetts Chemical Co., Walpole, Mass.  
Ohio Brass Co., Mansfield, O.  
Okonite Co., Ltd., 253 Broadway, New York.  
Ridlon, Frank, Co., 200 Summer St., Boston.  
Standard Paint Co., 100 William St., New York.  
Standard Varnish Works, New York.  
Stuart-Howland Co., Boston.  
Western Electric Co., Chicago.
- Jacks.**  
American Car Co., St. Louis.  
Brill, The J. G., Co., Philadelphia.  
Electric Service Supplies Co., 200 Plymouth Bldg., Chicago.  
Fairbanks, Morse & Co., Chgo.  
Kalamazoo Railway Supply Co., Kalamazoo, Mich.  
Kuhlman, The G. C., Car Co., Cleveland.  
Marshall, R. W., & Co., 95 Liberty St., New York.  
Morden Frog & Crossing Co., Chicago.  
Stephenson, John, Co., Elizabeth, N. J.  
Wason Mfg. Co., Springfield, Mass.  
Watson-Stillman Co., 26 Cortlandt St., New York.
- Joints, Expansion—(See Steam Fittings).**
- Joints, Rail.**  
Rail Joint Co., 29 W. 34th St., New York.
- Joints, Welded—(See Rail Joints, Welded).**
- Journal Boxes.**  
American Car Co., St. Louis.  
Brill, The J. G., Co., Philadelphia.  
Kuhlman, The G. C., Car Co., Cleveland.  
McGuire-Cummings Mfg. Co., Chicago.  
St. Louis Car Co., St. Louis, Mo.  
Stephenson, John, Co., Elizabeth, N. J.  
Symington, T. H., Co., Baltimore, Md.  
Wason Mfg. Co., Springfield, Mass.
- Journal Lubricators—(See Lubricants).**
- Journal Packing, Steel Wool.**  
Robertson, Wm., & Co., Fifth Floor Great Northern Bldg., Chicago.
- Lamps, Arc and Incandescent.**  
Anderson, A. & J. M., Mfg. Co., Boston.  
Electric Service Supplies Co., 200 Plymouth Bldg., Chicago.  
General Electric Co., Schenectady, N. Y.  
Ridlon, Frank, Co., 200 Summer St., Boston.  
Stuart-Howland Co., Boston.  
Western Electric Co., Chicago.  
Westinghouse Electric & Mfg. Co., Pittsburg, Pa.
- Lamp Sockets.**  
Electric Service Supplies Co., 200 Plymouth Bldg., Chicago.  
General Electric Co., Schenectady, N. Y.  
Johns-Manville, H. W., Co., New York, N. Y.
- Lantern Globes.**  
Railway Specialty & Supply Co., Chicago.
- Lifting Magnets.**  
Porter Mfg. Co., 29 Griswold St., Detroit, Mich.
- Lifts—(See Cranes, Hoist and Lift).**
- Lightning Arresters.**  
Electric Service Supplies Co., 200 Plymouth Bldg., Chicago.  
General Electric Co., Schenectady, N. Y.  
Stuart-Howland Co., Boston.  
Western Electric Co., Chicago.  
Westinghouse Elec. & Manufacturing Co., Pittsburg.
- Line Material.**  
Anderson, A. & J. M., Mfg. Co., Boston.  
Craghead Engineering Co., Cincinnati, O.  
Johns-Manville, H. W., Co., New York.  
Electric Ry. Equipment Co., Cincinnati, O.  
Electric Service Supplies Co., 200 Plymouth Bldg., Chicago.  
General Electric Co., Schenectady, N. Y.  
Macallen, The, Co., Boston.  
Marshall, R. W., & Co., 95 Liberty St., New York.  
Recording Fare Register Co., New Haven, Conn.  
Stuart-Howland Co., Boston.  
Western Electric Co., Chicago.
- Lock and Nut Washers.**  
National Lock Washer Co., Newark, N. J.
- Lockers, Metal.**  
Electric Service Supplies Co., 200 Plymouth Bldg., Chicago.
- Locomotives.**  
Baldwin Locomotive Works, Philadelphia.  
Johann, F. A., 1624 Pierce Bldg., St. Louis.
- Locomotives, Electric.**  
American Car Co., St. Louis.  
Baldwin Locomotive Works, Philadelphia.  
Brill, The J. G., Co., Philadelphia.  
General Electric Co., Schenectady, N. Y.  
Kuhlman, The G. C., Car Co., Cleveland.  
McGuire-Cummings Mfg. Co., Chicago.  
Stephenson, John, Co., Elizabeth, N. J.  
Wason Mfg. Co., Springfield, Mass.  
Westinghouse Elec. & Manufacturing Co., Pittsburg.
- Locomotives, Gasoline.**  
Fairbanks, Morse & Co., Chgo.  
Stover Motor Car Co., Freeport, Ill.
- Lubricants.**  
Deborn Drug & Chemical Works, Chicago.  
Galena-Signal Oil Co., Franklin, Pa.  
Whitmore Mfg. Co., Cleveland, O.
- Lumber.**  
Barnes, G. H., Hardwood Lumber Co., St. Louis, Mo.  
Beidler, Francis, & Co., Chgo.  
Berthold & Jennings, St. Louis.  
Lindsay Bros. Co., Spokane, Wash.  
S-E. Missouri Cypress Co., Campbell, Mo.
- Magnets and Solenoids.**  
Porter Mfg. Co., 29 Griswold St., Detroit, Mich.
- Malleable Iron.**  
St. Louis Car Co., St. Louis, Mo.
- Measuring Tapes.**  
Luffkin Rule Co., Saginaw, Mich.
- Mechanical Draft.**  
Green Fuel Economizer Co., Matteawan, N. Y.
- Meters.**  
Johns-Manville, H. W., Co., New York.  
Queen & Co., Philadelphia.  
Weston Electrical Instrument Co., Newark, N. J.
- Molded Goods.**  
Massachusetts Chemical Co., Walpole, Mass.  
Wood, G. S., Great Northern Bldg., Chicago.
- Motor Cars, Gasoline.**  
Stover Motor Car Co., Freeport, Ill.
- Motors, Electric.**  
Cleveland Armature Works, Cleveland, O.  
Fairbanks, Morse & Co., Chgo.  
General Electric Co., Schenectady, N. Y.  
National Brake & Electric Co., Milwaukee.



# Pay-As-You-Enter Cars meet all expectations on Chicago City Railway

---

President Thomas E. Mitten, in his recent annual report to the stockholders, makes this significant statement:

“Three hundred cars of the new Pay-As-You-Enter type have been purchased, 150 of which have been placed in service, resulting in almost entirely eliminating the large number of accidents brought about by passengers attempting to board or leave moving cars. The proportion of fares collected to passengers carried has also been materially increased, due to the collection of fares by conductor upon the rear platform.”



Similar results have followed the use of Pay-As-You-Enter Cars in Montreal, Buffalo, New York and Newark. They will produce equally satisfactory results on any heavy traffic line of your road. Investigate!

We license manufacturers and railways to build and use the Pay-As-You-Enter Car, the patents on which are owned by

## The Pay-As-You-Enter Car Company

DUNCAN McDONALD, President 26 Cortlandt Street, New York

THOS. W. CASEY, Manager

## CLASSIFIED LIST OF ADVERTISERS—Continued.

- Motors, Electric—Continued.**  
 Rossiter, MacGovern & Co., 17 Battery Pl., New York.  
 Western Electric Co., Chicago.  
 Westinghouse Elec. & Manufacturing Co., Pittsburg.
- Nut Locks.**  
 Chase-Shawmut Co., Newburyport, Mass.  
 National Lock Washer Co., Newark, N. J.  
 Railway Specialty & Supply Co., Chicago.  
 St. Louis Car Co., St. Louis, Mo.  
 U. S. Metal & Mfg. Co., 25 Broad St., New York.
- Nuts and Bolts.**  
 Lorain Steel Co., Philadelphia.  
 National Lock Washer Co., Newark, N. J.  
 Railway Specialty & Supply Co., Chicago.
- Oilers.**  
 Armstrong Oiler Co., 31st and Chestnut St., Philadelphia.
- Oils—(See Lubricants).**
- Overhead Equipment—(See Electric Railway Supplies).**
- Packings.**  
 Electric Service Supplies Co., 200 Plymouth Bldg., Chicago.  
 Johns-Manville, H. W., Co., New York.  
 Power Specialty Co., 111 Broadway, New York.
- Packing, Steel Wool Journal.**  
 Robertson, Wm., & Co., Fifth Floor Great Northern Bldg., Chicago.
- Paints.**  
 Massachusetts Chemical Co., Walpole, Mass.  
 Standard Paint Co., 100 William St., New York.  
 St. Louis Surface & Paint Co., St. Louis, Mo.
- Pay-As-You-Enter Cars.**  
 Pay-As-You-Enter Car Co., 26 Cortlandt St., New York.
- Pipe Bends and Fittings—(See Steam Fittings).**
- Poles, Metal.**  
 Craghead Engineering Co., Cincinnati, O.  
 Electric Railway Equipment Co., Cincinnati, O.  
 Electric Service Supplies Co., 200 Plymouth Bldg., Chicago.
- Poles and Ties, Wood.**  
 Advance Lumber Co., Cleveland, O.  
 Barney, G. H., Hardwood Lumber Co., St. Louis, Mo.  
 Beldier, Franca, & Co., Chgo.  
 Berthold & Jennings, St. Louis, Wash.  
 Churchill Cedar Co., Spokane, Wash.  
 Humbrld Lumber Co., Sand Point, Idaho.  
 Lindsley Bros. Co., Spokane, Wash.  
 National Pole Co., Escanaba, Mich.  
 Naugle Pole & Tie Co., 226 La Salle St., Chicago.  
 Pacific Coast Pole Co., Spokane, Wash.  
 S-E. Missouri Cypress Co., Campbell, Mo.  
 Worcester, C. H., Co., Tribune Bldg., Chicago.
- Promoters of Railway Projects.**  
 Shimer & Chase Co., Omaha, Neb.
- Punches—(See Ticket Punches).**
- Rail Benders.**  
 Electric Service Supplies Co., 200 Plymouth Bldg., Chicago.  
 Fairbanks, Morse & Co., Chgo.
- Rail Bonds—(See Bonds, Rail).**
- Rail Bonds, Flexible.**  
 Chase-Shawmut Co., Newburyport, Mass.
- Rail Drills—(See Drills, Track).**
- Rail Feed Wire—(See Wire and Cables).**
- Rail Joints and Chairs—(See Rail Joints, Rail).**
- Rail Joints, Welded.**  
 Lorain Steel Co., Philadelphia.
- Rails, New.**  
 Lorain Steel Co., Philadelphia.  
 New York Switch & Crossing Co., Hoboken, N. J.  
 Wharton, Wm., Jr., & Co., Philadelphia.
- Rails, Relaying.**  
 Zelnicker, Walter A., Supply Co., St. Louis.
- Railway Equipment.**  
 Johann, F. A., 1624 Pierce Bldg., St. Louis.
- Railway Velocipedes.**  
 Fairbanks Morse & Co., Chgo.  
 Kalamazoo Railway Supply Co., Kalamazoo, Mich.
- Registers and Fittings—(See Fare Registers).**
- Relays.**  
 Weston Electrical Instrument Co., Newark, N. J.
- Roofing.**  
 Johns-Manville, H. W., Co., New York.
- Rubber Goods, Mechanical.**  
 Wood, G. S., Great Northern Bldg., Chicago.
- Rubber Preservative.**  
 Wood, G. S., Great Northern Bldg., Chicago.
- Sand Apparatus.**  
 American Car Co., St. Louis.  
 Brill, The J. G., Co., Philadelphia.  
 Electric Service Supplies Co., 200 Plymouth Bldg., Chicago.  
 Kuhlman, The G. C., Car Co., Cleveland.  
 Marshall, R. W., & Co., 95 Liberty St., New York.  
 Ohio Brass Co., Mansfield, O.  
 Ridlon, Frank, Co., 200 Summer St., Boston.  
 St. Louis Car Co., St. Louis, Mo.  
 Stephenson, John, Co., Elizabeth, N. J.  
 Wason Mfg. Co., Springfield, Mass.
- Sash Balances and Fixtures.**  
 National Lock Washer Co., Newark, N. J.
- Sash Operating Devices.**  
 Drouvé, The G., Co., Bridgeport, Conn.  
 Lord & Burnham, Irvington-on-Hudson, New York.
- Seats, Car—(See Car Seats).**
- Shade Rollers—(See Curtains, Fixtures and Materials).**
- Shutters, Steel Rolling.**  
 Kinnear Manufacturing Co., Columbus, O.
- Signals.**  
 Blake Signal & Manufacturing Co., Boston.  
 Telegraph Signal Co., Rochester, N. Y.
- Signal Supplies.**  
 Railway Specialty & Supply Co., Chicago.
- Skylights.**  
 Drouvé, The G., Co., Bridgeport, Conn.  
 Lord & Burnham, Irvington-on-Hudson, New York.
- Snow Plows, Sweepers and Scrapers.**  
 American Car Co., St. Louis.  
 Brill, The J. G., Co., Philadelphia.  
 Kalamazoo Railway Supply Co., Kalamazoo, Mich.  
 Kuhlman, The G. C., Car Co., Cleveland.  
 McGuire-Cummings Mfg. Co., Chicago.  
 Russell Car & Snow-Plow Co., Ridgway, Pa.  
 Stephenson, John, Co., Elizabeth, N. J.  
 Wason Mfg. Co., Springfield, Mass.
- Sockets, Waterproof.**  
 Johns-Manville, H. W., Co., New York.
- Solder Paste.**  
 Chase-Shawmut Co., Newburyport, Mass.
- Splicing Compounds and Materials.**  
 Massachusetts Chemical Co., Walpole, Mass.
- Springs.**  
 American Car Co., St. Louis.  
 Brill, The J. G., Co., Philadelphia.  
 Kuhlman, The G. C., Car Co., Cleveland.  
 McGuire-Cummings Mfg. Co., Chicago.  
 Marshall, R. W., & Co., 95 Liberty St., New York.  
 Railway Steel Spring Co., 71 Broadway, New York.  
 St. Louis Car Co., St. Louis, Mo.  
 Stephenson, John, Co., Elizabeth, N. J.  
 Wason Mfg. Co., Springfield, Mass.
- Sprinkling Cars.**  
 American Car Co., St. Louis.  
 Brill, The J. G., Co., Philadelphia.  
 Kuhlman, The G. C., Car Co., Cleveland.  
 McGuire-Cummings Mfg. Co., Chicago.  
 Stephenson, John, Co., Elizabeth, N. J.  
 Wason Mfg. Co., Springfield, Mass.
- Stage Pockets and Plugs.**  
 Chase-Shawmut Co., Newburyport, Mass.
- Steam Apparatus.**  
 Green Fuel Economizer Co., Matteawan, N. Y.
- Steam Fittings, Etc.**  
 Crane Co., Chicago.  
 Davis, The John, Co., Chgo.  
 Simmons, John, Co., 110 Centre St., New York.  
 Power Specialty Co., 111 Broadway, New York.
- Steel Cars.**  
 American Car Co., St. Louis.  
 Brill, The J. G., Co., Philadelphia.  
 Kuhlman, The G. C., Car Co., Cleveland.  
 St. Louis Car Co., St. Louis, Mo.  
 Stephenson, John, Co., Elizabeth, N. J.  
 Wason Mfg. Co., Springfield, Mass.
- Steel Tapes.**  
 Luffkin Lumber Co., Saginaw, Mich.
- Stokers.**  
 Babcock & Wilcox Co., 85 Liberty St., New York.  
 Green Engineering Co., Com'l Nat. Bk. Bldg., Chicago.  
 Model Stoker Co., Dayton, O.  
 Under-Feed Stoker Co. of Am., Chicago.  
 Westinghouse Machine Co., Pittsburg.
- Storage Batteries—(See Batteries).**
- "Strike-Breakers."**  
 Drummond Detective Agency, 3 Ann St., New York.
- Superheaters.**  
 Power Specialty Co., 111 Broadway, New York.
- Switches, Frogs and Crossings.**  
 American Frog & Switch Co., Hamilton, O.  
 Barbour-Stockwell Co., Cambridgeport, Mass.  
 Cleveland Frog & Crossing Co., Cleveland, O.  
 Fairbanks, Morse & Co., Chgo.  
 Lorain Steel Co., Philadelphia.  
 Morden Frog & Crossing Co., Rookery, Chicago.  
 New York Switch & Crossing Co., Hoboken, N. J.  
 Railway Specialty & Supply Co., Chicago.  
 Wharton, Wm., Jr., & Co., Philadelphia.
- Switchboards and Switchboard Instruments.**  
 Anderson, A. & J. M., Mfg. Co., Boston.  
 Chase-Shawmut Co., Newburyport, Mass.  
 General Electric Co., Schenectady, N. Y.  
 Western Electric Co., Chicago.  
 Westinghouse Electric & Mfg. Co., Pittsburg.  
 Weston Electrical Instrument Co., Newark, N. J.
- Tapes and Webbing.**  
 Hope Webbing Co., Providence, R. I.  
 Johns-Manville, H. W., Co., New York.  
 Massachusetts Chemical Co., Walpole, Mass.  
 Okonite Co., Ltd., 253 Broadway, New York.
- Testing Instruments.**  
 Queen & Co., Philadelphia.  
 Weston Electrical Instrument Co., Newark, N. J.
- Test Lamps, Pocket.**  
 Chase-Shawmut Co., Newburyport, Mass.
- Ticket Choppers and Destroyers.**  
 Patton, Paul B., Salem, Mass.
- Ticket Punches.**  
 Meyers, Fred J., Mfg. Co., Hazelton, O.  
 Woodman Mfg. & Sup. Co., Boston.
- Ties and Poles, Wood—(See Poles and Ties).**
- Timber.**  
 Beldier, Franca, & Co., Chgo.  
 Lindsley Bros. Co., Spokane, Wash.  
 S-E. Missouri Cypress Co., Campbell, Mo.
- Tools, Pneumatic—(See Pneumatic Tools).**
- Track Cleaners and Scrapers.**  
 American Car Co., St. Louis.  
 Brill, The J. G., Co., Philadelphia.  
 Kalamazoo Railway Supply Co., Kalamazoo, Mich.  
 Kuhlman, The G. C., Car Co., Cleveland.  
 McGuire-Cummings Mfg. Co., Chicago.  
 Marshall, R. W., & Co., 95 Liberty St., New York.  
 Ohio Brass Co., Mansfield, O.  
 Stephenson, John, Co., Elizabeth, N. J.  
 Van Dorn & Dutton Co., Cleveland.  
 Wason Mfg. Co., Springfield, Mass.
- Track Drills—(See Drills, Track).**
- Tracklaying Machinery.**  
 Holman, D. F., Ry. Tracklayer Co., 1102 Ellsworth Bldg., Chicago.
- Track Tools.**  
 Electric Service Supplies Co., 200 Plymouth Bldg., Chicago.  
 Kalamazoo Railway Supply Co., Kalamazoo, Mich.
- Trimmings, Car.**  
 American Car Co., St. Louis.  
 Brill, The J. G., Co., Philadelphia.  
 Curtain Supply Co., Park Row Bldg., New York.  
 Kuhlman, The G. C., Car Co., Cleveland.  
 National Lock Washer Co., Newark, N. J.  
 St. Louis Car Co., St. Louis, Mo.  
 Stephenson, John, Co., Elizabeth, N. J.  
 Wason Mfg. Co., Springfield, Mass.  
 Wood, G. S., Great Northern Bldg., Chicago.
- Trolley Guards.**  
 Automatic Trolley Guard Co., 391 Ellicott Sq., Buffalo, N. Y.  
 Electric Service Supplies Co., 200 Plymouth Bldg., Chicago.
- Trolley Poles and Fittings.**  
 General Electric Co., Schenectady, N. Y.  
 Johns-Manville, H. W., Co., New York.  
 Marshall, R. W., & Co., 95 Liberty St., New York.  
 Star Brass Works, Kalamazoo, Mich.

# ST. LOUIS CAR CO. ST. LOUIS-MO.

**I**LLUSTRATED herewith is one of twelve single-end combination passenger, smoking and baggage compartment cars for the Pittsburgh, Harmony, Butler and Newcastle Railway.

These cars are of the St. Louis Car Company's semi-steel frame construction. Principal dimensions: total length, 46 feet; rear platform, 4 feet 5 inches; main passenger compartment, 22 feet 9½ inches; smoking compartment, 7 feet 8½ inches; baggage compartment, 10 feet 4 inches, including motorman's cab.

The sides are constructed with 12 window sashes and one baggage door. The lower sashes are arranged to raise, while the upper sashes are stationary. The side sashes are glazed with plate glass and the upper and deck sashes with opalescent glass.

The passenger compartment has 15 St. Louis Car Company's stationary seats, upholstered in brown plush with high head roll. In the rear of this compartment is a saloon, the side walls of which are covered with metal up to the window capping. The smoking compartment has six stationary seats, upholstered in dark green leather. The baggage compartment has three folding seats to be used when there is no baggage.

The motorman's cab is separated from the baggage compartment by an iron pipe railing. In the cab is a hot water heater on the left side of the motorman.

The cars are equipped with St. Louis Car Company's illuminated signs on the front of cars, vertical brake wheels on the front end and St. Louis Car Company's self-releasing brake handles on the rear end. They are mounted on high-speed trucks with air brakes and air sanders.



MADE IN THE LARGEST AND BEST EQUIPPED FACTORY OF ITS KIND IN THE WORLD

## CLASSIFIED LIST OF ADVERTISERS—Continued.

- Trolley Retrievers and Catchers.  
Electric Service Supplies Co.,  
1020-24 Filbert St., Phila.  
Milloy Electric Co., Bucyrus, O.  
Ridlon, Frank, Co., 200 Sum-  
mer St., Boston.  
Trolley Supply Co., Canton, O.
- Trolley Wagons.  
Kalamazoo Railway Supply  
Co., Kalamazoo, Mich.
- Trolley Wheels—(See Trolley  
Poles and Fittings).
- Trolley Wire—(See Wire and  
Cables).
- Trolleys, Track.  
Cleveland Armature Works,  
Cleveland, O.
- Trucks, Car.  
American Car Co., St. Louis.  
Baldwin Locomotive Works,  
Philadelphia.  
Brill, The J. G., Co., Phila-  
delphia.  
Kuhlman, The G. C., Car Co.,  
Cleveland.  
McGuire-Cummings Mfg. Co.,  
Chicago.  
St. Louis Car Co., St. Louis,  
Mo.  
Standard Motor Truck Co.,  
Pittsburg, Pa.  
Standard Varnish Works, New  
York City.  
Stephenson, John, Co., Eliza-  
beth, N. J.
- Trucks, Car—Continued.  
Van Dorn & Dutton Co.,  
Cleveland, O.  
Wason Mfg. Co., Springfield,  
Mass.
- Turbines.  
General Electric Co., Schene-  
cady, N. Y.  
Westinghouse Machine Co.,  
Pittsburg, Pa.
- Valves—(See Steam Fittings).
- Varnish.  
Electric Service Supplies Co.,  
200 Plymouth Bldg., Chicago.  
Harrison Elec. & Mfg. Co., 169  
South St., New York.  
Marshall, R. W., & Co., 95  
Liberty St., New York.  
Massachusetts Chemical Co.,  
Walpole, Mass.  
Milloy Electric Co., Bucyrus, O.  
Nuttall, R. D., Co., Pittsburg.  
Ridlon, Frank, Co., 200 Sum-  
mer St., Boston.  
Standard Paint Co., 100 Will-  
iam St., New York.  
Star Brass Works, Kalama-  
zoo, Mich.  
Trolley Supply Co., Canton, O.  
Wallace Supply Co., Chicago.  
Westinghouse Electric & Mfg.  
Co., Pittsburg, Pa.
- Ventilators.  
Drouvé, The G., Co., Bridge-  
port, Conn.  
Lord & Burnham, Irvington-  
on-Hudson, New York.
- Vestiettes.  
Bellamy Vestiette Mfg. Co.,  
Cleveland, O.
- Waste, Cotton and Wool.  
Hagy, J. Milton, Waste Wks.,  
Philadelphia, Pa.  
Railway Specialty & Supply  
Co., Chicago.
- Water Softening Apparatus.  
Dearborn Drug & Chemical  
Works, Chicago.
- Wheels and Axles.  
American Car Co., St. Louis.  
Brill, The J. G., Co., Phila-  
delphia.  
Griffin Wheel Co., Chicago.  
Kuhlman, The G. C., Car Co.,  
Cleveland.  
Lorain Steel Co., Philadelphia.  
McGuire-Cummings Mfg. Co.,  
Chicago.  
Marshall, R. W., & Co., 95  
Liberty St., New York.  
Railway Steel-Spring Co.,  
New York.  
St. Louis Car Co., St. Louis,  
Mo.  
St. Louis Car Wheel Co., St.  
Louis.  
Standard Steel Works, Phila-  
delphia.  
Stephenson, John, Co., Eliza-  
beth, N. J.  
Wason Mfg. Co., Springfield,  
Mass.
- Wheel Grinders.  
Wheel Turning Brake Shoe Co.,  
Detroit, Mich.
- Window Fixtures.  
Drouvé, The G., Co., Bridge-  
port, Conn.
- Wiping Rags.  
Hagy, J. Milton, Waste Wks.,  
Philadelphia, Pa.
- Wire, Aluminum.  
Aluminum Co. of America,  
Pittsburg, Pa.
- Wire, Insulated.  
Aluminum Co. of America,  
Pittsburg, Pa.  
American Electrical Works,  
Providence, R. I.  
General Electric Co., Schene-  
cady, N. Y.  
Okonite Co., Ltd., 253 Broad-  
way, New York.  
Standard Underground Cable  
Co., Pittsburg, Pa.  
Stuart-Howland Co., Boston.
- Wire and Cables.  
Aluminum Co. of America,  
Pittsburg, Pa.  
American Electrical Works,  
Providence, R. I.  
Bridgeport Brass Co., Bridge-  
port, Conn.  
General Electric Co., Schene-  
cady, N. Y.  
Okonite Co., Ltd., 253 Broad-  
way, New York.  
Standard Underground Cable  
Co., Pittsburg, Pa.



## TROLLEY WIRE, BARE COPPER CABLES WEATHERPROOF WIRE AND CABLES

RUBBER COVERED CABLES AND LEAD COVERED UNDERGROUND CABLES  
FOR ANY SERVICE. WRITE US FOR SPECIAL PRICES AT THE TIME  
STANDARD UNDERGROUND CABLE CO.  
Pittsburg New York Boston St. Louis San Francisco Chicago  
Philadelphia Los Angeles Atlanta

## PNEUMATIC TOOL AIR BRAKE and FIRE HOSE

GUILFORD S. WOOD  
ELECTRIC RAILWAY  
NECESSITIES  
Great Northern Bldg., Chicago 1

## Your Wife Will Laugh

if you tell her that you purchase electric  
tape by the pound. When *she* goes shop-  
ping, yardage and quality direct her. Our

No. 264 ELECTRIC TAPE

is the *highest quality obtainable* and the  
greatest yardage per pound. *But don't*  
*lose sight of the yardage.*

Your jobber will supply you if you insist.

*Write for quotations.*

MASSACHUSETTS CHEMICAL COMPANY

Operates  
Walpole Varnish Works PLANT: WALPOLE, MASS.  
Walpole Rubber Works

Do you know the difference between

## Motor Packing Waste

and other kinds?

The service each renders, of course, proves the case.  
A sample order for enough *Motor Packing Waste*  
to pack a few motor boxes will show the difference.  
All kinds of high-grade Wastes, Wiping Rags, etc.

The J. Milton Hagy Waste Works  
433 Spruce Street Philadelphia 5

## THE BABCOCK & WILCOX COMPANY

85 Liberty Street, New York

Babcock & Wilcox ——— Stirling ——— A & T Horizontal ——— Cahall Vertical

# WATER TUBE STEAM BOILERS

STEAM SUPERHEATERS

Works: Bayonne, N. J. Barberton, Ohio.

MECHANICAL STOKERS

BRANCH OFFICES:

BOSTON, Delta Bldg.  
PHILADELPHIA, 1110-1112 North American Bldg.  
SAN FRANCISCO, 53 First Street  
PITTSBURGH, Farmers Deposit Nat. Bank Bldg.  
NEW ORLEANS, 343 Baronne St.

DENVER, 410 Seventeenth St.  
SALT LAKE CITY, 313 Atlas Block  
WASHINGTON, Colorado Building  
CHICAGO, Marquette Bldg.  
ATLANTA, GA., 1132 Candler Bldg.

CLEVELAND, 706 New England Bldg.  
MEXICO CITY, 7 Avenida. Juarez  
HAVANA, CUBA, 116 1/2 Calle de la Habana  
LOS ANGELES, 321 Trust Bldg.  
CINCINNATI, O., Traction Bldg.

## TUBULAR POLES

IRON OR STEEL



FOR

**ELECTRIC RAILWAYS**

**ELECTRIC LIGHTING CO'S**

**SIGNAL** } SER-  
**TELEPHONE** } VICE  
**TELEGRAPH** }

**TRANSMISSION**

**L I N E S**

**C A T E N A R Y**  
**S U S P E N S I O N**  
**L I N E S**

**ELECTRIC RAILWAY EQUIPMENT CO.**

General Office: CINCINNATI-O-U-S-A

Shops: READING PA - WHEELING WVA

# THE LOVELL Window Operator

is constructed on the straight push-and-pull principle

- working through a rack and pinion
- actuated by a chain- or cable-controlled wheel.

It is the simplest, strongest device and most positive in action of the many we know about.

Any length of sash in one run up to 500 feet instantly opened or closed at one station, and the most distant windows operate in unison with those nearest. A boy can do the trick as well as a man.

To reduce drafts in case of fire and to insure perfect ventilation at all times, nothing is quite so efficient as the Lovell Window Operator.

*Made only by*

## The G. Drouvé Co.

Bridgeport, Conn., U. S. A.

Western Office: 40 Dearborn Street, Chicago

# Tell Us Your Brake Shoe Troubles

There isn't any kind of brake shoe problem we haven't solved satisfactorily thus far, and if you have a new or different kind of trouble we'd like first rate to know all about it.

Chances are that we can help you considerably. Of course we'll talk standardization—and not only talk it, but actually demonstrate to your own satisfaction that you can save a whole lot of good money by using our M. C. B. Christie type shoes.

You know how often you've wished that you didn't have so many brake shoe patterns, and you know how it hurts to see so heavy a percentage of brake shoe material find its way to the scrap heap.

It's easy enough to remedy both conditions.

*Just drop us a line and see.*

## American Brake Shoe & Foundry Company

Mahwah, N. J.

170 Broadway  
New York

Western Union Bldg.  
Chicago

# FOR SALE. FOR QUICK DELIVERY

## 6 55-ft. Passenger, Baggage and Smoking Car Bodies

Main Compartment 26' 0"  
Smoking " 10' 6"  
Baggage " 10' 0"  
Seating Capacity, 54

## 8 60-ft. Passenger, Baggage and Smoking Car Bodies

Main Compartment 28' 6"  
Smoking " 11' 0"  
Baggage " 8' 0"  
Seating Capacity, 58

## 5 52-ft. Passenger and Smoking Car Bodies — Double End

Seating Capacity, 60

## 3 52-ft. Passenger and Baggage Car Bodies — Double End

Seating Capacity, 56

## 2 50-ft. Express Car Bodies

*Write or wire us for further information.*

# The Jewett Car Co. Newark Ohio

**THE MIGHTY  
MIDGET**

## HOT WATER CAR HEATER

Adapted for Large Electric Cars and Long Distance Lines. Exclusively used on Largest Electric Systems. Ask for Catalog  
**THE WILLIAM C. BAKER HEATING & SUPPLY CO., 143 LIBERTY STREET  
NEW YORK**



## NILES CARS — THE ELECTRIC PULLMANS

LARGE, FAST INTERURBANS  
OUR SPECIALTY

## NILES CAR & MFG. COMPANY

WORKS: NILES, OHIO

Sales Office:  
J. A. HANNA Co., 312 Electric Bldg., Cleveland, O.

## "Not an Experiment"

The Providence Fender has been in successful operation on hundreds of roads for 13 years, and has proved itself reliable under all conditions of Street Railway service.

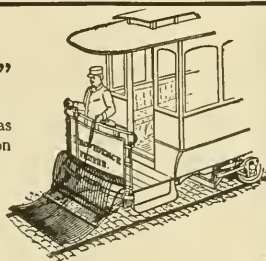

## CONSOLIDATED CAR FENDER COMPANY

Office and Factory: PROVIDENCE, R. I.  
Branch Office: 110 E. Twenty-third St., New York  
European Agents: Comptoir d'Electricite, 6, Rue Boudreau, Paris, France



It costs  
just two 5c fares

to heat a car 24 hours if you  
use a COOPER HEATER

Send for interesting pamphlet

The Cooper Heater Co., Dayton, Ohio

# STANDARD HIGH-SPEED "INTERBOROUGH" DOUBLE TRUCK

TYPE C-60

## "Solid Forged"

WITHOUT WELDS

FRAMES ARE MADE FROM ROLLED OPEN-HEARTH STEEL WITHOUT WELDS. ALL WEARING BOLTS ARE TURNED AND CASE HARDENED, AND WEARING HOLES STEEL THIMBLED. M. C. B. STANDARD PRINCIPLES ARE FOLLOWED. WE ARE PREPARED TO BUILD TRUCKS IN ACCORDANCE WITH PURCHASER'S DESIGNS AND SPECIFICATIONS.

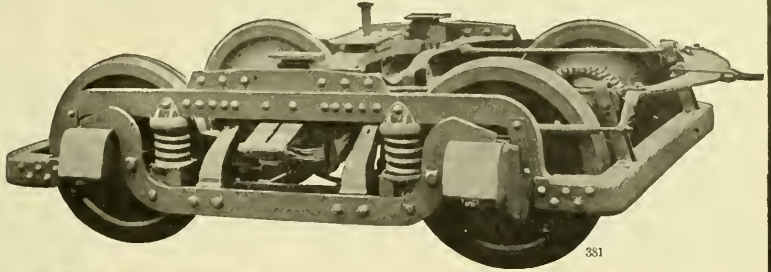

381

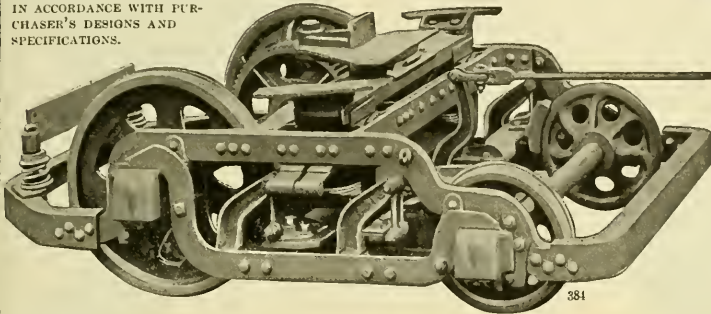

384

# STANDARD "MAXIMUM TRACTION" DOUBLE TRUCK

CITY AND SUBURBAN TYPE O-45

OVER TWO HUNDRED OF THESE "MAXIMUM TRACTION" TRUCKS ARE IN SERVICE IN BROOKLYN, NEW YORK, AND ARE PRONOUNCED "HIGHLY SATISFACTORY."

STANDARD MOTOR TRUCK COMPANY, FRICK BUILDING, PITTSBURGH, PENNSYLVANIA  
NEW YORK OFFICE: 170 BROADWAY WORKS: NEW CASTLE, PA. CHICAGO OFFICE: FISHER BUILDING

## Collecting and Registering Fares

—by the Rooke Automatic Collector System:

PASSENGER COMPANY Conductor

—by all old-fashioned register systems:

PASSENGER CONDUCTOR Company (?)

Under old-fashioned systems nickels are often collected without being registered—and unregistered nickels never reach the treasury.

Under the Rooke System every nickel is registered before it reaches the conductor's hand.

There is no chance for the nickel to go astray.

Rooke Automatic Register Co. : Providence, R. I.

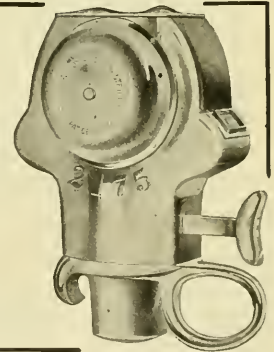

Avoid Accidents

By Using This Switch

SPECIAL TRACK WORK OF EVERY DESCRIPTION

## New York Switch & Crossing Co.

HOBOKEN, N. J.

## Anti-Straddling or Anti-Kicking Tongue Switch

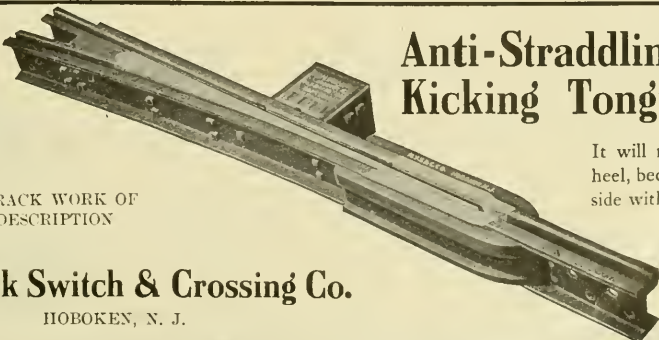

It will not drive down at the heel, because it is held to either side with a spring tension and firmly down on its bed. A car can not straddle this tongue.

WRITE FOR SPECIAL CIRCULAR

# How Much Damage in One Year

to overhead car tops and passengers is caused by wild trolley poles on your road?

¶ If you compute it (and it will pay you to start figuring right now) you will find that the amount is excessively large. ¶ On many roads a sum equal to or less than the yearly damage cost has proven sufficient to equip all cars with the Knutson Trolley Retriever, thus eliminating a large and useless expense. ¶ The first cost per car is not large and the maintenance expense is small, owing to a simple, strong construction that stands the wear and tear. ¶ Write us today.



Why not give me a 30 Days' Free Trial?

6

## Trolley Supply Co., Canton, O.



Factory of The Milloy Electric Company  
Bucyrus, Ohio

## The Milloy Trolley Base

built in our new and specially equipped factory, insures a quality which will give excellent service under ordinary and extraordinary conditions.

The Milloy Base is unusually low, has even tension on high or low wire. Has no fulcrum, no friction, no oil, no center post. Always efficient. Particulars on request.

**THE MILLOY ELECTRIC COMPANY**  
Bucyrus, Ohio

## Hydraulic Forcing Presses

WE HAVE just issued a catalogue of 130 pages describing and illustrating over 100 different hydraulic presses and tools whose main purpose is the making and breaking of force fits in the assembling or preparing of machinery and similar work.

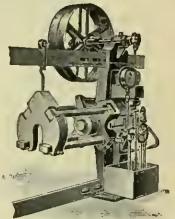

Write for Special Forcing Catalogue.

## THE WATSON-STILLMAN CO.

Main Office: 26 Cortlandt Street, New York City  
Branch Office: 453 The Rookery, Chicago, Ill.

# The Macallen Company

FORMERLY THE W. T. C. MACALLEN CO.

## Electric Railway Material

### BRASS FOUNDERS

Foundry and Division Sts., Boston, Mass.



- |                               |       |                               |
|-------------------------------|-------|-------------------------------|
| ELECTRIC SERVICE SUPPLIES CO. | - - - | Philadelphia, Pa.             |
| ELECTRIC SERVICE SUPPLIES CO. | - - - | Chicago, Ill.                 |
| OTTO NEISSER                  | - - - | Los Angeles, Cal.             |
| FRANK RIDLON CO.              | - - - | Boston, Mass.                 |
| F. BISSELL COMPANY            | - - - | Toledo, Ohio                  |
| JAS. CLARK, Jr., & CO.        | - - - | Louisville, Ky.               |
| J. A. DAWSON & CO.            | - - - | Montreal and Winnipeg, Canada |



## The Boilers Will be Out of Service a Much Shorter Time for Washing

thereby requiring very much less labor, to say nothing of the saving in fuel and the increased efficiency of the boilers, if the incrusting solids and other deleterious salts in the water are acted upon by *Dearborn Compounds* and their injurious properties destroyed. Send us gallon sample of your feed water for analysis.

### Dearborn Drug & Chemical Works

ROBT. F. CARR, PRESIDENT

299 BROADWAY, NEW YORK

POSTAL TELEGRAPH BLDG., CHICAGO

## Automatic Trolley Guard

will save the cost of a complete installation if it prevents only one bad accident at a steam railway crossing, subway or under crossing, or on a curve, bridge or other dangerous place.

Its use on overhead enables the motorman to have absolute control of his car at all such places. Not at all like other trolley guards with which you are familiar, either in design, construction or material.

*May we send you detailed description?*

**AUTOMATIC TROLLEY GUARD CO.**

391-393 Ellicott Square  
BUFFALO, N. Y.

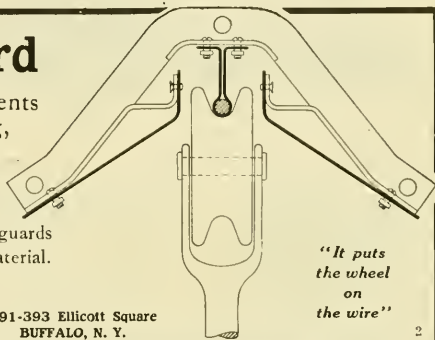

## Galena-Signal Oil Company

FRANKLIN, PA.

THEIR SPECIALTIES

**STREET RAILWAY LUBRICATION** including both rolling stock and power house equipment.

Same skillful *expert supervision* given in this service as in steam railway service has produced very satisfactory results. The business of our Street Railway Department has increased beyond every expectation. In 1906 this department sold ten times the number of barrels of oil sold by the same department in 1903.

We are under contract with many of the largest street and interurban railways of the country.

We guarantee cost per thousand miles in street railway service when conditions warrant it.

Write to Franklin, Pennsylvania, for further particulars.

**STEAM RAILWAY LUBRICATION** Sole manufacturers of the celebrated *Galena Cough, Engine and Car Oils* for steam railway lubrication. *Sibley's Perfection Valve Oil* for cylinder lubrication, and *Perfection Signal Oil* for use in railway signal lanterns.

**GALENA RAILWAY SAFETY OIL** Made especially for use in headlights, cab, classification and tail lights, and for switch and semaphore lamps. Burns equally well with the long time as with the one-day burner; with or without chimney as the burner requires. Is pure water white in color; high fire test, low cold test, and splendid gravity.

CHAS. MILLER, President

## HEINE WATER TUBE BOILERS

combine the four boiler requisites:

- Safety and Durability**
- Economy of Fuel**
- Economy of Space**
- Accessibility for both Internal and External Cleaning**

It took twenty-five years of experiment and improvement to produce these results.

You will be interested in reading the interesting story as told in our little book, "Boiler Logic."

A complimentary copy sent on request.

### HEINE SAFETY BOILER CO.

421 Olive St., ST. LOUIS, MO.

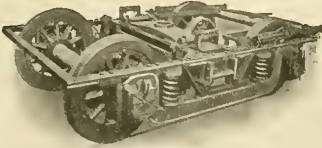

Truck built for Indianapolis, New Castle & Toledo Electric Railway Company.

# BALDWIN LOCOMOTIVE WORKS

BURNHAM, WILLIAMS & CO., PHILADELPHIA, PA., U. S. A.

Builders of **LOCOMOTIVES OF EVERY DESCRIPTION**  
Including **ELECTRIC LOCOMOTIVES** and

# ELECTRIC TRUCKS



**STANDARD STEEL WORKS,**  
**SOLID FORGED ROLLED AND STEEL TIRED WHEELS**  
mounted on axles and fitted with Motor Gears for Electric Railway Service

HARRISON BUILDING  
PHILADELPHIA, PA.

**ELLIPTIC AND  
COIL SPRINGS**

For **CABLE, ELECTRIC** and  
**ELEVATED CARS**

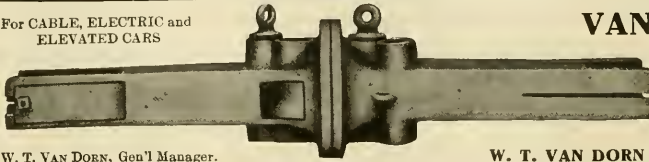

No. 5

W. T. VAN DORN, Gen'l Manager.

## VAN DORN AUTOMATIC COUPLERS

The records go farther than talk.  
Look up the records.  
Send for booklet of information on Couplings.

W. T. VAN DORN COMPANY, 1076 S. Paulina Street, CHICAGO

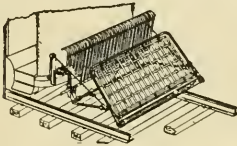

## ECLIPSE Life Guard

Manufactured by the  
**ECLIPSE RAILWAY SUPPLY CO.**  
Cleveland, Ohio



**AS IT  
HOLDS**

**Jobbers who publish  
a new catalogue should  
have one of our cuts.**

**THE ATLAS ANCHOR CO.,** Cleveland, Ohio

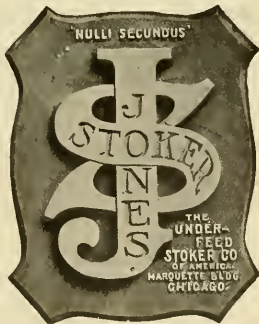

"NULLI SECUNDUS"

**J  
STOKER  
S**

THE  
UNDER-  
FIELD  
STOKER CO.  
OF AMERICA  
MARQUETTE BUILDG  
CHICAGO



WE NOW MAKE 75% OF THE TROLLEY WHEELS.  
WE WANT TO MAKE THE OTHER 25%.

THE STAR BRASS WORKS  
KALAMAZOO, MICH.

# PIPE FITTINGS AND VALVES

FOR THE  
**HEATING AND PLUMBING TRADE**

TRADE  MARK

**JOHN SIMMONS CO.**  
104-110 Centre Street, NEW YORK

## THE LORAIN STEEL COMPANY

**Girder Rails and High Tee Rails  
High-Grade Special Track Work**

GENERAL OFFICES  
THE PENNSYLVANIA BUILDING, PHILADELPHIA, PA.

## Shawmut Soldered Bond Cap

to make over your  
**PLUG BONDS**



Why not look this up

**CHASE-SHAWMUT CO.**  
Newburyport, Mass.

# CAR CURTAINS

Did you ever stop to think how much is added to the appearance of your cars by tasteful window curtains?

Let us give you an estimate upon new ones for those cars you are renovating.

## The Curtain Supply Company

Main Office and Works,  
83-93 Ohio Street, CHICAGO, ILL.  
530 Mission Street SAN FRANCISCO 1819 Park Row Bldg. NEW YORK

Why not cut your packing bill in half?

## STEEL WOOL JOURNAL PACKING

will do this for your road, as it has for many others. It will also save one-third in oil consumption and an appreciable amount of labor and wear. And it prevents hot boxes **positively**.

*If you are open to conviction, send for free sample and test it thoroughly*

**WM. ROBERTSON & COMPANY**

General Office: Great Northern Bldg., CHICAGO  
Factory: 75 S. Jefferson St., BATTLE CREEK, MICH.

12

## Dossert Solderless Connectors

The Standard for Splicing.  
THE ONLY Officially Approved Mechanical Joint!



2-Way, Type A. Showing Details.

Type A for all stranded and solid wires, indoors or underground.  
Type B for overhead line construction on stranded conductor only.

**DOSSERT & COMPANY**

242 W. 41ST STREET, NEW YORK

2



Established 1877.



**ALBERT & J. M. ANDERSON MFG. CO.,**

Makers of

**ELECTRICAL APPLIANCES:  
SWITCHES, SWITCHBOARDS,  
TIME SWITCHES, LINE MATERIAL,  
COPPER CASTINGS (75% CONDUCTIVITY.  
289-293 A ST., BOSTON, MASS., U. S. A.**

Branches:

New York, 195 Broadway. Chicago, 175 Dearborn Street.

Agencies:

Boston, Pettingell-Andrews Co. San Francisco, Eccles & Smith Co.  
New York, R. W. Marshall & Co. Atlanta, Newcomer-Manny Co.  
St. Louis, J. C. White. Denver, E. M. Messiter.  
Toronto, Ont., H. J. Surtees.



## Whitmore's Gear Protective Composition

is the first and only compound placed upon the market that has given entire satisfaction and convinced those who were in doubt that it stands in a class by itself. Cut down your expense by the use of **Whitmore's Gear Protective Composition**

—you can do it.

**The Whitmore Manufacturing Company**  
Cleveland, Ohio, U. S. A.

4

# CLASSIFIED ADVERTISEMENTS

Undisplayed advertisements are inserted under this heading at the uniform rate of one cent a word; minimum charge twenty-five cents. Replies directed to this office will be forwarded when required to any address in the United States, Canada or Mexico without extra charge. Advertisements received at the Chicago office by 9 a. m. Thursday will appear in the issue for the same week.

## POSITIONS WANTED.

An experienced business getter and manager would like to secure position as traffic manager for large electric system. Highest references. Address "No. 548," care of Electric Railway Review, Chicago.

Position as auditor wanted by a young man of experience in street railway and electric light accounting. Best of references as to character and ability. Address "No. 545," care Electric Railway Review, Chicago.

Position as auditor or assistant wanted by a young single man. Thoroughly experienced in railway, gas and lighting accounting. Now employed. Address "No. 544," care of Electric Railway Review, Chicago.

What can you offer young man with eight years' railway supply experience in sales department? Office or selling. Good correspondent. Unimpeachable reference. Address "No. 557," care of Electric Railway Review, Chicago.

Expert armature winder on all types of G.E. and Westinghouse motors is open for a position. Live, up-to-date man, capable of handling men. Excellent habits. A-1 references. Address "No. 552," care of Electric Railway Review, Chicago.

Position Wanted—Accountant and auditor thoroughly qualified to take full charge of office. Ten years' experience as auditor, bookkeeper and office manager. Can establish and maintain complete system of accounts. Street and interurban railway properties a specialty. Address "No. 554," care of Electric Railway Review, Chicago.

## POSITIONS WANTED.

Superintendent operating 200-car city division of a well-known trolley system must change. Desire similar position with smaller system, where there would be opportunity to make friends for the line and increase traffic. Experienced in railroad and electric line organization. Age 34. References: Every former superior officer. Address "No. 555," care of Electric Railway Review, Chicago.

Experienced master mechanic desires position. Has thorough knowledge of high-speed electric railway equipment, on third rail or trolley. Is good executive, tactful and able to organize work of departments. Best of references furnished. Will consider position with high-speed interurban or city railway. Address "No. 550," care Electric Railway Review, Chicago.

Position by draftsman; have had nine years' experience in electric railway work, instrument work, mechanical and electrical drafting. Experience: assistant to master mechanic and inspector of car construction, equipment and maintenance; track work and buildings. Also familiar with operation. Thoroughly reliable. Address "No. 549," care of Electric Railway Review, Chicago.

## POSITIONS OPEN.

Twelve offices, covering the entire street railway and manufacturing world. Positions open everywhere—office, sales and technical. Write today, HAP-GOODS, 305 Broadway, New York, or 1010 Hartford Bldg., Chicago.

## MISCELLANEOUS WANTS.

Want to buy second-hand equipment, machinery or material? A card inserted in the Electric Railway Review, stating just what you want, will bring immediate response. The card is small—only 1.20 an inch (measuring 1 inch deep by 1 1/2 inches wide) per insertion. Send orders to Electric Railway Review, 160 Harrison St., Chicago.

What have you to sell in the way of second-hand equipment, machinery or material? Buyers read the "For Sale" cards on the following page and there is the place to tell your story. "For Sale" cards are inexpensive—only \$1.20 an inch (measuring 1 inch deep by 1 1/2 inches wide) per insertion. Special rates on contracts for 100 inches or more to be used within one year. Now is the time to send your order to Electric Railway Review, 160 Harrison St., Chicago.

## BOOKS AND PUBLICATIONS.

Ask us about any book on electric railway and allied subjects. We publish some and sell all that are in print. The Wilson Company, 160 Harrison Street, Chicago.

Copies of the Street Railway Review of January and February, 1906, are wanted. Name condition and price. Address "No. 535," care of Electric Railway Review, Chicago.

We want your friends to read the Electric Railway Review. You will do them—and us—a favor by sending their addresses. We will gladly mail free sample copies. Electric Railway Review, 160 Harrison Street, Chicago.

## BUSINESS OPPORTUNITIES.

Exclusive sales agency wanted for Chicago and west for several street railway specialties. Appliances for cars only. Address "No. 556," care of Electric Railway Review, Chicago.

Wanted—Man with some capital and a knowledge of railway track supplies to join the advertiser—a salesman handling locomotive and car supplies—in a general railway supply business. Address "No. 538," care of Electric Railway Review, Chicago.

## BOOKS AND PUBLICATIONS.

Wanted—Copy of the Electric Railway Review of January 12, 1907, in good condition. State price in your answer. Address "No. 530," care of Electric Railway Review, Chicago.

Wanted—Copies of the Street Railway Review of April, 1900, May, 1901, and August, 1903. State price and condition. Address "No. 553," care of Electric Railway Review, Chicago.

If interested in any phase of steam transportation, you will find every development covered fully and accurately in The Railway Age. It is the leader and acknowledged authority in this field. Ask for free sample copies. The Railway Age, 160 Harrison Street, Chicago.

A copy of "The Motorman and His Duties," the standard handbook on the theory and practice of electric car operation, is worth many times its cost to every man interested in the subject. Send for 16-page pamphlet of sample pages. The Wilson Company, 160 Harrison Street, Chicago.

## THE NATIONAL LOCK WASHER CO., NEWARK, N. J.

Curtains - Curtain Fixtures - Sash Locks - Sash Balances - Nut Locks

CHICAGO OFFICE: 419 MONADNOCK BLOCK



CONTINUOUS JOINT

Over  
25,000  
miles  
in use



WEBER JOINT

Rolled  
from  
Best Quality  
Steel



WOLHAUPTER JOINT

Additional safety and economy in Track Maintenance has been proved by the use of Continuous, Weber and Wolhaupter-base-supported rail joints—after ten (10) years' service, having a record of over 25,000 miles in use—the extent of which is evidence of their excellence.

### Catalogs at Agencies

Baltimore, Md. Portland, Ore.  
Boston, Mass. Seattle, Wash.  
Chicago, Ill. St. Paul, Minn.  
Denver, Colo. St. Louis, Mo.  
Pittsburg, Pa. Troy, N. Y.

London, Eng. Montreal, Can.

HIGHEST AWARDS—Paris, 1900;  
Buffalo, 1901; St. Louis, 1904

## THE RAIL JOINT COMPANY

General Offices: 29 West 34th Street, New York City  
Makers of Rail Joints for Standard and Special Rail Sections, also Girder, Step or Compromise, and Insulating Rail Joints, protected by patents in United States and Foreign Countries.

# Want Ads

25 cents for any number of words under 25—more than 25 words, one cent a word per insertion. Replies forwarded without charge. Want Ads produce results—

# Try Them

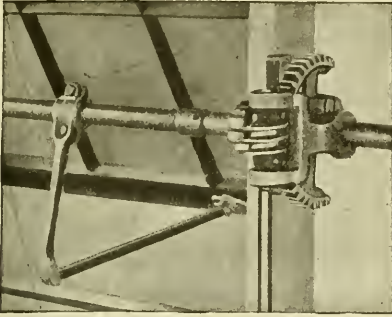

## The Ventilation

of your Shops, Foundries and Car Barns is made especially effective by a speedy, positive and easily manipulated **Sash Operating Apparatus** which automatically locks the sash at any position.

*Let us send you our catalogue.*

**Lord & Burnham Company**  
Irvington-on-Hudson, N. Y.

# R.W. MARSHALL & CO.

95 and 97 Liberty St., New York

Second-Hand Machinery and Equipment

## ELECTRIC RAILWAY MATERIALS

RAILS

Locomotives Cars Etc

Bought & Sold

Walter A. ZELNICKER Supply Co.

ST. LOUIS

FOR SALE CHEAP!

One 14x22 eight-wheel locomotive  
Ten 34-foot 50,000 capacity flat cars  
Two Greenleaf turntables  
70 box cars, 40 and 50,000 capacity  
80 Good Second-hand Bridges

Specifications and Blue Prints on application

F. A. JOHANN

1624 Pierce Bldg., St. Louis, Mo.

### FOR SALE: Three Car Bodies and Three Pairs of Double Trucks

with or without electric equipment and air brakes; all new and never used. Compelled to sell, as these cars will not operate over a leased line by reason of their width and length.

**R. W. MARSHALL & CO., 97 Liberty St., New York, N. Y.**

### FOR SALE CHEAP 200 Second Hand STREET CAR BODIES

Vestibule and Open, in elegant condition.

Also 1,000 New Car Folding Gates and 300 Car Stoves

**THE ISAAC JOSEPH IRON CO. OF CHICAGO** 1247 First National Bank Building.

## BUCKEYE ENGINE CO.

SALEM, OHIO

### Builders of High Class STEAM AND GAS ENGINES

in powers from 25 to 10,000 H. P.

Correspond with us before placing orders.  
Catalogues on application.

One cent a word for want ads in the Electric Railway Review.

NO SNOW TO DELAY CARS

The Russell Snow-Plow is used by more than 50 roads to maintain schedules and prevent blockades. Russell Car & Snow-Plow Co., Ridgway, Pa. Wendell & MacDuffie, Portland St., New York; C. A. Bailston, Fisher Bldg., Chicago; Robinson & Cary Co., Saint Paul.

IF YOU HAVE A RUSSELL

### SPRINGS—TIRES—STEEL-TIRED WHEELS RAILWAY STEEL-SPRING CO.

General Offices: 71 Broadway, New York

ROSSITER, MACGOVERN & CO. (Inc.)

90 West Street, New York

ENGINES Boilers, Locomotives, Cars, GENERATORS 2nd Hand MOTORS

New and Transformers, Railway, A. C. & D. C.

## ALUMINUM

### Railway Feeders

And all kinds of **Electrical Conductors**

Aluminum Feeders are less than one-half the weight of copper feeders and are of equal conductivity and strength. If insulated wire or cable is required, high grade insulation is guaranteed.

*Write for prices and full information.*

**Aluminum Company of America**  
PITTSBURGH, PA.

Formerly The Pittsburgh Reduction Company



## SOLENOIDS AND MAGNETS

for any purpose; lift and travel guaranteed.

Special electrical work and motors.

**THE PORTER MFG. CO.** 29 Griswold Street DETROIT, MICH.

## Send Us Your Book List

We publish a number of standard works on railway and allied subjects, both electric and steam. We sell all that are in print. Write us.

**The Wilson Company** 160 Harrison Street CHICAGO

**THE ARNOLD COMPANY**  
 ENGINEERS-CONSTRUCTORS  
 ELECTRICAL - CIVIL - MECHANICAL  
 101 LA SALLE STREET  
 CHICAGO

**A. L. REGISTER & CO.**  
 Engineers and General Contractors--Electric Railways  
 112 North Broad St. PHILADELPHIA, PA. Established 1889

**SHIMER & CHASE CO.**  
 Experienced Promoters of Electrical Railway Projects  
 Correspondence Solicited OMAHA, NEB.

**H. M. Bylesby & Company**  
 Incorporated  
 ENGINEERS  
 American Trust Bldg., Chicago  
 Design, Construct and Operate  
 Railway, Light, Power and  
 Hydraulic Plants EXAMINATIONS AND  
 REPORTS

**CENTRAL INSPECTION BUREAU**  
 Inspection of Rails, Ties, Cars, Motors, Bridges, Buildings, Etc.  
 17 STATE STREET - - - NEW YORK CITY

**LINE MATERIAL**  
 ELECTRIC SUPPLIES FOR RAILWAYS, POWER PLANTS, ETC.  
 THE CREAGHEAD ENGINEERING CO., 348 Main Street, Cincinnati, Ohio

**J. G. WHITE & COMPANY**  
 INCORPORATED  
**Engineers, Contractors**  
 43-49 Exchange Place,  
 41-43 Wall Street New York, N. Y.  
 Principal Philippine Office: Manila, P. I.

A. U. Jaastad P. J. Harleman F. E. Greenwood  
**SHEAFF & JAASTAD**  
 ENGINEERS  
 Broad Exchange Building, 68 Broad Street, BOSTON, MASS.

**SMITH CONCRETE MIXER**  
 does the work better, quicker, cheaper and lasts longer.  
**CONTRACTORS' SUPPLY & EQUIPMENT COMPANY**  
 Old Colony Building, Chicago 170 Broadway, New York 9

**Complete Plants for the Rapid  
 Handling of Material**  
 Every Sort of Hoisting Apparatus  
**BROWN HOISTING MACHINERY CO.** Cleveland, Ohio

**Gongs For Street Cars Bells**  
 G. C. REITER, Canton, Ohio

**HART CONVERTIBLE BALLAST, GONDOLA AND CONSTRUCTION CAR**  
**RODGER BALLAST CAR CO.,** Railway Exchange, CHICAGO

**HOT WATER HEATERS FOR CARS**  
 THE PETER SMITH HEATER COMPANY, Detroit, Mich.

**SANDERSON & PORTER**  
 ENGINEERS AND CONTRACTORS  
 EXAMINATIONS - REPORTS - DESIGNS - SPECIFICATIONS  
 CONSTRUCTION-EQUIPMENT-SUPERVISION AND MANAGEMENT  
 OF RAILWAY, LIGHT AND POWER PROPERTIES  
 HYDRO-ELECTRIC DEVELOPMENTS  
 52 WILLIAM STREET NEW YORK!

**ELECTRIC HEATERS** For All Classes of Cars  
 New York Consolidated Car-Heating Co. Chicago

The Recording Fare Register Company  
  
 New Haven, Conn.

**BRAKESHOOES**  
 STANDARD BRAKESHOE COMPANY  
 GEN'L OFFICES & WORKS--AURORA, ILL.--CHICAGO OFFICE 319 1/2 E. W. CH.

**RE-ENFORCED SPOKE WHEELS**  
 For City and Suburban Cars  
**ST. LOUIS CAR WHEEL CO.,** St. Louis, Mo.



**GEARS AND PINIONS**  
 FOR ALL TYPES OF MOTORS  
**THE VAN DORN & DUTTON CO.,** CLEVELAND, OHIO

**GRIFFIN WHEEL CO.**  
 CHICAGO  
 CHILLED IRON CAR WHEELS IRON OR STEEL AXLES

The soft steel flanges of the  
**Ideal Trolley Wheel**  
 have an absolutely uniform thickness that insures *perfect balance*. And perfect balance means high mileage.  
 Buffalo **LUMEN BEARING CO.** Toronto

WRITE TO **MODEL STOKER COMPANY** DAYTON OHIO  
 for detailed information about the best  
**AUTOMATIC SMOKELESS FURNACE**

**WHEEL TRUING BRAKE SHOES**  
 Repair Crippled Wheels While Running  
**THE WHEEL TRUING BRAKE SHOE CO.,** Detroit, Mich.

**INSULATING VARNISHES**  
(BAKING; AIR-DRYING)  
**COMPOUNDS**  
**TAPE**



Possess the Highest Insulative Efficiency.

The Standard Paint Co.  
100 William St.  
New York.

**Coach and Car (Metal) Surfacer**  
Elastic — Durable — Economical



**ST. LOUIS SURFACER & PAINT COMPANY**  
St. Louis, U. S. A.

**The Lindsley Brothers Company**  
Producers and Shippers of **WESTERN CEDAR POLES** and Manufacturers of **RED FIR CROSS ARMS**  
Eastern Sales Office, Monadnock Bldg., CHICAGO SPOKANE, WASHINGTON

**POLES and PILING** 20,000 35s and 40s, Ready to Ship at Once  
S-E. MISSOURI CYPRESS CO., CAMPBELL, MO.

**G. H. BARNES HARDWOOD LUMBER CO.**  
Office and Yard: Main and Warren Sts., ST. LOUIS, MO.  
Ties, Car Oak, Poplar, Ash, Cherry, Plain and Quartered Oak

One cent a word for want ads in the  
Electric Railway Review

**C. H. WORCESTER CO.**  
**CEDAR POLES**  
PRODUCERS AND WHOLESALEERS  
Suite 1719 Tribune Building CHICAGO

**Idaho Cedar Poles**  
PACIFIC COAST POLE CO. SPOKANE, WASH.

Red **Cedar Poles** White  
Prompt deliveries at right prices.  
**NATIONAL POLE COMPANY**  
EVERETT, WASH. ESCANABA, MICH.

We have in our Chicago Yard available for **RUSH SHIPMENTS** a **SELECTED STOCK** of **POLES** and **TIES**  
**NAUGLE POLE AND TIE CO.**  
Chicago Office, 226 La Saile Street

**CHESTNUT POLES**  
Cedar, Oak and Chestnut Ties  
FROM OUR OWN TIMBER LANDS  
**THE ADVANCE LUMBER CO.**  
CLEVELAND, OHIO

We are Producers and Wholesale Dealers in Western  
**CEDAR POLES**  
Yards in Washington, Idaho, Montana and British Columbia  
WRITE US FOR DELIVERED PRICES  
**CHURCHILL CEDAR CO.,** Box 1409, Spokane, Wash.

**BERTHOLD & JENNINGS**  
LUMBERMENS BLDG. SAINT LOUIS, MO.

**TIMBERS**  
L. L. Pine, Oak

**POLES**  
Cedar, Cypress, Chestnut

**TIES**  
Oak, Cypress, Chestnut

**WHITE CEDAR** **P** Large Stock 14 to 65 ft.  
**P** Prompt Shipment  
**OLES**  
**S**

**YARDS:**  
Menominee, Mich.  
Escanaba, Mich.  
Superior, Wis.  
Deer River, Minn.

**FRANCIS BEIDLER & CO.**  
Chicago, Ill.

# For Your Road—

A telephone dispatching system with a reliable signal under positive control of the dispatcher is the best, safest and quickest means of dispatching electric trains, and a certain preventive of disaster.

This means the

## Telegraph Signal System

One bare iron wire only is required for signaling.  
One dollar a month per station pays the maintenance.  
One bad smashup will pay for installation many times over.

Write today—now—for complete information.

## Telegraph Signal Company

282 State Street, Rochester, N. Y.



11

# Save Money on Repairs and Parts for Railway Motors

by patronizing our works  
—the largest of their kind  
in America—where we

- make Armatures complete, re-shaft and re-wind them
- furnish Commutators complete, refilled and assembled
- do all kinds of field work for nearly all different makes of Dynamos and Motors.

We give the best of service. You can pay freight both ways (unless very far distant) and still save money.

**Cleveland Armature Works**  
Cleveland, Ohio

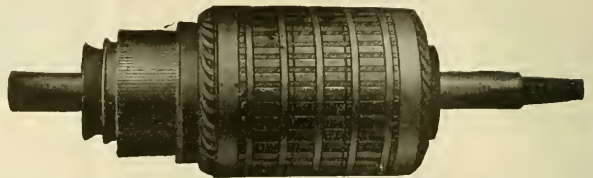
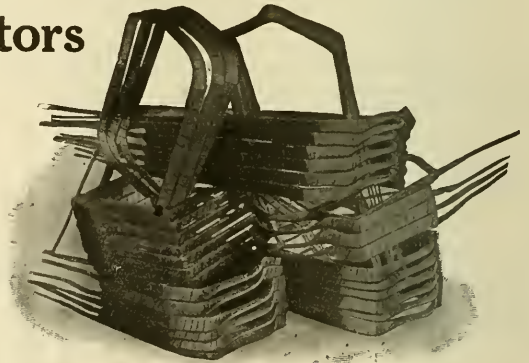

28



# Electric Railway Review

PUBLISHED EVERY SATURDAY BY THE WILSON COMPANY, CHICAGO

Entered as second-class matter January 5, 1907, at the postoffice at Chicago, Ill., under the act of March 3, 1879.

160 Harrison Street, Chicago  
150 Nassau Street, New York  
1529 Williamson Bldg., Cleveland

VOL. XIX  
No. 10

CHICAGO, MARCH 7, 1908

Whole No.  
254

Subscription: Domestic . . . \$2  
Foreign . . . \$5  
Canada . . . \$3.50

A policy which should be successful has been adopted by William A. House, president of the United Railways & Electric Company of Baltimore. On January 8 the Baltimore News published an interview with Mr. House which was introduced by the statement that "because of the many expressions of approval heard during the past year" on the new policy of the company the reporter was prompted to ask what had led to the change. The tenor of the answer was that the most valuable asset a public service corporation can have is the good-will of the public. Mr. House showed what had been done to strengthen the right of the company to the favorable opinion of the people. In pursuance of this policy the company has recently printed advertisements in the daily newspapers relating to the service and the papers have called attention thereto by articles in their news columns and editorials. In the performance of its duty the electric railway makes impressions which materially affect its earnings and expenses. As an individual has very largely in himself the determination of the impression which he creates upon the minds of others with whom he comes in contact, so a corporation influences by its acts the opinions of people regarding it. The United Railways & Electric Company has already printed several bulletins designed to develop a fair-minded attitude on the part of the public. The substance of the advertisement relating to transfers was published in last week's issue of the Electric Railway Review, page 276. In this advertisement the company showed that it was performing a valuable public service by its liberal privileges of transfer.

It is interesting to learn how extensively the single-phase system of current distribution for electric railways has been adopted in North America. M. N. Blake, more, in the February issue of the Electric Journal, presents a table showing general characteristic data on the single-phase electric roads in America. Thus we learn that there are 28 single-phase roads with a combined route mileage of 966.3 miles. If we take into account the fact that some of those roads have electrified two, three and even four tracks, a probably accurate estimate of the total mileage of single-phase electrically operated track would be 1,105 miles. Since the issue of the journal, earlier referred to, two single-phase roads, the Washington Baltimore & Annapolis and the Hanover & York railways, have begun operating. We therefore may readjust the totals as presented, thus finding that there are in operation 771.8 route-miles and under construction 194.5 route-miles of single-phase operated track. For the handling of passengers these roads require 240 cars, 162 of which, on 11 different roads, are equipped for combined alternating and direct current operation. There are also 57 electric locomotives used for freight purposes. The motive power equipment of the electric motors on these cars and locomotives has a total rated capacity of 137,400 horsepower. The alternating-current voltages carried on the trolley wires range from 1,200 to 11,000, a wide variation. The first single-phase road to be put in service was the Indianapolis & Cincinnati, which began operating in December, 1904, but little more than three

years ago. Bearing in mind the shortness of its growing period and remembering that there are now or soon will be in operation more than 1,100 miles of single-phase operated electric railway track, the rapidity of the new system's growth is at once apparent.

For any but metropolitan railway track the grooved girder rail seems to have had its day. A striking example of how a city council, at first favoring the grooved rail, after a fair trial willingly authorized the use of high T-rail, is told by C. W. Kellogg, Jr., in the March Stone & Webster Public Service Journal. In the winter of 1906 and 1907 the El Paso Electric Railway endeavored to obtain permission from the city council to install T-rails. The city council did not differ from a thousand and one other city councils and therefore insisted that the grooved girder rail should be used in the paved districts. Under protest the railway company built the track with grooved rail. It is now in a position to say to the city, "I told you so." The grooved rail has grown into disfavor because of its noisiness. The city council is now convinced that the T-rail is most acceptable for tracks in the paved districts of El Paso, and so, on January 9, 1908, permission was granted the railway company to use T-rail in future paving extensions. The track substructure approved by the city comprises wooden ties embedded in concrete. These ties carry 80-pound T-rails 7 inches high with a 2½-inch head. Between the rails the concrete is filled in above the tops of the ties and given a surface of Bitulithic paving material. Special nose brick are not used, but vitrified paving brick are laid parallel with the rail, three in a row, with the edge of the inner row set under the head of the T-rail. This track substructure combines many desirable features and we predict that the T-rail therein used will give entire satisfaction to the city authorities.

Without statements of total mileage and construction cost, which are placed at 1,300 and \$50,000,000, respectively, it would hardly be possible to realize the extent to which the Swedish government will electrically equip its state railways. In the February issue of the Electric Trunk Line Age is presented a descriptive article outlining the proposed plans for this enormous electrification project. Practically the entire mileage controlled by the state between the southern end of the Scandinavian peninsula and a line across the peninsula 150 miles north of Stockholm will be equipped for single-phase operation at 15,000 volts. The trains to be operated, from our point of view, are light, hardly comparing in weight with most of the equipments operated on the American interurban lines; therefore the decision to use single-phase motors rather than direct-current or three-phase equipments is justified. Current for the operation of the electrified railways will be generated at water power stations, of which there are a plentiful number in Sweden. Wooden poles will be used to support the trolley brackets carrying the catenary overhead wire, and steel poles set in concrete will be used for the independent

transmission circuits. In the preliminary report are estimates of cost and depreciation that are particularly interesting when compared with similar quantities for railway construction and operation in America. Interest was put at 3.8 per cent; copper wire was estimated at 30 cents a pound for the transmission lines and 31 cents a pound for the hard-drawn contact wire, the depreciation charges being 0.7 per cent and 2.5 per cent respectively for transmission and contact lines. On account of the possibility of double-tracking before the present plans are entirely consummated in 1920, the poles carrying the trolley wire will have to be renewed in 10 years' time. This great project of electrifying 1,300 miles of operated railways is actually under construction and the execution of the work will undoubtedly bring forth a vast amount of data of value to engineers interested in the many electrical projects in America.

---

### THE FUTURE OF THE INTERURBAN ROAD.

---

At a recent hearing in Boston before the legislative committee on street railways, Bentley W. Warren, counsel for the Boston & Northern Street Railway, presented an argument against a bill providing for privately owned elevated or subway lines, intimating at the close of the discussion that the trend of the times indicates that the coming electrification of steam railroads will obviate the needs of electric railroads; that it will be easier and cheaper to provide additional tracks for the electrified steam railroads than to build anew; and that the possession of great city terminals by the railroads will give them an advantage which the new interurban lines cannot hope to equal. There is no more interesting question in the transportation world than the future of the interurban railway in relation to the electrification of the steam roads.

In the main, the high-speed interurban railway development of the past has been confined to populous terminal cities, separated by thinly settled intermediary country, but there has lately come into existence a distinct demand for faster service in and between the cities and towns of the older communities of the east—a service that cannot possibly be given on the highways even with restricted stops. The possibilities of modern engineering are far from exhausted in the field of interurban rapid transit.

There is little question that the interurban line has come to stay. Each type of road fills a certain need of its own. The main issue is whether the electrified steam road, co-operating with the existing street railway development, can supply the class of service which at present the interurban lines are furnishing or are likely to furnish in the event of their construction in populous territory. A critical study inclines one to the belief that the existing steam railroad properties, serving sections that are thickly settled, cannot, even through electrification, provide the precise service of the high-speed electric interurban road. On the existing trackage of the steam roads, stops cannot be much increased in populous territory without interference with the movement of traffic. Separation of suburban from through travel is imperative. The addition of new tracks to a long established steam line is, in populous regions, an enormously expensive task, particularly as such tracks must inevitably conform fairly closely in alignment and grade to the older tracks, in order to allow steam locomotive service or heavy electric freight and passenger trains to be operated on the new rails in the flexible manipulation of the whole service.

A new high-speed interurban railway cannot, of necessity, be an enterprise of low cost, but in view of the fact that the route can be selected with particular reference to the requirements of interurban coupled with suburban travel, and without the same physical limitations which restrict even the electrified steam road, it is difficult to escape the conclusion that in many cases the new interurban right of way will cost less

per mile than the additional right of way assumed by an expanding electrified steam railroad. In the case of the latter it is probable that if electrification of existing 4-track lines is carried out to the greatest possible extent additional right of way can be deferred for many years. Even if this means a greater cost per mile of track in the case of the competitive interurban road, it does not follow that the converted steam road can duplicate the former's service. The reasons are not obscure.

The interurban line of the future will inevitably be in closer touch with the local street railway systems than the electrified steam lines. This means superior facilities for the collection and distribution of passengers within the terminal cities. The total time of transit from a station on an electrified steam railroad to the great city terminal station will inevitably be much less than the schedule of the interurban, even with the latter on a private right of way. The transportation problem is never solved, however, until the passenger or commodity completes the journey from the point of origin to the point of destination. Collecting and distributing facilities along the line of the interurban road are obviously superior to those of the former steam line, for, while the interurban cannot at the same time furnish the door-to-door service of the original street railway and give fast transportation from terminal to terminal, it can give a service intermediary between that of the street car and that of the electrified steam line, sufficiently flexible in its more frequent stops than the latter, its higher schedule speed than the former, and its superior distributing facilities or multiplex discharge points in convenient sections of the terminal cities to attract a traffic that should insure its future against displacement by any policy likely to be adopted on the electrified steam railroad. The many defects of interurban operation will need to be remedied before the best service can be given. Not the least of these is the prevailing practice of routing interurban cars built for fast running in and out of large towns over the most crowded tracks of the local street railway companies. Few interurban lines can afford to buy private right of way into large cities, but in many instances the routing of the cars by less frequented streets near enough to the main thoroughfares to attract traffic would enable very substantial savings to be made in the elapsed time from one end of the route to the other.

---

### ARRANGING CAR LIGHTS.

---

Attention was called at a recent meeting of the American Society of Mechanical Engineers to the poor distribution of the artificial light in use in steam railway cars. Until within the last few years, within which electric lighting has been introduced on steam lines, a number of center lights suspended from the upper deck were employed. These were oil lamps in pairs or later two or more gas burners, and the arrangement for the most part gave a sufficiently brilliant light directly under the lamp.

However, between the lamps there was a deep shadow and under all conditions the passenger was confronted with a row of lights shining in his face. With the adoption of electric lighting by the steam railways the practice of carrying a row of lights under the lower deck as on trolley cars was given some attention with the result that more even and better light was obtained. The objection of the tiresome glare of a row of lights shining directly into the eyes remained, however.

In buildings the modern system of illumination provides for an evenly diffused light approaching as nearly as possible the effect of daylight. Such an effect has been secured by many incandescent lights concealed behind a cornice near the ceiling and so located that the light is reflected first to the ceiling and then downward.

The steam railways, on the one hand, have not been able

to introduce a lighting system of this character in cars because of the illuminant employed and electric railways, on the other hand, have not had the complaint of the objectionable nature of the lights because their passengers have for the most part been making such short trips that the tiring effect of the lights upon their eyes has not been felt. But with the increasing length of trips taken by passengers on electric lines an opportunity is offered for the distribution of light which is not open to the steam railways because of the lack of an entirely successful electric lighting system.

With the general use of electric light on trolley cars the electric railways should be able to point the way for improvement in light distribution. It has been suggested that the way lies in the utilization of the molding at the junction of the upper and lower decks for concealing the lamps themselves and effecting a distribution by reflection from the upper and lower decks similar to that obtained by the lights concealed behind a cornice in buildings.

ANNUAL REPORT.

Twin City Rapid Transit Company.

The annual report of the Twin City Rapid Transit Company of Minneapolis for 1907 shows a much smaller increase over 1906 in net earnings than in gross earnings. The result of the financial crisis was felt to some extent in the last quarter of the year. The actual gain in gross passenger earnings was \$128,463, and Thomas Lowry, the president, estimates that had it not been for the development of unfavorable conditions, the increase would probably have amounted to \$500,000. Miscellaneous earnings amounted to \$35,201, as compared with \$52,909, but the reason for this decline is not stated. The earnings for three years compare as follows:

	1907.	1906.	1905.
Aver. miles track operated.	360	335	283
Gross earnings	\$6,055,743	\$5,644,988	\$4,759,262
Operating expenses	2,980,436	2,675,380	2,119,145
Net earnings	\$3,075,307	\$2,969,608	\$2,640,117
Taxes, charges, etc.	1,223,171	1,137,428	1,050,797
Net divisible income.	\$1,852,136	\$1,832,180	\$1,589,320
Preferred dividends	210,000	210,000	210,000
Balance	\$1,642,136	\$1,622,180	\$1,379,320
Common dividends	1,005,000	952,500	881,387
Surplus	\$ 637,136	\$ 669,680	\$ 497,933
Special appropriations	506,000	482,000	340,000
Surplus	\$ 131,136	\$ 187,680	\$ 157,933

The operating expenses given in the foregoing table equaled 49.2 per cent of gross earnings in 1907, as compared with 47.4 per cent in 1906. Operating expenses, plus taxes and allowance for depreciation, absorbed 63.84 per cent of gross earnings, as compared with 61.83 per cent in the preceding year. The total of all the maintenance expenditures was larger than in 1906, being as follows for the two years: Way and structure, 1907, \$192,209; 1906, \$195,024; equipment, 1907, \$269,748; 1906, \$240,230. Car service cost \$1,340,962, as compared with \$1,167,999. Upon the operation of power plants the company expended \$513,867 in 1907, as compared with \$467,264 in 1906.

The figures for 1906 as presented in the comparative table published in the 1907 report are somewhat different from those contained in the report issued one year ago. The reason is that decisions against the company in court on claims pending at the close of 1906 amounted to much more than was anticipated, and it was therefore found that the reserve for injuries and damages was inadequate. The sum of \$50,000, the estimated amount of the deficiency, was accordingly added to the injuries and damages account of 1906, causing a corresponding reduction in the surplus. The total reserve for injuries and

damages amounted at the close of 1907 to \$89,995, an amount which the company considers in excess of probable requirements. There was set aside from surplus a special reserve fund of \$250,000 for contingencies and \$141,855 of this amount was on hand at the close of the year. The specific purpose of this reserve fund is to furnish funds for "extraordinary outlays other than operating expenses, such as discounts on bonds and legal expenses." The insurance fund amounted on December 31, 1907, to \$84,743; the sum of \$19,671 was added to this fund during the year. With relation to the renewal fund the following is shown: There was appropriated from the surplus of the year \$506,000, and this was added, with \$17,500 interest on investments, to the renewal fund, the charges to which aggregated \$258,029 during the year; the fund stood on December 31, 1907, at \$855,920. Nearly all of the money in the renewal and the insurance funds is invested in the 5 per cent bonds of the company. In his statement to the stockholders, Mr. Lowry says:

The car service has been considerably improved, the car mileage being increased 2,513,089 miles. The rates of wages paid to all employes have also been increased, as has been done on previous occasions when the earnings warranted it, without any demands from them. The company thus keeps in its employment a body of men who are fully satisfied that their interests, at all times, receive fair consideration. No organization has, in consequence, existed among them at any time in the past 14 years. The management feels that the action in both of these matters was well advised, occasioning much favorable comment by the press, and likely to show, in the near future, that it has paved the way to still larger earnings. It recognizes that there is no better asset in the street railway business than a satisfied body of employes and the good-will of the traveling public. Your company is fortunate in having its relations in these respects on a most satisfactory basis.

Mr. Lowry mentions the decision of W. A. Lochren, judge of the United States circuit court, declaring illegal an ordinance passed by the city of Minneapolis requiring the company to sell six tickets for 25 cents. Although the city has appealed to the United States supreme court, Mr. Lowry states that the company is advised by its counsel that they have the utmost confidence that the case was correctly decided and that the judgment will be affirmed.

The figures of traffic compare as follows:

	1907.	1906.	1905.
Revenue passengers	117,414,647	109,194,985	94,666,696
Transfer passengers	35,261,823	31,533,846	26,612,347

The outstanding bonds at the close of the year amounted to \$17,900,000, an increase of \$1,354,000 during the year. The company sold \$800,000 consolidated mortgage 5 per cent bonds, and purchased \$574,000 additional bonds for the renewal and reserve funds, making a total of \$1,374,000 issued. There were redeemed \$20,000 Minneapolis Street Railway 7 per cent bonds. The common stock and preferred stock issues were unchanged at \$20,100,000 and \$3,000,600, respectively.

Elevated service on the Brooklyn bridge was interrupted from 6:30 to 9 last Saturday night because two elevated cars were derailed and one torn from its rear truck, near the Brooklyn terminal. Service on the trolley lines was maintained with difficulty, because of the unusual press of traffic. Incoming trains at the Brooklyn terminal were switched into the yard or sent around the loops and the passengers received transfers to the surface lines. Although the north track of the elevated road over the structure was not blocked, it was found impracticable to operate shuttle trains because of the new switching system at the Manhattan end of the bridge. A wrecking crew from the Bay Ridge station, Brooklyn, was rushed to the Brooklyn terminal and the cars were jacked back onto the tracks.

The power house of the Wilmington (Del.) City Railway was flooded on account of an overflow in Brandywine creek on February 26 and the plant was shut down and the street railway service interrupted for several hours.

THE HANOVER & YORK SINGLE-PHASE RAILWAY.

The York Railways Company, York, Pa., has just added to its interurban system a 20-mile single-track line between York and Hanover, Pa. An accompanying map will serve to show the lines of this company, which radiate in five directions from York. The old lines are all operated with 600-volt equipment, while the equipment for the new Hanover division is designed to operate either on 6,600-volt alternating current or 600-volt direct current.

Track and Roadway.

The route of the Hanover & York railway follows closely that of the Pennsylvania Railroad, serving the same territory. The steam road is crossed twice, but the grades are separated in each instance. Leaving the center of the business district of York, the cars will operate for two miles over the city tracks to the southeast limits of York, where the private right of way of the interurban line begins. This private right of way is continuous to within about four blocks of the center of Hanover. Inasmuch as the general surface of the country is comparatively rough, a large amount of earthwork was required to obtain a roadbed with maximum grades of 2 per cent and curves of long radius.

The track, which includes 80-pound T-rails, connected with Weber 4-bolt joints, is ballasted with crushed rock. The rails are electrically connected with 15-inch No. 0000 American Steel & Wire Company soldered bonds, one at each joint. There are no surface crossings with railroads and each of the bridge structures is of a permanent type, built of steel and resting on concrete piers and abutments. Two of the accompanying illustrations will serve to show the types of through truss and deck girder spans employed. The structural steel work was built by the York Bridge Company. The general contractors for the roadway work were Dodge & Day, Philadelphia, and John H. Dobbhing of York.

station is stepped up to 23,000 volts and transmitted to York, where the power company has a step-down station in which

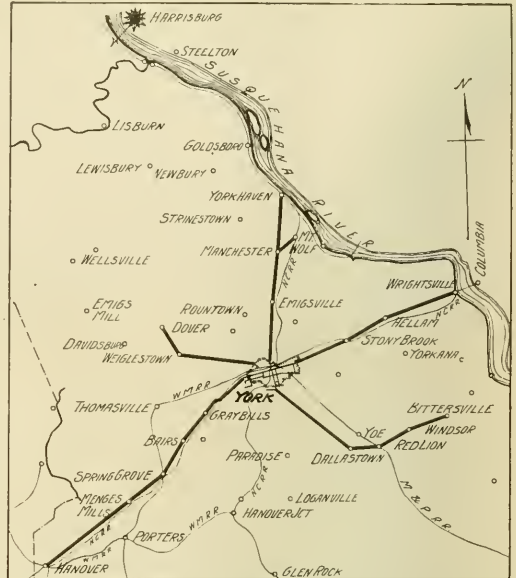

Hanover & York Railway—Interurban Lines of York Railways.

the pressure is lowered to 2,300 volts. At this voltage current is delivered to the station of the York Railways Company,



Hanover & York Railway—Overhead Crossing with Highway and Stream.

At each important highway crossing the company has erected a shelter shed of the attractive design illustrated herewith.

Power Distribution.

Current for the operation of the line is purchased from the York Haven Water Power Company, which has a hydraulic plant on the Susquehanna river, 12 miles north of York. The power is generated at 2,300 volts, which in the generating

where it is fed to two 450-kilowatt Westinghouse motor-generator sets. Each of these units comprises a 2,300-volt three-phase 60-cycle synchronous motor, driving a single-phase 6,600-volt 25-cycle generator. Exciting current is furnished by a 3-machine set, comprising an induction motor driving two 125-volt direct-current Westinghouse generators. The regulation of the motor-generator sets is effected with a Tirrell regulator, which controls the field current of the exciting generators.

From the line switch at the power house in York the 6,600-volt current to feed the interurban trolley wire is carried across the city on an independent pole line supporting one No. 0000 feeder and one track return wire of the same conductivity.

The trolley wire throughout the length of the private right of way carries current at 6,600 volts pressure. The wire is supported by catenary construction and fittings of standard

The rolling stock equipment, recently built by the Niles Car & Manufacturing Company, Niles, O., comprises four double-end passenger cars with smoking and passenger compartments, toilet rooms and separate heater closets. The general specifications of these cars follow:

Length over buffers, 51 ft. 3 in. Height under sills to top of roof ..... 9 ft. 5 in.  
 Over vestibules, 49 ft. 11 in.



Hanover & York Railway—Overhead Crossing with Steam Railway.

Westinghouse manufacture, with vertical hangers spaced 10 feet apart. The side brackets which support the messenger wire are carried on chestnut poles 55 feet high with 7-inch tops, spaced 100 feet apart. A 4-pin arm supports a telephone circuit and wires for an automatic block signal system, now

Of car body, ....	40 ft. 5 in.	From track to top of roof, .....	12 ft. 11 3/8 in.
Of vestibules, ....	4 ft. 9 in.	Between truck centers, ....	27 ft. 6 in.
Passenger compartment, .....	28 ft. 5 3/4 in.	Wheel base of trucks, .....	6 ft. 6 in.
Smoking compartment, .....	11 ft. 11 3/4 in.		



Hanover & York Railway—Passenger Car for Combined Direct and Alternating Current Service.

being installed by the W. S. Jackson Automatic Signal Company of York, Pa.

Where the high-tension trolley wire passes under bridges these structures are protected by a wooden ceiling of substantial construction. The design is such that should a trolley wheel or a pantograph collector leave the wire it will not be possible for it to ground the trolley wire or messenger on the overhead bridge structure.

Width over sheathing, ....	8 ft. 7 1/2 in.	Weight of car body, about, .....	30,000 lb.
Over all, .....	8 ft. 10 in.	Total weight, approximately, .....	82,000 lb.
Of aisle, .....	19 in.	Seating capacity, .....	52 persons
Length of seats, .....	37 3/4 in.		

The cars are mounted on Baldwin Class 78-30 trucks, with Standard rolled steel wheels and Symington journal boxes. The braking equipment comprises Peacock hand brakes and Westinghouse schedule A M M automatic air brakes with a



wiring in a condensed form and also exhibit the sequence of the unit switch operation on various controller notches for alternating and direct current service.

The interiors of the car bodies, a view of which is presented, are lighted by thirty-five 16-candlepower lights along the deck rails and three clusters inclosed by holophane bowls. The car interiors are finished in quartered oak and have full Empire ceilings. The window construction is the Niles Car & Manufacturing Company's double Gothic Pullman type. The seats, which are of Hale & Kilburn manufacture, are up-

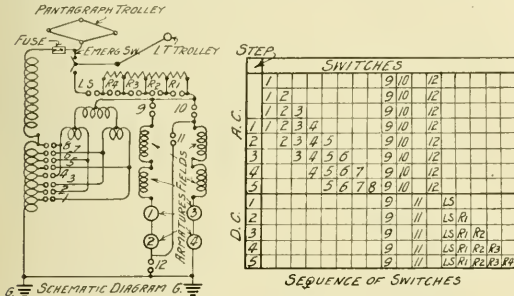

Hanover & York Railway—Diagram of Main Car Circuits and Table of Switch Sequence.

holstered in green, leather being used in the smoking compartment and plush in the main compartment. Some of the special features of these cars are as follows: Franklin heaters, Knutson retrievers, Lintern marker lights, dry hopper with cement floor in the toilet room, Sterling-Meaker registers,



Hanover & York Railway—Station Building for Road Crossing.

Providence fenders, Tomlinson automatic couplers and Lintern sand boxes and traps with National cab valves.

An interesting method is used to deliver sand from the air sanders to the rails. An iron pipe is clamped to the truck frame in front of each wheel. These pipes are connected with the bottom of the traps by coil springs of steel wire, the coils being 1 1/4 inches in diameter and having their upper ends fastened to the traps and the lower ends sliding inside of the delivery pipes. Over each coil is placed a length of canvas hose, which serves to keep the sand within the coils of the spring and assures that no matter what radius curve the car may be on the sand will be carried from the trap to

the delivery pipe, which is rigidly fastened to the truck frame.

The new line will operate cars on 1-hour headway, making the 20-mile run from the center of York to Hanover in 50 minutes, thus allowing a 10-minute layover at each end.

**NEW CONSTRUCTION OF THE STEUBENVILLE & EAST LIVERPOOL RAILWAY.**

The Steubenville & East Liverpool Railway & Light Company and the Ohio River Passenger Railway Company, which constitute extensions of the East Liverpool Traction & Light Company to Steubenville on the south and Beaver and Rochester, Pa., on the east, are putting into operation now from time to time parts of the new lines which are nearing final completion. Recently the opening of that part of the line between East Liverpool, Toronto and Steubenville was made the occasion of a celebration, in which the mayors and officials of all of the cities through which the lines pass and many prominent people took part.

The Steubenville & East Liverpool Railway & Light Company of Steubenville O., was incorporated in 1906. It purchased and has since operated the property of the Steubenville Traction & Light Company, which owned and operated the street railway system in the city of Steubenville and an interurban single-track electric railway between the cities of Steubenville and Toronto, O., a distance of 10 miles. This company also owned an electric light plant in Steubenville. The Toronto Electric Light & Power Company was also acquired. The new company has constructed a new double-track high-speed interurban railway from Toronto, which point has been the northerly terminus of the single-track interurban railroad between Toronto and Steubenville to the city of Wellsville, a distance of 7.63 miles, where connection is made with the double-track system of the East Liverpool Traction & Light Company. The new company is also now constructing a second track paralleling the present existing track between the cities of Steabenville and Toronto, and has improved and shortened the old route by taking out curves and reducing grades.

The power house at Steubenville has been entirely rebuilt and greatly enlarged by the installation of two 500-kilowatt turbo-generators, new electric lighting machinery, new switchboards, new and enlarged boilers; also by the installation of a cooling tower. The old power house of the Toronto Electric Light & Power Company at Toronto has been remodeled into a substation.

The entire track has been constructed of 85-pound A. S. C. E. T-rails in 60-foot lengths, laid on white oak ties, upon a first-class roadbed, ballasted with gravel and crushed stone. A small portion of the road is located upon the highway, but the greater part is upon private right of way.

New rolling stock purchased for the through interurban service consists of 18 cars, 42 feet long. They are finished in mahogany throughout and seat 44 passengers. The smoking compartment seats 16 passengers. The cars are painted a rich yellow and bear the legend "Ohio Valley Scenic Route" in aluminum letters bordered with black. The cars are equipped with four 60-horsepower motors, Brill trucks, electric arc headlights, electric heaters and Lintern signals.

Construction is now in progress from East Liverpool to Beaver and Rochester, Pa. At Stenbenville a track connection is made with the track of the Wheeling Traction Company, which reaches Wheeling, a distance of 21 miles to the south, and on the east it has contracts for running rights over the tracks of the Beaver Valley Traction Company, which has perfected a connection between Beaver and Pittsburg, a distance of 25 miles, except for a short distance through Sewickley.

On the north track connections will soon be made at East Liverpool with the line of the Youngstown & Ohio River Railroad and the Youngstown & Southern Railway, from

Youngstown to East Liverpool, a distance of 50 miles, which is now completed and operated within six miles of East Liverpool.

The cars will operate on a half-hour schedule, leaving Steubenville and East Liverpool on the hour and half hour.

The officers of the company are: Van Horn Ely, president; Edward McDonnell, secretary and treasurer; J. C. Rothery, general manager.

Westinghouse, Church, Kerr & Co. of New York are in charge of the construction work. The Ohio Valley Finance Company of Buffalo, N. Y., of which Hon. W. Caryl Ely is the president, has financed the construction.

**SHELTER STATIONS OF THE DULUTH STREET RAILWAY.**

BY HERBERT WARREN, GENERAL MANAGER.

The Duluth Street Railway has recently erected a number of shelter stations, as shown in the accompanying engravings, to meet the requirements at points in the residence districts where a considerable number of persons are in the habit of



Duluth Shelter Stations—Front View.

waiting for cars. The type of shelter chosen is simple, yet very practical. There are no side walls, but protection from the weather is afforded by the arrangement of the interior partitions. The shelter is divided into four equal compartments by these partition walls, which radiate from the center to the four corners. The details of the construction are shown in the engraving.

We formerly placed old car bodies in such locations, but they were unsightly from the start, and they were invariably demolished by vandals in a very short time and became a nuisance in the neighborhood. We found this to be the invariable fate of such inclosed shelters even in the best residence districts, and we had to discontinue using them.

Of late years when there has been a demand for us to set up an old car body in such a location we have replied that we would furnish the car body and bear the expense of setting it up, provided we could get someone in the neighborhood to accept a bill of sale for it at a nominal figure and become responsible for it. We made it plain to such persons that they were likely to be put to the expense of moving the car in case it was found to be a public nuisance. Some that were put up in this way fared a little better than those which we formerly took the responsibility of putting up. Vandals seem to have

a little more respect for the property of private individuals than they have for the property of corporations. However, they were in most cases treated almost as badly as when we owned them, and we gave up entirely having anything to do whatever with any inclosed shelter at such places unless conditions were such as to warrant an attendant being kept constantly in charge.

In some localities and at transfer points we have put up small inclosed buildings which are rented to be used as confectionery and cigar stands, with the understanding that they are to be kept open at all hours during which cars are passing, but such buildings are not welcomed in the best residence districts, and even if they were there would be nothing to warrant maintaining such stands in those districts.

After we had found from experience that it was absolutely impracticable to maintain any sort of inclosed shelter in the residence districts we decided to put up something that would merely break the force of the wind and keep off heavy

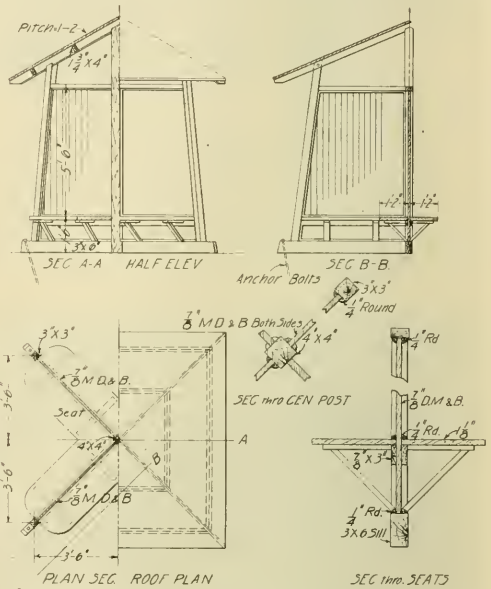

Duluth Shelter Stations—Details Showing Method of Construction.

rain, and the present shelter is the result. It does not make any pretensions of being a waiting room, but in a blizzard it is a great deal better than nothing. It is so constructed that it is not as likely to become a nuisance as if it were inclosed and it will take a small boy with a jackknife some time to whittle it down. The shelter was designed by German & Lignell, architects, of Duluth.

**Western Pacific Not to Use Electricity Immediately.**

E. T. Jeffery, president of the Western Pacific Railway, denies the recently published reports that the road would use electricity as a motive power. Mr. Jeffery is quoted as follows: "We have discussed the question of electricity for the Western Pacific from time to time for a year and a half or more, but have not yet reached any definite conclusion. The probabilities are that when we open the railroad for operation we shall have steam power, but we shall continue our studies of the uses and merits of electric power with a view to its adoption in the future."



### SIGNALS AND AUTOMATIC TRAIN STOPS IN THE HUDSON TUNNELS.

The signal equipment of the tunnels of the Hudson & Manhattan Railroad under the Hudson river between New York and Hoboken is a good example of the latest and best practice in block signaling, interlocking and automatic train stopping. When the order was placed it was specified that every known means for providing safety of train operation should be furnished and that the cost of the system was to be a secondary consideration.

The installation comprises a complete automatic block signal and automatic train stopping system, covering all tracks between Nineteenth street, Manhattan, and Hoboken. Between Hoboken and Greenwich avenue—the river section of the tunnels—signals are placed on an average of 367 feet apart. The minimum distance where speed is low is 115 feet, and the maximum is 1,620 feet. On steam railroads block signal sections average about one-half mile in length; on the express tracks of the New York subway the distance is 800 feet, or nearly seven signals per mile. In the Hudson tunnels the signal distance is only 367 feet, or more than 14 signals per mile.

The signals give three indications: Proceed, indicated by a green light; proceed with caution, a yellow light; and stop, a red light. As the consequences of a train passing a signal in the stop position may be disastrous, a device for automatically stopping such a train is used at each signal. This consists of two movable short arms or trips placed alongside each rail. When the signal is in the stop position these arms are raised to engage with the trigger of a valve in the air brake pipe of the train, releasing the air and setting the brakes. Each car is equipped with two of these valves, one on each end and on opposite sides of the car. When the signal moves again to the proceed position, the electric motor moves these train stop arms out of stop position, thus permitting the train to pass without setting the brakes, the arms being returned to stop position by gravity after the train has entered the block. This automatic method of train control is in successful use on the Boston Elevated and on the New York Subway express tracks. On these lines, however, but one automatic stop is used to protect a train. In the Hudson tunnels two stops are used, thus insuring a greater measure of protection.

The arrangement of the block section is unusual and is designed to provide a maximum of safety, together with the greatest possible train capacity. In steam railway signaling, with few exceptions, the block sections end at the home signals, no clear space being provided at each signal in case a train should accidentally overrun the home signal. In the New York subway a space is provided at each signal equal to the distance between signals—this distance being called the overlap—that is, the block sections (a space in which one train is permitted at a time) overlap each other for half their length. This is termed a double or one block section. To provide for maximum safety and maximum train capacity in the tunnels, it was found necessary to use a triple or two block overlap—that is, one block section is the length of three overlaps. Under this arrangement, if a train should stop in the tunnel, it would be protected by three stop (red) signals, four caution (yellow) signals and two automatic train stops. The overlap lengths are made long enough to permit of stopping a train at maximum speed, and include an allowance of one-third as a safety margin.

Another important feature of the system is that both rails of each track are used for the train propulsion current and also for the signal current. This permits of broken rail protection—that is, a broken track rail will interrupt the circuit and so cause the display of a stop signal and the operation of the automatic stop if the stop signal be displayed.

The block system as described fully provides for the safe

spacing of the trains. If the indication of the signals be not obeyed the automatic train stops compel obedience by setting the brakes and bringing the train to rest.

The switches are all under the control of the interlocking devices, consisting of seven plants—one at the Hoboken terminal (the largest), two at Caisson No. 1, two at Caisson No. 2, one at Greenwich avenue and one at Nineteenth street. The interlocking is the well-known all-electric system, the switches being operated by electric motors at each switch. The signals are the same type as used in the block system and are all controlled from the machines, the levers of which are so interlocked that it is only possible to make such movements as have been previously arranged for; conflicting movements are in this manner absolutely guarded against.

An interesting and novel feature of this plant is the illuminated track diagram. This is a diagram or chart of each track layout painted on glass and placed in front of each machine for the information of the operator. Each line of track has a row of small electric lamps placed back of the glass; these lamps are controlled from the different track sections; when the tracks are unoccupied the lamps remain lighted, showing a bright green light; as soon as a train enters the limits of the interlocking, the lights controlled by the track on which the train is running are extinguished, so that movement of a train along the track can be followed by observing the corresponding movement of the dark space along the track on the diagram. Without this method of indicating train movements it would be difficult for the operator to follow closely the train movements because of his field of vision being limited by the construction of the tunnels.

The system is one of the most complete that has ever been installed, the exacting requirements of operating frequent train service in the tunnels being such that the best that could be obtained was imperatively necessary.

The number of signals is 182, divided as follows: Home signals, 90; dwarf signals, 10; distant signals, 82. The number of switches is 13 and the number of automatic train stops 85.

The signal system was furnished by the General Railway Signal Company of Rochester, N. Y., and the automatic stopping system was furnished by the Kinsman Block System Company of New York.

### RENEWABLE TROLLEY WHEEL.

Trolley wheel patents of an interesting nature have just been allowed Thomas Langen, Brooklyn, N. Y. The new design is made with a view to affording a wheel of which the wearing parts may be renewed. The side discs of any trolley wheel have a much longer life than either the bottom of the groove or the bushing forming the center bearing. In Mr. Langen's type of wheel both the bushing and the groove in which the wire runs can be renewed at a small cost for labor and there also is afforded a large oil space.

When a wheel is worn in the groove until too thin for use it can be cut through on a lathe at the bottom of the groove and the sides separated. Each side can then be turned out and threaded deep enough to screw onto a short tube threaded at each end. A new grooved wearing surface in the ring form fits over the short tube and is clamped into place by screwing the side discs onto the short tube. The center bushing is forced in, leaving a large oil chamber between the bushing and the short connecting tube. For the smaller 4-inch wheels the sides can be malleable or sheet metal pressed into form and connected as described.

The increasing use of electrical means for the rapid transportation of the United States mails is shown by the statement that at the end of the last fiscal year there were 487 electric and cable routes in operation, with a length of 6,343.89 miles, and an annual travel of 11,302,534.95 miles.

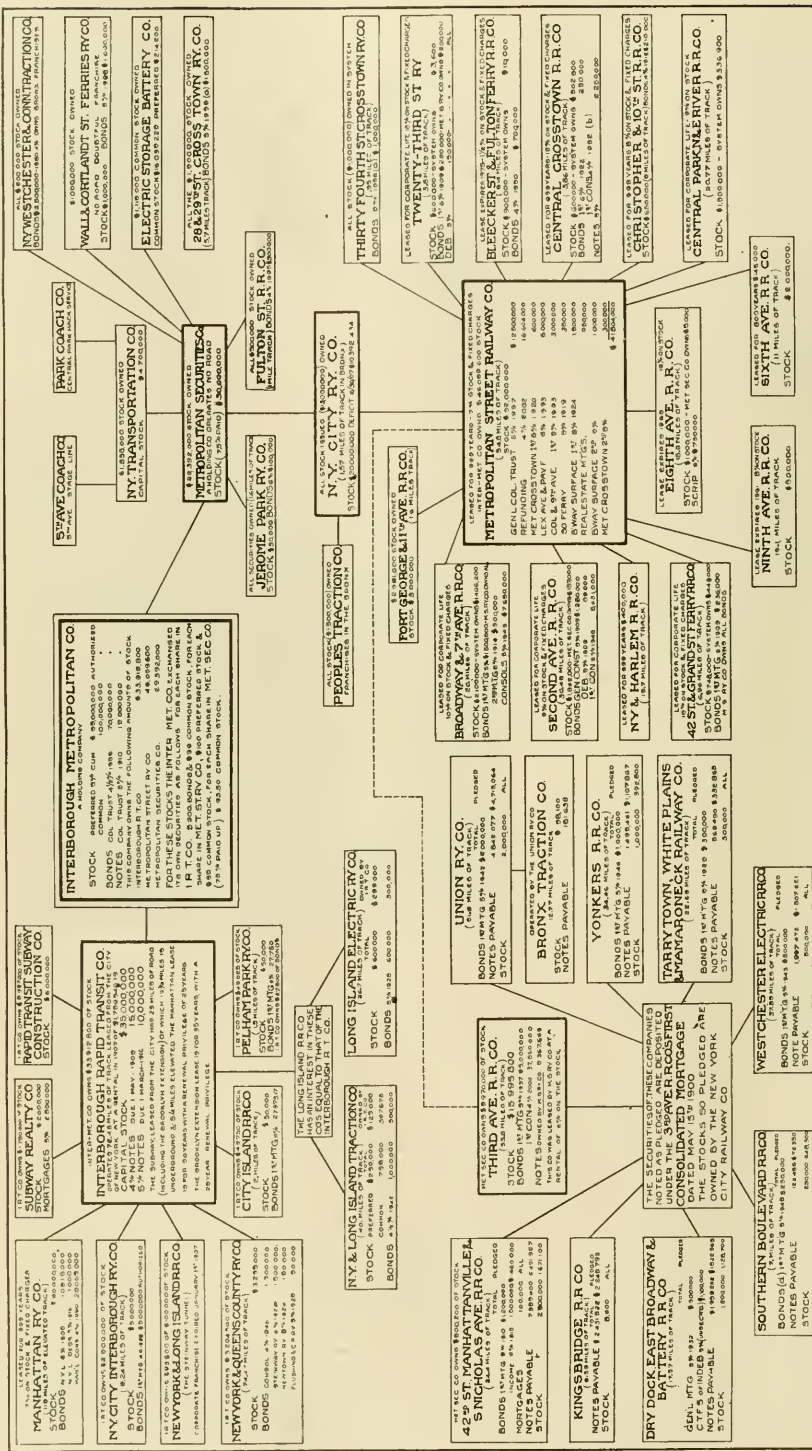

Interborough-Metropolitan System, New York—Chart Compiled by Public Service Commission, First District.

William M. Ivins, special counsel for the New York public service commission, first district, in its investigations into the Interborough-Metropolitan system, has prepared with the aid of special accountants assisting him and submitted to the commission a chart showing the interrelation and interdependence of all the corporations directly or indirectly under the control of the Interborough-Metropolitan Company including the entire elevated, surface and subway railroad system of Manhattan and the Bronx. The chart shows in sufficient detail the capitalization and funded debt of the different companies. Three large holding corporations formed the foundation upon which the Interborough-Metropolitan Company rests: The Interborough Rapid Transit Company, of the \$35,000,000 of capital stock of which the Interborough-Metropolitan Company owns \$34,059,600; the Metropolitan Street Railway Company, having \$52,000,000 of capital stock of which the Metropolitan Street Railway Company owns \$46,059,600. The Metropolitan Street Railway Company controls 14 subsidiary corporations besides the Third Avenue Railroad. Under the control of the latter are nine corporations. The Third Avenue Street Railway Company steps to have the lease held by the Metropolitan Street Railway terminated because of the interest guaranteed and it is probable that a reorganization will be effected in the near future. Controlled by the Interborough Rapid Transit Company are 10 subsidiary companies, including the Manhattan Railroad, operating 118 miles of elevated track and having a total stock capitalization of \$60,000,000, and also the New York & Long Island Railroad Company, which owns the Stehly tunnel. The Metropolitan Securities Company controls nine companies; two of these are hack lines in operation in Fifth Avenue and Central park.

### INDEX BUREAUS AN AID TO CLAIM AGENTS.

At the meeting of the executive committee of the American Street and Interurban Railway Claim Agents' Association in New York on January 30 a resolution was passed providing that a circular letter be issued to member companies, describing the operation of the local index bureaus. It is desired that many local bureaus be formed, followed by a national index bureau. The circular letter has been issued, signed by H. R. Goshorn, president of the association, Philadelphia, and B. B. Davis, secretary, Columbus, O. An abstract follows:

At present local bureaus are in operation in New York, Chicago, Philadelphia and Boston. Those in New York and Boston were organized over two years ago, and now have in their card indexes many thousands of names of claimants, lawyers and doctors. They have detected many fraudulent claimants, many "repeaters," and have saved the subscribing companies thousands of dollars. The Chicago and Philadelphia bureaus were organized recently, but they are showing good results.

No other method yet devised has been so effective in keeping track of the fakirs who prey upon corporations through claims. With a national bureau it is believed that a check can be placed upon the claimants who travel from city to city having "accidents" in preference to earning their bread by honest labor.

The method of organizing a local index bureau is simple. In the cities mentioned the number of subscribers varies. Chicago has nearly 40 subscribers, Boston has 18, Philadelphia and New York about a dozen each. The cost to the subscribers in each city is \$150 per year. Chicago, having so

instances, as many as six claims having been traced to a single house within one year.

The records of doctors are made up by the index operator. To each doctor is given a separate card upon which are given the names of claimants treated, the name of the company which reported the claim, and the company's record number, so that at a glance the record, from a claim department standpoint, of each doctor can be ascertained. The record of the lawyers is kept in the same manner, in a separate index.

In the cities where index bureaus now exist the subscribers include steam and trolley roads, electric light, telephone, gas, ice, ferry steamboat, theater, department store, manufacturing and contracting companies. The larger accident insurance and liability companies are also subscribers in each city and their records are frequently of value.

The cards inclosed with the circular are four in number. "A" is used for the alphabetical index, "B" for the street index, "C" for the index of physicians, and "D" for the attorneys' index.

### OHIO ELECTRIC RAILWAY BENEFICIAL ASSOCIATION.

The employes of the Ohio Electric Railway Company have recently organized the Ohio Electric Railway Beneficial Association, the objects of which, as stated in the constitution, are to improve the mental, moral, social and intellectual qualifications of its members; to aid and assist its members while they are disabled by reason of sickness or injuries, and at their death to provide for their families. All white male employes of the company are eligible for membership, but new employes will be required to pass a physical examination. The association now has about 1,000 members.

The association is composed of five local bodies known as chapters, located at Hamilton, Dayton, Columbus, Newark and Lima, and the administration of its affairs is delegated to a grand council, composed of the officers of the chapters, who in turn elect grand officers. The number of chapters may be increased or diminished if found desirable.

Each chapter will hold regular meetings once a month and members in good standing of one chapter may attend the meetings of any other. Members may be transferred from one chapter to another upon moving into another district.

Applications for membership are voted upon by the chapter and five blackballs are sufficient to reject an applicant. Members are required to pay \$1.00 initiation fee and dues of \$3.00 per year. Fines are imposed for failure to pay dues promptly.

In case a member in good standing resigns or is dismissed, provided he has not received any benefits, he may receive a rebate of one-fourth the money he has paid in as dues.

Any member in good standing who is sick or disabled may receive \$7.50 per week out of the funds of the association for the first 16 weeks, after which he may receive \$3.75 per week for 16 weeks, and \$2.00 per week for 16 weeks thereafter. Trustees of each chapter are to visit the sick in their chapter and report at each meeting. Medical examiners appointed by the grand council will examine applicants for sick benefits and report to the chapter whether the applicant is entitled to receive benefits. They shall also visit the sick and report upon their condition at each meeting of the chapter. Benefits will be granted only on the written certificate of the medical examiner and the trustee for the chapter. The medical examiners will also examine all candidates for membership.

Each member is required to pay \$1.00 toward a special death fund and upon the death of a member another assessment of \$1.00 per capita will be made. A sum equal to at least \$1.00 for each member of the association must at all times be held in the grand treasury as a special death fund. Upon the death of a member in good standing the sum of \$800, or, if the membership in the association is less than 800, \$1.00 for each member, shall be paid to the widow or other designated beneficiary of the deceased.

George F. McDonald of Columbus, O., is president of the association and F. L. Boyer of Dayton, O., is grand secretary-treasurer.

Name—Smith, John.	"A"	No.—33456.
Residence—Philadelphia, West Ninth street, No. 53.		
Occupation—Carpenter.		Age—31.
Date of accident—June 25, 1907.		
Physician—Dr. Thomas Jones, 1239 North Broad street.		
Attorney—John Brown, Real Estate Trust building.		
Remarks—Fracture of left tibia.		
This claim reported by Philadelphia Rapid Transit Co.		

### Index Bureaus an Aid to Claim Agents—Sample Card. (Original 5½ by 3½ inches.)

many members, has been able to reduce the cost to \$98. Each city should include in its territory all companies within a radius of about 50 miles.

In the smaller cities the radius could be increased. In some instances it will probably be found that a single bureau can be operated so as to include the whole state. If this should be found to be impracticable any member company of our association can receive the benefits of the proposed plan by establishing an index of its own. The plan will be found to be well worth the small trouble and expense involved. Should the national bureau prove a success it is expected that the cost will be so trifling that no company, however small, need hesitate to secure the benefits of membership.

It is particularly requested that all local bureaus adopt the exact size of the sample cards [5½ by 3½ inches] and the same general form of printing, so that a uniform system can be put into operation at the proper time. These cards are standard size and can be furnished by any card index manufacturing company.

The local index bureau consists of a series of card indexes in which are kept names and addresses of claimants, lawyers and doctors, who figure in suits or claims for damages against the subscribing companies. One operator can easily conduct the bureau. He, or she, receives the cards sent in daily or weekly by subscribing companies and files them. If a repeater is found the matter is promptly reported by the operator to the companies which have sent in the suspected name. Each company is advised of the claim against the other and the companies at once compare notes. Even if the claims are not fraudulent the value of this information will be apparent to everyone who has had experience in claim work. In many other ways the value of the index bureau has been proven to far exceed the cost wherever it has been established.

In the larger cities a separate index is kept of the streets and house numbers, the cards being duplicates of those first mentioned. By means of this index it is possible to keep a reliable record of the number of claims made for each house. The value of this information has been shown in a number of

**MILK TRAFFIC ON THE AURORA ELGIN & CHICAGO RAILROAD.**

The Aurora Elgin & Chicago Railroad is the only electric railway which carries milk into Chicago. In developing its milk business this road has had as competitors four steam roads. While statistics are not at hand showing the total number of cans of milk carried since the practice of running trains each day especially for this traffic was first started. fig-

price of milk by producers to dealers, and a consequent advance in prices by retail dealers to consumers in Chicago. The following figures show the number of 8-gallon cans carried per month, with the daily average:

	Total.	Daily av'ge.		Daily av'ge.
October, 1905...	6,514	210	February, 1907...	12,447
October, 1906...	11,444	369	March, 1906....	9,545
October, 1907...	14,268	460	March, 1907....	14,620
November, 1905.	7,417	247	April, 1906.....	10,098

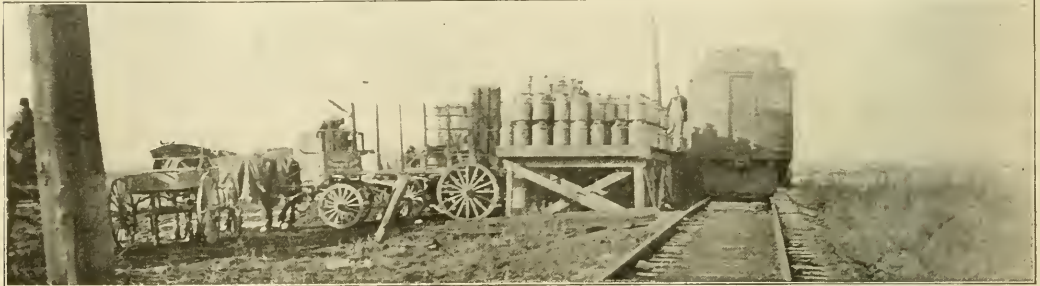

Milk Traffic on the Aurora Elgin & Chicago Railroad—End View of Chicago Receiving Platform.

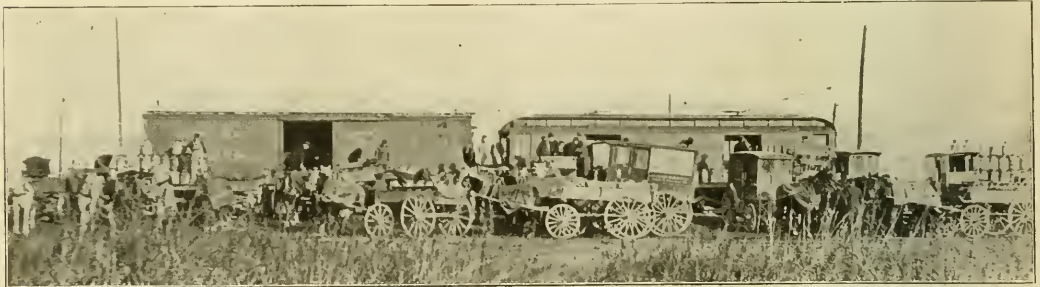

Milk Traffic on the Aurora Elgin & Chicago Railroad—Delivering Milk from Train of Motor Car and Box Trailer.

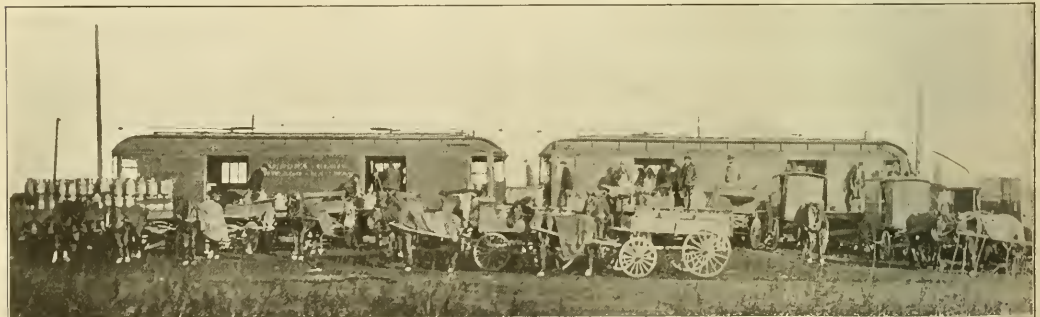

Milk Traffic on the Aurora Elgin & Chicago Railroad—Delivering Milk from Train of Two Motor Cars.

ures showing recent changes in the business can be given. During October, 1905, the first month for which complete figures can be shown, the total number of cans carried was 6,514, a daily average of 210 cans. In June, 1907, a total of 16,828 cans was handled or an average per day of 561 cans, making the largest monthly milk traffic in the history of the company. As June, owing to natural causes, is the month of greatest production of milk, the business has declined since that time, owing to the decline in production, but there has also been a reduction in the consumption on account of an increase in the

November, 1906...	10,278	343	April, 1907....	14,486	483
November, 1907...	13,482	449	May, 1906.....	13,467	434
December, 1905.	8,631	278	May, 1907.....	16,498	532
December, 1906...	11,725	378	June, 1907....	16,828	561
December, 1907...	14,524	468	July, 1907....	16,721	537
January, 1906...	9,010	290	August, 1907...	15,577	502
January, 1907...	13,082	422	September, 1906	12,164	405
February, 1906..	8,168	292	September, 1907	14,328	478

The milk carried into Chicago is collected by two trains, which leave the car house at Wheaton at 6 o'clock every morning for Batavia and Wayne, which are on different branches.

The trains return to Wheaton, collecting cans of milk at platforms located at the principal road crossings. When the cars reach Wheaton they are combined into one train and the trip is made from there to Fifty-second avenue, Chicago. It is at this point that the line of the Aurora Elgin & Chicago road connects with the elevated structure of the Metropolitan West Side Elevated Railway, over which it secures entrance to the business district of Chicago. The companies have not the right, however, to carry milk into the center of the business district. If this right could be secured the business could be multiplied largely. At the Fifty-second avenue station a switch track and a large wooden platform have been provided.

**THE AURORA ELGIN & CHICAGO R.R. CO.**

Good for Transportation of One

**8 Gallon Can of Milk**  
FROM ANY MILK STATION TO  
FiftySecondAve.(Chicago)

Subject to Instructions on the other side.  
Form 101

*J. J. Hoff*  
President

**INSTRUCTIONS.**

Agents will require of all parties shipping milk that they attach a ticket to each can before placing upon depot platform or in the car.

Conductors must not receive a can of milk into their train unless a ticket is attached to the can by means of the eyelet hole.

The ticket must in all cases be torn off and punched by Conductors and sent to the Auditor with other ticket collections.

Agents and Conductors will be particular to see that the capacity of the can is not greater than is represented by the ticket attached.

**Milk Traffic on the Aurora Elgin & Chicago Railroad—Sample of Ticket.**

erated to the Fifty-second avenue terminal and returning the empty can is 15 cents. Each can is supposed to have a ticket affixed when it is put on the car. This ticket is taken up by the conductor and is turned in with his report. Five men are employed on a 2-car train, the motorman, conductor and three helpers.

The foregoing information has been supplied by Richard Breckinridge, traffic agent of the Aurora Elgin & Chicago road.

**FLANGE AND GEAR WEAR RECORDS.**

In an electric railway repair shop it frequently becomes desirable for the head of the department to make permanent records of the contour of various wearing parts. When, for



Baltimore Shops—Plaster of Paris Impressions from Wheels and Gears.

instance, gear wheels or various makes of chilled iron or steel car wheels are being used with a view to determining their comparative wearing qualities, some form of accurate record taken during the service of the wheel or gear may become very important at a later date. H. H. Adams, superintendent of shops United Railways & Electric Company, Baltimore, obtains accurate and permanent records of the wear of wheel treads and flanges and gear teeth by making from time to

time plaster of paris impressions. A number of such casts are illustrated in the accompanying halftones. It will be noted that these casts were taken part from wheel treads and flanges and part from gear wheels. The great variety of uses to which this simple method of obtaining permanent records of wearing parts can be put should commend it as a useful shop kink.

**LIFE GUARD TESTED BY CHICAGO CITY RAILWAY.**

The Chicago City Railway, in conjunction with the board of supervising engineers of Chicago traction and the city transportation officials, on February 1 made tests of a new type of life guard, 200 of which it is proposed to put into



Chicago City Railway—Front of Car, Showing New Life Guard.

experimental service on 100 cars of the Chicago City Railway. As shown in the accompanying illustration, the life guard comprises a heavy wooden plank set under the car platform at an angle of 45 degrees with the rails. This plank is of oak, 2 inches thick, 12 inches high, and of such a length that it extends in its diagonal position from one edge of the car body to the other.

Contrary to the usual practice in the construction of such life guards this guard does not have a plow shape, but extends in a straight line from one side of the car to the other. The board comprising the life guard is supported on iron brackets bolted to the sills of the platform. The connection between the brackets and board is such that the life guard has vertical play up and down the brackets. Normally the bottom of the guard is 2½ inches above the rails, but bolted to the back of the guard are trailing iron wheels which will serve to raise it off the pavement when a car passes over a vertical curve at a subway or any other point where there is excessive break in the grade.

The lower edge of the guard board carries a cushion which comprises a strip of rubber belting on which is fastened a section of 2-inch rubber hose. The simplicity of this guard and its location entirely under the platform of the car are desirable features. In the tests earlier mentioned a dummy was hit a large number of times and in each instance was rolled to the side of the track, out of the way of the wheels.

The Portland (Ore.) Railway Light & Power Company has instructed its motormen on the city lines in Portland to stop on the near side of street crossings within the city where there are railway intersections. Heretofore motormen have had instructions to stop on both sides of such streets.

### ELECTRICAL EQUIPMENT OF THE RICHMOND & CHESAPEAKE BAY RAILWAY.

The Richmond & Chesapeake Bay Railway exhibits several novel features in connection with its single-phase electrical equipment. The construction features of the track and roadway were described in the Electric Railway Review for October 19, 1907, page 666.

The railway company has at present no power station of its own, but the generating apparatus is installed in the



Richmond & Chesapeake Bay Railway—Catenary Construction at Turnout.

Twelfth street power house of the Virginia Passenger & Power Company. This equipment is of special interest, owing to the manner in which provision is made for securing operation under varying conditions at the power house. The generating apparatus consists of two 750-kilowatt 25-cycle three-phase

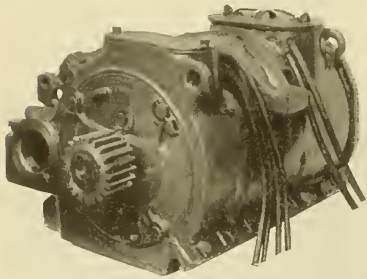

Richmond & Chesapeake Bay Railway—Exterior of Single-Phase Motor.

generators running at 128.5 revolutions per minute and designed to supply current at 6,600 and 13,200 volts.

One of these generators is direct connected to a 1,450-horsepower hydraulic turbine at one end of the shaft and to a 750-kilowatt 60-cycle 2300-volt three-phase generator at the other end, both of the units being mounted on a common base. Should there be insufficient water to operate the turbine, the 60-cycle generator will be run as a motor. The other 25-cycle machine is coupled to a water turbine, and also to a 750-kilowatt direct-current generator, the latter machine being used as a motor in the event of low water. From the above it will

be seen that when water power is plentiful the 60-cycle generator and the direct-current generator can be used for city lighting. Under the present operating conditions only one phase of the generators is used to supply the line voltage of 6,600 volts.

The electrical equipment of each of the four motor cars which at present comprise the rolling stock consists of four G. E. A-603-A railway motors, and a full complement of multiple-unit type M Sprague-General Electric control apparatus.

The motors are of the latest pattern, known as the series-repulsion type. These motors have excellent commutating qualities, which have been secured by what is known as the fractional pitch winding of the armatures. This winding performs the same function as do commutating poles in direct-current motors. Each motor has a capacity of 125 horsepower. The capacity and high starting torque of these motors was well illustrated on one of the trial trips. On this occasion one car was coupled to a train of five Norfolk & Western standard railway passenger coaches, carrying 300 passengers, and hauled the load with ease. To further test their capacity, two of the motors were cut out and the remaining two started this same train on a 1 per cent grade.

Each pair of motors with a compensator and contactors forms a practically independent equipment. This feature has the advantage that should one motor or any part of one-half of the equipment become damaged, the car can then be operated as a 2-motor equipment by throwing one blade of a double-knife disconnecting switch. The actual control apparatus is practically standard throughout. These are the first General Electric equipments ever put in operation with two compensators. The compensators are oil-cooled and are provided with taps to give 600, 450, 400, 340, 280 and 113 volts. The 600-volt taps are used only on the auxiliary circuits.

Each car is equipped with two trolleys of the pantograph type. The trolleys are constructed with steel pans, this material having been found to give greater satisfaction than either copper or aluminum.

The car bodies were built by the St. Louis Car Company and resemble very closely the standard Pullman car as used in steam road service. Each car has separate accommodations for white and colored people. The combination passenger and smoking car has a seating capacity of 64 persons.



Richmond & Chesapeake Bay Railway—Fully Equipped Motor Car.

The seating capacity of the combination passenger and baggage car is slightly less.

The overhead construction is of the catenary suspended type, the trolley itself being of No. 0000 grooved copper wire. The messenger cable is of steel and has seven strands. On the first section of the road between the Richmond depot and the car barns the track is laid on a reinforced concrete viaduct, the trolley being supported by a system of steel spans. Bracket supports are used on the other sections of the road. The Ohio Brass Company supplied a large portion of the catenary material.

The substation at the Ashland terminus is unique, inasmuch as its function is to provide for the lighting of the town from the high-tension single-phase trolley. This is probably the first time that an attempt has been made to supply a lighting system from a high-tension single-phase trolley subjected to severe load fluctuations, and the satisfactory results that have been attained speak well for the design of the regulating apparatus in both the substation and main station. The Tirrill regulators in both the substation and the power house give close voltage regulation.

At the substation the 6,600-volt single-phase current is transformed to 440 volts by two 25-cycle oil-cooled transformers of 150-kilowatt capacity each. From the low-tension side the current passes through a reactance or phase-splitting device to the induction motor end of a motor-generator set, consisting of a 150-horsepower 25-cycle 440-volt single-phase induction motor direct connected to a 100-kilowatt 2,300-volt 60-cycle single-phase generator. A 4-kilowatt 125-volt exciter is mounted on the common shaft at the generator end. The 2,300-volt 60-cycle current leaves the substation through a 2-circuit single-phase feeder panel for general lighting purposes in the town of Ashland. All the electrical machinery, switchboards, indicating and measuring instruments for the new road are of General Electric manufacture.

**RESULTS WITH NEW TRANSFERS AT BALTIMORE.**

Last year on April 1 the United Railways & Electric Company of Baltimore changed its form of transfer. Previous to

interpretation of transfers disappeared, inasmuch as this form of transfer shows so accurately the time it is used, it is necessary to order them very carefully so that the supply may closely approximate the demand. To provide against any emergency when more transfers will be required than have been prepared for any particular half day a so-called "calendar" transfer is kept in stock. It will be noted from the illustration that this transfer must be punched for the indication of the day and month; otherwise it has the same general arrangement as the transfer regularly used, which bears the full statement of the date in large type printed in red ink along the center. Careful examination of this form of transfer will show its especial completeness. All the junction points are shown and the direction in which a passenger may transfer at any one of the junction points is also very clearly indicated.

As an index of the former misuse of transfers before the new kind exhibiting the year was put into practice, it is related that on April 2, the day after the new transfers were distributed, the president of the company received several anonymous letters, some inclosing as many as 1,000 old transfers. It seems that owing to the absence of the year being indicated on the old forms of transfers many persons had been collecting transfers, saving them for a year and dealing in them. The following is a sample letter which came wrapped around a package of about 100 of the old transfers. The letter reads as follows:

Baltimore, April 1, 1907.

Mr. William A. House, United R. W. Co.

Dear Sir:—To my best friends, "good by." United, why did you do it? I will have another system to beat them—the conductors.

Yours, etc.,  
"TRANSFER."

Believing that the advertising space on the back of the transfers is as valuable to the company as a means of publicity as it would be to any purchaser, the transportation department each month has the space on the back of the transfers occupied by some of its own advertising; for example, trolley trips, how to get on and off cars, or as shown in an accompanying illustration.

**DEPRECIATION NOT TO BE DISCUSSED IN REPLIES TO ACCOUNTING CIRCULAR.**

The following notice has been issued by Prof. Henry C. Adams, in charge of statistics and accounts, interstate commerce commission, in relation to Circular No. 20 of the Accounting Series, an abstract of which was published in last week's issue of the Electric Railway Review:

This notice is to supply a statement that should have been contained in accounting series, Circular No. 20, so far as it refers to the tentative classification of operating expenses. That classification makes a provision, among its primary accounts; for depreciation accounts, but it should be understood that, according to an agreement entered into at a general meeting of the representatives of the electric lines and the federal and state railway commissions held in Washington on December 17 and 18, 1907, the question of depreciation need not be discussed in the replies submitted to accounting series, Circular No. 20, for the reason that a special committee of the representatives of electric lines has been appointed for the consideration of that question.

In Circular No. 20 it was stated that replies were desired in duplicate, one copy to be addressed to Professor Adams, B. V. Swenson, secretary of the American Street and Interurban Railway Association, New York, asks the Electric Railway Review to publish a notice requesting companies to send the duplicates of their replies to the New York office of the association instead of to Birmingham, Ala., as stated in the circular. Mr. Swenson suggests, in a letter to the general managers and auditors of street and interurban railways, that, pending the discussion of depreciation by the special committee, there be sent to him, as secretary of the association, any data or information which would be of use to the committee in informing itself on the subject.



Baltimore Transfers—"Calendar" for Emergency Use.

that time the transfers used did not show the year. The old transfers also required five punches by the conductor, while

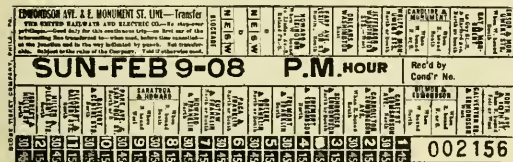

Baltimore Transfers—New Form for Regular Use.

the new form of transfer, illustrated herewith, requires but two punches, one showing the junction point and the other

**CONSUMPTION IN EARLY STAGES CAN BE CURED IF TAKEN IN TIME**

DO NOT NEGLECT COUGH OR SUCH PNEUMONIC SYMPTOMS AS SLIGHT COUGH, FEVER, NIGHT SWEATS, LOSS OF WEIGHT, BUT CONSULT A GOOD PHYSICIAN

<b>CONSUMPTION IS CONTRACTED THROUGH THE SPIT OF CONSUMPTIVES</b>	<b>FRIENDS OF CONSUMPTION DAMPNESS DARKNESS DRINK</b>	<b>ENEMIES OF CONSUMPTION SUN - CLEANLINESS FRESH AIR - ADDRESSING FOOD</b>
---	---	---

**CAUTION** (A QUINCE OR PREVENTION IS WORTH A POUND OF CURB—NO WATER KICKED UP—THEY ARE THE ONLY ONES WHO DO NOT ENHANCE THE HEALTH OF FRIENDS AND FAMILY BY CESS SPLITTING.)

Baltimore Transfers—Advertising on Reverse Side.

the time. It will be noted that the new transfer also exhibits very plainly the day, year, date and "a. m." and "p. m."

With the change in the form of transfer a large percentage of the damage claims arising from the misuse and mis-

RESULTS FROM ELECTRIFICATION OF THE NEW YORK CENTRAL.

The Journal of the American Society of Civil Engineers, February, 1908, Vol. XXXIV, No. 2, pages 68-98, contains a paper by W. J. Wilgus on "The Electrification of the Suburban Zone of the New York Central & Hudson River Railroad in the Vicinity of New York City," which is to be presented before the society on March 18. The author discusses at considerable length the reasons which determined the character of the installation and describes the physical features of the improvement. During the past few years the Electric Railway Review has presented a number of articles bearing on the electrification problems of the New York Central terminals, among which are a description of the electric locomotive and an account of its trial run on November 20, 1904, page 909, and the signal system for the electrical zones of the New York Central on June 15, 1906, page 354. Inasmuch as the construction features within the electrical zone have been so thoroughly described and illustrated by the technical press, the present interest lies in the statement which Mr. Wilgus makes concerning the operating results attained. An abstract of this statement follows:

The principal reasons for undertaking the work were twofold: (1) Demand of the public for the abolition of the nuisances incident to the use of steam locomotives south of

- (a) Cost and quantity of coal and water at the power station, and on the steam locomotive tender.
  - (b) Relation of ton mileage of the motive power to total ton mileage, including motive power and cars.
  - (c) Frequency and volume of traffic.
  - (d) Mechanical and electrical design of motive power as affecting repairs, and hours available for active service.
  - (e) Fixed charges, depreciation and maintenance on all items of both kinds of service, that have a bearing on comparative results, including land, structures and equipment.
- In other words, to obtain a true comparison observations must be made under like conditions in a known service.

With this object in view, a typical steam switching locomotive, engaged in terminal service, and a steam passenger locomotive, assigned to road service, were each selected for observation in the same class of traffic with electric locomotives. The terminal service embraced switching at the Grand Central yard, and hauling dead cars to and from Mott Haven storage yard, a distance of six miles. The road service comprised the hauling of schedule trains by the electric locomotive between the Grand Central terminal and Wakefield, 12½ miles; and the same trains by steam between Wakefield and North White Plains, 11½ miles.

Observers constantly rode the locomotives for the period of the tests, namely, September 12 to 27, 1907, in terminal service, and October 4 to 18, 1907, in road service. Cyclometers and wattmeters registered actual distances, speeds and current consumption. Record was also kept of the number of cars switched and hauled, and the proportion of time each day engaged in actual service, awaiting duty, and laid up for inspection and repairs.

The coal used contained 14,000 British thermal units per

SUBJECT.	STEAM.			ELECTRIC.		
	Description.	Amount per annum.	Per day.	Description.	Amount per annum.	Per day.
Interest .....	4½% on \$15 000 .....	\$637.50		4½% on \$30 000 .....	\$1 275	
Depreciation .....	3% on \$15 000 .....	750.00		5% on \$30 000 .....	1 500	
Repairs .....	General at West Albany .....	\$1 170		General at Harmon .....	\$468	
	Running at Mott Haven .....	414		Running at High Bridge and Wakefield .....	106	
	Trips to shops, 300 miles .....	168		Trips to shops, 60 miles .....	34	
	Use of shops .....	90	1 842.00	Use of shops .....	38	704
	Total for 335 days available for service .....	\$3 229.50	\$9.64	Total for 350 days available for service .....	\$3 479	\$9.94
Handling and inspection, including fixed charges and maintenance of land and structures .....	Mott Haven engine-house plant, 365 days .....	1 231.00	3.37	High Bridge and Wakefield inspection sheds, 365 days .....	200	0.55
Total .....		\$4 460.50	\$13.01		\$3 679	\$10.49

The saving in favor of the electric locomotive, therefore, is \$2.52 per day, equal to 19 per cent.

Results from Electrification of New York Central—Table 1—Comparison of Costs per Day of Available Service.

the Harlem river; and (2) need for increased capacity of the terminal, by the elimination of a large proportion of the switching movements required with steam locomotive practice; and relief to the main line entrance to the terminal by reducing its use for haulage of dead locomotives and cars to Mott Haven. As secondary considerations there were: (3) The possibility of sufficient economy in operation at least to offset largely the additional fixed charges on the cost of the electrical installation; and (4) opportunities for an ultimate large increase in traffic and corresponding growth of revenue to justify the expenditure for all improvements within the suburban zone.

The first two expectations have been completely realized. The atmospheric conditions in the Park avenue tunnel show marked improvement, even with the presence of the remaining New Haven company's steam service. The effect on the operating efficiency of the terminal has been very gratifying, the increased capacity being estimated at one-third. There has also been a large reduction in the number of shop or "dead" trains to and from Mott Haven.

Reduced Cost of Operation.

The results, as regards the third expectation, have been most surprising. The operation, for a considerable period, of steam and electric equipment side by side has afforded an unexampled opportunity for a true comparison of costs of operation. Until now data on this subject have been based on theory, ignoring many of the indeterminate features of actual operation that have such a weighty effect on costs. For instance, among the variables entering into an analysis of this character are:

the cost, per ton of 2,240 pounds, was: Steam locomotive in terminal service (anthracite) \$5.00 per ton Steam locomotive in road service (bituminous) 3.50 per ton Port Morris power station (bituminous) 3.05 per ton

Water, per 1,000 gallons, cost as follows:

Terminal service and at power station..... 13½ cents Road service ..... 5 cents

The cost of electric current, when the power station designed load is attained, is taken at 2.6 cents per kilowatt-hour, delivered at the contact shoes of the equipment, and includes all operating and maintenance costs, interest on the electrical investment required to produce and deliver the current, depreciation, taxes, insurance and transmission losses. The details of this cost in cents per kilowatt-hour are:

Items—	Operating costs.	Fixed charges.	Total.
Power station .....	0.58	0.44	1.02
Transmission losses .....	0.19	0.15	0.34
Distributing system and substations.....	0.32	0.92	1.24
Totals .....	1.09	1.51	2.60

Locomotive wages are practically identical for each class of service.

Table 1 shows the details of locomotive repairs, maintenance and fixed charges for each class of service, from which it will be noted that, although the fixed charges and depreciation of the electric locomotive are higher than those of the steam, owing to the greater first cost, the net result is in favor of the electric locomotive, due to lower costs for repairs and maintenance. These results are based on actual observa-



tions of the steam locomotive covering a period of several years; and of the electric locomotive for two years on the experimental track near Schenectady and one year in the New York zone. The reasons for the lower cost of repairs on the electric machine are the simplicity of construction and the minimum number of mechanical parts. It is also worthy of comment that the electric locomotive costs very much less per day for repairs and maintenance, due to lower expenses for land and structures, and fewer days out of service. For instance, the fixed charges and cost of maintenance and operation of the extensive steam engine plant on costly land, are comparable with the simple inspection shed charges of the electric locomotive.

The Schenectady experiments indicated that the cost of repairs of the electric locomotive of this type is about two-fifths of that of the steam locomotive of a corresponding age and capacity.

The results of these observations are summarized in Table 3. They show that, under the stated conditions, the electric locomotive has the following advantages over its steam rival: Saving in locomotive repairs and fixed charges. . . . 19 per cent Saving in dead time for repairs and inspection. . . . 18 per cent

pletion of the various other improvements afford an opportunity for increase in frequency and speed of train service; for the production of revenue from various sources at the terminal; and for the expansion of business that is sure to follow the enlargement of the facilities of the company throughout the suburban zone, not only as regards the local service, but in an even larger degree from long-haul freight and passenger traffic.

Several years will be consumed in the gradual rounding out of the work as a whole; but it is gratifying to have this early indication of the success of the undertaking from both the engineering and financial standpoints.

Apart from these results it is interesting to note the conclusions, suited to this particular problem, that may be drawn from a study of the various observations.

Equipment designed for the electric system over which it is to operate offers economies so superior as to overshadow any other advantages that may be claimed for a kind of equipment that can be operated over several systems. [In the early part of his paper Mr. Wilgus states that the direct-current (New York Central) locomotives require from 15 to 25 per cent less current than do the alternating-current (New

Kind of locomotive.	Miles per day.	Cars per day.	Busy hours per day	Hours ready for duty daily.	Percentage of time dead.	Total ton-miles daily	Car ton-miles daily.	Percentage of car ton-miles to total	Car ton-miles per busy hour.	Coal or current per car ton-mile.	Total cost per car, in cents.	Speed and stops.			Cost per 1 000 car ton-miles.				Watt-hours required to do work of 1 lb. coal.	
												Average miles per hour.	Miles per hour.	Stops.	Supplies.	Wages.	Interest, depreciation, and repairs on locomotives.	Total.		
<b>SWITCHING SERVICE—GRAND CENTRAL TERMINAL.†</b>																				
Steam	10.91	55	+ 1.83	16 16	+ 0.52	2 580	916	0.35	501	3.36 lb. coal, 264 watt-hr.	35.2					\$8.06	\$5.34	\$7.61	\$21.01	79
Electric	11.13	53	+ 2.01	+ 6.80	+ 0.36	1 980	914	0.46	115		28.5					6.88	5.25	4.40	16.53	
Advantages in favor of electric locomotives	0.22		+ 0.18	+ 0.64	+ 0.26			0.11			6.7					1.18	0.09	3.21	4.48	
<b>HAULING TO AND FROM MOTT HAVEN.†</b>																				
Steam	40.0	45	+ 3.36	+ 5.18	+ 0.53	16 540	11 730	0.71	3 490	0.46 lb. coal, 44.3 watt-hr.	51.6	11.9	48	0.9	1.12	0.35	0.52	1.99	96	
Electric	78.4	95	+ 6.41	+ 10.42	+ 0.30	30 370	23 810	0.77	3 640		43.2	12.3	45	2.0	1.16	0.31	0.28	1.75		
Advantages in favor of electric locomotives	38.4	50	+ 3.05	+ 5.24	+ 0.23	13 830	11 590	0.66	150		8.4	0.4	3	1.1			0.24	0.24		
<b>ROAD SERVICE.*</b>																				
Steam	74.04	28	3.72	+ 11.11	+ 0.54	25 620	12 660	0.49	3 400	1.22 lb. coal, 52.3 watt hr.	135.0	19.9	60	8.6	2.03	0.28	0.46	2.77	43	
Electric	136.22	43	5.34	+ 13.70	+ 0.43	33 210	21 510	0.65	4 030		109.0	23.6	55	2.9	1.37	0.31	0.34	2.02		
Advantages in favor of electric locomotives	52.18	15	1.62	+ 2.59	+ 0.09	7 590	8 850	0.16	630		29.0	3.7	5	..	0.66		0.12	0.75		

\* Portion of time of locomotives engaged in other service not shown in this table. † Switching and hauling done by same locomotives. ‡ Total time of locomotives in all classes of service.

Results from Electrification of New York Central—Table 3—Summary of Comparative Tests.

Greater daily ton mileage. . . . . 25 per cent  
 Saving in locomotive ton mileage in hauling service. 6 per cent  
 Saving in locomotive ton mileage in switching service. . . . . 11 per cent  
 Saving in locomotive ton mileage in road service. . . 16 per cent  
 Net saving in cost in hauling service. . . . . 12 per cent  
 Net saving in cost in switching service. . . . . 21 per cent  
 Net saving in cost in road service. . . . . 27 per cent

Even better results may be expected during winter months, when steam locomotives are subjected to many conditions that cause additional expenses not incident to the electric locomotive.

Owing to the partial use of steam switching locomotives and the presence of the New Haven company's steam road locomotives at the terminal, the full benefits of change of motive power have not yet been secured. However, on the same wage basis for 1907 as for 1906, the month of August, 1907, showed a decrease in cost of terminal locomotive and yard operation of nearly \$3,000, although the number of cars in and out increased from 64,984 to 68,519. In other words, the cost of operation decreased 9 per cent while the work done increased 5 1/2 per cent, which is equivalent to a net saving of 13 1/2 per cent.

As to the fourth expectation—increased revenue from a larger volume of business—no definite conclusions can be reached until the extension of electrical service and the com-

pletion of the various other improvements afford an opportunity for increase in frequency and speed of train service; for the production of revenue from various sources at the terminal; and for the expansion of business that is sure to follow the enlargement of the facilities of the company throughout the suburban zone, not only as regards the local service, but in an even larger degree from long-haul freight and passenger traffic.

Several years will be consumed in the gradual rounding out of the work as a whole; but it is gratifying to have this early indication of the success of the undertaking from both the engineering and financial standpoints.

Apart from these results it is interesting to note the conclusions, suited to this particular problem, that may be drawn from a study of the various observations.

Equipment designed for the electric system over which it is to operate offers economies so superior as to overshadow any other advantages that may be claimed for a kind of equipment that can be operated over several systems. [In the early part of his paper Mr. Wilgus states that the direct-current (New York Central) locomotives require from 15 to 25 per cent less current than do the alternating-current (New

Haven) locomotives operating on direct current in the New York Central electric zone.]

In switching service the economy of electric traction lies in savings for supplies and in lower unit fixed charges and repairs, due to less lost time for repairs and care.

In slow-speed hauling the advantage lies in the lower unit fixed charges and repairs of the electric locomotive, due to its ability to do more work while busy, and to less lost time for repairs and care.

High-speed road service shows advantages for electric traction in all three items: supplies, wages and fixed charges and repairs. The small, 18 per cent, increase in current consumption for the greater speed of road service, as compared with hauling service, is in marked contrast to the 165 per cent increase in coal consumption for steam traction.

Opportunities for large economies lie in the thorough training of motormen in the manipulation of their controllers, a very simple problem as compared with the difficulties of teaching both the enginemen and firemen on steam locomotives to perform their duties so as to result in fuel economy.

It is yet too early to express in dollars the comparative effect of steam and electric traction on the cost of maintaining and renewing tracks and structures. Repeated systematic inquiries of all foremen in charge of electric zone track maintenance, and of the motormen operating electrical equipment, have brought out the practically unanimous opinion that the

effect of electric locomotives, apart from slightly greater wear on switches, does not differ from steam motive power, on either line or surface of tracks, but that the former has better riding qualities. The superiority of electric traction is manifest, of course, in the cessation of costly corrosive action of locomotive gas on metallic structures, and the freedom from cinders which, with the steam locomotive, cause heavy maintenance costs for cleaning, rock ballast and pointing brick tunnel arches.

**SECTIONAL HOSE BRIDGE—PHILADELPHIA RAPID TRANSIT COMPANY.**

Through the courtesy of the Philadelphia Rapid Transit Company we present the accompanying illustrations and description of a sectional hose bridge that includes features

for four more lines of smaller hose. Probably the most valuable feature of this bridge is the facility with which a line of hose can be changed by lifting out the top part of the center section of the bridge rails.

The Philadelphia Rapid Transit Company has seven emergency wagon houses and the wagons at each house are provided with these bridges. Each quarter of a bridge has all its parts painted a color differing distinctly from each of the other three quarters, so that when a bridge is being put together on the street no time is lost in picking out the various mating parts. For carrying these bridges slings are provided which can be hooked under the body of the trolley wagon when it is desired to take a bridge from the emergency house to the scene of a fire. The approxi-

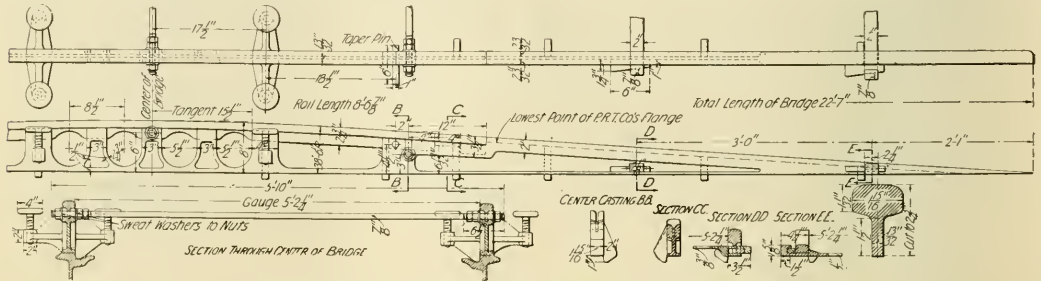

Philadelphia Rapid Transit Hose Bridge—Details of Construction.

of interesting design. Reference to the line engraving will show that the bridge has a total length of 22 feet 7 inches with a rise at the center of eight inches. The resulting incline is so slight that a car can easily pass over the bridge, even though the condition of the rails may be exceptionally bad.

Structurally, the bridge comprises a cast sectional frame with two incline points for each rail, and a center top rail

mate weights of the various parts are as follows: Manganese steel points, 150 pounds each; malleable iron centers, 150 pounds each; center sections of rail head, 75 pounds each.

An accompanying illustration shows one of these bridges in actual service during a fire in the business district of Philadelphia. The time required for loading one of these bridges on a trolley wagon, getting out of the emergency houses, unloading the bridge and setting it up ready for the

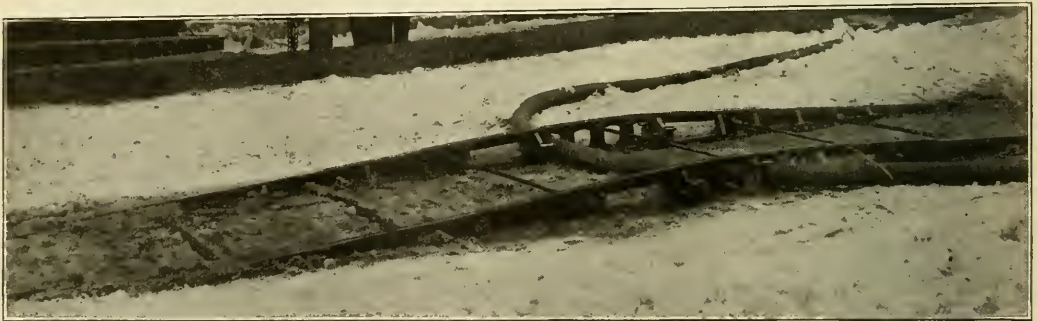

Philadelphia Rapid Transit Hose Bridge—View When in Service.

which can be lifted out of its seats in the malleable iron framework so that a line of hose may be inserted or taken away with the least possible hindrance to passing cars. The points of the bridge are cast of manganese steel and the center framework is of malleable iron. Outriders with adjusting screws are provided for each side of the bridge so that the temporary structure may be given a wide bearing on the pavement adjoining the running rail. The two halves of the bridge are joined by seven tie rods. The three center rods are provided with adjusting nuts and the two tie rods at each end are fastened to the opposite sides of the bridge by means of wedges driven to place. The bridge will accommodate four lines of 5-inch hose and space is also available

passage of a car, not including the time required for driving, is 4 1/2 to 5 minutes only.

The Illinois Traction Company is installing telephone booths at each siding on the Springfield-Decatur line to replace the jack-boxes which have been used heretofore. The booths will be equipped with telephones and electric lights, so arranged that opening the door of the booth automatically cuts the instrument into circuit and lights the lamp, while closing the door reverses the process. These booths have already been installed on the Lincoln-Springfield and Champaign-Decatur lines, and will be installed on the Decatur-Bloomington line.

PIPING A LUBRICATOR TO SAVE OIL.

BY J. L. SULLIVAN, MASTER MECHANIC ST. FRANCIS COUNTY ELECTRIC RAILWAY, FARMINGTON, MO.

There are many boiler feed and other pumping installations which have lubricators of the type shown in the accompanying piping diagram. As a rule when such a lubricator is empty the valves (2) and (3), as shown on the sketch, are closed and (1) is opened, so that the indicator may be blown out. After the lubricator has been blown (1) is closed and plug (4) is taken out so that the oil may be poured in for continued use.

It is customary to fill the lubricators from a can of some kind and frequent use of old coffee pots is made for this purpose.

The usual way of telling when to stop filling with oil is to wait until the lubricator runs over. This causes an unnecessary waste of oil. If the lubricator is filled say four times in 24 hours, the amount of oil that may run over combined with that blown out when preparing to refill will prob-

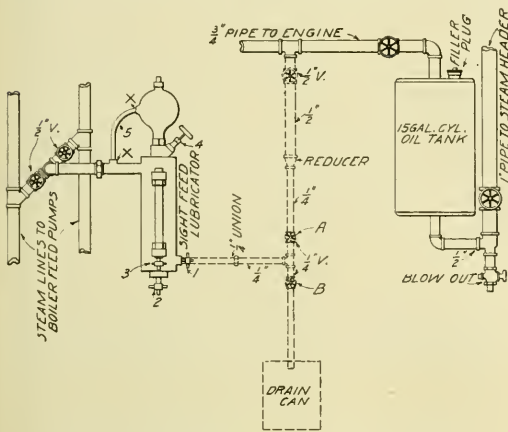

Lubricator Piping—Arrangement to Facilitate Filling.

ably amount to one-half pint. Thus in a year there would have been thrown away about 20 gallons of oil, and if a plant has three or four lubricators the waste may amount to as much as 60 gallons of oil in a year, which, at 35 to 70 cents per gallon, means a sum worth considering. Remembering that this is an unnecessary waste it will be seen that the loss in a few weeks might pay for connecting the lubricator with the oil supply tank, as indicated by the dotted lines in the sketch, thereby doing away with the old and wasteful method of filling.

The piping illustrated herewith as installed in our power plant comprises two steam lines, one to each pump, which originally had a lubricator on each line. By connecting these steam lines with the 1/2-inch pipe and using a valve on each side of a connection to the sight feed lubricator, we are enabled to feed oil to either one of the pumps that may be in service, according to the way the valves are set. The small pipe (5) leading from the condensing chamber of the lubricator was taken out and the two openings marked (X) were plugged. In connecting the lubricator with the oil supply the drain plug (1) was taken out and the hole tapped for a 1/4-inch pipe with a union as shown. If the lubricator becomes stopped up the 1/4-inch valve marked (A) is closed and the valve marked (B) is opened. Then the oil may be drained out of the lubricator into a can or cup later to be poured into the supply tank.

With the piping arrangement as shown the lubricator has

now been in service nine months and the method has been found to operate very satisfactorily.

PURCHASING TIES FOR THE INDIANA UNION TRACTION COMPANY.

In securing ties S. R. Dunbar, purchasing agent of the Indiana Union Traction Company, Anderson, Ind., has had favorable results from posting notices on poles at country crossroads and in stations, headed: "Wanted—Railroad Cross-ties in Any Quantity." These notices also give the dimensions of the ties desired, and state that further information can be had from Mr. Dunbar. The notices are kept in evidence by the section foremen. When inquiries are received Mr. Dunbar sends tie specifications, prepared in October, 1907, by W. C. Sparks, superintendent of roadway. In referring to the results of this method Mr. Dunbar says:

I was impelled to endeavor to obtain ties in this manner because of the high prices that we were forced to pay for ties shipped in by steam roads, and the difficulty of obtaining the ties when we wanted them.

In preparation for the ties which we would need for renewals during 1908 we started putting up notices early last fall, and engaged a man to follow inquiries and also develop what additional business he could by his own efforts. In this way we fully expect to obtain the full quantity which we shall need for the renewals for the year.

The ties will be of a quality satisfactory to us, and the inspection can be made without the necessity of sending the inspector long distances and having him wait for the trains of steam roads. Besides the saving in the cost of inspection we are able to buy ties from 15 to 20 per cent cheaper than the prices we otherwise would have to pay.

TOOL FOR HOLDING TROLLEY WHEEL.

BY F. A. M.

The accompanying sketch shows a tool for holding trolley wheels when turning up grooves, which is found to be a great convenience and to result in a considerable saving of labor

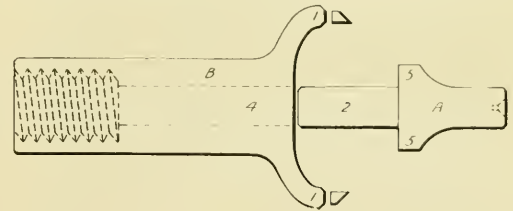

Tool for Holding Trolley Wheel.

in handling this work. The portion, B, is threaded to fit the spindle of the head stock of the lathe. The shank, 2, of the right-hand portion, A, is turned to fit the trolley wheel with the bushing removed and is a working fit in the central hole in B. When the wheel is placed on A and the portion 2 slipped into hole 4 in part B and the tall stock screwed up, the wheel is held firmly between the shoulders 5 on A and the arms 1 on B so that it cannot move laterally, but revolves with arms 1. If parts 2 and 4 are turned to an easy fit and A is properly centered the wheel will run perfectly true.

When the work is finished it is merely necessary to run back the center to remove the wheel and insert another, no adjustment of bolts, nuts or screws being necessary. If two sizes of trolley wheels are used two of the parts A will be required, one for each size. One portion, B, can be used for both sizes of wheels by providing a bushing for the hole 4. By the use of this device it has been found practicable to re-turn the groove to its original contour at a cost of from 1 to 1 1/2 cents per wheel.

### RECENT ELECTRIC RAILWAY LEGAL DECISIONS.

BY J. L. ROSENBERGER, LL. B., OF THE CHICAGO BAR.

#### Speed Regulation Distinction Between Steam and Electric Cars.

Indianapolis Union Railway Company v. Waddington, 82 Northeastern Reporter, 1030.—The supreme court of Indiana holds that the fact that electric cars are more readily controlled than steam cars affords just ground for distinguishing, in a city ordinance, between them with respect to speed.

#### True Rule with Regard to Rights of Vehicles at Crossings.

Daggett v. North Jersey Street Railway Company, 68 Atlantic Reporter, 179.—The court of errors and appeals of New Jersey holds that the true rule is that the driver of a wagon has the right of way, if, proceeding at a rate of speed which, under the circumstances of the time and locality, was reasonable, he reaches the point of crossing in time to safely go upon the tracks in advance of the approaching street car, the latter being sufficiently distant to be checked, and, if need be, stopped, before it reaches him.

#### Question of Motorman's Negligence Should be Submitted to Jury.

Merkl v. Jersey City Hoboken & Paterson Street Railway Company, 68 Atlantic Reporter, 74.—The court of errors and appeals of New Jersey holds that, except in cases where the motorman's negligence is not the immediate or proximate cause of the injury (as, for instance, where the injured person darts, or comes very suddenly, in front of the car, and the accident would have occurred even if it had been running at an entirely safe and proper rate of speed, and the motorman had been on his guard), the question of his negligence should be submitted to the jury.

#### Requirement as to Stopping of Car Before Ejection of Passenger.

Springfield v. Louisville Railway Company, 105 Southwestern Reporter, 1190.—The court of appeals of Kentucky says that if a passenger is drunk, or uses profane and insulting language, or violates the rules of the company wilfully and flagrantly, he may be ejected from the car, but not while it is in motion. As preliminary to this action, the car must be stopped, and then the passenger can be ejected; no more force being used than is necessary to accomplish this act. Of course the court does not mean to say that there might not be instances which would warrant the ejection of a passenger from a car, even while it is in motion; for example, if it was absolutely necessary to save the life of the conductor or the lives of the passengers, or to prevent their suffering great bodily harm at the hands of a desperate man.

#### Distinction with Regard to Jerks in Stopping of Cars.

Garner v. Forty-second Street, Manhattanville & St. Nicholas Avenue Railway Company, 107 New York Supplement, 134.—The supreme court of New York, appellate term, distinguishes between possible necessary jerks in stopping cars and one from suddenly increasing the speed after slowing down preparatory to stopping. It says that the plaintiff in this case signaled the conductor to stop. He rang the bell and the car slowed down as it approached the street. As the car slackened its speed the plaintiff arose from her seat and went to the rear platform. At that time the car was moving very slowly, and had come nearly to a standstill. She stood on the platform, holding the guard rail with her hand. While in this position and before she had made any movement to alight the speed of the car was suddenly increased to such a degree as to throw her into the street. It was conceded

that the plaintiff was justified in standing on the rear platform in readiness to alight. But the defendant argued that there was no negligence on its part and sought to support the argument by citing cases of persons injured by the violent jerking of a car in starting or stopping. The decisions in those cases, however, proceeded upon the theory that a jerk might necessarily attend the starting and the stopping of a car. That was not the situation here presented, as the car had slowed down preparatory to stopping, and the plaintiff was justified in assuming that the speed would be gradually reduced until the car came to a standstill. The judgment for the plaintiff must be affirmed.

#### What May be Assumed on Seeing Horse Standing Near Track —Motorman Being Inexperienced Not Negligence.

Columbus Street Railway & Light Company v. Reap, 82 Northeastern Reporter, 977.—The appellate court of Indiana, division No. 2, holds that a motorman had the right to assume, when he saw a horse and wagon standing beside the track and out of danger, that he could safely pass without slackening the speed of his car; that either the horse was properly secured or that it would not frighten at the car. It further says that while it was true that the motorman in charge of the motor on the car in this instance was inexperienced, that fact of itself did not constitute negligence on the part of the street car company. It is necessary that men learn the business. The operation of motor cars is not a natural gift, and the court can conceive of no other way in which the business can be learned than the one that was employed in this case by the company, which had taken the precaution to provide a skilled and experienced motorman to accompany the novice, to teach him the art, and presumably to see that no harm came from his inexperience.

#### Time and Manner Cars May be Started After Passengers Have Gotten On.

Birmingham Railway Light & Power Company v. Hawkins, 44 Southern Reporter, 983.—The supreme court of Alabama says that in the management of electric street cars it is the duty of the motorman, conductor or person in control to hold the car stationary until those desiring to enter the car have gotten on the car and reached a place of safety. The cases agree that it is negligence to start the car while the passenger is in the act of stepping onto the car, and, on the other hand, they hold that there is no obligation to keep the car standing until the passenger has taken his seat.

As this court has expressed it, the party in charge of the car must see that the passenger is not "alighting (or getting on) or otherwise in a position which would be rendered perilous by the motion of the car." The passenger must be allowed "a reasonable opportunity to get safely upon the car," and "if anything is apparent in the condition of the passenger, so that he would be likely to be thrown or injured by a motion of the car, then proper regard for his safety might require a train to be held in position to avoid it." But it seems that under ordinary conditions, unless some special circumstance requiring greater caution is brought to the attention of the motorman or the conductor, the passenger is considered to have reached a place of safety when he or she has gotten on the car.

It is a matter of common knowledge that many persons do not sit down at all, but ride standing on the platform and in the aisle of the car; there being railings on the platform and loops in the car for passengers to hold to while the car is in motion. Consequently, in this case, in which no special circumstances were shown, the passenger having boarded the car and being in the act of stepping from the platform into the door of the car, it could not, as a matter of law, be said to be negligence for the car to be started in the usual manner and without any unusual jerk. But it would be otherwise if it were started in an unusual manner, with a severe jerk, while the passenger was entering the door.

# News of the Week

## Detroit Injunction Dissolved.

Henry H. Swan, judge of the United States circuit court at Detroit, announced on March 2 that he would dissolve the injunction restraining the common council from passing the so-called Haily ordinance. This measure is intended to compel the Detroit United Railway, after any of its franchises expire, to sell five tickets for 15 cents. Judge Swan intimated strongly that he doubted the power of the common council to enact such an ordinance legally, but his action is based on the belief that the court did not have authority to restrain legislation.

## Receiver for Chicago-New York Air Line.

The Chicago-New York Electric Air Line Railroad Company, which has sold large amounts of stock throughout the country for the construction of an electric railroad from Chicago to New York, which it was advertised would carry passengers between those cities in 10 hours at a fare of \$10, was placed in the hands of a temporary receiver on March 4 by order of the court at Laporte, Ind. The temporary receiver, George F. Mull of Indianapolis, filed a bond for \$50,000 and immediately took charge of the company and its allied companies, the Co-Operative Construction Company, the Western Securities Company and the Hancock Company. The receivership was ordered on the application of stockholders said to own \$250,000 of the company's stock.

The complaint charges President A. C. Miller and other officers of the company with voting themselves excessive salaries, both in stock and in cash, and with participating in rebates and profits in connection with contracts let by the construction company. The complaint states that over \$1,000,000 of stock has been sold at prices ranging from \$5.00 to \$51 a share to more than 15,000 stockholders and that the officers in charge of this money are men of no responsibility or property and have given no bond to insure a faithful accounting for the money. It is further stated that the road could not be built for less than \$400,000,000 and that the stock was sold under a fraudulent claim that it could be built for \$200,000,000. It is stated that the company's only tangible asset is an incomplete railroad extending from Laporte to Westville, Ind., 12 miles, and that the officers of the company have secured with the company's funds a franchise in the town of Gary which they now claim as their personal property. On March 5, after hearing arguments of the company's attorneys, the court dismissed the receiver, pending a final hearing on the charges.

## Directors and Officers of Central Illinois Traction Company Freed from Responsibility for Fatal Accident.

Judge Thompson of the Coles county district court at Charleston, Ill., on February 24 quashed the indictments against the officers, directors and employes of the Central Illinois Traction Company, in which they were charged with manslaughter and criminal negligence in connection with the accident on August 30, 1907, in which 18 persons were killed and 35 injured. The case has attracted widespread attention, not only because of the prominence of the persons involved, but because of the stand taken by the state's attorney for the prosecution that the non-resident directors of the company were personally liable.

As previously reported in the Electric Railway Review, those who were indicted were: Judge Peter S. Grosscup, Arthur W. Underwood, Francis S. Peabody and Marshall W. Sampsell of Chicago, directors; President E. A. Potter of Chicago; Superintendent Fred Moore of Charleston; and B. F. McClara and Charles Botts of Charleston, the motormen of the two cars involved.

In his decision the court held that the 52 indictments were all faulty, not only on account of technical errors, because the grand jury that had returned them had been illegally assembled, but also on broad legal grounds, which completely freed the officers and directors from personal responsibility for the accident.

In discussing the duties and liabilities of the directors, after likening the board of directors to an individual owner, the court said: "Now, then, in this case to say that the owner of this railroad, if you please, would be jointly liable with the motorman running a car would not meet the approval of any fair-minded man, simply upon a statement of that proposition, because we all know as a matter of fact, as well as a matter of law, that their duties are not the same and their responsibilities are not the same.

"To include the directors, then, in this indictment with anyone else in my judgment absolutely vitiates the entire indictment.

"Something has been said about the directors not being liable as individuals; that the corporation would be liable civilly. There can be no question about the civil liability for damages resulting from the death of parties on the car, so far as the corporation is concerned. But I doubt if a single authority can be found in any common law state that holds that directors, in an individual capacity, would even be liable in a case of this kind for damages. I cannot at this time conceive whereby they could be held liable for damages resulting from death. If a director was personally in control and management of this car at the time of the accident, as set forth in the criminal code, the fact that he was a director of the company would make no difference. He would not be held liable as a director in that case; he would be held liable, as anybody else would be, in charge of the car, in the control and management of it at the time of the injury; and the fact that he was a director would not make any difference."

The state's attorney has announced his intention of bringing the case before the next grand jury.

## Proceedings in Suit to Forfeit Charter of New York City Railway.

Trial of the suit started by Attorney-General Jackson of New York to forfeit the charter of the New York City Railway on the ground that the corporation had been insolvent for more than one year, was begun on March 2 before Justice Vernon M. Davis of the state supreme court, New York.

The attorney-general set up as proof of the insolvency the balance sheet of the company as of June 30, 1906, which showed a deficit of \$6,923,961. The company answered that its solvency or insolvency on June 30, 1906, must depend upon the statement of current assets and liabilities contained in an affidavit of H. W. Brown, the auditor, filed in answer to the allegations of the attorney-general. This statement showed an excess of current assets amounting to \$5,000,000 on June 30, 1906. Herbert R. Limburg, special counsel for the attorney-general, attacked the inclusion by the New York City Railway of \$5,109,541 in "construction and equipment," and brought out the fact that \$4,500,000 of this represented discount upon \$15,000,000 notes, issued at 70 to the Metropolitan Securities Company in part payment for the \$23,000,000 cash which that company agreed to provide. Mr. Limburg said that he proposed to show that the property of the New York City Railway was turned over to the Metropolitan Securities Company without consideration and that a 30 per cent loss on these notes was charged as an asset and carried down into the statement for 1906, and that the company had been continuously insolvent for five years.

Paul D. Cravath, attorney for the company, admitted that the discount of \$4,500,000 was charged as an asset, and said that, while, according to his view, it was a proper capital charge from an accounting standpoint, it should be omitted from the list of assets for the purpose of determining solvency. Mr. Limburg then declared that with an admitted deficit of \$6,900,000 and a deduction of \$4,500,000 from "construction and equipment," the company would be left, according to its own statement, with a deficit of \$11,400,000, which would more than wipe out its capital stock.

When the proceedings were resumed on March 3 Mr. Cravath declared that insolvency must mean in the case of a business corporation only the inability to meet its pressing maturing obligations in the ordinary course of business. Any other interpretation, he added, would put many prosperous corporations in a state of technical insolvency, and be entirely inconsistent with the common sense of the situation.

Mr. Limburg said he proposed to show that the reports of the company carried constantly increasing totals representing material and supplies on hand, whereas it did not have, the values shown.

It was admitted by Oren Root, general manager, that an item of renewal of special work amounting to \$95,381, representing directly an expenditure for the renewal of tracks that had worn out on curves, was put into the company's statement as an asset, as well as an item of \$58,833 for "renewal of horses" and several other large amounts. Mr. Root said that these were proper charges, although they could not be included in a list of assets made up for the purpose of testing solvency.

## Progress of the Cleveland Negotiations.

It is now expected that the plans for a lease of the Cleveland Electric Railway to a holding company will take place in a few days. The mayor and F. H. Goff, who are conducting the negotiations, have gone so far as to submit tentative figures for the valuation of the Cleveland Electric property, and although they differ widely, the hope is expressed that the differences may be easily reconciled. On February 27 Mr. Goff and Mayor Johnson agreed to take 64 per cent of the gross earnings as the figure to be used in estimating the

operating expenses of the Cleveland Electric Railway. Henry J. Davies, secretary of the Cleveland Electric Railway, showed that the total receipts per passenger in 1906 were 4.82 cents, which would make the cost of operation 3.0842 cents per passenger. President Andrews of the Cleveland Electric Railway said that the cost of operation cannot be materially reduced under the holding company if the same number of cars are run.

Harry Bunning of the Forest City Railway and T. P. Kilfoyle of the Cleveland Electric Railway submitted a report in which the average life of the city franchises was computed as 3.1929 years from January 1, 1908, or to March 11, 1911. Mr. Goff claims an additional time of 0.2649 year, or to June 16, 1911, in consideration of the Glenville grant. They were instructed to make another report on some of the grants.

At the meeting on Saturday, February 29, Mayor Johnson presented a calculation which placed the value of the 234,000 shares of the Cleveland Electric stock at \$41.73 a share. This valuation included a physical value of \$15,034,614 and a franchise value of \$4,014,930. From this amount the indebtedness of the company, \$9,141,000, is to be deducted. Mr. Goff presented an estimate of \$22,980,000 for the entire valuation, or \$59.14 for each share after deducting indebtedness. Mr. Goff's figures were made up as follows: Physical property, including overhead charges, \$17,420,000; the value of the city grants, using 5 per cent as an interest rate and 64 per cent for operating expenses, \$5,550,000. After deducting indebtedness the total was \$13,839,000. To this he asked that \$6.00 per share be added for the outlying franchises, \$5.00 per share in consideration of a perpetual lease and about \$10 per share for good will.

The principal points of difference in the figures are in regard to about \$2,000,000 in the physical value for overhead charges, and in regard to the value of the inside grants. The mayor still insists that the outlying franchises have no value. He proposed that the company deduct the physical value of the lines and accept a bonus of \$250,000 to keep them after the settlement, suggesting that they might be sold to interurban companies. He declared that whatever he might add to his estimate would be for good will.

The negotiations were resumed on Tuesday of this week. Mr. Davies submitted a report on some of the outlying lines and also an estimate of \$22,386,991 for the entire property. To this he said should be added the value of certain outside grants. Another meeting was called for Friday morning. The Cleveland Electric Railway and the Forest City Railway have both called stockholders' meetings to consider the final settlement as soon as the negotiations are completed.

#### Legislation Affecting Electric Railways.

**Maryland.**—An amendment to apply to electric railways the provisions of a law requiring separate railroad cars for white and colored passengers has been defeated in the senate.

**Massachusetts.**—The senate committee on street railways has voted to report a bill granting permission to street railways to transport milk over their respective lines without legislative restriction. Under the terms of the bill electric roads may compete with steam roads, and its passage means much to interurban lines throughout the state. The only line doing a milk business in the state at the present time is the Amherst & Sunderland Railway, controlled by the Holyoke Street Railway, which operates about 17 miles in the Connecticut valley.—John H. Thompson has introduced a bill into the legislature providing that freight and express privileges may be granted to street railway companies in cities of 75,000 or more population upon the approval of two-thirds of the board of aldermen and the mayor.

**New York.**—Senator Travis has introduced a bill amending the rapid transit law so that private companies may be granted franchises for the construction of subways in New York, for an indeterminate term, at the discretion of the public service commission, the minimum being 25 years and the maximum 50 years, the city retaining the right to purchase the property at any time after 25 years.—Senator McCarren has introduced an amendment to the rapid transit law which removes the provision for separate contracts for construction and operation and requires that a contractor for a new subway must deposit with the city comptroller a bond for 10 per cent of the cost, or, in case the cost is less than \$10,000,000, for \$1,000,000.

**Ontario, Can.**—A bill has been introduced into the Ontario legislature to increase the assessments of various electric railways in the province. The matter is being taken up by the Canadian Street Railway Association, and strenuous opposition is to be made against the proposals.

**Ohio.**—Senator Gayman has introduced a bill requiring the state railroad commission to make a valuation of the property of the steam and electric railways of the state. The commis-

sion is authorized by the bill to employ engineers and experts and the companies are directed to afford the commission every facility for making the investigation.—Senator Schmidt has introduced a bill providing that municipal ordinances granting franchises to public service corporations shall be ratified by a majority of the voters before becoming effective.

**Sarnia Tunnel of the Grand Trunk.**—A trial trip through the Sarnia, Ont., tunnel of the Grand Trunk with electric power was made on February 20, two electric locomotives drawing a 700-ton train.

**American Institute of Electrical Engineers, Toledo Section.**—At the regular monthly meeting, held in the Builders' Exchange, Toledo, Friday evening, March 6, a paper on "Steam Turbines" was presented by C. F. Stoetmyer.

**Street Cars Not Required to Display Red Lights.**—Judge Rogers of the common pleas court at Youngstown, O., has held that the city ordinance requiring street cars crossing railroads at grade to display red lights on each side is invalid.

**Forged Order for Transfers.**—John J. Bauermeister of New York City was arrested on February 22 on a charge of forging the name of E. A. Maher, president of the Union Railway, to an order for 50,000 transfers. The order was presented to a printer, who became suspicious, and, after communicating with Mr. Maher, caused the man's arrest.

**New York State Street Railway Association.**—Secretary J. H. Pardee, 611 West One Hundred and Thirty-seventh street, New York, announces that at a recent meeting of the executive committee of the Street Railway Association of the State of New York it was decided to hold the next annual convention on Tuesday and Wednesday, June 23 and 24, at the Clifton hotel, Niagara Falls, Ont.

**Conferences on Uniform Rules in Indiana.**—Meetings of the committees appointed at the conference on February 13 at Indianapolis, between the Indiana railroad commission and operating officials of electric railways in Indiana, have taken place, and rapid progress has been made on the work assigned, which is the formation of uniform rules for trainmen and "maintenance of way."

**The Steam Path of the Steam Turbine.**—The March meeting of the American Society of Mechanical Engineers will be held on Tuesday evening, March 10, at 8:15 o'clock, in the Engineering Societies building, New York City. The meeting will be addressed by Dr. Charles P. Steinmetz, member A. S. M. E., past president A. I. E. E. and professor of electrical engineering at Union University, the subject being "The Steam Path of the Steam Turbine."

**New York New Haven & Hartford Reduces Salaries.**—The New York New Haven & Hartford Railroad has announced a reduction in salaries, effective on April 1. Salaries above \$2,000 per year will be reduced 10 per cent and salaries between \$1,200 and \$2,000 per year will be reduced 5 per cent, except that no salary in the first class will be reduced below \$2,000 and no salary in the second class will be reduced below \$1,200. The reduction includes the president, vice-presidents and the managers of the electric lines.

**Recent Accidents.**—A car on the Detroit Monroe & Toledo line of the Detroit United Railway rolled off a 15-foot embankment near La Salle, Mich., on February 29, injuring two persons seriously and a large number of others slightly. The wheels on the rear truck were derailed at a switch at the end of a trestle and after running a slight distance with the rear wheels on the ties the front wheels also left the track and the car toppled over the embankment, turning upside down. The defective operation of the automatic switch is stated to have been the cause.

**Electrolysis Suit in Massachusetts.**—The Spencer Gas Company, Spencer, Mass., recently brought suit against the Worcester Consolidated Street Railway, Worcester, Mass., and the Warren Brookfield & Spencer Street Railway, Brookfield, Mass., for an injunction to restrain the companies from operating their roads in such a manner as to damage the gas company's pipes by electrolysis. Justice Hammond of the Massachusetts supreme court has sustained a demurrer filed by the companies on the ground that if the gas company desires to state a case of injury to which each company has contributed the petition must be amended.

**Ticket Thieves Arrested.**—The Evansville & Southern Indiana Traction Company on February 28 caused the arrest of William Berger, a conductor, and Edward Schelbasse, a former office employe, on the charge of having stolen nearly 20,000 tickets, valued at \$10,000. Recently the company noticed that the conductors were turning in more tickets than had been

given out to them and had the tickets stamped with red figures. About 50,000 tickets, with a rubber stamp used for stamping the red figures, were found in Schelhasse's room. He thereupon confessed to the police that he had stolen the tickets while he worked in the office and that he and the conductor had disposed of them.

**Indiana Strike Ended.**—The strike of the motormen and conductors employed on the city lines of the Indiana Union Traction Company, which was declared on January 1, was declared at an end on March 2 by vote of the Muncie, Anderson and Marion locals of the Amalgamated Association of Street and Electric Railway Employes. As previously reported in the Electric Railway Review, the strike was called on January 1 because the company signed a wage contract with the Brotherhood of Interurban Trainmen. The first days of the strike were attended with great disorder, but the company has been running its cars without difficulty for several weeks, although traffic has been reduced by a boycott declared by the union sympathizers.

**Orders of Railroad Commission of Michigan.**—The railroad commission of Michigan has issued orders requiring all railroads, steam and electric, to file with it one copy of each of its current working timecards, train order blanks and releases and all rules governing movement of trains not published. Another order of the commission provides that when an automatic alarm bell on a highway or street crossing shall be out of order the company operating the railway shall immediately station a flagman at the crossing. The commission has also issued an order providing that former employes of railway companies who have been retired from practical work by reason of old age, infirmity or permanent disability, may lawfully be supplied with free transportation.

**Attempt to Lay Track Defeated.**—An attempt of the Kentucky & Indiana Bridge & Railway Company to lay an additional track at the New Albany end of the bridge between Louisville and New Albany early last Sunday morning was prevented by the police department of New Albany, assisted by the fire department, who threatened to turn the hose on the workmen. The company desired to lay a third rail to complete a connection between the tracks of the Louisville Railway and the Louisville & Northern Railway & Lighting Company, conforming to the wide gauge of the Louisville lines, and has had a petition for a permit before the city council for two months, but the council has not acted upon it. The Louisville & Northern has posted in its cars a notice apologizing to the public for the necessity of transferring before crossing the bridge from Louisville.

**Minnesota Electric Roads Not to be Assessed on Gross Earnings.**—It has been decided that the electric railways of Minnesota shall pay taxes this year on the basis of the assessment of their property in the communities through which the lines run and not on the basis of gross earnings. This understanding was reached at a conference on February 27, between the attorney-general, members of the state railroad and warehouse commission and representatives of the roads. Several months ago the supreme court held that suburban electric railways are common carriers and as such, under the statutes, they would be required to pay taxes on the basis of gross earnings. As the roads have not kept their records in such a way as to determine the proper division of earnings according to localities, they were consequently not able to make the report required by the commission. Moreover, much of the property had already been assessed by the localities. Consequently it was decided that the assessment for the present year should be made on the old basis.

**Electric Railway Bonds as Basis for Emergency Currency.**—Samuel T. Murdock of Lafayette, Ind., who is prominently identified with many of the electric railways of Indiana, has written to the United States senators from Indiana opposing the passage of the Aldrich emergency currency bill without a provision including the bonds of electric railway and lighting companies, as well as railroad bonds, as the basis for an emergency currency. Mr. Murdock says: "This seems unfair, particularly to this section of the country, where traction lines have reached their highest state of proficiency and perfection. While it is true that bonds of both electric light and traction companies, as well as all other securities, should be properly safeguarded, these securities have an intrinsic and inherent value, even greater than many of the railroad securities acceptable under this measure. In the localities in which the roads are built and in the community to which service is given by them their bonds are taken by the banks at a proper and safe valuation and are among the assets of many of these institutions. I sincerely trust that the bill will be modified so as to permit good bonds of the traction and light companies to be used as a basis for currency circulation."

## Traffic and Transportation

### Increases in Fares in Massachusetts.

On March 1 the Concord Maynard & Hudson Street Railway, Maynard, Mass., increased the unit of fare from five to six cents, making the fare from Hudson to Concord 24 cents instead of 20. Henry Tower, the treasurer, stated that the season had been an especially hard one for the roads and that his road had been affected more seriously than any other. He gave as one reason the closing of the Assabet mills at Maynard. He said that the road earned \$7,000 net last year, but did not pay any dividends, as the money was needed for further extensions. It is intended to extend a switch at Gleasondale, which will facilitate travel between Hudson and Marlboro.

Increases in the unit of fare from five to six cents were adopted on March 1 by the Middlesex & Boston, the Natick & Cochituate and the Westboro & Hopkinton street railways, to be operative west of Newton Lower Falls. George A. Sweetser, chairman of the Wellesley, Mass., selectmen, has issued a statement of protest against the increases, in which he says with reference to the Natick & Cochituate road: "The company has paid from 1891 to 1907, inclusive—17 years—141 per cent in dividends, averaging 8 per cent a year. In one year it paid 53 per cent, and in only one recent year has it failed to pay dividends. In only two other years have the dividends been less than 6 per cent since 1897. The street railway has a large floating debt which is not funded. If this could be funded a material saving in interest charges could be made. Just recently the selectmen granted the company an extension of location, which it desired for the purpose of giving better service. Almost immediately after this grant was made the company cut down the number of trips per hour from four to three, and was unable to run cars always on time then. We are going to file with the railway commission a petition for the retention of the 5-cent fares." The companies have issued a statement concerning the change, in which they say: "It is hoped by the management that the necessity for this advance in fares will not be permanent, and that the public will give the management hearty co-operation in this change, necessitated by causes beyond control."

The unit of fares on the Dedham Franklin Medfield & Medway Street Railway was raised from seven to eight cents on March 1. Since January 15 the fare unit had been seven cents, and previous to that time it was five cents. Tickets are now sold in books of 25 for \$1.75. The various fare limits, which were not operative under the 7-cent fare, have been restored.

### Orders Affecting Service and Fares in New York.

The New York public service commission, first district, has ordered the Brooklyn Union Elevated Railroad to increase the number of trains on the Brighton Beach line about 20 per cent.

The public service commission, first district, has ordered the Interborough Rapid Transit Company to construct additional stairways at the stations at One Hundred and Thirty-seventh and One Hundred and Forty-fifth streets. The cost of the improvements, about \$28,000, will be borne by the city. At the hearing on the alleged insufficiency of service on the Ninth Avenue elevated road, New York, Frank Hedley, general manager of the Interborough Rapid Transit Company, submitted reports of inspectors, showing that there were standing passengers in the cars during only a short period in the afternoon rush hours. Mr. Hedley referred to the greatly reduced traffic on the line since the financial crisis. Commissioner Estus decided that under the circumstances the service is now adequate and recommended that the hearing be dismissed.

The New York public service commission, second district, has directed the New York & Long Island Traction Company, Hempstead, N. Y., to collect no more than 10 cents for a passage in either direction over its entire line, and not more than 5 cents for a single ride not exceeding five miles long in either direction. The company had been charging a 10-cent fare between Hempstead and Freeport, where the distance is less than five miles.

The public service commission, first district, has extended until March 14 the time for answer by the Brooklyn Rapid Transit Company and the Coney Island & Brooklyn Railroad to the complaint against the 10-cent fare to Coney Island.

In response to a request from the public service commission, first district, for information following a complaint from the board of aldermen, F. W. Whitridge, receiver for the Dry

Dock East Broadway & Battery Railroad, New York, wrote as follows: "I trust that the aldermen will consider that the 'unclean, unhealthy and menacing' conditions of which they complain are largely caused by the personal habits, sanitary condition and manners of the people who are carried in the cars, and I should be happy to co-operate with them in any device which they may suggest, including free baths on our routes, for remedying these conditions. I am even prepared to admit that the operation of the cars may be 'a travesty on the transportation accommodations of the great city of New York,' although it is possible that the slowness complained of is because of our inability to purchase faster horses and because also of the fact that the streets are not kept free for the sole use of these cars."

#### Fare Cases at Atlanta, Ga.

The Georgia railroad commission has been petitioned to compel the Atlanta Northern Railway, which is controlled by the Georgia Railway & Electric Company, Atlanta, to reduce the fare between Atlanta and Marietta from 35 to 20 cents.

P. S. Arkwright, president of the Georgia Railway & Electric Company, has made public a reply to the petition, in which he refers to the attacks on the company and says:

"The taxes of the company were increased 130 per cent, the largest increase on any corporation in Georgia. Fares have been reduced to five cents on all the city and suburban lines of the Georgia Railway & Electric Company, universal transfers being granted at the same time. With it all every concession made by the company has been made voluntarily, for the general public good, and at financial sacrifice to the company. Every effort has been made to meet the just demands of the public. Additional cars have been put on all lines; the service has been steadily increased and improved; the lines have been extended, rebuilt and new territory opened up. We had hoped to conduct many improvements which have been made impossible. The company is exerting every effort to deal not only justly, but liberally, with the public. It has always been the policy of the company to do anything the public demands or else give a good and satisfactory reason for refusing. Complaints like the present do not encourage the construction of interurban lines; there is little encouragement for the construction of suburban lines; all street railroad people and steam railroad people, too, realize the fact that there is no money in long hauls where a flat rate of five cents is charged. Every man who rides from Atlanta to College park for five cents loses this company money. It is the short-haul business which enables this loss to be made up and makes possible the construction of suburban trolley lines."

On February 27 the hearing on the petition to the Georgia railroad commission to compel the Georgia Railway & Electric Company, Atlanta, to give eight rides for 25 cents was begun at Atlanta. After two short sessions an adjournment was taken until March 5.

**Chicago Elevated Road Traffic.**—The average daily number of passengers carried by the South Side Elevated Railroad of Chicago in February was 111,927, an increase of 15,833, or 16.47 per cent, over February, 1907. The Northwestern Elevated Railroad carried an average of 102,182 passengers daily during February, an increase of 13,747, or 15.54 per cent. The Metropolitan West Side Elevated Railway carried an average of 145,427, a decrease of 9,016, or 5.83 per cent.

**Warning to Teamsters.**—As part of its effort to reduce accidents the Omaha & Council Bluffs Street Railway, Omaha, Neb., is advertising a warning "to persons driving vehicles," in which it says: "At this season of the year street car tracks are apt to be very slippery, owing to atmospheric conditions, and it is impossible, therefore, to stop a car as promptly as ordinarily. Remember that a street car is confined to the track and that the motorman cannot turn out or stop his car instantly when 'cut off' by a vehicle."

**Interview on Prevention of Accidents.**—An article headed "Stop, Look and Listen" is published in the Journal-Gazette of Ft. Wayne, Ind. It contains an interview with R. T. Gunn, superintendent of transportation Ft. Wayne & Wabash Valley Traction Company. Mr. Gunn is quoted in part as follows: "The exercise of a little judgment on the part of persons walking along and across streets would prevent a good many accidents. How many persons who start over a street crossing stop and look each way to see if a carriage or street car is approaching? It is a common occurrence for passengers to alight from a car and walk behind the standing car, directly in front of an approaching car on the other track. It is impossible for the motorman to see these people. The motorman not only has to operate his car, but also do a lot of thinking for people too careless to think for themselves. The accident nearly always happens at a time when the probability is reduced to a minimum."

# Construction News

## FRANCHISES.

**Glasgow, Pa.**—The Ohio River Passenger Railway has been granted a 100-year franchise to build a line through Glasgow. The company agrees to complete the line by July 1, 1908.

**Greenville, Pa.**—A franchise has been granted to the Mercer Construction Company for the building of a street railway in Greenville, Pa. Construction must be started within six months and completed within 18 months from the date of the franchise. It is stated that the company also has obtained right of way for an interurban line between Greenville and Mercer and between Mercer and Sharon. State Senator James M. Campbell is interested.

**St. Louis, Mo.**—The St. Louis Electric Terminal Railway Company has asked for an extension of time in which to complete its proposed electric line, which will enter St. Louis over a bridge across the Mississippi river, which is expected to be completed by next December. The franchise for building the road expires next October and as it is not considered desirable to operate the cars by ferry before the completion of the bridge one year's extension was asked. The road will be built by the Illinois Traction System. (Noted November 23, 1907.)

**Toledo, O.**—The Toledo Fostoria & Findlay Railway Company has applied for a perpetual franchise in Toledo, O. The road will enter the city on Oakdale avenue for a short distance and then use its private right of way along the east corporation line and adjoining the Bay Terminal Steam Railroad to a connection with the Toledo Railways & Light Company's tracks in Woodville avenue.

**Tolleston, Ind.**—The town board has granted a franchise to the Chicago Lake Shore & South Bend Railway, which is building from South Bend, Ind., to Kensington, Ill.

## RECENT INCORPORATIONS.

**Fruita Land & Power Company.**—Incorporated in Colorado to build an electric railway from Debeque to Fruita, Cal., 40 miles; to build a power plant on the Grand river, and to develop an irrigating system for reclaiming 20,000 acres of land. It is stated that the Commonwealth Securities Company, Denver, Colo., has the financial management of the project. Horace K. Devereaux, president, Colorado Springs; J. Arthur Connell, vice-president; Orson Adams and E. A. Sunderlin, secretary and treasurer.

## TRACK AND ROADWAY.

**Anniston (Ala.) Electric & Gas Company.**—It is reported that this company contemplates an extension of its line to the Blue Springs cotton mills in Oxford, Ala. R. S. Rand, general manager, Anniston, Ala.

**Atlanta & Carolina Construction Company, Atlanta, Ga.**—A contract has been signed with Cook & Lowry of Montgomery, Ala., for the construction of this company's electric line in Atlanta, Ga. Work is to be started in 60 days. The road will connect Atlanta and Augusta, Ga., by way of Washington, Crawfordsville, Athens, Monroe, Conyers and Lithonia, and will also connect Atlanta and West Point, Ga. The central terminus of the road will be at the corner of Center and Broad streets, Atlanta. James W. English, president, Atlanta, Ga. (Noted February 15.)

**Brockville, Ont.**—J. B. Gaughn of Brockville is said to be interested in a project to build an electric railway paralleling the St. Lawrence river from Brockville to Prescott, Ont., 16 miles, together with a street railway in Brockville and an amusement park at Maitland, half way between the termini.

**Columbus Street Railway & Light Company, Columbus, Ind.**—It is reported that John W. Crump, vice-president of this company, and Harold Larabee, manager of the Central Indiana Lighting Company, are interested in a proposed interurban line from Columbus to Hope, Ind., about 12 miles, the right of way for which is said to have been promised by residents along the proposed route. It is stated that power for its operation would be secured from the existing power plant of the company at Columbus. A park, to be established midway between the two towns, is part of the project.

**Dayton (O.) Street Railway.**—C. H. Bosler, president of the Dayton Street Railway Construction Company, Dayton, O., writes that his company will build seven miles of double-track



line from the southeastern to the northwestern corner of Dayton, extending through the principal business section of the city, and affording transportation facilities for the suburbs of Highlands, Riverdale and Dayton View. Its construction will conform to that of the existing lines through the city, although it will be entirely independent of any of the three companies now operating in Dayton. The overhead trolley will be suspended from iron poles and 73-pound 7-inch rail will be used. Alternating current will be purchased from the Dayton Lighting Company and will be transformed by the railway company for direct-current operation. C. H. Bosler, president and general manager, 816 Riebold building, Dayton; Dennis Dwyer, treasurer; J. J. Hall, secretary.

**Dunnville Wellandport & Beamsville Electric Railway, Wellandport, Ont.**—It is reported that William W. Umbenhauer, banker, Philadelphia, Pa., will finance this proposed electric line from Dunnville to Beamsville, Ont. Plans and estimates are being made and it is expected that work will be started this summer. James A. Ross, Wellandport, Ont., is president. (Noted December 28, 1907.)

**Elizabeth, N. J.**—It is reported that a company is being organized to build an electric railway between Elizabeth, Rahway, Carteret, Woodbridge and Perth Amboy, N. J., which it is said will form an important part of the Newark to Trenton trolley route. Ex-Senator Pettigrew of South Dakota is interested.

**Ellwood City, Pa.**—A company of local men has been organized and will apply for a charter to build an electric railway from Ellwood City to Butler, Pa., by way of Burnstown and Wurtemburg. It is stated that sufficient money has been raised for the preliminary surveys, which will be started as soon as the company has been incorporated. J. T. Meckler, John M. Curry, J. N. Kirker and J. C. Keith, all of Ellwood City, are interested.

**Evansville Mt. Carmel & Olney Interurban Railway, Olney, Ill.**—Adam Knopp, Olney, Ill., president of this company, writes that the preliminary organization has been effected and that permanent officers will be elected at a meeting to be held at Vincennes, Ind., this week. The road will have a total length of 75 miles, 33 of which will be in Illinois and 42 in Indiana. It will be built from Olney to Mt. Carmel, Ill., and from there cross the Wabash river to Evansville, Ind., serving several intermediate towns along the route. James W. Moore is secretary. (Noted January 4, February 15 and 22.)

**Findlay-Marion Railway & Light Company, Findlay, O.**—It is stated that this company has secured funds for the construction of its proposed 47-mile electric railway from Findlay to Marion, O., and that work probably will be started this summer. R. P. Hankey, Detroit, Mich., is president. (Noted May 25, 1907.)

**Gainesville Whitesboro & Sherman Railway, Gainesville, Tex.**—A party of Chicago capitalists and engineers has been inspecting the route of the proposed line from Gainesville to Sherman, Tex., 39 miles, with a view to financing the project. The first six miles out of Gainesville was graded in 1906, but work was suspended. John King of Gainesville is vice-president. (Noted December 21, 1907.)

**Grafton (W. Va.) Street Railway.**—This company is said to be planning the construction of an extension  $1\frac{1}{2}$  miles long through South Grafton to the west side. John T. McGraw, president, Grafton, W. Va. (Noted February 15.)

**Grand Rapids (Mich.) Electric Railway.**—C. J. Post, secretary, has issued a map of the lines proposed by this company, which radiate from Grand Rapids, Mich., to Grand Haven, Bay City, Kalamazoo and Battle Creek, with a line from Kalamazoo, Mich., to Montpelier and Fostoria, O.

**Guadalajara, Mex.**—Louis H. R. von Reuau, a mining engineer, is said to have secured power concessions on the Ameca and Mascota rivers in Mexico, for the operation of a proposed electric railway from Cuale to Las Penas, Mex., on the Pacific coast.

**Houghton County Street Railway, Houghton, Mich.**—We are officially advised that construction on this company's extension from Calumet to Mohawk, seven miles, and from Houghton to Pawesdale, Mich., 11 miles, will be started in May. W. H. McGrath, manager, Houghton, Mich.

**Illinois Central Electric Railway, Canton, Ill.**—This company is reported to have placed an order with the Ohio Brass Company for six miles of overhead material. The extension under construction from Canton to St. David, Ill., is expected to be ready for operation by April 1. The company is said to be planning an extension to Norris, Ill., about five miles. R. O. Sharon, general manager, Canton, Ill.

**Iowa & Northwestern Railway.**—It is stated that this company has contracted for the use of a water power at Quasqueton, Ia., with which to operate its road. The line is being built by the Empire Railway Construction Company, of which S. B. Howard is president.

**Kansas City St. Joseph & Excelsior Springs Electric Railway, Kansas City, Mo.**—This company has applied for an extension of two years' time in which to build the bridge over the Missouri river at Kansas City, in connection with its proposed double-track interurban line from Kansas City to St. Joseph and Excelsior Springs, Mo. Work on the bridge was to have been started in May of this year. Ira G. Hedrick, Kansas City, consulting engineer. (Noted May 4 and June 22, 1907.)

**Lima & Toledo Traction Company, Lima, O.**—The plans for the proposed drawbridge of this company over Swan creek have been approved at a public hearing held by Colonel Townsend of the United States corps of engineers. The bridge will be located between the Clover Leaf bridge and the Huebner Toledo Breweries Company's plant. (Noted February 15.)

**Lima-Honeoye Electric Light & Railroad Company, Lima, N. Y.**—E. D. Watkins, manager, writes that the company is meeting with success in securing stock subscriptions from residents along the line and that the data which have been collected showing the tonnage shipped by the farmers and merchants during 1907 make an excellent showing. It is planned to begin construction as soon as subscriptions amounting to \$75,000 have been secured. Lupfer & Remick, Buffalo, N. Y., will probably do the engineering work.

**Nelsonville Athens & Glouster Traction Company, Nelsonville, O.**—We are advised by C. W. Juniper, secretary, that this company has secured franchises in all the cities and villages along the proposed route and that considerable right of way has been acquired. While the plans are not fully matured it is expected that construction will be started on the Nelsonville-Athens section this spring. The line will be operated either by electricity or gasoline motors. It will serve the following cities and towns: Nelsonville, New Floodwood, Chaucey and Athens. A line also will be built from Chaucey through Jacksonsville, Glouster, Murray City, Buchtel and back to Nelsonville. L. F. Carpenter, president; C. W. Juniper, secretary; Charles Tutt, general manager, all of Nelsonville, O.

**Northern Electric Company, Chico, Cal.**—This company has decided upon the permanent route for its proposed extension from Chico to Red Bluff, Redding and Kennett, Cal., and the work of securing right of way will be started immediately. It is stated that the company will soon start work on the construction of its proposed line from Marysville to Colusa and that shortly afterward work on the Red Bluff-Redding section will be begun. A. D. Schindler, general manager, Chico, Cal.

**Oklahoma City Rapid Transit Railway, Oklahoma City, Okla.**—Engineers are said to be at work out of Shawnee, Okla., on the survey for the proposed route of this company, which was incorporated last spring to build an electric railway from Oklahoma City to Norman, Shawnee and Muskogee. George E. Silsby, Saginaw, Mich., E. W. Milburn and others of Tecumseh, Okla., are interested. (Noted April 13, 1907.)

**Oregon Electric Railway, Portland, Ore.**—It is stated that this company will let contracts during the next three months for its proposed 21-mile branch to Hillsboro, Ore. Guy W. Talbot, vice-president and general manager, Portland. (Noted December 14, 1907.)

**Paris & Subiaco Traction Company, Paris, Ark.**—Major Henry Stroup, chief engineer of this company, is reported as announcing that all of the right of way has been secured and that work will be started this spring. The line will connect Paris, Ark., with the monastery of the Benedictine monks at Subiaco in Logan county and will develop the coal fields of that section. D. J. Young, Conrad Elskens, G. G. Dandridge, Henry Stroup and Charles J. Jewett are interested. (Noted February 15.)

**Portland Eugene & Eastern Railway, Portland, Ore.**—L. N. Roney, contractor, is making arrangements for the construction of a bridge across the Willamette river on the line from Eugene to Salem, Ore. A. Welch, chief engineer. (Noted January 4.)

**Public Service Railway, Newark, N. J.**—Surveyors are at work on a route for a new electric line which it is stated this company will build between Upper Montclair and Paterson, N. J. The present communication between the two cities is afforded only by a detour of several miles, which the new road will shorten.

**Portland Railway Light & Power Company, Portland, Ore.**—It is reported that this company will build a 4-mile extension to the proposed Swift packing plant as soon as work on the buildings is well under way. F. I. Fuller, general manager, Portland, Ore.

**Quebec & Saguenay Electric Railway, Quebec, Ont.**—It is reported that construction on this railway will be commenced in the spring. It is intended that the line, when completed, shall connect Quebec with St. Catharines Bay, a distance of about 155 miles. The route has been surveyed from Cap Tourmentine, the terminus of the Quebec Railway Light & Power Company's railway, to Murray Bay, 56 miles, and it is on this portion that it is understood the work will be rushed, with a view to its completion within a year. R. Forget is the promoter.

**Roanoke Railway & Electric Company, Roanoke, Va.**—Work on the construction of two new city lines is to be started by this company in the near future. J. W. Hancock, general manager, Roanoke, Va.

**San Angelo Traction Company, San Angelo, Tex.**—Col. J. H. Ransom, Hereford, Tex., president and general manager of the proposed electric railway in San Angelo, states that the line will be three miles long. The franchise which was secured some time ago expires next September and it is stated that work will be started in the near future on the first mile of track. J. A. Williams, secretary and treasurer. (Noted February 15.)

**Traverse City, Mich.**—Bond subscriptions are being received for the purpose of building an electric railway from Traverse City to Charlevoix, Mich., and it is proposed to begin work this spring. The Carter Construction Company of Indianapolis is interested.

**Warren Cortland & Jefferson Traction Company.**—C. G. Phillips, Cortland, O., one of the promoters of this road, is said to be negotiating with the Mohawk Construction Company of Boston, Mass., for the construction of the road.

#### POWER HOUSES AND SUBSTATIONS.

**Albany & Hudson Railroad, Hudson, N. Y.**—It is stated that this company is planning for the immediate installation of additional power equipment and boilers in its power plant at Stuyvesant Falls. N. Y. R. H. Smith, general manager, Albany, N. Y.

**Coney Island & Brooklyn Railroad, Brooklyn, N. Y.**—This company has contracted with A. Pasquini, 1123 Broadway, New York City, for the construction of a new power house to be located at Smith and Ninth streets, Brooklyn, and with John B. Roberts & Co., 1 Madison avenue, New York City, for the erection of two substations, one to be located at De Kalb avenue and Sanford street and the other at Coney Island and Q avenues. The buildings are to be of brick construction.

**Fruita Land & Power Company.**—This company, which was recently incorporated in California for the construction of an electric railway from Debeque to Fruita, Cal., and to develop an irrigation system for reclaiming a large tract of land, will build a power plant on the Grand river near Debeque, work on which is said to have been started. It is stated that 6,656 horsepower will be developed. Horace K. Devereaux, Colorado Springs, Colo., is president.

**Northern Texas Traction Company, Ft. Worth, Tex.**—Early last fall plans were made to enlarge the Handley power station by the installation of a new 1,500-horsepower engine direct connected to a 1,000-kilowatt generator and by the installation of 1,000 horsepower in boilers, with the necessary pumps, condensers, etc. The work was stopped temporarily in November, but it is hoped to have the boilers in operation by March 15. The engine and generator will probably be in operation some time during the summer.

**Oregon Electric Railway, Portland, Ore.**—It is announced that a contract for the building of a substation will be let by this company within the next three months. Guy W. Talbot, vice-president and general manager, Portland.

**San Angelo (Tex.) Traction Company.**—This company proposes to install an electric power plant for a street railway. A brick building 33 by 52 feet will be erected and bids will be asked shortly for the electrical equipment.

**Schenectady (N. Y.) Railway.**—This company has recently put in operation a new substation at Karners, N. Y., which was described in the Electric Railway Review of June 22, 1907. The building is 73 by 57 feet in area, of stone, brick and steel construction and replaces an old frame structure. The equipment includes four 300-kilowatt rotary converters and twelve 10,000-volt air-cooled transformers.

## Personal Mention

Mr. Benjamin H. Glover has resigned as superintendent of motive power of the Metropolitan West Side Railway of Chicago, Ill.

Mr. J. L. Sullivan, master mechanic of the St. Francois County Electric Railway, Farmington, Mo., has resigned, effective on March 9.

Mr. G. F. Moore, general manager St. Joseph Valley Railway, at La Grange, Ind., has resigned to become inspector of general accounts for the interstate commerce commission, with headquarters at Washington, D. C.

Mr. W. F. McCloud, assistant auditor of the Indianapolis & Cincinnati Traction Company at Rushville, Ind., has resigned, effective on March 1, to take charge of the accounting and system work of the Prestolite Company in the general offices of the company at Indianapolis, Ind.

Mr. George H. Shaw has been appointed superintendent of the La Crosse City Railway, succeeding Mr. S. B. Livermore, resigned; effective on March 1. Mr. Shaw was formerly superintendent of the Southern Wisconsin Railway, Madison, Wis., having held this position for 18 years.

Mr. E. C. McCarthy, purchasing agent of the Savannah (Ga.) Electric Company, has been appointed district manager of the southeastern states for Stone & Webster, succeeding Mr. H. H. Hunt. Mr. E. T. Steel, formerly with the Ponce (Porto Rico) Railway & Light Company, has been appointed to succeed Mr. McCarthy at Savannah.

Mr. P. W. Gerhardt has been appointed assistant superintendent of the Minneapolis division of the Twin City Rapid Transit Company of Minneapolis, Minn. Mr. Gerhardt graduated in 1905 from Purdue University and until the latter part of January, 1908, was connected with the testing department of the General Electric Company.

Mr. E. C. Deal, who has been superintendent of the Bergen county division of the Public Service Corporation of New Jersey for several years, has been transferred to Elizabeth, N. J., where he will have general supervision of the Central division, comprising the lines in Union, Middlesex and Somerset counties, this division previously having been in charge of several division superintendents.

Mr. Frank T. Buchanan, who for the past few months has been in the statistical department of Stone & Webster, Boston, Mass., has been appointed superintendent of the Blue Hill Street Railway, Canton, Mass., effective on February 19. Mr. Buchanan formerly was superintendent of the Cape Breton Electric Company, Sydney, N. S., and more recently was in charge of the Key West Electric Company lines at Key West, Fla., both of which are operated by Stone & Webster.

Mr. F. F. Barbour has been appointed assistant to President B. F. Josselyn of the Portland Railway Light & Power Company, Portland, Ore., effective on March 1. Mr. Barbour has been special agent for the General Electric Company at San Francisco and has had an extended experience in electric railway and lighting construction and operation. In his new position he will relieve the president of much of the detail work and afford Mr. Josselyn an opportunity to devote his time to the personal direction of the more general and important matters.

At the annual meeting of the Schenectady (N. Y.) Railway on March 2 Mr. C. S. Sims, vice-president and general manager of the Delaware & Hudson Company, was elected vice-president; Mr. A. L. Linn, Jr., general auditor of the Mohawk Valley Company, New York City, was elected general auditor; and Mr. D. C. Diebell, auditor of the United Traction Company, Troy, N. Y., was elected auditor, succeeding Mr. Frederick Ruby, resigned. Mr. A. H. Harris, general counsel of the New York Central Lines, and Mr. Edgar S. Fassett, general manager of the United Traction Company, were added to the board of directors.

Mr. Edward B. Kirk, general manager of the Sterling Dixon & Eastern Electric Railway, Dixon, Ill., has resigned, effective on March 1, to become general manager of the Atlantic Shore Line Railway, Kennebunkport, Me., succeeding Mr. W. G. McLoon, resigned. Mr. Kirk is a graduate of the electrical engineering department of Purdue University and for several years was superintendent of the Jacksonville (Ill.) Railway & Light Company. Later he was appointed electrical engineer and master mechanic of the Grand Rapids Grand Haven & Muskegon Railway, Grand Rapids, Mich., and more

## Financial News

recently was vice-president and general manager of the Winnebago Traction Company, Oshkosh, Wis. He resigned from this position last July to become general manager of the Sterling Dixon & Eastern Electric Railway at Dixon, succeeding Mr. Henry C. Higgins.

Mr. F. E. Reidhead, who has recently been transferred from Columbus, Ga., to Paducah, Ky., as manager of the Paducah Traction Company and other properties of Stone & Webster of Boston, succeeding Mr. John S. Bleecker, has been manager of the Stone & Webster properties at Columbus for about three years. About five years ago he became superintendent of the Columbus Railroad and two years later, when the Gas Light Company of Columbus and the Columbus Power Company were acquired by Stone & Webster, he was given charge of the three properties with the title of manager. Before going to Columbus he was general superintendent of the Minneapolis General Electric Company. At Paducah Mr. Reidhead will have charge of the lighting and power interests as well as of the street railway. Mr. Bleecker has been transferred to Columbus to succeed Mr. Reidhead, as previously reported.

Mr. H. A. Fisher, whose portrait is presented herewith, is president of the Joliet & Southern Traction Company, operating the Joliet Plainfield & Aurora Railroad, and has recently of the Bloomington Pontiac & Joliet Electric Railway, with headquarters at Joliet, Ill.

Mr. Fisher is a native of Ohio and began his career in the newspaper business, having been at one time editor and publisher of the Elyria Republican. In 1878 he left the newspaper business and became general eastern immigration agent of the Union Pacific Railroad at Toledo, O. He was later assistant general passenger agent of the Wabash Railroad, and then assistant general passenger and ticket agent of the Missouri Pacific Railway at St. Louis. In 1886 he resigned and has since been elected president engaged in the construction and operation of railroads. In December, 1899, he went to Columbus, O., and associated himself with the electric railway construction work in that vicinity. In October, 1903, he resigned as general manager of the Columbus Delaware & Marion Railway to go to Joliet as president of the Fisher Construction Company, which built the Joliet Plainfield & Aurora Railroad.



H. A. Fisher.

Hon. James F. Shaw has resigned as president and general manager of the Boston & Worcester Street Railway and the Boston & Worcester Electric Companies of Boston, Mass., in order to devote more of his time to other affairs. He is now serving his second term in the state senate. Mr. Shaw is first vice-president of the American Street and Interurban Railway Association. Mr. William M. Butler has been elected president of the Boston & Worcester Street Railway and Mr. Arthur E. Child has been elected president of the Boston & Worcester Electric Companies, which is a holding organization for the street railway. Mr. Childs has been vice-president of the holding company.

Mr. Alexander Jackson has resigned as chief dispatcher of the Brooklyn Rapid Transit Company, Brooklyn, N. Y., to accept a similar position with the Public Service Railway of Newark, N. J. Mr. John Weigel has been appointed to succeed him. Mr. Jackson began his service with the company in 1895 as conductor and has served as inspector, clerk in the timetable department and chief of that department. From July, 1903, to August 15, 1906, he was in charge of schedules for the Public Service Corporation of New Jersey. Mr. Weigel started as a motorman at the same time as Mr. Jackson, and after some experience in the shops, became successively inspector, general inspector, assistant division superintendent, clerk and then chief of the timetable department, and chief dispatcher of surface lines. He went with the Public Service Corporation when Mr. Jackson came to the Brooklyn Rapid Transit Company in 1906 and now exchanges positions with him.

**Chicago City Railway.**—Judge Ball of the Cook superior court has dismissed the bill filed by C. H. Venner to enjoin this company from operating under its franchise.

**Chicago Railways Company.**—The special master's deed conveying the properties of the Chicago Union Traction Company to the Chicago Railways Company has been filed of record.

**Chicago & Milwaukee Electric Railroad.**—Holders of a majority of the \$10,000,000 bonds of the Chicago & Milwaukee Electric Railroad of Wisconsin have appointed the following committee to represent bondholders, with authority to consent to an issue of receivers' certificates of not to exceed 10 per cent of the total amount of the bond issue: John V. Clarke and C. B. Sheed of Chicago, and Miller Lash, George A. Somerville and Robert Cassels of Toronto. Holders of this issue of the bonds will be requested to deposit them with the Chicago Title & Trust Company or the National Trust Company of Toronto. A bondholders' protective committee has been organized to represent the holders of Chicago & Milwaukee Electric Railroad, Illinois division, 5 per cent bonds. F. J. Lisman of New York is chairman of the committee.

**Columbus Delaware & Marion Railway, Columbus, O.**—A meeting of shareholders will be held on March 27 to vote on an increase of the capital stock from \$2,500,000 to \$3,000,000.

**Delaware River & Atlantic City Railroad.**—Vice-Chancellor Leaming, Camden, N. J., entered an order on February 27 to show cause why a receiver should not be appointed for this company. The application was made by William Harris, attorney on behalf of Charles T. Maloney of Woodbury, N. J., a stockholder. Pending the return of the order the corporation was restrained from transacting any business except that which pertains to the proceedings in court. The bill filed states that the company was incorporated on July 11, 1899, with a capital of \$6,000,000, to construct an electric railway from the foot of Ferry street, Gloucester City, to the foot of Florida avenue, Atlantic City. The company is indebted to various persons. The complainant asserts that the suspension of efforts to finance, build and operate the railway was caused by a want of funds to carry on the work, and that the company cannot resume its business at any time hereafter with safety to the public and advantage to the stockholders.

**Des Moines (Ia.) City Railway.**—Gross earnings in 1907 were \$779,059 and operating expenses were \$559,550, leaving net earnings of \$219,509. Taxes were \$21,596 and interest amounted to \$158,991, leaving a surplus of \$38,922. From the latter \$22,221 should be deducted on account of depreciation, leaving a final surplus of \$16,701.

**Havana (Cuba) Electric Railway.**—Gross earnings in 1907 were \$1,810,888, as compared with \$1,570,302 in 1906. Net earnings were \$846,156, as compared with \$612,591.

**Indiana Union Traction Company, Anderson, Ind.**—At the annual meeting of shareholders on March 3 the directors were elected. The earnings for 1907 were published in the Electric Railway Review of February 22, 1908, page 249.

**Interborough-Metropolitan Company, New York.**—T. P. Shonts, the president, has offered the Steinway tunnel to the city of New York for \$7,239,477. Mr. Shonts estimates in his letter that the New York & Long Island Railroad and the corporation which controls it, the Interborough Rapid Transit Company, have expended this sum in the construction of the tunnel, purchase of real estate necessary for right of way, interest charges, etc. About \$412,110, it is figured, has been expended for real estate not needed in the operation of the tunnel, but that amount is not included in the total. In payment for the property the company would accept 4 per cent bonds of New York City at par. Mr. Shonts suggests that the city make a contract with the New York & Queens County Railway, which is controlled by the Belmont interests, to operate the tunnel for 25 years upon the following terms: "The expenses of operation to be fixed by agreement at an arbitrary sum to represent the estimated cost, one-half of the sum to be paid by the city, the balance to be met by the company. A single fare of five cents to be charged between Forty-second street and Fourth avenue, Manhattan, and any point on the line of the New York & Queens County Railway."—It is expected that an issue of \$50,000,000 bonds will be made soon by the Interborough Rapid Transit Company, bearing 5 per cent interest and secured by a first mortgage on the power

house and rolling stock, the Steinway tunnel and the Long Island traction properties owned by the company. According to the plan the company will sell \$20,000,000 of the proposed bonds now and use the proceeds to retire \$15,000,000 notes maturing on May 1 and \$5,000,000 floating debt, provided bond market conditions are favorable. If conditions are unfavorable the bonds will be used as collateral security for a new issue of notes. Earnings of the Interborough Rapid Transit Company for the year, 1907, with comparisons, follow:

	1907.	1906.	1905.
Gross .....	\$23,513,172	\$20,916,147	\$18,218,266
Expenses .....	10,316,327	8,793,486	8,245,005
Net .....	\$13,196,645	\$12,122,661	\$ 9,973,261
Other income .....	1,146,322	673,598	701,661
Total income .....	\$14,342,967	\$12,796,259	\$10,674,922
Interest on bonds .....	*4,772,568	3,961,992	3,018,166
Taxes .....	†1,537,977	1,341,074	1,288,614
Total interest and taxes .....	\$ 6,310,545	\$ 5,303,066	\$ 4,306,780
Net income .....	8,032,422	7,493,193	6,368,142
Seven per cent on Manhattan Railway stock ...	4,200,000	3,948,000	3,864,000
Surplus .....	\$ 3,832,422	\$ 3,545,192	\$ 2,504,142
Dividends .....	3,150,000	3,062,500	.....
Surplus .....	\$ 682,422	\$ 482,692	\$ 2,504,142
Operating percentage .....	43.90	42.09	45.26

\*Includes \$3,745,902 interest on bonds, \$1,016,666 interest on 3-year notes and \$10,000 rental. †Taxes include \$162,940 on real estate, \$202,469 on earnings, and \$1,172,568 on structure and personal property.

**London (Ont.) Street Railway.**—Gross earnings in 1907 were \$232,377, an increase of \$29,465 over 1906. Expenses were \$168,925, of which \$11,574 was devoted to maintenance, \$32,883 to power plant expense, \$65,865 to car service and \$27,703 to general expense. Net earnings were \$64,352, and after provision for charges of \$27,229, the net income was \$37,123. Henry A. Everett, the president, refers in the report to stockholders to the erection during the year of a car house and terminal, and to the negotiations started by a committee from the city council for the purchase of the property by the municipality. When the city has legal authority to purchase negotiations will be entered into. An additional issue of \$50,000 bonds will be disposed of to offset the bank overdraft caused by additions to the property. The report contains a statistical statement, compiled by George H. Bentson, secretary and treasurer, concerning the operations from the year 1896 to 1907, inclusive. Some of the figures follow:

	1907.	1906.	1896.
Expenses, per cent of earnings..	72.3	78.5	57.5
Per car-mile, cents—			
Gross earnings .....	16.18	15.48	11.02
Operating expenses .....	*11.70	*12.16	6.34
Net earnings .....	4.48	3.32	4.68
Gross earnings per mile of track.	\$6,989	\$6,452	\$3,990

\*Taxes included.

**Market Street Elevated Passenger Railway, Philadelphia.**—Edward B. Smith & Co. of Philadelphia, in a circular offering for sale a block of the \$10,000,000 of 4 per cent mortgage bonds, state that according to an official estimate the road when completed, in the latter part of this year, will receive fully \$1,500,000 in cash fares per annum. Operating expenses, they say, are expected to be under 50 per cent. The western part of the system has been in operation for more than a year and it is now carrying about 45,000 passengers daily.

**Metropolitan Street Railway, New York.**—The Guaranty Trust Company of New York, as trustee under the general collateral mortgage of 1897, has brought a foreclosure suit in the United States circuit court at New York.

**New York New Haven & Hartford Railroad.**—A report has been filed in the Massachusetts supreme court by Winfield S. Slocum, master in chancery, in connection with the suit filed by Attorney-General Malone of Massachusetts against the ownership of street railways in that state by the New York New Haven & Hartford Railroad. An abstract of the report follows: "The directors of the New York New Haven & Hartford Railroad acquired the stock of the Worcester & Connecticut Eastern Railway, which afterward became the Consolidated Railway Company, which acquired additional powers from Connecticut and did acquire stocks, bonds and securities of street railways named in the information, ex-

cepting those of the Springfield Street Railway. The Consolidated Railway Company acquired all the stock of the Worcester & Southbridge Street Railway, the Worcester & Blackstone Valley Street Railway, the Webster & Dudley Street Railway, the Worcester & Webster Street Railway and a majority of the stock of the Berkshire Street Railway. The Consolidated Railway Company did not directly acquire a majority of the stock of the Springfield Street Railway, but it entered into agreements for the organization of the Springfield Railway Companies and made an agreement with that association, guaranteeing certain dividends on its preferred stock and guaranteeing a certain price upon the preferred stock in a certain event, and the Springfield Railway Companies did acquire a majority of the stock and securities of the Springfield Street Railway. The Consolidated Railway Company has continued to hold the entire capital stock of the Worcester & Webster and the Webster & Dudley street railways. Upon June 25, 1906, the voluntary association known as the New England Investment & Security Company was formed and the Consolidated Railway Company sold and conveyed to it all of the stocks, bonds and securities which it held in the Worcester & Southbridge Street Railway, the Worcester & Blackstone Valley Street Railway, the Berkshire Street Railway and the Springfield Street Railway. The plan of organization of the New England Investment & Security Company was reported to and approved by the directors of the New York New Haven & Hartford Railroad, and an agreement as to the guaranty of its stock was made between the New York New Haven & Hartford Railroad and the Consolidated Railway Company and the New England Investment & Security Company; and the Consolidated Railway Company was a party to the agreement and declaration of trust. Most of the trustees and officers of the New England Investment & Security Company are persons who are directors and officers of the New York New Haven & Hartford Railroad and of the Consolidated Railway Company."

**South Side Elevated Railroad, Chicago.**—The directors have sent a letter to shareholders in which they say: "The directors desire to notify you that in pursuance of the established policy of this company to keep upon a conservative and strictly cash basis they have decided that for the present the dividends should be reduced from a 4 to a 3 per cent basis. The extensive third track and branch construction was greatly delayed by a long strike against the contractors for this work. This interfered with our traffic and prevented the growth of business, which, if no delay had occurred, would naturally have resulted before this time. There has been since October a loss of patronage from the general recession in business, but there are indications that this loss will disappear. Meanwhile the directors wish to keep on hand the usual cash surplus, and also provide funds for the purchase of more cars and the like, without resorting to a floating debt or any of the modern railroad financing, such as the issue of car purchase certificates or the like."

**Third Avenue Railroad, New York.**—Judge Lacombe of the United States circuit court, New York, has authorized the issue of the following receivers' certificates: Dry Dock East Broadway & Battery Railroad, \$100,000 for 25 new cars and taxes; Forty-second Street Manhattanville & St. Nicholas Avenue Railroad, \$200,000 for 50 cars and taxes. The certificates bear 6 per cent interest and mature in one year from the date of issue.

**Toledo & Indiana Railway, Toledo, O.**—On March 2 \$100,000 bonds of this company, dated January 1, 1903, and maturing on January 1, 1928, were sold at auction at Toledo, O., to J. M. Longnecker of Delta, Ind., at 50 per cent of par. The bonds were held as collateral security for the payment of a note.

**United Traction Company, Albany, N. Y.**—George P. Hilton, president of the chamber of commerce of Albany, has been elected a director to succeed James F. McElroy, resigned.

**West Chester Kennett & Wilmington Electric Railway, West Chester, Pa.**—This company has absorbed the property of the controlled Oxford West Grove & Avondale Street Railway, Avondale, Pa.

**West End Street Railway, Boston.**—This company sold at auction in Boston on February 26 the portion of the new issue of 20,218 shares not acquired by shareholders. The stock was bought by Towle & Fitzgerald of Boston at 80¢ and accrued dividend a share.

**Western Ohio Railway, Lima, O.**—Gross earnings in 1907 were \$444,846, as compared with \$385,619 in 1906.

**Dividends Declared.**

Galveston-Houston Electric Company, preferred, 3 per cent.

# Manufactures and Supplies

## ROLLING STOCK.

**Illinois Traction System**, Champaign, Ill., is asking prices on 60 cars.

**Toledo Urban & Interurban Railway**, Toledo, O., has purchased three freight trail cars from Niles Car & Manufacturing Company.

**Ottawa Electric Railway**, Ottawa, Ont., has placed an order with the Preston Car & Coach Company of Preston, Ont., for two single-truck cars.

**Westside Electric Street Railway**, Charleroi, Pa., has placed an order with the G. C. Kuhlman Car Company for two 10-bench open motor cars.

**Southwestern Traction Company**, London, Ont., has placed an order with the Preston Car & Coach Company of Preston, Ont., for six double-truck interurban cars.

**Chicago Railways Company** will receive bids on March 7 for 300 double-truck pay-as-you-enter type cars, as previously reported in the Electric Railway Review. We are officially advised that these bids will be passed upon by the board of supervising engineers before the contracts are closed.

**Pay-As-You-Enter Car Company**, 26 Cortlandt street, New York, has closed contracts with the United Railways Company of St. Louis and The Milwaukee Electric Railway & Light Company whereby the pay-as-you-enter system of fare collection will be used on the new cars of the St. Louis railway and on new and rebuilt cars for the Milwaukee lines.

**St. Louis Car Company** is at the present time engaged in building and shipping cars for the Utah Light & Railway Company, Pittsburg Railways, the Little Rock Railway & Electric Company, the Denver & Interurban Railroad, Northwestern Pacific Railroad, Penn & Franklin Street Railway, Texas Traction Company, Metropolitan Street Railway of Kansas City, San Bernardino Valley Traction Company, Manaos Railway Company of Brazil, and has booked a number of small orders for various roads. The cars for the Little Rock Railway & Electric Company are now being shipped. Mr. Hegerty, general manager of this property, has been highly complimented on the general design and handsome appearance of the new equipment.

**Winnebago Traction Company**, Oshkosh, Wis., which was reported in the Electric Railway Review of February 29 to be in the market for six cars, has placed an order with the American Car Company for four standard Narragansett 15-bench open car bodies, to be mounted on St. Louis Car Company's trucks, with four G.E. motors and Christensen air brakes. In addition to these cars the company will buy two single-truck closed cars, similar to those now in service on the road. The details have not been decided upon. Contracts have been placed with the Baldwin Locomotive Works for eight Class 78-25 electric motor trucks and with the Allis-Chalmers Company for four Bullock 50-horsepower railway motors and AA-4 air brake equipment.

## SHOPS AND BUILDINGS.

**Chicago (Ill.) City Railway**.—Plans have been prepared for a large car house at West Sixty-ninth street and Ashland avenue. It will have a capacity of 250 cars.

**New York City Railway**.—The car barns of this company, occupying the entire block between First and Second avenues and Ninety-sixth and Ninety-seventh streets, New York, were destroyed by fire on February 29. The fire originated in the paint shop on the second floor, where 72 cars were being repainted, and because of the abundance of combustible material on this floor spread so rapidly that it was impossible to save any part of the building. The number of cars destroyed cannot at this time be accurately learned, but the total number will be in the neighborhood of 450. The loss is estimated at \$1,000,000.

## TRADE NOTES.

**Hicks Locomotive & Car Works**, Chicago, has appointed the Empire Steel & Equipment Company, 141 Broadway, New York, its eastern representative.

**Omaha Electrical Show**.—An electrical show will be held in Omaha, Neb., April 13 to 18, under the auspices of the Nebraska Electrical Trades Association. The exhibition will be held in the Auditorium, a building affording about 30,000 square feet of exhibit space. F. A. Nash, president of the

Omaha Electric Light & Power Company, is president of the association.

**Indianapolis Switch & Frog Company**, Springfield, O., has rebuilt its plant, which was destroyed by fire, and is now prepared to fill orders for frogs, switches, crossings and track material.

**Wheeler Condenser & Engineering Company** announces the removal of its general offices to the factory at Carteret, N. J. The New York sales office will, however, be retained at 90 West street, under the management of George D. Atwood.

**R. Woodman Manufacturing Company** of Boston has recently sent a third order of punches to the Wellington Corporation Tramways of Wellington, New Zealand, and the County Borough Brighton, England, has also ordered extensively.

**C. L. Richards**, formerly with the Metropolitan West Side Elevated Railway of Chicago and the Interborough Rapid Transit Company, New York, has joined the mechanical expert staff of the Galena-Signal Oil Company, Franklin, Pa. For the time being Mr. Richards will make his headquarters in the company's New York office.

**Carlyle-Johnson Machine Company**, Hartford, Conn., has recently received an order for 30 of its direct-line shaft-driven clutches from the Remington Arms Company, Ilion, N. Y.; from William Sellers & Co., Philadelphia, an order for 119, which will be used in the new shop of Wolf Brothers in Philadelphia; and from the Mergenthaler Linotype Company an order for 41.

**Adreon & Co.**, Security building, St. Louis, Mo., recently appointed sales agents of the Steel Car Forge Company of Pittsburg, report that they have secured for this company an order of 95,000 tie plates, from the United Railways Company of St. Louis. The entire roadbed, on paved streets, will be embedded in concrete and a base plate alternated with a flat one. The plates are made of  $\frac{1}{8}$ -inch open-hearth steel.

**Wisconsin Engine Company** of Corliss, Wis., has received the resignation of Frank Engelhardt, who was in charge of the Chicago sales office of the company. The Wisconsin Engine Company has decided to close the Chicago office on March 1, and for the time being to conduct the business from that district under the direct charge of C. T. Myers, general sales manager at Corliss.

**Telegraph Signal System** and its method of operation are fully described and illustrated in a 4-column article in Public Service for March. The Telegraph Signal Company, Rochester, N. Y., Chauncey P. Button, general manager, is the manufacturer of the Telegraph Signal System, which includes new devices for placing the semaphore blades along a railway route within the complete control of a dispatcher located at any convenient place.

**E. H. Symington**, manager western sales of the T. H. Symington Company, Baltimore, who suffered a fractured skull by being thrown from his horse in Chicago nearly a year ago, recently returned from a trip around the world, taken in an effort to regain his health. Mr. Symington's doctors now advise him not to return to his work for another six months, and he left on February 26 for another tour. The last time he went via Japan, China, Ceylon, India, Egypt and Europe; this time he is going to South Africa, thence to Tasmania, Australia, New Zealand, Buenos Aires, Rio de Janeiro and Madeira. He hopes to be at work again in his office in the Railway Exchange building, Chicago, by fall.

**W. C. Lawson and J. E. Simons** have formed a partnership under the name of Lawson & Simons, as selling agents for various companies. At present they are prepared to handle long-leaf yellow pine, oak, fir, creosoted lumber, ties, piling, telegraph and trolley poles, tool steel, bolts and nuts, bar iron and steel. Mr. Lawson's experience with the American Car & Foundry Company, and as salesman for the Pressed Steel Car Company and Scullin-Gallagher Iron & Steel Company, and Mr. Simons' varied experience as a railroad mechanical man, combined with his recent commercial experience with the Fitz-Hugh, Luther Company, would seem to assure a successful organization. The new firm's office is located at 505 Fisher building, Chicago.

**E. S. Averill** has connected himself with the Chicago Bailey Company, 260 South Clark street, Chicago, as general sales manager. Mr. Averill was general superintendent of the United States Express Company for 12 years, and more recently was vice-president of the Copper Belt Mines Company. He is well known to railway men in both the east and west through his connection as manager of the express business of the Baltimore & Ohio, Erie and Chicago Milwaukee & St. Paul. The Chicago Bailey Company is the sole manufac-

turer and distributor of "The Chief's Own" metallic packing, which is made to fit any pistons, valves or stems, and is manufactured on specifications. The company states that this packing has been adopted by the United States government for use on its war ships, as well as on stationary plants in its buildings.

Westinghouse Electric & Manufacturing Company advises us that the United States circuit court of appeals for the district of New Jersey has sustained the opinion rendered some time ago in favor of it against the Prudential Insurance Company of Newark, N. J. This suit was brought by the Westinghouse company against the Prudential to restrain it from further infringement of Nolan patent No. 582481, in the use of a direct-current generator manufactured by the Bullock Electric Manufacturing Company, and the United States circuit court district of New Jersey, held that claims 2 and 4 of the patent are valid and infringed by the use of the Bullock generator in question. The feature of the direct-current generator to which this patent relates is the means used for clamping the armature laminae in place, and the particular feature is the means for holding the movable clamping ring or flange in position, a split ring partially located in a circumferential groove in the armature spider being used to hold the clamping plate in position, the ring itself being held from centrifugal movement by a shoulder upon the clamping plate. This is an important feature of construction, as it obviates the use of bolts passing through the laminae for the purpose of holding them together.

The Brady Brass Company, in its litigation with the Ajax Metal Company, has received a favorable decision from the United States circuit court of appeals for the third district of New Jersey, reversing the decision of the lower court. The case has been in the courts since 1903, and was argued on appeal in December last in Philadelphia. The Ajax Metal Company set up the claim that it had invented and patented an alloy capable of holding up within itself more lead than had been previously possible without the use of nickel, and had thus produced a bearing consisting of less than 7 per cent of tin and more than 20 per cent of lead, and the balance copper. The validity of the patent, which was sustained by the trial court, is denied in the decision just rendered. In passing upon the claims of the plaintiff the court says that "the patent is for a product and not for a process. There is no claim for any particular method of combining the constituents of this alloy, and the specification only states the ordinary foundry practice well known and recognized by those skilled in the art." Discussing the metallurgical features, the court says that points upon which the Ajax company bases its claim for novelty of invention were all known and well understood by the trade long before the application for patent. The evidence of experts like Dr. Charles B. Dudley of the Pennsylvania Railroad, Prof. John W. Langley, Dr. Charles F. Chandler and Dr. Joseph W. Richards, is quoted to confirm the main point, that the alloy in question was not patentable, as it "differed in degree and not in kind" from that which had been on the market for a long time. Concerning the claim that the Ajax company had discovered a "critical point," so-called, in copper-tin alloys, the court quotes the testimony of Dr. Albert Sauveur to show that the so-called "critical point" was known at least three years prior to the application for the patent in litigation "by all students who had conducted the necessary experiments." In concluding the opinion the court says: "A mere difference in the proportions of the constituents of an alloy, however useful the result may be, does not entitle the originator to the monopoly of a patent in the absence of other circumstances than those here disclosed. Being of the opinion that the patent in suit is invalid, it is unnecessary to consider other grounds of defense, though we may be permitted to say that the prior public use set up in the answer of the defendant seems to us to have been sustained by the testimony."

#### ADVERTISING LITERATURE.

General Electric Company, Schenectady, N. Y.—New publications include a handsome booklet, known as Bulletin No. 4548, devoted to the application of small motors to machine tools. It illustrates typical examples of direct and alternating current motors installed on a great variety of lathes, drills, grinders, punchers, shears, boring mills and similar tools, which are suggestive of their almost limitless adaptability to this character of service. A short description of typical General Electric motors, rheostats and controllers is followed by 15 pages of excellent half-tone illustrations showing the motors installed on tools of various manufacturers, and running from small portable drills to heavy punches, boring mills and engine lathes. The pamphlet is bound in a light green cover bearing in reproduction a photograph of the interior of an electrically driven shop.—One of the most artistic electric

fan catalogues of the season is Bulletin No. 4560. It is conveniently arranged for reference, two or three fan motors being shown on each page with a brief description in tabulated form and data as to voltage, catalogue numbers, list prices, etc. Descriptions are included of ceiling fans, exhaust fans and some miscellaneous small motors for blowers, drills, buffing and polishing machines, etc. The general color scheme of the book is cream and brown, light tint blocks being used on all the pages. The frontispiece is an excellent reproduction of the painting "Fame," by Edith Prellwitz, and the cover is a portrait medallion in bright colors.

#### THE CLOSED GROOVE RING FIXTURE.

A new window curtain fixture especially adapted for semi-convertible cars has just been perfected by the Curtain Supply Company, Chicago. Illustrations are presented herewith showing cut-away views of this fixture. The new types are made with either front or drop pinch handles or without handles.

Figure 1 is a sectional view of a ring fixture with front pinch handles. This closed groove

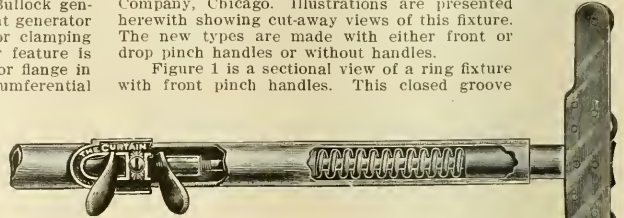

Closed Groove Ring Fixture—Figure 1—Sectional View.

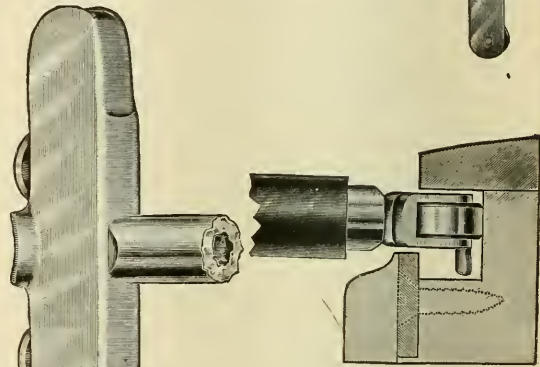

Closed Groove Ring Fixture—Figure 2—View Showing Flange.

Closed Groove Ring Fixture—Figure 3—Application of Steel Confining Strip.

fixture combines the good features of the ring fixtures with several new and important features obtained by flanging a part of the tip and employing a metal confining strip, as illustrated in Figures 2 and 3. The new fixture is self-ripping and the flange on the head in combination with the confining steel strip, as shown in Figure 3, prevents any possibility of escape from the grooves. An additional desirable feature is the peculiar form of the head and flange, which makes it impossible for the fixture to bind when in a canted or oblique position. This fixture can be operated with or without handles and is adjustable to any variation in window opening.

In Figure 4 the fixture is shown in a holding position, a section of the head having been cut away so that the two loosely mounted holding rings may be seen. Any upward pull of the roller causes the ring to rock or jam against the bottom of the grooves and thus holds the curtain in any desired position. Desirable features for which claims are made are: No jarring of the car can make the curtain creep upward, and the curtain may be moved up or down by grasping the fixture at any point along the bottom.

The non-holding position of the fixture is illustrated in Figure 5, which shows the rings out of contact with the grooved bottoms. When the curtain is pulled down the rings recede and the fixture then rests on the anti-friction rollers at either end of the shoes and can be moved freely. The no-

ment the hand is removed from the curtain the upward pull of the roller is again exerted and the rings rock against the grooved bottoms, holding the fixture firmly in place.

The ring fixture as described requires a groove  $\frac{5}{8}$  inch wide and  $\frac{1}{2}$  inch deep under the confining strip, and this strip

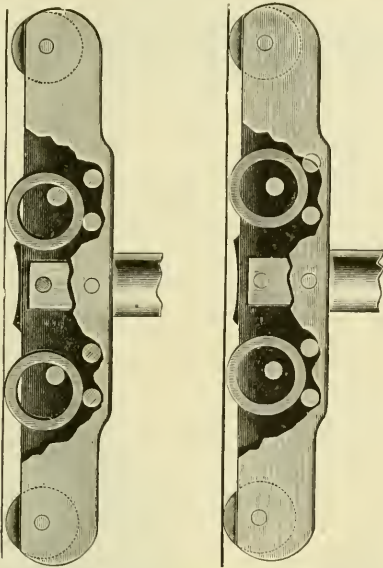

Closed Groove Ring Fixture—Figures 4 and 5—Tips in Holding and Non-Holding Positions.

should be so placed that the opening is  $\frac{3}{8}$  inch wide, the detail arrangement being shown in Figure 3.

THE LUFKIN RULE COMPANY.

The accompanying illustration shows the plant of the Lufkin Rule Company at Saginaw, Mich., to which extensive additions have recently been made. Since its establishment a quarter of a century ago, the company has experienced a phenomenal growth, and today its plant is the largest of its kind in existence.

The rapid rise of this company has been due chiefly to the superior quality of its products, which include steel and cloth measuring tapes, steel and wood rules and a number of other hardware specialties. While all of these are made with the same degree of care in order to maintain that excellence of



Plant of the Lufkin Rule Company, Saginaw, Mich.

quality which has given the company its world-wide reputation, it is through the manufacture of steel measuring tapes that the company is best known to engineers. In fact, the name "Lufkin" has come within the past few years to be linked almost inseparably with "measuring tapes."

In addition to its factory at Saginaw, Mich., the company has in operation a branch at Windsor, Can. Offices are maintained in New York City and in London, Eng. From the London office the large export trade of the company is managed.

THE PORTER ELECTRIC TRACK SWITCH.

Wherever great numbers of cars are operated over special track work it becomes necessary either to place a switch tender at important street intersections during the rush hours or to install an automatic device through the agency of which the motorman on an approaching car can operate the facing switches. Various forms of automatic switch operators have been tried.

In general these are of two classes: (1) those carried on the platform of the car and (2) those installed in the street. The principal reason why that type of switch operator which comprises a mechanical arrangement carried on a car platform is not more generally used is because one such device must be purchased and installed for each end of a car. It is said that such mechanical devices also necessitate very slow running when operating over the switch or its trip.

The second class of automatic switch operators is that which includes electro-magnets or solenoids placed under the pavement to operate the switch points through some train of mechanical apparatus. In general these electric track switches require no special apparatus on the car and have shown themselves to be reliable. The accompanying illustrations will assist in the description of such a device, which not only successfully throws the switch as desired, but automatically locks it so that it will not jar across the jaws or otherwise be thrown except by the motorman, either from his car

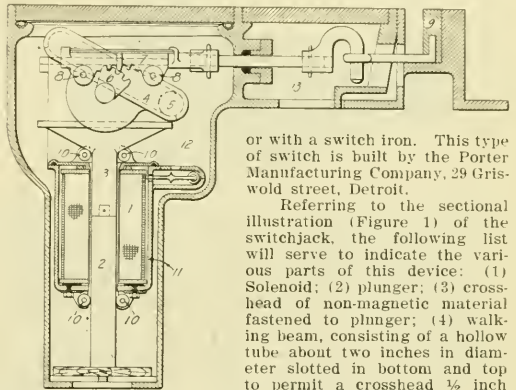

Electric Track Switches—Fig. 1—Sectional View of Porter Switchjack.

or with a switch iron. This type of switch is built by the Porter Manufacturing Company, 29 Griswold street, Detroit.

Referring to the sectional illustration (Figure 1) of the switchjack, the following list will serve to indicate the various parts of this device: (1) Solenoid; (2) plunger; (3) crosshead of non-magnetic material fastened to plunger; (4) walking beam, consisting of a hollow tube about two inches in diameter slotted in bottom and top to permit a crosshead  $\frac{1}{2}$  inch wide to pass through the tube; (5) iron ball loose in tube of walking beam; (6) sectional pinion secured on each side of walking beam; (7) carriage held

in place by (8) four small wheels; (9) tongue of switch; (10) rollers preventing side pull of plunger; (11) case for solenoid, filled with insulating oil; (12) waterproof cast-iron case for mechanism; (13) extension of case provided with separate cover so that switch tongue can be connected to operating mechanism without removing cover of main waterproof case.

The mechanisms contained in the outside castings can easily be withdrawn a single piece at a time and can readily be assembled by a novice, as there are no bolts, screws or special tools required in assembling.

Operation.

When an electric current is sent around the solenoid the plunger and crosshead are pulled up by magnetic attraction, the crosshead coming in contact with the iron ball in the lower part of the walking beam. The pinions fastened to the walking beam are turned through an angle and move the carriage. As soon as the electric current in the solenoid is broken the crosshead and plunger drop by their own weight to their lower position, at the same time releasing the iron ball, which immediately rolls down to the opposite end of the walking beam cylinder. The next time current is applied to the solenoid the same operation is repeated, except that the opposite end of the walking beam is pushed up and the switch tongue is therefore pushed in the opposite direction.

The duty of a motorman, if the switch tongue is set correctly, is simply to let his car drift over the section containing the switch control mechanism. If it is necessary to throw the switch tongue power should be applied to the car as it approaches the switch control mechanism.

Three different methods of wiring Porter switchjacks are used. The method to be used on any railway depends largely on local conditions. These methods are as follows:

(1) Solenoid connected in parallel with low-resistance shunt connected to a section of the trolley wire. (2) Solenoid connected in parallel with low-resistance shunt connected to an insulated section of the railway track. (3) Main solenoid connected from trolley to earth and operated by switch connected to an auxiliary solenoid, which is connected to a switch of the trolley wire.

Figure 2 shows the wiring necessary for operating the switchjack when the main solenoid is connected from the

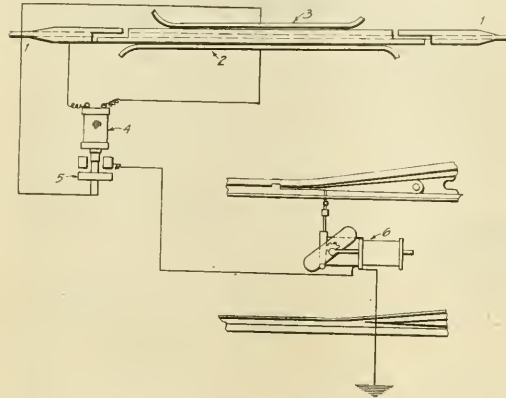

Electric Track Switches—Figure 2—Method of Wiring Switchjack.

trolley to earth by means of switch connected to an auxiliary solenoid.

(1) Is the trolley wire, (2) contact for auxiliary solenoid, (3) contact for main solenoid, (4) auxiliary solenoid, (5) switch operated by auxiliary solenoid, and (6) main solenoid.

The trolley bridge lowers the trolley wheel from the trolley wire and forces the car equipment to take current through the auxiliary solenoid. If the car takes current while the trolley is passing over the bridge this current passes through the auxiliary solenoid, 4, and raises the plunger which throws in switch, 5. This switch connects the main solenoid from the trolley line at contact, 3, to earth. The operation of the

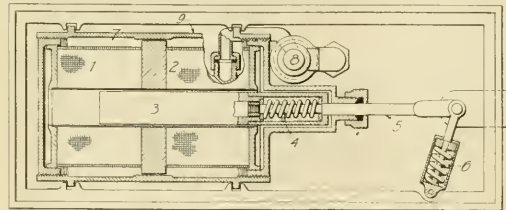

Electric Track Switches—Figure 3—Porter Double Solenoid Switchjack.

switch point by means of the main solenoid is as earlier explained.

The trolley bridge or breaker weighs but 11 pounds and may readily be adjusted on any trolley without cutting the wire. It needs no span wire to hold it up.

Porter's Double Solenoid Switchjack.

Figure 3 shows double solenoid switchjack operator, designed for a pull of 150 pounds. Referring to the illustration (1) and (2) are solenoids, (3) plunger, (4) shock absorber spring, (5) rod connecting plunger with switch point, (6) locking device, (7) cast-iron case filled with insulating oil, (8) pocket for holding connecting wires, (9) cast-iron case for all the mechanism.

This electrical operator is designed to throw a switch in one or other direction every time a car approaches that switch. The wiring required for the double solenoid operator is similar in principle to that illustrated in Figure 2.

In actual service, if it is desired that the car should turn to the left, power is thrown on as the car approaches the trolley bridge. This current flows from the trolley wire through an auxiliary solenoid and contact to the trolley wheel and car. The auxiliary solenoid raises its plunger and connects the right side of the main solenoid from the trolley contact to earth, thus pulling over the switch point.

If it is desired that the car should turn to the right the power is turned off while the trolley wheel is passing across the bridge. The left side of the main solenoid is then connected from the trolley contact through the switch to earth, the plunger of the auxiliary solenoid not being raised. Thus the duty of a motorman is to turn his controller off if he wishes to turn to the right and to turn his controller on if he wishes to turn to the left.

The operation of the double solenoid is simple. The plunger is pulled in one or other direction accordingly as one or other of the solenoids is energized. The shock absorber is a spring which prevents the switch point from being thrown too violently. The locking device holds the switch point in position after the electric current is cut off of the solenoid.

ELECTRIC SHOVELS FOR BALLAST WORK.

Last summer the Chautauqua Traction Company, James-town, N. Y., purchased from the Vulcan Iron Works, Toledo, O., a "Giant Class F" electric shovel and installed it in a gravel pit for digging ballast. The shovel did excellent work up to a few months ago, when it was closed down for the winter. The following is a short description of the new shovel and a few observations as to its work.

The car body is 27 feet long by 7 feet 8 inches wide and is mounted on standard-gauge trucks. It is equipped with a 1 1/2-yard dipper, which has a clear height of lift with door open of 12 feet. It will make a cut at the level of the rails of 26 feet. There are three separate motors, one for hoisting the dipper, one for swinging the crane and a motor on the crane for crowding the dipper into the bank. All motors are



Electrically Operated Shovel.

of the railway type, using direct current at 600 volts pressure and running 700 revolutions per minute. The main or hoisting motor is rated at 75 horsepower; the swing and crane motors are rated at 30 horsepower each.

With the shovel working in a cut 12 feet deep and operating at its full capacity, the hoisting motor drew about 80 amperes of current. At times the load would run up as high as 180 amperes, but this would be only momentary, and would only occur when the man on the crane would crowd the dipper into the bank or when some obstruction in the shape of boulders was met. The crowding or crane motor current averaged about 30 amperes, but when crowding the dipper into the bank with its full force, the load would run up as high as 80 amperes. The swinging motor load averaged between 30 and 40 amperes.

The material dug was a mixture of gravel, sticky clay and sand, but the motors were never overtaxed. The shovel averaged three complete dips and swings per minute with the dipper carrying 1 1/2 cubic yards of material each time. Power was taken directly from the trolley wires.

This type of shovel is winning favor for all work where electric power is available. The design has long since passed the experimental stage, and these shovels are said to be equal in every way of a steam shovel. Important economy is gained because no fireman is needed and no expense for hauling coal or water is required.

Cement Production.

Returns received by the United States geological survey from 87 plants, representing over 95 per cent of the cement production of the United States, indicate that the total output in 1907 was 48,000,000 barrels. This compares with an output of 46,463,424 barrels in 1906 and of 35,246,812 barrels in 1905.



# Washburn "K" Type Traction Coupler Complete with Draft Rigging

**Simple  
Strong  
Durable**



This device is composed of the "K" head—a heavy cast steel extension made in any length—and the "K" pivoted draft box spindle type. Made also in a heavier coupler and with the regulation 6¼ x 8 M. C. B. draft spring.

*Ask for new catalogue of traction devices.*

**Washburn Steel Castings & Coupler Co., Minneapolis, Minn.**

Western Agents: Tweedy, Hood & Finlen, 204 Fisher Bldg., Chicago

Canadian Agent: John Taylor, Montreal

16

# The Moore Track Drill

**does not interfere with traffic!**

The shifting of one lever and a few seconds' time takes down the drill—the operation reversed makes it ready for work again.

This is only one of the many strong points about the Moore Track Drill that make it worth buying.

*Ask for descriptive catalogue.*

**Kalamazoo Railway Supply Co. Kalamazoo Michigan**

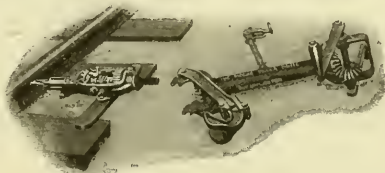
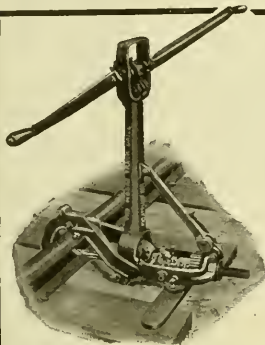

# Baltimore Center and Side Bearings

## FOR ELECTRIC TRUCKS

**Impossible  
to Clog  
Balls**

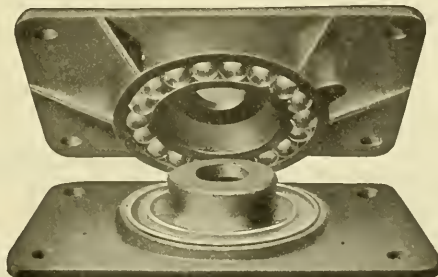

**No  
Lubrication  
Necessary**

**SAVES:** { FLANGE WEAR  
RAIL WEAR  
TRUCK REPAIRS

**DURABILITY:** { PROVEN  
UNDER  
HEAVIEST  
LOADS

BALTIMORE  
MD.

**THE T. H. SYMINGTON CO.**

CHICAGO  
ILL.

## THE J. G. BRILL COMPANY, PHILADELPHIA, PA.

AMERICAN CAR COMPANY, ST. LOUIS, MO.  
 G. C. KUHLMAN CAR COMPANY, CLEVELAND, OHIO  
 JOHN STEPHENSON COMPANY, ELIZABETH, N. J.  
 WASON MANUFACTURING CO. SPRINGFIELD, MASS.

MAIN OFFICE: PHILADELPHIA, PA.  
 LONDON OFFICE: 110 CANNON ST. E. C.  
 PACIFIC COAST AGENTS: PIERSON  
 ROEDING & CO., SAN FRANCISCO.  
 AUSTRALIAN AGENTS: NOYES  
 BROTHERS, SYDNEY. CABLES:  
 "BRILL," PHILA., "AXLES" LONDON.

*CARS TRUCKS SEATS RATTAN SPRINGS SPECIALTIES SUPPLIES*

## SAFE SUMMER SERVICE

The "Narragansett" is the right car for handling crowds safely in excursion service and is the only practical double-truck open car. The width over all is the same as a single-step open car as the upper step is on the flange of a Z-bar sill and within the line of the posts. The best possible arrangement of the running board of a single step car with the minimum height of floor is 19½ inches to board and 17 inches to floor. The same height in the "Narragansett" is divided into 16, 13 and 7½ inches. Companies which have used "Narragansett" cars for a number of years have recently reported that they have had no accidents. Women, children and elderly persons can get in and out easily and quickly. The Z-bar sills make it the strongest open car ever built. The arrangement does not reduce the length of the seats. Write for catalog.

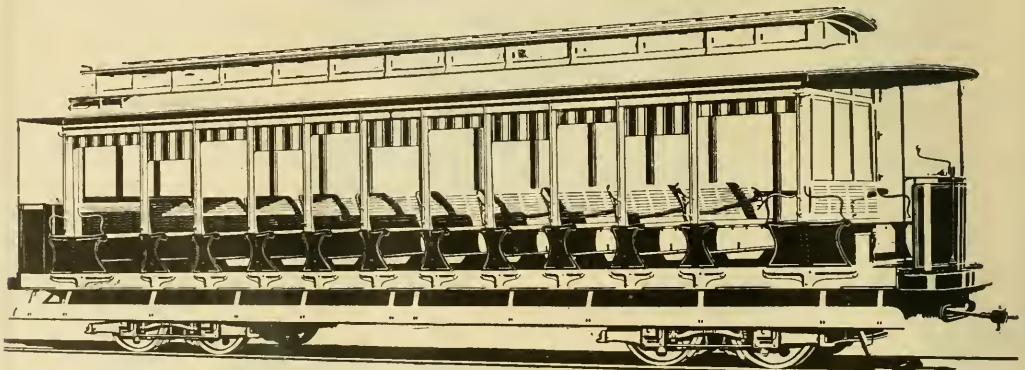

*THE BRILL "NARRAGANSETT" CAR (PATENTED)*

# General Electric Company

## Two Aids to Better Service

The GE Luminous  
Arc Headlight



Increases safe  
speed at night

Belmont Tunnel  
New York City



Lighted by GE Lumi-  
nous Arc Headlight

---

Track brilliantly illuminated for 1-3 mile

---

The GE Luminous Arc Headlight is suitable for operation either in series with car-lighting system or substitutional resistance.

Operated at 4 amperes direct current. Can be adjusted for any line voltage from 450 to 650. More efficient than any other headlight.

Arc maintained at focus of reflector, insuring permanent direction of rays.

Life of electrodes: 2,000 to 3,000 hours for upper; 50 to 75 hours for lower.

Lower electrode needs adjusting but once in ten hours. No enclosing globe used.

Light can be dimmed by reversing current through lamp—no expense or bother of having incandescent lamp or screen.

---

Improved illumination with reduced expense

Principal Office:

Chicago Office:  
Monadnock Bldg.

**Schenectady, N. Y.**

Sales Offices in  
All Large Cities

# Stuart-Howland Co.

Everything Electrical  
BOSTON

## FOR EVERY KIND OF MEASURING

there's a reliable and absolutely accurate steel tape made by

**THE LUFKIN RULE CO.**

SACINAW, MICH., U. S. A.

New York  
London, England  
Windsor, Canada



## E. C. Van Valkenburgh

Promotional Advertising  
for Electric Railways

2117 West 102d Street : Chicago

A definite plan—good copy—careful attention to detail—these are the essential features of Van Valkenburgh Advertising Service.

## The Green Fuel Economizer Co.

MATTEAWAN, N. Y.

New York, Boston, Chicago, Atlanta, San Francisco,  
Los Angeles, Seattle, Salt Lake City, Montreal.

Engineers: Builders of Green's Fuel Economizers, Fans, Blowers and Exhausters, Steam Air Heater Coils, Waste Heat Air Heaters, Mechanical Draft, Heating and Ventilating and Drying Apparatus, Draft Dampers and Engines.

WRITE FOR CATALOGS.

## Queen Testing Sets

"The Recognized Standard"

Voltmeters  
Ammeters  
Switchboard  
and Portable  
Alternating  
and Direct  
Current



Queen Acme Testing Set

U. S. Standard Testing Sets  
Rail Bond Testers  
Galvanometers, etc., etc.  
Electrical Instruments for All Purposes

**QUEEN & CO., Inc., Philadelphia, Pa.**

## WESTON Standard Portable Direct-Reading



Voltmeters  
Millivoltmeters  
Voltammeters  
Ammeters  
Milliammeters  
Ohmmeters  
Ground Detectors  
and Circuit Testers

Our STATION VOLTMETERS and AMMETERS are unsurpassed in point of extreme accuracy and lowest consumption of energy.

## WESTON ELECTRICAL INSTRUMENT CO.

Main Office and Works: Waverly Park, Newark, N. J.

London Branch: Audrey House, Ely Place, Holborn, Paris, France: E. H. Cadot, 12 Rue St. Georges. New York Office: 71 Cortlandt St. Berlin: European Weston Electrical Instrument Co., Ritterstrasse, No. 88.

# Independent Investigation

of the modern bonding and rebonding methods

## Electric Brazing and Copper Welding

will prove the truth of our claim

→that they are the only methods of reasonable cost producing perfect mechanical and electrical union of bond and rail, and possessing long life.

We will gladly send the names of users upon your request. Then ask what they think.

**THE ELECTRIC RAILWAY IMPROVEMENT COMPANY**

6005 Carnegie Avenue

CLEVELAND, OHIO

11

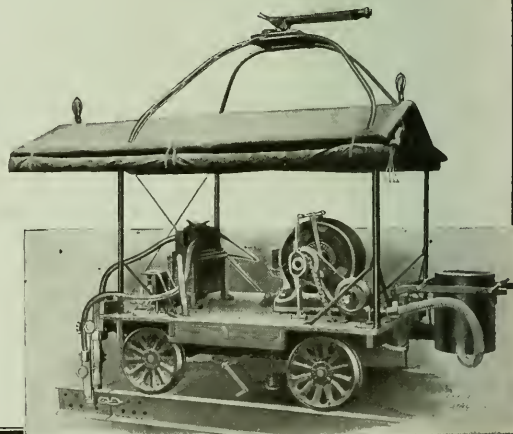

# Electric Railway Review

PUBLISHED EVERY SATURDAY.

FORMERLY THE STREET RAILWAY REVIEW.

THE WILSON COMPANY, CHICAGO.

160 Harrison Street, Chicago  
150 Nassau Street, New York  
1525 Williamson Bldg., Cleveland

Vol. XIX  
No. 11

CHICAGO, MARCH 14, 1908

Whole No.  
255

Subscription: Domestic . . . \$2  
Foreign . . . \$5  
Canada . . . \$3.50

## A Practical Book

*For Every Man*

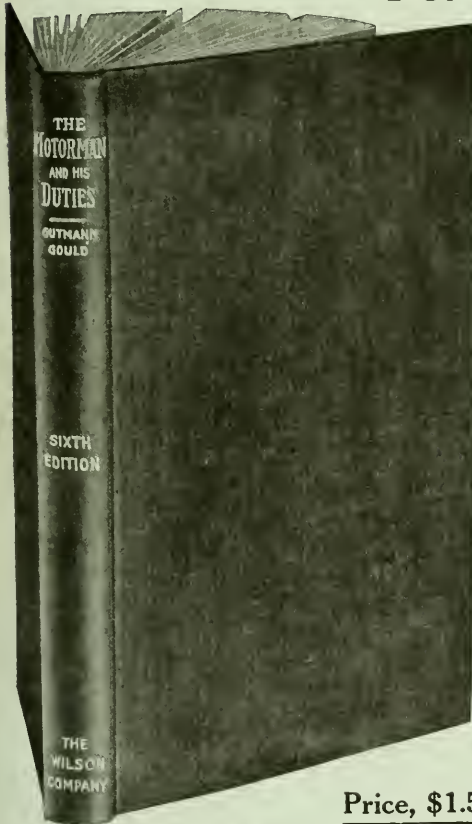

whose services will be made more valuable to himself and to his employer by acquiring intimate knowledge of the principles governing the operation of electric railway cars.

*Buy, read and study this book! A practical application of the knowledge imparted will result in better, safer and more economical operation.*

*“The Motorman and His Duties”* explains in simple language, free from mathematics and technicalities, many points not generally comprehended. It outlines clearly the relation existing between the track, overhead, power station and the car itself.

No other book completely covers the subject in a manner so easily understood!

*“The Motorman and His Duties,”* in the eleven chapters of its recently published sixth edition, comprises 198 pages, 5 by 7 inches, attractively bound in green cloth. It is illustrated by 138 halftones and zinc etchings. It includes a subject index, a glossary and three large inserts of car wiring diagrams.

**Price, \$1.50 per Copy, Prepaid**

Send your address on a postal for a 16-page pamphlet of sample pages, etc.

**The Wilson Company** 160 Harrison Street  
CHICAGO, U. S. A.

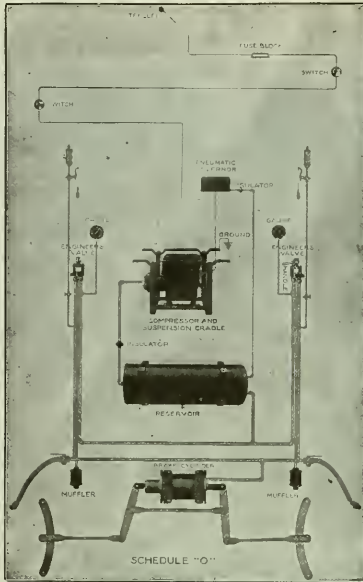

Diagram of National Straight Air Brake Equipment for Double End Motor Car.

# NATIONAL Air Brakes

¶ The accompanying illustration shows the National Straight Air Brake equipment for single-car service.

¶ This equipment is recognized as the standard of efficiency, simplicity and reliability.

¶ The careful design and construction of the component parts of the apparatus make "National Air Brakes" the most compact, efficient and serviceable brakes for traction service and permit of a maximum of economy in operation and maintenance.

*Bulletins sent on request.*

**National Brake & Electric Co.**  
MILWAUKEE, U. S. A.

NEW YORK: 111 Broadway  
PHILADELPHIA: W. H. Goble, 1722  
Westmoreland Street.  
BOSTON: F. E. Huntress, 131 State St.

SAN FRANCISCO, CAL.: W. F. McHenry,  
69-71 First Street.  
LONDON: 14 Great Smith Street, Westminster.

General Sales Office: 519 First National Bank Bldg., Chicago

# C. A. W. Motors and Dynamos

We claim for them the advantages of perfect commutation, coolness in operation, high efficiency, substantial construction, interchangeable parts, high quality of insulation, perfect balance, and pleasing appearance.

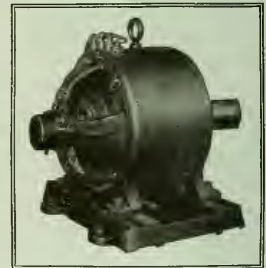

*Ask, please, for booklet and information about our offer of a 30-day free test*

**CLEVELAND ARMATURE WORKS, CLEVELAND, OHIO**

*America's Greatest Armature Winding, Commutator and Field Works*

# Westinghouse

## Protective Apparatus

### Danger of Fire

can be practically eliminated by care and watchfulness, but

### Westinghouse Protective Apparatus

is essential to insure your apparatus against damage from heavy or light static discharges

### Our "MP" Arrester is a Popular Type

Ask for our Circulars Nos. 1132 and 1146



## Westinghouse Electric & Mfg. Co.

Atlanta  
Baltimore  
Boston

Buffalo  
Chicago  
Cincinnati

Cleveland  
Dallas  
Denver

Detroit  
Kansas City  
Los Angeles  
Minneapolis

New Orleans  
New York  
Philadelphia

Pittsburg  
St. Louis  
Salt Lake City

San Francisco  
Seattle  
Syracuse

Canada: Canadian Westinghouse Co., Ltd., Hamilton, Ontario Mexico: G. & O. Braniff & Co., City of Mexico

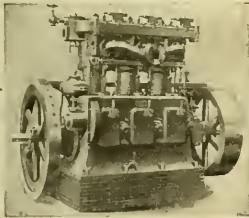

## Single-Acting Gas Engines

Confidence in the merits of any machine is best inspired by an intimate knowledge of its construction, operation and field of usefulness. To those not familiar with the subject, Booklet No. 7006, "Gas Power," presents complete information on the construction in detail and operation of Westinghouse Single-Acting Gas Engines, with a brief synopsis of some important installations.

You can procure a copy of Booklet No. 7006 from any of our sales offices.

**The Westinghouse Machine Co.**  
Pittsburg, Pa.

## The Substitution of Air Brakes for Hand Brakes

on electric cars is as great a step in advance as was the substitution of electric motors for horses and mules as a motive power. A step in advance of no less importance in the art of braking is the

### Westinghouse "AMM" Automatic Air Brake

for one, two, three, four and five car train service. It is the only electric car brake equipment having graduated-release, quick-recharge, quick-service and high-pressure emergency features, with all they imply.

Ask nearest office for further particulars

**Westinghouse Traction Brake Co.**  
Pittsburg, Pa.

## ALPHABETICAL INDEX TO ADVERTISEMENTS.

Advance Lumber Co. ....24	Dearborn Drug & Chemical Works .....14	Meyers, Fred J. Mfg. Co. ....18	Smith, Peter, Heater Co. ....22
All-Chalmers Co. ....12	Dossert & Co. ....12	Miller Anchor Co. ....15	Speer Carbon Co. ....18
Aluminum Co. of America. ....12	Drouvé, G. Co. ....12	Milloy Electric Co. ....22	Standard Brake Shoe Co. ....22
American Brake Shoe & Fry. Co. ....12	Drummond Detective Agency. ....12	Model Stoker Co. ....15	Standard Motor Truck Co. ....22
American Electrical Works. ....12	Eldridge Railway Supply Co. ....18	Mortien Frog & Crossing Wks. Co. ....22	Standard Paint Co. ....16
American Frog & Switch Co. ....12	Electric Railway Equipment Co. ....26	National Brake & Electric Co. 2	Standard Steel Works. ....18
Anderson, Albert & J. M. Mfg. Co. ....26	Electric Ry. Improvement Co. ....27	National Lock Washer Co. ....23	Standard Underground Cable Co. ....24
Armstrong Oilier Co. ....22	Electric Service Supplies Co. ....27	National Pole Co. ....23	Standard Varnish Works. ....24
Arnold Company. ....22	Engineers and Contractors. ....27	Naugle Pole & Tie Co. ....24	Star Brass Works. ....18
Atlas Anchor Co. ....18	Fairbanks, Morse & Co. ....21	New York Switch & Crossing Co. ....22	Stone & Webster Engineering Corporation .....15
Automatic Trolley Guard Co. 21	Ford, Bacon & Davis. ....22	Niles Car & Mfg. Co. ....23	Stuart-Howland Co. ....20
Babcock & Wilcox Co. ....12	Galena-Signal Oil Co. ....23	Northern Engineering Works 13	Symington, T. H. Co. ....30
Baker, Wm. C., Heating & Supply Co. ....21	General Electric Co. ....23	Nuttall, R. D. Co. ....23	Telegraph Signal Co. ....19
Baldwin Locomotive Works. 18	Green Engineering Co. ....21	Ohio Brass Co. ....23	Trolley Supply Co. ....19
Barbour-Stockwell Co. ....24	Green Fuel Economizer Co. ....21	Okonite Co., Ltd. ....13	Under-Feed Stoker Co. ....18
Barnes, G. H., Hardwood Lumber Co. ....24	Green Wheel Co. ....22	Pacific Coast Pole Co. ....24	U. S. Metal & Mfg. Co. ....19
Beidler, Francis, & Co. ....24	Hagy, J. Milton, Waste Wks. 12	Pantastoc Co. ....30	Van Dorn & Dutton Co. ....13
Bellamy Vestelite Mfg. Co. 25	Hahn & Kilburn Mfg. Co. ....23	Paton, Paul B. Co. ....21	Van Dorn, W. T., Co. ....25
Berthold & Jennings. ....19	Hartshorn, Stewart, Co. ....23	Pay-As-You-Enter Car Co. 9	Van Valkenburgh, E. C. ....25
Bliss, R. Mfg. Co. ....14	Heine Safety Boiler Co. ....21	Porter Mfg. Co. ....22	Wanted and For Sale Cards. ....20, 21
Bridgeport Brass Co. ....30	Heywood Bros. & Wakefield Co. ....30	Power Specialty Co. ....25	Washburn Steel Castings & Coupler Co. ....27
Brill, J. G., Co. ....28	Holman, D. F., Ry. Tracklayer Co. ....24	Pressed Steel Car Co. ....17	Watson-Stullman Co. ....25
Brown, Harold P. Co. ....19	Hope Webbing Co. ....30	Queen & Co. ....16	Wendell & MacDuffie. ....25
Brown Hoisting Machy. Co. 14	Humbird Lumber Co., Ltd. ....20	Rail Joint Co. ....15	Western Electric Co. ....5
Buckeye Engine Co. ....24	Indestructible Fibre Co. ....20	Railway Specialty & Supply Co. ....25	Westinghouse Elec. & Mfg. Co. ....3
Burnham, Williams & Co. ....18	Jewett Car Co. ....17	Railway Steel-Spring Co. ....21	Westinghouse Machine Co. 3
Byllesby, H. M., & Co. ....22	Johann, F. A. ....21	Recording Fare Register Co. 30	Westinghouse Traction Brake Co. ....3
Central Inspection Bureau. ....22	Johns-Manville, H. W., Co. 5	Register, A. L., & Co. ....22	Wilson Electrical Instrument Co. ....16
Chase-Shawmut Co. ....26	Joseph, Isaac, Iron Co. ....21	Relter, G. C. ....22	Wharton, Wm. Jr., & Co. ....13
Chicago Mica Co. ....19	Kalamazoo Ry. Supply Co. ....27	Roberts & Abbott Co. ....22	Wheeler Condenser & Eng'g Co. ....22
Churchill Cedar Co. ....24	Kinnear Manufacturing Co. ....26	Robertson, Wm., & Co. ....22	Wheel Trailing Brake Shoe Co. ....22
Cincinnati Car Co. ....24	Lindsay Bros. Co. ....24	Rodger Ballast Car Co. ....17	White, J. G., & Co. ....22
Cleveland Armature Works. 2	Lorain Steel Co. ....15	Rose Automatic Register Co. 21	Whitmore Mfg. Co. ....16
Cleveland Frog & Cross. Co. ....23	Lord & Burnham Co. ....25	Russell Car & Snow-Plow Co. 18	Widener & Eng'g Co. ....25
Collier, Barron G. ....23	Lufkin Rule Co. ....30	S-E. Missouri Cypress Co. ....24	Woodbury Carlton Co. ....25
Columbia Construction Co. 22	Lumen Bearing Co. ....12	St. Louis Car Co. ....11	Woodman, R., Mfg. & Supply Co. ....18
Columbus Ry. & Light Co. ....21	Macellen Co. ....24	St. Louis Car Wheel Co. ....13	Worcester, C. H. Co. ....24
Consolidated Car Fender Co. 25	McGuire-Cummings Mfg. Co. ....21	St. Louis Surfacter & Paint Co. ....12	Zelnicke, Walter A., Supply Co. ....21
Consolidated Car-Heating Co. 22	Marshall, R. W., & Co. ....21	Sanderson & Porter. ....12	
Contractors' Supply & Equipment Co. ....22		Saxton, E. Co. ....22	
Cooper Heater Co. ....25		Shimer & Chase Co. ....22	
Crane Co. ....24		Sheaf & Jastaad. ....22	
Creighthead Engineering Co. 22		Simmons, John, Co. ....18	
Curtain Supply Co. ....22			
Davis, John, Co. ....21			

## CLASSIFIED LIST OF ADVERTISERS.

Advertising Service. Van Valkenburgh, E. C., 2117 West One Hundred and Second St., Chicago.	Asbestos Materials. Johns-Manville, H. W., Co., New York.	Bells and Gongs—Continued. McGuire-Cummings Mfg. Co., Chicago. Ohio Brass Co., Mansfield, O. Relter, G. C., Canton, O. St. Louis Car Co., St. Louis, Mo. Stephenson, John, Co., Elizabeth, N. J. Wason Mfg. Co., Springfield, Mass. Western Electric Co., Chicago.	Brackets and Cross Arms. Anderson, Albert & J. M., Mfg. Co., Boston. Crescent Engineering Co., Cincinnati, O. Electric Railway Equipment Co., Cincinnati, O. Electric Service Supplies Co., 200 Plymouth Bldg., Chicago. Johns-Manville, H. W., Co., New York, N. Y. Lindsay Bros. Co., Spokane, Wash. Ohio Brass Co., Mansfield, O. Ridlon, Frank, Co., 200 Summer St., Boston. Stuart-Howland Co., Boston. Western Electric Co., Chicago.
Advertising, Street Car. Collier, Barron G., Flat Iron Bldg., New York.	Axles—(See Wheels and Axles).	Block System—(See Signals).	Brakes and Brake Parts. Allis-Chalmers Co., Milwaukee, Wis. American Car Co., St. Louis. Brill, The J. G., Co., Philadelphia. Electric Service Supplies Co., 200 Plymouth Bldg., Chicago. General Electric Co., Schenectady, N. Y. Kuhlman, The G. C., Car Co., Cleveland. McGuire-Cummings Mfg. Co., Chicago. National Brake & Electric Co., Milwaukee. Stephenson, John, Co., Elizabeth, N. J. Wason Mfg. Co., Springfield, Mass. Westinghouse Traction Brake Co., Pittsburg, Pa.
Air Brakes—(See Brakes and Brake Parts).	Badges and Buttons. Electric Service Supplies Co., 200 Plymouth Bldg., Chicago. Recording Fare Register Co., New Haven, Conn.	Blowers—(See Mechanical Draft)	Brakeshoes. American Brake Shoe & Fry. Co., Mahwah, N. J. American Car Co., St. Louis. Barbour-Stockwell Co., Cambridgeport, Mass. Brill, The J. G., Co., Philadelphia. Kuhlman, The G. C., Car Co., Cleveland. McGuire-Cummings Mfg. Co., Chicago.
Air Compressors—(See Compressors, Air).	Ballast Cars—(See Cars, Ballast).	Blue Printing Machines. Buckeye Engine Co., Salem, O.	
Alloys and Bearing Metals. Brown, H. P., 120 Liberty St., New York. General Electric Co., Schenectady, N. Y. Lumen Bearing Co., Buffalo, N. Y. Ohio Brass Co., Mansfield, O. Ridlon, Frank, Co., 200 Summer St., Boston. St. Louis Car Co., St. Louis, Mo.	Ball Bearings. Symington, T. H., Co., Baltimore, Md.	Bollers. Babcock & Wilcox Co., N. Y. Fairbanks, Morse & Co., Chicago. Green Fuel Economizer Co., Mattawan, N. Y. Heine Safety Boiler Co., 421 Olive St., St. Louis. Lord & Burnham, Irvington-on-Hudson, New York.	
Aluminum Wire, Etc. Aluminum Co. of America, Pittsburg.	Bases—(See Trolley Poles and Fittings).	Bonds, Rail. Brown, H. P., 120 Liberty St., New York. Chase-Shawmut Co., Newburyport, Mass. Electric Railway Improvement Co., Cleveland, O. Electric Service Supplies Co., 200 Plymouth Bldg., Chicago. General Electric Co., Schenectady, N. Y. Johns-Manville, H. W., Co., New York.	
Anchors. Atlas Anchor Co., Cleveland, O. Electric Service Supplies Co., 200 Plymouth Bldg., Chicago. Miller Anchor Co., Newark, O. Ohio Brass Co., Mansfield, O.	Bearing Service Supplies Co., 200 Plymouth Bldg., Chicago. General Electric Co., Schenectady, N. Y. Lumen Bearing Co., Buffalo, N. Y. McGuire-Cummings Mfg. Co., Chicago. Marshall, R. W., & Co., 95 Liberty St., New York. Nuttall, R. D., Co., Pittsburg. Ohio Brass Co., Mansfield, O. Ridlon, Frank, Co., 200 Summer St., Boston. Symington, T. H., Co., Baltimore, Md. Van Dorn & Dutton Co., Cleveland, O.	Bolier Cleaning Compound. Dearborn Drug & Chemical Works, Chicago. Johns-Manville, H. W., Co., New York.	
Armatures and Coils, Winding and Repairing. Cleveland Armature Works, Cleveland, O. Electric Service Supplies Co., 200 Plymouth Bldg., Chicago. General Electric Co., Schenectady, N. Y. Marshall, R. W., & Co., 95 Liberty St., New York. Ridlon, Frank, Co., 200 Summer St., Boston. Stuart-Howland Co., Boston.	Bells and Gongs. American Car Co., St. Louis. Brill, The J. G., Co., Philadelphia. Electric Service Supplies Co., 1020-24 Filbert St., Phila. Kuhlman, The G. C., Car Co., Cleveland.		





# A. C. GENERATORS

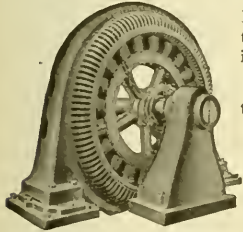

From your standpoint as the user, the three most important features of

A. C. GENERATORS to be considered are Heating, Regulation and Efficiency.

The heating is kept low by a generous and especially well ventilated design of those parts in which heat is developed.

Perfect regulation is obtained by so proportioning the parts as to reduce to the

lowest possible value the quantities which tend most strongly against good regulation.

## WESTERN ELECTRIC A. C. GENERATORS

will give you the highest average or all-day-efficiency.

Send for a copy of our Catalogue No. 5210-A on *Alternators*

## Why J-M Insulated Cross-Overs Outwear Others

The flexible ears attached to ends of each arm of J-M INSULATED CROSS-OVERS are the only parts subject to wear. These can be easily and quickly removed and replaced at a small cost, without removing Cross-Over from the line. Consequently, J-M CROSS-OVERS outwear all others.

Crystallization of the wire at the ends of these Cross-Overs, due to hammering effect of the trolley wheel, is overcome by the straight underrun with flexible end pieces.

J-M CROSS-OVERS are made of heavily galvanized malleable iron with flexible ears and insulated with thoroughly seasoned fibre between wires. Can be installed without cutting trolley wire.

Write nearest branch for booklet.

## H. W. JOHNS-MANVILLE COMPANY

NEW YORK	PITTSBURGH	MINNEAPOLIS
MILWAUKEE	CLEVELAND	SAN FRANCISCO
CHICAGO	BUFFALO	LOS ANGELES
BOSTON	BALTIMORE	SEATTLE
PHILADELPHIA	NEW ORLEANS	DALLAS
ST. LOUIS	KANSAS CITY	LONDON

765

# STANDARD HIGH-SPEED "INTERBOROUGH" DOUBLE TRUCK

TYPE C-60

"Solid Forged"

WITHOUT WELDS

FRAMES ARE MADE FROM ROLLED OPEN-HEARTH STEEL WITHOUT WELDS. ALL WEARING BOLTS ARE TURNED AND CASE HARDENED, AND WEARING HOLES STEEL THIMBLED. M. C. B. STANDARD PRINCIPLES ARE FOLLOWED. WE ARE PREPARED TO BUILD TRUCKS IN ACCORDANCE WITH PURCHASER'S DESIGNS AND SPECIFICATIONS.

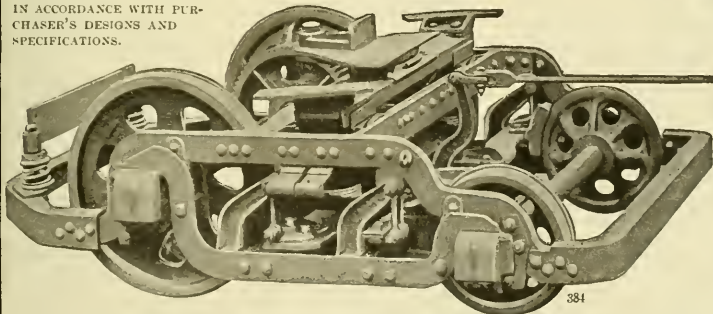
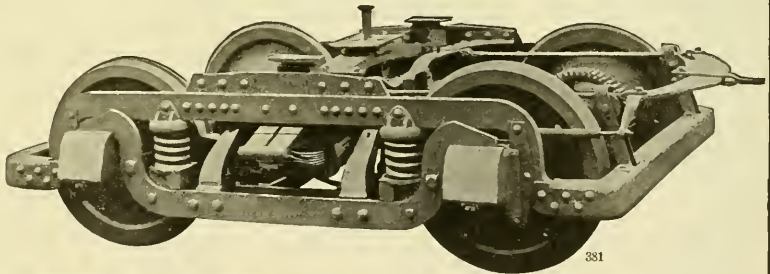

## STANDARD "MAXIMUM TRACTION" DOUBLE TRUCK

CITY AND SUBURBAN TYPE O-45

OVER TWO HUNDRED OF THESE "MAXIMUM TRACTION" TRUCKS ARE IN SERVICE IN BROOKLYN, NEW YORK, AND ARE PRONOUNCED "HIGHLY SATISFACTORY."

STANDARD MOTOR TRUCK COMPANY, FRICK BUILDING, PITTSBURGH, PENNSYLVANIA  
 NEW YORK OFFICE: 170 BROADWAY WORKS: NEW CASTLE, PA. CHICAGO OFFICE: FISHER BUILDING

## CLASSIFIED LIST OF ADVERTISERS—Continued.

- Brakeshoes—Continued.**  
 Marshall, R. W. & Co., 95 Liberty St., New York.  
 St. Louis Car Co., St. Louis, Mo.  
 Standard Brake Shoe Co., Aurora, Ill.  
 Stephenson, John, Co., Elizabeth, N. J.  
 Wason Mfg. Co., Springfield, Mass.  
 Wharton, Wm., Jr. & Co., Philadelphia.  
 Wheel Truing Brake Shoe Co., Detroit.
- Bridges.**  
 Johann, F. A., 1624 Pierce Bldg., St. Louis.
- Bridge Timbers.**  
 Beidler, Francis, & Co., Chgo.
- Brushes, Motor and Dynamo.**  
 Electric Service Supplies Co., 200 Plymouth Bldg., Chicago.  
 General Electric Co., Schenectady, N. Y.  
 Ridon, Frank, Co., 200 Summer St., Boston.  
 Speer Carbon Co., St. Marys, Pa.
- Bumpers, Car.**  
 American Car Co., St. Louis.  
 Brill, The J. G., Co., Philadelphia.  
 Kuhlman, The G. C., Car Co., Cleveland.  
 St. Louis Car Co., St. Louis, Mo.  
 Stephenson, John, Co., Elizabeth, N. J.  
 Wason Mfg. Co., Springfield, Mass.
- Car House Doors.**  
 Klinear Mfg. Co., Columbus, O.  
 Wilson, J. G., Mfg. Co., New York.
- Car Replacers.**  
 Electric Service Supplies Co., 200 Plymouth Bldg., Chicago.  
 Fairbanks, Morse & Co., Chgo.  
 Kalamazoo Railway Supply Co., Kalamazoo, Mich.  
 Ohio Brass Co., Mansfield, O.  
 U. S. Metal & Mfg. Co., 25 Broad St., New York.
- Car Roof Paint, Canvas.**  
 St. Louis Surface & Paint Co., St. Louis, Mo.
- Car Seats.**  
 American Car Co., St. Louis.  
 Brill, The J. G., Co., Philadelphia.  
 Hale & Kilburn Mfg. Co., Philadelphia.  
 Heywood Bros. & Wakefield Co., Wakefield, Mass.  
 Kuhlman, The G. C., Car Co., Cleveland.  
 St. Louis Car Co., St. Louis, Mo.  
 Stephenson, John, Co., Elizabeth, N. J.  
 Wason Mfg. Co., Springfield, Mass.
- Car Signs—(See Signs, Cars and Track).**
- Car Steps.**  
 Electric Service Supplies Co., 200 Plymouth Bldg., Chicago.
- Car Trimmings—(See Trimmings, Car).**
- Cars, Ballast.**  
 Rodger Ballast Car Co., Chgo.  
 St. Louis Car Co., St. Louis, Mo.
- Cars, Dump.**  
 Fairbanks, Morse & Co., Chgo.  
 Rodger Ballast Car Co., Chgo.  
 Russell Car & Snow-Plow Co., Ridgway, Pa.  
 St. Louis Car Co., St. Louis, Mo.
- Cars, Passenger and Freight.**  
 American Car Co., St. Louis.  
 Brill, The J. G., Co., Philadelphia.  
 Cincinnati Car Co., Cincinnati.  
 Detroit Carbuilding & Equipment Co., Detroit, Mich.  
 Electric Railway Improvement Co., Cleveland, O.  
 Fairbanks, Morse & Co., Chgo.  
 Jewett Car Co., Newark, O.  
 Johann, F. A., 1624 Pierce Bldg., St. Louis.  
 Kuhlman, The G. C., Car Co., Cleveland.  
 McGuire-Cummings Mfg. Co., Chicago.  
 Niles Car & Mfg. Co., Niles, O.
- Cars, Passenger and Freight—Continued.**  
 Pressed Steel Car Co., Pittsburg.  
 Rodger Ballast Car Co., Chgo.  
 Russell Car & Snow-Plow Co., Ridgway, Pa.  
 St. Louis Car Co., St. Louis, Mo.  
 Standard Motor Truck Co., Pittsburg.  
 Stephenson, John, Co., Elizabeth, N. J.  
 Wason Mfg. Co., Springfield, Mass.
- Cars, Pay-As-You-Enter.**  
 Pay-As-You-Enter Car Co., 26 Cortlandt St., New York.
- Cars, Rebuilt.**  
 Detroit Carbuilding & Equipment Co., Detroit, Mich.
- Cars, Second-Hand.**  
 Detroit Carbuilding & Equipment Co., Detroit, Mich.  
 Joseph, Isaac, Iron Co., Chicago, Ill.  
 Marshall, R. W. & Co., 95 Liberty St., New York.  
 Zelnicker, Walter A., Supply Co., St. Louis.
- Cars, Steel.**  
 Pressed Steel Car Co., Pittsburg.  
 St. Louis Car Co., St. Louis, Mo.  
 Standard Motor Truck Co., Pittsburg.
- Castings, Brass.**  
 Star Brass Works, Kalamazoo, Mich.
- Castings, Iron and Steel.**  
 American Brake Shoe & Foundry Co., Mahwah, N. J.  
 Green Engineering Co., Com'l Nat. Bk. Bldg., Chicago.  
 Lorain Steel Co., Johnstown, Pa.  
 National Brake & Electric Co., Milwaukee.  
 Washburn Steel Castings & Coupler Co., Minneapolis.
- Catchers—(See Trolley Retrievers and Catchers).**
- Cattle Guards.**  
 Fairbanks, Morse & Co., Chgo.
- Circuit-Breakers.**  
 Electric Service Supplies Co., 200 Plymouth Bldg., Chicago.  
 General Electric Co., Schenectady, N. Y.  
 Western Electric Co., Chicago.
- Coal Handling Machinery—(See Conveyors).**
- Coils—(See Armatures and Coils).**
- Commutators and Parts.**  
 Cleveland Armature Works, Cleveland.  
 Electric Service Supplies Co., 1929-34 Filbert St., Philadelphia.  
 General Electric Co., Schenectady, N. Y.  
 Marshall, R. W. & Co., 95 Liberty St., New York.  
 Ohio Brass Co., Mansfield, O.  
 Stuart-Howland Co., Boston.
- Compressors, Air.**  
 Fairbanks, Morse & Co., Chgo.  
 General Electric Co., Schenectady, N. Y.  
 National Brake & Electric Co., Milwaukee.  
 Westinghouse Traction Brake Co., Pittsburg.
- Concrete Mixers.**  
 Contractors' Supply & Equip. Co., Chicago.
- Condensers.**  
 Wheeler Condenser & Engineering Co., Carteret, N. J.
- Conduits.**  
 Electric Service Supplies Co., 200 Plymouth Bldg., Chicago.  
 Western Electric Co., Chicago.
- Connectors, Solderless.**  
 Dossert & Co., 242 W. Forty-first St., New York.
- Contractors.**  
 Arnold Company, 181 La Salle St., Chicago.  
 Bylesby, H. M., Co., Am. Trust Bldg., Chicago.  
 Columbia Construction Co., Milwaukee, Wis.  
 Creaghead Engineering Co., Cincinnati, O.
- Contractors—Continued.**  
 Green Engineering Co., Com'l Nat. Bk. Bldg., Chicago.  
 Register, A. L. & Co., 112 N. Broad St., Philadelphia.  
 Sanderson & Porter, 52 William St., New York.  
 Saxton, E., 841 Bladensburg R., Washington, D. C.  
 Sheaf & Jaastad, 83 Broad St., Boston.  
 Stone & Webster Engineering Corp., Boston.  
 Wharton, Wm., Jr. & Co., Philadelphia.  
 White J. G. & Co., 49 Exchange Pl., New York.
- Controllers and Attachments.**  
 Electric Service Supplies Co., 200 Plymouth Bldg., Chicago.  
 General Electric Co., Schenectady, N. Y.  
 Johns-Manville, H. W., Co., New York.  
 Marshall, R. W. & Co., 95 Liberty St., New York.  
 Western Electric Co., Chicago.  
 Westinghouse Electric & Mfg. Co., Pittsburg.
- Conveyors and Coal Handling Machinery.**  
 Green Engineering Co., Com'l Nat. Bk. Bldg., Chicago.  
 Northern Engineering Works, Detroit, Mich.
- Cord, Bell and Trolley.**  
 American Car Co., St. Louis.  
 Brill, The J. G., Co., Philadelphia.  
 Electric Service Supplies Co., 1929-34 Filbert St., Philadelphia.  
 Kuhlman, The G. C., Car Co., Cleveland.  
 St. Louis Car Co., St. Louis, Mo.  
 Stephenson, John, Co., Elizabeth, N. J.  
 Stuart-Howland Co., Boston.  
 Wason Mfg. Co., Springfield, Mass.
- Couplers, Car.**  
 American Car Co., St. Louis.  
 Brill, The J. G., Co., Philadelphia.  
 Kuhlman, The G. C., Car Co., Cleveland.  
 McGuire-Cummings Mfg. Co., Chicago.  
 Ohio Brass Co., Mansfield, O.  
 St. Louis Car Co., St. Louis, Mo.  
 Stephenson, John, Co., Elizabeth, N. J.  
 Van Dorn, W. T., Co., Paulina St., Chicago.  
 Washburn Steel Castings & Coupler Co., Minneapolis.  
 Wason Mfg. Co., Springfield, Mass.
- Coverings, Pipe and Boiler.**  
 Johns-Manville, H. W., Co., New York.
- Cranes, Hoists and Lifts.**  
 American Car Co., St. Louis.  
 Brill, The J. G., Co., Philadelphia.  
 Brown Hoisting Machinery Co., Cleveland, O.  
 Kuhlman, The G. C., Car Co., Cleveland.  
 Northern Engineering Works, Detroit, Mich.  
 Railway Specialty & Supply Co., Chicago.  
 Stephenson, John, Co., Elizabeth, N. J.  
 Van Dorn, W. T. & Dutton Co., Cleveland, O.  
 Wason Mfg. Co., Springfield, Mass.
- Cross Arms—(See Brackets and Cross Arms).**
- Crossing Gates—(See Gates and Guards).**
- Crossings, Track—(See Switches).**
- Curtains, Fixtures and Materials.**  
 American Car Co., St. Louis.  
 Brill, The J. G., Co., Philadelphia.  
 Curtin Supply Co., 93 Ohio St., Chicago.  
 Electric Service Supplies Co., 200 Plymouth Bldg., Chicago.  
 Hartsorn, Stewart, Co., East Newark, N. J.  
 Kuhlman, The G. C., Car Co., Cleveland.  
 Marshall, R. W. & Co., 95 Liberty St., New York.  
 National Lock Washer Co., Newark, N. J.
- Curtains, Fixtures and Materials—Continued.**  
 Pantofote Co., 11 Broadway, New York.  
 St. Louis Car Co., St. Louis, Mo.  
 Stephenson, John, Co., Elizabeth, N. J.  
 Wason Mfg. Co., Springfield, Mass.
- Cylinder Oil.**  
 Power Specialty Co., 111 Broadway, N. Y.
- Derailing Devices.**  
 American Flyer & Switch Co., Hamilton, O.  
 Cleveland Frog & Crossing Co., Cleveland, O.
- Detective Agency.**  
 Drummond Detective Agency, New York.
- Doors and Fixtures.**  
 American Car Co., St. Louis.  
 Brill, The J. G., Co., Philadelphia.  
 Kuhlman, The G. C., Car Co., Cleveland.  
 St. Louis Car Co., St. Louis, Mo.  
 Stephenson, John, Co., Elizabeth, N. J.  
 Wason Mfg. Co., Springfield, Mass.
- Doors, Steel Rolling.**  
 Kinnear Manufacturing Co., Columbus, O.  
 Wilson, J. G., Mfg. Co., New York.
- Draft, Mechanical—(See Mechanical Draft).**
- Draft Rigging.**  
 Van Dorn, W. T., Co., Chgo.  
 Washburn Steel Castings & Coupler Co., Minneapolis.
- Drills, Track.**  
 Brown, H. P., 120 Liberty St., New York.  
 Electric Service Supplies Co., 200 Plymouth Bldg., Chicago.  
 Fairbanks, Morse & Co., Chgo.  
 Kalamazoo Railway Supply Co., Kalamazoo, Mich.  
 Marshall, R. W. & Co., 95 Liberty St., New York.  
 Ridon, Frank, Co., 200 Summer St., Boston.
- Drying Appliances.**  
 Green Fuel Economizer Co., Matteawan, N. Y.
- Dynamos and Generators.**  
 Cleveland Armature Works, Cleveland, O.  
 Fairbanks, Morse & Co., Chgo.  
 General Electric Co., Schenectady, N. Y.  
 National Brake & Electric Co., Milwaukee, Wis.  
 Western Electric Co., Chicago.  
 Westinghouse Electric & Mfg. Co., Pittsburg, Pa.
- Economizers, Fuel.**  
 Green Fuel Economizer Co., Matteawan, N. Y.
- Electrical Instruments.**  
 Electric Service Supplies Co., 200 Plymouth Bldg., Chicago.  
 General Electric Co., Schenectady, N. Y.  
 Johns-Manville, H. W., Co., New York.  
 Queen & Co., Philadelphia.  
 Western Electric Co., Chicago.  
 Westinghouse Electric & Mfg. Co., Pittsburg, Pa.  
 Weston Electrical Instrument Co., Newark, N. J.
- Electric Railway Supplies, General.**  
 Cleveland Armature Works, Cleveland, O.  
 Creaghead Engineering Co., Cincinnati, O.  
 Electric Service Supplies Co., 200 Plymouth Bldg., Chicago.  
 Fairbanks, Morse & Co., Chgo.  
 General Electric Co., Schenectady, N. Y.  
 Johns-Manville, H. W., Co., New York.  
 Marshall, R. W. & Co., 95 Liberty St., New York.  
 Ohio Brass Co., Mansfield, O.  
 Stuart-Howland Co., Boston.  
 Western Electric Co., Chicago.

Have You Sent for Your Sample of

# Steel Wool Journal Packing

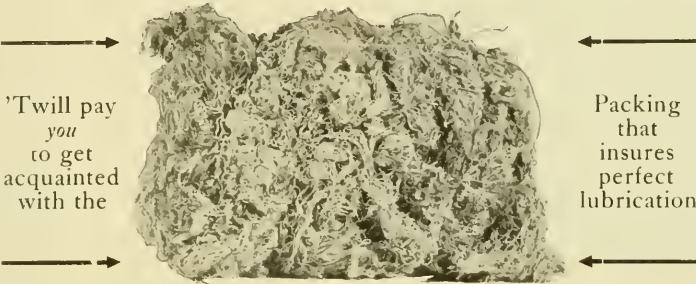

→  
 'Twill pay  
*you*  
 to get  
 acquainted  
 with the  
 ←

←  
 Packing  
 that  
 insures  
 perfect  
 lubrication  
 →

A two-cent stamp and a minute will bring enough to enable you to decide whether these claims are true

- 
- Steel Wool** → saves one-half the packing  
**Journal** → saves one-third the oil  
**Packing** → saves labor and wear  
 → prevents hot boxes **positively.**
- 

You can never know what real economy in journal packing is until you get in touch with

## William Robertson & Co.

General Office: Fifth Floor Great Northern Bldg., Chicago  
 Factory: 75 South Jefferson Street, Battle Creek, Mich.

→ *Drop us a line now--while you think of it* ←

## CLASSIFIED LIST OF ADVERTISERS—Continued.

- Enamels.**  
Acme White Lead & Color Works, Detroit, Mich.  
St. Louis Surfacor & Paint Co., St. Louis, Mo.
- Engine Apparatus.**  
Green Fuel Economizer Co., Matteawan, N. Y.
- Engineers and Contractors.**  
Arnold Company, Chicago.  
Bylesby, H. M., & Co., Chgo. Columbia Construction Co., Milwaukee, Wis.  
Ford, Bacon & Davis, New York.  
Register, A. L., & Co., Philadelphia.  
Roberts & Abbott Co., Cleveland, O.  
Sanderson & Porter, New York  
Saxton, E., Washington, D. C.  
Sheaff & Jaastad, Boston.  
Stone & Webster Eng. Corporation, Boston.  
White, J. G., & Co., New York.
- Engines, Gas and Oil.**  
Buckeye Engine Co., Salem, O.  
Fairbanks, Morse & Co., Chgo. Westinghouse Machine Co., Pittsburg.
- Engines, Hoisting.**  
Fairbanks, Morse & Co., Chgo.
- Engines, Steam.**  
Buckeye Engine Co., Salem, O.  
Westinghouse Machine Co., Pittsburg.
- Fans, Exhaust and Ventilating.**  
General Electric Co., Schenectady, N. Y.  
Green Fuel Economizer Co., Matteawan, N. Y.  
Western Electric Co., Chicago.  
Westinghouse Elec. & Mfg. Co., Pittsburg.
- Fare Boxes—(See Electric Railway Supplies).**
- Fare Registers and Register Fittings.**  
Electric Service Supplies Co., 200 Plymouth Bldg., Chicago.  
Recording Fare Register Co., New Haven, Conn.  
Rooke Automatic Register Co., Providence, R. I.
- Feedwater Apparatus.**  
Green Fuel Economizer Co., Matteawan, N. Y.  
Wheeler Condenser & Engineering Co., Carteret, N. J.
- Feed Wire—(See Wire and Cables).**
- Fenders and Guards.**  
Consolidated Car Fender Co., Providence, R. I.  
Eclipse Railway Supply Co., Cleveland, O.  
Electric Service Supplies Co., 1020-24 Filbert St., Phila.  
McGuire-Cummings Mfg. Co., Chicago.  
Marshall, R. W., & Co., 95 Liberty St., New York.
- Flangers, Snow.**  
McGuire-Cummings Mfg. Co., Chicago.  
Ohio Brass Co., Mansfield, O.  
Kalamazoo Railway Supply Co., Kalamazoo, Mich.  
Van Dorn & Dutton Co., Cleveland, O.
- Frogs—(See Switches, Frogs and Crossings).**
- Fuel Economizers—(See Economizers, Fuel).**
- Fuses and Fuse Devices.**  
Chase-Shawmut Co., Newburyport, Mass.  
Electric Service Supplies Co., 200 Plymouth Bldg., Chicago.  
General Electric Co., Schenectady, N. Y.  
Johns-Manville, H. W., Co., New York.  
Western Electric Co., Chicago.  
Westinghouse Elec. & Manufacturing Co., Pittsburg.
- Gaskets, Bronze.**  
Power Specialty Co., 111 Broadway, New York.
- Gates and Guards.**  
Ellis, R. Mfg. Co., Pawtucket, R. I.  
Kalamazoo Railway Supply Co., Kalamazoo, Mich.
- Gear Cases.**  
Electric Service Supplies Co., 200 Plymouth Bldg., Chicago.  
General Electric Co., Schenectady, N. Y.  
Marshall, R. W., & Co., 95 Liberty St., New York.
- Gears and Pinions.**  
Electric Service Supplies Co., 200 Plymouth Bldg., Chicago.  
General Electric Co., Schenectady, N. Y.  
Marshall, R. W., & Co., 95 Liberty St., New York.  
Nuttall, R. D., Co., Pittsburg.  
Van Dorn & Dutton Co., Cleveland, O.
- Generators—(See Dynamos).**
- Gongs—(See Bells and Gongs).**
- Graphite Paint—(See Paint).**
- Grates, Chain.**  
Green Engineering Co., Com'l Nat. Bk. Bldg., Chicago.
- Grease—(See Lubricants).**
- Grinders.**  
Brown, Harold P., 120 Liberty St., New York.
- Ground Connection Clamps.**  
Chase-Shawmut Co., Newburyport, Mass.
- Guy Anchors—(See Anchors).**
- Harps, Trolley—(See Trolley Poles and Fittings).**
- Headlights.**  
Electric Service Supplies Co., 200 Plymouth Bldg., Chicago.  
Fairbanks, Morse & Co., Chgo. General Electric Co., Schenectady, N. Y.  
Ridlon, Frank Co., 200 Summer St., Boston.  
St. Louis Car Co., St. Louis, Mo.  
Stuart-Howland Co., Boston.  
Trolley Supply Co., Canton, O.
- Headlights, Passenger Car.**  
Indestructible Fibre Co., 46 Broadway, New York.
- Heaters, Car, Electric.**  
Consolidated Car-Heating Co., New York.  
Johns-Manville, H. W., Co., New York.
- Heaters, Car, Hot Water, and Stoves.**  
Baker, The Wm. C., Heating & Svc. Co., New York.  
Cooper Heater Co., The, Dayton, O.  
Electric Service Supplies Co., 1020-24 Filbert St., Phila.  
McGuire-Cummings Mfg. Co., Chicago.  
Smith, Peter, Heater Co., Detroit, Mich.
- Heating and Ventilating Apparatus—(See Mech. Draft).**
- Hoists—(See Cranes, Hoists and Lifts).**
- Hose Bridges.**  
Ohio Brass Co., Mansfield, O.
- Hydraulic Machinery.**  
Watson-Stillman Co., 26 Cortlandt St., New York.
- Inspection.**  
Central Inspection Bureau.
- Inspection Cars, Gasoline.**  
Stover Motor Car Co., Freeport, Ill.
- Instruments, Measuring and Testing—(See Electrical Instruments).**
- Insulating Tapes.**  
General Electric Co., Schenectady, N. Y.  
Johns-Manville, H. W., Co., New York, N. Y.  
Okonite Co., Ltd., 253 Broadway, New York.  
Western Electric Co., Chicago.
- Insulations and Insulating Material.**  
Anderson, A. & J. M., Mfg. Co., Boston.  
Creaghead Engineering Co., Cincinnati, O.  
Electric Railway Equipment Co., Cincinnati, O.  
Electric Service Supplies Co., 200 Plymouth Bldg., Chicago.  
General Electric Co., Schenectady, N. Y.  
Johns-Manville, H. W., Co., New York.  
Macallen, The, Co., Boston.  
Ohio Brass Co., Mansfield, O.  
Okonite Co., Ltd., 253 Broadway, New York.  
Ridlon, Frank, Co., 200 Summer St., Boston.  
Standard Paint Co., 100 William St., New York.  
Standard Varnish Works, New York.  
Stuart-Howland Co., Boston.  
Western Electric Co., Chicago.
- Jacks.**  
American Car Co., St. Louis.  
Brill, The J. G., Co., Philadelphia.  
Electric Service Supplies Co., 200 Plymouth Bldg., Chicago.  
Fairbanks, Morse & Co., Chgo. Kalamazoo Railway Supply Co., Kalamazoo, Mich.  
Kuhlman, The G. C., Car Co., Cleveland.  
Marshall, R. W., & Co., 95 Liberty St., New York.  
Morden Frog & Crossing Co., Chicago.  
Stephenson, John, Co., Elizabeth, N. J.  
Wason Mfg. Co., Springfield, Mass.  
Watson-Stillman Co., 26 Cortlandt St., New York.
- Joints, Expansion—(See Steam Fittings).**
- Joints, Rail.**  
Rail Joint Co., 29 W. 34th St., New York.
- Joints, Welded—(See Rail Joints, Welded).**
- Journal Boxes.**  
American Car Co., St. Louis.  
Brill, The J. G., Co., Philadelphia.  
Kuhlman, The G. C., Car Co., Cleveland.  
McGuire-Cummings Mfg. Co., Chicago.  
St. Louis Car Co., St. Louis, Mo.  
Stephenson, John, Co., Elizabeth, N. J.  
Syrington T. H., Co., Baltimore, Md.  
Wason Mfg. Co., Springfield, Mass.
- Journal Lubricants—(See Lubricants).**
- Journal Packing, Steel Wool.**  
Robertson, Wm., & Co., Fifth Floor Great Northern Bldg., Chicago.
- Lamps, Arc and Incandescent.**  
Anderson, A. & J. M., Mfg. Co., Boston.  
Electric Service Supplies Co., 200 Plymouth Bldg., Chicago.  
General Electric Co., Schenectady, N. Y.  
Ridlon, Frank, Co., 200 Summer St., Boston.  
Stuart-Howland Co., Boston.  
Western Electric Co., Chicago.  
Westinghouse Electric & Mfg. Co., Pittsburg, Pa.
- Lamp Sockets.**  
Electric Service Supplies Co., 200 Plymouth Bldg., Chicago.  
General Electric Co., Schenectady, N. Y.  
Johns-Manville, H. W., Co., New York, N. Y.
- Lantern Globes.**  
Railway Specialty & Supply Co., Chicago.
- Lifting Magnets.**  
Porter Mfg. Co., 29 Griswold St., Detroit, Mich.
- Lifts—(See Cranes, Hoist and Lift).**
- Lightning Arresters.**  
Electric Service Supplies Co., 200 Plymouth Bldg., Chicago.  
General Electric Co., Schenectady, N. Y.  
Stuar-Howland Co., Boston.  
Western Electric Co., Chicago.  
Westinghouse Elec. & Manufacturing Co., Pittsburg.
- Line Material.**  
Anderson, A. & J. M., Mfg. Co., Boston.  
Creaghead Engineering Co., Cincinnati, O.  
Johns-Manville, H. W., Co., New York.  
Electric Ry. Equipment Co., Cincinnati, O.  
Electric Service Supplies Co., 200 Plymouth Bldg., Chicago.  
General Electric Co., Schenectady, N. Y.  
Macallen, The, Co., Boston.  
Marshall, R. W., & Co., 95 Liberty St., New York.  
Recording Fare Register Co., New Haven, Conn.  
Stuart-Howland Co., Boston.  
Western Electric Co., Chicago.
- Lock and Nut Washers.**  
National Lock Washer Co., Newark, N. J.
- Lockers, Metal.**  
Electric Service Supplies Co., 200 Plymouth Bldg., Chicago.
- Locomotives.**  
Baldwin Locomotive Works, Philadelphia.  
Johann, F. A., 1624 Pierce Bldg., St. Louis.
- Locomotives, Electric.**  
American Car Co., St. Louis.  
Baldwin Locomotive Works, Philadelphia.  
Brill, The J. G., Co., Philadelphia.  
General Electric Co., Schenectady, N. Y.  
Kuhlman, The G. C., Car Co., Cleveland.  
McGuire-Cummings Mfg. Co., Chicago.  
Stephenson, John, Co., Elizabeth, N. J.  
Wason Mfg. Co., Springfield, Mass.  
Westinghouse Elec. & Manufacturing Co., Pittsburg.
- Locomotives, Gasoline.**  
Fairbanks, Morse & Co., Chgo. Stover Motor Car Co., Freeport, Ill.
- Lubricants.**  
Dearborn Drug & Chemical Works, Chicago.  
Galena-Signal Oil Co., Franklin, Pa.  
Whitmore Mfg. Co., Cleveland, O.
- Lumber.**  
Barnes, G. H., Hardwood Lumber Co., St. Louis, Mo.  
Beidler, Francis, & Co., Chgo. Berthold & Jennings, St. Louis.  
Lindsay Bros. Co., Spokane, Wash.  
S-E. Missouri Cypress Co., Campbell, Mo.
- Magnets and Solenoids.**  
Porter Mfg. Co., 29 Griswold St., Detroit, Mich.
- Malleable Iron.**  
St. Louis Car Co., St. Louis, Mo.
- Measuring Tapes.**  
Lufkin Rule Co., Saginaw, Mich.
- Mechanical Draft.**  
Green Fuel Economizer Co., Matteawan, N. Y.
- Meters.**  
Johns-Manville, H. W., Co., New York.  
Queen & Co., Philadelphia.  
Weston Electrical Instrument Co., Newark, N. J.
- Motor Cars, Gasoline.**  
Stover Motor Car Co., Freeport, Ill.

# Pay-As-You-Enter Cars

*are simple  
in plan and  
operation:*

Passengers enter by way of the rear platform **only**, and directly under the eye of the conductor — no chance for accidents here through starting while passengers are in the act of boarding. And the company gets all the nickels, too.

Passengers leave by way of the front platform, and directly under the eye of the motorman, who has sole control of the exit door. And that means no accidents at the front end.

Pay-As-You-Enter Car operation means more nickels, fewer accidents, closer adherence to schedules.



We license manufacturers and railways to build and use the Pay-As-You-Enter Car, the patents on which are owned by

## The Pay-As-You-Enter Car Company

DUNCAN McDONALD  
President

26 Cortlandt Street, New York

THOS. W. CASEY  
Manager

## CLASSIFIED LIST OF ADVERTISERS—Continued.

- Motors, Electric.**  
Cleveland Armature Works, Cleveland, O.  
Fairbanks, Morse & Co., Chgo. General Electric Co., Schenectady, N. Y.  
National Brake & Electric Co., Milwaukee.  
Western Electric Co., Chicago. Westinghouse Elec. & Manufacturing Co., Pittsburg.
- Nut Locks.**  
Chase-Shawmut Co., Newburyport, Mass.  
National Lock Washer Co., Newark, N. J.  
Railway Specialty & Supply Co., Chicago.  
St. Louis Car Co., St. Louis, Mo.  
U. S. Metal & Mfg. Co., 25 Broad St., New York.
- Nuts and Bolts.**  
Lorain Steel Co., Philadelphia. National Lock Washer Co., Newark, N. J.  
Railway Specialty & Supply Co., Chicago.
- Oilers.**  
Armstrong Oiler Co., 31st and Chestnut St., Philadelphia.
- Oils—(See Lubricants).**
- Overhead Equipment—(See Electric Railway Supplies).**
- Packings.**  
Electric Service Supplies Co., 200 Plymouth Bldg., Chicago.  
Johns-Manville, H. W., Co., New York.  
Power Specialty Co., 111 Broadway, New York.
- Packing, Steel Wool Journal.**  
Robertson, Wm., & Co., Fifth Floor Great Northern Bldg., Chicago.
- Paints.**  
Standard Paint Co., 100 William St., New York.  
St. Louis Surface & Paint Co., St. Louis, Mo.
- Pay-As-You-Enter Cars.**  
Pay-As-You-Enter Car Co., 26 Cortland St., New York.
- Pipe Bends and Fittings—(See Steam Fittings).**
- Poles, Metal.**  
Creshead Engineering Co., Cincinnati, O.  
Electric Railway Equipment Co., Cincinnati, O.  
Electric Service Supplies Co., 200 Plymouth Bldg., Chicago.
- Poles and Ties, Wood.**  
Advance Lumber Co., Cleveland, O.  
Barnes, G. H., Hardwood Lumber Co., St. Louis, Mo.  
Beider, Francis, & Co., Chgo. Berthold & Jennings, St. Louis.  
Churchill Cedar Co., Spokane, Wash.  
Humbird Lumber Co., Sand Point, Idaho.  
Lindsay Bros. Co., Spokane, Wash.  
National Pole Co., Escanaba, Mich.  
Naugle Pole & Tie Co., 226 La Salle St., Chicago.  
Pacific Coast Pole Co., Spokane, Wash.  
S-E. Missouri Cypress Co., Campbell, Mo.  
Worcester, C. H., Co., Tribune Bldg., Chicago.
- Promoters of Railway Projects.**  
Shlmer & Chase Co., Omaha, Neb.
- Punches—(See Ticket Punches).**
- Rail Benders.**  
Electric Service Supplies Co., 200 Plymouth Bldg., Chicago.  
Fairbanks, Morse & Co., Chgo.
- Rail Bonds—(See Bonds, Rail).**
- Rail Bonds, Flexible.**  
Chase-Shawmut Co., Newburyport, Mass.
- Rail Drills—(See Drills, Track).**
- Rail Feed Wire—(See Wire and Cables).**
- Rail Joints and Chairs—(See Joints, Rail).**
- Rail Joints, Welded.**  
Lorain Steel Co., Philadelphia.
- Rails, New.**  
Lorain Steel Co., Philadelphia. New York Switch & Crossing Co., Hoboken, N. J.  
Wharton, Wm., Jr., & Co., Philadelphia.
- Rails, Relaying.**  
Zelnicke, Walter A., Supply Co., St. Louis.
- Railway Equipment.**  
Johann, F. A., 1624 Pierce Bldg., St. Louis.
- Railway Velocipades.**  
Fairbanks, Morse & Co., Chgo. Kalamazoo Railway Supply Co., Kalamazoo, Mich.
- Registers and Fittings—(See Fare Registers).**
- Relays.**  
Weston Electrical Instrument Co., Newark, N. J.
- Roofing.**  
Johns-Manville, H. W., Co., New York.
- Sand Apparatus.**  
American Car Co., St. Louis. Brill, The J. G., Co., Philadelphia.  
Electric Service Supplies Co., 200 Plymouth Bldg., Chicago.  
Kuhlman, The G. C., Car Co., Cleveland.  
Marshall, R. W., & Co., 95 Liberty St., New York.  
Ohio Brass Co., Mansfield, O.  
Ridlon, Frank, Co., 200 Summer St., Boston.  
St. Louis Car Co., St. Louis, Mo.  
Stephenson, John, Co., Elizabeth, N. J.  
Wason Mfg. Co., Springfield, Mass.
- Sash Balances and Fixtures.**  
National Lock Washer Co., Newark, N. J.
- Sash Operating Devices.**  
Drouvé, The G., Co., Bridgeport, Conn.  
Lord & Burnham, Irvington-on-Hudson, New York.
- Seats, Car—(See Car Seats).**
- Shade Rollers—(See Curtains, Fixtures and Materials).**
- Shutters, Steel Rolling.**  
Kinnear Manufacturing Co., Columbus, O.
- Signals.**  
Blake Signal & Manufacturing Co., Boston.  
Telephone Signal Co., Rochester, N. Y.
- Signal Supplies.**  
Railway Specialty & Supply Co., Chicago.
- Skylights.**  
Drouvé, The G., Co., Bridgeport, Conn.  
Lord & Burnham, Irvington-on-Hudson, New York.
- Snow Plows, Sweepers and Scrapers.**  
American Car Co., St. Louis. Brill, The J. G., Co., Philadelphia.  
Kalamazoo Railway Supply Co., Kalamazoo, Mich.  
Kuhlman, The G. C., Car Co., Cleveland.  
McGuire-Cummings Mfg. Co., Chicago.  
Reisler Car & Snow-Plow Co., Ridgway, Pa.  
Stephenson, John, Co., Elizabeth, N. J.
- Snow Plows, Sweepers and Scrapers—Continued.**  
Wason Mfg. Co., Springfield, Mass.
- Sockets, Waterproof.**  
Johns-Manville, H. W., Co., New York.
- Solder Paste.**  
Chase-Shawmut Co., Newburyport, Mass.
- Springs.**  
American Car Co., St. Louis. Brill, The J. G., Co., Philadelphia.  
Davis, The John, Co., Chgo.  
Kuhlman, The G. C., Car Co., Cleveland.  
McGuire-Cummings Mfg. Co., Chicago.  
Marshall, R. W., & Co., 95 Liberty St., New York.  
Railway Steel Spring Co., 71 Broadway, New York.  
St. Louis Car Co., St. Louis, Mo.  
Stephenson, John, Co., Elizabeth, N. J.  
Wason Mfg. Co., Springfield, Mass.
- Sprinkling Cars.**  
American Car Co., St. Louis. Brill, The J. G., Co., Philadelphia.  
Kuhlman, The G. C., Car Co., Cleveland.  
McGuire-Cummings Mfg. Co., Chicago.  
Stephenson, John, Co., Elizabeth, N. J.  
Wason Mfg. Co., Springfield, Mass.
- Stage Pockets and Plugs.**  
Chase-Shawmut Co., Newburyport, Mass.
- Steam Apparatus.**  
Green Fuel Economizer Co., Matteawan, N. Y.
- Steam Fittings, Etc.**  
Crane Co., Chicago.  
Davis, The John, Co., Chgo.  
Simmons, John, Co., 110 Centre St., New York.  
Power Specialty Co., 111 Broadway, New York.
- Steel Cars.**  
American Car Co., St. Louis. Brill, The J. G., Co., Philadelphia.  
Kuhlman, The G. C., Car Co., Cleveland.  
St. Louis Car Co., St. Louis, Mo.  
Stephenson, John, Co., Elizabeth, N. J.  
Wason Mfg. Co., Springfield, Mass.
- Steel Tapes.**  
Luffkin Rule Co., Saginaw, Mich.
- Stokers.**  
Babcock & Wilcox Co., 85 Liberty St., New York.  
Green Engineering Co., Com'l Nat. Bk. Bldg., Chicago.  
Model Stoker Co., Dayton, O.  
Under-Psed Stoker Co. of Am., Chicago.  
Westinghouse Machine Co., Pittsburg.
- Storage Batteries—(See Batteries).**
- "Strike-Breakers."**  
Drummond Detective Agency, 3 Ann St., New York.
- Superheaters.**  
Power Specialty Co., 111 Broadway, New York.
- Switches, Frogs and Crossings.**  
American Frog & Switch Co., Hamilton, O.  
Barbour-Stockwell Co., Cambridgeport, Mass.  
Cleveland Frog & Crossing Co., Cleveland, O.  
Fairbanks, Morse & Co., Chgo. Lorain Steel Co., Philadelphia.  
Morden Frog & Crossing Co., Rookery, Chicago.  
New York Switch & Crossing Co., Hoboken, N. J.  
Railway Specialty & Supply Co., Chicago.  
Wharton, Wm., Jr., & Co., Philadelphia.
- Switchboards and Switchboard Instruments.**  
Anderson, A. & J. M., Mfg. Co., Boston.  
Chase-Shawmut Co., Newburyport, Mass.  
General Electric Co., Schenectady, N. Y.  
Western Electric Co., Chicago. Westinghouse Electric & Mfg. Co., Pittsburg.  
Weston Electrical Instrument Co., Newark, N. J.
- Tapes and Webbing.**  
Hope Webbing Co., Providence, R. I.  
Johns-Manville, H. W., Co., New York.  
Okonite Co., Ltd., 253 Broadway, New York.
- Testing Instruments.**  
Queen & Co., Philadelphia.  
Weston Electrical Instrument Co., Newark, N. J.
- Test Lamps, Pocket.**  
Chase-Shawmut Co., Newburyport, Mass.
- Ticket Choppers and Destroyers.**  
Patten, Paul B., Salem, Mass.
- Ticket Punches.**  
Meyers, Fred J., Mfg. Co., Hartford, O.  
Woodman Mfg. & Sup. Co., Boston.
- Ties and Poles, Wood—(See Poles and Ties).**
- Timber.**  
Beider, Francis, & Co., Chgo. Lindsay Bros. Co., Spokane, Wash.  
S-E. Missouri Cypress Co., Campbell, Mo.
- Tools, Pneumatic—(See Pneumatic Tools).**
- Track Cleaners and Scrapers.**  
American Car Co., St. Louis. Brill, The J. G., Co., Philadelphia.  
Kalamazoo Railway Supply Co., Kalamazoo, Mich.  
Kuhlman, The G. C., Car Co., Cleveland.  
McGuire-Cummings Mfg. Co., Chicago.  
Marshall, R. W., & Co., 95 Liberty St., New York.  
Ohio Brass Co., Mansfield, O.  
Stephenson, John, Co., Elizabeth, N. J.  
Van Dorn & Dutton Co., Cleveland, O.  
Wason Mfg. Co., Springfield, Mass.
- Track Drills—(See Drills, Track).**
- Tracklaying Machinery.**  
Holman, D. F., Ry. Tracklayer Co., 1102 Ellsworth Bldg., Chicago.
- Track Tools.**  
Electric Service Supplies Co., 200 Plymouth Bldg., Chicago.  
Kalamazoo Railway Supply Co., Kalamazoo, Mich.
- Trimmings, Car.**  
American Car Co., St. Louis. Brill, The J. G., Co., Philadelphia.  
Curtain Supply Co., Park Row Bldg., New York.  
Kuhlman, The G. C., Car Co., Cleveland.  
National Lock Washer Co., Newark, N. J.  
St. Louis Car Co., St. Louis, Mo.  
Stephenson, John, Co., Elizabeth, N. J.  
Wason Mfg. Co., Springfield, Mass.
- Trolley Guards.**  
Automatic Trolley Guard Co., 391 Elliott St., Buffalo, N. Y.  
Electric Service Supplies Co., 200 Plymouth Bldg., Chicago.
- Trolley Poles and Fittings.**  
General Electric Co., Schenectady, N. Y.  
Johns-Manville, H. W., Co., New York.  
Marshall, R. W., & Co., 95 Liberty St., New York.  
Star Brass Works, Kalamazoo, Mich.

# ST. LOUIS CAR CO. ST. LOUIS-MO.



## St. Louis Car Company's Semi-Convertible Type

The illustration represents one of the cars recently shipped by us to the Houston Electric Company, Houston, Texas.

These cars are of our own design—a practically perfect Semi-Convertible type. Both lower and upper sashes raise into the roof. They move easily and when in the roof pockets are securely fastened, with no possible danger of falling and injuring passengers.

### Our construction of the Semi-Convertible Car is the very best that has yet been devised

These Houston cars are 28' over corner posts and 31' 6" over all. Width over arm rail, 8' 6". They are finished with very handsomely figured mahogany, provided with curtains at each window and each door opening and have the St. Louis Car Company's latest improved "Walkover" seat.

The cars are mounted on St. Louis Car Company's No. 47 Short Wheel Base Truck, which has been adopted as standard in a great many of the larger cities. The channel-iron and steel construction of the "Robertson type" permits the arm rail of the car to be placed very low and adds much to the appearance.

*Photographs, Blue Prints and Specifications will be mailed upon request.*

## CLASSIFIED LIST OF ADVERTISERS—Continued.

- Trolley Retrievers and Catchers. Electric Service Supplies Co., 1020-24 Filbert St., Phila.  
Milloy Electric Co., Bucyrus, O.  
Ridlon, Frank, Co., 200 Summer St., Boston.  
Trolley Supply Co., Canton, O.
- Trolley Wagons. Kalamazoo Railway Supply Co., Kalamazoo, Mich.
- Trolley Wheels—(See Trolley Poles and Fittings).
- Trolley Wire—(See Wire and Cable).
- Trolleys, Track. Cleveland Armature Works, Cleveland, O.
- Trucks, Car. American Car Co., St. Louis.  
Baldwin Locomotive Works, Philadelphia.  
Brill, The J. G., Co., Philadelphia.  
Kuhlman, The G. C., Car Co., Cleveland.  
McGuire-Cummings Mfg. Co., Chicago.  
St. Louis Car Co., St. Louis, Mo.  
Standard Motor Truck Co., Pittsburg, Pa.  
Standard Varnish Works, New York City.  
Stephenson, John, Co., Elizabeth, N. J.
- Trucks, Car—Continued. Van Dorn & Dutton Co., Cleveland, O.  
Wason Mfg. Co., Springfield, Mass.
- Turbines. General Electric Co., Schenectady, N. Y.  
Westinghouse Machine Co., Pittsburg, Pa.
- Valves—(See Steam Fittings).
- Varnish. Electric Service Supplies Co., 200 Plymouth Bldg., Chicago.  
Harrison Elec. & Mfg. Co., 163 South St., New York.  
Marshall, R. W., & Co., 95 Liberty St., New York.  
Milloy Electric Co., Bucyrus, O.  
Nuttall, R. D., Co., Pittsburg, Ridlon, Frank, Co., 200 Summer St., Boston.  
Standard Paint Co., 100 William St., New York.  
Star Brass Works, Kalamazoo, Mich.  
Trolley Supply Co., Canton, O.  
Wallace Supply Co., Chicago.  
Westinghouse Electric & Mfg. Co., Pittsburg, Pa.
- Ventilators. Drouvé, The G., Co., Bridgeport, Conn.  
Lord & Burnham, Irvington-Hudson, New York.
- Vestlettes. Bellamy Vestlette Mfg. Co., Cleveland, O.
- Waste, Cotton and Wool. Hagy, J. Milton, Waste Wks., Philadelphia, Pa.  
Railway Specialty & Supply Co., Chicago.
- Water Softening Apparatus. Dearborn Drug & Chemical Works, Chicago.
- Wheels and Axles. American Car Co., St. Louis.  
Brill, The J. G., Co., Philadelphia.  
Griffin Wheel Co., Chicago.  
Kuhlman, The G. C., Car Co., Cleveland.  
Lorain Steel Co., Philadelphia.  
McGuire-Cummings Mfg. Co., Chicago.  
Marshall, R. W., & Co., 95 Liberty St., New York.  
Railway Steel-Spring Co., New York.  
St. Louis Car Co., St. Louis, Mo.  
St. Louis Car Wheel Co., St. Louis.  
Lorain Steel Works, Philadelphia.  
Stephenson, John, Co., Elizabeth, N. J.  
Wason Mfg. Co., Springfield, Mass.
- Wheel Grinders. Wheel Truing Brake Shoe Co., Detroit, Mich.
- Window Fixtures. Drouvé, The G., Co., Bridgeport, Conn.
- Wiping Rags. Hagy, J. Milton, Waste Wks., Philadelphia, Pa.
- Wire, Aluminum. Aluminum Co. of America, Pittsburg, Pa.
- Wire, Insulated. Aluminum Co. of America, Pittsburg, Pa.  
American Electrical Works, Providence, R. I.  
General Electric Co., Schenectady, N. Y.  
Okonite Co., Ltd., 253 Broadway, New York.  
Standard Underground Cable Co., Pittsburg, Pa.  
Stuart-Hiowand Co., Boston.
- Wire and Cables. Aluminum Co. of America, Pittsburg, Pa.  
American Electrical Works, Providence, R. I.  
Bridgeport Brass Co., Bridgeport, Conn.  
General Electric Co., Schenectady, N. Y.  
Okonite Co., Ltd., 253 Broadway, New York.  
Standard Underground Cable Co., Pittsburg, Pa.

**Coach and Car Roof Paint**

"Metal" Canvas Preserver—*Priming Coat*  
"Metal" Canvas Roof Paint—*Other Coats*



**ST. LOUIS SURFACER  
& PAINT COMPANY**  
St. Louis, U. S. A.

**ALUMINUM****Railway Feeders**

And all kinds of **Electrical Conductors**

Aluminum Feeders are less than one-half the weight of copper feeders and are of equal conductivity and strength. If insulated wire or cable is required, high grade insulation is guaranteed.

Write for prices and full information.

**Aluminum Company of America**

PITTSBURGH, PA.

Formerly The Pittsburgh Reduction Company

Of the strongest and lightest construction—that's the

**Ideal Trolley Wheel**

Very different from the cast wheels you have used.

May we tell you all about the *Ideal*?

Buffalo **LUMEN BEARING CO.** Toronto

Waste for Electric Railway Service

**Motor Packing Waste**

Free from dirt and grit. Easy to pack. All long strands. Good absorber. One packing of the journal box will last longer than with the ordinary waste.

**WIPING WASTE**

White and colored sanitary cleaned wiping rags.

Samples submitted.

**The J. Milton Hagy Waste Works**

433 Spruce St.

INCORPORATED

Philadelphia

**THE BABCOCK & WILCOX COMPANY**

85 Liberty Street, New York

Babcock & Wilcox ——— Stirling ——— A & T Horizontal ——— Cahall Vertical

**WATER TUBE STEAM BOILERS**

STEAM SUPERHEATERS

Works: Bayonne, N. J. Barberton, Ohio.

MECHANICAL STOKERS

BRANCH OFFICES:

BOSTON, Delta Bldg.  
PHILADELPHIA, 110-112 North American Bldg.  
SAN FRANCISCO, 83 First Street  
PITTSBURGH, Farmers Deposit Nat. Bank Bldg.  
NEW ORLEANS, 343 Baronne St.

DENVER, 410 Seventeenth St.  
SALT LAKE CITY, 315 Atlas Block  
WASHINGTON, Colorado Building  
CHICAGO, Marquette Bldg.  
ATLANTA, GA., 1132 Candler Bldg.

CLEVELAND, 706 New England Bldg.  
MEXICO CITY, 7 Avenida, Jorobez  
HAVANA, CUBA, 116½ Calle de la Habana  
LOS ANGELES, 321 Trust Bldg.  
CINCINNATI, O., Traction Bldg.



**OKONITE** FEEDER WIRES FOR POWER TRANSMISSION.

Whether overhead, underground or submarine, successfully meet the most exacting conditions of modern traction systems. Used by the most prominent Street Railways in the country.

**The Standard for Rubber Insulation**  
Samples and Estimates on application

**THE OKONITE CO. Ltd.,** 253 Broadway, NEW YORK

WILLARD L. CANDEE, H. DURANT CHEEVER, Managers. GEORGE T. MANSO N, Gen'l Supt.; W. H. HODGINS, Secretary.

**Cranes for your Power Plant, Coal Storage, etc.**



**Cranes for your Car Shops, Car Barns, etc. Electric and Air Hoists.**

ELECTRIC AND HAND POWER TRAVELING CRANES

**NORTHERN ENGINEERING WORKS, DETROIT, MICH.**

**WHARTON SPECIAL TRACK WORK**

OF EVERY DESCRIPTION

FOR ALL CLASSES OF SERVICE

**WM. WHARTON JR. & CO.**  
INCORPORATED.

PHILADELPHIA, PA. JENKINTOWN, PA.

**MANGANESE STEEL TRACK WORK IS OUR SPECIALTY**

**RE-ENFORCED SPOKE WHEELS**

For City and Suburban Cars



This wheel is being substituted in place of the Old Style Plate Wheel because it does not rumble and roar when on paved city streets.

The only spoke wheel for Heavy High Speed Service.

Stronger Spokes  
Stronger Flange  
Deep, Even Chill  
Greater Mileage  
Absolute Safety

A Sample Order Will Prove Its Superiority Over the Old Style Spoke Wheel

WRITE FOR BOOKLET ON WHEELS

**ST. LOUIS CAR WHEEL CO.**  
ST. LOUIS, MO.

THE **Van Dorn & Dutton Co.**

CLEVELAND, OHIO

MANUFACTURERS OF

**GEARS AND PINIONS**

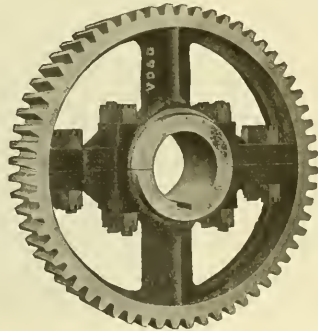

For All Types of Motors

HIGHEST QUALITY

# Dearborn Water Purifying Reagents

Increase the efficiency and the years of service of steam boilers by keeping them in good condition internally. Gallon sample of the water required for analysis before preparing treatment.

## Dearborn Drug & Chemical Works

ROBT. F. CARR, PRESIDENT

299 BROADWAY, NEW YORK POSTAL TELEGRAPH BLDG., CHICAGO

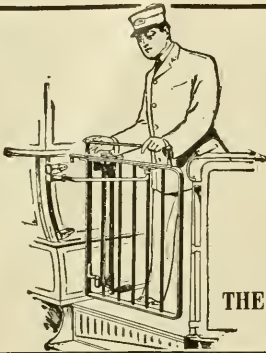

## Over 46,500 of Wood's Car Gate

Patented U. S. and Canada

### Equipments Now in Use

Do not bother passengers. Easy to operate. Light, strong, serviceable. Simple to apply on all styles of cars.

Ask for Prices

THE R. BLISS MFG. CO., Pawtucket, R.I., U.S.A.

New York Office, National Novelty Corporation, 826 Broadway

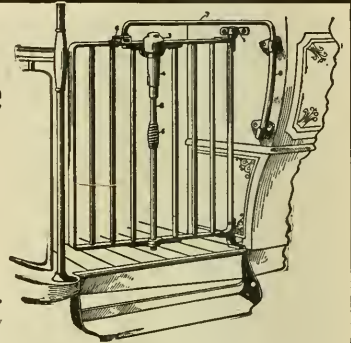

# Brown Hoist Electric Locomotive

**CRANES** DO VALUABLE SERVICE IN LIFTING AROUND  
POWER STATIONS AND CAR HOUSES



EVERY SORT OF HOISTING APPARATUS IS SHOWN IN OUR CATALOGUE

## THE BROWN HOISTING MACHINERY CO.

HAVEMEYER BLDG., NEW YORK

CLEVELAND, OHIO

FRICK BLDG., PITTSBURG, PA.

## Railway Work



Paris Line of the Terre Haute, Indianapolis and Eastern Traction Co.

THE Paris Line of the Terre Haute, Indianapolis and Eastern Traction Company is a specimen of railroad work which was laid out and constructed entirely by us.

This road is a high-speed electric interurban, sixteen miles in length. Its construction included 15 concrete bridges and culverts, and one 112-ft. truss bridge designed for 100-ton loading. 70-lb. A. S. C. E. standard rail was used throughout.

The heavy cuts and fills required the use of steam shovel, Hedgewood rapid unloader, two standard gauge steam locomotives, and twenty 30-ft. flat cars.

We design and construct both electric and steam railways, and our service includes every detail of the work—from first surveys to completing and equipping the road for operation.

Our contracts are on a basis of cost plus a fixed sum, or cost plus a percentage. We therefore act as agents for our client, keep him fully informed as to costs, progress, etc., and submit vouchers for all expenditures.

Railway construction is an important feature of our business, and to those contemplating work of this character we shall be glad to send our "Terre Haute" booklet. Write for it.

**Stone & Webster Engineering Corporation**  
**Constructing Engineers**  
 147 Milk Street :: Boston, Mass.

We are prepared to design and construct water power developments, power stations, industrial buildings, railways, electrical transmission lines and distributing systems, either new work or extensions. Correspondence invited.



CONTINUOUS JOINT

Over  
25,000  
miles  
in use



WEBER JOINT

Rolled  
from  
Best Quality  
Steel



WOLHAUPTER JOINT

Additional safety and economy in Track Maintenance has been proved by the use of Continuous, Weber and Wolhaupter base-supported rail joints—after ten (10) years' service, having a record of over 25,000 miles in use—the extent of which is evidence of their excellence.

### Catalogs at Agencies

Baltimore, Md.	Portland, Ore.
Boston, Mass.	Seattle, Wash.
Chicago, Ill.	St. Paul, Minn.
Denver, Colo.	St. Louis, Mo.
Pittsburg, Pa.	Troy, N. Y.
London, Eng.	Montreal, Can.

HIGHEST AWARDS—Paris, 1900;  
 Buffalo, 1901; St. Louis, 1904

## THE RAIL JOINT COMPANY

General Offices: 29 West 34th Street, New York City  
 Makers of Rail Joints for Standard and Special Rail Sections, also  
 Girder, Step or Compromise, and Insulating Rail Joints, protected by  
 patents in United States and Foreign Countries.

# The Right Tool

## in the Right Place

We have among our 300 types of hydraulic jacks the tool you need most. Our jacks run from two to one thousand ton capacity—every tool a perfect one and thoroughly guaranteed



Send for Jack Catalogue.

## THE WATSON-STILLMAN CO.

Main Office: 26 Cortlandt Street, New York City  
 Branch Office: 453 The Rookery, Chicago, Ill.



Factory of The Milloy Electric Company  
 Bucyrus, Ohio

## The Milloy Trolley Base

built in our new and specially equipped factory, insures a quality which will give excellent service under ordinary and extraordinary conditions.

The Milloy Base is unusually low, has even tension on high or low wire. Has no fulcrum, no friction, no oil, no center post. Always efficient. Particulars on request.

**THE MILLOY ELECTRIC COMPANY**  
 Bucyrus, Ohio

## Whitmore's Gear Protective Composition

will eliminate all of the difficulties and disagreeable features that many complain to us they experience when using other material. It does not become fluid in hot weather, and will not absorb power in cold weather. Try it and be convinced.

The Whitmore Manufacturing Company  
Cleveland, Ohio, U. S. A. 5



## Black Air-Drying Varnish

—for quick repairs to dynamos and motors, air-cooled transformer coils, magnet coils, underframe work of cars, etc. Invaluable in the shop where baking facilities are not available. It forms a tough, elastic, odorless coating, is easily applied with a brush, and withstands overheating, water, snow and sleet.

We have an interesting booklet for you.

The Standard Paint Co. 100 William Street  
Chicago St. Louis Kansas City Boston Philadelphia New Orleans

## WESTON Electrical Instrument Co.

Main Office and Works:  
WAVERLY PARK, NEWARK, N. J.



Weston Standard Illuminated  
Dial Station Voltmeter  
Model 11

### Illuminated Dial Station Instruments

SEND FOR NEW CATALOGUE

Berlin—European Weston Electrical Instrument Co., Hiltterstrasse, No. 88  
Paris, Franco—E. H. Cadot, 12 Rue St. Georges  
London—Audrey House, Ely Place, Holborn  
New York Office—74 Cortlandt St.

## Queen Testing Sets

"The Recognized  
Standard"

Voltmeters  
Ammeters  
Switchboard  
and Portable  
Alternating  
and Direct  
Current



Queen Acme Testing Set

U. S. Stand-  
ard Testing  
Sets  
Rail Bond  
Testers  
Galvanom-  
eters, etc., etc.  
Electrical  
Instruments for  
All Purposes

QUEEN & CO., Inc., Philadelphia, Pa.

# Persistent Advertisers

are the men who keep  
in sight and stay in front!

"One who watches carefully the pages of general advertising mediums is struck by two things: the persistency with which those advertisers who are recognized as successful maintain their advertising week after week, month after month, and year after year; they never seem to abate their effort; apparently the volume of their business increases steadily.

"The other thing noticeable is the large number of advertisers who thrust their announcements above the surface for a little while and then sink into oblivion. They either had not merit as a basis for their claims or they did not possess the skill to steer their enterprise successfully, or else they lacked the nerve to put forth proper effort."

—Advertising Experience.

**Moral:** The time to advertise is all the time you want to do business.

**Note:** The place to advertise to reach electric railway buyers is in the

## Electric Railway Review

Our Advertisers' Copy Service will co-operate with you to produce real advertising—the kind that helps sell goods.

# FOR SALE. FOR QUICK DELIVERY

## 6 55-ft. Passenger, Baggage and Smoking Car Bodies

Main Compartment	26' 0"
Smoking	10' 6"
Baggage	10' 0"
Seating Capacity, 54	

## 8 60-ft. Passenger, Baggage and Smoking Car Bodies

Main Compartment	28' 6"
Smoking	11' 0"
Baggage	8' 0"
Seating Capacity, 58	

## 5 52-ft. Passenger and Smoking Car Bodies — <sup>Double</sup>End

Seating Capacity, 60

## 3 52-ft. Passenger and Baggage Car Bodies — <sup>Double</sup>End

Seating Capacity, 56

## 2 50-ft. Express Car Bodies

*Write or wire us for further information.*

# The Jewett Car Co. Newark Ohio

## Hart Convertible CONSTRUCTION BALLAST and GONDOLA CAR

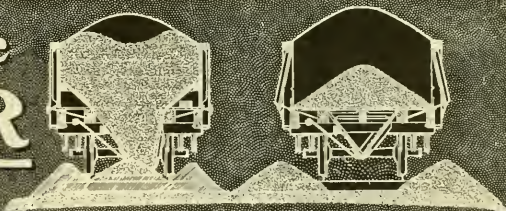

A Center-Dump, Side-Dump and Flat-Bottom Gondola—All in One

*Diagonal shading shows position of ballast after being spread by the Rodger Distributing Car which follows the hopper cars*

## Rodger Ballast Car Co. Railway Exchange. CHICAGO.

# Steel Passenger Cars and Trucks

For Steam and Electric Railways

Steel and Composite Freight Cars for all Classes of Service

# Pressed Steel Car Co.

NEW YORK, PITTSBURGH, CHICAGO, ST. LOUIS, ATLANTA, MEXICO CITY, BUENOS AIRES, SYDNEY, N. S. W.

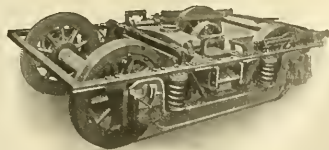

**BALDWIN LOCOMOTIVE WORKS**  
 BURNHAM, WILLIAMS & CO., PHILADELPHIA, PA., U. S. A.  
 Builders of **LOCOMOTIVES OF EVERY DESCRIPTION**  
 Including ELECTRIC LOCOMOTIVES and  
**ELECTRIC TRUCKS**

Truck built for Indianapolis, New Castle & Toledo Electric Railway Company.

**STANDARD STEEL WORKS**, HARRISON BUILDING, PHILADELPHIA, PA.

**SOLID FORGED ROLLED AND STEEL TIRED WHEELS** ELLIPTIC AND COIL SPRINGS  
 mounted on axles and fitted with Motor Gears for Electric Railway Service



**The Fred. J. Meyers Mfg. Co.** Hamilton, O.  
 Largest Manufacturers in the World of **TICKET AND CONDUCTORS' PUNCHES**  
 Send for catalog of 75 different styles of punches with 1000 different dies.  
 Write for special prices.

**TICKET PUNCHES**

Our Cast Steel Ticket Punches are the most universally used for cancelling transfer and other tickets.  
 We handle all kinds of Railway Supplies.

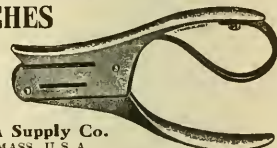

**R. Woodman Mfg. & Supply Co.**  
 63 Oliver St., BOSTON, MASS., U. S. A.

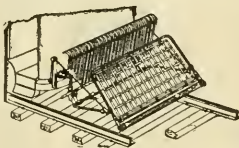

**ECLIPSE Life Guard**

Manufactured by the **ECLIPSE RAILWAY SUPPLY CO.**  
 Cleveland, Ohio



**AS IT HOLDS**

**Eventually Atlas Anchors**

**Why not now?**

**THE ATLAS ANCHOR CO.,** Cleveland, Ohio

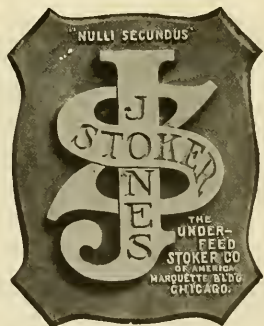

"NULLI SECUNDUS"

THE UNDER-FEED **STOKER CO.**  
 OF AMERICA  
 HARQUETTE, MINN.  
 CHICAGO.



**PIPE FITTINGS AND VALVES**

FOR THE **HEATING AND PLUMBING TRADE**

TRADE  MARK

**JOHN SIMMONS Co.**  
 104-110 Centre Street, NEW YORK

**THE LORAIN STEEL COMPANY**

**Girder Rails and High Tee Rails  
 High-Grade Special Track Work**

GENERAL OFFICES  
 THE PENNSYLVANIA BUILDING, PHILADELPHIA, PA.

# U.S. Metal & Mfg. Co.

25 Broad Street, New York

Pittsburg, 1509 Arrott Bldg. Chicago, 414 Railway Exchange

## Victor Cast Steel Car Replacer

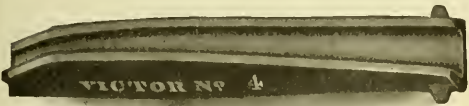
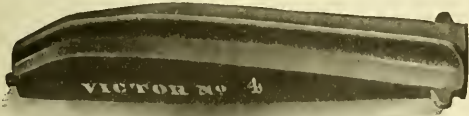

Victor No. 4

Weight, 136 pounds per set. For use on electric or standard steam roads using rails five inches high or under. Replacers are made of cast steel and annealed.

2

# Plastic Rail Bond Durability

When you see one you think of the other.

A bond that shows but 5 percent depreciation after eleven years' severe service has earned the right to be known as the

## Durable Rail Bond

The plug type can be installed without disturbing the pavement or removing the angle plate.



When Put,  
Stays Put!

This shows you how.

**HAROLD P. BROWN,**

*The Bond Expert,*

120 LIBERTY STREET, NEW YORK.



# The Blake Signal System

Increases Efficiency  
of Operation

— which means maximum earnings with minimum of operation cost and increased comfort and safety for passengers.

These happy results are obtained on high-speed interurban roads through the use of the Blake Signals

— because the dispatcher can communicate at any given signal point with a train crew, thus eliminating delays at meeting points and waits and stops for orders so common under the ordinary telephone system.

Economical to install and to operate.  
Ask for descriptive pamphlet, please.

**Blake Signal & Manufacturing  
Company**

246 Summer St.

Boston, Mass.

4

# Mica Prices Reduced

*Compare our prices on Raw Mica and Manufactured Mica with prices you have been paying our competitors.*

**WHY PAY FANCY PRICES?**

**CHICAGO MICA CO.**

VALPARAISO : : INDIANA

# The SIGNAL SYSTEM

that prevents accidents, facilitates traffic and promotes adherence to schedules

is made by the

**Telegraph Signal Co.**

82 State St., Rochester, N. Y.

7

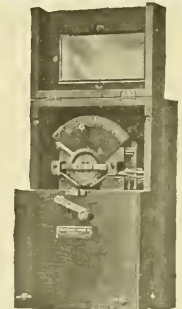

# CLASSIFIED ADVERTISEMENTS

Undisplayed advertisements are inserted under this heading at the uniform rate of one cent a word; minimum charge twenty-five cents. Replies directed to this office will be forwarded when required to any address in the United States, Canada or Mexico without extra charge. Advertisements received at the Chicago office by 9 a. m. Thursday will appear in the issue for the same week.

## POSITIONS WANTED.

Train dispatcher wants position; 5 years' experience with big electric system; best of references. Address "No. 564," care of Electric Railway Review, Chicago.

What can you offer young man with eight years' railway supply experience in sales department? Office or selling. Good correspondent. Unimpeachable reference. Address "No. 557," care of Electric Railway Review, Chicago.

Position wanted as track foreman by a reliable and practical construction man of many years' experience on both city and interurban roads. Can give good engineering reference; do not drink. Address "No. 565," care of Electric Railway Review, Chicago.

Officers of electric railway properties desiring services of an experienced operating superintendent, young, energetic and reliable. Handling successfully handled a 200-car system, are requested to address "No. 555," care of Electric Railway Review, Chicago.

Accountant, first-class, desires position. Good executive ability and a strict business man. Can keep any kind of accounts render comparative statistical statements, and not afraid to go against anything. Make me an offer. Address C. K. Tilton, Suite A-1, Champion Bldg., Atlantic City, N. J.

An experienced supply salesman, who also has had thirteen years' operating experience on city lines, desires to form connection with a railway supply house handling either electric or steam supplies or both. Would consider proposition to open sales agency. Address "No. 566," care of Electric Railway Review, Chicago.

Position Wanted—Accountant and auditor thoroughly qualified to take full charge of office. Ten years' experience as auditor, bookkeeper and office manager. Can establish and maintain complete system of accounts. Street and interurban railway properties a specialty. Address "No. 554," care of Electric Railway Review, Chicago.

## POSITIONS WANTED.

Position as chief engineer and machinist wanted. Will go to responsible company on trial. Have had 25 years' practical experience. Address "No. 563," care of Electric Railway Review, Chicago.

Position as auditor wanted by a young man of experience in street railway and electric light accounting. Best of references as to character and ability. Address "No. 545," care Electric Railway Review, Chicago.

Position as chief clerk or auditor by young single man with seven years' experience electric railway work. Good knowledge of operating departments; exceptional references. Address "No. 559," care of Electric Railway Review, Chicago.

Expert armature winder on all types of G.E. and Westinghouse motors is open for a position. Live, up-to-date man, capable of handling men. Excellent habits. A-1 references. Address "No. 552," care of Electric Railway Review, Chicago.

Master mechanic of undeniable ability and experience is at liberty to accept reasonable offer. Has had 15 years' experience in both steam and electric service. Has exceptional ability in equipping new rolling stock and handling shops and men on economical basis. Address "No. 560," care of Electric Railway Review, Chicago.

Experienced master mechanic desires position. Has thorough knowledge of high-speed electric railway equipment, on third rail or trolley. Is good executive, tactful and able to organize work of departments. Best of references furnished. Will consider position with high-speed interurban or city railway. Address "No. 550," care Electric Railway Review, Chicago.

Position by draftsman; have had nine years' experience in electric railway work, instrument work, mechanical and electrical drafting. Experience; assistant to master mechanic and inspector of car construction, equipment and maintenance; track work and buildings. Also familiar with operation. Thoroughly reliable. Address "No. 549," care of Electric Railway Review, Chicago.

## POSITIONS OPEN.

Wanted—Electrical salesman who is selling to street railways to take important side line. J. W. Morrison, 29 Griswold St., Detroit, Mich.

Park superintendent wanted. State experience and salary wanted; also give references. Address "No. 561," care of Electric Railway Review, Chicago.

Technical men. Positions open in all departments. Write today if you will consider better position, change of location. Twelve offices. Service confidential. HAPGOODS, 305 Broadway, New York, or 1010 Hartford Bldg., Chicago.

## BUSINESS OPPORTUNITIES.

Exclusive sales agency wanted for Chicago and west for several street railway specialties. Appliances for cars only. Address "No. 556," care of Electric Railway Review, Chicago.

Wanted—Man with some capital and a knowledge of railway track supplies to join the advertiser—a salesman handling locomotive and car supplies—in a general railway supply business. Address "No. 558," care of Electric Railway Review, Chicago.

Don't throw away your old batteries. We have a preparation which will positively renew old dry batteries at the cost of two cents each. Trial package and electrical catalogue 10 cents. Adams Electric Co., Dept. E. R., Kewanee, Ill.

Experienced salesmen, opening office in Washington, D. C., desire to make arrangements to represent manufacturers of standard specialties and supplies for electric railways and contractors. Southern territory. Address "No. 562," care of Electric Railway Review, Chicago.

## BOOKS AND PUBLICATIONS.

Ask us about any book on electric railway and allied subjects. We publish some and sell all that are in print. The Wilson Company, 160 Harrison Street, Chicago.

## MISCELLANEOUS WANTS.

Want to buy second-hand equipment, machinery or material? A card inserted in the Electric Railway Review, stating just what you want, will bring immediate response. The cost is small—only \$1.20 an inch (measuring 1 inch deep by 1½ inches wide) per insertion. Send orders to Electric Railway Review, 160 Harrison St., Chicago.

What have you to sell in the way of second-hand equipment, machinery or material? Buyers read the "For Sale" cards on the following page and there is the place to tell your story. "For Sale" cards are inexpensive—only \$1.20 an inch (measuring 1 inch deep by 1½ inches wide) per insertion. Special rates on contracts for 100 inches or more to be used within one year. Now is the time to send your order to Electric Railway Review, 160 Harrison St., Chicago.

## BOOKS AND PUBLICATIONS.

Wanted—Copies of the Street Railway Review of April, 1900, May, 1901, and August, 1903. State price and condition. Address "No. 553," care of Electric Railway Review, Chicago.

We want your friends to read the Electric Railway Review. You will do them—and us—a favor by sending their addresses. We will gladly mail free sample copies. Electric Railway Review, 160 Harrison Street, Chicago.

If interested in any phase of steam transportation, you will find every development covered fully and accurately in The Railway Age. It is the leader and acknowledged authority in this field. Ask for free sample copies. The Railway Age, 160 Harrison Street, Chicago.

A copy of "The Motorman and His Duties," the standard handbook on the theory and practice of electric car operation, is worth many times its cost to every man interested in the subject. Send for 16-page pamphlet of sample pages. The Wilson Company, 160 Harrison Street, Chicago.

## If You Have a Position for a High Grade Man

you can quickly secure his services in one of two ways

- by answering "Positions Wanted" advertisements on this page, or
- by advertising on this page under the heading, "Positions Open"

**Either plan will prove a winner—try it now**



SPRINGS—TIRES—STEEL-TIRED WHEELS  
**RAILWAY STEEL-SPRING CO.**  
 General Offices: 71 Broadway, New York

**HEINE SAFETY  
 BOILER CO.**  
 421 OLIVE STREET, ST. LOUIS, MO.  
 Manufacturers of WATER TUBE BOILERS

**NO SNOW TO DELAY CARS**  
 The Russell Snow-Plow is used by more than 50 roads to maintain schedules and prevent blockades. Russell Car & Snow-Plow Co., Ridgway, Pa. Wendell & MacDuffie, Cortlandt St., New York; C. A. Ralston, Fisher Bldg., Chicago; Robinson & Cary Co., Saint Paul.  
**IF YOU HAVE A RUSSELL**

**R.W. MARSHALL & CO.**  
 95 and 97 Liberty St., NEW YORK  
 Second-Hand Machinery and Equipment  
**ELECTRIC RAILWAY MATERIALS**

**RAILS**  
*Locomotives Cars Etc*  
 Bought & Sold  
*Walter A. ZELNICKER Supply Co.*  
 174 ST. LOUIS

**FOR SALE CHEAP!**  
 One 1422 eight-wheel locomotive  
 Ten 34-foot 50,000 capacity flat cars  
 Two Greenleaf turntables  
 70 box cars, 40 and 50,000 capacity  
 80 Good Second-hand Bridges  
 Specifications and Blue Prints on application  
**F. A. JOHANN**  
 1824 Pierce Bldg., St. Louis, Mo.

**GREEN TRAVELING LINK GRATES**

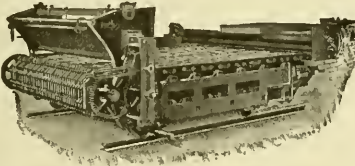

Highest Capacity  
 Highest Efficiency  
 Automatic Smokeless  
 Labor Saving  
 Cheap Fuel

**GREEN ENGINEERING CO.**  
 Main Office: Commercial National Bank Bldg., Chicago, Ill.  
 BRANCH OFFICES: Pittsburgh; St. Louis; St. Paul; Louisville  
 General Foundry Work a Specialty

**FOR SALE: Three Car Bodies and Three Pairs of Double Trucks**  
 with or without electric equipment and air brakes; all new and never used. Compelled to sell, as these cars will not operate over a leased line by reason of their width and length.  
**R. W. MARSHALL & CO., 97 Liberty St., New York, N. Y.**

**FOR SALE:**  
 6-inch Girder Rails and 7-inch T Rails  
 70-lb. and 70-lb.  
 Second-hand, in first-class condition, almost as good as new. Removed to give place for grooved rails required by city. 130 tons of each, with splice bars. Price \$25.00 f. o. b. Columbus. Inspection solicited.  
**THE COLUMBUS RAILWAY & LIGHT CO., Columbus, Ohio**

**Gasoline Motor Cars for Street Car Service**

Can be used advantageously for owl car service and on branch lines of large railroads where the passenger traffic does not warrant the maintenance of a regular train schedule.

Address R. R. Dept. No. 757 MS.

**Fairbanks, Morse & Co.**  
 CHICAGO, ILLINOIS

**FOR SALE CHEAP**  
**200 Second Hand STREET CAR BODIES**  
 Vestibule and Open, in elegant condition.  
 Also 1,000 New Car Folding Gates and 300 Car Stoves  
**THE ISAAC JOSEPH IRON CO. OF CHICAGO** 1247 First National Bank Building.

**AUTOMATIC TROLLEY GUARD CO.**  
 391-393 Ellcott Square, Buffalo, N. Y.  
**"IT PUTS THE WHEEL ON THE WIRE"**

**PATTEN TICKET DESTROYER**



Don't burn your used tickets. Destroy them, and avoid fraud. Remember, it is difficult to get a man to destroy anything of value to him.  
 Sell the old stock—it will soon pay for machine.  
 In use on the Boston & Northern R. R., Old Colony St. Ry. Co., Breckton St. Ry. Co., Waterbury El. Co., Bridgeport Traction Co., Buffalo Ry. and others.  
 Write for circular.  
**PAUL B. PATTEN**  
 78 Lafayette Street - SALEM, MASS., U. S. A.

**THE MIGHTY MIDGET HOT WATER CAR HEATER**  
 Adapted for Large Electric Cars and Long Distance Lines. Exclusively used on Largest Electric Systems. Ask for Catalog  
**THE WILLIAM C. BAKER HEATING & SUPPLY CO., 143 LIBERTY STREET NEW YORK**

**ANY BOOK** on Railway and Allied Subjects now in print sent prepaid upon receipt of price by **THE WILSON CO., 160 HARRISON STREET CHICAGO**

**THE ARNOLD COMPANY**  
 ENGINEERS—CONSTRUCTORS  
 ELECTRICAL—CIVIL—MECHANICAL  
 101 LA SALLE STREET  
 CHICAGO

**A. L. REGISTER & CO.**  
 Engineers and General Contractors—Electric Railways  
 112 North Broad St. PHILADELPHIA, PA. Established 1889

**SHIMER & CHASE CO.**  
 Experienced Promoters of Electrical Railway Projects  
 Correspondence Solicited OMAHA, NEB.

**H. M. Bylesby & Company**  
 Incorporated  
 ENGINEERS  
 American Trust Bldg., Chicago

**CENTRAL INSPECTION BUREAU**  
 Inspection of Rails, Ties, Cars, Motors, Bridges, Buildings, Etc.  
 17 STATE STREET - - - - NEW YORK CITY

Design, Construct and Operate  
 Railway, Light, Power and  
 Hydraulic Plants EXAMINATIONS AND  
 REPORTS

**LINE MATERIAL**  
 ELECTRIC SUPPLIES FOR RAILWAYS, POWER PLANTS, ETC.  
 THE CREAGHEAD ENGINEERING CO., 346 Main Street, Cincinnati, Ohio

**J. G. WHITE & COMPANY**  
 INCORPORATED  
**Engineers, Contractors**  
 43-49 Exchange Place, New York, N. Y.  
 41-43 Wall Street  
 Principal Philippine Office: Manila, P. I.

**THE CURTAIN SUPPLY CO.**  
 CAR CURTAINS  
 CHICAGO, 85-93 Ohio Street 1819 Park Row Bldg., NEW YORK

**Gongs** For Street Cars **Bells**  
 G. C. REITER, Canton, Ohio

**Ford, Bacon & Davis,**  
 Engineers,  
 115 BROADWAY,  
 NEW YORK.

**HOT WATER HEATERS FOR CARS**  
 THE PETER SMITH HEATER COMPANY, Detroit, Mich.

**ELECTRIC HEATERS** For All Classes  
 of Cars  
 New York Consolidated Car-Heating Co. Chicago

**COLUMBIA CONSTRUCTION CO.**  
 BUILDERS OF  
**Electric Railways**  
 Colby and Abbot Building : MILWAUKEE, WIS.

**BRAKESHOOES**  
 STANDARD  
 BRAKESHOE COMPANY  
 GEN'L OFFICES & WORKS - AURORA, ILL. CHICAGO OFFICE 315 RY EXCH.

**GRIFFIN WHEEL CO.**  
 CHICAGO  
 CHILLED IRON CAR WHEELS IRON OR STEEL AXLES

**The Roberts & Abbott Co.**  
 E. P. ROBERTS ENGINEERS W. H. ABBOTT  
**Electric Railways, Light and Power**  
 Complete Industrial Plants Water Power Development  
 CLEVELAND CHICAGO PHILADELPHIA BALTIMORE

WRITE TO **MODEL STOKER COMPANY** DAYTON OHIO  
 for detailed information about the best  
**AUTOMATIC SMOKELESS FURNACE**

**WHEEL TRUING BRAKE SHOES**  
 Repair Crippled Wheels While Running  
**THE WHEEL TRUING BRAKE SHOE CO.,** Detroit, Mich.

**Surface, Jet and Barometric Condensers**  
**Edwards Air Pumps Centrifugal Pumps**  
**Water Cooling Towers**  
 Wheeler Condenser & Engineering Company  
 CARTERET, N. J.  
 90 West Street, NEW YORK Monadnock Block, CHICAGO, ILL.

**E N G I N E E R S**

who wish to be numbered among the  
 elect should be represented on this page

The cost is small—ask us about it

**ELECTRIC RAILWAY REVIEW**  
 160 Harrison Street, Chicago



**SOLENOIDS AND MAGNETS**  
 for any purpose; lift and travel guaranteed.  
 Special electrical work and motors.  
**THE PORTER MFG. CO.** 29 Griswold Street  
 DETROIT, MICH.

**CAR ADVERTISING**  
*Barron & Collier*  
 ALMOST EVERYWHERE  
 Flat Iron Building, New York.

**THE NATIONAL LOCK WASHER CO.,** NEWARK, N. J.  
 Curtains - Curtain Fixtures - Sash Locks - Sash Balances - Nut Locks  
 CHICAGO OFFICE: 419 MONADNOCK BLOCK

Specify the Genuine Roller. It is that Element that makes a Car Curtain a Success. Every Genuine Roller has the Name of Manufacturer



**HARTSHORN'S**  
TIN ROLLER

**STEWART HARTSHORN**  
— IN SCRIPT ON LABEL —  
**STEWART HARTSHORN CO.**  
 Office and Factory, E. NEWARK, N. J.  
 NEW YORK, 382 Lafayette St. CHICAGO, 335-344 Wabash Ave.

Special Car Rollers are made. Brackets are made for all classes of fittings. Used all over the world wherever cars are run.



**NILES CARS** — THE ELECTRIC PULLMANS

LARGE, FAST INTERURBANS  
 OUR SPECIALTY

**NILES CAR & MFG. COMPANY**  
 WORKS: NILES, OHIO  
 Sales Office: J. A. HANNA Co., 312 Electric Bldg., Cleveland, O.

**Galena-Signal Oil Company**  
 FRANKLIN, PA.

THEIR SPECIALTIES

**STREET RAILWAY LUBRICATION** including both rolling stock and power house equipment.  
 Same skillful expert supervision given in this service as in steam railway service has produced very satisfactory results. The business of our Street Railway Department has increased beyond every expectation. In 1906 this department sold ten times the number of barrels of oil sold by the same department in 1903.  
 We are under contract with many of the largest street and interurban railways of the country.  
 We guarantee cost per thousand miles in street railway service when conditions warrant it.  
 Write to Franklin, Pennsylvania, for further particulars.

**STEAM RAILWAY LUBRICATION** Sole manufacturers of the celebrated Galena Coach, Engine and Car Oils for steam railway lubrication. Sibley's Perfection Valve Oil for cylinder lubrication, and Perfection Signal Oil for use in railway signal lanterns.

**GALENA RAILWAY SAFETY OIL** Made especially for use in headlights, cab, classification and tail lights, and for switch and semaphore lamps. Burns equally well with the long time as with the one-day burner; with or without chimney as the burner requires. Is pure water white in color; high fire test, low cold test, and splendid gravity.

CHAS. MILLER, President



Passenger Paying Fare

Street Railways using the

**Rooke Automatic Fare Collector**

get every nickel collected because every nickel is registered before it reaches the conductor's hand. No chance to go astray!

**Rooke Automatic Register Co.**  
 Providence, Rhode Island

**VALVES—FITTINGS—STEAM SPECIALTIES**  
**CRANE CO.**  
 CHICAGO  
 ESTABLISHED 1865

We are Producers and Wholesale Dealers in Western  
**CEDAR POLES**  
 Yards in Washington, Idaho, Montana  
 and British Columbia  
 WRITE US FOR DELIVERED PRICES  
**CHURCHILL CEDAR CO.,** Box 1409, Spokane, Wash.

**The Lindsley Brothers Company**  
 Producers and Shippers of **WESTERN CEDAR POLES** and Manufacturers of **RED FIR CROSS ARMS**  
 Eastern Sales Office, Monadnock Bldg., CHICAGO SPOKANE, WASHINGTON

**POLES and PILING** 20,000 35s and 40s, Ready to Ship at Once  
 S-E. MISSOURI CYPRESS CO., CAMPBELL, MO.

**G. H. BARNES HARDWOOD LUMBER CO.**  
 Office and Yard: Main and Warren Sts., ST. LOUIS, MO.  
 Ties, Car Oak, Poplar, Ash, Cherry, Plain and Quartered Oak

**TRACKLAYING BY MACHINERY**  
 SIMPLE, RAPID AND ECONOMICAL  
 D. F. HOLMAN RAILWAY TRACKLAYER CO., 1102 Ellsworth Bldg., Chicago

**C. H. WORCESTER CO.**  
**CEDAR POLES**  
 PRODUCERS AND WHOLESALEERS  
 Suite 1710 Tribune Building CHICAGO

**Idaho Cedar Poles**  
 PACIFIC COAST POLE CO. SPOKANE, WASH.

For prompt deliveries of  
**Cedar Poles** Red or White  
 write either office today.  
**NATIONAL POLE COMPANY**  
 EVERETT, WASH. ESCANABA, MICH.

We have in our Chicago Yard available for **RUSH SHIPMENTS** a **SELECTED STOCK** of **POLES** and **TIES**  
**NAUGLE POLE AND TIE CO.**  
 Chicago Office, 226 La Salle Street

**CHESTNUT POLES**  
 Cedar, Oak and Chestnut Ties  
 FROM OUR OWN TIMBER LANDS  
**THE ADVANCE LUMBER CO.**  
 CLEVELAND, OHIO

**VOLTALAC** FOR INSULATING ARMATURE AND FIELD COILS  
 TRADE MARK Almost Every Big Electric Railway In the U. S. and Europe uses it  
**STANDARD VARNISH WORKS**  
 LONDON NEW YORK CHICAGO

**Special Work for Street Railways**

Switches and Crossings  
 Mates with Hard  
 Frogs Steel Centers



Cast Weld Compromise Rail

Barbour - Stockwell Co., 205 Broadway, Cambridgeport, Mass.

**M**OST people have about all they can do to keep track of their own business—that is why it is necessary to tell them about yours.

It is only by telling them about the attractions of your road and your territory—telling them systematically and frequently—that you can keep them interested and obtain the maximum amount of business.

The Van Valkenburgh Advertising Service helps you to tell your story systematically, convincingly and economically. Let's talk the matter over.



**E. C. Van Valkenburgh**  
**Promotional Advertising**  
**for Electric Railways**  
 2117 West 102d Street, Chicago

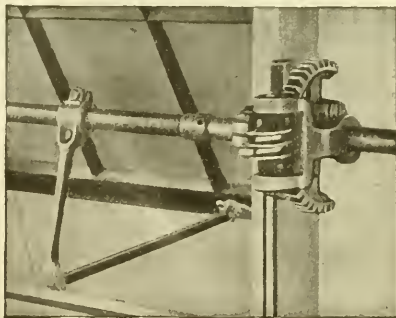

### The Ventilation

of your Shops, Foundries and Car Barns is made especially effective by a speedy, positive and easily manipulated **Sash Operating Apparatus** which automatically locks the sash at any position.

*Let us send you our catalogue.*

**Lord & Burnham Company**  
 Irvington-on-Hudson, N. Y.

THE RAILWAY SPECIALTY  
 AND SUPPLY CO.

## TRACK BOLTS

Great Northern Building  
 CHICAGO

# FOSTER SUPERHEATERS

SAVE FEED WATER, CONDENSING WATER, COAL AND BOILER POWER

**POWER SPECIALTY COMPANY**  
 111 Broadway, New York



DESIGNS for ADVERTISING  
 BIRDS EYE VIEWS

**HALF TONES**  
 Photographing Machinery  
 & Retouching ART PRINTING  
**WOODBURY CARLTON & CO.**  
 WORCESTER, MASS.



THE

## Bellamy Vestlette

For Street Railway Conductors

**ABSOLUTELY SAFE. Money cannot be lost or stolen from these pockets OVER 150,000 IN USE**

Saves the price of a coat yearly. Conductor's uniform always presentable. Adopted as a part of the uniform by over 200 Street Railway Companies. Price \$2.00, sent to any address prepaid, where we have no agent. Agents wanted on every line.

The Bellamy Vestlette Mfg. Co., Cleveland, O.  
 and A. F. JURY, 265 Yonge St., Toronto, Canada

Patented April 27, 1897

## "Not an Experiment"

The Providence Fender has been in successful operation on hundreds of roads for 13 years, and has proved itself reliable under all conditions of Street Railway service.

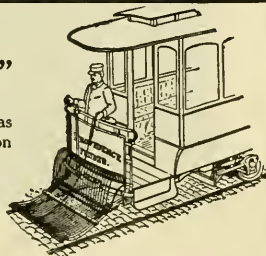

### CONSOLIDATED CAR FENDER COMPANY

Office and Factory: PROVIDENCE, R. I.  
 Branch Office: 110 E. Twenty-third St., New York  
 European Agents: Comptoire d'Electricite, 6, Rue Boudreau, Paris, France



# 10c per day

will heat that car if you use a **COOPER HEATER**

Ask for descriptive matter

The Cooper Heater Co., Dayton, Ohio

# ROLLING DOORS

In Steel, Wood or Bronze

FOR CAR BARNs, FREIGHT SHEDS, ETC.

Made by the

## JAS. G. WILSON MFG. CO.

New York Office: 3 W. 29th Street

ESTABLISHED 1876

Incorporated 1903

# Kinnear

STEEL  
Rolling Doors  
FOR CAR HOUSES



Operate Easily, Speedily, Satisfactorily  
and are very durable. Write for Catalog

## The Kinnear Manfg. Co.

COLUMBUS, OHIO.

BOSTON  
65 WATER ST.

CHICAGO  
112 CLARK ST.

PHILADELPHIA  
101 CHESTNUT ST.



Established 1877.



## ALBERT & J. M. ANDERSON MFG. CO.,

Makers of

**ELECTRICAL APPLIANCES:**  
SWITCHES, SWITCHBOARDS,  
TIME SWITCHES, LINE MATERIAL,  
COPPER CASTINGS (75% CONDUCTIVITY).  
289-293 A ST., BOSTON, MASS., U. S. A.

Branches:

New York, 135 Broadway.

Chicago, 175 Dearborn Street.

Agencies:

Boston, Pettengell-Andrews Co.

San Francisco, Eccles & Smith Co.

New York, R. W. Marshall & Co.

Atlanta, Newcomer-Manry Co.

St. Louis, J. C. White.

Denver, E. M. Messiter.

Toronto, Ont., H. J. Surtees.



# TUBULAR POLES

IRON OR STEEL



FOR  
ELECTRIC RAILWAYS  
ELECTRIC LIGHTING CO'S  
SIGNAL TELEPHONE VICE TELEGRAPH  
TRANSMISSION LINE  
AND CATENARY SUSPENSION LINE

**ELECTRIC RAILWAY EQUIPMENT CO.**  
General Office: CINCINNATI-O-U-S-A  
Shops: READING PA - WHEELING WVA

# Shawmut Soldered Bond Cap

to make over your  
PLUG BONDS



Why not look this up

## CHASE-SHAWMUT CO.

Newburyport, Mass.

# Electric Railway Review

PUBLISHED EVERY SATURDAY BY THE WILSON COMPANY, CHICAGO

Entered as second-class matter January 5, 1907, at the postoffice at Chicago, Ill., under the act of March 3, 1879.

160 Harrison Street, Chicago  
150 Nassau Street, New York  
1529 Williamson Bldg., Cleveland

Vol. XIX  
No. 11

CHICAGO, MARCH 14, 1908

Whole No.  
255

Subscription: Domestic . . . \$2  
Foreign . . . \$5  
Canada . . . \$3.50

The inauguration of electric service on certain branch lines of the New York New Haven & Hartford Railroad in Connecticut illustrates an interesting phase of

## Branch Line Railroad Electrification.

recent steam road electrification. It is noteworthy that this branch line work is being pushed forward with all feasible celerity. The class of service to be maintained on these branches differs, of course, considerably from the electric locomotive service that was inaugurated last year on the main line between New York and Stamford. It is practically an interurban service on steam road tracks and dispenses with the costly scheme of running infrequent and cumbersome steam trains for light traffic and short distances. Electric interurban cars are operated both in the city streets of Hartford, Berlin and Meriden and on the regular railroad trackage of the company in cross country running. Thus it is clearly a great advantage to escape the limitations of the highway in operating between these populous centers. The New Haven system, as is well known, occupies a territory that is very densely populated, and its earnings from freight and passenger service are nearly equal. Its mileage is very largely distributed in a network of branch lines, and, with the important main line electrification projects now under consideration or pending, and the broad-minded policy of branch line electrification set in motion, will be sure to establish a precedent for other systems. The old idea was that the main lines of the steam roads carrying a very heavy traffic would first be electrified, but the success of the lighter branch line work will do much to hasten the complete electrification of all systems where frequent service is a necessity.

The prospects for additional subway construction in New York City have been greatly complicated within the past few

## Subways in New York.

days by the announcement of Comptroller Metz that the available borrowing capacity of the city is not sufficient to build any subways at the present time and probably will not be for the next two years. There are now 19 of what Mr. Metz calls "blue-pencil subways" on the maps of the public service commission and the approval of the board of estimate is sought for two more. The city is clamoring for additional transit facilities and actually requires more subways to handle the present traffic, not to mention providing for future development. In this connection an anomalous condition is presented in the status of the so-called Belmont or Steinway tunnel owned by the Interborough Rapid Transit Company. This tunnel, which extends under the East river at Forty-second street and is an important link between the trolley systems of Long Island and the entire transportation system of Manhattan, was practically completed several months ago and, according to the officers of the company, could be placed in operation in connection with the subway within 60 days. The tunnel, however, remains idle because of a cloud on the franchise, which is being contested in the courts at the instance of the city. Not being in a position to operate, the Interborough company has offered to sell the tunnel to the city for the cost of construction, to be operated jointly by the city and the New York & Queens County Railway. Because of a dispute as to juris-

diction neither the city nor the public service commission has taken any action on the proposal and it is doubtful if the city is in a position to finance the purchase at the present time. It would seem that the only available solution would be for the city to withdraw its suits and allow the company to apply for a new franchise. The general situation would be greatly relieved by the passage of a bill now pending before the legislature to permit the public service commission to grant franchises for subway construction to private companies.

It is not an absolutely new experience for managers of electric railway systems to be forced by the decrease in revenues

## Do Not Encourage Walking.

to curtail, as far as consistent, all expenditures. The advisability of providing under such conditions an available supply of money as large or in proportion to the surplus kept in normal times cannot be questioned. One of the best examples of this far-sightedness comes from the management of an elevated road in the central west which by reducing the dividends 1 per cent for the coming year will avoid the necessity of issuing bonds or certificates to meet depreciation or the purchase of new equipment. But a strikingly opposite plan has been put into effect on an eastern city system and with a radical difference in results. It was thought that by reducing the car mileage a saving equal to the loss in daily revenues could be maintained and the one balance the other. Therefore a trial was made. The result after several weeks' experimenting is a decided loss to the company. People having short distances to go or those having longer distances that could be reached in a short time have found that the time consumed in waiting for a car and then getting to their destination would be equal to or nearly as great as the time necessary to walk the entire distance. A street car system should not educate those upon whom it is dependent for an existence to employ some different means of locomotion. Otherwise the result will be bad. A majority of those who are thus educated to walk, partly through inadequate transportation facilities, may continue in this practice. If this proves true the loss is permanent. In times when plans are proposed to meet temporary conditions only it would be well to make certain that the operation of such plans does not overlap and carry ill effects to a season that should bring plentiful earnings.

We have been favored with a copy of the "blue book" of the Ft. Wayne & Wabash Valley Traction Company. This book

## A Railway Blue Book.

is so unique in character and fills such a peculiar niche in electric railway operation that a fitting announcement of its contents is warranted here. The blue book is comprised of a long strip of blue print paper folded into a booklet of 38 pages. As explained by its donor, "This book is issued by the maintenance of way department of the Ft. Wayne & Wabash Valley Traction Company. It is printed every little while and not oftener than once a year and distributed for our convenience and the admiration of our friends." The first cover of the book exhibits views along the "Wabash valley route." The second page is a directory

of the executive and operating staff of the railway. On the next page are tables showing track elevation for various degrees of curvature and practical leads used in placing switches and frogs. Then come six photographic views along the route showing the attractiveness of the roadway and the territory served. A general map including the Wabash valley route and other electric roads in northern Indiana is presented. The major portion of this interesting booklet is a very complete route map, including the main lines and various local divisions. The information exhibited on this map should make it of especial value to any and all of the operating staff. There are exhibited as follows: Location of each town and county line intersected; each highway, railway, waterway and farm road crossed; each stop and siding; the owner's name and the boundary of each farm crossed; the location of substations; the rail sections of which the track is composed; the population of the important cities; the names of the various track foremen and the exact limits of their sections; the location of the various power stations, their capacities, the arrangement of alternating and direct current feeding and distribution wires, including their sizes, and the arrangement of the trolley and telephone wires. The map presenting all this information for the entire Ft. Wayne & Wabash Valley route is 145 inches long and very carefully made. On inspection one can readily see how valuable this blue book must be as a handy means of reference.

---

#### HIGH-VOLTAGE DIRECT-CURRENT TRANSMISSION.

Preliminary engineering work is being carried on with a view to designing a transmission system which may be used to carry electrical power from a hydraulic generating station at Victoria Falls to the mining districts 700 miles away in South Africa. Both European and American engineers are engaged in this work. The opinion of the European engineers is that for so great a transmission distance it will be possible to operate only with direct current at what are now considered excessively high voltages. The American engineer also engaged in this work, is Ralph D. Mershon. He holds the opinion that the transmission of a large amount of power over so great an intervening distance will be possible only by utilizing alternating current.

The opinions of these engineers is indicative of the substance of frequent discussions which recently have taken place before engineering bodies in Europe. Briefly, the point at issue is whether or not high-voltage direct currents are feasible for long-distance power transmission. With the characteristics of alternating-current transmission lines in mind, it may be interesting to outline briefly the so-called "Thury" direct-current system of high-tension transmission.

In contrast with our low-tension direct-current distribution networks with their constant potential and varying current, the Thury system employs a constant current and a variable potential obtained by varying the generator speed. To obtain the high voltages, generators wound to deliver constant current are electrically connected in series so that the difference of potential across the entire series is sufficiently high for the transmission purposes. Each of the direct-current generators is insulated from the ground and from the prime mover which drives it, the latter insulation being effected by means of a flexible shaft coupling composed of silk. As the machines are insulated from the ground, the commutator on any machine is subjected only to the difference of potential between its own brushes, while the difference of potential between the terminals of the end machines may be as high as 80,000 volts.

The power generated is controlled in amount by regulation of the voltage. This regulation is effected by varying the generator speed through the medium of an electrically controlled governor, which decreases the speed when the load decreases and vice versa.

A single circuit only is required for the transmission of the power. At the receiving end motors are arranged as at the generator end. These motors are wound for constant speed, the speed being kept uniform by means of a centrifugal governor which shifts the brushes as the load varies. Thus, as the load decreases the speed tends to increase and the governor then moves the brushes toward the neutral point. With the brushes moved toward the neutral point, the current tends to decrease and this in turn causes the governors in the power house at the other end of the line to decrease the speed of the generators until the required voltage for the load on the motors is obtained.

In Europe a transmission system of this character is said to be operating satisfactorily. The Thury system as yet is untried in America. This may be accounted for by reason of the fact that so many important advancements have of late been made in the art of alternating-current power transmission.

---

#### CAR ILLUMINATION WITH ARC LAMPS.

A brightly illuminated passenger car is a good advertisement. Plentiful illumination in cars is appreciated by passengers and advantageously noted by the non-passenger part of the public. These fundamental facts are becoming more generally recognized and various types of lamps in numerous combinations are used to obtain the desired effect. For illuminating the interiors of large interurban cars, the arc lamp is a medium which is worthy of careful consideration.

The enclosed arc lamp is used for general illumination on the interurban cars of the Pacific Electric Railway, Los Angeles Interurban Railway, San Francisco, Oakland and San Jose Railway, and the Northern Electric Company, all in California; and among the eastern roads using this method of illumination is the recently built Philadelphia & Western Railway.

Cars illuminated with arc lamps present a more brilliant effect than cars lighted with incandescent lamps. The arc lamp, of course, requires more current than the number of incandescent lamps which would usually be considered necessary to do the same work; but on the other hand the arc lamps give the interior of a car a much more attractive appearance. Severe variations in voltage which cannot well be avoided on long interurban lines, do not as seriously affect the illuminating power of arc lamps as they do the candlepower of incandescent lamps. This feature of providing a passenger with a sufficient amount of light to enable him to read uninterruptedly during his entire journey, without any particular inconvenience whether the train be standing or starting, is appreciated where arc lights are used.

The cars of some roads are lighted with only one interior arc light and when this light can be operated in series with the arc headlight very economical results are obtained. The large interurban cars of the Pacific Electric and the Los Angeles Railway companies are wired for two interior arc lights connected in parallel, and this circuit in turn is in series with the arc headlight. When these cars were first put into service, they were wired with the two interior lights in series with the headlight and in this way the headlight received but the three amperes of current which also passed through the two interior lights in series with it. On account of the high speed at which some of the cars operated on the longer lines, it was found that the headlights did not illuminate the track far enough in advance of the car; therefore, to provide for a more powerful illumination with these same headlights, they were rearranged so that they would operate with six amperes of current rather than three. To furnish this amount of current it was found that a most economical way was afforded by connecting the two interior arc lights in parallel with lamps burning at the rate of three amperes and the pair in series with the 6-ampere headlights. Thus, the benefit of



the additional current required in the headlight for intense illumination is obtained while the cars are lighted in exactly the same way, and yet it is not necessary to waste current in a resistance which otherwise would have been required to limit the headlight current to six amperes.

The life of the carbons in the enclosed arc lamps suitable for interurban car illumination is about 50 hours. This is sufficient for several days' service, but nevertheless the lamps will operate more effectively when trimmed each day. Inasmuch as the jolting of the car puts an arc lamp to a rather severe test, it is only fair that it should have daily inspection. In comparison with its competitor, the electric bulb, the arc lamp gives a plentiful and uniform illumination throughout wide variations in voltage, while the incandescent lamp gives a softer, less powerful illumination varying with excessive changes in voltage.

**ANNUAL REPORTS.**

**Winnipeg Electric Railway.**

Gross earnings of the Winnipeg Electric Railway in 1907 increased 21.62 per cent over 1906. As operating expenses increased only 10.53 per cent, the net earnings from operation showed a gain of 30.75 per cent. Earnings for the last two years compare as follows:

	1907.	1906.	Increase.
Gross earnings .....	\$1,722,407	\$1,416,305	\$306,102
Operating expenses .....	775,731	701,964	73,767
Net earnings .....	\$ 946,676	\$ 714,341	\$232,335
Fixed charges .....	386,667	251,037	135,630
Divisible income .....	\$ 560,009	\$ 463,304	\$ 96,705
Dividends .....	373,137	248,669	124,468
Surplus .....	\$ 186,872	\$ 214,635	*\$27,763
Operating expenses, per cent of gross earnings .....	45.05	49.56	51.42

\*Decrease.

William Mackenzie, the president, gives a list of additions made during the year, which include 40 additional double-truck cars, of which 20 were constructed at the shops of the company and 20 by the Ottawa Car Company; 19.5 miles of track; equipment of all cars with air brakes and heaters for motormen's vestibules; 1,588 new poles and 340,088 pounds of wire, used in the extension of electric lighting and power lines; 48,007 feet of new gas mains required in extensions; 838 new gas services; and an addition to the Ft. Rouge car house, with a capacity of 50 cars. The "cost of property" on the balance sheet as of December 31, 1907, is \$12,001,911, as compared with \$10,654,759 at the end of the previous year. The amount of outstanding bonds was not changed in the year from \$5,400,000. The capital stock outstanding was \$5,320,950, an increase of \$945,750. The figures of passengers carried compare as follows:

	1907.	1906.	1905.
Passengers carried .....	20,846,317	17,229,554	13,081,249
Transfer passengers .....	5,954,067	3,109,094	1,682,685

**American Association Committees on "Classification" Appointed.**

The following committees on "Classification" have been appointed to consider the tentative classifications of the interstate commerce commission:

American Street and Interurban Railway Association—Gen. George H. Harries, chairman, Washington, D. C.; C. Loomis Allen, Utica, N. Y.; Frank R. Ford, New York, N. Y.; Arthur W. Brady, Anderson, Ind.; W. B. McKinley, Champaign, Ill.

American Street and Interurban Railway Accountants' Association—W. F. Ham, chairman, Washington, D. C.; H. L. Wilson, Boston, Mass.; Frank R. Henry, St. Louis, Mo.; William G. McDole, Cleveland, O.; C. N. Duffy, Milwaukee, Wis.

**REPORT ON CAUSE OF THE QUEBEC BRIDGE FAILURE.**

The report of the royal commission, consisting of Henry Holgate of Montreal, John G. Kerry of Campbellford and Prof. J. Galbraith of Toronto, appointed to investigate the cause of the failure of the Quebec bridge, which collapsed on August 29, 1907, was submitted to the house of commons of the Canadian parliament on March 9.

The findings of the commission, which were unanimous, are as follows:

(a) The collapse of the Quebec bridge resulted from the failure of the lower chords in the anchor arm near the main pier. The failure of these chords was due to their defective design.

(b) The stresses that caused the failure were not due to abnormal weather conditions or accident, but were such as might be expected in the regular course of erection.

(c) The design of the chords that failed was made by P. I. Szlapka, the designing engineer of the Phoenix Bridge Company.

(d) This design was examined and officially approved by Theodore Cooper, consulting engineer of the Quebec Bridge & Railway Company.

(e) The failure cannot be attributed directly to any cause other than errors in judgment on the part of those two engineers.

(f) These errors of judgment cannot be attributed either to lack of common professional knowledge, to neglect of duty or to a desire to economize. The ability of the two engineers was tried in one of the most difficult professional problems of the day and proved to be insufficient for the task.

(g) We do not consider that the specifications for the work were satisfactory or sufficient, the unit stresses in particular being higher than any established by past practice. The specifications were accepted without protest by all interested.

(h) A grave error was made in assuming the dead load for the calculations at too low a value and not afterward revising this assumption. This error was of sufficient magnitude to have required the condemnation of the bridge, even if the details of the lower chords had been of sufficient strength, because, if the bridge had been completed as designed, the actual stresses would have been considerably greater than those permitted by the specifications.

This erroneous assumption was made by Mr. Szlapka and accepted by Mr. Cooper and tended to hasten the disaster.

(i) We do not believe that the fall of the bridge could have been prevented by any action that might have been taken after August 27, 1907. Any effort to brace or take down the structure would have been impracticable, owing to the manifest risk of human life involved.

(j) The loss of life in August, 1907, might have been prevented by the exercise of better judgment on the part of those in responsible charge of the work for the Quebec Bridge & Railway Company and for the Phoenix Bridge Company.

(k) The failure on the part of the Quebec Bridge & Railway Company to appoint an experienced bridge engineer was a mistake. This resulted in a loose and inefficient supervision of all parts of the work on the part of the Quebec Bridge & Railway Company.

(l) The work done by the Phoenix Bridge Company in making the detail drawings and in planning and carrying out the erection, and by the Phoenix Iron Company in fabricating the material was good and the steel used was of good quality. The serious defects were fundamental errors in design.

(m) No one connected with the general designing fully appreciated the magnitude of the work nor the insufficiency of the data upon which they were depending. The special experimental studies and investigations that were required to confirm the judgment of the designers were not made.

(n) The professional knowledge of the present day concerning the action of steel columns under load is not sufficient to enable engineers to economically design such structures as the Quebec bridge. A bridge of the adopted span that will unquestionably be safe can be built, but in the present state of professional knowledge a considerably larger amount of metal would have to be used than might be required if our knowledge were more exact.

(o) The professional record of Mr. Cooper was such that his selection for the authoritative position that he occupied was warranted, and the complete confidence that was placed in his judgment by the officials of the dominion government and the Phoenix Bridge Company was deserved.

Recent floods in northern Ohio and Indiana have seriously interfered with service on the interurban lines.

THE BOISE & INTERURBAN RAILWAY.

The Boise & Interurban Railway of Boise, Idaho, was opened for traffic on August 8, 1907, between Boise and Caldwell, Idaho, a distance of about 29 miles. Boise, the capital, as well as the financial and social center of the state, has a population of 25,000. Caldwell, the other terminus, is a town of 5,000 inhabitants, located on the Oregon Short Line Railroad.

As will be seen from the accompanying map, the line runs parallel with the Boise river, through the thriving villages of Eagle, Star and Middleton, and through a territory hitherto without railroad connections. On November 16, 1907, the company also began operating a city loop of 3½ miles in Boise and both lines have since justified the expectations of the owners in the passenger traffic returns.

Track and Roadway.

The main line is 28.6 miles long, with about four miles of switch and side track, all located on private fenced right



Boise & Interurban Railway—Steel Truss Bridge, 550 Feet Long, over Boise River, Showing Interurban Passenger Car.

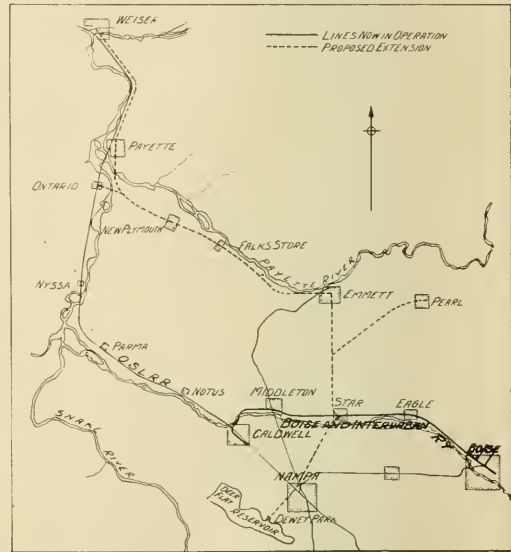

Boise & Interurban Railway—Map of Operating Line and Proposed Extensions.

of way, except where the road passes through the town or city streets. The track construction is of a substantial character, consisting of 60 and 72 pounds T-rails laid on standard ties and fully ballasted. In paved streets 7-inch T-rails are used. The rails are bonded with Ohio Brass Company soldered bonds through open country and with American Steel & Wire Company twin terminal cable bonds in the city, all of a capacity equal to No. 0000 copper wire.

A 550-foot 5-span through truss steel bridge, with concrete piers and abutments, as shown in one of the illustrations, has been built over the Boise river near Boise. Plate girder construction has been used for short spans.

Overhead Construction.

In the city the overhead construction is span-supported, with No. 0000 trolley wire. On the interurban line a double No. 0000 trolley wire is supported by 9-foot brackets, made of 2-inch tubing. A single line of 60-foot cedar poles carries the bracket construction, the high-tension transmission wires and a telephone line. The transmission line is 60 miles long

and is composed of No. 3 aluminum wires. The material for the overhead construction was furnished by the Ohio Brass Company. Miller No. 3 anchors and wooden slugs were used for fastening the guy wires.

**Power.**

Power is obtained from a hydro-electric plant on the Snake river at Swan Falls, Idaho, owned by the Trade Dollar Consolidated Mining Company, which has large interests in

ing crane, oil-filled water-cooled transformers, stepping the generator pressure up to 44,000 volts, static interruptors, oil switches, lightning arresters, etc. The current is carried over a 60-mile transmission line to two substations, where it is converted to direct current at 600 volts for operation.

The substation buildings, one of which is illustrated, are of white brick with concrete roofs, carried on steel girders, and are of fireproof construction. The equipment of each substation consists of one 300-kilowatt 600-volt 60-cycle rotary



Boise & Interurban Railway—Car House and Repair Shop Building, with Substation in the Rear.

the Boise & Interurban Railway Company. The power house building, which is illustrated herewith, is of reinforced concrete construction throughout, including roofs, floors, walls and generator foundations. The spillway of the dam in the

converter, operating at 720 revolutions per minute; three 100-kilowatt oil-insulated, self-cooling transformers, with primary coils wound for 22,000 and 44,000 volts and secondary coils wound for 367 volts; one 50-ampere 44,000-volt oil switch and



Boise & Interurban Railway—Express Motor Car Hauling Train of Seven Freight Cars.

Snake river is 450 feet wide and a head of 19 feet is obtained.

The plant has an electrical generating capacity of 2,300 kilowatts. The original plant of the mining company contained four 72-inch vertical water turbines belted to three 300-kilowatt Westinghouse generators. Last year the capacity of the plant was increased in order to furnish power for the railway by the installation of two additional 700-kilowatt generators, each direct-connected to two 66-inch vertical water turbines. The equipment of the plant includes a 10-ton travel-

ing crane, three 44,000-volt oil-insulated choke coils, three sets of lightning arresters, and one 4-panel switchboard, all furnished by the Westinghouse Electric & Manufacturing Company.

**Rolling Stock.**

The rolling stock equipment consists of seven interurban cars built by the American Car Company of St. Louis and four city cars built by the St. Louis Car Company, besides a number of box and flat cars. Two of the interurban cars are of the

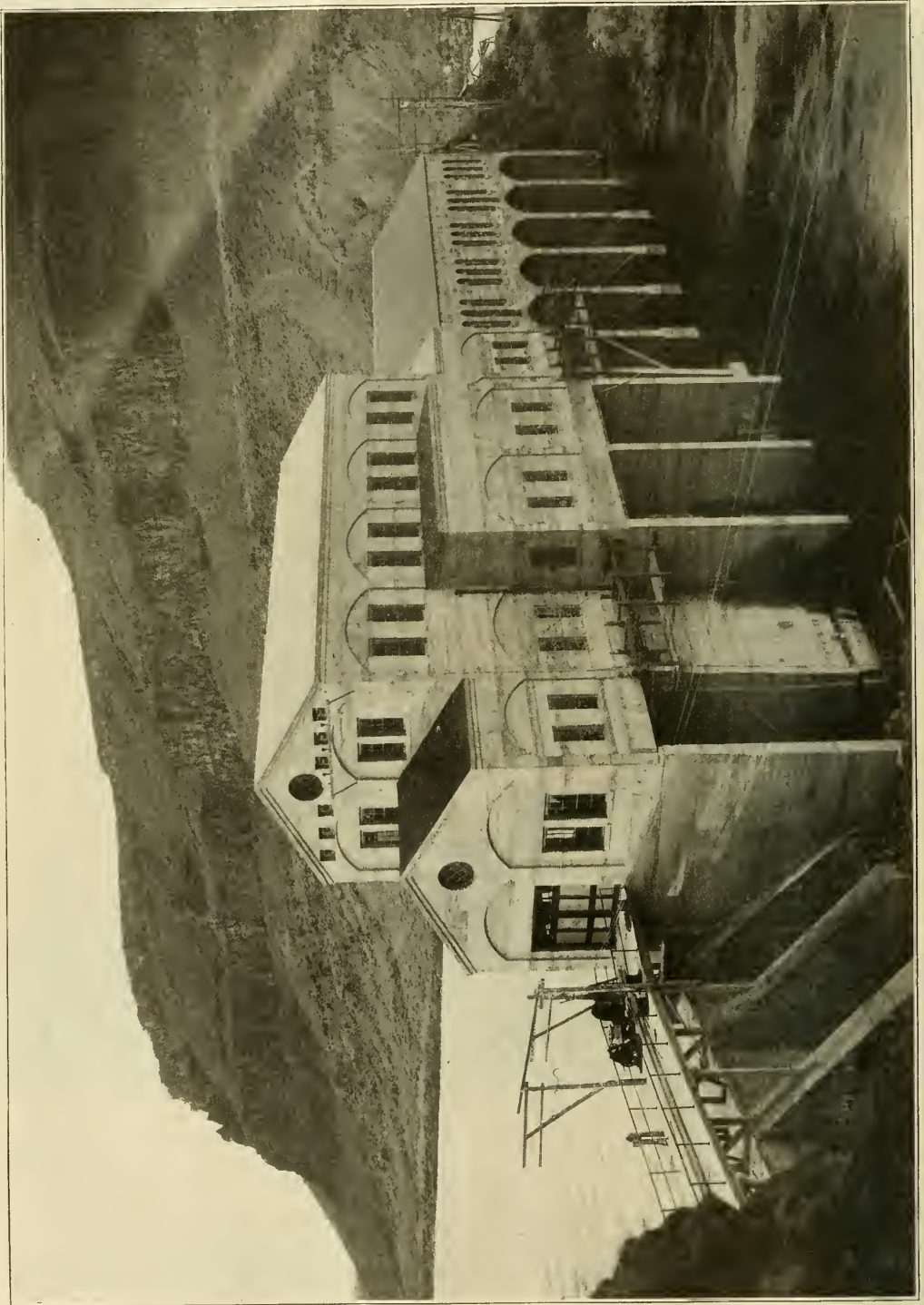

Boise & Interurban Railway—Hydro-Electric Power House on the Snake River at Swan Falls.

passenger and baggage type. Four are Brill semi-convertible passenger cars 32 feet long over corner posts and 43 feet 6 inches over bumpers and 8 feet 6 inches wide over sills, seating 44 passengers. They are equipped with Brill No. 27 E 1 double trucks with a 6-foot 6-inch wheel base, four 50-horsepower motors geared to a maximum speed of 46 miles per hour and type K 28 F controllers. There is also one express car of the same general dimensions as the passenger cars equipped with Brill No. 27-GI trucks with a 6-foot 6-inch wheel base and four 60-horsepower motors geared to 20 miles per hour. The express car has four windows on each side and sliding doors at the center and ends of the car.

The city cars are 28 feet over corner posts and 41 feet over bumpers, and are equipped with St. Louis Car Company's No. 47 double trucks and K 28 B controllers.

The car house and repair shop building is located on the main line  $4\frac{1}{2}$  miles from Boise. It is 55 by 150 feet in size

rates have been placed at such a figure that no farmer or country merchant along the road can afford to drive to town for supplies. This policy has resulted in giving the road all the traffic to be had and it has handled many cars of sugar beets, fruit and farm produce, with fuel and merchandise for return traffic. Since the road began operating the population in the territory served has been greatly increased, large tracts of land have been subdivided into 5 and 10 acre farms, new residences are being built and a new activity is evident.

On the interurban line a 75-minute schedule is maintained with trains every 75 minutes from each terminal. The running time will soon be reduced to one hour or less. The rate of fare is about 2.6 cents per mile for 1-way tickets and 2.1 cents per mile for round-trip tickets. Mileage books and trip commutation books are also issued.

Pierce park,  $4\frac{1}{2}$  miles from Boise, 182 acres in extent, is now being provided with the attractions of a first-class

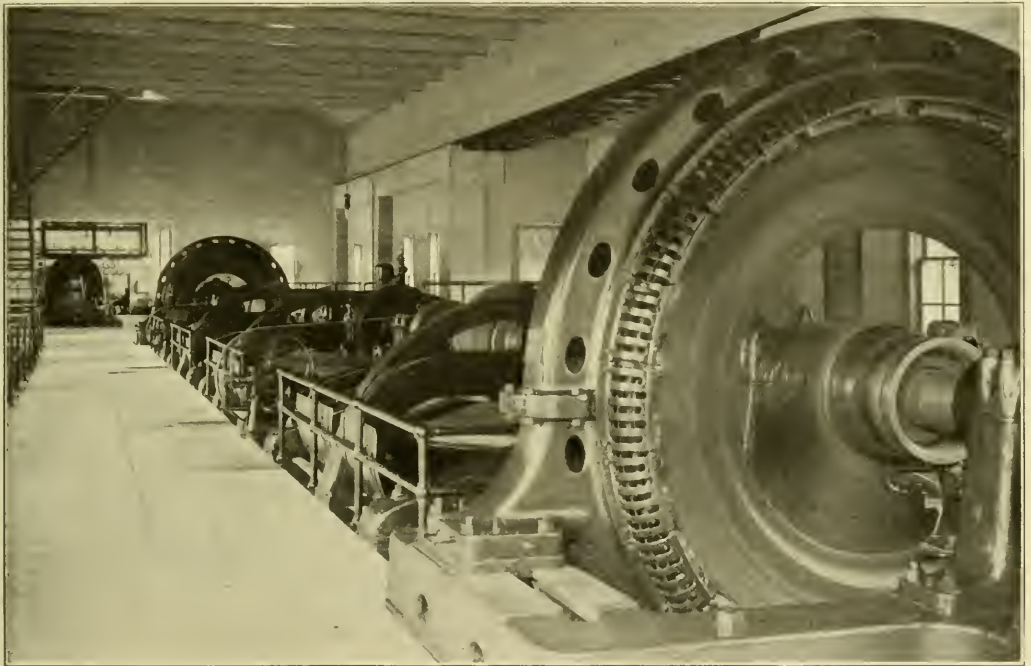

Boise & Interurban Railway—View of Interior of Power House, Showing Two 700-Kilowatt Generators Geared to Hydraulic Turbines.

and has a capacity of 12 cars. This building, which is illustrated, is of white brick, like the substations, with a concrete roof carried on steel trusses, and a concrete floor. Each track has a concrete repair pit and convenient repair facilities.

#### Traffic.

The road has terminal connections at Boise and at Caldwell with the Oregon Short Line Railroad, with which it has a traffic interchange agreement. It also has a traffic agreement and a track connection at Middletown with the Idaho Northern Railroad. These steam road connections and the policy of the company to develop all the business possible in its territory have led to a large and profitable freight traffic. Until the advent of this line the country traversed was isolated, and, although rich in soil and in natural resources, its productiveness has been somewhat handicapped by the lack of a proper outlet, consequently, in order to develop business

amusement park, including a lagoon with electric launches and rowboats, baseball, recreation, and picnic grounds and grounds for private gatherings, including a Chantauqua society.

The road has already outgrown the office quarters provided for it in the beginning and it is proposed to build this year a substantial and commodious office building on a choice corner, 100 by 122 feet, that has been purchased in the heart of Boise, which will serve the combined purposes of office rooms for the officers of the company, ticket offices and waiting rooms, and express and freight offices. The company has also purchased a choice corner in the center of Caldwell, upon which to erect a building adequate to its needs in that town.

An extension to Nampa is proposed and several other extensions are contemplated, to be made as soon as conditions warrant.

The officers of the company are: President, W. E. Pierce,

Boise, Idaho; vice-president, Julian Kennedy, Pittsburg, Pa.; secretary, T. B. McKaig, Pittsburg, Pa.; treasurer, A. C. Thompson, Pittsburg, Pa.; general manager, H. E. Dalton, Boise, Idaho.

The preliminary work was carried out by W. E. Pierce, president, assisted by F. P. King and C. J. Franklin, engineers, of Boise. F. H. Knox of Pittsburg was chief engineer in charge of construction. The Colonial Trust Company of Pittsburg was fiscal agent. The company has a capital stock of \$5,000,000.

#### NEW YORK CITY RAILWAY RECEIVERS WANT \$3,500,000 FOR IMPROVEMENTS.

The receivers for the New York City Railway filed in the United States circuit court, New York, on March 7, a petition for authority to issue \$3,500,000 of receivers' certificates. Exclusive of the amount required to rebuild the car house at Ninety-sixth and Ninety-seventh streets, which was destroyed by fire on February 29, and to substitute new cars for those destroyed in the fire—this amount being estimated at \$1,000,000 at least—the receivers state that they need the following sums:

For reconstruction of rolling stock.....	\$ 900,000
Rehabilitation of tracks, paving, etc.....	400,000
Payment for transformation of First avenue line between Fifty-ninth street and One Hundred and Twenty-fifth street from horse road to underground trolley .....	277,305
Completion of car house and repair shops at One Hundred and Forty-sixth street and Lenox avenue, in excess of insurance from fire of April, 1907 .....	174,463
New cars to replace those of the Central Crosstown line destroyed by fire and in excess of insurance due .....	330,440
Installation of sprinkler systems, to insure sufficient and adequate insurance of property.....	507,279
<b>Total .....</b>	<b>\$2,589,487</b>

The receivers have also filed a complaint in a suit against the Metropolitan Securities Company to recover \$1,964,000, alleged to be the balance due of \$8,000,000 to which the receivers say the New York City Railway was entitled by a contract with the Securities company. An agreement was entered into on May 22, 1907, by which the New York City Railway was to lend to the Metropolitan Street Railway \$8,000,000 for various expenditures made necessary by changes in motive power, etc. This sum was to be furnished on reasonable notice at any time before January 1, 1909. By the agreement the Metropolitan Street Railway was to issue \$8,000,000 of 3-year 5 per cent improvement notes, secured by notes of its subsidiary companies, and to turn these over to the Metropolitan Securities Company, and the Securities company was to furnish the New York City Railway such sums as it might need to carry out the contract. The complaint says that \$3,036,000 was furnished and suit is now started for the balance, with interest from September 24, 1907, and costs.

The petition for authority to issue receivers' certificates states that the failure of the Metropolitan Securities Company to pay the money under this contract partly makes necessary the petition. The receivers point out that if they win that suit they will be able to retire some of the certificates.

The property of the railway was examined by a representative of the public service commission. The commission ordered many cars reconstructed and other improvements made. The petition states on this subject:

Incidentally it may be suggested that if for the last few years the New York City Railway had made the expenditures necessary to keep the rolling stock (also the track and sub-surface hereinafter referred to) in first-class condition it probably would not have been able to pay to the Metropolitan Street Railway its stipulated rental, which was distributed among its stockholders. The total amount required to transform the rolling stock from what it was when we received it in September to what it will be when reconstructed in full compliance with the requirements of the public service commis-

sion of the beginning of next summer is upon a very conservative estimate \$900,000.

In addition to the extra expenditures required all over the city in order to bring the track surface structure up to a proper operating condition certain portions of the tracks and subsurface of the system must be entirely rehabilitated prior to June 30, 1908.

The maintenance of the pavement, which by statute is obligatory upon the company, not only within and between the tracks, but for a distance of two feet from the outer rail of the track, becomes difficult when the track is not in proper condition. At the present time the city is largely paved with some form of asphalt, and this pavement is peculiarly susceptible to injury through the vibration of loose rails and the pounding of defective joints. As soon as the pavement begins to break, due to such movements in the track structure, the heavy traffic to which it is subjected on the main thoroughfares on Manhattan island aggravates the condition and produces a very rapid disintegration of the wearing surface, so that it is but a very short time before serious holes in the pavement are made, necessitating a particularly heavy expense for maintenance.

The cost of completing the burned One Hundred and Forty-sixth Street shops will be \$665,000. Money received or still due from insurance companies is \$490,537, leaving a loss of \$174,463.

The cost of 155 cars of the pay-as-you-enter type and other cars will be \$1,200,087. The insurance money received and to be received for loss of cars which are thus to be replaced is \$870,447. The receivers state that the insurance companies declare sprinkler apparatus must be installed in the car houses on account of the numerous fires in the last two years. The receivers say that \$11,000,000 worth of property is exposed in the car houses to loss by fire. They add: "This fire hazard jeopardizes the most essential parts of our service. Should another conflagration occur the very heart and vitals of the system are likely to be affected, with the result of most disastrous inroads upon our revenue. To provide against and minimize this present and ever-threatening peril the expenditure of considerable sums is absolutely essential." The receivers say:

It is manifest that so large a sum as that stated above cannot be obtained from current net earnings. Over and above operating expenses we have had to pay since our appointment for taxes and similar obligations to state and city more than \$800,000. Our fixed charges to July 1, aggregate \$1,354,625. In our judgment it is advisable that all of these fixed charges should be paid as they accrue. So far as we can now determine it is inadvisable to default on any of them, because the revenue derived from the operation of the various lines seems sufficient to meet such charges. In other words, the lines are full self-supporting and it seems advisable under these circumstances from our standpoint to keep the present operating system intact.

The estimated excess of gross receipts over operating expenses to July 1, 1908, is \$1,552,274 with operating expenses on their present basis, but it will be less if the public service commission requires, as it did, the petition says, in the case of the Eighth avenue line service in excess of the demands of traffic. The receivers say:

The ratio of receipts for the last seven weeks, compared with that of the corresponding period of last year, begins to show a noticeable improvement when contrasted with the ratio of the last quarter of 1907 and the corresponding period of 1906. This is due in a considerable degree to the increased efficiency of the service following as a direct result of the rehabilitating processes under way. Then, too, the more thorough and complete repairing of electric cars is resulting in our being able to keep more cars in service and fewer in the shops undergoing repairs, with a resulting increase in earning capacity.

It is suggested that the receivers' certificates could be made a lien on the property of the Metropolitan Street Railway superior to the lien of the Metropolitan Street Railway refunding mortgage, which secures \$16,604,000 bonds due on April 1, 2002, and bearing interest at 4 per cent, and also to the lien of the Metropolitan Street Railway, general and collateral trust mortgage, which secures \$12,500,000 bonds, due February 1, 1997, and bearing interest at 5 per cent. A hearing on the motion to issue these certificates will be given on March 19.

**ENGINEERING ASSOCIATION COMMITTEES.**

President F. G. Simmons of the American Street and Interurban Railway Engineering Association has announced the following standing committees to supplement those earlier appointed as announced in the Electric Railway Review on December 28, 1907, page 976:

**What is Economical Maintenance?**

- F. H. Lincoln, chairman, assistant general manager Philadelphia Rapid Transit Company, Philadelphia, Pa.
- W. H. Collins, general superintendent Fonda Johnstown & Gloversville Railroad (electric division), Gloversville, N. Y.
- John Lindall, superintendent motive power and machinery Boston Elevated Railway, Boston, Mass.
- Fred Heckler, superintendent motive power and cars Lake Shore Electric Railway, Fremont, O.
- W. H. McAloney, superintendent rolling stock Denver City Tramway, Denver, Colo.
- T. Scullin, master mechanic Cleveland Electric Railway, Cleveland, O.
- Sylvester Potter, master mechanic Detroit United Railway, Detroit, Mich.

**Power Generation.**

- William H. Roberts, chairman, superintendent motive power Northern Ohio Traction & Light Company, Akron, O.
- G. H. Kelsay, superintendent power Indiana Union Traction Company, Anderson, Ind.
- C. F. Bancroft, superintendent motive power and machinery Boston & Northern Street Railway, Boston, Mass.
- G. O. Harvey, electrical engineer International Railway, Buffalo, N. Y.
- George B. Dusenberre, consulting engineer, Cleveland, O.
- R. A. Dyer, Jr., assistant general manager Rochester Syracuse & Eastern Railroad, Newark, N. Y.

**Power Distribution.**

- W. J. Harvie, chairman, chief engineer Utica & Mohawk Valley Railway, Utica, N. Y.
- G. D. Nicoll, electrical and mechanical engineer Indianapolis & Cincinnati Traction Company, Rushville, Ind.
- W. H. Matthews, superintendent lines Denver City Tramway, Denver, Colo.
- James Heywood, superintendent lines and cables Philadelphia Rapid Transit Company, Philadelphia, Pa.
- James P. Boyden, superintendent wires Boston Elevated Railway, Boston, Mass.

**Operating and Storage Car House Designs.**

- F. F. Low, chairman, architect Boston Elevated Railway, Boston, Mass.
- E. F. Rogers, chief engineer Boston & Worcester Street Railway, Boston, Mass.
- M. H. Brondson, electrical and chief engineer Rhode Island Company, Providence, R. I.

The latest list of committees includes F. P. Maize, chief electrician and master mechanic Rochester Railway Company, in place of W. D. Wright as a member of the committee on maintenance and inspection of electrical equipment.

**CENTRAL ELECTRIC RAILWAY ASSOCIATION MEETING.**

President F. D. Carpenter announces that the next regular meeting of the Central Electric Railway Association will be held at the Claypool hotel, Indianapolis, Ind., on Thursday, March 26, 1908. After the business meeting, which will convene at 10:30 a. m., the following programme will be presented:

- "Standardization of Trolley Wheel, Harp and Pole." by Adam Cole of the Vaile & Kimes Company, Dayton, O.
- "Twelve Hundred-Volt Direct-Current System of the Indianapolis & Louisville Traction Company." by H. D. Murdock, master mechanic and electrical engineer, Seymour, Ind.
- "Electric Motor and Traller Trucks," by A. C. Vauclean, Baldwin Locomotive Works, Philadelphia, Pa.

This being the first regular meeting of the year it is earnestly requested that as many as possible will be in attendance. The Central Electric Traffic committee will make its report at this meeting and it is desirous that some definite action be taken relative to a permanent organization.

Through the courtesy of A. A. Anderson, general manager of the Indianapolis & Louisville Traction Company, all

members are invited to make a trip over the 1,200-volt traction line. A special car will leave Indianapolis immediately after the adjournment of the meeting, remaining over night at some convenient point and resuming the journey on the following morning. It is hoped that a large number of the members will avail themselves of this opportunity.

**THROUGH ROUTE IN CHICAGO.**

The ordinances under which the Chicago City Railway and the Chicago Railways Company are operating provide that these companies shall establish 21 through routes between the different sections of the city. Under the direction of the board of supervising engineers, Chicago traction, the operation of the first through route will be started at 4 a. m. on March 17. A resolution passed by this board states that, inasmuch as the operation at the present time of through routes Nos. 2 and 3, as described in the ordinances, is impracticable, owing to existing obstructions, the companies are authorized to take the initiative in the establishment of a temporary through route to be known as Route No. 22, consisting of a combination of routes Nos. 2 and 3, as follows:

Beginning at Halsted street and Seventy-ninth street; east on Seventy-ninth to Vincennes avenue; north on Vincennes to Wentworth avenue; north on Wentworth to Twenty-second street; east on twenty-second to Clark street; north on Clark to Howard avenue; returning by the same route, except that the southbound cars will run east on Archer avenue, from Clark to Wentworth, and thence south on Wentworth.

The length of this route is 20 miles, divided about equally between the lines of the Chicago City Railway and the Chi-

SOUTH BOUND	Route 9	Route 8	Route 7	Route 6	Route 5	Route 4	Route 3	Route 2	Route 1	Emergency	SPECIAL	RECEIVABLE ONLY at crossing points in a diverging section of cross line—this card is not to be used if transferred. Avoid 15 minutes after time punched or if transferred. Not Good in "South Division" South of 12th Street. CHICAGO CITY RAILWAY COMPANY. HOLLYWOOD CO. OF NORTH CAROLINA. UNITED STATES RAILROADS.	NORTH-SOUTH BOUND	WEST	EAST	NORTH SOUTH EAST WEST	FOUR TRANSFERS TO NORTH SOUTH EAST WEST	
	Route 9	Route 8	Route 7	Route 6	Route 5	Route 4	Route 3	Route 2	Route 1									
AM	6	7	8	9	10	11	12	1	2	3	4							
PM	5	6	7	8	9	10	11	12	1	2	3	4	5	6				
Min	0	10	20	30	40	50												

Through Route in Chicago—Form of Transfer.

cago Railways Company. The time required to make the run from one terminus to the other is two hours, or four hours for the round trip. Each company is to retain the fares collected on its own cars regardless of the territory in which the fares are collected. Under the general arrangement each road is to furnish, as nearly as possible, a proportionate number of cars commensurate with its mileage in, the through routes. The number of cars in use on this route will be divided evenly between the two companies, as the mileage is about equal. There has been some discussion concerning the headway, which has been finally determined at eight minutes, requiring the use of 16 cars by each company. Each company is to use its own trip sheets and to be responsible for all accidents occurring on or in connection with its own cars, regardless of the territory in which they may take place.

The number of the through route is to be carried on the front and rear dash of each car in figures from 10 to 12 inches high. A new form of transfer will be introduced for use on the through routes, and 35,000 of these transfers will be ordered daily at the beginning. This transfer will be accepted on any cross or diverging line except in the central business district, and as a precaution the transfer will be punched in the general direction in which the passenger is bound so as to avoid a reverse trip farther than the next junction point. Separate colors, manila and salmon, will be used respectively for the southbound and northbound cars.

On account of physical obstructions it will not be possible to use the latest type of Chicago City Railway car on this route.

SIGHT-SEEING AND FUNERAL CAR SERVICE IN MEXICO.

BY T. J. NICHOLL.

One of the most popular branches of electric railway service in Mexico City is the "Seeing Mexico" cars. They are painted white and gold on the outside, fitted with beautiful rattan chairs, carpets, silk curtains and cushions on the inside; in fact, everything necessary to make them as comfortable and as luxuriant as any private electric cars in America. These cars leave the Grand Plaza at 9:30 a. m. and 3 p. m. daily, each car in charge of an experienced English and Spanish speaking guide.

Each of the trips requires about 3 1/2 hours. The fare is \$2.00 in Mexican money. Two cars are generally required to accommodate the people on each trip. The cars seat from 30 to 50 people (usually all seats are occupied), with a few standing or sitting on camp stools. So it will be seen that the company carries say an average of 45 people on each car, or 180 per day, at \$2.00 each, totaling \$360 per day. The service is really very cheap, well worth the money and doubtless will be much extended very soon, as it is fast becoming very popular.

An attractive little pamphlet is also used by the company in describing the trips.

Funeral Service.

The story of the splendid street car service given the city of Mexico would hardly be complete without giving a short

cars called "Carrozas" for extraordinarily fine funerals. These cars cost upward of \$10,000 each and have a place in front for the casket, with seats behind for the people. Women never attend funerals in this country. They also have 20 electric and 8 horse "Carrozas," which are used for first and second class funerals, according as may be required, and are decorated to suit for extra expense. The original cost of such a car is, \$3.75 silver, trailers being paid for at the same rate, whether for flowers or people.

This service saves the people many thousands of dollars annually and at the same time is worth while to the railway company.

The free car for funerals when people are unknown or die absolutely destitute is quite another thing; instead of being entirely open it is entirely closed, with doors on one side opening from top to bottom. There are four doors, with three compartments to each (like pigeonholes), there being 12 places in each car. In each one of these places a body is placed, either in a common board coffin or sewed up in a blanket. The latter cars are furnished at the exact cost of running, twice per day. The service is paid for by the government.

GATEMEN ON THE MICHIGAN UNITED RAILWAYS.

On one interurban division of the Michigan United Railways of Jackson, Mich., the plan was established tentatively on November 21 of having gatemen at the terminals at Battle Creek and Kalamazoo direct passengers to purchase tickets before entering cars. The results attained by this change have been explained to the Electric Railway Review by F. W. Brown, general freight and passenger agent. The plan at present is applied only to limited cars. The cars have gates on the platforms. Before cars leave the Battle Creek or Kalamazoo terminals uniformed employes place stools before the steps and stand beside them to inspect the tickets. The employes who call the trains and request passengers to purchase their tickets are regular employes, and it requires about 10 minutes of their time to attend to this duty for each departing train. There has therefore been no additional expense for the company in the hiring of employes for this service.

Gatemen and conductors are instructed to use their best judgment and not to insist upon the purchase of tickets by any who would be seriously inconvenienced if they were prevented from boarding the car without delay. Before it was decided to try the experiment posters, reading as follows, were placed in conspicuous places: "Passengers will assist the company in providing service of the highest efficiency by purchasing tickets before boarding the train."

In speaking of the plan, Mr. Brown said: "We found that it was very difficult for conductors to attend to the collection of tickets as well as perform their other duties satisfactorily. Between flagging for the crossings, watching the block signals and attending to the trolley when the third rail was reached, the conductors could not work the car properly for fares. If the plan is satisfactory in its operation on limited cars, we will eventually introduce it on the local cars, but if we do that of course additional employes will be required to act as gatemen. The plan leaves the conductors more time to attend to the operation of the cars, and makes it certain that the company will receive fares for all passengers."

The Ft. Wayne & Wabash Valley Traction Company has recently adopted the Singer uniform for its conductors and motormen on both city and interurban lines. According to the new merit system of discipline recently established the employes will be inspected from time to time and awarded merits or demerits for appearance.



Ticket for Sight-Seeing Service in Mexico.

description of the funeral service. There is a special department for this service, which is very much used, and which earns, I am told, about \$400 per day. For this service the old horse cars are used to a good advantage. The company controls the funeral service of the city, whether it be by electric car, horse car or carriage, and it is prepared to furnish any kind of service upon short notice given at their office.

With few exceptions the funerals from the city to the cemeteries are conducted by the street railway company, either first-class, second-class or free, the cost varying with the amount of decoration used on the cars. It is not an uncommon sight to see five or six funerals leaving the public square, following one another on the street railway tracks, each with from one to three cars. Some have great quantities of beautiful flowers and ornamentation and others have none.

The funeral car is generally a motor car, but sometimes it is pulled by mules. It is painted and trimmed in black or white. All are single-truck cars, with four square posts supporting the roof at the corners of the car body, forming a parallelogram, say 12 feet long by the usual width of the car. Between the posts on the floor of the car is a raised portion upon which the casket and many of the flowers are placed. The friends of the dead are carried in one, two or three trailers or horse cars. I have seen as many as two trailers filled with floral decorations.

There are also two magnificently furnished and fitted



**THE NEW BUSINESS DEPARTMENT OF A RAILWAY.**

BY C. EDGAR TITZEL, MANAGER CONESTOGA TRACTION COMPANY.

A "New Business" department of a street railway company is just as important as a "New Business" department of an electric light or gas company. Many managers of street railway companies have been very slow to realize this fact. The up-to-date trolley line of today is the one that advertises and solicits business, thereby promoting travel which would otherwise be lost to the road.

The system which the writer represents has maintained a "New Business" department for a number of years to good



Conestoga Traction Company—Illuminated Sign on Top of Waiting Room in Centre Square, Lancaster, Pa.

advantage. We solicit both by personal interviews and by sending out letters and circulars. Four or five times a year we send a circular letter to all the lodges in the county, calling their attention to our service, and inclosing a card giving special car rates and other information of interest to them. In season we send personal letters to the managers of baseball, football and basket ball teams. In the spring we send a letter, together with advertising matter, to all the public school teachers, calling attention to the various pleasure resorts along our lines. Just before the picnic season we send a letter and circular to all Sunday school superintendents, Sunday school teachers, ministers, lodges and factories whose employes are in the habit of holding picnics.

We advertise our express business by sending to the merchants several times a year circular letters and schedules of rates. Keeping up these lists is a very small matter, as it takes very little time after the lists are once compiled.

When county fairs, circuses or other big attractions are held at points which can be reached from our lines, we post big show bills at places where they will attract the most attention. We advertise in the newspapers and by circulars any other event along our lines which will attract travel.

In addition to this system of advertising we have a man who makes a personal canvass. Someone may say that this is a very expensive department to maintain. This is not so; the expense is very small, considering the results obtained.

Of course, economy and judgment must be used in the management of this department, just as in all other departments of the business.

**REPAIR WORK PROGRESS RECORD.**

With the object in view of having available from day to day a record of the repair work done on the cars of its various classes of rolling stock, there is used at the shops of the United Railways & Electric Company, Baltimore, a record similar to that shown in the accompanying engraving.

The cars of this company are numbered according to lines and each line, it will be noted, is given a separate column on the record sheet. Under each line is stated the number of cars apportioned to that line. The column for each line is subruled into three smaller columns marked "O," "C" and "P." These letters have the following indications: O, overhauling shop; C, carpenter and also motor and truck shop; P, paint shop. Each line across the page represents one day's work in the shops, so that when the office of superintendent of shops receives the record of the work completed during the day before, the various entries may be made.

Considering, for example, the last entries on the sheet as reproduced, that for February 8, we find that of Class 100 twelve cars had been through the paint shop up to that date. Referring to the record for the day before it is seen that on that day eleven cars had been through the paint shop, and therefore one car of Class 100 was completed on the eighth. Similarly, it is noted that of Class 1200 ten cars had been through the carpenter shop and five through the paint shop, and so on across the columns. When inspecting this record it should be remembered that the bottom figures in any column represent the total amount of work done to date.

This method of recording work is found very satisfactory for keeping track of the open cars that are being sent through the shops and prepared for summer service. It is similarly used during the summer for keeping track of the closed cars being repaired for winter service. With the entries made on the record each day the superintendent of shops is posted as to the exact condition of the work, and should it be required he can instruct any particular shop to hasten the work on

LINE	100	400	500	600	900	1000	1100	1200	600	2000	2100	2200	2300	2600	2700	2800	Working Cars	TOTAL
1	1																	1
2																		
3																		
4																		
5																		
6																		
7																		
8																		
9																		
10																		
11																		
12																		
13																		
14																		
15																		
16																		
17																		
18																		
19																		
20																		
21																		
22																		
23																		
24																		
25																		
26																		
27																		
28																		
29																		
30																		
31																		
32																		
33																		
34																		
35																		
36																		
37																		
38																		
39																		
40																		
41																		
42																		
43																		
44																		
45																		
46																		
47																		
48																		
49																		
50																		
51																		
52																		
53																		
54																		
55																		
56																		
57																		
58																		
59																		
60																		
61																		
62																		
63																		
64																		
65																		
66																		
67																		
68																		
69																		
70																		
71																		
72																		

United Railways & Electric Company, Baltimore—Continuous Record of Overhauling Work Completed.

cars for the various lines, so that when the equipment is changed for the coming season there will always be enough cars on each line to fulfill the schedules.

Wood blocks laid alongside rails are said to be preferred on asphalt paved streets in Frankfurt, Germany, to any other system of connecting the street tracks and the paving. The blocks are laid over the whole space between the rails and for some distance outside the rails.

OPERATIONS OF ELECTRIC RAILWAYS IN ILLINOIS.

The annual report of the Illinois railroad and warehouse commission covering the operations of railroads for the year ended June 30, 1907, states that "the interurban electric railroads are taking a very important position in the state and are helping to solve in many ways the various transportation problems, especially those pertaining to local traffic." The electric railway part of the report covers only strictly interurban lines and elevated roads within the state of Illinois, street railways being exempted by statute from the jurisdiction of the commission. In this connection the report says: "So far as this commission is aware street railway companies make no report to any department of the state government. This commission has frequent inquiries as to the condition of street railway companies, and it might be well to suggest that these public utility companies enjoying special privileges from the state and municipal governments ought to be required to make a report to some department so that public information might be had of their condition."

An abstract of the report follows:

Mileage.

The total mileage, main line and branches of interurban and elevated electric railroads, for the year was 1,184.83, an increase for the year of 249.07 miles. The total mileage of second, third and fourth main tracks was 192.99, an increase of 2.29 miles. The mileage of industrial tracks was 7.80 miles, an increase of 3.67 miles, and the mileage of yard tracks and sidings was 71.30 miles, making a total of tracks of all kinds of 1,456.92 miles, an increase for the year of 269.49 miles.

Capitalization.

The capital stock and funded debt of this class of roads for the year was \$177,443,007, an increase for the year of \$16,855,779, which is accounted for in the additional mileage built and put in operation. The average capitalization (capital stock and funded debt) per mile of road of interurban and elevated electric railroads for the year was \$150,790. The average capitalization (capital stock and funded debt) per mile of surface roads was \$73,053, and per mile of road for the elevated railroads was \$1,967,780.

The total dividends paid were \$1,134,365, an increase of \$391,396. The total assets were \$195,474,221, an increase of \$21,749,623. The total liabilities were \$190,978, an increase of \$21,251,727. The net surplus of assets over liabilities was \$4,496,180.

Income Account.

The gross earnings from operation were \$12,956,210, an increase of \$1,676,018. Operating expenses were \$7,747,332, an increase of \$1,174,071. The income from operation was \$6,208,878, an increase of \$501,947. The income from property and other sources was \$892,866, an increase of \$210,021. The total income was \$7,101,744, an increase of \$711,968. The expenses assignable to fixed charges were \$4,986,165, leaving a net income of \$2,381,798, an increase of \$385,299.

Passenger and Freight Traffic.

The total income from passenger service, including mail, express, advertising, etc., was \$12,371,696, an increase of \$1,354,776. The total income from freight service was \$594,371, an increase of \$148,051. The total earnings and income from all sources was \$14,394,557, an increase of \$1,589,137. A comparative summary of traffic statistics is as follows:

Passenger traffic—	1907.	1906.
Revenue passengers carried.....	197,781,911	183,650,979
Passenger and mixed car mileage....	55,863,475	51,849,607
Passenger earnings per car-mile.....	\$ 0.212	
Average amount received from each passenger.....	\$ 0.065	0.059
Passenger earnings per mile of road....	10,550	11,771
Transfer passengers carried.....	7,638,759	6,397,108
Freight traffic—		
Tons of revenue freight carried.....	1,452,118	1,277,566
Freight and mixed car mileage.....	470,056	689,950
Average receipts per ton per mile.....	\$ 0.048	
Freight earnings per car-mile.....		0.656
Average amount received from each ton of freight.....	\$ 0.40	0.350
Freight earnings per mile of road....	820	751
Summary—		
Gross earnings from operation.....	\$ 13,956,210	\$ 12,122,661

Total car mileage.....	56,333,531	53,378,595
Total earnings per car-mile.....	\$ 0.232	
Gross earnings per mile of road....	11,552	12,820
Operating expenses per mile of road....	6,453	6,883
Net earnings per mile of road.....	5,094	5,937

Expenditures.

The total expenditures for maintenance of way and structures, maintenance of equipment, conducting transportation and general and unclassified expenses and fixed charges amounted to \$12,359,500, an increase of \$1,459,292. The expenditures are classified as follows:

	1907.	1906.
Maintenance—		
Way and structures.....	\$ 720,283	\$ 564,470
Equipment.....	1,001,739	921,832
Transportation—		
Operation of power plant.....	1,602,627	1,359,872
Operation of cars.....	2,731,678	2,377,785
General expenses.....	1,579,105	1,255,219
Unclassified expenses.....		29,752

Total operating expenses.....	\$ 7,635,432	\$ 6,508,930
Total fixed charges.....	4,724,068	4,391,278

Total oper. exp. and fixed charges. \$12,359,500 \$10,900,208

Employees.

The number of officers and employes was 6,697, a decrease of 29. There was paid in salaries \$1,479,742, an increase of \$513,980. The average rate of compensation per day for all employes, excluding officers, was \$2.15, an increase of \$0.12. The average rate of compensation per day, including officers, was \$2.19, an increase of \$0.07.

Miscellaneous Data.

During the year 6,860 tons of steel rails and 161,761 new ties were laid. There are 441 stations on these roads, an increase of 90. The number of highways crossed at grade is 2,475, an increase of 329. The number of under highway crossings is 449 and the number of overhead highway crossings is 13.

Accidents.

The number of passengers killed was 19, an increase of 12; the number of employes killed was 19, an increase of 9; other persons killed 38, an increase of 7; the total number of passengers injured was 149, an increase of 52; other persons injured 81, an increase of 16; total number of all classes killed 76, an increase of 28; total number of all classes injured 708, an increase of 240.

The commission has been gathering information as to the methods in use in the operation of the trains and cars of the interurban and elevated electric railroads and the extent and nature of safety appliances used for the protection of the public, and it may be necessary to establish some standard of operation.

Taxes.

The amount of taxes paid in 1907 was \$664,322.93, an increase over the preceding year of \$81,355.09, and an increase since 1897 of \$585,274.29.

SPRING FOR OIL CUP LID.

The accompanying sketches, Figures 1 and 2, will serve to show how one master mechanic has changed the springs

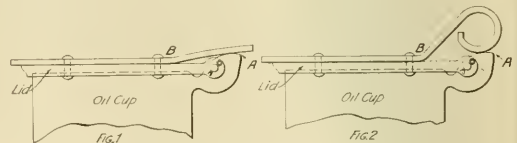

Oil Cup Lid—Showing Original Flat Spring and Improved Spring with Long Bend.

on his armature and axle bearing oil cup lids so that they will afford a longer useful life.

Figure 1 shows the lid and spring as furnished with the motor. After having been in use a short time this flat spring takes a permanent set at B. This renders it useless because it will not hold the lid down and keep out the dust and dirt.



a trifle "fast," as switching in puts a load upon it, slowing it down. Similarly an incoming converter should be running "slow," as the current flowing into the motor will normally produce motor action tending momentarily to increase speed. Attention to this difference will often prevent an oscillation of machines.

The use of the self-synchronizing method will not permit alternators improperly driven to operate successfully together. The stringent requirements of the synchronous machines for uniform driving torque has served to greatly improve the regulation of all prime movers, although the problem of engine governing is not yet fully solved. When it is realized that two engines driving alternators in parallel must not vary so much as one mechanical degree in position from uniform rotation, due to cyclic variation, and must change speed simultaneously and equally in case of a change of load, it is seen how difficult the problem is.

#### REFRIGERATOR CAR FOR THE FT. WAYNE & SPRINGFIELD RAILWAY.

The Ft. Wayne & Springfield Railway of Decatur, Ind., placed a refrigerator car in service on February 13. The car was built at the shops of the company at Decatur under the direction of T. W. Shelton, superintendent of the company, and is intended primarily to be used for the purpose of transporting meat from the plant of the Decatur Packing Company

and carlines. The roof is covered with  $\frac{3}{8}$ -inch poplar and 6-ounce cotton duck. Before the canvas was applied the roof was covered with two coats of lead and oil. The roof is of monitor type, with steam coach type of hood. The space between the deck rail and the roof is sealed and filled with sawdust. The floor consists of  $1\frac{1}{2}$ -inch oak laid crosswise and  $\frac{3}{4}$ -inch pine flooring laid lengthwise. The interior finish is yellow pine, tongued and grooved, placed lengthwise. The space between the sheathing is filled with sawdust. Suitable racks are provided, fitted with hooks for hanging meat. The ends of the car body are partitioned and have doors leading from the platforms to the interior of the car. There are 6-foot doors on the sides of the car at the center, heavy false doors which are to be used in warm weather, and a small door in each vestibule.

The Edwin C. Washburn M. C. B. type of drawbar with K draft rigging is used. The trucks are standard M. C. B. freight trucks, 5-foot wheel base and 25-foot truck centers. The brake rigging is automatic air and hand power and has compound levers. The wheels are 34 inches in diameter with 3-inch tread and  $\frac{3}{4}$ -inch flange. Various different styles of short coupling bars are carried on the car so that it will be possible to make couplings with the various drawbars in use on different roads over which the car will be operated. The



Refrigerator Car for the Ft. Wayne & Springfield Railway.

at Decatur to various towns and cities reached by interurban electric railways in northern Indiana and western Ohio.

The car will be operated over the Ft. Wayne & Springfield Railway from Decatur to Ft. Wayne. Connection is made at that point with the lines of the Ft. Wayne & Wabash Valley Traction Company, the Toledo & Chicago Interurban Railway, the Ohio Electric Railway, the Indiana Union Traction Company and the Marion Bluffton & Eastern Traction Company. Through these connections shipments can be made to Wabash, Peru, Logansport, Ft. Wayne, Huntington and Muncie. Other points will be included as business is extended. The car will be attached to the regular freight car which makes trips between Decatur and Ft. Wayne.

The bottom frame of the car is of oak of continuous pieces. The two outside sills are 4 by 12 inches and the intermediate sills are 4 by 8 inches, all sills being tied together with  $\frac{3}{4}$ -inch rods. All the filling blocks are mortised and tenoned into the intermediate and side sills. The posts are of oak, 3 by 3 inches in section, and are fastened to the top plates by means of angle irons bolted through the posts and plates, the bottom being fastened in a similar manner. The posts are 2 feet center to center. The roof framing, including carlines, is of oak. Steel carlines,  $\frac{3}{8}$  by  $1\frac{1}{2}$  inches, extend from one top plate to the other, being bent to the shape of the roof and placed 3 feet apart, securely bolted to the top plates

total length of the car is 40 feet and the width is 8 feet 4 inches. The car has a capacity of 50,000 pounds. As ice can be placed in the car during the summer months the company will use the car for transporting beer and other materials as well as for carrying the packing house products for which it was primarily built.

On the first trip on February 13 the car was loaded with 20,000 pounds of meat shipped from Decatur via Ft. Wayne to Huntington, Wabash, Peru and Logansport. The Ft. Wayne & Springfield Railway has a contract with the Decatur Packing Company for the transportation of all products that can be carried over its line and connecting electric lines.

The car is painted with Sherwin-Williams standard Pullman color. The Sherwin-Williams specifications for car painting were used, and English varnish, sold by the Pratt & Lambert Company of Chicago, was applied afterward.

#### Quarterly Meeting of New York Association.

Secretary J. H. Pardee announces that the quarterly meeting of the Street Railway Association of the State of New York will be held on March 18 at the Fort Orange Club, Albany, N. Y. At this meeting the association will discuss the tentative classification of operating expenses recently proposed by the interstate commerce commission.

## LONG-DISTANCE TRANSMISSION IN AFRICA.

On March 1 Ralph D. Mershon, consulting engineer, New York, spoke before the Pittsburg section of the American Institute of Electrical Engineers. He described the proposed transmission plans for South Africa. Mr. Mershon said that the Victoria Falls Power Company was formed for the purpose of transmitting power from Victoria Falls, on the Zambesi river, to Johannesburg and the Witwaters Rand, for use in the gold mines there. The distance of transmission will be between 600 and 700 miles. Mr. Mershon was retained to report upon the feasibility of such a transmission, his report being one of several, the other reports relative to the matter being made by European engineers.

The problem to be solved and the question to be answered were: Given the water power at Victoria Falls which could be developed hydraulically at a given cost, and given at Johannesburg a market for a certain amount of power at a certain price, could the power be profitably transmitted? Those of the European engineers who considered the project feasible thought it could be carried out only by means of the Thury direct-current system of transmission; but Mr. Mershon's report showed that the transmission could be accomplished with alternating current and that there would be considerable advantages in using alternating current. At the same time he advised the Victoria Falls Power Company that it would be better to first install steam stations on the Rand, and, through the medium of these stations, educate the mine owners to the use of electrical power and get control of developing the power market until the load was sufficient an amount to justify the transmission. Otherwise, if the transmission were built, the power company might be in the position of having to carry for a number of years a heavy investment while the load on the transmission system was being built up. The course outlined in regard to the steam stations is being followed.

Victoria Falls, the power-generating site, are in the Zambesi river, at a point where the river is about a mile wide. Their height is 400 feet, or  $2\frac{1}{2}$  times that of Niagara Falls. At the falls there is a hotel for tourists, and every endeavor is being made to encourage tourist travel to this point. The Rhodesian Railways at the present time extend about 400 miles north of the falls.

## Electric Traction in Lorraine.

Two thousand volt direct-current locomotives are used on a meter-gauge mine railway of about nine miles length in Maizières, Lorraine. The gradients of the railway are 2 and 3 per cent in parts, and ore trains of 250 to 300 tons are hauled over it. Hitherto the service has been performed by steam locomotives, but now electric traction has been installed. Direct-current motors were chosen because it was possible to get motors of larger capacity into the available width than with other systems. The locomotive has two 4-wheel trucks, and each of the four axles carries a motor, whereby a total hourly capacity of something over 600 horsepower is obtained. The motors are connected permanently two in series and are fed by overhead wire carrying 2,000 volts pressure, with rail return. The current collector is a side-contact sliding conductor of the Oerlikon type. The line is fed from a 600-kilowatt converter station at either end of the line. The locomotives have 49-inch drivers and weigh 60 tons each. The motors have commutating poles.—Engineering News.

A novel method of supplying steam to the electric power station of the Great Central Railway at Marylebone, England, was used while the boilers were undergoing thorough cleaning. The road operates both steam and electric equipment, and four locomotives of the latest type were placed close against the power house, fired up, and pipe connections arranged to carry steam to the engine room.—Railway and Engineering Review.

## RECENT ELECTRIC RAILWAY LEGAL DECISIONS.

BY J. L. ROSENBERGER LL. B., OF THE CHICAGO BAR.

## Proper Remedy for Enforcing Performance of Duties in Respect to Highways.

Borough of Pleasantville v. Atlantic City & Suburban Traction Company, 68 Atlantic Reporter, 60.—The supreme court of New Jersey holds that mandamus is a proper remedy for enforcing performance by a traction company of duties in respect to the public highways occupied by it pursuant to the terms of the municipal ordinances under which such occupation is enjoyed.

## Company Held to Provisions for Half Fare for School Children Regardless of Constitutionality of Law.

Interstate Consolidated Street Railway Company v. Commonwealth of Massachusetts, 28 Supreme Court Reporter, 26.—The supreme court of the United States says that this was a complaint against the street railway company for refusing to sell tickets for the transportation of pupils to and from the public schools at one-half the regular fare charged by it, as required by Section 72 of Chapter 112 of the revised laws of Massachusetts. At the trial the railway company admitted the fact, but set up that the statute was unconstitutional, in that it denied to the company the equal protection of the laws and deprived it of its property without just compensation and without due process of law.

In support of this defense the company made an offer of proof which may be abridged into the propositions that the regular fare was five cents; that during the last fiscal year the actual and reasonable cost of transportation per passenger was 3.86 cents, or, including taxes, 4.10 cents; that pupils of the public schools formed a considerable part of the passengers carried by it, and that the one street railway expressly exempted by the law transported nearly one-half the passengers transported on street railways and received nearly one-half the revenue received for such transportation in the commonwealth. The offer was stated to be made for the purpose of showing that this company could not comply with the statute without carrying passengers for less than a reasonable compensation and for less than cost. The offer of proof was rejected, and a ruling that the statute was repugnant to the fourteenth amendment to the constitution of the United States was refused. The company excepted, and, after a verdict of guilty and sentence, took the case to the supreme judicial court of Massachusetts, which overruled the exceptions.

The supreme court of the United States is of opinion that the decision below was right. A majority of the court considers that the case was disposed of by the fact that the statute in question was in force when the company took its charter, and confines itself to that ground. It says that by the act of incorporation the company was "subject to all the duties, liabilities and restrictions set forth in all general laws now or hereafter in force relating to street railway companies, except," etc. There is no doubt that, by the law as understood in Massachusetts, at least, the provisions of said Section 72, if they had been inserted in the charter in terms, would have bound the corporation, whether such requirements could be made constitutionally of an already existing corporation or not. The railroad company would have come into being and have consented to come into being subject to the liability, and could not be heard to complain.

If the charter, instead of writing out the requirements of Section 72, referred specifically to another document expressing them, and purported to incorporate it, of course the charter would have the same effect as if it itself contained the words. If the document was identified, it would not matter what its own nature or effect might be, as the force given to it by reference and incorporation would be derived wholly

from the charter. The document, therefore, might as well be an unconstitutional as a constitutional law. But the contents of a document may be incorporated or adopted as well by generic as by specific reference, if only the purport of the adopting statute is clear.

#### Reasonableness and Application of Ordinance Requiring Sufficient Cars to Give Seats and to Save Long Waiting.

North Jersey Street Railway Company v. Jersey City, 67 Atlantic Reporter, 1072.—The supreme court of New Jersey says that there was brought under review in this case an ordinance regulating the running of trolley cars in Jersey City from the terminals at the Pennsylvania and Erie stations during the evening "rush" hours. This required, under penalty, that all corporations running trolley cars in the city between the hours of 5:30 and 7 p. m., run from their terminals at the Pennsylvania and Erie stations a sufficient number of cars to provide with a seat every passenger from whom a fare was demanded, and that they should run a sufficient number of cars from said terminals during such hours that persons desiring transportation should not be kept waiting longer than five minutes.

It was contended that this ordinance was unreasonable because it was impossible to comply with it. But no attempt was made to show that the ordinance was impossible of observance at the Erie terminal or was otherwise unreasonable so far as that terminal was concerned. To this extent, therefore, the court without discussion finds the ordinance reasonable.

With regard to the Pennsylvania terminal it appeared that nine lines of cars used it, all incoming cars being confined for about two blocks to a single track, as also were the outgoing cars. The headway between cars on the different lines during the rush hours varied between 2 and 12 minutes, and a car of one or another of the various lines left the terminals at intervals approximating 40 seconds during the afternoon rush hours. The principal difficulty resulted from the large number of ferry boats that somewhat irregularly arrived at that point between 5:30 and 7 p. m., crowded with passengers, who, for the most part, desired to make their way homeward by the trolley cars.

Nevertheless the court is satisfied from the evidence that this company might with proper effort have dispatched from this terminal during the rush hours in question a considerably greater number of cars than it did. It says that, no doubt, under any schedule or system of running the cars, interruption might occasionally be caused by extraordinary blockades in the street or by other circumstances over which the traction company had no control. The ordinance, however, should be given a reasonable interpretation, and it was not to be supposed that the company would be held liable for the results that might occasionally be produced by causes beyond its control.

Upon the whole, the court cannot say that the requirements of the ordinance with respect to the dispatch of cars from the Pennsylvania terminal were either impossible of performance or so difficult of performance as to render the ordinance oppressive. The operation of the ordinance was therefore not wholly unreasonable. Exceptional circumstances that might render its performance impossible in particular instances might be availed of by way of defense, if action was brought for recovery of the penalty that the ordinance prescribes.

The ordinance not appearing to be at all unreasonable in its application to the Erie terminal, and not under all circumstances unreasonable in its application to the Pennsylvania terminal, it should be permitted to stand to the end that it may be enforced, except in particular cases where it may be made to appear that the circumstances render the operation of its provisions unreasonable or oppressive.

## News of the Week

### Consolidation Discussed in Chicago.

Talk of consolidation of the properties of the Chicago City Railway and the Chicago Railways Company has been started by Walter L. Fisher, special traction counsel for the city of Chicago. Mr. Fisher declared that with the present division of ownership the short haul traffic is lost by the companies and that many people in the business district would ride for short distances if they were able to take cars for more satisfactory distances than the present terminal plans of the two companies permit.

Discussion of the advisability of consolidation of the four elevated railroads of Chicago has been started again. It is generally recognized that this consolidation will be brought about eventually.

### Detroit 3-Cent Fare Ordinance Enjoined.

On March 3 the city council of Detroit, Mich., passed the so-called Holly ordinance, which requires the Detroit United Railways to establish a 3-cent fare on all lines for which the franchises have expired and to give universal transfers from those lines to other lines operated by the company. The ordinance was promptly signed by the mayor. On March 3 Judge Swan of the United States circuit court dissolved an injunction restraining the council from enacting the ordinance, on the ground that the court did not have authority to restrain legislation, but immediately after the passage of the ordinance he issued another temporary injunction restraining the city officials from enforcing it. The injunction was obtained on the petition of the Guaranty Trust Company of New York, representing the bondholders. A final hearing of the case will be held on March 16.

### Forestry and Hydro-Electrical Work.

At the eighth meeting of the Pittsfield, Mass., section of the American Institute of Electrical Engineers, held March 5, Mr. H. L. Smith presented an original paper on "Forestry and Hydro-Electric Development." Mr. Smith gave figures showing the enormous requirements for timber and the alarming rate at which our forests are being denuded. The effects of fire and the ruthless destruction of the young timber, due to the inconsiderate logging methods of rapacious lumbermen, were compared with the more considerate cutting done in the forest reservations under government supervision.

The beneficial effects of forest preservation, along the headwaters of the tributaries of the larger rivers, in the regulation of the stream flow, and in the prevention of disastrous freshets was described in detail. A brief outline was given of the work of the United States geological survey in the gauging of important streams. The fact that at the present rate of cutting, practically the entire hardwood supply will be exhausted in 16 years was brought out and an appeal made to give support to all worthy measures which would check the present ruthless destruction of our great timber tracts.

### Proposed Subway Between Philadelphia and Camden.

Announcement was made this week of the plans of the Delaware Subway Railway Company to build a twin-tube tunnel for electric cars under the Delaware river between Camden, N. J., and Philadelphia, Pa. The project has been delayed by extended litigation, but an important obstacle has been cleared away by a recent decision of the New Jersey Supreme Court. The Subway Company condemned a terminal site at Camden on property owned by the Philadelphia & Camden Ferry Company, a subsidiary of the Pennsylvania Railroad, adjacent to the ferry terminal. A commission, appointed by the court, assessed the damages at \$100,000. The ferry company, which has strenuously opposed the subway plans, contested the finding of the commission on the ground that amount was too low, and asked compensation for the prospective loss of business by competition. The court decided that this question could not be admitted. The ferry company has taken the case to the court of appeals.

The tunnel is to be financed by a syndicate, headed by Clarence and Edwin Wolf, bankers of Philadelphia. To procure the rights to build on the Jersey side a corporation called the Intercity Link Railway was formed. To obtain the Pennsylvania charter and the Philadelphia franchises, the Philadelphia & Camden Railway was organized and subsequently other rights were secured under the title of the Delaware Subway Railway. Of these concerns Clarence Wolf is president, Edwin Wolf treasurer and Morris Wolf secretary and legal representatives. Plans have been prepared by Stearns & Castor of Philadelphia. The approaches will amount to

about one-half mile and the length of the tubes under the river will be 2,700 feet. Property for the Philadelphia terminal has been acquired. The tunnel will form an important connection between the electric railway systems of Pennsylvania and New Jersey and will provide more comfortable transportation than is now possible by ferry. It is planned to begin construction as soon as the appeal of the ferry company is settled.

#### Trial of Suit to Annul Charter of New York City Railway.

Paul D. Cravath, attorney for the New York City Railway, will not introduce any evidence in defense of the charges of the attorney-general of New York that the company had been insolvent for one year prior to September 24, when the receivers were appointed. The trial before Justice Davis of the New York supreme court therefore came to an end on March 10. Mr. Cravath and H. K. Limburg, special counsel for the attorney-general, will submit briefs.

An effort has been made by Mr. Limburg to secure the introduction of the evidence of H. H. Vreeland before the grand jury. District Attorney Jerome, who had been subpoenaed, told the court that Mr. Vreeland's testimony related almost entirely to the Metropolitan Securities Company. Finally Justice Davis said he would look over the grand jury introduction to see if it is admissible. Mr. Cravath said: "Mr. Vreeland is not a stockholder in the New York City Railway, and, therefore, his testimony cannot be called on this question."

At the hearing on March 4 it was stated that the only franchise owned outright by the New York City Railway was the so-called "Halsey franchise," for two miles of track in the Bronx, purchased for \$15,000. H. R. Limburg, special attorney for the attorney-general, questioned H. W. Browne, auditor of the company, regarding the allowances for depreciation of equipment.

Mr. Browne maintained that a proper entry was always made for such depreciation and that if it appeared small the reason was that the stock purchased was of such good quality that no great allowance was necessary until after the third year of use.

Mr. Limburg asked the witness to explain the item of \$200,000 in the yearly report for "renewal of horses." Mr. Browne explained that the company figured the working life of a horse at four years, and that for the purposes of accounting three-fourths of the purchase value of the horses owned by the company was carried as an asset every year. Similarly, he said, any expenditure which covered a series of years was distributed over each year in equal proportion.

Of the \$9,255,475 "open accounts" in the balance sheet of June 30, 1906, it was shown that \$2,534,602 consisted of "advances to subsidiary companies." Of the latter amount \$1,405,000 met operating deficits. On June 30, 1907, \$1,875,956, advanced to meet operating deficits, was still due by subsidiary companies.

During the proceedings on March 9, Mr. Limburg argued that approximately \$7,000,000 of special franchise taxes unpaid and contested by the company in court, should have been considered a contingent liability on June 30, 1906. Mr. Limburg said that the Metropolitan Street Railway borrowed in 1904 the sum of \$793,423 to pay its franchise taxes up to and including 1900. He stated that this loan showed that the suits brought by the New York City Railway for the purpose of contesting the constitutionality of the special franchise tax law were not entered into in good faith. The attorneys for the company argued that assessments under this law could not be considered even a contingent liability, because the company was contesting them in good faith.

Mr. Limburg asked for the contracts relating to the purchase of control of the Twenty-eighth and Twenty-ninth streets Crosstown Railroad by the Metropolitan Street Railway. It had been shown in previous proceedings that these lines were purchased at receiver's sale for \$25,000 in 1896, recapitalized with \$1,500,000 stock and \$1,500,000 bonds through the Metropolitan Traction Company, and then sold to the Metropolitan Street Railway, which issued its stock to the Metropolitan Traction Company for the stock of the two lines, guaranteeing principal and interest of the bonds. The two lines have failed to earn the interest on their bonded debt and were indebted to the Metropolitan Street Railway on this account \$54,819 up to June 30, 1906. Mr. Limburg contended that under the lease of 1902, the New York City Railway was made liable for both the principal and interest of the bonds, and that as the road had not earned the interest itself, the principal was a contingent liability of the New York City Railway.

The securities carried as an asset valued at \$8,658,527 in the balance sheet of the New York City Railway as of June 30, 1906, were attacked by Mr. Limburg, who charged that with the exception of two small blocks of 87 and 168 shares,

respectively, and the \$500,000 Fulton Street and \$1,500,000 Twenty-eighth and Twenty-ninth Street stocks all were hypothecated as collateral for all loans.

A statement was placed in evidence by Mr. Limburg showing that of the \$23,000,000 raised by the sale of the Metropolitan Securities Company stock, the New York City Railway received only \$20,259,000. It was also shown that an entry in the balance sheet as of June 30, 1906, entitled "reserve for net deficits," represented the deficits of the subsidiaries of the Third Avenue Railroad, amounting to \$2,256,330 less \$751,279, the surplus of the Union Railway. These deficits had been made by advances of the New York City Railway and were carried by that company.

#### Transportation Affairs in New York.

On March 6 the New York public service commission of the first district held a public hearing in regard to the traffic on the Brooklyn bridge since January 27, when the extension to the Manhattan terminal was put into service and the plan of operating the Brooklyn Rapid Transit Company elevated trains through to Manhattan was established and the old bridge shuttle service was abandoned. These improvements were described in the Electric Railway Review of February 1, page 154. H. B. Seaman, chief engineer of the commission, has submitted a report criticizing the new plan of operation. Arthur W. Dutton, superintendent of transportation of the Brooklyn Rapid Transit Company, testified that since the new plan was established the company has been operating \$20 6-car elevated trains per day across the bridge, as compared with 708 before January 27. The maximum number of 6-car trains that can now be run across the bridge is 61 per hour and it is hoped that this number can be increased to 70. A count made on February 17, shows that 59,994 passengers were carried over the bridge between 4 and 7 p. m. under the new system, as against 57,207 under the old system, as shown by a count on October 27. Mr. Dutton also said that running trains through to Park Row placed at the disposal of the company the old terminals at the Brooklyn end of the bridge, from which they could run out practically empty trains to accommodate Brooklyn passengers. The company has put in service 100 new steel elevated cars and has greatly increased the service on several of its lines. The hearing was continued on Tuesday of this week. Mr. Dutton said that the opening of the Brooklyn subway had lessened considerably the traffic on the bridge and that by means of the through trains the rush hour crowds over the bridge were now better handled than ever before. He said that the only way to use shuttle trains to advantage would be to build a large terminal at the Brooklyn end of the bridge.

The public service commission and Mayor McClellan appear unable to agree as to whether the city authorities or the commission should first consider the proposition of the Interborough-Metropolitan Company to sell the Belmont tunnel to the city. As reported in last week's issue of the Electric Railway Review, the company offered to sell the tunnel to the city for the cost of construction, \$7,239,477 and suggested that the city enter into an operating contract with the New York & Queens County Railway, controlled by the Belmont interests, for 25 years, the city to pay one-half of the estimated operating expenses and the balance to be met by the company; the city to take the local fares until reimbursed for its advances for operating expenses and interest on bonds issued to pay for the tunnel and 1 per cent for a sinking fund, the company to take the through fares, and when the city has been reimbursed, the local fares to be divided equally between the city and the company. A delegation from the borough of Queens called upon the mayor on March 10 to urge the purchase and were referred to the commission. They then called upon Chairman Wilcox and were told that the commission had nothing to do with the matter until the city authorities decided favorably on the question. The position of the commission is based upon an opinion rendered by George S. Coleman, counsel to the commission, who said in part:

"I am of the opinion that this proposition is one for the decision, in the first instance, of the city authorities which have to do with the expenditure of public money. If the proposition does not commend itself to the city, the advice of the commission is needless.

"If the city authorities are inclined to favor this proposition, the matter may later come before this commission for its approval under the provisions of the public service commissions law or for its aid and co-operation in the carrying out of the same under the provisions of the rapid transit act, but this latter act, in its present form, gives to the commission no powers which would allow the purchase of an existing railroad or tunnel with public money, and the rapid transit act would have to be amended in order to grant any such authority for the purchase of a railroad or tunnel in lieu of construction of the same at the public expense, and to provide for any such

co-operative arrangement for operation and taking of fares in lieu of a guaranteed rental, as now provided, to cover interest and sinking fund for bonds issued to pay for the public improvement."

Plans for the construction of additional subways in New York City received a severe setback on March 9 when Comptroller Metz announced that the city would have no available funds this year and probably not for the next two years, which could be employed for the construction of subways. This announcement was made following a conference in Mayor McClellan's office attended by officials of the city financial department and the chief engineer of the board of estimate. It was estimated that the city's borrowing capacity on July 1, under the constitutional provision restraining the city from issuing bonds in excess of 10 per cent of the assessed real estate valuation, would be only \$33,000,000 and that imperative city improvements which have not yet been provided for would use up that remaining amount. The plans for the Brooklyn Fourth avenue subway are now being revised and still have to be passed upon by the board of estimate. Chairman Wilcox of the public service commission stated on March 5 that he hoped to be able to advertise for bids within two weeks. The plans for the Broadway-Lexington route are now being considered by the board of estimate. A plan has been suggested that only the amount required for one year's construction work be charged against the city's debt limit, instead of the entire amount of the contract. This plan might make it possible to begin the construction of one of the subways at once. The corporation counsel is expected to render an opinion as to the feasibility of the plan in a few days.

#### Legislation Affecting Electric Railways.

**Massachusetts.**—The Boston Elevated Railway has withdrawn from the legislature its bill to provide authority to acquire control of connecting street railways by purchase of stock. The action follows efforts of the Public Franchise League to oppose the measure in the legislature and to stir up public opinion against it as a dangerous bill. The company takes the ground that it will not seek legislation that is against the wishes of the public.—In regard to the bill of the Boston Elevated Railway to allow it to purchase the West End Street Railway, now held under a lease, the legislature, after receiving a favorable report from its committee on street railways, has asked the railroad commission to state what public benefits would result from the passage of the act and the consummation of the purchase. The commission was to report on March 9, but they have asked for 30 days additional time for investigation.

**New York.**—George M. Palmer has introduced in the house a bill to amend the public service commission bill. The amendments give the mayor of New York City the power to name the members of the commission for the first district instead of the governor, provide for the payment of the expenses of this commission by the city and reduce the salary of members of both commissions from \$15,000 to \$9,000 and of counsel from \$10,000 to \$7,500. It is also provided that two members of each commission shall be members of the political party receiving the second highest number of votes in the city and state elections; that one member of each commission shall be an experienced railroad workman, and that the terms of all the present commissioners shall expire on January 31, 1909; the governor and mayor are then to appoint each five commissioners for each district, one to serve one year, two to serve two years and two to serve three years. Thereafter, the term of office shall be three years and vacancies shall be filled by appointment for the unexpired term only.

**Ohio.**—Senator F. C. Howe has introduced in the senate a bill which provides that in case a city and a street railway company cannot agree as to the conditions of a franchise the city may proceed to acquire the tracks or lease them by an appropriation suit. The measure is directed at the Cleveland situation and provides a method of settling the controversy if the present negotiations for a lease of the Cleveland Electric Railway to a holding company are unsuccessful.—Representative Foster has introduced a bill providing that whenever steam railroads and interurban electric roads form a substantially continuous line of railway in the state they shall establish joint rates for passenger and freight traffic.—Representative Wertz has introduced a bill to compel the interchange of passenger and freight traffic by steam and electric roads when the track and equipment of the interurbans are of sufficient strength to accommodate the rolling stock of steam roads.

**American Institute of Electrical Engineers.**—The Minnesota section of the American Institute of Electrical Engineers will meet at the office of the St. Paul Gas Light Company, Sixth and Jackson streets, St. Paul, on Monday evening, March 16, 1908. Albert H. Armstrong of Schenectady, N. Y., will

address the meeting on "Heavy Electric Traction," which will be followed by a general discussion. An informal dinner for members and others at the Ryan hotel will precede the meeting.

**New England Street Railway Club.**—The annual meeting of the New England Street Railway Club will be held at the Hotel Somerset, Boston, Mass., on the evening of March 26 and the election of officers will take place at that time.

**Chicago & Milwaukee Offices Moved.**—The general offices of the Chicago & Milwaukee Electric Railroad, Chicago, Ill., have been removed from the Stock Exchange building to the Tacoma building. The operating offices are at Highwood, Ill., and Robert B. Stearns, formerly general manager, is acting as operating manager for the receivers.

**Georgia Railway & Electric Employees' Association.**—The employees of the Georgia Railway & Electric Company, Atlanta, Ga., have recently organized a benefit association, known as the Georgia Railway & Electric Employees' Association, which has about 500 charter members. The members pay dues of 50 cents a month, or \$5.00 a year if paid in advance, and when sick or disabled are entitled to \$1.00 a day from the funds of the association, free medicine and free physicians. In case of death by accident or sickness a beneficiary is to receive \$100.

**Resume Operation of Indianapolis Viaduct.**—The Indianapolis Traction & Terminal Company and the Indianapolis Columbus & Southern Traction Company have received permission from the city engineer of Indianapolis to operate light cars over the Virginia avenue viaduct, although the permanent repairs to the structure have not yet been completed. The companies have been obliged to use another route for several weeks because of the condition of the bridge but, according to the city engineer, since about 700 tons of dead weight, such as sidewalks, paving and the concrete base of the roadbed have been removed and it is now considered safe to use the bridge.

**Winnebago Traction Company Wins Bridge Case.**—The Wisconsin supreme court has decided in favor of the Winnebago Traction Company, of Oshkosh, Wis., a long controversy between that company and the city of Oshkosh and the Eastern Wisconsin Railway & Light Company, of Fond du Lac, Wis., in regard to the latter's right to operate its cars across the Main street bridge into Oshkosh. The decision of the lower court, under which the Eastern Wisconsin Company has been operating across the bridge, is reversed, and the court holds that the only way in which the company may secure the right is by condemnation proceedings or by purchasing the right from the Winnebago Traction Company, which holds the franchise.

**Instructing Trainmen on the Illinois Traction System.**—In regard to the methods of instruction of trainmen recently put in practice by the Illinois Traction System, C. F. Handisy, general superintendent of transportation, writes: "The practice we are now employing in regard to the examination of trainmen is the same as used by steam roads. We are holding schools of instruction similar to those held by steam roads, taking up the book of rules, timetables and the general method of operation; or, in other words, we are trying to make better men out of our trainmen, that is, get them thoroughly posted on train rules, train orders, etc., and keep them that way. We recently issued a new book of rules, which of course made this absolutely necessary in order that all should get the same understanding. We intend to hold schools of instruction at least once in two weeks at each division point, until such time as we have the men well enough posted so that one session a month will be sufficient, or once in two months."

**Increase of Wages in Des Moines.**—We are advised by A. G. Maish, general manager of the Des Moines City Railway, that a board of arbitrators representing the company and its motormen and conductors, appointed to adjust the wage scale for the next two years, until March 4, 1910, has decided upon a rate of 19 cents per hour for the first year's service, increasing one cent per hour for each succeeding year's service, including the sixth. The carmen recently demanded an increase of about 40 per cent, while the company felt that the increase was unwarranted and asked for a reduction. The question was then submitted to arbitration. The old scale was 16 cents per hour for the first year's service, increasing to 23 cents for the ninth year and thereafter. A controversy as to the wages of the carmen employed by the Inter-Urban Railway of Des Moines was settled on Saturday night, when the men voted to accept President Polk's offer of the same scale that was granted the city men. The men had demanded a higher rate than that paid the city men, but accepted the same rate in view of certain concessions, including pay for deadhead time and three cents per hour additional for overtime.



# Traffic and Transportation

## Through Routes on Chicago Elevated Roads.

Clarence A. Knight, president of the Chicago & Oak Park Elevated Railroad, has written a letter to Alderman M. G. Foreman, chairman Chicago council committee on "Local Transportation," in which he signifies the willingness of that company to put into effect a system of universal transfers in connection with the other elevated roads, under an arrangement satisfactory to all interests. Mr. Knight states that if through routing cannot be brought about he is in favor of eliminating several stations and of elevating the north track of the loop on Lake street from La Salle street to the west track on Fifth avenue and the west track on Fifth avenue from Lake street to Washington street. Mr. Knight would also extend the platforms of the loop stations. Before committing the company to any of these propositions, however, Mr. Knight desires that some disposition be made of several matters that have been pending before the committee for three years, including an ordinance granting the company the right to elevate its tracks from Fifty-second avenue to Austin avenue.

H. G. Hetzler, president of the Metropolitan West Side Elevated Railway, does not favor the plan for the through routing of trains on the Chicago elevated roads or the plan for running the Metropolitan cars from the Humboldt park and Logan square branches to the loop over the Lake street road.

## Withdrawal of Commutation Tickets by Schenectady Railway.

The Schenectady (N. Y.) Railway has filed its answer with the New York public service commission, second district, in relation to the complaint of residents of Albany, Troy, Schenectady, Green Island and Watervliet, as to withdrawal of the sale and use of commutation tickets since January 1. The company denies that the withdrawal of such tickets was unreasonable. It denies the statements contained in the complaint as to dividends declared and paid by the company. In connection with such denial the company states that since the present owners of the stock of the company acquired the same and assumed the management of the company but one dividend has been paid and that was a dividend of 1¼ per cent, payable on July 30, 1906. No other dividend has been paid, for the reason that the earnings are not sufficient to justify a dividend.

The company denies that it is the policy of the management to curtail the service without consideration of the convenience of the traveling public, but on the contrary alleges that the management has arranged its service with as little inconvenience to the traveling public as is possible. With the object in view of increasing its revenue and decreasing its expense, the management found it necessary to adopt such a policy that the earnings might fairly be expected to be increased or the expenses of operation reduced to the end that some reasonable degree of profit might be left to afford some return on the investment. It has been found impossible to reduce expenses of operation, as an increase of wages of 20 per cent has been necessary, and costs have increased in every department concerned with the operation and maintenance of the road. Without material deduction in wages some increase must be obtained by way of revenue to enable the present management to maintain the road and its operation and produce any return upon the investment. Such increase, the present management believes, will be in part obtained by the withdrawal of the commutation tickets.

The company further states that the use of commutation tickets was adopted by the General Electric Company when it was the owner of the Schenectady Railway, and as the present management is advised, this arrangement was not a railroad, but an industrial feature. At that time it was impossible for that company to find living accommodations for its workmen in Schenectady, and it was necessary therefore for that company, also owning the railway, to make rates of transportation to and from points outside of Schenectady so low that its employes might live in such outside localities to be carried on the railway from and to their homes. Since these commutation rates were put in effect the conditions have changed. Schenectady has grown, the needs of employes to go outside the city to live have become less, and the result now claimed is that the rates so adopted are so low that they produce no adequate return for the service.

The company further states that the traffic for which commutation rates were adopted cannot be cheaply carried, for the reason that in the hours in which commuters ride the cars have few passengers, as in the morning hours the tide of

travel is toward Schenectady, and in the late afternoon hours is from that place. The company contends that the rates now charged are fully as low or lower than those which prevail on other electric lines fairly to be compared with the Schenectady Railway. The company requests that the complaint be dismissed.

## Petition for Reduced Fares in Springfield, Mass., Denied by State Commission.

The Massachusetts railroad commission has dismissed the petition asking that the Springfield Street Railway be compelled to sell six tickets for 25 cents, and 25 tickets for \$1.00. In its decision the commission states:

"The board has given a hearing upon this petition, the grounds of complaint being that the rates of fare are excessive and that the company does not furnish a sufficient number of cars to accommodate the public.

"The case does not present the question of extension of privileges to a rapidly growing suburban community or to outlying suburbs in process of development. No convincing evidence has been presented in support of the contention that a reduction in the rate of fare will result in a considerable increase of revenue from present patrons or from persons not now using the road, and we believe it would be unfair to ask the company to test by a trial the soundness of the petitioners' argument. A company might adopt experimental measures in the management of its business which the board could not properly recommend in the exercise of its supervisory powers.

"The complaints as to insufficient number of cars related in large measure to the so-called rush hours of the afternoon, and unsatisfactory conditions were particularly alleged in connection with the Wilbraham road, Belmont avenue, Maple street, Liberty street, Chicopee by way of Glenwood, and Chicopee Falls by way of Brightwood, and Chicopee lines. Subsequent to the hearing careful observations were made on five days and the board is convinced from both the evidence and the reports of these investigations that improvement is being made and that the company is endeavoring to give to Springfield citizens the first-class service to which they are entitled, but this endeavor is hampered by existing track conditions. Many of the delays of which complaint was made were caused through single-track operation. It appears that the company has now pending before the authorities of Springfield applications for double-track locations upon which no action has been taken. It would obviously be improper for the board, in view of its statutory duties as to approval of location grants, to make any suggestion relative thereto, but it is its conviction that the only remedy for much of the inadequacy of accommodation is additional trackage, and we, therefore, so far as we may with propriety do so, urge the petitioners and company to give attention to this phase of the situation."

"The rule of construction in instruments of this character, where an ambiguity exists, is as follows: 'If any ambiguity exists in a grant of privilege, it must operate against the grantee in favor of the public.'"

## Decision in Long Island Fare Case.

The decision of the New York Public Service Commission, Second District, requiring the New York & Long Island Traction Company, Hempstead, N. Y., to charge not to exceed five cents fare for a continuous trip of five miles or less over any portion of its lines as described in its articles of association, is by Chairman Stevens. An abstract of the decision follows:

"The respondent was incorporated in 1899, under the name Mineola Hempstead & Freeport Traction Company. This name was changed in 1902, to the New York & Long Island Traction Company. The fourth of its articles of association, reads as follows: 'Such road shall be \* \* \* operated from points in the village of Mineola to points in the village of Freeport, all within the county of Nassau, which points shall be its terminal; and its length shall be 11 miles.' It appears that the greater portion of the route thus described is situate within the town of Hempstead, and beginning in the northerly line of that town runs south through the villages of Hempstead and Freeport. The distance from the northerly line of the town of Hempstead to the northerly line of the village of Hempstead is less than five miles, and the distance from the southerly line of the village of Hempstead, to the northerly line of the village of Freeport, is less than five miles. There also appears to be a portion of the line in the town of Hempstead south of the southerly line of the village of Freeport, which is less than five miles in length.

"On June 6, 1901, the highway commissioners of the town of Hempstead granted a consent for the construction of the road, describing three different places therein where it might be constructed. The question arises upon the proper construction of provisions in the franchise. After granting the right of way, the resolution makes certain conditions, one clause providing that the Mineola Hempstead & Freeport Traction Com-

pany shall make not less than six round trips daily over the entire track laid by it, and that the maximum rate for one continuous passage in either direction over the entire line as herein described shall not exceed 10 cents and shall not exceed 5 cents for any five miles or less, and that the traction company shall issue to and receive from any connecting line or lines, now or hereafter to be built, upon payment of one fare therefor transfer checks or tickets, the fare paid to be divided between the connecting companies in proportion to the distance traveled by the passenger, and that in no case should the proportion charged by the traction company exceed 10 cents for passage over its entire road, as herein described, and it shall not exceed five cents for any five miles or less.

"The respondent charges 10 cents fare from a point in the village of Freeport to a point in the village of Hempstead, which points are less than five miles apart. It claims that the condition in its franchise just quoted does not relate to those portions of its line situate within the villages of Hempstead and Freeport, and is applicable only to those portions of its line situate in the township of Hempstead outside of the limits of the two villages. The complainant urges that the condition is applicable to the entire line.

"The language of the franchise is ambiguous to some extent. In the franchise there is no specific description of the entire line, while, on the other hand, there is a specific description of those portions of the line which lie wholly within the town of Hempstead and outside of the villages of Hempstead and Freeport. The respondent claims, therefore, that the language quoted relates only to those portions of the line which are specifically described in the grant. The question is whether the highway commissioners intended to restrict the amount of fare to those portions of the line situate exclusively within the town of Hempstead, or to restrict it upon the entire line. The requirement that the respondent shall make not less than six round trips daily over the entire track laid by it shows that the commissioners had the entire track, covering a distance of 11 miles, in mind. This provision is then followed by the agreement that the maximum rate for one continuous passage in either direction over the entire line as herein described shall not exceed 10 cents. There could not be a continuous passage in either direction over the three distinct parcels situate within the town of Hempstead. The words 'entire line as herein described,' are not aptly chosen in view of the drafting of the remainder of the grant, but they cannot have any proper effect unless they refer to the words 'entire track' in the previous sentence and also to the line as described in the articles of association of the respondent. The next words used, 'And shall not exceed 5 cents for any five miles or less' clearly contemplates a continuous trip of five miles which was not physically possible within the town of Hempstead. It is very clear that the commissioners intended to cover by this language the entire length of the road. An ambiguity in the language may be conceded to exist, and the question then becomes whether or not they succeeded in embracing within the grant the intention which we hold they had.

**Theater Car on Illinois Traction System.**—A special theater car was run to Springfield, Ill., over the St. Louis branch of the Illinois Traction System on March 8.

**Additional Service on Long Island.**—The Long Island Railroad has announced that a new schedule will be placed in force on May 28, giving additional service to many parts of Long Island.

**Service Improved in Savannah, Ga.**—Under a plan of making stops, introduced by the Savannah (Ga.) Electric Company, officials report that the service is rapidly improving. The regular stops now in effect enable trains to maintain much better schedules.

**Owl Car Service in Toledo.**—The Toledo (O.) Railways & Light Company has established owl car service. H. S. Swift, secretary and auditor of the company, announced that the total number of passengers carried on the first night was 282 and the total receipts were \$14.10. Five cars were operated.

**Parlor Car Service on the Puget Sound.**—The parlor car service established by the Puget Sound Electric Railway between Tacoma and Seattle has been so successful that additional cars will be introduced to meet the demand. At present two parlor cars are in service, and an additional charge of 25 cents is made for a seat therein.

**The Near or the Far Side of the Street in St. Paul.**—At a conference between the fire board, officials of the Twin City Rapid Transit Company and a committee of the city council in St. Paul on March 4, an agreement was reached regarding the stops. The company agreed to restore the old system of stopping on the far side of the street at practically all crossings and the fire board agreed to the elimination of the stops on the near side of Cedar street. The board insisted that the

cars stop before crossing streets where firemen make runs, but agreed that the runs on Cedar street should be abolished. This concession will eliminate stops at three points where streets on which cars run intersect with Cedar street. The arrangement is subject to approval by the city council.

**Georgia Hearing Concluded.**—The hearing on the application before the Georgia railroad commission for reduction in the fare between Atlanta and Marietta from 35 to 20 cents, was concluded at Atlanta on March 5. P. S. Arkwright, president of the Georgia Railway & Electric Company, admitted that the stock in the Atlanta Northern Railway is owned by the Georgia Railway & Electric Company.

**Order Regarding Transfers in Schenectady, N. Y.**—The Schenectady (N. Y.) Railway Company has issued orders to conductors to give no transfers from one line to another, except at the transfer points printed on the back of transfers. The transfers will not be accepted by conductors except when people board cars at the proper points. This order has been issued to protect the company from many abuses of the transfer privilege.

**Count Cars and Passengers on Brooklyn Bridge.**—Inspectors of the bridge department of New York City were stationed on the Brooklyn bridge during the evening rush hours on February 17 to count the cars and passengers. The inspectors found that on the surface lines, between 4 and 7 o'clock, there were 328 cars per hour, or 26 cars more than on October 17 last, when the elevated bridge service was in operation and the subway not in use. During the three hours these cars carried 9,839 passengers. The elevated roads had during the same hours 1,026 cars and 59,994 passengers, against 700 cars and 57,007 passengers on October 17, 1907.

**Fare Reduction to be Contested in Oregon.**—The Oregon Water Power & Railway Company, Portland, Ore., which is operated by the Portland Railway Light & Power Company, will contest in court the order of the Oregon railroad commission that the company reduce fares between Oak Grove and Milwaukie and Portland, and also extend transfers to Lents. In referring to the proceedings which have been started Ralph W. Wilbur, attorney for the company, said that when the railroad commission decided against the company it was decided to bring the case before the courts, for the reason that fares charged by competitors exceed the 5-cent rate. The company contends that it should not be compelled to carry passengers at a lower fare than other companies are permitted to charge.

**Changes in San Francisco.**—Charles N. Black, vice-president and general manager of the United Railroads of San Francisco, has made public a statement in relation to reports concerning changes in the force of inspectors and extra conductors and the curtailment of the transfer system. Mr. Black states that it is not the intention of the company to curtail any privileges or to hamper the service; and, while the force of inspectors has been reduced materially, he calls attention to the fact that prior to the fire, when the traffic was much larger than it is at present, the company employed 25 inspectors, and that number has been found ample to perform all the duties now required of such employes. Mr. Black adds that the transfer system has not been curtailed in any particular, but that during the last three months transfer privileges have been increased materially. The only restrictions are those which have become necessary to avoid deliberate misuse of transfer privileges. The changes simplify the system and avoid disputes between passengers and conductors.

In reply to a request of the New York public service commission of the first district, President Mellen of the New York New Haven & Hartford Railroad on March 6 sent a letter explaining that the construction of an electric line between New York and Port Chester is being delayed by litigation. The New Haven owns two franchises, one for the New York Westchester & Boston Railway and one for the New York & Port Chester Railroad. The validity of the Westchester franchise has been questioned and the company has been unable to acquire the necessary right of way by condemnation proceedings. The route of the Port Chester franchise was changed to coincide with that of the Westchester company, but construction has been blocked by an injunction. Mr. Mellen assured the commission that as soon as the legal difficulties are settled the New Haven company would proceed to build the line.

The Gaceta de Madrid of February 7 announces that the Compania del Ferrocarril de Sarria at Barcelona, Spain, has applied for a concession for an electric tramway in Barcelona, and that a period of one month from the date of publication has been appointed for the presentation of proposals.

# Construction News

## FRANCHISES.

**Bridgeport, Ala.**—A franchise has been granted to C. A. Sutliff and associates of South Pittsburg, Tenn., for the construction of an electric railway in Bridgeport, which it is stated will form part of an interurban line to be built from Bridgeport to Copenhagen, Richards City, South Pittsburg and Jasper, Tenn.

**Brownsville, Tex.**—S. K. Hallam, L. H. Hallam, John G. Fernandez and A. C. Brokaw, all of Brownsville, Tex., have applied for a franchise to build a street railway in this city.

**Chicago, Ill.**—The ordinance extending the franchises of the South Chicago City Railway and the Calumet Electric Street Railway and providing for a consolidation of the companies under the name of the Calumet & South Chicago Railway, was considered at a public meeting of the local transportation committee of the city council on March 3, and was practically completed on March 6. Representatives of residents of the districts affected appeared to suggest numerous changes in the ordinance. The ordinance extends the date of expiration of the present franchises from 1912 and 1915 to 1928, and requires a division of the net receipts with the city, the latter receiving 55 per cent as in the Chicago City Railway and Chicago Railways Company franchises. The ordinance also provides for four transfer zones. In the first zone transfers are to be exchanged with the Chicago City Railway. In the second zone transfers are to be exchanged after a year, provided the company earns 6¼ per cent on its investment. Bion J. Arnold and George Weston are now making a valuation of the property. The ordinance provides for a thorough rehabilitation of the properties within 3½ years, 40 miles of track to be rebuilt at once. The company is required to provide 15 new cars within the first year and as many thereafter as may be specified by the board of supervising engineers. Seven important extensions are to be built by January 1, 1910.

**Dallas, Tex.**—The city council has passed an ordinance granting a franchise to the Texas Traction Company for an entrance to the city. The route lies mostly over the tracks of the Dallas Consolidated Electric Street Railway and the Metropolitan Street Railway but the company will build some new track of its own. The line from Sherman to Dallas, 65 miles, is expected to be ready for operation about June 1.

**Evans, Colo.**—The city council has granted a franchise to the Greeley & Northern Colorado Railway & Utility Company for the construction of an electric railway in Evans, Colo. It is stated that 20 acres of land will be donated by the city for car repair shops and barns, to be located about two blocks west of the Union Pacific depot. It is also reported that a portion of the right of way through the western part of the city will be donated to the company.

**North Yakima, Wash.**—The Yakima Valley Transportation Company has applied for an extension of one year in which to complete the first five miles of track. Under the terms of the franchise, the company should have had this amount of tracklaying completed by March 12, but owing to delays only three miles had been laid. Five miles must be laid each year hereafter. (Noted January 4.)

**Seattle, Wash.**—A franchise has been granted by the county commissioners to F. X. Waldron & Co. of this city for the construction of an electric railway and light system on Vashon island. The road will be 12½ miles long and will pass from the north to the south end of the island, by way of Burton. Final surveys have been completed and it is stated that grading will be started at once and the work pushed in order to have the line completed by June 1, 1909, the date of the opening of the Alaska-Yukon-Pacific exposition. The plans include two fast ferry boats, one running to the north end of the island from Seattle and the other to the south end from Tacoma, Wash. It is stated that the power house and electric light plant will be located at Lisabeula. The franchise states that the line must be started within 90 days from the date of the grant, be completed as far as Burton within two years and be entirely completed within five years. (Noted February 22.)

## RECENT INCORPORATIONS.

**Catoctin & Pen-Mar Railway.**—A bill has been introduced in the Maryland legislature at Annapolis to charter this company to build a railroad from Myersville to Pen-Mar, Md., the line to be operated either by steam or electricity. Capital stock, \$50,000, which may be increased to \$500,000. Incorporators:

Henry M. Warrenfeltz, Hubert L. Hanover, Dr. Alvey J. Smith, C. Upton Grossnickle, George R. Stottlemeyer, Michael Kline, C. W. Blickenstopp, J. David English, Gideon O. Horne, I. A. Pox, Worth B. Stottlemeyer and J. W. Brown.

**Kansas City & Kansas Southwestern Electric Railway.**—This company has applied for a charter to build an electric railway in Kansas connecting Topeka, Kansas City and Independence, Kan. Capital stock, \$10,000,000. E. M. Lamkin, Kansas City; J. E. Martin and C. S. Dudley, Minneapolis, Minn.; W. L. Moyer, New York City; W. Laming, Tonganoxie, Kan.; S. W. Brewer, Chanute, Kan.; and Harry E. Hopper, Indianola, are interested.

**Montgomery Electrical Company, Christiansburg, Va.**—Incorporated in Virginia to build an electric railway from Christiansburg to Cambria, Va. Capital stock, \$5,000, which may be increased to \$50,000. J. L. Vaughan, Shawsville, Va., president; E. S. Hagan, vice-president; A. A. Palegar, Jr., secretary and treasurer, Christiansburg, Va.

**Thief River Electric Railway, Thief River Falls, Minn.**—Incorporated in Minnesota to build an electric railway from Thief River Falls northeast into Beltrami county. It is stated that \$50,000 has been subscribed and a part of the right of way donated. D. N. Winton, president; D. P. O'Neill, first vice-president; Milton Forder, second vice-president; M. V. Everson, third vice-president; T. P. Hamre, secretary; L. M. Hoag, treasurer; G. Halvorsen, counsel.

**Washington & Maryland Electric Railway.**—A bill has been introduced in the Maryland senate by Senator Claggett of Prince George county, incorporating this company, which proposes to build and operate an electric railway from Washington, D. C., to Ritchie Station. Prince George county, where it will connect with the Chesapeake Beach (steam) Railway. Horace Crosier, commissioner of Prince George county; Samuel E. Cox, T. Van Claggett, George S. Dove, F. Snowden Hill, George Zerhorst, Albert S. Carry, Alfred G. Shaw and Ernst Gerstenberg are named as incorporators.

## TRACK AND ROADWAY.

**Annapolis, Md.**—Senator Lee of Montgomery county, Maryland, has introduced a bill in the senate providing for the construction of a 5-mile electric railway which will afford direct connection between Damascus and Mt. Airy, Md.

**Atlanta & Carolina Railway, Atlanta, Ga.**—This company which proposes to build an electric railway from Atlanta to Augusta, Ga., has filed amended articles of incorporation which provides for extensions into the following counties not included in the original charter: Newton, Columbia, Richmond, Lincoln, Walton, Oconee, Clarke, Oglethorpe, Wilkes and McDuffie. James W. English, president. (Noted March 7.)

**Augusta & Columbia Railway, Augusta, Ga.**—It is announced that this company, which was organized about a year ago to build an extension of the Augusta & Aiken Railway from Aiken to Columbia, S. C., 59 miles, will start construction work in the near future. It is proposed to connect with the Augusta & Atlanta Electric Railway, on which construction will soon be started between Atlanta and Augusta, and will afford a through trolley route from Atlanta, Ga., to Columbia, S. C. James U. Jackson, Augusta, Ga., is interested. (Noted April 20, 1907.)

**Bartlesville (Okla.) Interurban Railway.**—W. G. Thummel, chief engineer, writes that a contract has been let to the Freeborn Engineering & Construction Company of Kansas City for the overhead construction, tracklaying and installation of power house machinery for the line between Bartlesville and Dewey, Okla., seven miles. The power house equipment, including generators, engines, pumps and boilers, was purchased on March 6 from the John A. Stewart Electric Company of Cincinnati, O. Rails, spikes, etc., were also purchased from the St. Louis Rail & Equipment Company. The road is to be in operation by June 15. J. J. Curl is president. (Noted December 14, 1907.)

**British Columbia Electric Railway, Vancouver, B. C.**—During the year 1907 this company constructed about 9½ miles of single-track extensions in Vancouver, Victoria and Westminster, B. C., and several miles of track were laid with 60-pound rails, in place of 40-pound rails in Vancouver, and with 56-pound rails in Victoria. Among the extensions outlined for this year are the Westminster-Chilliwack line, about 56 miles, and other extensions aggregating about 50 miles. The work is to be done by the company. R. H. Sperling, Vancouver, is general manager.

**Buffalo Lockport & Rochester Railway, Niagara Falls, N. Y.**—The Rochester-Albion section of this line from Rochester to Lockport, N. Y., is now expected to be in operation by

May 1 and the Albion-Lockport section by July 1. Tracklaying on the latter section has been completed to a point just east of Lockport and the remainder will be finished as soon as the weather permits. Power will be received from the Niagara Lockport & Ontario Power Company. J. G. White & Co. are the contractors. Edmund Wragge, chief engineer, Toronto, Ont. (Noted August 31, 1907.)

**Charleston & Summerville Electric Railway, Charleston, S. C.**—It is stated that grading will soon be resumed on the remaining four miles of this 27-mile interurban line which will connect Charleston and Summerville, S. C. George Tupper, secretary and treasurer, Summerville, S. C. (Noted January 4.)

**Chicago Railways Company.**—A permit has been secured from the city superintendent of streets for the reconstruction of the tracks on North Clark street, from Washington street to Addison avenue, and in Milwaukee avenue between Desplaines and Robey streets. The tracks will be relaid with 129-pound grooved rails. Work is to begin about March 25.

**Connecticut Company, New Haven, Conn.**—Plans for an electric railway from Willimantic to South Coventry, Conn., have been submitted to the board of aldermen of Willimantic. A hearing was held before the state railroad commission on March 9 on the proposed line from Waterbury to Woodbury. No opposition developed.

**Eastern Pennsylvania Railway Company, Pottsville, Pa.**—This company has completed an 8-mile link between Tamaqua and Middleport, Pa., completing a through line from Pottsville to Mauch Chunk.

**Eastern Railway Construction Company.**—This company was formed at a recent meeting of stockholders of the West Chester & Wilmington Electric Railway, with a capital stock of \$10,000 to build its proposed electric railway from West Chester, Pa., to Wilmington, Del. The West Chester & Wilmington company holds charters for operating in both Pennsylvania and Delaware and steps for merging the two companies have been taken.

**Evansville (Ind.) Railways Company.**—C. H. Battin, general manager, writes that a new line will be built this year from Evansville to Newburg, Ind., nine miles, for both steam and electric operation. The line will be built under the name of the Evansville Terminal Railway.

**Des Moines (Ia.) City Railway.**—George B. Hippee, president, writes that this company does not propose to make any extensions or improvements this year.

**Des Moines Winterset & Creston Electric Railway, Des Moines, Ia.**—E. B. Steere, general manager, writes that surveys have been completed for the proposed line from Des Moines to Creston, Ia., 64 miles. Construction is to begin as soon as financial arrangements are completed. The company has a 25-year contract with the Inter-Urban Railway and the Des Moines City Railway for terminal facilities in Des Moines and will use 5.7 miles of those companies' tracks from Valley Junction to a loop in the city. It has also made arrangements for freight terminals in Des Moines and has favorable franchises in Winterset, Macksburg and Creston, the latter being exclusive for 25 years. The line will be entirely on private right of way, 100 feet wide, over 80 per cent of which is now owned or contracted for. It is planned to erect a power plant and to sell current for lighting and power. The estimated cost of construction is \$1,815,583. W. D. Skinner is president and B. Schreiner is chief engineer. (Noted February 22.)

**Dunnville Wellandport & Beamsville Electric Railway, Dunnville, Ont.**—We are advised by James A. Ross, president, that this company expects to start construction work on its 16-mile electric line from Dunnville to St. Ann's during the coming summer. The preliminary surveys have been completed and plans and estimates are being made. President, James A. Ross, Wellandport, Ont.; vice-president, F. R. Lalor, M. P., Dunnville; secretary, W. J. Aikens, Dunnville. F. J. Ramsey, M. L. Parry, R. A. Harrison, George R. Smith, Thomas Marshall and E. L. Edgecomb, all of Dunnville, Ont., are the directors. (Noted March 7.)

**Ft. Wayne & Springfield Railway, Decatur, Ind.**—This company has filed notice of an increase of capital stock from \$500,000 to \$1,000,000 for the purpose of building an extension from Decatur to Richmond, Ind., and an organization of representatives from various towns along the proposed route has been formed to co-operate with the company to secure the line.

**Hanford (Wash.) Electric Railroad.**—It is reported that construction on the proposed electric line from Hanford to Kennewick, Wash., will be started at once. The line will be built by the Hanford Irrigation Company and it is stated that materials have been purchased.

**Grand Haven, Mich.**—It is reported that E. J. H. Stone-metz contemplates building a new street railway in Grand Haven and taking over the city lighting plant.

**Illinois Traction System, Champaign, Ill.**—Plans are now being considered for the construction of the line between Peoria and Sreator, Ill., which will form a part of the proposed through line to Chicago, via Yorkville or Joliet.

**Jacksonville, Tex.**—H. L. Norton of Boston, Mass., is in Jacksonville endeavoring to interest the citizens of this and other towns in a proposed interurban electric line 75 miles long, which will connect Jacksonville, Dialville, Rusk and Tyler, Tex. The road will be built primarily for handling the truck and fruit trade in this section. Mass meetings are being held in the towns along the route.

**Louisville (Ky.) Railway.**—This company proposes to authorize an issue of \$1,000,000 preferred stock to provide for improvements to its power station and for the extension of its Bardstown line. It is intended also to build an extension to the state fair grounds. T. J. Minary, president and general manager, Louisville, Ky.

**Memphis Covington & Northern Railroad, Covington, Tenn.**—R. W. Sanford, attorney, writes that this company has completed surveys for its proposed interurban electric line, which will connect Memphis and Covington, Tenn., 40 miles. The plans of the company have not been fully decided upon, but Mr. Sanford states that construction work may be started this summer. J. B. Gillespie, president, Covington, Tenn.; J. B. Witherington, vice-president; John T. Garner, secretary and treasurer; R. W. Sanford, attorney. W. K. Palmer Company, 718 Dwight building, Kansas City, Mo., chief engineer. (Noted November 16, 1907.)

**Metaline Rapid Transit Company, Seattle, Wash.**—This company has recently been organized by John S. Cosford, W. W. Warner and H. J. Warner of Seattle.

**Mexico Santa Fe & Perry Traction Company, Mexico, Mo.**—It is reported that grading, for which contracts were awarded last fall, will soon be resumed on this proposed line between Mexico and Perry, Mo., by way of Mollino and Santa Fe. Three miles had been completed when work was suspended in the winter. It is stated that contracts for roadbed construction and equipment will be let in the near future. The line will be 27 miles long and gas-electric cars will be operated. S. L. Robinson, president and general manager, Mexico, Mo. (Noted February 15.)

**Montgomery (Ala.) Traction Company.**—Announcement is made that this company expects to spend \$100,000 for improvements.

**Ohio Electric Railway, Cincinnati, O.**—Tracklaying on the Lima-Bellefontaine line has been completed from Waynesfield to Huntsville, O. It is stated that within 60 days this portion of the line will be ready for the overhead construction and that it will be in operation some time in May.

**Omaha & Council Bluffs Street Railway, Omaha, Neb.**—Work has been started on the new Twenty-fourth street line of this company from Leavenworth street to Cass street and as soon as Twenty-fourth street has been opened from Cass street to Cumming street work will be pushed to an early completion of the line. W. A. Smith, general manager, Omaha, Neb.

**Pacific Electric Railway, Los Angeles, Cal.**—This company has recently secured trackage rights over the Crescent City Railway from Riverside to the plant of the Southern California Portland Cement Company, a distance of five miles, which it is understood will be used in connection with a proposed line from Riverside to Los Angeles.

**Pittsburg Lisbon & Western Railroad, Lisbon, O.**—N. B. Billingsley, president, writes that the report that this company contemplates electrifying a portion of its line and building an extension from Darlington to Morado, Pa., is entirely erroneous, as no such plans have been considered.

**Seattle Electric Company, Seattle, Wash.**—This company is reported to be planning improvements to its lines and equipment during the coming year at an approximate cost of \$1,500,000. It is stated that a number of miles of new track will be built to care for the traffic during the Alaska-Yukon exposition in 1909. H. F. Grant, manager, Seattle, Wash.

**San Francisco Oakland & San Jose Consolidated Railway.**—This corporation has been formed with a capital stock of \$7,750,000 for the purpose of consolidating the San Francisco Oakland & San Jose Railway and the San Francisco & Bay Counties Railway, the latter having been recently incorporated

to build an electric railway from San Francisco to San Jose. The company proposes to continue the operation of the three lines at present operated by the San Francisco Oakland & San Jose, to construct a line from San Francisco to San Jose, to build a branch line to Northbrae and another branch to Claremont, and to connect the main line with Yerba Island by means of a tunnel. The directors are: F. M. Smith, F. C. Havens, E. A. Heron, H. Wadsworth and Dennis Searles, of San Francisco.

**Shore Line Electric Railway.**—Considerable progress has been made on grading for this proposed electric railway and it is stated that the line may be opened for traffic during the coming summer. The company was formed last spring to build a 13-mile electric line from Horse Neck Beach to R. I., and others are interested. (Noted November 9, 1907.)

**Terre Haute Indianapolis & Eastern Traction Company, Indianapolis, Ind.**—Construction is progressing rapidly on the line between Amo and Danville, Ind. When this line is completed there will be two possible routes for the Terre Haute-Indianapolis service, one via Amo and Plainfield, as at present, and the other via Amo and Danville.

**Texas Traction Company, Dallas, Tex.**—Rapid progress is reported on the construction of this 65-mile interurban line from Dallas to Sherman, Tex. About 30 miles of track have been laid from McKinney to a point north of Howe, and it is expected that it will be entirely completed to Sherman within about 10 days. A construction force also is at work south of McKinney and it is expected that the road will be equipped and ready for operation by summer. Theodore Stebbins, general manager, Dallas, Tex. (Noted January 11.)

**Twin City Rapid Transit Company, Minneapolis, Minn.**—George L. Wilson, engineer and roadmaster, writes that no extensions are contemplated this year.

**Utah Light & Railway Company, Salt Lake City, Utah.**—It is announced that this company will build its proposed Ninth avenue electric line during 1908. The new line will follow the present Sixth avenue line for a part of the distance and will then branch off on Ninth avenue, serving a new section of the city which is being rapidly built up. Joseph S. Wells, general manager, Salt Lake City. (Noted West Point, Mass., and into Connecticut from Saybrook to Ivorytown and Essex. Charles F. Parkherm, Woonsocket, November 23, 1907.)

#### POWER HOUSES AND SUBSTATIONS.

**Ohio Electric Railway, Cincinnati, O.**—This company is installing a substation at Jewell, O., on the Springfield-Bellefontaine line.

**Seattle Electric Company, Seattle, Wash.**—It is stated that this company will enlarge its power plant at Georgetown, Wash., during the coming year.

**Athens (Ga.) Electric Railway.**—This company has ordered from the Allis-Chalmers Company for installation in its power house at Athens a 1,000-kilowatt steam turbine, together with a direct-connected three-phase 60-cycle 2,300-volt generator and a 40-kilowatt induction motor-generator set.

**New York City Railway.**—This company is remodeling one of its buildings at Houston street and Broadway, to be used as a substation. Nearly all of the machinery has been installed, including two 1,500-kilowatt rotaries, six transformers and the necessary switchboards and other apparatus, all of General Electric manufacture. It is expected that this will be put in operation during the next two weeks.

**Louisville (Ky.) Railway.**—This company will increase the capacity of its Jacob street power station by the addition of a 3,000-kilowatt turbo-generator unit. T. J. Minary, president and general manager, Louisville.

**Americus (Ga.) Railway & Light Company.**—Contracts for power house equipment for the Americus street railway line have been awarded as follows: Westinghouse Electric & Manufacturing Company, electrical equipment in duplicate, including two steam turbines, with turbo-generators of 550 horsepower and actual speed of 3,600 revolutions per minute; Wheeler Condenser & Engineering Company, Carteret, N. J., condensing apparatus; Casey & Hedges Company, Chattanooga, Tenn., boilers in duplicate, each of 500 horsepower and equipped with superheaters; Henry R. Worthington, New York, pumps, including two boiler feed, one centrifugal and one triplex pump, operated by 100-horsepower motor; General Electric Company, equipment for street-lighting system; Standard Brick Company, Macon, Ga., 300,000 brick for construction of power house; building to be of brick, fireproof, steel smoke-stack, 150 feet high and resting on base of brick and concrete. R. N. Waller, president. (Noted January 4.)

## Personal Mention

Mr. Charles B. Houck has been appointed general manager of the Wilkesbarre & Hazleton Railroad Company, with headquarters at Hazleton, Pa.

Mr. F. A. Wilkinson, assistant superintendent of tracks of the Worcester (Mass.) Consolidated Street Railway, has been appointed superintendent of tracks, succeeding Mr. Rockwood H. Bullock, resigned.

Mr. D. W. Cameron, formerly general manager of the Cambridge Power Light & Traction Company, Cambridge, O., has resigned. He will be succeeded by Mr. J. A. Middleswart, secretary of the company.

Mr. H. B. Twyford, who went from Chicago to London about five years ago to become purchasing agent for the Underground Electric Railways, London, Eng., has resigned and returned to the United States.

Mr. William Busby, whose portrait is presented herewith, was recently elected president of the Choctaw Railway & Lighting Company of McAlester, Okla., succeeding Mr. A. W.



William Busby.

Underwood of Chicago. Having acquired control of the property, Mr. Busby was born 53 years ago in Pemberton, N. J., and later moved to Kansas. In 1895 he became general agent of the coal department of the Choctaw Oklahoma & Gulf Railroad, and after six years with that company engaged in the coal business for himself. He now owns two large coal mines and his principal interests are in that business, although he has been prominently identified with the industrial development of Oklahoma in several other directions. He also controls the McAlester Brick Company and operates the Wilburton Water & Power Company.

Mr. A. H. Walcott, heretofore superintendent of the Blue Hill Street Railway, Canton, Mass., has resigned; effective on February 19. He will be succeeded by Mr. F. T. Buchanan, as announced in our issue of last week.

Mr. Charles L. Rogers, superintendent of the Uxbridge & Blackstone Street Railway at Uxbridge, Mass., has been appointed superintendent of the Milford Attleboro & Woonsocket Street Railway, succeeding Mr. E. A. Potter, resigned.

Mr. W. C. Crawford of Tilbury, Ont., has been elected first vice-president of the Windsor Essex & Lake Shore Rapid Railway of Windsor, Ont., and Mr. C. Magee of Ottawa, Ont., has been elected second vice-president. Mr. W. R. Phillimore of Chatham, Ont., has been elected treasurer to succeed Mr. Crawford.

Mr. R. W. King, who succeeded Mr. Joseph Colvin as superintendent of the Washington Alexandria & Mt. Vernon Railway, Washington, D. C., as announced in the Electric Railway Review of February 22, has been appointed general manager of the company, effective on March 4. Mr. P. E. Cliff, who has been assistant superintendent and master mechanic of the company for a number of years, has been made superintendent, succeeding Mr. Colvin.

Mr. R. W. Shepherd has been appointed auditor of the Portland Railway Light & Power Company, with headquarters at Portland, Ore., a position which recently was created by the retirement of Mr. Samuel G. Reed, treasurer, and the consolidation of the offices of secretary and treasurer of the company under Mr. Charles M. Huggins, formerly treasurer and auditor. Mr. Shepherd was connected for many years with the United Gas Improvement Company of Philadelphia and more recently was auditor and assistant comptroller of the Rhode Island Company at Providence, R. I.

With the recent retirement of Mr. S. W. Huff as general manager of the Virginia Passenger & Power Company, Richmond, Va., that office has been abolished and the following changes have become effective: Mr. C. B. Buchanan, heretofore superintendent of transportation, has been appointed general superintendent of railroads. Mr. George H. Whitfield, mechanical and electrical engineer, has been appointed general superintendent of light and power and will have charge of the power houses, substations and power equipment.

Mr. Thomas Millen, who recently resigned as master mechanic of the New York City Railway, has been in active railroad service for 42 years, principally with steam railroads. In 1894 he was appointed master mechanic of the Metropolitan Street Railway of New York, now operated by the New York City Railway, and held that position until a few days ago, when he retired from railroad service to live on his farm at Sussex, N. J. Mr. Millen was tendered a complimentary banquet on his retirement by his railroad friends and associates, at Shanley's, New York City, at which a large number of prominent railway men were present. Mr. A. C. Tully was toastmaster.

Mr. E. E. Downs, who has been appointed general manager of the Sterling Dixon & Eastern Electric Railway at Dixon, Ill., has had an extensive experience in the construction and operation of electric railroads. Mr. Downs was born in Boston, Mass., and his first business experience was in general contracting and telephone work. When the electrification of street railroads began he became connected with the construction department of the Thomson-Houston Company and had charge of the electrical installation of the Second Avenue Passenger Railway of Pittsburg, the first electric railway to be built in that city. He later had charge of the electrical installation of the Missouri Street Railway of St. Louis; the City Electric Railway of Little Rock, Ark., in which work he was associated with Mr. Bion J. Arnold; the Ft. Clark Street Railway of Peoria, Ill.; and the Ft. Wayne & Belle Isle Railway of Detroit, Mich. He then became manager for the General Electric Company of street railroads in Kalamazoo and Battle Creek, Mich. Later he was associated with his brother and F. N. Rowley in the Michigan Traction Company and the Railways General Company at Battle Creek, building a 10-mile road in less than 60 days. He then went to Indianapolis and had charge of a road under construction between Anderson and Marion, Ind. In 1897 he was engaged by Mr. George J. Kobusch of St. Louis, Mo., as general manager of the Winnebago Traction Company of Oshkosh, Wis. He remained with this company 7½ years as general manager, vice-president and president and constructed several lines in the vicinity of Oshkosh in connection with Clement C. Smith, president of the Columbia Construction Company. In October, 1904, he resigned to go to San Francisco, Cal., representing the banking firm of E. H. Rollins & Son of Boston, where he became general manager of the Petaluma & Santa Rosa Railway, operating 35 miles of interurban railway and a 35-mile steamboat line. In March, 1906, he returned to the east and promoted and partially completed a large amusement park near Philadelphia, known as Beechwood park. He now succeeds Mr. E. B. Kirk, who resigned to become general manager of the Atlantic Shore Line Railway, Portsmouth, N. H.



E. E. Downs.

#### OBITUARY.

William H. Hoover, formerly superintendent and master mechanic of the Lykens & Williams Valley Street Railway at Williamsstown, Pa., died recently.

Charles H. Dalton, who served continuously from January 1, 1894, to October 11, 1906, as chairman of the Boston, Mass., transit commission, died on February 23, aged 82 years.

Josia K. Bougher, formerly president of the Burlington County Railway Company, Mt. Holly, N. J., died recently. Dr. William C. Parry, vice-president of the company, will succeed him.

## Financial News

**Albany & Hudson Railroad, Hudson, N. Y.**—Bondholders have been asked to accept certificates convertible into first mortgage bonds of the company in exchange for their coupons due in 1908 and 1909. The first of the 1908 coupons was due on March 1. The circular states that the company will give one \$1,000 certificate for each \$875 face value of coupons. The company has an authorized bond issue of \$2,000,000, of which \$1,750,000 bonds are outstanding and \$100,000 bonds are in the treasury, having been authorized for betterments and improvements. Application will be made to the New York public service commission, second district, for approval of the issue of the remaining \$150,000 bonds authorized. The plan for refunding the coupons will be operative upon the acceptance of holders of two-thirds of the bonds.

**Anderson (S. C.) Traction Company.**—Edwin W. Robertson of Columbia, S. C., and Robert E. Ligon of Anderson were appointed receivers for this company by Judge Kleugh at Abbeville, S. C., on March 4 on the application of the Anderson Machine & Foundry Company. The indebtedness of the company is stated at \$200,000, including \$163,000 secured by a mortgage.

**Boston & Worcester Street Railway, Boston.**—William M. Butler, who succeeded James F. Shaw as president, is quoted as saying: "I can positively state that there is no truth in the stories that the Boston & Worcester will be sold to the New York New Haven & Hartford Railroad or the Boston Elevated Railway. The company will continue as it has in the past, and I do not look for any changes."

**Camden & Trenton Railway, Camden, N. J.**—The following protective committee, representing holders of the first mortgage bonds, has been organized in Philadelphia: Edward Powell, J. B. Eldridge, Robert Pearsall, Clarence L. Harper and Talcott Williams. The committee urges holders of the bonds to deposit them with the Union Trust Company of Philadelphia not later than April 1. The agreement under which the bonds are to be deposited provides that the committee shall be authorized to foreclose the mortgage and buy in the property; to sell the bonds subject to the right of dissatisfied depositors to withdraw; or to prepare a plan of reorganization which shall be effective if accepted by a majority of the holders.

**Chicago & Milwaukee Electric Railroad.**—Petitions to have A. C. Frost, president of the Chicago & Milwaukee Electric Railroad, declared bankrupt have been filed in the United States district court at Chicago. The petitions charge that the proceedings as a result of which George M. Seward was named receiver for A. C. Frost & Co., were collusive. The petitioners are Justin K. Orvis of Waukegan, Ill. and the Western Bank Note and Engraving Company and the Hartzell-Lord Company of Chicago. Their claims aggregate approximately \$5,600, and they charge that Mr. Frost has committed a long series of acts of bankruptcy, including the agreement whereby Charles G. Dawes was made trustee when the troubles in the Chicago & Milwaukee Electric Railroad were first made public on December 31, 1907.—F. S. Munro has been appointed temporary receiver for the Republic Construction Company by Judge Grosscup of the United States circuit court, who issued a restraining order enjoining creditors from prosecuting suits or interfering with the property of the company.—Judge W. D. Tarrant of Milwaukee appointed the Fidelity Trust Company of that city receiver in Wisconsin for the Chicago & Milwaukee Electric Railway. The receiver was appointed on application of the Columbia Construction Company, which set forth that the company was insolvent and that a receivership was the only course that would enable the company to pay its creditors and save the system to the public. The complaint states that between July 10 and November 21, 1907, the construction company built two miles of track for the railway, the contract price for which was \$57,025. On September 13 the defendant company paid \$16,287 of this amount and on November 21, \$5,000.

**Chicago City Railway.**—The syndicate which owns nearly all of the capital stock has called upon its subscribers to pay 0.8 per cent on the par value of their subscriptions on account of actual expenses and disbursements incurred for syndicate operations.

**Chicago Railways Company.**—The \$2,500,000 of 5 per cent first mortgage bonds offered last week were sold so quickly that the banks which participated in the first offering have offered a second block of \$2,500,000 for sale.

**Delaware River & Atlantic City Railroad.**—Vice-Chancellor Leaming was to have heard arguments at Camden, N. J., on March 9 on the return of a rule to show cause why a receiver should not be appointed for this company. Lewis A. Starr, counsel for minority stockholders, asserted that the petitioner was not a stockholder, and that he had no right to apply for a receiver. William T. Harris, who filed the application in behalf of Charles T. Maloney, filed an affidavit asserting that Mr. Maloney was the owner of 10 shares of stock, but that he had given them into the custody of Walter N. Boyer, Jr., for the purpose of financing the proposed road. Mr. Starr, replying to the allegations of the petition, said that the enterprise had progressed in a satisfactory manner until 1903, when a faction, headed by William J. Thompson, conceived a plan to control the board of directors. This faction voted 112,000 shares at a meeting of the shareholders on October 16 last.

**Exeter Hampton & Amesbury Street Railway, Exeter, N. H.**—The property of this company was sold at foreclosure at Hampton, N. H., on March 10, to Charles Penny of Hartford, Conn., representing a committee of bondholders.

**Indianapolis & Cincinnati Traction Company, Indianapolis, Ind.**—A reorganization agreement has been sent to holders of stocks and bonds for signature. The agreement provides that each subscriber shall transfer his securities to five trustees on or before April 30, to be controlled or disposed of by the trustees in accordance with the terms of the agreement. The trustees named are: Theodore F. Rose and George A. Ball, Muncie; Winfield T. Durbin, Anderson; John J. Appel, Indianapolis; and Claude Cambern, Rushville, Ind. If the owners of all the stock and bonds consent to the agreement, the trustees will have the receivership ended and the indebtedness paid and will raise capital for the extension of the road from Connorsville, Ind., to Hamilton, O. To secure the necessary funds for these purposes, the trustees would be empowered to sell all or part of the bonds. If all of the securities are not deposited under the agreement the trustees are authorized to take such steps as they may deem proper to end the receivership by sale of the property at foreclosure and to become purchasers on behalf of the subscribers to the agreement, provided that the property does not bring a price which the trustees would deem greater than it would be wise to pay. If the trustees acquire the property in this manner, they would organize a new company. The agreement was approved at a recent meeting of holders of the securities, at which more than three-fourths of the capital stock and bonds were represented.

**Interborough Rapid Transit Company, New York.**—Formal application has been made to the New York public service commission, first district, for approval of the execution by this company of a mortgage upon all of its real property and all of its interests as lessee of the rapid transit railroads, derived by assignment from John E. McDonald and the Rapid Transit Subway Construction Company and other property, to secure an issue of not to exceed \$55,000,000 of bonds, to be dated November 1, 1907, and to be payable on November 1, 1952, with interest at a rate to be fixed by the directors from time to time. The bonds are to be subject to purchase at 110 through the operations of a sinking fund of \$300,000 per annum, beginning November 1, 1910. The bonds are also to be subject to payment and cancellation in amounts of not less than \$1,000,000 at 110. The company would set aside not exceeding \$18,000,000 of the bonds for the retirement of \$15,000,000 of 4 per cent notes due on May 1, 1908. For the retirement of \$10,000,000 notes due on March 1, 1910, not exceeding \$12,000,000 of the new bonds would be resecured. The remainder of the bonds would be issued from time to time to pay for construction or acquisition of, or improvements, betterments, additions to, extensions of or in payment for, lines of rapid transit railway in New York and other lines of railway of any character in that city owned or leased by a corporation at least 90 per cent of the stock of which is owned by the Interborough company, or to fund indebtedness of the company, or indebtedness of any other company assumed or guaranteed by the company and contracted for one of these purposes. The company desires to issue \$18,000,000 bonds now for the retirement of the notes maturing in May, and \$12,000,000 additional to fund time and demand loans and accounts payable. These current unsecured obligations were incurred principally for the following purposes: Excess cost of that part of the Brooklyn extension of the subway in operation on December 31, 1907, \$2,624,910; on account of equipment of subway under contracts Numbers 1 and 2 with New York, \$7,727,816; total, \$10,352,726. The mortgage has been authorized by the directors of the company, and a special meeting of stockholders has been called for March 17, 1908, for the purpose of acting upon the proposition to issue the bonds. As it may be necessary to issue promissory notes in extension of the notes due on May 1, and to secure the payment of such notes by the pledge of the \$18,000,000 bonds, the

company also asks the commission to approve the issue by it of not exceeding \$25,000,000 of notes, with interest at not exceeding 6 per cent, secured by the pledge of not exceeding \$30,000,000 face value of the bonds. The statement of cash cost of properties included in the proposed mortgage is given as follows: Value of leases of subway taken at actual amount of cash expended for equipment, and the actual amount for construction, in excess of amount received from City of New York, \$35,752,699; real estate not included in equipment, \$196,814; capital stock of Rapid Transit Subway construction at par, being amount paid in cash, \$6,000,000; stocks and bonds of the following named companies at cash cost to Interborough Rapid Transit Company: Subway Realty Company, \$2,106,266; New York & Queens County Railway, \$2,900,152; New York & Long Island Traction Company, \$744,557; Long Island Electric Railway, \$612,821; total, \$6,363,796; Manhattan Guaranty fund, (which by the agreement under which the gold notes maturing on May 1, 1908, were issued, is appropriated to the security of the gold notes), \$4,057,987; amounts due from companies the stocks of which are included in the mortgage: New York & Queens Company Railway, \$732,000; New York & Long Island Traction Company, \$50,000; Subway Realty Company, \$942,123; total, \$1,724,123—\$54,095,419.

**Louisville (Ky.) Traction Company.**—A special meeting of shareholders will be held on April 15 to vote on the question of issuing \$1,000,000 additional preferred stock, making a total of \$3,500,000 outstanding.

**New Orleans (La.) Railway & Light Company.**—Gross earnings in 1907 were \$6,041,291, of which \$3,987,733 was contributed by the railway department. Operating expenses were \$3,270,397, of which \$2,411,759 was on account of the railway department. Net earnings were \$2,770,894.

**Rochester Syracuse & Eastern Railroad, Syracuse, N. Y.**—A certificate of increase in the capital stock from \$6,000,000 to \$8,500,000 has been filed at Albany.

**Schenectady (N. Y.) Railway.**—A. H. Harris of New York and E. S. Fassett, general manager of the United Traction Company of Albany, have been elected directors.

**United Railroads of San Francisco.**—The following statement, showing the effect upon gross earnings from the strike, has been made public:

Months—	1906.	1907.	Decrease.
June .....	\$448,455	\$152,126	\$296,329
August .....	429,311	317,769	111,542
September .....	425,199	367,220	57,979
November .....	546,166	449,732	96,428
December .....	562,206	481,285	89,915

The Westinghouse Electric & Manufacturing Company has obtained permission from the United States district court in Pittsburg to join with other creditors of the United Railroads of San Francisco in a plan for the adjustment of the railway company's floating indebtedness, amounting to \$3,500,000. While the plan has not been announced, it was reported that it provides for an issue of \$3,500,000 of 6 per cent notes by the United Railways Investment Company, which owns the entire capital stock of the United Railroads, to be secured by \$3,500,000 of 7 per cent first preferred stock of the railroad company, half of the notes to mature in August, 1913, and half in February, 1914.

**ELECTRIC RAILWAY EARNINGS.**

**Galveston-Houston Electric Company.**

December—	1907.	1906.
Gross earnings .....	\$87,668.85	\$81,375.26
Operating expenses and taxes .....	54,430.70	50,444.49
Net earnings .....	33,238.15	30,930.77
Interest charges .....	13,749.89	11,958.34
Balance .....	19,488.26	18,972.43
Bond sinking fund .....	2,608.75	2,537.50
Balance .....	16,879.51	16,434.93

**Savannah (Ga.) Electric Company.**

December—	1907.	1906.
Gross earnings .....	\$53,566.10	\$48,655.54
Operating expenses and taxes .....	39,253.19	32,855.55
Net earnings .....	14,307.91	15,819.99
Interest charges .....	12,391.75	11,300.00
Balance .....	1,916.16	4,519.99
Improvement fund .....	1,666.74	1,666.64
Balance .....	249.42	2,853.35

**Tampa (Fla.) Electric Company.**

December—	1907.	1906.
Gross earnings .....	\$45,895.00	\$41,161.36
Operating expenses and taxes .....	29,510.13	28,967.22
Net earnings .....	16,384.87	12,194.14
Interest charges .....	729.14	680.85
Balance .....	15,655.73	11,513.29

Dallas (Tex.) Electric Corporation and Subsidiary Companies.

December—	1907.	1906.
Gross earnings and income from securities	\$96,630.09	\$89,438.79
Operating expenses and taxes	72,263.87	72,159.00
Net earnings	24,366.22	17,279.79
Interest charges	20,147.08	16,225.00
Balance	4,219.14	1,054.79
Bond sinking fund	3,333.34	3,189.16
Balance	885.80	*2,134.37

\*Deficit.

Northern Texas Traction Company, Ft. Worth, Tex.

December—	1907.	1906.
Gross earnings	\$84,345.88	\$78,750.30
Operating expenses and taxes	49,130.47	47,202.31
Net earnings	35,215.41	31,547.99
Interest charges	9,819.04	10,223.32
Balance	25,396.37	21,324.67

El Paso (Tex.) Electric Company.

December—	1907.	1906.
Gross earnings	\$50,791.35	\$41,575.23
Operating expenses and taxes	35,302.63	31,003.60
Net earnings	15,488.72	10,571.63
Interest charges	5,417.68	4,187.50
Balance	10,071.04	6,384.13

Columbus (Ga.) Electric Company.

December—	1907.	1906.
Gross earnings	\$32,256.06	\$27,613.08
Operating expenses and taxes	14,192.20	12,434.90
Net earnings	18,063.86	15,178.18
Interest charges	10,955.87	9,650.49
Balance	7,557.99	5,527.69
Improvement fund	1,398.32	1,023.36
Balance	6,159.67	4,504.33

Brockton & Plymouth Street Railway, Plymouth, Mass.

December—	1907.	1906.
Gross earnings	\$7,367.90	\$6,943.92
Operating expenses and taxes	7,417.39	5,335.61
Net earnings	*49.49	1,608.31
Interest charges	1,817.66	1,802.10
Balance	*1,867.15	*193.79

\*Deficit.

Puget Sound Electric Railway, Tacoma, Wash.

December—	1907.	1906.
Gross earnings	\$130,575.73	\$113,467.27
Operating expenses and taxes	93,327.94	83,767.38
Net earnings	37,247.79	29,699.89
Interest charges	31,390.42	24,679.17
Balance	5,857.37	5,020.72
Bond sinking fund	5,957.51	7,410.00
Deficit	100.14	2,389.28

Kansas City Railway & Light Company.

January—	1908.	1907.
Gross earnings	\$496,321.33	\$479,021.63
Operating expenses	258,830.84	238,017.74
Net earnings	237,490.49	241,003.89
Taxes and interest	151,277.80	147,519.37
Net income	86,212.69	93,484.52

Twin City Rapid Transit Company.

January—	1908.	1907.
Total earnings	\$469,891.21	\$456,837.38
Operating expense	258,200.90	243,097.42
Net earnings	211,690.31	213,739.96
Deductions	121,955.55	115,258.34
Surplus	89,734.76	98,481.62

Dividends Declared.

Interborough Rapid Transit Company, New York, quarterly, 2 1/4 per cent.

Northern Ohio Traction & Light Co., Akron, O., quarterly, 1/2 of 1 per cent.

Philadelphia Traction Company, 4 per cent.  
Portland (Ore.) Railway Light & Power Co., preferred, quarterly, 1 1/4 per cent.

South Side Elevated Railroad, Chicago, quarterly, 3/4 of 1 per cent.

Twin City Rapid Transit Company, Minneapolis, preferred, quarterly, 1 3/4 per cent.

United Traction & Electric Company, Providence, R. I., quarterly, 1 1/4 per cent.

# Manufactures and Supplies

## ROLLING STOCK.

Sarnia Street Railway, Sarnia, Ont., is reported to be in the market for new rolling stock.

Philadelphia Rapid Transit Company, Philadelphia, Pa., is building eight new double-truck ash cars of a special type in its own shops.

Berlin & Waterloo Street Railway, Berlin, Ont., is having several cars rebuilt by the Preston Car & Coach Company, Limited, Preston, Ont.

Mount Hood Railway & Power Company, Portland, Ore., has ordered 40 flat cars, 60,000 pounds capacity, from the Hicks Locomotive & Car Works.

Chicago Ottawa & Peoria Railway, H. E. Chubbuck, general manager, Ottawa, Ill., has ordered six double-truck cars, 40 feet 10 inches long, from the Danville Car Company.

Illinois Valley Railway, La Salle, Ill., is having six semi-convertible cars, to be used as trailers, built by the Danville Car Company. Delivery is to be made in May. The specifications include the following details:

Seating capacity	.....40 passengers	Height inside	.....8 ft. 6 in.
Wheel base	.....4 ft.	Sill to trolley base	.....8 ft. 10 1/4 in.
Length of body	.....32 ft.	Track to trolley base	.....11 ft. 8 in.
Over vestibule	.....39 ft. 10 in.	Body	.....Semi-steel
Over all	.....40 ft. 10 in.	Underframe	.....Combination
Width inside	.....8 ft. 2 1/2 in.		
Over all	.....9 ft. 2 in.		

## Special Equipment.

Air brakes	.....General Electric	Fenders	.....Co. standard
Bolsters, truck	.....Danville	Hand brakes	.....Peacock
Couplers	.....Tomlinson	Trucks	.....Danville
Curtain material	.....Pantastote		

Quincy Horse Railway & Carrying Company, Quincy, Ill., has ordered eight open center aisle cars and two closed cars from the Danville Car Company. Delivery is to be made in May and August, respectively. The specifications include the following details:

## Open Center Aisle Cars.

Seating capacity	.....40 passengers	Height sill to trolley base	.....8 ft. 1/2 in.
Wheel base	.....8 ft.	Track to trolley base	.....11 ft. 11 in.
Length of body over vestibule	.....29 ft.	Body	.....Wood and metal
Over all	.....30 ft.	Underframe	.....Wood-faced metal
Width inside	.....7 ft. 2 in.		
Over all	.....8 ft. 6 in.		

## Closed Cars.

Seating capacity	.....20 passengers	Height inside	.....8 ft. 4 in.
Wheel base	.....7 ft.	Sill to trolley base	.....8 ft. 10 in.
Length of body	.....18 ft.	Track to trolley base	.....11 ft. 11 in.
Over vestibule	.....28 ft.	Body	.....Metal facing
Over all	.....29 ft. 2 in.	Underframe	.....Wood reinforced
Width inside	.....7 ft.		
Over all	.....8 ft. 4 in.		

## Special Equipment.

Couplers	.....Danville	Gongs	.....Danville
Curtain fixtures	.....Acme	Hand brakes	.....Peacock
Curtain material	.....Pantastote	Headlights	.....Syracuse
Destination signs	.....Hunter illuminated	Motors	.....2 Westinghouse 49
Fenders	.....Co. standard	Trucks	.....Brill

Rochester Syracuse & Eastern Railway, Syracuse, N. Y., was reported in our issue of February 15 as having practically placed its order for two double-truck cars with the Cincinnati Car Company. We are now advised that the order has been placed with The J. G. Brill Company.

## SHOPS AND BUILDINGS.

Denver & Interurban Railroad, Denver, Colo.—On March 10 work was begun on this company's car house at Twenty-third and Market streets, Denver. The building will have a frontage of 168 feet on Market street and 125 feet on Twenty-third street.

## TRADE NOTES.

Ridgway Dynamo & Engine Company, Ridgway, Pa., announces the opening of a district sales office at 907 Andrews



building, Cincinnati, O. George W. Euker, who has had extensive experience in electrical and power plant work, is in charge.

**Raymond Concrete Pile Company** of New York has opened an office in the Arcade building, Philadelphia, in charge of Percy H. Wilson.

**New York Car & Truck Company**, Kingston, N. Y., has had a petition in bankruptcy filed against it. The assets are said to be about \$75,000.

**F. P. Harrison Electric & Manufacturing Company**, 169 South street, New York, has been placed in bankruptcy. The receivers have not yet been appointed.

**Weber Gas Engine Company**, Kansas City, Mo., will furnish a gas engine to supply the power for the new plant of the Page-Storms Forge Company of Springfield, Mass.

**Railway Steel-Spring Company**, New York, at its annual meeting held on March 5 re-elected all the retiring directors. The report for the year ended December 31, 1907, showed net earnings of \$2,320,136.75.

**Taylor & Fenn Company**, Hartford, Conn., is shipping a large order of drill presses to Germany. The company expects to be as busy as ever by April 1, and is looking forward to a large business this season.

**Alfred Box & Co.**, Front and Poplar streets, Philadelphia, have received an order from the New York City Railway for a 20-ton hand power crane to be installed in the substation at Houston street and Broadway.

**Frances A. McIntosh**, formerly with the Standard Tool Company, Cleveland, O., has been appointed advertising manager of the Buffalo Forge Company, Buffalo Steam Pump Company, and George F. Squier Manufacturing Company, all of Buffalo, N. Y.

**Westinghouse Machine Company's** rehabilitation is now assured. The creditors' committee has met with the receivers and agreed to the plan to issue bonds in denomination of \$500 for all indebtedness, other than amounts smaller than \$500, which will be paid in cash.

**Arthur West**, who has been chief engineer of the Westinghouse Machine Company for the past several years, has resigned and on May 1 will become manager of the power department of the Bethlehem Steel Company in charge of manufacturing, engineering and sales.

**Robins Conveying Belt Company** of Passaic, N. J., with a branch office at 52 State street, Boston, is finishing contracts at the Lincoln wharf and Harvard power stations of the Boston Elevated Railway, and at the power station of the United Electric Light Company of Springfield, Mass.

**R. S. Stangland** has been placed in charge of Muralt & Co.'s construction office at New Ft. Lyon, Colo., and will superintend the erection of the complete lighting, heating and power plant which this firm is building for the United States government at the New Ft. Lyon naval hospital.

**American Car & Foundry Company** has declared the regular quarterly dividends of 1 per cent on the common stock and 1½ per cent on the preferred stock, payable on April 1 to stockholders of record March 10. The company's report for the quarter ended January 31 shows net earnings of \$1,772,200.

**F. A. Lawson & Co.**, 209 Monadnock building, San Francisco, Cal., have secured the Pacific coast agency for Dossert & Co.'s solderless cable connectors and terminals and have already placed large orders for Dossert joints. They report great activity in the electrical construction field on the coast.

**Pittsburg Automatic Vise & Tool Company**, Pittsburg, Pa., has opened a branch office in the Dwight building, Kansas City, in charge of E. Metz, Jr. The company has been awarded a contract for complete finishing equipment for vises for the new plant of the Schoen Steel Wheel Company at Newlay, Yorkshire, England.

**Berger Manufacturing Company**, Canton, O., elected the following officers for the ensuing year: E. A. Langenbach, president and general manager; Fred Snyder, first vice-president; R. H. Yancey, second vice-president; C. A. Irwin, secretary and general superintendent; Frank A. Schwertner, treasurer; and C. W. Kreig, assistant treasurer and auditor.

**James F. Shaw & Co., Incorporated**, electric railway builder, Boston, Mass., on March 2 was placed in the hands of Arthur D. Hill of Boston as receiver. This action was taken upon the petition of a creditor and of the company also. The liabilities are \$709,976, while the assets, which are not readily negotiable, are said to be \$880,000. The company has issued a statement that the legal proceedings were instituted to

prevent disadvantageous sale of securities held as collateral by its creditors, and expressing confidence that a proper handling of the affairs will result in full payment of all creditors.

**American Brake Shoe & Foundry Company**, Mahwah, N. J., has made arrangements with the Illinois Valley Railway, La Salle, Ill., Galesburg Railway & Light Co., Galesburg, Ill., Quincy Horse Railway & Carrying Company, Quincy, Ill., and the Wichita Railroad & Light Company, Wichita, Kan., for the standardization of these companies' brakeshoes as adopted by the American Street & Interurban Railway Association.

**Flexible Compound Company**, 3607 Haverford avenue, Philadelphia, has appointed the following agents for its flexible compound for waterproofing and general protective purposes: Timms, Cress & Co., Portland, Ore.; S. P. Holmes & Co., Chicago; J. G. Chadwick & Co., Lakewood, near Cleveland, O.; D. R. Whitaker, 72 Park place, New York; F. A. Barbey, Boston, Mass.; Howard R. Justice, London, Eng.

**Protective Tread Company**, Boston, Mass., has invented a new tread which will be placed upon the market at some future date. The tread consists of rubber vulcanized into a steel base, and promises to revolutionize all other inventions of this class. At the present time only 50 feet have been manufactured. A part of this has been placed in one of the elevators at 53 State street, Boston, and after hard usage does not as yet show the indentation of the steel through the rubber covering.

**Electric Cable Company**, 17 Battery place, New York, whose plant at Bridgeport, Conn., was partially destroyed by fire, announces that arrangements have been made which will permit of filling all orders received for its various products, including Voltax, the transparent protective compound, rubber covered wires, weatherproof wires and cables, magnet wires, annunciator and office wire, etc. Pending adjustment of insurance details, the company will make no announcement of its plans for rebuilding.

**The American Street and Interurban Railway Manufacturers' Association**, through its executive committee, at a meeting held by that committee in New York on March 6, elected two vice-presidents in accordance with the recently adopted amendment to the by-laws. Charles C. Peirce was elected vice-president in charge of entertainment, and K. D. Hequembourg vice-president in charge of exhibits. Both of the newly elected vice-presidents were given authority to select their own assistants. J. H. McGraw was elected chairman of the committee on conference to discuss matters of mutual concern with the American association. Messrs. Elliott, president of the Manufacturers' association, C. C. Peirce and Arthur Partridge were chosen as a subcommittee to visit Denver with the representatives of the American association in connection with the investigations that are to be made relative to the selection of the place for holding the next annual convention.

#### ADVERTISING LITERATURE.

**Universal Stone Crusher Company**, Cedar Rapids, Ia.—An attractive catalogue illustrates and describes the Velten system of concrete machinery.

**Raymond Concrete Pile Company**, New York, N. Y.—An article on concrete pile foundations has been reprinted in pamphlet form, fully illustrated.

**Expanded Metal & Corrugated Bar Company**, St. Louis, Mo.—A mailing card of unique design directs attention to this company's corrugated bars for reinforced concrete construction.

**Disc Grader & Plow Company**, Hunter, N. D.—An attractive illustrated booklet sets forth the advantages of the rotary disc plowing attachment for elevating graders manufactured by this company. The device is especially adapted for railway grading.

**Railway Specialty & Supply Company**, Chicago, Ill.—Bulletin S-128 illustrates and describes the ideal ground plate designed for use in connection with signal systems. It emphasizes the important relation of efficient ground connection to the proper protection of signal apparatus.

**Westinghouse Traction Brake Company**, Pittsburg, Pa.—A reprint of a paper entitled "Magnetic Brakes," and presented by A. L. C. Fell before the Tramways and Light Railways Association, in London, England, has been prepared for distribution in neat pamphlet form. A number of explanatory tables and diagrams are included.

**Allis-Chalmers Company**, Milwaukee, Wis.—Recently issued publications include a 32-page bulletin, No. 1508, de-

vented to the electrically operated air brake.—Bulletin No. 1050 contains a complete description of alternating-current generators, water-wheel type, which are adapted to meet the exacting requirements of continuous service in the largest water power plants. A number of such plants are illustrated.

**Railway Steel-Spring Company, 30 Church Street, New York, N. Y.**—A handsome catalogue of 48 pages and cover devoted to the Latrobe tire department is the first tire catalogue issued by this company since its acquisition of the Latrobe plant January 1, 1906. Various products are illustrated by fine halftones and fully described, including weldless forged and rolled locomotive driving tires, tender, truck, car wheel and motor tires, double flanged crane tires, gear rings, weldless wrought steel pipe flanges, etc. Valuable tables and diagrams are features of the book.

**Fibre Conduit Company, Orangeburg, N. Y.**—A series of interesting booklets is being published in attractive form to set forth the advantages of Orangeburg fiber conduit. One, under the title of "Lightness and Economy," demonstrates by picture and text that a laborer easily carries 30 feet of 3-inch conduit in his arms, that a 1-team truck carries over 3,000 feet and that 25,000 feet are loaded in one car of the usual 30,000 pounds capacity. It is stated that in a recent installation of 30 ducts in parallel, one man in the trench, with two helpers, laid 6,500 ducts feet in four hours. Another booklet entitled "Laboratory Tests," contains a detailed report of tests made on Orangeburg fiber conduit by the Electrical Testing Laboratories of New York.

**Western Electric Company, Chicago, Ill.**—This company's 1908 general catalogue, now being distributed, is a substantial cloth-bound volume of 840 pages. The cover is unusually striking in design and color scheme. The catalogue lists all such electrical supplies and apparatus as are constantly in demand, including, of course, those for electric railway use. The arrangement is excellent and a large number of illustrations are used to good advantage. Tables of useful information add much to the catalogue's value for reference purposes, and a comprehensive index makes it easy to locate any desired subject. A series of halftone engravings following the title page depict the company's Chicago Clinton street works, Hawthorne works, New York City works and its branch houses in Philadelphia, St. Louis, St. Paul, San Francisco, Cincinnati, Kansas City, Denver, Pittsburg, Atlanta, Los Angeles and Seattle.

**General Electric Company, Schenectady, N. Y.**—Recently issued bulletins include No. 4566, which describes some new types of tantalum lamps now on the market. These lamps are rated for 40, 50 and 80 watts. The 40 and 50 watt types replace the former 44-watt lamp. The 50-watt lamp will enable stations to maintain their output per lamp the same as with the present 16-candlepower lamp and give the customer 50 per cent increase in the candlepower. An interesting table is given showing the saving secured for 750 hours of service at various loads per kilowatt-hour, which indicates that with the average cost of current to the consumer now in force, the tantalum lamp saves more than twice its cost. Under the heading, "Solution of Illuminating Problems," an interesting outline is given of the best methods of selecting proper units for various conditions.—Bulletin No. 4571 is devoted to the General Electric tungsten lamp for street lighting.

**Green Fuel Economizer Company, Matteawan, N. Y.**—The Book of the Economizer is an interesting and valuable publication containing 160 pages, 6 by 9 inches, fully illustrated with a large number of halftones, line drawings and tables. The book is for all who manage, design or operate steam power plants. It takes up not only the history and merits of the Green fuel economizer, but also such engineering topics as the absorption of heat by different parts of the boiler surface; the relative economy of boiler surface and economizer surface under various conditions, methods of determining the economy of additional heating surface from the load curve; the effects of oil fuel, high steam pressures and superheat on boiler economy; methods of measuring the temperature of flue gases; and reports of various tests of boiler plants containing economizers. The general scope of the book may be inferred from the following chapter headings: "The Economizer and Its Invention, Elementary Theory of the Economizer, Forcing Capacity of Boilers, The Profit from an Economizer, Secondary Advantages of the Economizer, The Economizer in Small Boiler Plants, Calculating the Performance of an Economizer, A Simple Method of Figuring the Saving, Actual Saving Greater than Theoretical Saving, Measuring the Temperature of the Flue Gases, Actual Results Obtained in Economy Tests of Economizers, Design and Construction of the Fuel Economizer, The Waste-Heat Air Heater, The Air Heater and the Economizer in Water Gas Manufacture, Chimneys, Mechanical Draft, Steam and Fan Tables."

#### ERWOOD'S REVERSIBLE ROLLING DOOR.

The advantages attained in the use of doors composed of independent slats of metal each hooked to the other, for closing large openings in roundhouses, shipping platforms, wagon ways and fire walls, core and drying ovens, etc., are apparent. Such doors occupy a limited space over the opening and are readily operated by a light chain or automatic fusing link.

Doors of this type have of late years found favor in connection with large core oven and dry kiln work, where a fire-proof and fairly air-tight closure is sufficient.

Core ovens of 20 feet in width at the opening and subjected to the ordinary temperature of such a service have been successfully sealed in this way. In the ordinary rolling shutter the slats are of an S shape, and consequently but one side of this combination is water and dust proof, as is obvious in

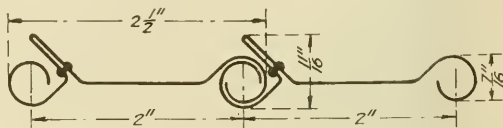

Erwood's Reversible Rolling Door—Section Showing Two Slats.

booking two such shapes into each other, consequently, while it has been the custom to place the weather side outward and thus shield the hinges from the elements and dust, the inside, where the hinge is exposed by the open groove, is subject to rapid wear and corrosion because of the admission of moisture and dirt. The Erwood patented reversible shutter is designed to provide a reversible element with both sides weather-proof. The reverse or inside of the slat or shutter is protected by a shield composed (in this instance) of a portion of the sheet constituting the slat; the shield extends over the opening of the hinge and acts as a watershed or eave. This extends down to the center of the hinge and prevents drip or dust from lodging in the vital part of the shutter. This invention permits of the use of a flat web to the slat, which in rolling occupies less space.

This shutter is the invention of John Erwood, 1604 West Adams street, Chicago.

#### THE PROFIT FROM AN ECONOMIZER.

The following paragraphs are taken from a book on economizer practice recently issued by the Green Fuel Economizer Company, Matteawan, N. Y.:

The profit from an economizer due to the heat saving is the value of fuel saved, labor saved and steaming capacity gained above the interest on the first cost plus the cost of upkeep. The fuel saving can be calculated beforehand. Theoretically, that is, considering only the heat contributed directly by the economizer, it amounts to nearly 1 per cent of fuel for each 11 degrees that the water is raised in temperature by the economizer, since to make steam at 100 pounds pressure from feedwater at 60 degrees F., for instance, requires 1,137 British thermal units.

Fuel records taken before and after putting in Green fuel economizers often show savings as high as 1 per cent of coal for each 7 or 8 degrees that the feedwater is heated, so that if the rise is 150 degrees, which is not unusual where the boilers and fires are driven at a high rate, the actual saving amounts to about 18 per cent. As Prof. R. C. Carpenter says: "Under usual conditions the economizer will save 12 to 15 per cent of the coal bill each year." There are good reasons for this added economy, since, first, the economizer reduces the rate of driving of the boiler; and, second, the heat saved by the economizer replaces an equivalent amount of heat from coal on the grate, and, as a result of the lower rate of burning, better combustion and better furnace efficiency are obtained—especially where the furnace has previously been overdriven. The economizer constitutes additional heating surface that contributes heat without additional fire. The efficiency of the boiler plant is also enhanced by the fact that much of the scale-forming matter in the water is precipitated in the economizer, where it settles in the bottom headers, whence it is washed out more easily than it could be removed after baking onto the boiler tubes.

With the flue gases leaving the boiler at a temperature of 650 degrees F., the economizer may heat the water up to the boiler evaporation point. This temperature of the flue gases implies about 5.8 square feet of surface in the boiler per horsepower developed and is by no means exceptional, since boilers have been sold on ratings of 7 square feet per horsepower and boilers installed on a much more conservative basis are often

brought up to this rating to meet the growth of the business. A boiler of good design will make steam at this rate without priming, but not economically, as the high flue temperature indicates. Good economy requires either more boiler surface or a Green fuel economizer.

The maximum possible saving by an economizer is based upon the assumption that the construction of the economizer units fits for the generation of steam but that it may be allowed to do all the work of heating the water up to the boiler evaporating temperature. In a certain plant tested, the boiler pressure was 95 pounds, the corresponding temperature of evaporation being 334 degrees F. The temperature of the feedwater entering the economizer was 162.5 degrees, so that it was theoretically possible for the economizer to contribute 334 minus 162.5=171.5 British thermal units. The number of thermal units required for the actual evaporation of water at 95 pounds is 877 degrees. The total work done on the water is therefore 887.9 plus 171.5=1,049.4 heat units, of which 171.5 constitutes 16.3 per cent, or the maximum proportion of the work that could be done by the economizer receiving water at 162.5 degrees, which was the actual temperature, the water in this case coming from an open heater where it had been warmed by the exhaust of the pumps and certain other auxiliary apparatus.

**COMPRESSION ROLLER SASH FIXTURE.**

The Edwards compression roller and anti-rattler for window sash, which is extensively used on steam and electric coaches, steamships, ferry boats and office buildings, is shown in the accompanying illustration in operative position, with the sash or casing broken away to admit of an unobstructed view. The device is designed to hold the sash firmly against the outside stop casing, keeping out the cold air and preventing rattling, and has met with success, some hundreds of cars having been equipped with it during the last three years. In



Compression Roller Sash Fixture.

severe climates it has proved to increase greatly the comfort of passengers. It has recently been installed on ferry boats operating in New York harbor and is being made standard after a series of successful tests, and we are advised that the United States government has adopted the device on all light-house tenders, to be used in connection with the Edwards bevel bolt sash lock and bevel notch stop bar. The President's yacht, the "Mayflower," has also been equipped with these fixtures, as well as several other boats belonging to the government.

The O. M. Edwards Company, Syracuse, N. Y., is the manufacturer of this device.

**LARGE GALVANIZED STEEL POLES FOR TRANSMISSION WORK.**

The Great Western Power Company, of California, has adopted the "Milliken pole" for use in carrying its high voltage power transmission line. The power is transmitted on two circuits of three wires each, carrying current at 100,000 volts pressure. In view of this high voltage and the extreme length of lines, eventually 1,000 miles, great care was exercised in designing the poles.

The pole is designed with three crossarms, it being intended to carry a feed wire on the outer end of each crossarm by suspended insulation. The top of the pole is arranged to carry a guard or ground wire. The poles will be set about 750 feet apart.



Galvanized Steel Pole.

The bottom of the lowest crossarm is 51 feet 2 inches above the ground level, and the second crossarm is 10 feet above the first, and the third crossarm is 10 feet above the second. The extreme top of the pole carrying a guard wire is 5 feet 1 inch above the bottom of the highest crossarm. The wires are to be 17 feet 1 inch from each other in a horizontal plane for the two upper crossarms, and 18 feet 1 inch for the lowest crossarm; thus making all feed wires 6 feet 5 inches from the nearest part of the pole proper measured in a horizontal direction.

The bottom of the pole at the ground level occupies a base 17 feet square. The stub ends of the pole, i. e., the portion of the pole in the ground, are separate pieces of steel and are of such length as to allow of 6 feet for bedding in the ground.

These poles are constructed entirely of structural steel shapes and are designed to follow the theoretical stresses and

produce a pole of given strength and stiffness, with a minimum amount of material. There are a great many duplicate pieces, thus making it a simple matter for the purchaser to assemble them in the field.

Very complete and careful tests of the strength of these poles were made before their regular manufacture was started. The test pole was erected in a vertical position on an immovable concrete foundation. The strains were applied by means of weights hanging from a fixed structure, and the amount of load and deflection was easily determined. The pole was designed to stand the following tests:

When tested in a vertical position, on an immovable foundation, and with a proper margin of safety a simultaneous horizontal side pull of 1,000 pounds at the top and 2,500 pounds at each of the three crossarms, or in other words, a total strain of 8,500 pounds the crossarms were to support a suspended weight of 1,000 pounds at their extreme ends and any one of the crossarms to carry at one of these ends a horizontal pull along the direction of the line of 3,000 pounds.

The Receivers of Milliken Bros. (Inc.), 11 Broadway, New York City, are manufacturing these poles at Milliken, Staten Island, N. Y., where complete arrangements have been made in the bridge and structural shops for getting out this particular class of structural work.

As all of this material (except bolts and nuts) is galvanized by the hot process before shipment, and after all the shop work has been done, there has been added to the Milliken plant a large galvanizing department for doing this particular work. In fact, it is said that it has the largest hot galvanizing bath ever constructed. This bath is capable of taking pieces somewhat over 30 feet in length at a single dipping, which is a decided improvement over the old-fashioned method of dip-

ping long pieces one end at a time. The facilities are very complete in this plant for turning out large quantities of this class of work quickly.

#### NEW FOUNDRY OF THE AMERICAN BRAKE SHOE & FOUNDRY COMPANY AT CHATTANOOGA, TENN.

The American Brake Shoe & Foundry Company has plants for the manufacture of brakeshoes at Mahwah, N. J., Bloomfield, N. J., Cummings, N. J., Buffalo, Detroit, Chicago, Chicago Heights, St. Paul, St. Louis, Denver, Birmingham, Atlanta and Chattanooga, and recently has built a new foundry at Chattanooga, the general plan of which is shown in the accompanying engraving. The old plant at Chattanooga had a capacity of 50 tons daily, while the new plant has a capacity of 100 tons. The new foundry was planned and built under the direction of Elmer P. Snow, general superintendent of the American Brake Shoe & Foundry Company at Mahwah, N. J., and is operated under the superintendence of E. D. Herron.

The main foundry building is 100 by 350 feet. The roof is supported on wooden posts set on concrete column bases. The walls below the windows are brick and the rest of the structure is of wood and glass, the windows extending clear to the roof plate. The machine and pattern shop is 40 by 60 feet, the offices and storeroom is 40 by 60 feet and the core room, on the west side of the shop, is 25 by 60 feet. A large shipping platform at one end of the foundry is built on a level with the floors of box cars and provides means for loading the product at little expense. A 100-ton track scale is used for weighing the raw material as it enters the works. A com-

#### THE FIRE AND WATER RESISTING QUALITIES OF ELECTRICAL MACHINERY.

Electrical apparatus, when constructed in accordance with the best engineering practice, is well-nigh indestructible if subjected only to the ordinary amount of wear and tear, and often comes out with flying colors from the devastating reign of floods and fires. The few incidents quoted below are excellent examples of the amount of hard usage that well constructed electrical apparatus will survive, and still be in working condition.

In the Knights Deep Mine, near Johannesburg, South Africa, there were installed thirty-six 15-kilowatt transformers and twelve three-phase, 50 horsepower G.E. induction motors for operating the mine pumps. Through a peculiar combination of circumstances, the mine was allowed to fill with water, the motors and transformers remaining under several hundred feet of water for over two years.

When taken out three of the motors were rewound in the local repair shop. The others were simply dried out and then soaked in oil. Contrary to all expectations and to the surprise of all concerned the insulation was found to be in excellent condition, and the motors were put into service, apparently none the worse for their high-pressure bath. The transformers were treated in the same manner and shortly afterward they replaced several transformers of English make which had burned out only a short time after being installed.

A railway power station, situated near the Mississippi river, experienced a severe flood during the season of high water. Two 1,500-kilowatt 6,000-volt generators were more than half under water for nearly a week, but when dried out carried their load without giving any trouble whatever. In

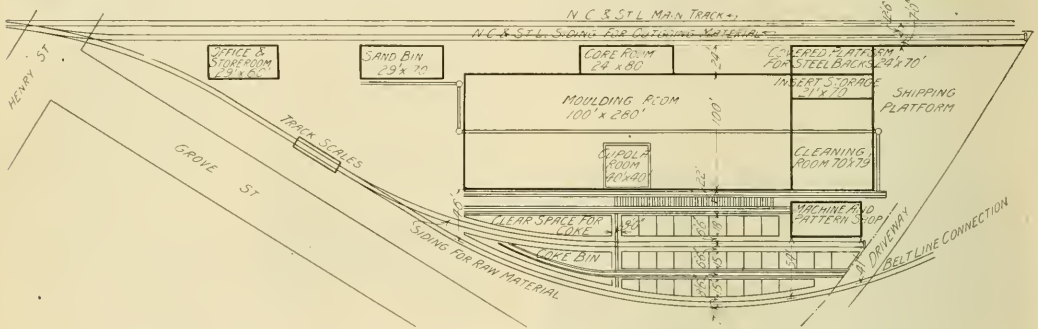

Foundry of the American Brake Shoe & Foundry Company at Chattanooga, Tenn.—General Plan.

plete bin system is used for storing the different kinds of metal for the cupolas. These bins are in three rows of 11 each and are 16 feet square and 10 feet deep.

Material is transferred about the plant on cars operating over depressed tracks; these cars are fitted with ball-bearing trucks, so that one man can push a load of 4,000 pounds. A ladle and truck running on a narrow-gauge track, parallel with the main building, is used to transfer metal from the cupolas to sully ladles which are used for pouring the molds. The central transfer track in the foundry continues into the cleaning room, so that the products move directly from the molding room to the cleaning room. There are two cupolas of the Calumet type, the large one being 60 by 72 inches and the smaller one 48 by 60 inches. The molding is done entirely by machines and all the machinery is driven by electric motors, the power for which is furnished by the Chattanooga Electric Company. This company also supplies current for the arc lights.

The charging of the cupolas is done by means of chutes by which the metal is delivered into the cupola at small expense. The equipment in the cleaning room consists of 10 large tumbling barrels fitted with steel stays, a row of barrels being placed on each side of the central track, and the product is delivered to these barrels from cars standing on the tracks. The brakeshoes, after being cleaned, are delivered on small cars to the shipping platform. The principal product of the plant is locomotive brakeshoes and car brakeshoes with steel backs.

Railway connection is provided with the Nashville Chattanooga & St. Louis and the Chattanooga Belt Line. The coke supply comes from the Durham Coal & Coke Company, 16 miles south of Chattanooga. The cost of the new plant was about \$45,000, which does not include considerable equipment which was brought over from the old shop.

fact the first machine to be dried out carried the entire railway load until the second machine could be put into condition.

A 3-horsepower induction motor was taken from the ruins of the printing office of The Democrat, Ellsworth, Me., some few days after the entire building had been destroyed by fire. After being freed from the protecting coat of ice and cinders, the motor was dried and cleaned. When connected to the circuit it ran as smoothly as when first installed. Some idea of the intensity of the heat to which the motor was subjected may be gained from the fact that the switchboard and instruments were completely destroyed.

A G.E. 20-horsepower 550-volt three-phase induction motor, installed in a leather warehouse in Salem, Mass., was subjected to a severe ordeal during a fire. After the building and its contents had been deluged with water the motor was removed, and after being cleaned, dried and fitted with another pulley started immediately on application of the current. The motor has since carried its rated load and does not appear to be damaged in any way except as to appearance.

Another excellent example of the durability of the induction motor was shown by the remarkable performance of a G.E. 5-horsepower motor which was used in driving a pump in the G. H. Perry Company's quarry in South Dakota. The motor was often allowed to run without any attention over night, especially during the rainy season. One night a heavy rainstorm filled the quarry to such a height that the motor was half under water. When started the next morning it picked up its load and carried it steadily until the pit was emptied of water. On examination it was found to be none the worse for its prolonged bath, although a new pulley had to be put on in place of the old one, which was softened and warped out of shape.

# The Moore Track Drill

does not interfere with traffic!

The shifting of one lever and a few seconds' time takes down the drill—the operation reversed makes it ready for work again.

This is only one of the many strong points about the Moore Track Drill that make it worth buying.

*Ask for descriptive catalogue.*

**Kalamazoo Railway Supply Co.** Kalamazoo Michigan

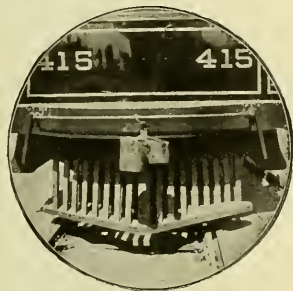
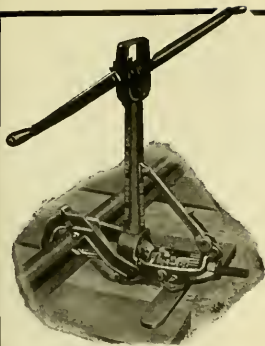

## Washburn Standard M. C. B. Coupler

Coupled or uncoupled from either side and on curved track as easily and safely as on straight track. The result is that

- trains may be operated in from two to six units each
- movement is safe around short curves of city streets
- freight cars are handled satisfactorily, and
- interchange is facilitated with steam roads.

*Our 112-page catalog of traction devices sent free for the asking.*

**Washburn Steel Castings & Coupler Co., Minneapolis, Minn.**

Western Agents: Tweedy, Hood & Finlen, 2014 Fisher Bldg., Chicago  
Canadian Agent: John Taylor, Montreal

17

# You can lease a Portable Bonding Car

and do bonding and rebonding by the modern methods of

## Electric Brazing and Copper Welding

at an approximate labor cost of installation of 12 cents per bond.

No other method within reaching distance of this cost can produce results equal to or even approaching ours for perfect conductivity and long life.

*Proof is yours for the asking.*

**THE ELECTRIC RAILWAY IMPROVEMENT COMPANY**  
6005 Carnegie Avenue CLEVELAND, OHIO

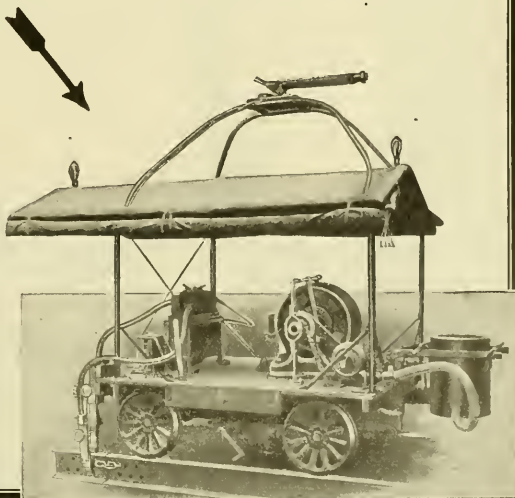

## THE J. G. BRILL COMPANY, PHILADELPHIA, PA.

AMERICAN CAR COMPANY, ST. LOUIS, MO.  
 G. C. KUHLMAN CAR COMPANY, CLEVELAND, OHIO  
 JOHN STEPHENSON COMPANY, ELIZABETH, N. J.  
 WASON MANUFACTURING CO. SPRINGFIELD, MASS.

MAIN OFFICE: PHILADELPHIA, PA.  
 LONDON OFFICE: 110 CANNON ST. E.C.  
 PACIFIC COAST AGENTS: PIERSON  
 ROEDING & CO., SAN. FRANCISCO.  
 AUSTRALIAN AGENTS: NOYES  
 BROTHERS, SYDNEY. CABLES:  
 "BRILL," PHILA., "AXLES" LONDON.

*CARS TRUCKS SEATS RATTAN SPRINGS SPECIALTIES SUPPLIES*

## FOR HIGH EFFICIENCY

The centrifugal pump is used in fire engines because it is the simplest and most effective means of producing pressure. It is used in the Brill power sprinkler for the same reason. The centrifugal pump is operated by a direct-connected motor (both located on the platform at one end of the car) and supplies pressure for distributing the water uniformly over fifty feet of roadway on each side of the track. The pump shaft has the only wearing surface in the entire mechanism, so no trouble is caused by heated parts. The amount and direction of the water is always under perfect control by the patented type of sprinkling head employed. Write for catalog.

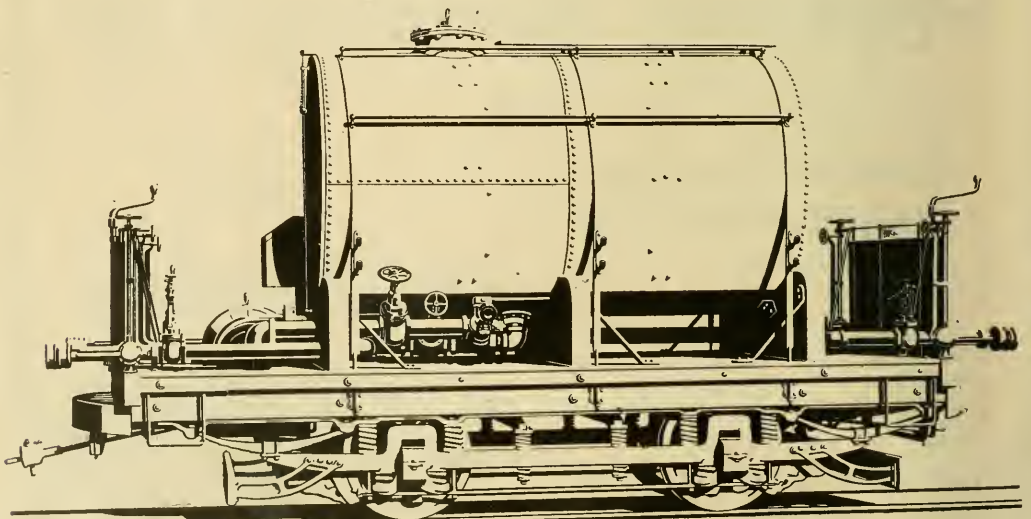

*THE BRILL CENTRIFUGAL SPRINKLER (PATENTED)*



## *General Electric Company*

### Lightning Arresters

relieve electrical systems from excessive voltages incident to lightning discharges, line surges, and other line disturbances.

¶ Its arresters are the result of the most thorough scientific and practical investigation of high-voltage phenomena ever undertaken, and arresters have been standardized for all conditions ordinarily arising in the commercial operation of lighting and power systems.

¶ If you will state your conditions, the General Electric Company stands ready to offer you the assistance of its engineers, who will advise you the best type of arrester to be used on your system.

¶ Large stocks of standard arresters are carried to meet all ordinary conditions, and ample manufacturing facilities permit the prompt shipment of special arresters to meet unusual conditions.

Principal Office :

**Schenectady, N. Y.**

CHICAGO OFFICE: MONADNOCK BLDG.

Sales Offices in All Large Cities



There are other steel measuring tapes  
—but none so reliable and absolutely accurate as those made by  
**THE LUFKIN RULE CO.** New York  
London, England  
Windsor, Canada  
SACINAW, MICH, U. S. A.

“Phono-Electric” Trolley Wire insures permanent, reliable, efficient service in your overhead construction.  
Write for our “Red Booklet.” Mailed free.  
BRIDGEPORT BRASS COMPANY  
253 Broadway, New York  
Mills: Bridgeport, Conn.



**HOPE TAPES AND WEBBINGS**  
ARE THE BEST  
WRITE FOR SAMPLES AND PRICES  
**HOPE WEBBING CO., Providence, R. I.**

The Recording Fare Register Company  
New Haven, Conn.



**WAKEFIELD CAR SEATS**  
We make everything necessary to seat a car of any description. Our line includes Reversible seats of both the Slideover and Turuover types for Steam and Electric service, as well as the only practical Double Revolving seat on the market.  
Our Longitudinal Spring Seating is unexcelled for superiority of workmanship and durability.  
We also carry a large variety of Rattan Chairs for Parlor and Observation Cars.  
**Heywood Brothers & Wakefield Company**  
New York, N. Y. Wakefield, Mass.



**Pantasote**  
The National Standard for Car Curtains and Car Upholstery.  
**AGOSOTE HEADLINING**  
The only headlining made in one solid piece. Will not separate, warp or blister. Waterproof and homogeneous.  
**THE PANTASOTE COMPANY**  
707 Fisher Building, Chicago, Ill. 11 Broadway, New York

**THE SYMINGTON JOURNAL BOX IS NOW STANDARD ON 95 PER CENT OF ALL MODERN ELECTRIC TRUCKS**

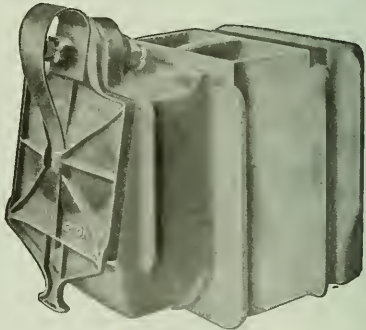
**Special Notice!** WE ARE PREPARED TO FURNISH AT ONCE **REPAIR BOXES** FOR ANY MAKE OF TRUCK IN SERVICE

**BALTIMORE MD. THE T. H. SYMINGTON CO. CHICAGO ILL.**



# Electric Railway Review

PUBLISHED EVERY SATURDAY.

FORMERLY THE STREET RAILWAY REVIEW.

THE WILSON COMPANY, CHICAGO.

160 Harrison Street, Chicago  
150 Nassau Street, New York  
1329 Williamson Bldg., Cleveland

VOL. XIX  
No. 12

CHICAGO, MARCH 21, 1908

Whole No.  
236

Subscription: Domestic . . . \$2  
Foreign . . . \$5  
Canada . . . \$3.50

## You read this page every week

Everybody does, every time—couldn't miss it if they wanted to. An advertisement here is the most emphatic thing in the whole traction field and an inexpensive means of commanding attention.

---

**You may buy this page for one week  
at a cost of less than two cents per paper**

---

Think of it—for less than the price of a postage stamp your message will be placed before an up-to-date and progressive traction man, where he cannot help seeing it and where he will read it if you have something interesting to tell. ¶ This offer is conditioned upon your advertisement appearing in all the papers of the issue selected. More than 5,000 copies are printed every week, but just to make it even money we'll call it 5,000, thus fixing the cost of the page at \$100.

We know the traction field thoroughly, but we don't know where or how you can get so much advertising value for so small an expenditure. ¶ Let us have an order now, please, to reserve the particular issue you would like to use. We will co-operate to the fullest extent in making the advertisement of the greatest possible value to you.

---

**Electric Railway Review** 160 Harrison Street  
CHICAGO, U. S. A.

*Spring Storms are a menace to Generators, Motors and Transformers*



# Garton-Daniels Lightning Arresters Protect Them

¶ Economy in operation demands a rigid protection of apparatus. ¶ Now, before spring storms come on, a careful inspection of your Lightning Arresters may later save big repair bills. ¶ A proper equipment of operative, efficient arresters will prevent all but the most insignificant losses. ¶ Garton-Daniels Arresters of the improved type have shown

a wonderful record for the past four years. ¶ Our new bulletin will soon be ready for distribution. Drop us a line and we will send you a copy, so that you can pick out the style that you will need.

## ELECTRIC SERVICE SUPPLIES Co.

Railway Material & Electrical Supplies

MAYER & ENGLUND DEPT.  
PHILADELPHIA  
NEW YORK

GARTON-DANIELS DEPT.  
KEOKUK  
PITTSBURG SAINT LOUIS

PORTER & BERG DEPT.  
CHICAGO  
ATLANTA

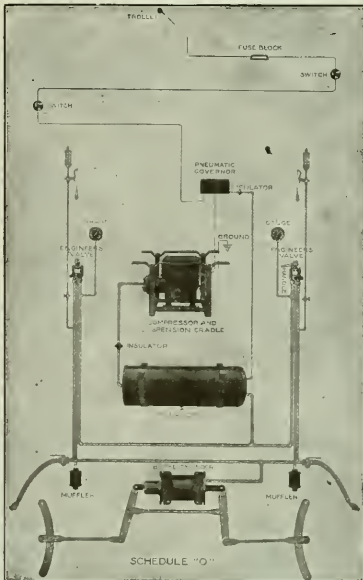

Diagram of National Straight Air Brake Equipment for Double End Motor Car.

# NATIONAL Air Brakes

¶ The accompanying illustration shows the National Straight Air Brake equipment for single-car service.

¶ This equipment is recognized as the standard of efficiency, simplicity and reliability.

¶ The careful design and construction of the component parts of the apparatus make "National Air Brakes" the most compact, efficient and serviceable brakes for traction service and permit of a maximum of economy in operation and maintenance.

*Bulletins sent on request.*

## National Brake & Electric Co.

MILWAUKEE, U. S. A.

NEW YORK: 111 Broadway  
PHILADELPHIA: W. H. Gable, 1722  
Westmoreland Street.  
BOSTON: F. E. Dunne, 131 State St.

SAN FRANCISCO, CAL.: W. F. McKenny,  
69-71 First Street.  
LONDON: 14 Great Smith Street, West-  
minster.

General Sales Office: 519 First National Bank Bldg., Chicago

# Westinghouse

## Steam Turbines

### Principle of Operation

The steam chamber consists of a number of graduated steps formed by rings of stationary and rings of moving blades. The stationary blades give direction and velocity to the steam; the moving blades convert the energy and velocity into useful power. The total turning power exerted upon the shaft is due both to the impulse of steam upon the moving blades when entering the chamber and to the reaction when leaving it.

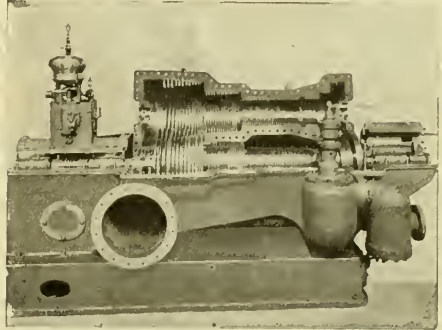

You will know all about Westinghouse Turbines after reading Publication 7002.

## The Westinghouse Machine Co.

Steam Turbines, Steam Engines, Gas Engines, Gas Producers, Storage Batteries and The Roney Stoker

New York, 10 Bridge Street  
 Boston, 131 State Street  
 Atlanta, Candler Building  
 St. Louis, Chemical Building

Pittsburg, Westinghouse Building  
 Cleveland, New England Building  
 Chicago, 171 La Salle Street  
 Cincinnati, Traction Building

Philadelphia, North American Building  
 Denver, McPhee Building  
 San Francisco, Hunt, Mirk & Co.



### The Two Extremes of Service

—high-speed long-distance runs between cities and the frequent stops necessary within city limits—are conditions easily taken care of by

### The Westinghouse "AMM"

automatic brake, which possesses many exceptional features and will operate single cars or trains of cars not to exceed five, giving graduated release, quick recharge, quick service and high pressure in emergency.

A good brake is not merely a necessary expense but a dividend earning asset.

**Westinghouse Traction Brake Co.**  
 PITTSBURG, PA.

## Westinghouse No. 101-B2 Railway Motor

A Modern Motor for Modern Traffic



A double equipment is suitable, under usual conditions, for single- or double-truck cars weighing not over 18,000 lbs. without equipment. A quadruple equipment is best for double-truck cars weighing not to exceed 35,000 lbs. without equipment.

Full particulars in Circular 1089

## Westinghouse Electric & Mfg. Co.

Atlanta	Cincinnati	Kansas City	New York	Salt Lake City
Baltimore	Cleveland	Los Angeles	Philadelphia	San Francisco
Boston	Dallas	Muskegon	Pittsburg	Seattle
Buffalo	Denver	New Orleans	St. Louis	Syracuse
Chicago	Detroit	Mexico: G. & O. Braniff & Co., City of Mexico		

Canada: Canadian Westinghouse Co., Ltd., Hamilton, Ont.

## ALPHABETICAL INDEX TO ADVERTISEMENTS.

Advance Lumber Co.....16	Dossert & Co.....13	Morden Frog & Crossing Wks.16	Standard Brake Shoe Co.....14
Allis-Chalmers Co.....16	Drouvé, G. Co.....13	National Brake & Electric Co. 2	Standard Motor Truck Co.....11
Aluminum Co. of America.....12	Drummond Detective Agency.....2	National Lock Washer Co.....22	Standard Paint Co.....21
American Brake Shoe & Fdry. Co.....13	Eclipse Railway Supply Co.....19	National Pole Co.....16	Standard Steel Works.....18
American Electrical Works.....13	Electric Railway Equipment Co.....13	Naugle Pole & Tie Co.....16	Standard Underground Cable Co.....12
American Frog & Switch Co.....13	Electric Ry. Improvement Co.....22	New York Switch & Crossing Co.....23	Standard Varnish Works.....18
Anderson, Albert & J. M., Mfg. Co.....14	Electric Service Supplies Co.....2	Niles Car & Mfg. Co.....17	Star Brass Works.....18
Armstrong Oiler Co.....14	Engineers and Contractors.....14	Northern Engineering Works-13	Stone & Webster Engineering Corporation.....18
Arnold Company.....13	Fairbanks, Morse & Co.....19	Nuttall, R. D., Co.....15	Stuart-Howland Co.....26
Atlas Anchor Co.....13	Ford, Bacon & Davis.....19	Ohio Brass Co.....5	Symington, T. H., Co.....26
Automatic Trolley Guard Co.14	Galena-Signal Oil Co.....15	Okonite Co., Ltd.....5	Telegraph Signal Co.....15
Babcock & Wilcox Co.....12	General Electric Co.....25	Pacific Coast Pole Co.....16	Trolley Supply Co.....19
Baker, Wm. C., Heating & Supply Co.....17	Green Engineering Co.....25	Pantafote Co.....17	Under-Feed Stoker Co.....18
Baldwin Locomotive Works.13	Green Fuel Economizer Co.....26	Patten, Paul B.....17	U. S. Metal & Mfg. Co.....18
Barbour-Stockwell Co.....13	Griffin Wheel Co.....19	Pay-As-You-Enter Car Co.....9	Van Dorn & Dutton Co.....14
Barnes, G. H., Hardwood Lumber Co.....16	Hagy, J. Milton, Waste Wks.....12	Power Specialty Co.....9	Van Dorn, W. T., Co.....19
Beidler, Francis, & Co.....16	Hale & Kilburn Mfg. Co.....12	Pressed Steel Car Co.....21	Van Valkenburgh, E. C.....19
Beilamy Vestette Mfg. Co.....16	Hartshorn, Stewart, Co.....16	Queen & Co.....21	Wanted and For Sale Cards.....20, 21
Berthold & Jennings.....16	Heine Safety Boiler Co.....16	Rail Joint Co.....18	Washburn Steel Castings & Coupler Co.....22
Blake Signal & Mfg. Co.....16	Heron, W. & Wakefield Co.....19	Railway Specialty & Supply Co.....18	Watson-Stillman Co.....19
Bridgport Brass Co.....16	Holman, D. F., Ry. Tracklayer Co.....19	Recording Fare Register Co.....26	Weston Electric Co.....5
Brill, J. G., Co.....24	Humbird Lumber Co., Ltd.....19	Register, A. L., & Co.....14	Westinghouse Elec. & Mfg. Co.....3
Brown, Harold P.....14	Indestructible Fibre Co.....23	Reiter, G. C., Canton, O.....14	Westinghouse Machine Co.....3
Brown Hoisting Machy. Co.....14	Jewett Car Co.....17	Ridlon, Frank, Co.....20	Westinghouse Traction Brake Co.....3
Buckeye Engine Co.....14	Johann, F. A.....21	Rodger Ballast Car Co.....14	Weston Electrical Instrument Co.....21
Burnham, Williams & Co.....13	Johns-Manville, H. W., Co.....5	Rockford & Interurban Ry. Co.....21	Wharton, Wm. Jr., & Co.....14
Bylesby, H. M., & Co.....18	Kalamazoo Ry. Supply Co.....23	Rooke Automatic Register Co. 21	Wheeler Condenser & Eng'g Co.....14
Central Inspection Bureau.....15	Lindsay Bros. Co.....16	Russell Car & Snow-Plow Co.21	Wheel Truing Brake Shoe Co.....22
Chase-Shawmut Co.....15	Lorain Steel Co.....15	S-E. Missouri Cypress Co.....16	White, J. G., & Co.....14
Chicago Mica Co.....20	Lori & Burnham Co.....21	St. Louis Car Wheel Co.....14	Whitmore Mfg. Co.....20
Churchill Cedar Co.....16	Lufkin Rule Co.....26	St. Louis Surfact & Paint Co.....12	Wilson, J. G., Mfg. Co.....19
Cincinnati Car Co.....17	Lumen Bearing Co.....14	Sanderson & Porter.....14	Woodbury-Carlton Co., W. Co., New York, N. Y.....19
Cleveland Armature Works.....11	Macallen Co.....16	Santon, E.....14	Woodman, R., Mfg. & Supply Co.....16
Cleveland Frog & Cross. Co.....12	McGuire-Cummings Mfg. Co.....16	Shim & Chase Co.....14	Worcester, C. H., Co.....16
Collier, Barron G.....22	Marshall, R. W. & Co.....21	Sheaff & Jastaad.....18	Zelnicer, Walter A., Supply Co.....21
Columbia Construction Co.....15	Meyers, Fred J., Mfg. Co.....16	Simmons, John, Co.....18	
Columbus Ry. & Light Co.....21	Miller Anchor Co.....19	Smith, Peter, Heater Co.....14	
Consolidated Car Fender Co.16	Milroy Electric Co.....19	Speer Carbon Co.....18	
Consolidated Car-Heating Co.24	Model Stoker Co.....14		
Coopers' Supply & Equipment Co.....22			
Cooper Heater Co.....14			
Crane Co.....26			
Craghead Engineering Co.....14			
Curtain Supply Co.....14			
Davis, John, Co.....23			
Dearborn Drug & Chemical Works.....23			

## CLASSIFIED LIST OF ADVERTISERS.

Advertising Designs and Plates. Woodbury-Carlton Co., Worcester, Mass.	Armature Lifts. Electric Service Supplies Co., 200 Plymouth Bldg., Chicago.	Bells and Gongs—Continued. Kuhlman, The G. C., Car Co., Cleveland. McGuire-Cummings Mfg. Co., Chicago.	Brackets and Cross Arms. Anderson, Albert & J. M., Mfg. Co., Boston. Craghead Engineering Co., Cincinnati, O.
Advertising Service. Van Valkenburgh, E. C., 2117 West One Hundred and Second St., Chicago.	Asbestos Materials. Johns-Manville, H. W., Co., New York.	Ohio Brass Co., Mansfield, O. Reiter, G. C., Canton, O. St. Louis Car Co., St. Louis, Mo. Stephenson, John, Co., Elizabeth, N. J. Wason Mfg. Co., Springfield, Mass. Western Electric Co., Chicago.	Electric Railway Equipment Co., Cincinnati, O. Electric Service Supplies Co., 200 Plymouth Bldg., Chicago. Johns-Manville, H. W., Co., New York, N. Y. Lindsay Bros. Co., Spokane, Wash. Ohio Brass Co., Mansfield, O. Ridlon, Frank, Co., 200 Summer St., Boston. Stuart-Howland Co., Boston. Western Electric Co., Chicago.
Advertising, Street Car. Collier, Barron G., Flat Iron Bldg., New York.	Axies—(See Wheels and Axles).	Block System—(See Signals).	Blowers—(See Mechanical Draft)
Air Brakes—(See Brakes and Brake Parts).	Babbitt Metals—(See Alloys and Bearing Metals).	Blue Printing Machines. Buckeye Engine Co., Salem, O.	Boilers. Babcock & Wilcox Co., N. Y. Fairbanks, Morse & Co., Chicago. Green Fuel Economizer Co., Matteawan, N. Y. Heine Safety Boiler Co., 421 Olive St., St. Louis. Lord & Burden, Livingston-Hudson, New York.
Air Compressors—(See Compressors, Air).	Badges and Buttons. Electric Service Supplies Co., 200 Plymouth Bldg., Chicago. Recording Fare Register Co., New Haven, Conn.	Boiler Cleaning Compound. Dearborn Drug & Chemical Works, Chicago. Johns-Manville, H. W., Co., New York.	Boles and Brake Parts. Allis-Chalmers Co., Milwaukee, Wis. American Car Co., St. Louis. Brill, The J. G., Co., Philadelphia. Electric Service Supplies Co., 200 Plymouth Bldg., Chicago. General Electric Co., Schenectady, N. Y. Kuhlman, The G. C., Car Co., Cleveland. McGuire-Cummings Mfg. Co., Chicago. National Brake & Electric Co., Milwaukee. Stephenson, John, Co., Elizabeth, N. J. Wason Mfg. Co., Springfield, Mass. Westinghouse Traction Brake Co., Pittsburg, Pa.
Alloys and Bearing Metals. Brown, H. P., 120 Liberty St., New York. General Electric Co., Schenectady, N. Y. Lumen Bearing Co., Buffalo, N. Y. Ohio Brass Co., Mansfield, O. Ridlon, Frank, Co., 200 Summer St., Boston. St. Louis Car Co., St. Louis, Mo.	Ball Bearings. Symington, T. H., Co., Baltimore, Md.	Bonds, Rail. Brown, H. P., 120 Liberty St., New York. Chase-Shawmut Co., Newburyport, Mass. Electric Railway Improvement Co., Cleveland, O. Electric Service Supplies Co., 200 Plymouth Bldg., Chicago. General Electric Co., Schenectady, N. Y. Kuhlman, The G. C., Car Co., Cleveland. McGuire-Cummings Mfg. Co., Chicago. National Brake & Electric Co., Milwaukee. Stephenson, John, Co., Elizabeth, N. J. Wason Mfg. Co., Springfield, Mass. Westinghouse Traction Brake Co., Pittsburg, Pa.	Brakes and Brake Parts. Allis-Chalmers Co., Milwaukee, Wis. American Car Co., St. Louis. Brill, The J. G., Co., Philadelphia. Electric Service Supplies Co., 200 Plymouth Bldg., Chicago. General Electric Co., Schenectady, N. Y. Kuhlman, The G. C., Car Co., Cleveland. McGuire-Cummings Mfg. Co., Chicago. National Brake & Electric Co., Milwaukee. Stephenson, John, Co., Elizabeth, N. J. Wason Mfg. Co., Springfield, Mass. Westinghouse Traction Brake Co., Pittsburg, Pa.
Aluminum Wire, Etc. Aluminum Co. of America, Pittsburg.	Bases—(See Trolley Poles and Fittings).	Boiler Cleaning Compound. Dearborn Drug & Chemical Works, Chicago. Johns-Manville, H. W., Co., New York.	Brakes and Brake Parts. Allis-Chalmers Co., Milwaukee, Wis. American Car Co., St. Louis. Brill, The J. G., Co., Philadelphia. Electric Service Supplies Co., 200 Plymouth Bldg., Chicago. General Electric Co., Schenectady, N. Y. Kuhlman, The G. C., Car Co., Cleveland. McGuire-Cummings Mfg. Co., Chicago. National Brake & Electric Co., Milwaukee. Stephenson, John, Co., Elizabeth, N. J. Wason Mfg. Co., Springfield, Mass. Westinghouse Traction Brake Co., Pittsburg, Pa.
Anchor. Atlas Anchor Co., Cleveland, O. Electric Service Supplies Co., 200 Plymouth Bldg., Chicago. Miller Anchor Co., Norwalk, O. Ohio Brass Co., Mansfield, O.	Bearings. Electric Service Supplies Co., 200 Plymouth Bldg., Chicago. General Electric Co., Schenectady, N. Y. Lumen Bearing Co., Buffalo, N. Y. McGuire-Cummings Mfg. Co., Chicago. Marshall, R. W., & Co., 95 Liberty St., New York. Nuttall, R. D., Co., Pittsburg. Ohio Brass Co., Mansfield, O. Ridlon, Frank, Co., 200 Summer St., Boston. Symington, T. H., Co., Baltimore, Md. Van Dorn & Dutton Co., Cleveland, O.	Bells and Gongs. American Car Co., St. Louis. Brill, The J. G., Co., Philadelphia. Electric Service Supplies Co., 1020-24 Filbert St., Phila.	Brakes and Brake Parts. Allis-Chalmers Co., Milwaukee, Wis. American Car Co., St. Louis. Brill, The J. G., Co., Philadelphia. Electric Service Supplies Co., 200 Plymouth Bldg., Chicago. General Electric Co., Schenectady, N. Y. Kuhlman, The G. C., Car Co., Cleveland. McGuire-Cummings Mfg. Co., Chicago. National Brake & Electric Co., Milwaukee. Stephenson, John, Co., Elizabeth, N. J. Wason Mfg. Co., Springfield, Mass. Westinghouse Traction Brake Co., Pittsburg, Pa.
Armatures and Coils, Winding and Repairing. Cleveland Armature Works, Cleveland, O. Electric Service Supplies Co., 200 Plymouth Bldg., Chicago. General Electric Co., Schenectady, N. Y. Marshall, R. W., & Co., 95 Liberty St., New York. Ridlon, Frank, Co., 200 Summer St., Boston. Stuart-Howland Co., Boston.	Bells and Gongs. American Car Co., St. Louis. Brill, The J. G., Co., Philadelphia. Electric Service Supplies Co., 1020-24 Filbert St., Phila.		Brakes and Brake Parts. Allis-Chalmers Co., Milwaukee, Wis. American Car Co., St. Louis. Brill, The J. G., Co., Philadelphia. Electric Service Supplies Co., 200 Plymouth Bldg., Chicago. General Electric Co., Schenectady, N. Y. Kuhlman, The G. C., Car Co., Cleveland. McGuire-Cummings Mfg. Co., Chicago. National Brake & Electric Co., Milwaukee. Stephenson, John, Co., Elizabeth, N. J. Wason Mfg. Co., Springfield, Mass. Westinghouse Traction Brake Co., Pittsburg, Pa.



# Don't Take Chances!

You should know that good insulation is like good insurance—it pays.



insulated electric railway line material will positively insure your lines against insulation troubles.

WRITE FOR BULLETIN TODAY

## J-M Asbestos Roofing

**"The Cheapest-per-Year"**  
because its first cost is the only cost

It is the only prepared roofing requiring no preservative coating. Ordinary roofings require coating every year or two and rapidly deteriorate.

### FIGURE IT OUT!

	J-M ASBESTOS ROOFING	ORDINARY ROOFING
First cost of one hundred squares	\$500.00	\$500.00
Cost of coating every two years	000.00	375.00
for ten years.....	000.00	150.00
Deterioration.....	—	—
	\$500.00	\$825.00

On the basis of ten years' service, J-M ASBESTOS ROOFING costs only \$5.00 against \$8.25 per square for ordinary roofing. In other words, ordinary roofings cost \$3.25 per square more than J-M ASBESTOS ROOFING, or over 60 per cent more. It will pay you to investigate J-M ASBESTOS ROOFING.

Write nearest Branch for samples and catalog.

## H. W. JOHNS-MANVILLE CO.



- |              |             |               |
|--------------|-------------|---------------|
| NEW YORK     | PITTSBURG   | MINNEAPOLIS   |
| MILWAUKEE    | CLEVELAND   | SAN FRANCISCO |
| CHICAGO      | BUFFALO     | LOS ANGELES   |
| BOSTON       | BALTIMORE   | SEATTLE       |
| PHILADELPHIA | NEW ORLEANS | DALLAS        |
| ST. LOUIS    | KANSAS CITY | LONDON        |

728



Tamping and Digging Bar. Catalog No. 2975

Pole Shave—Extra Heavy Blade,  
1 1/4 in. wide, finely tempered steel.  
Catalog No. 8774.

## Track and Line Construction Tools

SPRING CONSTRUCTION IS AT HAND  
ORDER NOW AND SAVE DELAYS

We have a carefully selected stock of track and line construction tools. All are of the very best quality, HEAVIER and MORE DURABLE than tools ordinarily supplied.

For Complete List see Catalog No. 7, pages 455 to 520.

Socket Framing Chisel—A very serviceable tool and a keen cutter.  
Catalog No. 5255

Insulated side cutting Pliers.  
Catalog No. 5282

# THE OHIO BRASS COMPANY

Telegraph Shovel. Cat. No. 1777  
NEW YORK, 43-49 Exchange Place  
CHICAGO, 321 Dearborn Street

MANSFIELD, OHIO

PIERSON, ROEDING & Co., San Francisco, Los Angeles, Seattle.

St. Louis, 10 N. 4th Street  
BIRT GELLATLY, 336 4th Ave., Pittsburgh

Telegraph Spoon. Cat. No. 1775

## CLASSIFIED LIST OF ADVERTISERS—Continued.

- Brakeshoes—Continued.  
Marshall, R. W., & Co., 95 Liberty St., New York.  
St. Louis Car Co., St. Louis, Mo.  
Standard Brake Shoe Co., Aurora, Ill.  
Stephenson, John, Co., Elizabeth, N. J.  
Wason Mfg. Co., Springfield, Mass.  
Wharton, Wm., Jr., & Co., Philadelphia.  
Wheel Truing Brake Shoe Co., Detroit.
- Bridges.  
Johann, F. A., 1624 Pierce Bldg., St. Louis.
- Bridge Timbers.  
Beldler, Francis, & Co., Chgo.
- Bushes, Motor and Dynamo.  
Electric Service Supplies Co., 200 Plymouth Bldg., Chicago.  
General Electric Co., Schenectady, N. Y.  
Ridlon, Frank, Co., 200 Summer St., Boston.  
Speer Carbon Co., St. Marys, Pa.
- Bumpers, Car.  
American Car Co., St. Louis.  
Brill, The J. G., Co., Philadelphia.  
Kuhlman, The G. C., Car Co., Cleveland.  
St. Louis Car Co., St. Louis, Mo.  
Stephenson, John, Co., Elizabeth, N. J.  
Wason Mfg. Co., Springfield, Mass.
- Car House Doors.  
Wilson, J. G., Mfg. Co., New York.
- Car Replacers.  
Electric Service Supplies Co., 200 Plymouth Bldg., Chicago.  
Fairbanks, Morse & Co., Chgo. Kalamazoo Railway Supply Co., Kalamazoo, Mich.  
Ohio Brass Co., Mansfield, O.  
U. S. Metal & Mfg. Co., 25 Broad St., New York.
- Car Roof Paint, Canvas.  
St. Louis Surfact & Paint Co., St. Louis, Mo.
- Car Seats.  
American Car Co., St. Louis.  
Brill, The J. G., Co., Philadelphia.  
Hale & Kilburn Mfg. Co., Philadelphia.  
Heywood Bros. & Wakefield Co., Wakefield, Mass.  
Kuhlman, The G. C., Car Co., Cleveland.  
St. Louis Car Co., St. Louis, Mo.  
Stephenson, John, Co., Elizabeth, N. J.  
Wason Mfg. Co., Springfield, Mass.
- Car Signs—(See Signs, Cars and Track).
- Car Steps.  
Electric Service Supplies Co., 200 Plymouth Bldg., Chicago.
- Car Trimmings—(See Trimmings, Car).
- Cars, Ballast.  
Rodger Ballast Car Co., Chgo. St. Louis Car Co., St. Louis, Mo.
- Cars, Dump.  
Fairbanks, Morse & Co., Chgo. Rodger Ballast Car Co., Chgo. Russell Car & Snow-Plow Co., Ridgway, Pa.  
St. Louis Car Co., St. Louis, Mo.
- Cars, Passenger and Freight.  
American Car Co., St. Louis.  
Brill, The J. G., Co., Philadelphia.  
Cincinnati Car Co., Cincinnati.  
Detroit Carbulding & Equipment Co., Detroit, Mich.  
Electric Railway Improvement Co., Cleveland, O.  
Fairbanks, Morse & Co., Chgo. Jewett Car Co., Newark, O.  
Johann, F. A., 1624 Pierce Bldg., St. Louis.  
Kuhlman, The G. C., Car Co., Cleveland.  
McQuire-Cummings Mfg. Co., Chicago.  
Niles Car & Mfg. Co., Niles, O.
- Cars, Passenger and Freight—Continued.  
Pressed Steel Car Co., Pittsburg.  
Rodger Ballast Car Co., Chgo. Russell Car & Snow-Plow Co., Ridgway, Pa.  
St. Louis Car Co., St. Louis, Mo.  
Standard Motor Truck Co., Pittsburg.  
Stephenson, John, Co., Elizabeth, N. J.  
Wason Mfg. Co., Springfield, Mass.
- Cars, Pay-As-You-Enter.  
Pay-As-You-Enter Car Co., 26 Cortlandt St., New York.
- Cars, Rebuilt.  
Detroit Carbulding & Equipment Co., Detroit, Mich.
- Cars, Second-Hand.  
Detroit Carbulding & Equipment Co., Detroit, Mich.  
Marshall, R. W., & Co., 95 Liberty St., New York.  
Zelnicker, Walter A., Supply Co., St. Louis.
- Cars, Steel.  
Pressed Steel Car Co., Pittsburg.  
St. Louis Car Co., St. Louis, Mo.  
Standard Motor Truck Co., Pittsburg.
- Castings, Brass.  
Star Brass Works, Kalamazoo, Mich.
- Castings, Iron and Steel.  
American Brake Shoe & Foundry Co., Mahwah, N. J.  
Green Engineering Co., Com'l Nat. Bk. Bldg., Chicago.  
Lorain Steel Co., Johnstown, Pa.
- National Brake & Electric Co., Milwaukee.  
Washburn Steel Castings & Coupler Co., Minneapolis.
- Catchers—(See Trolley Retrievers and Catchers).
- Cattle Guards.  
Fairbanks, Morse & Co., Chgo.
- Circuit-Breakers.  
Electric Service Supplies Co., 200 Plymouth Bldg., Chicago.  
General Electric Co., Schenectady, N. Y.  
Western Electric Co., Chicago.
- Coal Handling Machinery—(See Conveyors).
- Coils—(See Armatures and Coils).
- Commutators and Parts.  
Cleveland Armature Works, Cleveland.  
Electric Service Supplies Co., 1020-24 Filbert St., Phila.  
General Electric Co., Schenectady, N. Y.  
Marshall, R. W., & Co., 95 Liberty St., New York.  
Ohio Brass Co., Mansfield, O.  
Stuart-Howland Co., Boston.
- Compressors, Air.  
Fairbanks, Morse & Co., Chgo. General Electric Co., Schenectady, N. Y.  
National Brake & Electric Co., Milwaukee.  
Westinghouse Traction Brake Co., Pittsburg.
- Concrete Mixers.  
Contractors' Supply & Equip. Co., Chicago.
- Condensers.  
Wheeler Condenser & Engineering Co., Carteret, N. J.
- Condults.  
Electric Service Supplies Co., 200 Plymouth Bldg., Chicago.  
Western Electric Co., Chicago.
- Connectors, Soliderless.  
Dossert & Co., 242 W. Forty-first St., New York.
- Contractors.  
Arnold Company, 181 La Salle St., Chicago.  
Byllesby, H. M., Co., Am. Trust Bldg., Chicago.  
Columbia Construction Co., Milwaukee, Wis.  
Creshead Engineering Co., Cincinnati, O.
- Contractors—Continued.  
Green Engineering Co., Com'l Nat. Bk. Bldg., Chicago.  
Register, A. L., & Co., 112 N. Broad St., Philadelphia.  
Sanderson & Porter, 62 William St., New York.  
Saxton, E., 841 Biadensons, Washington, D. C.  
Sheaff & Jaastad, 88 Broad St., Boston.  
Stone & Webster Engineering Co., Boston.  
Wharton, Wm., Jr., & Co., Philadelphia.  
White, J. G., & Co., 49 Exchange Pl., New York.
- Controllers and Attachments.  
Electric Service Supplies Co., 200 Plymouth Bldg., Chicago.  
General Electric Co., Schenectady, N. Y.  
Johns-Manville, H. W., Co., New York.  
Marshall, R. W., & Co., 95 Liberty St., New York.  
Western Electric Co., Chicago.  
Westinghouse Electric & Mfg. Co., Pittsburg.
- Conveyors and Coal Handling Machinery.  
Green Engineering Co., Com'l Nat. Bk. Bldg., Chicago.  
Northern Engineering Works, Detroit, Mich.
- Cord, Bell and Trolley.  
American Car Co., St. Louis.  
Brill, The J. G., Co., Philadelphia.  
Electric Service Supplies Co., 1020-24 Filbert St., Phila.  
Kuhlman, The G. C., Car Co., Cleveland.  
St. Louis Car Co., St. Louis, Mo.  
Stephenson, John, Co., Elizabeth, N. J.  
Stuart-Howland Co., Boston.  
Wason Mfg. Co., Springfield, Mass.
- Couplers, Car.  
American Car Co., St. Louis.  
Brill, The J. G., Co., Philadelphia.  
Kuhlman, The G. C., Car Co., Cleveland.  
McQuire-Cummings Mfg. Co., Chicago.  
Ohio Brass Co., Mansfield, O.  
St. Louis Car Co., St. Louis, Mo.  
Stephenson, John, Co., Elizabeth, N. J.  
Van Dorn, W. T., Co., Paulina St., Chicago.  
Washburn Steel Castings & Coupler Co., Minneapolis.  
Wason Mfg. Co., Springfield, Mass.
- Couplers, Car.  
American Car Co., St. Louis.  
Brill, The J. G., Co., Philadelphia.  
Kuhlman, The G. C., Car Co., Cleveland.  
McQuire-Cummings Mfg. Co., Chicago.  
Ohio Brass Co., Mansfield, O.  
St. Louis Car Co., St. Louis, Mo.  
Stephenson, John, Co., Elizabeth, N. J.  
Van Dorn, W. T., Co., Paulina St., Chicago.  
Washburn Steel Castings & Coupler Co., Minneapolis.  
Wason Mfg. Co., Springfield, Mass.
- Coverings, Pipe and Boiler.  
Johns-Manville, H. W., Co., New York.
- Cranes, Hoists and Lifts.  
American Car Co., St. Louis.  
Brill, The J. G., Co., Philadelphia.  
Brown, Hoisting Machinery Co., Cleveland, O.  
Kuhlman, The G. C., Car Co., Cleveland.  
Northern Engineering Works, Detroit, Mich.  
Railway Specialty & Supply Co., Chicago.  
Stephenson, John, Co., Elizabeth, N. J.  
Van Dorn & Dutton Co., Cleveland, O.  
Wason Mfg. Co., Springfield, Mass.
- Cross Arms—(See Brackets and Cross Arms).
- Crossing Gates—(See Gates and Guards).
- Crossings, Track—(See Switches).
- Curtains, Fixtures and Materials—Continued.  
American Car Co., St. Louis.  
Brill, The J. G., Co., Philadelphia.  
Curtain Supply Co., 93 Ohio St., Chicago.  
Electric Service Supplies Co., 200 Plymouth Bldg., Chicago.  
Hartsborn, Stewart, Co., East New York, N. Y.  
Kuhlman, The G. C., Car Co., Cleveland.  
Marshall, R. W., & Co., 95 Liberty St., New York.  
National Lock Washer Co., Newark, N. J.
- Curtains, Fixtures and Materials—Continued.  
Pantastote Co., 11 Broadway, New York.  
St. Louis Car Co., St. Louis, Mo.  
Stephenson, John, Co., Elizabeth, N. J.  
Wason Mfg. Co., Springfield, Mass.
- Cylinder Oil.  
Power Specialty Co., 111 Broadway, N. Y.
- Derailing Devices.  
American Frog & Switch Co., Hamilton, O.  
Cleveland Frog & Crossing Co., Cleveland, O.
- Detective Agency.  
Drummond Detective Agency, New York.
- Doors and Fixtures.  
American Car Co., St. Louis.  
Brill, The J. G., Co., Philadelphia.  
Kuhlman, The G. C., Car Co., Cleveland.  
St. Louis Car Co., St. Louis, Mo.  
Stephenson, John, Co., Elizabeth, N. J.  
Wason Mfg. Co., Springfield, Mass.
- Doors, Steel Rolling.  
Wilson, J. G., Mfg. Co., New York.
- Draft, Mechanical—(See Mechanical Draft).
- Draft Rigging.  
Van Dorn, W. T., Co., Chgo. Washburn Steel Castings & Coupler Co., Minneapolis.
- Drills, Track.  
Brown, H. P., 120 Liberty St., New York.  
Electric Service Supplies Co., 200 Plymouth Bldg., Chicago.  
Fairbanks, Morse & Co., Chgo. Kalamazoo Railway Supply Co., Kalamazoo, Mich.  
Marshall, R. W., & Co., 95 Liberty St., New York.  
Ridlon, Frank, Co., 200 Summer St., Boston.
- Drying Appliances.  
Green Fuel Economizer Co., Matteawan, N. Y.
- Dynamos and Generators.  
Cleveland Armature Works, Cleveland.  
Fairbanks, Morse & Co., Chgo. General Electric Co., Schenectady, N. Y.  
National Brake & Electric Co., Milwaukee, Wis.  
Western Electric Co., Chicago.  
Westinghouse Electric & Mfg. Co., Pittsburg, Pa.
- Economizers, Fuel.  
Green Fuel Economizer Co., Matteawan, N. Y.
- Electric Instruments.  
Electric Service Supplies Co., 200 Plymouth Bldg., Chicago.  
General Electric Co., Schenectady, N. Y.  
Johns-Manville, H. W., Co., New York.  
Queen & Co., Philadelphia.  
Western Electric Co., Chicago.  
Westinghouse Electric & Mfg. Co., Pittsburg, Pa.  
Weston Electrical Instrument Co., Newark, N. J.
- Electric Railway Supplies, General.  
Cleveland Armature Works, Cleveland, O.  
Creshead Engineering Co., Cincinnati, O.  
Electric Service Supplies Co., 200 Plymouth Bldg., Chicago.  
Fairbanks, Morse & Co., Chgo. General Electric Co., Schenectady, N. Y.  
Johns-Manville, H. W., Co., New York.  
Marshall, R. W., & Co., 95 Liberty St., New York.  
Ohio Brass Co., Mansfield, O.  
Stuart-Howland Co., Boston.  
Western Electric Co., Chicago.

# ST. LOUIS CAR CO. ST. LOUIS-MO.



## St. Louis Car Company's Semi-Convertible Type

The illustration represents one of the cars recently shipped by us to the Houston Electric Company, Houston, Texas.

These cars are of our own design—a practically perfect Semi-Convertible type. Both lower and upper sashes raise into the roof. They move easily and when in the roof pockets are securely fastened, with no possible danger of falling and injuring passengers.

### Our construction of the Semi-Convertible Car is the very best that has yet been devised

These Houston cars are 28' over corner posts and 31' 6" over all. Width over arm rail, 8' 6". They are finished with very handsomely figured mahogany, provided with curtains at each window and each door opening and have the St. Louis Car Company's latest improved "Walkover" seat.

The cars are mounted on St. Louis Car Company's No. 47 Short Wheel Base Truck, which has been adopted as standard in a great many of the larger cities. The channel-iron and steel construction of the "Robertson type" permits the arm rail of the car to be placed very low and adds much to the appearance.

*Photographs, Blue Prints and Specifications will be mailed upon request.*

## CLASSIFIED LIST OF ADVERTISERS—Continued.

- Enamels.**  
Acme White Lead & Color Works, Detroit, Mich.  
St. Louis Surface & Paint Co., St. Louis, Mo.
- Engine Apparatus.**  
Green Fuel Economizer Co., Matteswan, N. Y.
- Engineers and Contractors.**  
Arnold Company, Chicago.  
Byllesby, H. M., & Co., Chgo.  
Columbia Construction Co., Milwaukee, Wis.  
Ford, Bacon & Davis, New York.  
Register, A. L., & Co., Philadelphia.  
Sanderson & Porter, New York.  
Saxton, E., Washington, D. C.  
Sheaff & Jaastad, Boston.  
Stone & Webster Eng. Corporation, Boston.  
White, J. G., & Co., New York.
- Engines, Gas and Oil.**  
Buckeye Engine Co., Salem, O.  
Fairbanks, Morse & Co., Chgo.  
Westinghouse Machine Co., Pittsburg.
- Engines, Hoisting.**  
Fairbanks, Morse & Co., Chgo.
- Engines, Steam.**  
Buckeye Engine Co., Salem, O.  
Westinghouse Machine Co., Pittsburg.
- Fans, Exhaust and Ventilating.**  
General Electric Co., Schenectady, N. Y.  
Green Fuel Economizer Co., Matteswan, N. Y.  
Western Electric Co., Chicago.  
Westinghouse Elec. & Mfg. Co., Pittsburg.
- Fare Boxes—(See Electric Railway Supplies).**
- Fare Registers and Register Fittings.**  
Electric Service Supplies Co., 200 Plymouth Bldg., Chicago.  
Recording Fare Register Co., New Haven, Conn.  
Rooke Automatic Register Co., Providence, R. I.
- Feedwater Apparatus.**  
Green Fuel Economizer Co., Matteswan, N. Y.  
Wheeler Condenser & Engineering Co., Carteret, N. J.
- Feed Wire—(See Wire and Cables).**
- Fenders and Guards.**  
Consolidated Car Fender Co., Providence, R. I.  
Eclipse Railway Supply Co., Cleveland, O.  
Electric Service Supplies Co., 1020-24 Filbert St., Phila.  
McGuire-Cummings Mfg. Co., Chicago.  
Marshall, R. W., & Co., 95 Liberty St., New York.
- Flangers, Snow.**  
McGuire-Cummings Mfg. Co., Chicago.  
Ohio Brass Co., Mansfield, O.  
Kalamazoo Railway Supply Co., Kalamazoo, Mich.  
Van Dorn & Dutton Co., Cleveland, O.
- Frogs—(See Switches, Frogs and Crossings).**
- Fuel Economizers—(See Economizers, Fuel).**
- Fuses and Fuse Devices.**  
Chase-Shawmut Co., Newburyport, Mass.  
Electric Service Supplies Co., 200 Plymouth Bldg., Chicago.  
General Electric Co., Schenectady, N. Y.  
Johns-Manville, H. W., Co., New York.  
Western Electric Co., Chicago.  
Westinghouse Elec. & Manufacturing Co., Pittsburg.
- Gaskets, Bronze.**  
Power Specialty Co., 111 Broadway, New York.
- Gates and Guards.**  
Kalamazoo Railway Supply Co., Kalamazoo, Mich.
- Gear Cases.**  
Electric Service Supplies Co., 200 Plymouth Bldg., Chicago.  
General Electric Co., Schenectady, N. Y.  
Marshall, R. W., & Co., 95 Liberty St., New York.
- Gears and Pinions.**  
Electric Service Supplies Co., 200 Plymouth Bldg., Chicago.  
General Electric Co., Schenectady, N. Y.  
Marshall, R. W., & Co., 95 Liberty St., New York.  
Nuttall, R. D., Co., Pittsburg.  
Van Dorn & Dutton Co., Cleveland, O.
- Generators—(See Dynamos).**
- Gongs—(See Bells and Gongs).**
- Graphite Paint—(See Paint).**
- Grates, Chain.**  
Green Engineering Co., Com'l Nat. Bk. Bldg., Chicago.
- Grease—(See Lubricants).**
- Grinders.**  
Harold P., 120 Liberty St., New York.
- Ground Connection Clamps.**  
Chase-Shawmut Co., Newburyport, Mass.
- Guy Anchors—(See Anchors).**
- Harps, Trolley—(See Trolley Poles and Fittings).**
- Headlights.**  
Electric Service Supplies Co., 200 Plymouth Bldg., Chicago.  
Fairbanks, Morse & Co., Chgo.  
General Electric Co., Schenectady, N. Y.  
Ridlon, Frank Co., 200 Summer St., Boston.  
St. Louis Car Co., St. Louis, Mo.  
Stuart-Howland Co., Boston.  
Trolley Supply Co., Canton, O.
- Headlinings, Passenger Car.**  
Indestructible Fibre Co., 45 Broadway, New York.
- Heaters, Car, Electric.**  
Consolidated Car-Heating Co., Albany, N. Y.  
Johns-Manville, H. W., Co., New York.
- Heaters, Car, Hot Water, and Stoves.**  
Baker, The Wm. C., Heating & Sup. Co., New York.  
Cooper Heater Co., The, Dayton, O.  
Electric Service Supplies Co., 1020-24 Filbert St., Phila.  
McGuire-Cummings Mfg. Co., Chicago.  
Smith, Peter, Heater Co., Detroit, Mich.
- Heating and Ventilating Apparatus—(See Mech. Draft).**
- Hoists—(See Cranes, Hoists and Lifts).**
- Hose Bridges.**  
Ohio Brass Co., Mansfield, O.
- Hydraulic Machinery.**  
Watson Stillman Co., 26 Cortlandt St., New York.
- Inspection.**  
Central Inspection Bureau.
- Inspection Cars, Gasoline.**  
Stover Motor Car Co., Freeport, Ill.
- Instruments, Measuring and Testing—(See Electrical Instruments).**
- Insulating Tapes.**  
General Electric Co., Schenectady, N. Y.  
Johns-Manville, H. W., Co., New York, N. Y.  
Okonite Co., Ltd., 253 Broadway, New York.  
Western Electric Co., Chicago.
- Insulations and Insulating Material.**  
Anderson, A. & J. M., Mfg. Co., Boston.  
Creaghead Engineering Co., Cincinnati, O.  
Electric Railway Equipment Co., Cincinnati, O.  
Electric Service Supplies Co., 200 Plymouth Bldg., Chicago.  
General Electric Co., Schenectady, N. Y.  
Johns-Manville, H. W., Co., New York.  
MacCallen, The, Co., Boston.  
Ohio Brass Co., Mansfield, O.  
Okonite Co., Ltd., 253 Broadway, New York.  
Ridlon, Frank Co., 200 Summer St., Boston.  
Standard Paint Co., 100 William St., New York.  
Standard Varnish Works, New York.  
Stuart-Howland Co., Boston.  
Western Electric Co., Chicago.
- Jacks.**  
American Car Co., St. Louis.  
Brill, The J. G., Co., Philadelphia.  
Electric Service Supplies Co., 200 Plymouth Bldg., Chicago.  
Fairbanks, Morse & Co., Chgo.  
Kalamazoo Railway Supply Co., Kalamazoo, Mich.  
Kuhlman, The G. C., Car Co., Cleveland.  
Marshall, R. W., & Co., 95 Liberty St., New York.  
Morden Frog & Crossing Co., Chicago.  
Stephenson, John, Co., Elizabeth, N. J.  
Wason Mfg. Co., Springfield, Mass.  
Watson-Stillman Co., 26 Cortlandt St., New York.
- Joints, Expansion—(See Steam Fittings).**
- Joints, Rail.**  
Rail Joint Co., 29 W. 34th St., New York.
- Joints, Welded—(See Rail Joints, Welded).**
- Journal Boxes.**  
American Car Co., St. Louis.  
Brill, The J. G., Co., Philadelphia.  
Kuhlman, The G. C., Car Co., Cleveland.  
McGuire-Cummings Mfg. Co., Chicago.  
St. Louis Car Co., St. Louis, Mo.  
Stephenson, John, Co., Elizabeth, N. J.  
Symington, T. H., Co., Baltimore, Md.  
Wason Mfg. Co., Springfield, Mass.
- Journal Lubricators—(See Lubricators).**
- Journal Packing, Steel Wool.**  
Robertson, Wm., & Co., Fifth Floor Great Northern Bldg., Chicago.
- Lamps, Arc and Incandescent.**  
Anderson, A. & J. M., Mfg. Co., Boston.  
Electric Service Supplies Co., 200 Plymouth Bldg., Chicago.  
General Electric Co., Schenectady, N. Y.  
Ridlon, Frank Co., 200 Summer St., Boston.  
Stuart-Howland Co., Boston.  
Western Electric Co., Chicago.  
Westinghouse Electric & Mfg. Co., Pittsburg, Pa.
- Lamp Sockets.**  
Electric Service Supplies Co., 200 Plymouth Bldg., Chicago.  
General Electric Co., Schenectady, N. Y.  
Johns-Manville, H. W., Co., New York, N. Y.
- Lantern Globes.**  
Railway Specialty & Supply Co., Chicago.
- Lifting Magnets.**  
Porter Mfg. Co., 29 Griswold St., Detroit, Mich.
- Lifts—(See Cranes, Hoist and Lift).**
- Lightning Arresters.**  
Electric Service Supplies Co., 200 Plymouth Bldg., Chicago.  
General Electric Co., Schenectady, N. Y.  
Stuart-Howland Co., Boston.  
Western Electric Co., Chicago.  
Westinghouse Elec. & Manufacturing Co., Pittsburg.
- Line Material.**  
Anderson, A. & J. M., Mfg. Co., Boston.  
Creaghead Engineering Co., Cincinnati, O.  
Johns-Manville, H. W., Co., New York.  
Electric Ry. Equipment Co., Cincinnati, O.  
Electric Service Supplies Co., 200 Plymouth Bldg., Chicago.  
General Electric Co., Schenectady, N. Y.  
MacCallen, The, Co., Boston.  
Marshall, R. W., & Co., 95 Liberty St., New York.  
Recording Fare Register Co., New Haven, Conn.  
Stuart-Howland Co., Boston.  
Western Electric Co., Chicago.
- Lock and Nut Washers.**  
Newark Lock Washer Co., Newark, N. J.
- Lockers, Metal.**  
Electric Service Supplies Co., 200 Plymouth Bldg., Chicago.
- Locomotives.**  
Baldwin Locomotive Works, Philadelphia.  
Johns, F. A., 1624 Pierce Bldg., St. Louis.  
Locomotives, Electric.  
American Car Co., St. Louis.  
Baldwin Locomotive Works, Philadelphia.  
Brill, The J. G., Co., Philadelphia.  
General Electric Co., Schenectady, N. Y.  
Kuhlman, The G. C., Car Co., Cleveland.  
McGuire-Cummings Mfg. Co., Chicago.  
Stephenson, John, Co., Elizabeth, N. J.  
Wason Mfg. Co., Springfield, Mass.  
Westinghouse Elec. & Manufacturing Co., Pittsburg.
- Locomotives, Gasoline.**  
Fairbanks, Morse & Co., Chgo.  
Stover Motor Car Co., Freeport, Ill.
- Lubricants.**  
Deaborn Drug & Chemical Works, Chicago.  
Galena-Signal Oil Co., Franklin, Pa.  
Whitcomb Mfg. Co., Cleveland, O.
- Lumber.**  
Barnes, G. H., Hardwood Lumber Co., St. Louis, Mo.  
Beidler, Francis, & Co., Chgo.  
Berthold & Jennings, St. Louis.  
Lindsay Bros. Co., Spokane, Wash.  
S-E. Missouri Cypress Co., Campbell, Mo.
- Magnets and Solenoids.**  
Porter Mfg. Co., 29 Griswold St., Detroit, Mich.
- Malleable Iron.**  
St. Louis Car Co., St. Louis, Mo.
- Measuring Tapes.**  
Lufkin Rule Co., Saginaw, Mich.
- Mechanical Draft.**  
Green Fuel Economizer Co., Matteswan, N. Y.
- Meters.**  
Johns-Manville, H. W., Co., New York.  
Queen & Co., Philadelphia.  
Weston Electrical Instrument Co., Newark, N. J.
- Mica, Raw and Manufactured.**  
Chicago Mica Co., Valparaiso, Ind.
- Motor Cars, Gasoline.**  
Stover Motor Car Co., Freeport, Ill.



# Operation of your first line with Pay-As-You-Enter Cars

will prepare the way for the  
similar operation of other lines.

The public needs instruction once only regarding the Pay-As-You-Enter plan, for the advantages and benefits are immediately apparent.

This is proved by the recent experience of the Chicago City Railway Company in beginning operation on its second line with Pay-As-You-Enter Cars. A press report says:



"The Chicago City Railway Company on Wednesday of this week placed 100 new Pay-As-You-Enter Cars in service on the Indiana Avenue line. The new service was successful from the start, as most of the passengers have become familiar with the Pay-As-You-Enter system since 125 cars of that type were put in operation on the parallel Cottage Grove Avenue line in November. The company's officials state that the Pay-As-You-Enter Car is no longer regarded as an experiment, but as a complete success."

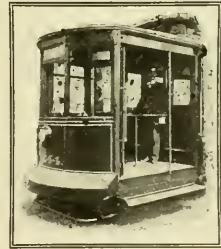

The Pay-As-You-Enter Car succeeds because it is modern, sensible and businesslike, fair to passengers and fair to the company.

We license manufacturers and railways to build and use the Pay-As-You-Enter Car, the patents on which are owned by

## The Pay-As-You-Enter Car Company

DUNCAN McDONALD  
President

26 Cortlandt Street, New York

THOS. W. CASEY  
Manager

## CLASSIFIED LIST OF ADVERTISERS—Continued.

- Motors, Electric.**  
Cleveland Armature Works, Cleveland, O.  
Fairbanks, Morse & Co., Chgo.  
General Electric Co., Schenectady, N. Y.  
National Brake & Electric Co., Milwaukee.  
Western Electric Co., Chicago.  
Westinghouse Elec. & Manufacturing Co., Pittsburg.
- Nut Locks.**  
Chase-Shawmut Co., Newburyport, Mass.  
National Lock Washer Co., Newark, N. J.  
Railway Specialty & Supply Co., Chicago.  
St. Louis Car Co., St. Louis, Mo.  
U. S. Metal & Mfg. Co., 25 Broad St., New York.
- Nuts and Bolts.**  
Lorain Steel Co., Philadelphia.  
National Lock Washer Co., Newark, N. J.  
Railway Specialty & Supply Co., Chicago.
- Oilers.**  
Armstrong Oiler Co., 31st and Chestnut St., Philadelphia.
- Oils—(See Lubricants).**
- Overhead Equipment—(See Electric Railway Supplies).**
- Packings.**  
Electric Service Supplies Co., 200 Plymouth Bldg., Chicago.  
Johns-Manville, H. W., Co., New York.  
Power Specialty Co., 111 Broadway, New York.
- Packing, Steel Wool Journal.**  
Robertson, Wm., & Co., Fifth Floor Great Northern Bldg., Chicago.
- Paints.**  
Standard Paint Co., 100 William St., New York.  
St. Louis Surfer & Paint Co., St. Louis, Mo.
- Pay-As-You-Enter Cars.**  
Pay-As-You-Enter Car Co., 26 Cortland St., New York.
- Pipe Bends and Fittings—(See Steam Fittings).**
- Poles, Metal.**  
Creaghead Engineering Co., Cincinnati, O.  
Electric Railway Equipment Co., Cincinnati, O.  
Electric Service Supplies Co., 200 Plymouth Bldg., Chicago.
- Poles and Ties, Wood.**  
Advances Lumber Co., Cleveland, O.  
Barnes, G. H., Hardwood Lumber Co., St. Louis, Mo.  
Beldier, Francis, & Co., Chgo.  
Berthold & Jennings, St. Louis.  
Churchill Cedar Co., Spokane, Wash.  
Humbird Lumber Co., Sand Point, Idaho.  
Lindsley Bros. Co., Spokane, Wash.  
National Pole Co., Escanaba, Mich.  
Naugle Pole & Tie Co., 226 La Salle St., Chicago.  
Pacific Coast Pole Co., Spokane, Wash.  
S-E. Missouri Cypress Co., Campbell, Mo.  
Worcester, C. H., Co., Tribune Bldg., Chicago.
- Promoters of Railway Projects.**  
Shlmer & Chase Co., Omaha, Neb.
- Punches—(See Ticket Punches).**
- Rail Benders.**  
Electric Service Supplies Co., 200 Plymouth Bldg., Chicago.  
Fairbanks, Morse & Co., Chgo.
- Rail Bonds—(See Bonds, Rail).**
- Rail Bonds, Flexible.**  
Chase-Shawmut Co., Newburyport, Mass.
- Rail Drills—(See Drills, Track).**
- Rail Feed Wire—(See Wire and Cables).**
- Rail Joints and Chairs—(See Joints, Rail).**
- Rail Joints, Welded.**  
Lorain Steel Co., Philadelphia.
- Rails, New.**  
Lorain Steel Co., Philadelphia.  
New York Switch & Crossing Co., Hoboken, N. J.  
Wharton, Wm., Jr., & Co., Philadelphia.
- Rails, Relaying.**  
Zelnicker, Walter A., Supply Co., St. Louis.
- Railway Equipment.**  
Johann, F. A., 1624 Pierce Bldg., St. Louis.
- Railway Velocipedes.**  
Fairbanks Morse & Co., Chgo.  
Kalamazoo Railway Supply Co., Kalamazoo, Mich.
- Registers and Fittings—(See Fare Registers).**
- Relays.**  
Weston Electrical Instrument Co., Newark, N. J.
- Roofing.**  
Johns-Manville, H. W., Co., New York.
- Sand Apparatus.**  
American Car Co., St. Louis.  
Brill, The J. G., Co., Philadelphia.  
Electric Service Supplies Co., 200 Plymouth Bldg., Chicago.  
Kuhlman, The G. C., Car Co., Cleveland.  
Marshall, R. W., & Co., 95 Liberty St., New York.  
Ohio Brass Co., Mansfield, O.  
Ridlon, Frank, Co., 200 Summer St., Boston.  
St. Louis Car Co., St. Louis, Mo.  
Stephenson, John, Co., Elizabeth, N. J.  
Wason Mfg. Co., Springfield, Mass.
- Sash Balances and Fixtures.**  
National Lock Washer Co., Newark, N. J.
- Sash Operating Devices.**  
Drouvé, The G., Co., Bridgeport, Conn.  
Lord & Burnham, Irvington-on-Hudson, New York.
- Seats, Car—(See Car Seats).**
- Shade Rollers—(See Curtains, Fixtures and Materials).**
- Signals.**  
Blake Signal & Manufacturing Co., Boston.  
Telegraph Signal Co., Rochester, N. Y.
- Signal Supplies.**  
Railway Specialty & Supply Co., Chicago.
- Skylights.**  
Drouvé, The G., Co., Bridgeport, Conn.  
Lord & Burnham, Irvington-on-Hudson, New York.
- Snow Plows, Sweepers and Scrapers.**  
American Car Co., St. Louis.  
Brill, The J. G., Co., Philadelphia.  
Kalamazoo Railway Supply Co., Kalamazoo, Mich.  
Kuhlman, The G. C., Car Co., Cleveland.  
McGuire-Cummings Mfg. Co., Chicago.  
Russell Car & Snow-Plow Co., Ridgway, Pa.  
Stephenson, John, Co., Elizabeth, N. J.
- Snow Plows, Sweepers and Scrapers—Continued.**  
Wason Mfg. Co., Springfield, Mass.
- Sockets, Waterproof.**  
Johns-Manville, H. W., Co., New York.
- Solder Paste.**  
Chase-Shawmut Co., Newburyport, Mass.
- Springs.**  
American Car Co., St. Louis.  
Brill, The J. G., Co., Philadelphia.  
Kuhlman, The G. C., Car Co., Cleveland.  
McGuire-Cummings Mfg. Co., Chicago.  
Marshall, R. W., & Co., 95 Liberty St., New York.  
Railway Steel Spring Co., 71 Broadway, New York.  
St. Louis Car Co., St. Louis, Mo.  
Stephenson, John, Co., Elizabeth, N. J.  
Wason Mfg. Co., Springfield, Mass.
- Sprinkling Cars.**  
American Car Co., St. Louis.  
Brill, The J. G., Co., Philadelphia.  
Kuhlman, The G. C., Car Co., Cleveland.  
McGuire-Cummings Mfg. Co., Chicago.  
Stephenson, John, Co., Elizabeth, N. J.  
Wason Mfg. Co., Springfield, Mass.
- Stage Pockets and Plugs.**  
Chase-Shawmut Co., Newburyport, Mass.
- Steam Apparatus.**  
Green Fuel Economizer Co., Matteawan, N. Y.
- Steam Fittings, Etc.**  
Crane Co., Chicago.  
Davis, The John, Co., Chgo.  
Simmons, John, Co., 110 Centre St., New York.  
Power Specialty Co., 111 Broadway, New York.
- Steel Cars.**  
American Car Co., St. Louis.  
Brill, The J. G., Co., Philadelphia.  
Kuhlman, The G. C., Car Co., Cleveland.  
St. Louis Car Co., St. Louis, Mo.  
Stephenson, John, Co., Elizabeth, N. J.  
Wason Mfg. Co., Springfield, Mass.
- Steel Tapes.**  
Lufkin Rule Co., Saginaw, Mich.
- Stokers.**  
Babcock & Wilcox Co., 85 Liberty St., New York.  
Green Engineering Co., Com'l Nat. Bk. Bldg., Chicago.  
Model Stoker Co., Dayton, O.  
Under-Feed Stoker Co. of Am., Chicago.  
Westinghouse Machine Co., Pittsburg.
- Storage Batteries—(See Batteries).**
- "Strike-Breakers."**  
Drummond Detective Agency, 3 Ann St., New York.
- Superheaters.**  
Power Specialty Co., 111 Broadway, New York.
- Switches, Frogs and Crossings.**  
American Frog & Switch Co., Hamilton, O.  
Barbour-Stockwell Co., Cambridgeport, Mass.  
Cleveland Frog & Crossing Co., Cleveland, O.  
Fairbanks, Morse & Co., Chgo.  
Lorain Steel Co., Philadelphia.  
Morden Frog & Crossing Co., Rookery, Chicago.  
New York Switch & Crossing Co., Hoboken, N. J.  
Railway Specialty & Supply Co., Chicago.  
Wharton, Wm., Jr., & Co., Philadelphia.
- Switchboards and Switchboard Instruments.**  
Anderson, A. & J. M., Mfg. Co., Boston.  
Chase-Shawmut Co., Newburyport, Mass.  
General Electric Co., Schenectady, N. Y.  
Western Electric Co., Chicago.  
Westinghouse Electric & Mfg. Co., Pittsburg.  
Weston Electrical Instrument Co., Newark, N. J.
- Tapes and Webbing.**  
Hope Webbing Co., Providence, R. I.  
Johns-Manville, H. W., Co., New York.  
Okonite Co., Ltd., 253 Broadway, New York.
- Testing Instruments.**  
Queen & Co., Philadelphia.  
Weston Electrical Instrument Co., Newark, N. J.
- Test Lamps, Pocket.**  
Chase-Shawmut Co., Newburyport, Mass.
- Ticket Choppers and Destroyers.**  
Patten, Paul B., Salem, Mass.
- Ticket Punches.**  
Meyers, Fred J., Mfg. Co., Hamilton, O.  
Woodman Mfg. & Sup. Co., Boston.
- Ties and Poles, Wood—(See Poles and Ties).**
- Timber.**  
Beldier, Francis, & Co., Chgo.  
Lindsley Bros. Co., Spokane, Wash.  
S-E. Missouri Cypress Co., Campbell, Mo.
- Tools, Pneumatic—(See Pneumatic Tools).**
- Track Cleaners and Scrapers.**  
American Car Co., St. Louis.  
Brill, The J. G., Co., Philadelphia.  
Kalamazoo Railway Supply Co., Kalamazoo, Mich.  
Kuhlman, The G. C., Car Co., Cleveland.  
McGuire-Cummings Mfg. Co., Chicago.  
Marshall, R. W., & Co., 95 Liberty St., New York.  
Ohio Brass Co., Mansfield, O.  
Stephenson, John, Co., Elizabeth, N. J.  
Van Horn & Dutton Co., Cleveland, O.  
Wason Mfg. Co., Springfield, Mass.
- Track Drills—(See Drills, Track).**
- Tracklaying Machinery.**  
Holman D. F., Tracklayer Co., 112 Ellsworth Bldg., Chicago.
- Track Tools.**  
Electric Service Supplies Co., 200 Plymouth Bldg., Chicago.  
Kalamazoo Railway Supply Co., Kalamazoo, Mich.
- Trimming, Car.**  
American Car Co., St. Louis.  
Brill, The J. G., Co., Philadelphia.  
Curtain Supply Co., Park Row Bldg., New York.  
Kuhlman, The G. C., Car Co., Cleveland.  
National Lock Washer Co., Newark, N. J.  
St. Louis Car Co., St. Louis, Mo.  
Stephenson, John, Co., Elizabeth, N. J.  
Wason Mfg. Co., Springfield, Mass.
- Trolley Guards.**  
Automatic Trolley Guard Co., 391 Ellicott Sq., Buffalo, N. Y.  
Electric Service Supplies Co., 200 Plymouth Bldg., Chicago.
- Trolley Poles and Fittings.**  
General Electric Co., Schenectady, N. Y.  
Johns-Manville, H. W., Co., New York.  
Marshall, R. W., & Co., 95 Liberty St., New York.  
Star Brass Works, Kalamazoo, Mich.

**STANDARD HIGH-SPEED "INTERBOROUGH" DOUBLE TRUCK**

TYPE C-60

**"Solid Forged"**

WITHOUT WELDS

FRAMES ARE MADE FROM ROLLED OPEN-HEARTH STEEL WITHOUT WELDS. ALL WEARING BOLTS ARE TURNED AND CASE HARDENED, AND WEARING HOLES STEEL THIMBLED. M. C. B. STANDARD PRINCIPLES ARE FOLLOWED. WE ARE PREPARED TO BUILD TRUCKS IN ACCORDANCE WITH PURCHASER'S DESIGNS AND SPECIFICATIONS.

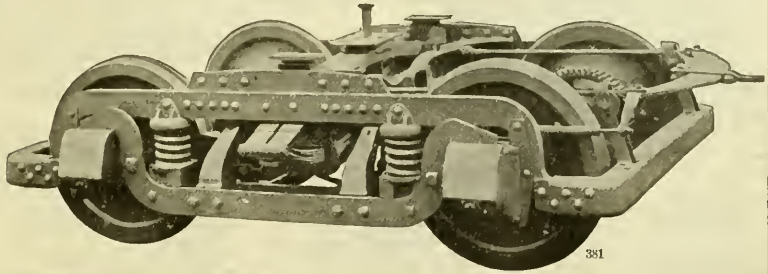

381

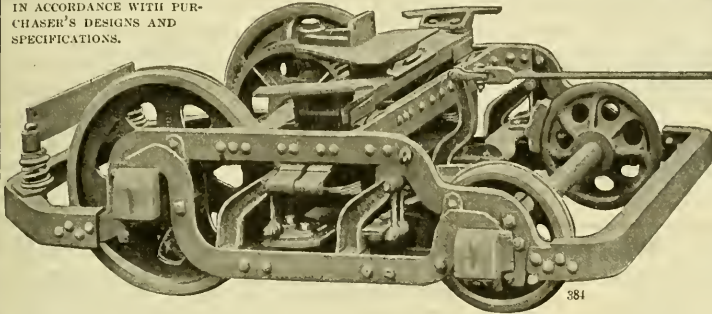

384

**STANDARD  
"MAXIMUM  
TRACTION"  
DOUBLE TRUCK**

CITY AND SUBURBAN  
TYPE O-45

OVER TWO HUNDRED OF THESE "MAXIMUM TRACTION" TRUCKS ARE IN SERVICE IN BROOKLYN, NEW YORK, AND ARE PRONOUNCED "HIGHLY SATISFACTORY."

STANDARD MOTOR TRUCK COMPANY, FRICK BUILDING, PITTSBURGH, PENNSYLVANIA  
NEW YORK OFFICE: 170 BROADWAY WORKS: NEW CASTLE, PA. CHICAGO OFFICE: FISHER BUILDING

We buy for spot cash anything you may have for sale in the way of

**Railway Motors  
Armatures  
Commutators  
Scrap Copper, Etc.**

↔ No deal too large for us to handle ↔

We refer to Bradstreet, Dun or any Cleveland bank.

**Cleveland Armature Works**

4732 St. Clair Avenue : : CLEVELAND, OHIO

America's Greatest Armature Winding, Commutator and Field Works

**CLASSIFIED LIST OF ADVERTISERS—Continued.**

- Trolley Retrievers and Catchers.**  
 Electric Service Supplies Co., 1020-24 Filbert St., Phila.  
 Milloy Electric Co., Bucyrus O.  
 Riddon, Frank Co., 200 Summer St., Boston.  
 Trolley Supply Co., Canton, O.
- Trolley Wagons.**  
 Kalamazoo Railway Supply Co., Kalamazoo, Mich.
- Trolley Wheels—(See Trolley Poles and Fittings).**
- Trolley Wire—(See Wire and Cables).**
- Trolleys, Track.**  
 Cleveland Armature Works, Cleveland, O.
- Trucks, Car.**  
 American Car Co., St. Louis.  
 Baldwin Locomotive Works, Philadelphia.  
 Brill, The J. G., Co., Philadelphia.  
 Kuhlman, The G. C., Car Co., Cleveland.  
 McGuire-Cummings Mfg. Co., Chicago.  
 St. Louis Car Co., St. Louis, Mo.  
 Standard Motor Truck Co., Pittsburg, Pa.  
 Standard Varnish Works, New York City.  
 Stephenson, John, Co., Elizabeth, N. J.
- Trucks, Car—Continued.**  
 Van Dorn & Dutton Co., Cleveland, O.  
 Wason Mfg. Co., Springfield, Mass.
- Turbines.**  
 General Electric Co., Schenectady, N. Y.  
 Westinghouse Machine Co., Pittsburg, Pa.
- Valves—(See Steam Fittings).**
- Varnish.**  
 Electric Service Supplies Co., 200 Plymouth Bldg., Chicago.  
 Harrison Elec. & Mfg. Co., 163 South St., New York.  
 Marshall, R. W., & Co., 95 Liberty St., New York.  
 Milloy Electric Co., Bucyrus, O.  
 Nuttall, R. D., Co., Pittsburg.  
 Riddon, Frank, Co., 200 Summer St., Boston.  
 Standard Paint Co., 100 William St., New York.  
 Star Brass Works, Kalamazoo, Mich.  
 Trolley Supply Co., Canton, O.  
 Wallace Supply Co., Chicago.  
 Westinghouse Electric & Mfg. Co., Pittsburg, Pa.
- Ventilators.**  
 Drouvé, The G., Co., Bridgeport, Conn.  
 Lord & Burnham, Irvington-on-Hudson, New York.
- Vestlettes.**  
 Bellamy Vestlettes Mfg. Co., Cleveland, O.
- Waste, Cotton and Wool.**  
 Hagy, J. Milton, Waste Wks., Philadelphia, Pa.  
 Railway Specialty & Supply Co., Chicago.
- Water Softening Apparatus.**  
 Dearborn Drug & Chemical Works, Chicago.
- Wheels and Axles.**  
 American Car Co., St. Louis.  
 Brill, The J. G., Co., Philadelphia.  
 Griffin Wheel Co., Chicago.  
 Kuhlman, The G. C., Car Co., Cleveland.  
 Lorain Steel Co., Philadelphia.  
 McGuire-Cummings Mfg. Co., Chicago.  
 Marshall, R. W., & Co., 95 Liberty St., New York.  
 Railway Steel-Spring Co., New York.  
 St. Louis Car Co., St. Louis, Mo.  
 St. Louis Car Wheel Co., St. Louis.  
 Standard Steel Works, Philadelphia.  
 Stephenson, John, Co., Elizabeth, N. J.  
 Wason Mfg. Co., Springfield, Mass.
- Wheel Grinders.**  
 Wheel Truing Brake Shoe Co., Detroit, Mich.
- Window Fixtures.**  
 Drouvé, The G., Co., Bridgeport, Conn.
- Wiping Rags.**  
 Hagy, J. Milton, Waste Wks., Philadelphia, Pa.
- Wire, Aluminum.**  
 Aluminum Co. of America, Pittsburg, Pa.
- Wire, Insulated.**  
 Aluminum Co. of America, Pittsburg, Pa.  
 American Electrical Works, Providence, R. I.  
 General Electric Co., Schenectady, N. Y.  
 Okonite Co., Ltd., 253 Broadway, New York  
 Standard Underground Cable Co., Pittsburg, Pa.  
 Stuart-Howland Co., Boston.
- Wire and Cables.**  
 Aluminum Co. of America, Pittsburg, Pa.  
 American Electrical Works, Providence, R. I.  
 Bridgeport Brass Co., Bridgeport, Conn.  
 General Electric Co., Schenectady, N. Y.  
 Okonite Co., Ltd., 253 Broadway, New York.  
 Standard Underground Cable Co., Pittsburg, Pa.

**"METALSTEEL" PAINT**  
 Best Steel Protective and Rust Preventive for all Metal Surfaces.



**ST. LOUIS SURFACER & PAINT COMPANY**  
 St. Louis, U. S. A. 10

**TROLLEY WIRE, BARE COPPER CABLES  
 WEATHERPROOF WIRE AND CABLES**



RUBBER COVERED CABLES AND LEAD COVERED UNDERGROUND CABLES FOR ANY SERVICE. WRITE US FOR SPECIAL PRICES AT THIS TIME

**STANDARD UNDERGROUND CABLE CO.**  
 Pittsburg New York Boston St. Louis San Francisco Chicago  
 Philadelphia Los Angeles Atlanta

**ALUMINUM**  
**Railway Feeders**  
 And all kinds of **Electrical Conductors**

Aluminum Feeders are less than one-half the weight of copper feeders and are of equal conductivity and strength. If insulated wire or cable is required, high grade insulation is guaranteed.

*Write for prices and full information.*

**Aluminum Company of America**  
 PITTSBURGH, PA.  
 Formerly The Pittsburgh Reduction Company

**Motor Packing Waste**

It is free from dirt and grit, holds the oil better and is easier to pack than ordinary waste.

One packing of the journal box will last longer than with other waste. Used by leading traction companies and electric motor manufacturers.

All grades of white and colored wiping waste, also sanitary cleaned wiping rags. Samples submitted.

**The J. Milton Hagy Waste Works**  
 433 Spruce St. INCORPORATED Philadelphia 2

**THE BABCOCK & WILCOX COMPANY**  
 85 Liberty Street, New York

Babcock & Wilcox — Stirling — A & T Horizontal — Cahall Vertical

**WATER TUBE STEAM BOILERS**

Works: Bayonne, N. J. Barberton, Ohio.

BRANCH OFFICES:

BOSTON, Delta Bldg.	DENVER, 410 Seventeenth St.	CLEVELAND, 706 New England Bldg.
PHILADELPHIA, 1110-1112 North American Bldg.	SALT LAKE CITY, 313 Atlas Block	MEXICO CITY, Avenida Juarez
SAN FRANCISCO, 63 First Street	WASHINGTON, Colorado Building	HAVANA, CUBA, 116 1/2 Calle de la Habana
PITTSBURGH, Farmers Deposit Nat. Bank Bldg.	CHICAGO, Marquette Bldg.	LOS ANGELES, 321 Trust Bldg.
NEW ORLEANS, 343 Baronne St.	ATLANTA, GA., 1132 Candler Bldg.	CINCINNATI, O., Tracost Bldg.

**STEAM SUPERHEATERS**      **MECHANICAL STOKERS**

## You know how important

it is to have the windows of your power house, car shops and barns closed instantly when a fire occurs so that drafts may be reduced to a minimum.

If you've ever had a fire experience you know, too, that a fire's headway may be measured by the number of window closing stations and the speed of the closing device.

And if you had

## Lovell Window Operators

in use, you appreciated their quick operation, due to the small number of closing stations, each one handling all the way up to 500 feet of sash, and to the fact that the windows farthest from stations were closed in unison with those nearest.

But if you had something that wasn't satisfactory, we'd suggest that you investigate the **Lovell Window Operator**—made only by

## THE G. DROUVÉ CO.

BRIDGEPORT, CONN., U. S. A.

Western Office: 40 Dearborn Street, Chicago

2



The M. C. B. Christie Flanged Steel Back Brake Shoe for use on wheels with 3-inch tread and over.

## Brake Shoe Standardization

is not the extremely expensive process you may have imagined it to be.

It is really a simple proposition—means merely a change in the brake head—no change in brake hanger, rigging or truck.

And the saving in brake shoe material bought, handled and scrapped will more than pay for the change.

Give us the opportunity of studying your brake shoe problem and we'll show you how to save money.

*Address the nearest office, please.*

## TUBULAR POLES IRON OR STEEL



FOR  
ELECTRIC RAILWAYS  
ELECTRIC LIGHTING CO'S  
SIGNAL )  
TELEPHONE )  
TELEGRAPH )  
SER-  
VICE  
TRANSMISSION  
LINE S  
AND  
CATENARY  
SUSPENSION  
LINE S

**ELECTRIC RAILWAY EQUIPMENT CO.**  
General Office: CINCINNATI-O-U-S-A  
Shops: READING PA - WHEELING WVA

## American Brake Shoe & Foundry Company

Mahwah, N. J.

170 Broadway  
New York

Western Union Bldg.  
Chicago

8

**THE ARNOLD COMPANY**

ENGINEERS-CONSTRUCTORS  
ELECTRICAL - CIVIL - MECHANICAL  
181 LA SALLE STREET  
CHICAGO

**H. M. Bylesby & Company**

Incorporated  
ENGINEERS  
American Trust Bldg., Chicago  
Design, Construct and Operate  
Railway, Light, Power and  
Hydraulic Plants  
EXAMINATIONS AND  
REPORTS

**J. G. WHITE & COMPANY**  
INCORPORATED**Engineers, Contractors**

43-49 Exchange Place, New York, N. Y.  
41-43 Wall Street  
Principal Philippine Office: Manila, P. I.

**SANDERSON & PORTER****ENGINEERS AND CONTRACTORS**

EXAMINATIONS - REPORTS - DESIGNS - SPECIFICATIONS  
CONSTRUCTION - EQUIPMENT - SUPERVISION AND MANAGEMENT  
OF RAILWAY, LIGHT AND POWER PROPERTIES  
HYDRO-ELECTRIC DEVELOPMENTS  
52, WILLIAM STREET, NEW YORK

**Complete Plants for the Rapid  
Handling of Material**

Every Sort of Hoisting Apparatus

BROWN HOISTING MACHINERY CO. Cleveland, Ohio

In the **IDEAL TROLLEY WHEEL** we have reduced electrical resistance to a minimum and eliminated the steel flange as part of the circuit.

Plenty of other superior points about the Ideal. Write us.

Buffalo **LUMEN BEARING CO.** Toronto

**A. L. REGISTER & CO.**

Engineers and General Contractors—Electric Railways  
112 North Broad St. PHILADELPHIA, PA. Established 1889

**SHIMER & CHASE CO.**

Experienced Promoters of Electrical Railway Projects  
Correspondence Solicited OMAHA, NEB.

**CENTRAL INSPECTION BUREAU**

Inspection of Rails, Ties, Cars, Motors, Bridges, Buildings, Etc.  
17 STATE STREET - - - NEW YORK CITY

**LINE MATERIAL**

ELECTRIC SUPPLIES FOR RAILWAYS, POWER PLANTS, ETC.  
THE CREAHEAD ENGINEERING CO., 346 Main Street, Cincinnati, Ohio

**THE CURTAIN SUPPLY CO.**

CAR CURTAINS  
CHICAGO, 85-93 Ohio Street 1819 Park Row Bldg., NEW YORK

**Gongs** For Street Cars **Bells**

G. C. REITER, Canton, Ohio

**HOT WATER HEATERS FOR CARS**

THE PETER SMITH HEATER COMPANY, Detroit, Mich.

**ELECTRIC HEATERS** For All Classes of Cars

New York Consolidated Car-Heating Co. Chicago

**BRAKESHOOES**

STANDARD  
BRAKESHOE COMPANY  
GEN'L OFFICES & WORKS - AURORA, ILL. - CHICAGO OFFICE 315 RY. EXCH.

WRITE TO **MODEL STOKER COMPANY** DAYTON OHIO

For detailed information about the best  
**AUTOMATIC SMOKELESS FURNACE**

**WHEEL TRUING BRAKE SHOES**

Repair Crippled Wheels While Running  
THE WHEEL TRUING BRAKE SHOE CO., Detroit, Mich.

**SMITH CONCRETE MIXER**

does the work better, quicker, cheaper and lasts longer.  
**CONTRACTORS' SUPPLY & EQUIPMENT COMPANY**  
Old Colony Building, Chicago 170 Broadway, New York 9

**RE-ENFORCED SPOKE WHEELS**

For City and Suburban Cars  
**ST. LOUIS CAR WHEEL CO., St. Louis, Mo.**

**HART CONVERTIBLE CAR**

RODGER BALLAST CAR CO., Railway Exchange, CHICAGO

**GEARS AND PINIONS**

FOR ALL TYPES OF MOTORS  
THE VAN DORN & DUTTON CO., CLEVELAND, OHIO

**AUTOMATIC TROLLEY GUARD CO.**

391-393 Elliott Square, Buffalo, N. Y.  
"IT PUTS THE WHEEL ON THE WIRE"



Established 1877.

**ALBERT & J. M. ANDERSON MFG. CO.,**

Makers of

**ELECTRICAL APPLIANCES:**  
SWITCHES, SWITCHBOARDS,  
TIME SWITCHES, LINE MATERIAL,  
COPPER CASTINGS (75% CONDUCTIVITY).  
289-293 A ST., BOSTON, MASS., U. S. A.

Branches: New York, 135 Broadway. Chicago, 175 Dearborn Street.

Agencies:

Boston, Pettibell-Andrews Co. San Francisco, Eccles & Smith Co.  
New York, R. W. Marshall & Co. Atlanta, Newcomer-Wanry Co.  
St. Louis, J. C. White. Denver, E. M. Messiter.  
Toronto, Ont., H. J. Surtees.



## Shawmut Soldered Bond Cap

to make over your  
PLUG BONDS

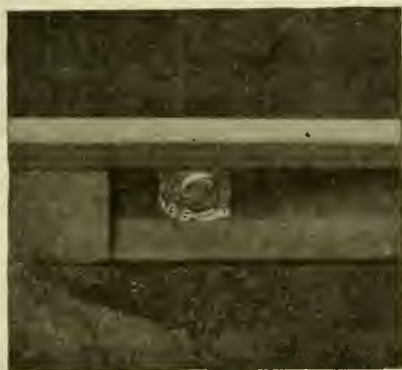

Why not look this up

**CHASE-SHAWMUT CO.**  
Newburyport, Mass.

## Your Dispatcher's Orders

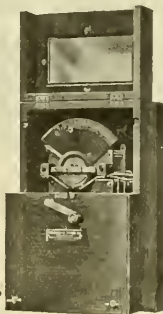

are apt to prove valueless at the critical moment unless he has a positive means at hand of enforcing them.

He can do this *every time* with the Telegraph Signal System.

Investigate its merits! Write

**Telegraph Signal Company**  
282 State Street - Rochester, N. Y.

10

## Galena-Signal Oil Company

FRANKLIN, PA.

THEIR SPECIALTIES

### STREET RAILWAY LUBRICATION

including both rolling stock and power house equipment.

Same skillful *expert supervision* given in this service as in steam railway service has produced very satisfactory results. The business of our Street Railway Department has increased beyond every expectation. In 1906 this department sold ten times the number of barrels of oil sold by the same department in 1903.

We are under contract with many of the largest street and interurban railways of the country.

We guarantee cost per thousand miles in street railway service when conditions warrant it.

Write to Franklin, Pennsylvania, for further particulars.

### STEAM RAILWAY LUBRICATION

Sole manufacturers of the celebrated *Galena Coach, Engine*

and *Car Oils* for steam railway lubrication. *Sibley's Perfection Valve Oil* for cylinder lubrication, and *Perfection Signal Oil* for use in railway signal lanterns.

### GALENA RAILWAY SAFETY OIL

Made especially for use in headlights, cab, classification

and tail lights, and for switch and semaphore lamps. Burns equally well with the long time as with the one-day burner; with or without chimney as the burner requires. Is pure water white in color; high fire test, low cold test, and splendid gravity.

CHAS. MILLER, President



## Opinions

often differ, yet there can be but one opinion regarding the economy of using only "NUTTALL XX" Pinions for heavy railway service. Their wearing qualities are 35 per cent greater than those of the ordinary kind. Try them and see. Order now for immediate delivery.

*If in a hurry, wire us.*

**R. D. Nuttall Company**  
Pittsburg, Pa.

# MORDEN FROG AND CROSSING WORKS

MANUFACTURERS OF

618 The Rookery, Chicago

## Street Railway Special Track Work

Works: } SOUTH CHICAGO and CHICAGO HEIGHTS

"UNION" Track Jacks, Switches, Frogs, Crossings, Rail Braces, Etc.

# The Lindsley Brothers Company

Producers and Shippers of

and Manufacturers of

## WESTERN CEDAR POLES

## RED FIR CROSS ARMS

Eastern Sales Office, Monadnock Bldg., CHICAGO

SPOKANE, WASHINGTON

## Poles and Ties

A Selected Stock in Chicago for Rush Shipment  
A Number of Large Yards in the North

### NAUGLE POLE & TIE CO.

CHICAGO OFFICE: 226 LA SALLE STREET

If you want **POLES** Michigan or good Western Cedar

at the right prices and prompt delivery, write us.

### NATIONAL POLE COMPANY

EVERETT, WASH. ESCANABA, MICH.

## CHESTNUT POLES

Cedar, Oak and Chestnut Ties

FROM OUR OWN TIMBER LANDS

### THE ADVANCE LUMBER CO.

CLEVELAND, OHIO

## C. H. WORCESTER CO. CEDAR POLES

PRODUCERS AND WHOLESALERS

Suite 1719 Tribune Building

CHICAGO

## G. H. BARNES HARDWOOD LUMBER CO.

Office and Yard: Main and Warren Sts., ST. LOUIS, MO.

Ties, Car Oak, Poplar, Ash, Cherry, Plain and Quartered Oak

## HEINE SAFETY BOILER CO.

421 OLIVE STREET, ST. LOUIS, MO.

Manufacturers of WATER TUBE BOILERS

## POLES and PILING

20,000 35s and 40s, Ready to Ship at Once  
S-E. MISSOURI CYPRESS CO., CAMPBELL, MO.

## Idaho Cedar Poles

PACIFIC COAST POLE CO.

SPOKANE, WASH.

We are Producers and Wholesale Dealers in Western

## CEDAR POLES

Yards in Washington, Idaho, Montana and British Columbia

WRITE US FOR DELIVERED PRICES

CHURCHILL CEDAR CO., Box 1409, Spokane, Wash.

## BERTHOLD & JENNINGS

LUMBERMEN'S BLDG. SAINT LOUIS, MO.

### TIMBERS

L. L. Pine, Oak

### POLES

Cedar, Cypress, Chestnut

### TIES

Oak, Cypress, Chestnut

## WHITE CEDAR

## P O L E S

Large Stock 14 to 65 ft.

Prompt Shipment

## P O L E S

### YARDS:

Menominee, Mich.  
Escanaba, Mich.  
Superior, Wis.  
Deer River, Minn.

## P O L E S

FRANCIS BEIDLER & CO.  
Chicago, Ill.



# FOR SALE. FOR QUICK DELIVERY

## 6 55-ft. Passenger, Baggage and Smoking Car Bodies

Main Compartment 26' 0"  
 Smoking " 10' 6"  
 Baggage " 10' 0"  
 Seating Capacity, 54

## 8 60-ft. Passenger, Baggage and Smoking Car Bodies

Main Compartment 28' 6"  
 Smoking " 11' 0"  
 Baggage " 8' 0"  
 Seating Capacity, 58

## 5 52-ft. Passenger and Smoking Car Bodies—Double End

Seating Capacity, 60

## 3 52-ft. Passenger and Baggage Car Bodies—Double End

Seating Capacity, 56

## 2 50-ft. Express Car Bodies

*Write or wire us for further information.*

# The Jewett Car Co. Newark Ohio

### THE MIGHTY MIDGET

## HOT WATER CAR HEATER

Adapted for Large Electric Cars and Long Distance Lines. Exclusively used on Largest Electric Systems. Ask for Catalog

THE WILLIAM C. BAKER HEATING & SUPPLY CO., 143 LIBERTY STREET NEW YORK



## NILES CARS — THE ELECTRIC PULLMANS

LARGE, FAST INTERURBANS  
OUR SPECIALTY

## NILES CAR & MFG. COMPANY

WORKS: NILES, OHIO

Sales Office: J. A. HANNA Co., 312 Electric Bldg., Cleveland, O.

## CAR BODIES

Of All Types

## TRUCKS

To Suit

## CINCINNATI CAR COMPANY

CINCINNATI, OHIO

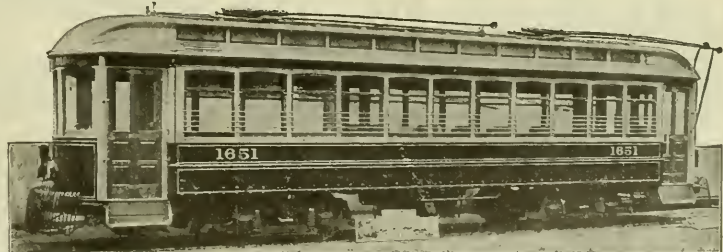

STANDARD SEMI-CONVERTIBLE—For Use All the Year

# Baldwin Locomotive Works

BURNHAM, WILLIAMS & CO., PHILADELPHIA, PA., U. S. A.

Builders of  
**LOCOMOTIVES**

of every description  
including

**ELECTRIC  
LOCOMOTIVES**

**ELECTRIC TRUCKS**



# Standard Steel Works Co.

HARRISON BLDG., PHILA., PA., U. S. A.

New York, N. Y. Cleveland, O. St. Louis, Mo. Denver, Colo.  
Portland, Ore. Richmond, Va. Chicago, Ill. St. Paul, Minn.  
San Francisco, Cal. Seattle, Wash. Winnipeg, Can.

**Solid Forged  
Rolled and Steel Tired Wheels**

Mounted on axles fitted with Motor Gears  
for Electric Railway Service.

**LOCOMOTIVE TIRES RAILWAY SPRINGS  
FORGINGS CASTINGS**



SPEER  
HIGH GRADE  
BRUSH

ST. MARYS - PA.

## Time is Money

That is one reason why the  
Atlas Anchor is so popular.

Get a Working Model Free.

THE ATLAS ANCHOR CO., Cleveland, Ohio



AS IT  
HOLDS



CONTINUOUS JOINT

Over  
25,000  
miles  
in use



WEBER JOINT

Rolled  
from  
Best Quality  
Steel



WOLHAUPTER JOINT

Catalogs at Agencies  
Baltimore, Md. Portland, Ore.  
Boston, Mass. Seattle, Wash.  
Chicago, Ill. St. Paul, Minn.  
Denver, Colo. St. Louis, Mo.  
Pittsburg, Pa. Troy, N. Y.  
London, Eng. Montreal, Can.

HIGHEST AWARDS—Paris, 1900;  
Buffalo, 1901; St. Louis, 1904

Additional safety and economy in Track Maintenance has been proved by the use of Continuous, Weber and Wolhaupter base-supported rail joints—after ten (10) years' service, having a record of over 25,000 miles in use—the extent of which is evidence of their excellence.

## THE RAIL JOINT COMPANY

General Offices: 29 West 34th Street, New York City  
Makers of Rail Joints for Standard and Special Rail Sections, also Girder, Step or Compromise, and Insulating Rail Joints, protected by patents in United States and Foreign Countries.

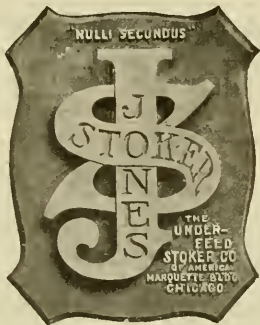

NULLI IN SECUNDIS

J  
STOKER  
FEED  
S  
S

THE  
UNION-  
FEED  
STOKER CO.  
OF AMERICA  
MARQUETTE BLDG.  
CHICAGO

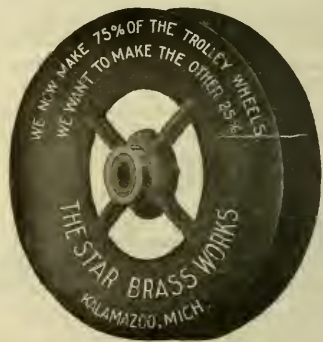

# PIPE FITTINGS AND VALVES

FOR THE  
HEATING AND PLUMBING TRADE

TRADE  MARK

**JOHN SIMMONS CO.**  
104-110 Centre Street, NEW YORK

# THE LORAIN STEEL COMPANY

**Girder Rails and High Tee Rails  
High-Grade Special Track Work**

GENERAL OFFICES  
THE PENNSYLVANIA BUILDING, PHILADELPHIA, PA.

Of all the good things we can say about the

# Knutson Trolley Retriever

the best is this—it is in successful use on a majority of the high-speed electric railways of America.

What more need we say?  
Only this—send for a lot and make a thorough test on your road at our expense. Write to

**The Trolley Supply Co., Canton, Ohio**

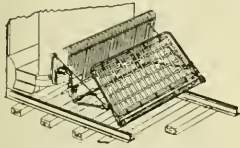

## ECLIPSE Life Guard

Manufactured by the  
**ECLIPSE RAILWAY SUPPLY CO.**  
Cleveland, Ohio



## E. C. Van Valkenburgh

Promotional Advertising  
for Electric Railways

2117 West 102d Street : Chicago

*A well-laid plan and Van Valkenburgh Advertising Service will make your advertising successful.*

## SPRINGS—TIRES—STEEL-TIRED WHEELS RAILWAY STEEL-SPRING CO.

General Offices: 71 Broadway, New York

## GRIFFIN WHEEL CO. CHICAGO

CHILLED IRON CAR WHEELS IRON OR STEEL AXLES

For CABLE, ELECTRIC and  
ELEVATED CARS

## VAN DORN AUTOMATIC COUPLERS

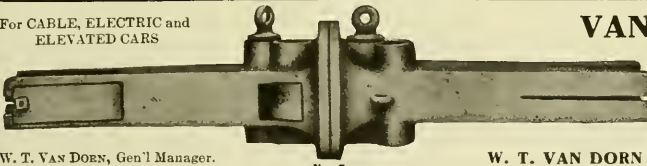

The records go farther than talk.  
Look up the records.  
Send for booklet of information on Couplings.

W. T. VAN DORN, Gen'l Manager.

No. 5

W. T. VAN DORN COMPANY, 1076 S. Paulina Street, CHICAGO



Factory of The Milloy Electric Company  
Bucyrus, Ohio

## The Milloy Trolley Base

built in our new and specially equipped factory, insures a quality which will give excellent service under ordinary and extraordinary conditions.

The Milloy Base is unusually low, has even tension on high or low wire. Has no fulcrum, no friction, no oil, no center post. Always efficient. Particulars on request.

**THE MILLOY ELECTRIC COMPANY**  
Bucyrus, Ohio

## Track Equipment

We have a large line of hydraulic tools adapted for use in the track department. Special Punches and Rail Benders (for tee, guard, girder and conductor rail), Tie Plate Presses and Hydraulic Jacks.

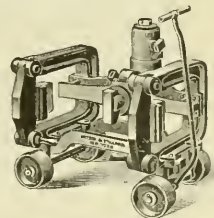

Send for Railroad Catalogue.

**THE WATSON-STILLMAN CO.**

Main Office: 26 Cortlandt Street, New York City  
Branch Office: 453 The Rookery, Chicago, Ill.

# CLASSIFIED ADVERTISEMENTS

Undisplayed advertisements are inserted under this heading at the uniform rate of one cent a word; minimum charge twenty-five cents. Replies directed to this office will be forwarded when required to any address in the United States, Canada or Mexico without extra charge. Advertisements received at the Chicago office by 9 a. m. Thursday will appear in the issue for the same week.

## POSITIONS WANTED.

Train dispatcher wants position, 5 years' experience with big electric system; best of references. Address "No. 564," care of Electric Railway Review, Chicago.

Position as chief engineer and machinist wanted. Will go to responsible company on trial. Have had 25 years' practical experience. Address "No. 563," care of Electric Railway Review, Chicago.

Young man with four years' experience in office, drafting room, and field work alternately, desires position as utility man with electric road, in east preferably. Address "No. 563," care of Electric Railway Review, Chicago.

Position wanted as track foreman by a reliable and practical construction man of many years' experience on both city and interurban roads. Can give good engineering reference; do not drink. Address "No. 565," care of Electric Railway Review, Chicago.

Officers of electric railway properties desiring services of an experienced operating superintendent, young, energetic and reliable, having successfully handled a 200-car system, are requested to address "No. 555," care of Electric Railway Review, Chicago.

Wanted—To correspond with company needing the services of high-class general manager or general superintendent. Electrical and civil engineer; 17 years' experience with large properties and in construction and operation. Address "No. 565," care of Electric Railway Review, Chicago.

Experienced electrical engineer wants position with manufacturing concern or with company operating electric railways. Graduate Purdue University, 1905. Will go anywhere for permanent position. Age 26; married; A No. 1 references as to habits and ability. Address "No. 570," care of Electric Railway Review, Chicago.

## POSITIONS WANTED.

Position as chief clerk or auditor by young single man with seven years' experience electric railway work. Good knowledge of operating departments; exceptional references. Address "No. 554," care of Electric Railway Review, Chicago.

Accountant, first-class, desires position. Good executive ability and a strict business man. Can keep any kind of accounts; render comparative statistical statements; and not afraid to go against anything. Make me an offer. Address C. K. Tilton, Suite A-1, Champion Bldg., Atlantic City, N. J.

An experienced supply salesman, who also has had thirteen years' operating experience on city lines, desires to form connection with a railway supply house handling either electric or steam supplies or both. Would consider proposition to open sales agency. Address "No. 566," care of Electric Railway Review, Chicago.

Master mechanic of undeniable ability and experience is at liberty to accept reasonable offer. Has had 15 years' experience in both steam and electric service. Has exceptional ability in equipping new rolling stock and handling shops and men on economical basis. Address "No. 560," care of Electric Railway Review, Chicago.

## POSITIONS OPEN.

Wanted — Electrical salesman who is willing to street railways to take important side line. J. W. Morrison, 29 Griswold St., Detroit, Mich.

Park superintendent wanted. State experience and salary wanted; also give references. Address "No. 561," care of Electric Railway Review, Chicago.

Superintendents, engineers, draftsmen, street railway, electrical, mechanical. Positions open. Write for free list and information, HAPGOODS, 305 Broadway, New York, or 1010 Hartford Bldg., Chicago.

## BUSINESS OPPORTUNITIES

Exclusive sales agency wanted for Chicago and west for several street railway specialties. Appliances for cars only. Address "No. 556," care of Electric Railway Review, Chicago.

Wanted—Man with some capital and a knowledge of railway track supplies to join the advertiser—a salesman handling locomotive and car supplies—in a general railway supply business. Address "No. 558," care of Electric Railway Review, Chicago.

Don't throw away your old batteries. We have a preparation which will positively renew old dry batteries at the cost of two cents each. Trial package and electrical catalogue 10 cents. Adams Electric Co., Dept. E. R., Kewanee, Ill.

Experienced salesmen, opening office in Washington, D. C., desire to make arrangements to represent manufacturers of standard specialties and supplies for electric railways and contractors. Southern territory. Address "No. 562," care of Electric Railway Review, Chicago.

## MISCELLANEOUS WANTS.

Want to buy second-hand equipment, machinery or material? A card inserted in the Electric Railway Review, stating just what you want, will bring immediate response. The cost is small—of \$1.20 an inch (measuring 1 inch deep by 1½ inches wide) per insertion. Send orders to Electric Railway Review, 160 Harrison St., Chicago.

What have you to sell in the way of second-hand equipment, machinery or material? Buyers read the "For Sale" cards on the following page and there is the place to tell your story. "For Sale" cards are inexpensive—only \$1.20 an inch (measuring 1 inch deep by 1½ inches wide) per insertion. Special rates on contracts for 100 inches or more to be used within one year. Now is the time to send your order to Electric Railway Review, 160 Harrison St., Chicago.

## BOOKS AND PUBLICATIONS.

Wanted—Copies of the Street Railway Review of July 30, 1904, May, 1901, and August, 1903. State price and condition. Address "No. 567," care of Electric Railway Review, Chicago.

Wanted—Copies of the Street Railway Review of April, 1900, May, 1901, and August, 1903. State price and condition. Address "No. 553," care of Electric Railway Review, Chicago.

We want your friends to read the Electric Railway Review. You will do them—and us—a favor by sending their addresses. We will gladly mail free sample copies. Electric Railway Review, 160 Harrison Street, Chicago.

If interested in any phase of steam transportation, You will find the development covered fully and accurately in The Railway Age. It is the leader and acknowledged authority in this field. Ask for free sample copies. The Railway Age, 160 Harrison Street, Chicago.

A copy of "The Motorman and His Duties," the standard handbook on the theory and practice of electric car operation, is worth many times its cost to every man interested in the subject. Send for 16-page pamphlet of sample pages. The Wilson Company, 160 Harrison Street, Chicago.

Interstate commerce national legislation to July 1, 1906, is fully covered in our reference pamphlet. It contains the full text of the act to regulate commerce as amended, including the Elkins and Hepburn acts, and of the supplementary act relating to the testimony of witnesses before the Interstate commerce commission. It also contains the texts of the expedition act, the anti-trust act of 1890, the employers' liability act and the safety equipment laws. Difference in type shows the parts expunged from, and the parts added to, the Interstate commerce and Elkins acts by the Hepburn act. This pamphlet is of special value to railway men and lawyers. Mailed prepaid for 25 cents in stamps or coin. Special prices for quantities. The Wilson Company, 160 Harrison St., Chicago.

One road writes as follows:

"All doubts that we had in the beginning about the merits of your

## Whitmore's Gear Protective Composition

have been thoroughly removed. The results from the use of this material are far beyond our expectations. You are entitled to great success."

We are in position to do the same thing for you.

The Whitmore Manufacturing Company  
CLEVELAND, OHIO, U. S. A. 1

## Mica Prices Reduced

Compare our prices on Raw Mica and Manufactured Mica with prices you have been paying our competitors.

WHY PAY FANCY PRICES?

CHICAGO MICA CO.

VALPARAISO : : : INDIANA

**FOR SALE: Three Car Bodies and Three Pairs of Double Trucks**  
 with or without electric equipment and air brakes; all new and never used. Compelled to sell, as these cars will not operate over a leased line by reason of their width and length.  
**R. W. MARSHALL & CO., 97 Liberty St., New York, N. Y.**

**FOR SALE:**  
 6-inch 70-lb. **Girder Rails** and 7-inch 70-lb. **T Rails**  
 Second-hand, in first-class condition, almost as good as new. Removed to give place for grooved rails required by city. 130 tons of each, with splice bars. Price \$25.00 f. o. b. Columbus. Inspection solicited.  
**THE COLUMBUS RAILWAY & LIGHT CO., Columbus, Ohio**

**INSULATING VARNISHES**  
 (BAKING; AIR-DRYING)  
**COMPOUNDS**  
**TAPE**

**P&B**

Possess the Highest Insulative Efficiency.  
**The Standard Paint Co.**  
 100 William St. New York.

**WESTON Standard Portable Direct-Reading**



**Voltmeters**  
**Millivoltmeters**  
**Voltammeters**  
**Ammeters**  
**Millammeters**  
**Ohmmeters**  
**Ground Detectors**  
**and Circuit Testers**

Our STATION VOLTMETERS and AMMETERS are unsurpassed in point of extreme accuracy and lowest consumption of energy.

**WESTON ELECTRICAL INSTRUMENT CO.**  
 Main Office and Works: Waverly Park, Newark, N. J.  
 London Branch: Audrey House, Ely Place, Holborn, Paris, France: E. H. Cadot, 12 Rue St. Georges. New York Office: 71 Cortlandt St. Berlin: European Weston Electrical Instrument Co., Ritterstrasse, No. 88.

**"Wanted" and "For Sale" Cards**

Especially for the marketing of second-hand equipment, machinery, material, etc., are carried on this page at a uniform rate of **\$1.20 an inch** (measuring 1 inch deep by 1 1/2 inches wide) per insertion.

Special rates made on contracts covering 100 inches or more.

Send orders to

**Electric Railway Review**  
 160 Harrison Street - CHICAGO

**R.W. MARSHALL & CO.**  
 95 and 97 Liberty St., New York  
 Second-Hand Machinery and Equipment  
**ELECTRIC RAILWAY MATERIALS**

**RAILS**  
*Locomotives Cars Etc.*  
 Bought & Sold  
 Dealer & **ZELNICKER Supply Co.**  
 IN ST. LOUIS

**FOR SALE CHEAP!**  
 One 14/22 eight-wheel locomotive  
 Ten 34-foot 50,000 capacity flat cars  
 Two Granitium lumber cars  
 70 box cars, 40 and 50,000 capacity  
 80 Good Second-hand Bridges  
 Specifications and Blue Prints on application  
**F. A. JOHANN**  
 1624 Pierce Bldg., St. Louis, Mo.

**FOR SALE:** A number of **Nine-Bench Open Motor Cars**, monitor decks, in good condition.  
 Address: Rockford & Interurban Ry. Co., Rockford, Ill.

**NO SNOW TO DELAY CARS**  
 \*The Russell Snow-Plow is used by more than 50 roads to maintain schedules and prevent blockades. Russell Car & Snow-Plow Co., Ridgway, Pa. Wendell & MacDuffie, Cortlandt St., New York; C. A. Ralston, Fisher Bldg., Chicago; Robinson & Cary Co., Saint Paul.  
**IF YOU HAVE A RUSSELL**

**Queen Testing Sets**

*"The Recognized Standard"*



**U. S. Standard Testing Sets**  
 Rail Bond Testers  
 Galvanometers, etc., etc.  
 Electrical Instruments for All Purposes

Queen Acme Testing Set

**QUEEN & CO., Inc., Philadelphia, Pa.**

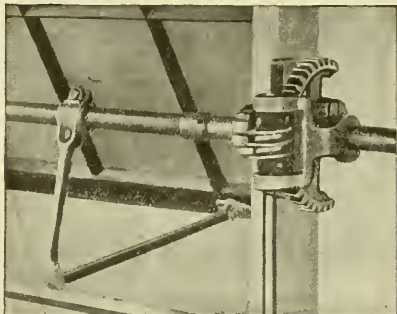

**The Ventilation**

of your Shops, Foundries and Car Barns is made especially effective by a speedy, positive and easily manipulated **Sash Operating Apparatus** which automatically locks the sash at any position.

Let us send you our catalogue.

**Lord & Burnham Company**  
 Irvington-on-Hudson, N. Y.

# Washburn Standard M. C. B. Coupler

—equal to every test

This coupler enabled heavy interurban cars to be hauled on their own wheels in trains from St. Louis to Los Angeles— and without a single breakage. The 152 cars equipped with these couplers are now in fast and heavy service on the Pacific Electric Railway, running in trains of from two to six units each, and around the short curves of city streets.

*Our 112-page catalog of traction devices sent free for the asking.*

**Washburn Steel Castings & Coupler Co., Minneapolis, Minn.**

Western Agents: Tweedy, Hood & Finlen, 2014 Fisher Bldg., Chicago  
Canadian Agent: John Taylor, Montreal



18

# NATIONAL

Curtain Fixtures  
Sash Locks Sash Balances  
and Nut Locks

COMPLETE CURTAINS

**The National Lock Washer Co.**

NEWARK, N. J.  
CHICAGO OFFICE: 419 Monadnock Block



## A Cooper Heater

will heat eight cars satisfactorily for the same cost of operating one car with the electric heater. It pays for itself.

*Ask us to prove it*

**The Cooper Heater Co., Dayton, Ohio**

10

# Bonding Time will be at hand soon!

Before then—right *now*, in fact—you should investigate the modern bonding methods—

## Electric Brazing AND Copper Welding

—because, of course, you want the best bonding at economical cost. And *best* means perfect mechanical and electrical union, giving greatest conductivity and longest life. Ask us for the names of users—then investigate in your own way.

**The Electric Railway Improvement Company**

6005 Carnegie Ave. - - Cleveland, Ohio

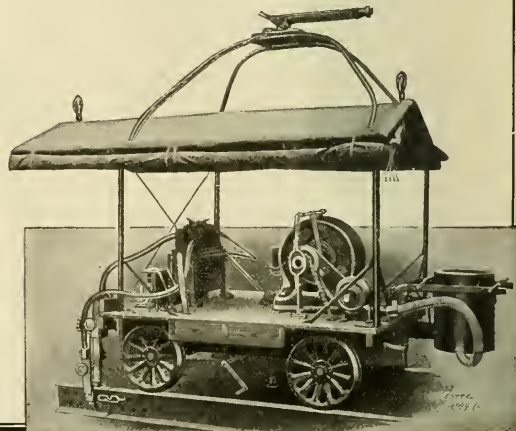

9

# Electric Railway Review

PUBLISHED EVERY SATURDAY BY THE WILSON COMPANY, CHICAGO

Entered as second-class matter January 5, 1907, at the postoffice at Chicago, Ill., under the act of March 3, 1879.

160 Harrison Street, Chicago  
150 Nassau Street, New York  
1529 Williamson Bldg., Cleveland

Vol. XIX  
No. 12

CHICAGO, MARCH 21, 1908

Whole No.  
256

Subscription: Domestic . . . \$2  
Foreign . . . \$5  
Canada . . . \$3.50

Representatives of afternoon newspapers in Chicago made an organized attempt this week to prevent the Chicago City Railway from enforcing an order prohibiting the sale of newspapers on the new pay-as-you-enter cars. Under the guise of a newsboys' riot, but actually under the leadership of the circulation managers of evening papers, a crowd of carriers and adult hoodlums posing as their friends and sympathizers tried to board the pay-as-you-enter cars in the congested district during the evening rush hours. When refused admittance to the cars the gangs assaulted the conductors, pulled trolleys from the wires and caused blockades. The trouble lasted during the two evening hours when traffic is heaviest. One of the principal advantages assured to the public by the introduction of pay-as-you-enter cars is that the conductors on such cars do not force their way through aisles that may be crowded, jostling the passengers while collecting fares. To allow the newsboys to rush through the cars in heedless fashion would perpetuate the kind of discomfort that was caused by conductors under the old plan. The company is unquestionably maintaining its rights and doing its duty by passengers. Now that hostilities have been suspended pending the trial of the rioters who were arrested, it is to be hoped that the position of the company will be upheld.

In the circular published in another part of this issue the committees of the American Street and Interurban Railway Association emphasize the possibility that a large number of electric railways do not realize the great importance of the interstate commerce commission's tentative classification of operating expenses. This

**Circular Should be Answered.**

federal commission has jurisdiction over every electric and steam railway located in two or more states, and over every intrastate railway which engages, in connection with one or more other lines, in the transportation of persons or property in a continuous movement from a point in one state to another state. The system which the commission prescribes for electric railways the accounting methods of which it can control will probably be adopted by the authorities of 30 states, who have indicated their approval of the scheme. The complaint that the circular of the commission was issued so late that insufficient time is allowed for consideration of its provisions, is well founded. The delay was caused by the government printing office, which has been similarly slow in printing the various circulars issued in relation to the accounting system for steam roads. Every electric railway should avail itself of the opportunity to place before the interstate commission a criticism of the tentative classification. It is to be regretted that the commission has even tentatively set the gross earnings of those roads which will be permitted to use the abbreviated classification of operating expenses as low as \$50,000. This figure is not approved by representatives of important commissions. William O. Seymour, a member of the Connecticut commission, suggested in the statement published in the Electric Railway Review for January 11, 1908, that only certain essential accounts should be required of roads with gross earnings of not exceeding \$200,000 per annum. Thomas Yapp

of Minnesota suggested \$75,000 as the line of demarcation. The figure favored by Mr. Seymour appears exceedingly liberal in the light of the interstate commission's circular, but the limit should be set even higher if the mistake of saddling the roads with abnormally large accounting expense is to be avoided. Your opinion as to the proper figure should be sent to the interstate commission.

The commutator is intrinsically the weakest part of all direct-current machinery. Brush and brush-holder troubles are often the causes of motor failures. In the long run it is probable that rough commutators are responsible for much of the trouble occurring at the brush-holder, though sometimes an inferior brush or a poorly adjusted spring will cause sparking. The best spring tension to use under definite conditions is a matter to be determined more by trial than by theory. Given a commutator with smooth, even bars it is safe to say that a wide range of brush-holder spring tension can be employed without undue arcing. The use of very low tensions on the springs tends to allow the brushes to be jarred off easily when a rough spot is met. As the tension is increased the brush holds closer to the bar, even in the face of irregularities. In many car houses the brush tensions are adjusted according to the personal judgment of the inspector, and there is no doubt that if all car houses were supplied with small spring balances and records kept of the most satisfactory brush tensions on different styles of motors, the present uncertainty of the proper tension to use that obtains in many cases would be largely done away with. A weekly inspection and cleaning of the brush-holder and the application of a little shellac is a precaution that will cost little and will tend to keep the holders in first-class condition. These features of maintenance are in themselves small matters, but when applied on a large scale they go a long way toward preventing the withdrawal of cars from service on account of motor failures.

The street paving problem is a troublesome one for the railway and the municipality. A most important factor necessary

**Wood Paved Streets.**

for satisfactory paving between rails is the track substructure. Advancements in track construction methods and in the design of rail sections now places within the command of any railway company a track substructure which will withstand the severe loads imposed by heavy car and truck traffic. Given such a track substructure the engineer is next confronted with the task of choosing a paving material satisfactory to both the railway company and the municipality. For nearly a hundred years wood has been used for street paving and now the forest service of the United States department of agriculture is making extensive studies and many experiments with a view to determining the value of various woods and preservatives for wood paving. In the course of its studies the forest service has gathered data upon creosoted block pavements from nearly every city in the United States which has laid them and from those creosoting plants which treat wood paving blocks. The data

thus obtained, together with the conclusions, are presented in a bulletin of the department. As yet the approved creosoted wood block pavements have not been down long enough to warrant the government engineers in making final conclusions, but by reading between the lines one learns that wood blocks treated with a well chosen preservative and properly laid afford a street surface which will outwear granite blocks. The comparative favorableness, to travel of wood blocks and granite is so decidedly on the side of the wood block pavement that we may look to its more general adoption by municipalities.

#### COMPENSATION PAYMENTS OF CHICAGO ELEVATED LOOP.

The earnings from operation of the Chicago Elevated loop are derived almost entirely from the lessees under the unique provisions of the lease whereby the loop is the principal central business district terminal for four elevated railway systems extending into the outlying sections of the city. The leases with the Union Elevated Railroad Company, the property and stock of which have been acquired by the Northwestern Elevated Railroad, provide that each of the four lessees shall pay to the lessor, the Union Elevated company,  $\frac{1}{2}$  of 1 cent for every paying passenger carried on its lines without regard to whether the passengers ride on the loop structure or not. In addition to the payments as rentals under this provision, the four companies, the Northwestern Elevated Railroad, the Metropolitan West Side Elevated Railway, the Chicago & Oak Park Elevated Railroad (the reorganized Lake Street Elevated Railroad) and the South Side Elevated Railroad, are required to pay large expenses of maintenance and operation. The lease, which was executed on December 19, 1904, is explicit in its stipulations concerning these expenses. A power house furnishes power for the operation of the trains on the loop, and the lessees must pay the entire cost of the "maintenance, renewals, repairs and operation, including the taxes, assessments, insurance and ground rent," not only of the power house itself, but also for its apparatus, machinery and connections. The lessees also agree to pay the entire cost of "maintenance, insurance, renewals, repairs and operation of the tracks, ties, switches, signals and signal towers," and the cost of the operation of stations. The expenses of taxes, assessments, maintenance, repairs and renewals of the structure proper and the stations are to be borne by the lessor. The lessees are not to be charged with the compensation to the city or with claims or judgments for damages to abutting or adjoining property.

The loop structure comprises 20,900 feet of single track. The outstanding bonds on the property are about equal to the amount of outstanding stock, \$5,000,000. This stock was purchased in 1901 at \$125 a share, or a total of \$6,250,000, by the Northwestern Elevated Railroad, which later absorbed the loop property. To meet the capital expenditure necessitated by this investment, the Northwestern company issued its 4 per cent first mortgage and refunding bonds.

The 50-year franchise under which the loop of Chicago is operated provides for an annual distribution of earnings with the city of Chicago after provision is made for the interest on about \$5,000,000 of first mortgage 5 per cent bonds. During the five years beginning on January 1, 1897, there was paid annually to the city, after provision had been made for this bond interest, but before any allowance was made for the expenses not borne by the lessees, 5 per cent of the earnings. During the ensuing period of five years, the compensation was increased to 10 per cent per annum. During the 10-year term which began on January 1, 1907, the city is to receive 15 per cent annually. In the 15-year term beginning on January 1, 1917, the rate is to be 20 per cent per annum, and for the remainder of the term the city is to receive 25 per cent per annum upon the conditions stated.

Under this compensation feature of the ordinance the city has just received the first payment at the 15 per cent rate. It amounted to \$71,028.44, a much larger sum than has been paid in any preceding year. Payments of compensation since the operation of the loop was begun aggregate \$271,903.19, as follows:

Year.	Per cent.	Compensation.	Totals.
1898.....	5	\$ 4,956.45	
1899.....	5	7,196.97	
1900.....	5	9,142.87	
1901.....	5	11,402.07	
			\$ 32,698.36
1902.....	10	\$28,258.03	
1903.....	10	32,436.84	
1904.....	10	31,943.71	
1905.....	10	36,114.08	
1906.....	10	39,423.73	
			168,176.39
1907.....	15	\$71,028.44	71,028.44
			\$271,903.19

The payment of \$71,028.44 as compensation for 1907 indicates net earnings for the company, after the payment of bond interest, of about \$473,523. From this sum, however, the company had to meet the expenses accruing under the terms of the lease, the extent of which, although unknown, must be large. Subject to these expenses, earnings before deduction of the bond interest were about \$723,523.

There is no reason to doubt that the return on this investment will grow much larger as the density of traffic on the loop continues to increase. The loop is in the remarkable position of receiving revenue from passengers carried by lessee roads into stub terminals. The Metropolitan Elevated, the Chicago & Oak Park Elevated and the South Side Elevated roads have stub terminals which accommodate part of their traffic during rush hours.

The terminal expense which must be borne by the lessee roads on account of their lease with the loop company is 10 per cent of their gross passenger earnings plus the additional expenses outlined. In 1907 the total loop rental and expenses paid by the South Side Elevated road amounted to 14.5 per cent of its gross passenger earnings; with the Metropolitan road the expense was 14.6 per cent. While this seems large, it is evident that without the terminal facilities which the loop provides the elevated railways would be seriously hampered. It is necessary for urban street railways to have terminal facilities in the heart of the business district. Such terminal facilities must be provided, even if the expense is large.

Although the franchise under which the Union Elevated loop is operated is for 50 years, the lease with the tenant companies is to last so long as the loop shall be permitted to be maintained under existing ordinances or under any other legal authority which may hereafter exist. Because of the importance of the loop to the people who depend upon its facilities, it may be assumed that the structure will remain standing under a new franchise providing for a continuance of the profit-sharing arrangement, which will yield much more to the city as time passes. It may also be assumed that the Northwestern company, which owns the loop, will not admit the inadequacy of the loop until many radical changes in operation have been made with the object of facilitating the operation of trains. Changes which this company deems desirable now were outlined in the report of Ford, Bacon & Davis, published in the Electric Railway Review of February 29, 1908, page 268.

The compensation paid to the city is wholly a charge upon the earnings from the loop proper. The compensation is not a tax upon the operating railways, unless it be considered that in the computation of the rental of  $\frac{1}{2}$  of 1 cent a passenger, when the terms of the lease were originally settled, allowance was made with the idea that the payment should be virtually redistributed from the lessor to the lessee companies.



ANNUAL REPORTS.

Toronto Railway Company.

Gross earnings of the Toronto Railway Company increased 12.9 per cent in 1907 over 1906, operating expenses increased 15 per cent and net earnings gained 10.6 per cent. The increase in operating expenses is due principally to an advance in wages of employes made last June. The figures for three years compare as follows:

	1907.	1906.	1905.
Gross earnings .....	\$3,511,197	\$3,109,740	\$2,747,324
Operating expenses .....	1,893,236	1,646,515	1,560,437
Net earnings .....	\$1,617,961	\$1,463,225	\$1,186,887
Taxes, charges, etc. ....	721,802	647,129	544,303
Net divisible income. \$	896,159	\$ 816,096	\$ 642,584
Dividends .....	473,378	460,241	350,000
Surplus .....	\$ 422,781	\$ 355,855	\$ 292,584
Special appropriations ..	125,000	100,000	50,000
Surplus .....	\$ 297,781	\$ 255,855	\$ 242,584
Operating expenses—per cent of gross earnings .....	53.9	52.9	56.8

The taxes, charges, etc., for 1907 as shown in the foregoing, included payments to the city of Toronto for taxes, percentage payments under franchise and pavement charges aggregating \$542,091, an increase of \$74,725 over the corresponding payments during the previous year. These payments equaled the large proportion of 15.4 per cent of the gross earnings or 33.5 per cent of the net earnings. This is a heavy tax upon the revenue of the company. Since the railway began to operate under its franchise it has paid to the city a total of \$3,982,826 for taxes, compensation and paving charges.

In his report William Mackenzie, the president, states that comparatively few extensions were built on account of the opposition of the city council. Important litigation with the city was decided during the year in the favor of the company. The express business, although confined to lines operating over 28 miles of track yielded gross earnings of \$33,896, and will be extended.

There was expended for "extensions, additions and betterments" \$536,388, chiefly for the following purposes: Lands and properties, the purchase of which was deemed advisable to provide adequately for the future growth of the company; continuing the installation of underground cable connecting the substations and power house; completing 40 cars and for the first lot of 100 pay-as-you-enter cars; and in track extensions. The company operates 78 miles of track.

The cost of "road and equipment, real estate and buildings, including pavements," etc., was stated as of December 31, 1907, at \$13,541,020 as compared with \$13,104,632 at the close of the previous year. The stock was unchanged at \$8,000,000 and the outstanding bonds stood at \$3,613,373, the same as at the conclusion of the preceding year. Bills payable aggregated \$137,160.

The figures of passengers carried compare as follows:

	1907.	1906.	1905.
Passengers carried .....	85,574,788	76,958,488	67,881,688
Transfers .....	31,370,825	28,159,558	23,625,752

Mr. Mackenzie says that the legal department "had a particularly successful year in cases arising from injuries and damages claims, having won 15 out of 22 cases tried in the high court."

Consumption of Copper.

An interesting government estimate has been made showing that the use of copper in 1906 for electrical purposes was practically half the consumption; brass manufacturers used 30 per cent; in rolling mills and the manufacture of sheet copper 5 per cent were used, and for miscellaneous uses, principally castings, 15 per cent.—Steam.

# Communications

## THE TENTATIVE CLASSIFICATION OF OPERATING EXPENSES.

To the Editors:

Although it has been understood generally that the interstate commerce commission desired to have the primary accounts of the classification of operating expenses for electric railways correspond so far as possible to the accounts prescribed for steam railways, the tentative classification submitted differs from the steam railway classification in many places where it would be preferable to have the accounts conform more closely to the similar accounts in the steam railway classification.

In the general account "maintenance of way and structures," the classification prescribed by the interstate commerce commission for steam railways, effective on July 1, 1907, shows account No. 1 as "superintendence." As this account is very important, it should undoubtedly be given a place in the primary accounts, but in the tentative classification the expense of "superintendence" is included in account No. 15, "other maintenance of way expenses"; account No. 24, "miscellaneous electric line expenses," and account No. 32, "miscellaneous buildings and structures expenses." The plan outlined subdivides this expense between the various sub-headings of "maintenance of way and structures," which does not seem desirable.

Primary accounts are set up as follows: No. 3, "rails"; No. 4, "rail fastenings"; No. 5, "frogs, switches and special work." Why it is necessary to make these separate primary accounts is not clear. The classification for steam roads provides only two primary accounts, "rails" and "other track material," which appear ample for the purpose.

It will be observed that "stationery and printing" is included in account No. 15, "other maintenance of way expenses"; account No. 24, "miscellaneous electric line expenses"; and account No. 32, "miscellaneous buildings and structures expenses." Instead of the subdivision of this expense, a single primary account, "stationery and printing," under "maintenance of way and structures," would appear to be desirable.

In account No. 15, "other maintenance of way expenses," and account No. 24, "miscellaneous electric line expenses," the cost of "injuries to persons" is included, and in addition this expense is assigned a primary account, No. 42. The one primary account "injuries to persons" under "maintenance of way and structures" should be sufficient for all charges in connection with this item. A separate account, No. 39, is shown for "care of track," which appears to be superfluous when proper consideration is given to account No. 8, "roadway and track"; account No. 41, "cleaning, sprinkling and oiling roadbed"; and account No. 43, "other miscellaneous maintenance expenses."

In the general account, "maintenance of equipment," provision is made for "superintendence" in account No. 63, "other equipment expenditures." Under this same account provision is made for stationery and printing, insurance and injuries to persons. It would seem desirable that these items should be given primary account numbers instead of being included under one general head whereby their identity is lost.

Regarding accounts Nos. 47 and 48, it is not clear why a distinction should be made between passenger cars and combination cars, as both classes of cars are used for passenger service. The steam railway classification, which provides one account for passenger train cars, is preferable, particularly as the wages of motormen and conductors operating cars of these classes are not separated in the tentative classification. Separate accounts are set up for "express cars," No. 49.

and "freight cars," No. 51. It will be impossible for some railroads to make a distinction between express cars and freight cars, as the same cars are used for both purposes and are interchanged. It is not clear, either, why a separation should be made in the maintenance of these two classes of cars when the wages of motormen and conductors are not separated between freight and express.

Provision is made for the maintenance of locomotives in account No. 52. It does not appear that the classification makes proper allowance either for present conditions or for changes which time is rapidly bringing about. The account does not specify whether electric or steam locomotives are covered. It would seem desirable to separate the different classes, which, of course, could be done by making subdivisions of the accounts, as "a" and "b."

To accounts Nos. 53 and 54 the same criticism as to accounts Nos. 47 and 48 would apply. Concerning accounts Nos. 45 and 57, the same criticism as to accounts Nos. 49 and 51 is justified.

The classification of "traffic expenses" in the steam railway system would be more satisfactory than the accounts in the tentative electric railway classification. The importance of giving "superintendence" a primary account should again be emphasized under this general account. "Superintendence" should be separated from the expenses of outside agencies, as it is very important to separate the expenses of administration from expenditures made strictly for soliciting by an outside agency; and it would appear that "stationery and printing" should have a primary account instead of being included in account No. 72, "traffic supplies and expenses."

"Superintendence," account No. 88, includes in the tentative classification the dispatching of trains, an expense which, it appears, is of sufficient importance to be entitled to a primary account number.

"Express service" is shown as account No. 98. In view of the fact that the compensation of certain employes might be divided between this account and other operating accounts, it is not plain how amounts to be charged to this account should be ascertained. If it is desired to show the expenditures on account of express service separately, some basis of apportioning the expenses between the proper accounts may be selected, if "express service" is interpreted to mean simply wagon service, picking up shipments of express and delivering them at destination.

Primary account numbers are given to "superintendence," "insurance," "injuries to persons" and "stationery and printing" under both "transportation expenses" and "general expenses." This would make it desirable to give such items primary account numbers under "maintenance of way and structures" and "maintenance of equipment," instead of carrying them in "miscellaneous expenses" under those two general accounts.

It does not appear that the clearing accounts are necessary in the classification of the operating expenses of electric roads. These accounts do not seem to be used in the steam railway classification.

Although the method suggested for accounting for the various "joint facilities" accounts is different from that which has been followed generally by electric railways, such accounts could undoubtedly be handled as the interstate commerce commission appears to desire. The accounts seem to be outlined in the same manner as in the steam railway classification.

An objectionable feature of the classification is the large number of primary accounts. Heretofore electric roads have never used so many primary accounts in their classifications of operating expenses. In addition to the other changes which appear desirable, I am inclined to believe that the accounts assigned to "maintenance of electric lines," eight in number, might with advantage be reduced to three primary accounts, as follows: "High tension transmission lines," "distribution system" and "conductors." Instead of using seven primary accounts for "maintenance of buildings and structures," as shown in the tentative classification, the ex-

penses could be shown in one or two primary accounts. Instead of separate primary accounts covering passenger, combination and mail cars, the expenditures for these cars could be carried in one account, and as it is not feasible or desirable for many roads to separate the expenses on account of freight and express cars those expenses should be combined.

In brief, in my opinion the number of accounts should be reduced as indicated and the additional primary accounts, namely, "superintendence," "insurance," "injuries to persons," and "stationery and printing," should be added under the general accounts, "maintenance of way and structures" and "maintenance of equipment."

With these changes, it would appear that the tentative classification should prove satisfactory to interurban electric railway lines, and if any further changes are made it is hoped that the interstate commerce commission will make these changes with a view to conforming more closely to the steam railroad classification and not diverging from it, as several items in the tentative classification would indicate has been done.

AUDITOR.

#### QUARTERLY MEETING OF THE NEW YORK STATE ASSOCIATION.

The Street Railway Association of the State of New York held its regular quarterly meeting in the commodious rooms of the Ft. Orange Club at Albany on March 18.

The meeting was an executive session and was devoted almost entirely to a discussion of the interstate commerce commission's tentative classification of operating expense accounts. A committee was appointed to study the proposed system and formulate a report in the form of a resolution, which will be presented to the public service commission of New York, second district, and to the interstate commission. A meeting of this committee will be held on March 23 at Buffalo, in the office of T. W. Wilson, president of the association. This committee is as follows:

Henry J. Pierce, president International Railway Company, Buffalo.

Edgar S. Fassett, general manager United Traction Company, Albany.

C. Loomis Allen, vice-president and general manager Syracuse Rapid Transit Company and Utica & Mohawk Valley Railway.

A. L. Linn, Jr., general auditor Mohawk Valley Company. J. C. Collins, secretary and auditor Rochester Railway.

H. M. Beardsley, secretary and treasurer Elmira Water Light & Railroad Company.

A short discussion took place concerning the merits of a bill before the legislature making it necessary for a conductor to have a license. The bill was read in part before the meeting and was found to contain clauses unfair to the railways and destructive to good service. In case the bill becomes a law as it now stands it will be necessary for an applicant for the position of conductor to be a resident of the state one year prior to the time of his application for a conductor's license and then to have 30 days' actual experience over all the lines of the system on which he is to work. The following committee was appointed to represent the association at a hearing regarding the bill on the afternoon of that day: Daniel M. Beach, Rochester Railway; W. W. Cole, Elmira Water Light & Railroad Company; Mr. Norton.

The following attended the meeting:

Albany—Edgar S. Fassett, general manager, Arthur J. Gies, auditor, United Traction Company.

Albion—J. M. Campbell, Buffalo Lockport & Rochester Railway.

Buffalo—Edward H. Stichel, general auditor Buffalo & Lake Erie Traction Company; H. J. Pierce, president, T. W. Wilson, general manager, D. M. Deininger, auditor, Morris Coban, Jr., International Railway Company.

Cortland—G. H. Garrison, secretary Cortland County Traction Company.

Elmira—W. W. Cole, vice-president and general manager Elmira Water Light & Railroad Company.

Gloversville—W. H. Collins, general superintendent,

George A. Harris, general auditor, Fonda Johnstown & Gloversville Railroad.

Kingston—C. Gordon Reel, vice-president and general manager Kingston Consolidated Railroad.

Newark—R. A. Dyer, Jr., assistant general manager Rochester Syracuse & Eastern Railroad and Auburn & Syracuse Electric Railroad.

New York City—A. L. Linn, Jr., general auditor, F. B. Lasher, traveling auditor, Mohawk Valley Company; Joseph K. Choate, assistant to president Oneonta & Mohawk Valley Railroad; T. B. Bradley, auditor Richmond Light & Railroad, Staten Island Midland Railroad (borough of Richmond); J. H. Pardee, managing director J. G. White & Co.; James Marwick, chartered accountant Interurban Traction Company.

Oneonta—W. C. Austin, auditor Oneonta & Mohawk Valley Railroad.

Poughkeepsie—J. W. Hinkley, Jr., president Poughkeepsie City & Wappingers Falls Electric Railway.

Rochester—E. J. Cook, general manager, J. Clarence Collins, secretary and auditor, Rochester Railway; Daniel M. Beach.

Schenectady—E. F. Peck, general manager, D. C. Dibbell, auditor, Schenectady Railway.

Syracuse—J. M. Joel, auditor, C. Loomis Allen, vice-president and general manager, Syracuse Rapid Transit Railway and Utica & Mohawk Valley Railway.

At a meeting of the executive committee on March 17 it was decided to hold the next annual meeting of the association at Niagara Falls on June 30 and July 1. The annual banquet will be held on the evening of June 30.

**ASSOCIATION CIRCULAR ON CLASSIFICATION OF OPERATING EXPENSES.**

A circular letter concerning the tentative classification of operating expenses has been addressed to the presidents of electric railways of the United States by George H. Harries, chairman of the American Street and Interurban Railway Association committee on "Classification," and W. F. Ham, chairman of the American Street and Interurban Railway Accountants' Association committee on "Classification." The letter, of which an abstract follows, is headed "Urgently Important":

**Importance of the Classification.**

In view of the possibility that a large number of the street and interurban railway companies have not realized the great importance of the tentative classification of accounts set forth in Circular No. 20, recently distributed by the interstate commerce commission, the special committees of the American and the Accountants' associations urge your active interest in this matter at this time.

It should be clearly understood that the proposed classification will, when it becomes effective, govern the accounts of practically every electric railway in the country; directly where the roads do interstate business and indirectly where state commissions follow the orders, rulings and methods of the federal commission—a condition which the federal commission expects soon to exist. It is therefore imperative that all companies furnish the interstate commerce commission (and this association, in duplicate) with criticisms or opinions as to the tentative classification.

Conceding the difficulty of anything like complete dissection or discussion of the classification within the time limit, it is undoubtedly practicable for you to select and comment upon those features of the scheme of which you approve or disapprove. Should there be primary accounts which you deem unnecessary, or should the grouping be out of accord with practice which experience has shown to be valuable or essential, it is most desirable that the facts be now presented, to the end that the expressed desires of the federal and state authorities harmonize, as nearly as may be, with the business needs of the electric carriers.

In this work, whether it be much or little, and regardless of the size of your company, the committees beg your earnest and prompt co-operation; without which nothing good can be accomplished. The information requested should be furnished promptly, the date set by the interstate commerce commission being March 28. If you find it impossible or impracticable to digest the circular by that day we shall appreciate notification to that effect, together with a statement as to the probable date when your answers will be forwarded.

It is suggested, in order to develop the practicability and application of the proposed classification to the electric railway industry, that each company subdivide its 1907 operating

expenses among the proposed accounts, in as approximate an estimate as time and convenience will permit.

Several companies represented upon your committees have already made such approximate estimates in a short time, and the results appear to be of great practical value.

To this end there is inclosed, in triplicate, data sheet No. 26, for this operating expense classification, which also contains the form for questions of the commission. Please fill out and send one copy to Prof. Henry C. Adams, in charge of statistics and accounts, interstate commerce commission, Washington, D. C., and one copy to B. V. Swenson, secretary American Street and Interurban Railway Association, New York, N. Y.

**The Data Sheet.**

The data sheet inclosed with the circular contains both the abbreviated and the tentative classifications of operating expenses, published in the Electric Railway Review of February 29, 1908. The percentage of total operating expenses charged to each primary account is desired. The abbreviated classification is to be used by companies with annual gross revenue of less than \$50,000 and the amplified classification by companies with annual gross revenue of \$50,000 or over. The data sheet also contains a list of questions submitted by the interstate commerce commission in its circular and states: "It is not intended that the answers made to this inquiry should be confined to the specific questions enumerated; on the contrary, any criticisms and suggestions pointing to the improvement of the classifications are invited." Information is desired upon the following points:

Name of company; number of miles of line operated; number of cars operated under normal conditions. Do you favor dividing electric lines into two classes, as outlined in this circular? What limit, in your opinion, should be used as a line of demarcation indicating the distinction between a large and a small company? What was the gross revenue of your company as shown in its last annual report? What is the present surplus (or deficit) from operation of your company, and in what particular years did it accumulate? Please give a list of joint facilities involved in the operations of your company. [See accounts Nos. 45, 46, 66, 67, 104, 105, 115 and 116, Electric Railway Review of February 29, 1908, page 267.—Eds.] Do you consider the principles involved in the joint facility accounts as applicable to electric railway carriers?

General criticisms are also invited regarding the classification.

**SOUTHWESTERN ELECTRICAL AND GAS ASSOCIATION.**

H. T. Edgar, president, Ft. Worth, Tex., announces that the next annual convention of the Southwestern Electrical and Gas Association will be held in El Paso, Tex., on May 7, 8 and 9. Arrangements have been made for the following papers to be read:

"Wood Preserving," by Prof. E. P. Schoch, University of Texas.

"Track Construction," by Mark Lowd, Dallas, Tex.

"Gas Engines and Producers," by W. B. Tuttle, San Antonio, Tex.

"Various Forms of Electrical Illumination, and their Efficiency," by C. W. Kellog, Jr., El Paso, Tex.

"Gas Meters," by A. J. Myler, Jr., Dallas, Tex.

A general discussion will be held on the question "What Policy Should be Pursued by Public Service Corporations in Making Extensions?" H. S. Cooper, manager of the Galveston Electric Company, and Frank E. Scoville, general manager of the Laredo Electric & Railway Company, have been appointed to lead the discussion for the street railway companies. The complete programme of the different sessions and of the entertainments will be announced later.

The St. Regis hotel has been selected as the headquarters of the association for the convention. The rates are: For rooms without bath, \$1.50 per day; for rooms with bath, \$2.00 to \$3.00 per day, on the European plan. The hotel has offered ample facilities to the supply men for exhibition purposes and arrangements have been made with the El Paso Electric Railway to furnish current for the exhibits.

R. B. Stichter, 609 Juanita building, Dallas, is secretary of the association.

### THE CHICAGO & SOUTHERN TRACTION COMPANY.

BY D. C. HINSTORFF

Through service between Chicago and Kankakee was begun on October 5, 1907, by the Chicago & Southern Traction Company, thereby establishing a connecting link for the pro-



Chicago & Southern—Typical Roadway, Bridge and Overhead Construction.

posed Chicago-St. Louis and Chicago-Indianapolis trolley routes.

The main line of the new road extends from Seventy-ninth and Halsted streets, Chicago, to the heart of Kankakee, a distance of 51.64 miles, and serves the towns of Blue Island, Harvey, Chicago Heights, Steger, Crete, Monee, Peotone, Manteno, Tucker and Bradley. A storage battery line owned and operated by the Chicago Electric Traction Company from Chicago to Harvey, a distance of 12 miles, with branch lines to Morgan Park and Calumet Grove, was the beginning of this promising interurban system. The equipment consisted of single-truck motor cars and trailers, mounted on Dupont trucks, which were constructed with a long wheel base in order to allow ample room for carrying the storage cells. A train made up of a gasoline-electric motor car and trailers was operated on the Calumet Grove branch for handling picnic parties to and from a park at the terminus of that line. Proving itself expensive and unpractical under conditions existing at that time, the storage battery system was changed to the overhead trolley system.

The property of the Chicago Electric Traction Company was acquired by the Chicago & Southern Traction Company in order to give the latter road an entrance into Chicago over its own tracks. The Southern company, together with the Detroit & Toledo Construction Company, built that portion of the line from Harvey to Kankakee, a distance of 40 miles,

besides making extensive improvements on the original line.

The terminal facilities of the road are excellent. At Seventy-ninth and Halsted streets direct connections are made with two trunk lines of the Chicago City Railway Company to the business center, while a spur from the main line at Eighty-first street to Sixty-third street and South Park avenue, where the "White City," the largest amusement park in Chicago, is located, connects with the South Side Elevated Railroad and suburban and interurban lines to points south and southeast.

The Kankakee terminal is centrally located and is likewise the terminus for all the lines of the two local systems radiating from that point. Eventually interurban lines may be built from Kankakee to Lafayette, Ind., and Champaign, Ill., connecting with the Indianapolis & Northwestern Traction Company and Illinois Traction System, respectively. The new road runs through a rich farming country and serves a population of approximately 85,000 outside of the Chicago city limits. Numerous industries are located along the line, one town alone, Chicago Heights, having 47 manufacturing establishments.

A large tract of land, lying about midway between the termini, has been purchased and will be converted into a pleasure park. An abundance of shade trees, deep ravines, a lake and flowing stream make it a most picturesque spot.

Five cemeteries are reached by the Morgan Park branch, which gives the company considerable funeral traffic. One funeral alone has required as high as 23 cars, while others were handled with not less than 10 cars. Statistics show that during the past year the three oldest of these cemeteries had a burial average of 14 per day. It is the intention to add three more funeral cars to the present equipment.

#### Track and Roadway.

Outside of towns the road is built on private right of way, 50 feet wide, enclosed in American Steel & Wire Company's large mesh fencing, with wooden cattleguards and wing fences at highway crossings. Tangents 10 miles in length and shorter ones, connected by high-speed curves, with a comparatively



Chicago & Southern—Single-Ended Interurban Car.

level track, give the road an exceptional opportunity for limited service, which it proposes to operate in the near future. The maximum grade is 1 per cent, the deepest cut about seven feet, and the highest fill comes close to the same measurement.

Seventy-pound Pennsylvania Steel Company's T-rails are

laid on chestnut ties and 6 to 8 inch stone ballast from the company's own quarry. The rails are connected with 4-hole continuous rail joints and bonded with American Steel & Wire Company's pin-driven rail bonds. The highways are paved to the height of the rail with crushed rock and a single plank outside of each rail. This method of construction was found to be a decided improvement over the all-plank crossing, as the latter causes considerable annoyance during the winter months, due to the heaving of the planks. The sidings are of the through and stub types. The stub sidings will later be continued and built through. Ys are located at convenient

and Eighty-eighth street and Vincennes road, Chicago, and at 33,000 volts to the Chicago Heights, Monee and Bradley substations. The company in turn sells current to the Chicago Heights street railway, North Kankakee street railway and the Peotone Lighting Company, whose consumers use induction motors exclusively for manufacturing purposes. A lower potential was adopted for the Chicago and Blue Island transmission lines on account of running through a densely populated territory.

**Substations.**

The substation buildings are of brick, with concrete foundations, concrete floors and tile roofing. When fully completed the Chicago Heights substation will have a waiting room, ticket office and baggage room, in addition to the operating room and high-tension chamber. The floor plan illustrates the general layout of the station.

The Blue Island substation, an interior view of which is shown, has two 500-kilowatt 600-volt rotary converters, fed by six 185-kilowatt oil-cooled transformers, which step down the alternating-current voltage to 430 volts. Each of the other substations has one rotary and three transformers, but is built large enough to house a duplicate equipment. The negative side of the rotaries is connected with the track rails by four 300,000-circular-mil cables. All electrical apparatus is of General Electric manufacture.

**Rolling Stock.**

The passenger rolling stock consists of 10 double-truck interurban cars, 15 double-truck city and suburban cars, 15 single-truck closed motor cars, 25 single-truck 10-bench open motor cars, 15 single-truck 19-bench open trailers and 1 funeral car.

A McGuire-Cummings sweeper, a Dupont snow plow and two work cars, equipped with air operated nose plows, consti-



Chicago & Southern—Interior Blue Island Substation.

points along the line to facilitate reversing the single-end cars as called for by the schedule and in cases of emergency.

Below Peotone the road runs underneath the Illinois Iowa & Minnesota Railway through a concrete subway. All grade crossings are protected with Buda derails. The largest bridge on the line is below Manteno. It is of steel construction, 100 feet in length, and rests on concrete abutments.

On city streets, with practically all double-track construction, 80-pound Lorain girder rails are laid with tieplate braces on every tie. The girder rails are connected with 4-hole Atlas rail joints and bonded with "protected" rail bonds, furnished by the Electric Service Supplies Company. Buda spring switches and switchstands are used throughout the line.

The overhead material, which was furnished by the Ohio Brass Company, is supported by 35-foot Idaho cedar poles, with 14-inch bottoms and 8-inch tops, placed 110 feet apart. In Blue Island and Harvey steel poles have been erected.

Over single track two parallel No. 00 grooved trolley wires are hung on twin hangers from 9-foot Richmond flexible side brackets with 1/4-inch and 5/16-inch strand. Side pole span suspension is employed over double tracks with the same gauge trolley and span wires and single straight-line hangers.

The transmission lines, consisting of three No. 4 copper wires each, are carried on 100,000-volt double-peticoat high-tension insulators mounted on steel pins. One wire runs along the top of the pole and the other two are supported on 4 by 6 inch by 7-foot wood crossarms, which are braced with galvanized iron angle bars about 8 feet above the 2 by 4 inch by 4-foot crossarms supporting the telephone lines and 500,000-circular-mil feeders. Lightning protection is afforded by Garton lightning arresters, distributed five to a mile.

**Power.**

Power is purchased from the Blue Island plant of the Commonwealth Edison Company. Three-phase 25-cycle current is distributed at 9,000 volts to substations located at Blue Island



Chicago & Southern—Combination Work Car, Snow Plow and Ballast Spreader.

tute the snow fighting equipment. The work cars have a cab at one end and are mounted on St. Louis Car Company's No. 23A M. C. B. trucks. They are equipped with L-4 controllers, Westinghouse straight and automatic air brakes. A Baldwin type switching locomotive, 7 flat cars and 32 center dump cars make up the balance of the miscellaneous equipment.

The interurban cars are of the single-end vestibule type with smoking compartment, and were built by the St. Louis Car Company. The dimensions are as follows: Length over bumpers, 51 feet; length of the regular passenger compartment, 28 feet 8 inches inside; length of the smoking com-

partment, 11 feet 2½ inches inside; width of car, 8 feet 6 inches over all; height of car from rail to top of roof, 13 feet 2 inches; truck centers, 27 feet 6 inches.

The frames are of semi-steel construction, trussed by two truss rods 1½ inches in diameter with upset ends. The sills are composite and consist of yellow pine 5 by 8 inches, reinforced on the inside by 6-inch 8-pound channels. The center sills are of 6-inch I-beams with yellow pine fillers and the intermediate sills are of 4½ by 6 inch yellow pine.

The needle beams are of 5-inch I-beams trussed. The sides of the cars are constructed with ash posts and casings and are covered with narrow beaded poplar. The letter boards also are of poplar. There are seven double windows on each side of the car. The lower sashes are arranged to raise and are glazed with plate glass. The upper sashes are of Gothic

press, drill press, wheel and machinists' lathes and other machinery and tools necessary for maintaining the rolling stock in operative condition. The offices, which are located in the same building, will be enlarged and employes' club rooms and other conveniences will be added.

#### Operating Features.

In addition to a frequent local service, the present schedule provides a headway of 15 minutes to Blue Island, 30 minutes to Crete and 90 minutes to Kankakee. An hourly headway between Chicago and Kankakee will take the place of the present schedule in the spring.

A telephone dispatching system is used, the dispatchers' headquarters being at Harvey. Telephone booths with automatic cutouts, operated by the movement of the door, are located at all sidings, Ys, junctions and termini. Instruments are wall sets of Stromberg-Carlson make.

The personnel of the Chicago & Southern Traction Company executive and operating staff is as follows: Matthew Slush, president; C. J. Reilly, secretary and treasurer, Detroit, Mich.; W. H. Conrad, general manager; V. R. Ronk, auditor; J. E. Cooke, cashier; Charles Oldenburg, claim agent; J. P. Naumes, superintendent of transportation; E. E. Youngs, master mechanic; A. J.

Law, superintendent of construction; R. J. Bell, electrician; R. W. Renton, chief engineer, Chicago.

#### ARMATURE BANDING DEVICE.

Small roads having few cars cannot afford expensive equipment in their repair shops. The St. Francois County Railway, Farmington, Mo., is such a road, and J. L. Sullivan,

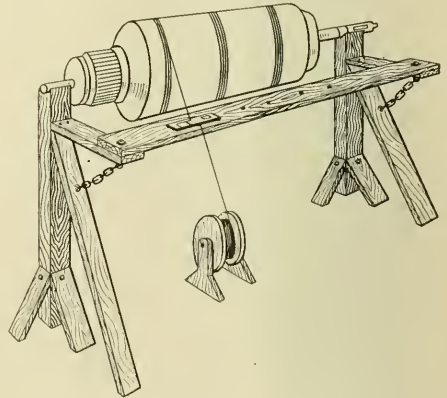

Simple Device for Banding Armatures.

master mechanic, has supplied the accompanying sketch showing his method of banding armatures without using a lathe. In the sketch as reproduced it will be noted that the armature rests on two special stands. Connecting with these stands and running alongside the armature is a 2 by 4 inch hardwood tension bar on which, by means of lag screws, fiber tension blocks can be placed to guide and place in tension the banding wire taken from a reel standing on the floor below. A special crank is arranged to fit the pinion end of the shaft so that the armature may be turned while placing the band wire.

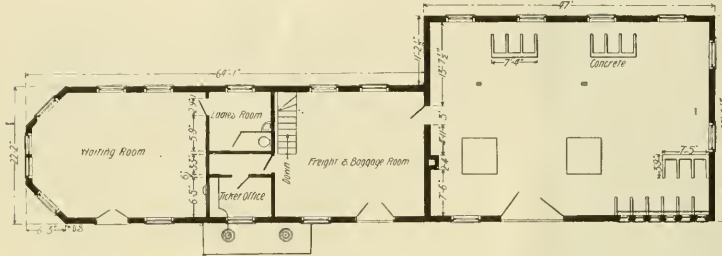

Chicago & Southern—Floor Plan, Combination Passenger Depot and Substation.

design and extend over the lower sashes. Mahogany interior finish and full empire ceiling painted a dark red, together with oxidized trimmings and high back, head roll, reversible seats upholstered in brown plush, give the car a handsome appearance. The seats in the smoking compartment are upholstered in black leather. Each car is equipped with drinking water and toilet room with dry hopper.

The cars are equipped with wood body pilots, Radiant No. 2 hot water heaters, arc headlights, parcel racks, whistles and gongs, and are mounted on St. Louis Car Company's M. C. B. high-speed forged steel trucks. The cars have four G.E.-74 motor equipments, type M control, Westinghouse straight and automatic air hand brakes, air sanders and trolley retrievers.

The city and suburban cars were built by the G. C. Kuhlman Car Company and are of the single-end semi-convertible type with smoking and passenger compartments and Detroit platforms. A steam coach roof is at the forward end. The motorman's cab takes up about two-thirds of the front vestibule and contains a Radiant No. 1 hot water heater in addition to the control equipment. There are 18 transverse seats with stationary backs and four longitudinal seats in each car, all upholstered in spring rattan. The ceilings are painted a dark green. A single sliding door opens into the smoking compartment from the front vestibule, a double sliding door leads from the passenger compartment to the rear platform and a partition and single swinging door separate the compartments. The cars are mounted on Brill No. 27 FE1 trucks with 4-foot 6-inch wheel base. The cars are equipped with 4-motor equipments, McGann storage air brakes, Peacock hand brakes, Ham air sanders, arc headlights, electric markers and Knutson trolley retrievers.

#### Car House and Shops.

The car house and shops are located at Eighty-eighth street and Vincennes road, Chicago. The building is at the present time in process of reconstruction. When completed each track will have an inspection pit and will lead out of the building independently. Air supply for cleaning purposes will be available at all tracks. The shops will be fully equipped with a wheel

### ARNOLD REPORT ON NEW YORK SUBWAY SIGNALS.

In an exhaustive report upon the subject of the signal and interlocking system in use in the New York subway, Bion J. Arnold, consulting engineer, has recommended to the public service commission that improvements be made in the signal apparatus by which less headway for express trains may be obtained without sacrificing the safety of passengers, and that after these improvements are perfected the local tracks be equipped with the same block signal system as is now used on the express tracks. An abstract of the report follows:

The present plan of express stations is criticized by saying that if they were double-decked or otherwise planned to allow the movement of express trains alternating on one and the other sides of express platforms, the capacity of the subways would be increased fully 50 per cent.

The signal changes he recommends would make possible a headway of 90 seconds, or 40 trains an hour, on both express and local tracks. At present the rate is about 30 trains an hour.

The signal system installed in the tunnel tracks of the subway system and on a part of the elevated structure is what is known as an electro-pneumatic system, the block signals being automatic and the interlocking, semi-automatic, that is, controlled by a lever in an interlocking machine and also by a track circuit. The local tracks between Brooklyn bridge and Ninety-sixth street station are but partly equipped with signals, these being placed principally at critical points where there are short curves. At certain points on the elevated structure where a supply of compressed air is not available, a number of signals have been installed, which are operated by solenoids using current from the third rail.

The existing signal system is as complete as it was possible to make it at the time it was put in (1904), but the art of signaling has made rapid strides since that time. According to the records furnished by the Interborough company for the two years from October 1, 1905, there were 155,064,894 signal and stop operations with 497 failures, or one failure to 312,001 of block and interlocking signal and automatic stop movements. This is considered a satisfactory test of the signal system in use, but it is believed that with new methods and appliances perfected since the installation of the system, it can be greatly improved.

Several observations were made of the movement of trains in the subway. The highest observed speed was 40 miles an hour. The usual speed of express trains at places favorable for fast running was 35 miles an hour. Heavily loaded northbound express trains leaving the Brooklyn bridge made 32 miles an hour.

At the Grand Central station, where the observations were confined to the movement of trains at express platforms, the number of trains moved an hour was 27 northbound and 29 southbound, and the average time interval between the arrivals of trains was 2 minutes and 12 seconds northbound and 2 minutes and 1 second southbound. The average length of stop was 58 seconds northbound and 35 seconds southbound. The shortest stop was 25 seconds on both tracks and the longest stop was 82 seconds on the northbound and 62 seconds on the southbound track.

The average length of time required for the trains to pass from Grand Central station block indicates that under present conditions, it is hardly possible to maintain a 2-minute headway upon the express tracks during rush hours.

There is a special signal placed just outside of each express station which operates to prevent approaching trains from running into a train standing at the station. Since the system was installed, this stop signal has been brought nearer the station platforms for the purpose of reducing the delay in trains stopped by it, and thereby increasing the capacity of the express tracks. Inasmuch as the alertness and attention of the motorman are relied upon to prevent collisions, Mr. Arnold thinks that some automatic device should be added so as to make the safety absolute in the case of signals at express stations. Final changes in the present system should move the automatic stop farther away from the platform, rather than closer to it.

The existing system with its automatic safety trip insures absolute safety on the express tracks between stations, and that it should be important to provide the same degree of safety in the station blocks by means of automatic stops.

As a temporary means of increasing the efficiency of the existing signal system, Mr. Arnold suggests a visual and audible signal to be given by the stopped train to a subway platform station attendant that the entering trains has been delayed to the extent of a full stop. He also suggests a manually operated switch whereby an attendant can release the

emergency stop holding the entering train and giving it the signal to proceed after the leaving train has begun to move. Much time is now lost, he says, because the proceed signal is not given to the motorman of the entering train until the last car of the leaving train has left the platform.

#### Conclusions.

(1) The subway signal system is in the main, modern, effective and well maintained.

(2) There is no reason, so far as the signal system is concerned, why a 90-second headway cannot be maintained.

(3) This 90-second headway will eventually be desirable upon both local and express tracks.

(4) The signal system at the present time does not afford positive safety at the approach to stations, as the motormen are relied upon to reduce the speed of the trains.

(5) In addition to the excessive platform waits, additional time is lost at each station stop by holding the following train a considerable distance out of the station until the leaving train has entirely cleared the platform.

(6) As at present operated delays at the station platform have a cumulative effect upon the following trains so that even one prolonged stop may disarrange the schedule for the entire hour.

#### Changes Recommended.

(1) That the necessary steps be taken to develop and install an automatic speed control signal system to be used as an auxiliary at station blocks which will allow the incoming train to safely approach the rear of the train at the platform and to enter the platform promptly upon the leaving of the outgoing train without sacrificing any of the standard of safety which is now maintained between stations.

(2) That during the development of the system there be installed at every express station the changes in the block signal system proposed by the Interborough company for Grand Central station. The equipment required for these changes will reduce the present possible headway by 7 seconds, and could ultimately become a part of the permanent recommended arrangement.

(3) That the subway officials consider, for the purpose of effecting temporary relief, the installation of a manually operated permissive signal at every express station to be used to expedite a delayed incoming train and thus overcome the cumulative effects on the schedule of a prolonged station wait.

(4) That the local tracks be protected by a complete block signal system when the automatic speed control system, herein suggested has been perfected.

(5) That, when the load on the subway increases to such an extent as to require additional conductors for carrying the electrical energy to and from the trains, the present signal system be altered so as to utilize both rails for carrying the return current, and at the same time make the system conform to the latest accepted practice whereby the signal system detects and indicates a broken or removed rail, provided the system shall at that time have proved superior to the single-rail system.

#### The Abandonment of 5-Cent Fares.

The Stone & Webster Public Service Journal for March discusses the recent address of P. F. Sullivan, president of the Boston & Northern Street Railway Association, before the Massachusetts Street Railway Association. An abstract of the article follows:

Street railway fares should vary in accordance with the principle that causes general prices to vary as conditions change. Nothing short of a varying transportation charge will place the street railways of Massachusetts in a financial position which, as honestly capitalized and honestly conducted business enterprises, they have a right to occupy. The salient fact with reference to the situation is, that as the street railways have extended into the rural districts they have decreased their income per track mile and increased their interest charge per passenger. The maintenance of the 5-cent unit of fare, in the face of these conditions, is what has produced the present situation. The company in New Bedford has resisted the temptation of the last 10 years to branch out into the country; as a result of this policy, its profits are 8.8 per cent on its capital stock and premiums, its interest charge per passenger being at a minimum point.

The Portland (Ore.) Railway Light & Power Company will open its large amusement park, The Oaks, on May 15. The resort will be operated directly by the railroad company this year, instead of being leased, as was the practice before last year.

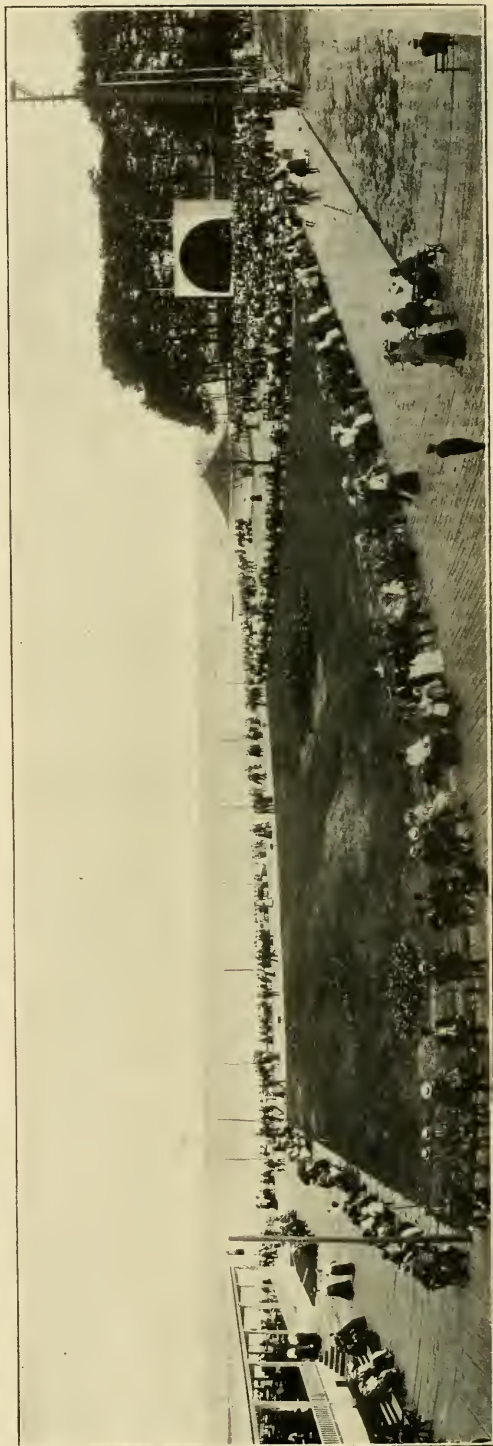
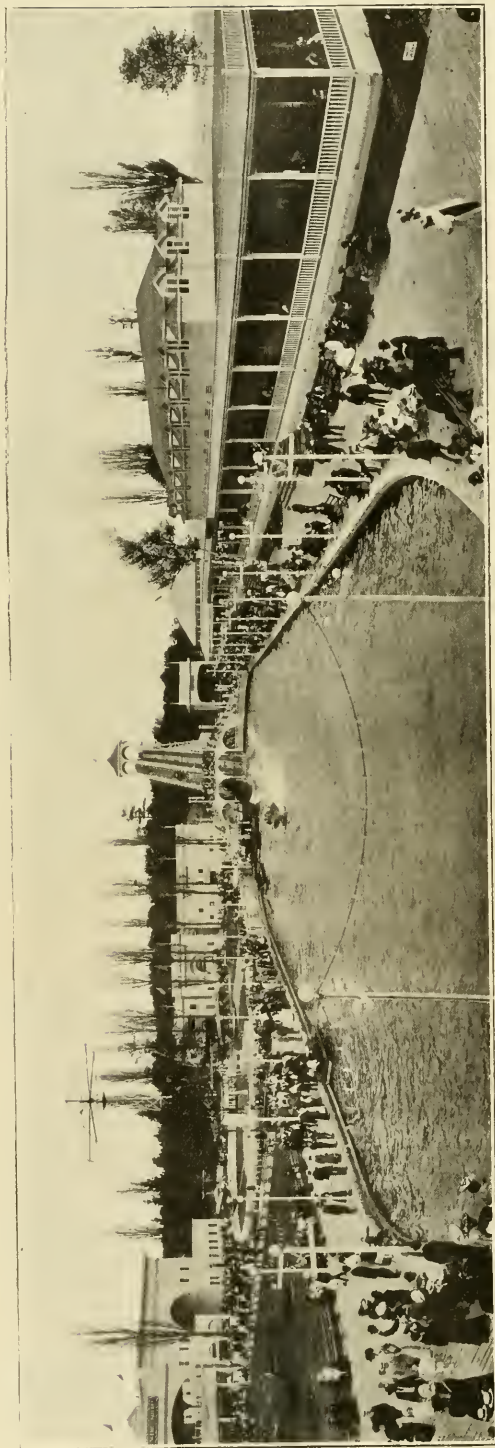

Scarboro Beach Park, Toronto—Panoramic Views of Grounds, Amusement Buildings and Lake Front.



**SCARBORO BEACH PARK, TORONTO, CANADA.**

We present herewith illustrations from Scarboro Beach Park, a summer amusement resort operated at Toronto, Ont., by the Toronto Park Company, Limited, in which the Toronto Railway Company is largely interested, and which adds greatly to the railway company's summer traffic.

The summer park idea had reached its full development in the United States long before it was introduced into Canada. The first Canadian enterprise of sufficient importance to rank with the pretentious parks of American cities was launched in Montreal several years ago. This venture proved such a novelty to the pleasure-loving French people, who form so large a portion of the population of that city that the park won an immediate success and turned the thoughts of its promoters toward other Canadian cities. Scarboro Beach, Toronto, came into existence as a natural sequence. Now the Beach is the premier pleasure resort, not only of the city of Toronto with its 300,000 population but of all Ontario, the largest and wealthiest province in Canada.

Scarcely more than a year ago H. A. Dorsey, whose enterprises of this character have been on an important scale in several cities, interested himself in the establishment of Scarboro Beach in Toronto. The Toronto Park Company was organized and the company secured a charming stretch of woodland comparatively close to the center of the city and situated on Lake Ontario.

Although the people of Toronto had enjoyed a well-managed amusement center, situated at Hanlan's Point, a short boat trip from the city, a street railway park of the character familiar to residents of American cities was comparatively new to them, and in spite of the fact that the opening season was handicapped by unusually cold and rainy weather, the park speedily took its place as the one of the most important summer institutions of the city. Toronto people are proverbially fond of aquatic sports and the Toronto Park Company speedily found that one of its greatest assets was its stretch of water front and sandy beach, reputed to be one of the finest on Lake Ontario. In the center of this beach the company erected Scarboro Inn, a commodious and modern restaurant with broad sweeping piazzas from which the patrons of the park witness the water sports. One of the most popular of these events is the war canoe race. The canoes, which are modeled after those used by the Indians, each carry a crew of 24 paddles, and the long slender craft are propelled through the water with marvelous speed and dexterity. To see the crews of several war canoes sweeping down to the finishing line after a mile race, is said to be more exciting than a close contest for the Vanderbilt cup.

The park, which is bounded on one entire side by Lake Ontario, has an area of 20 acres, a portion of which is still covered by the last representatives of the primeval forest. This grove is the natural adjunct of the beach, and is a most potent attraction for patrons of the park who come by daylight, being constantly in use for picnic and excursion parties. After 6 o'clock the grove is brightly illuminated. An artificial lake, 50 by 100 feet, with concrete walls, is used in connection with the Chute-the-Chutes, which is 80 feet high with a slide about 600 feet. Boats on the Chute-the-Chutes make the trip in 11 seconds, and the device is said to be one of the most solidly constructed in America. The scenic railway, which parallels the beach at the opposite end of the grounds, has 2,800 feet of track and has a passenger capacity of 28 people every 22 seconds. The railway is of modern and very substantial construction and is equipped with a block system of signals and specially designed improvements for loading and unloading passengers. The park company also operates all of the other devices of the grounds, including "The Old Mill," "San Francisco Earthquake," a roller skating rink, "Third Degree," "Infant Incubator," carousel, laughing gallery, shooting gallery, circle swing, cafe, "Bump the

Bumps," etc. The band concerts given by the Scarboro Beach band, under the direction of Conductor Richard Raven, were the means of attracting a great many people to the park during the last season. An instance of the attractive nature of the water aspects of the park is the fact that there are 210 bath houses on the grounds used by swimmers and bathers.

In addition to providing amusement for many thousands, the lake also provides the park with fire protection. The water is pumped through a special 12-inch intake pipe by two centrifugal pumps of 1,000 gallons and 500 gallons capacity per minute, respectively. The pumps are driven by separate electric motors. To supplement this service and to provide for emergency two 6-inch mains from the city water service are also connected with the park.

Scarboro Beach is a complete community within itself. It has its own government, its own army in the shape of a uniformed police force, its own navy represented by a fleet of



Scarboro Beach Park, Toronto—Electric Tower and Chutes.

small boats which patrols the lake in the interest of the bathers, its own hospital, fire department and its population of employes. This community, in spite of the unparalleled bad weather of its first season, attracted more than 500,000 people within its gates between June 1 and September 28, last year, and at the close of the summer it was a formidable rival to the Industrial Exhibition, Toronto's great annual fair.

A party of officers and directors of the Philadelphia Rapid Transit Company, city officials and others made an inspection trip through the new Market street subway in Philadelphia on March 12. At a banquet in the evening, James P. McNichol of the Millard Construction Company, which has the contract for the subway, announced that it would be ready for operation by September 1.

The Erie Railroad has abandoned passenger train service between Buffalo and Niagara Falls, N. Y., on account, it is reported, of electric railway competition.

## ASSOCIATION COMMITTEES.

To assist in carrying on the work of the American Street and Interurban Railway Association and its affiliated bodies during 1908, the following committees have been announced:

## American Association.

**Membership.**—H. H. Vreeland, chairman, New York; C. S. Sergeant, Boston, Mass.; W. Caryl Ely, Buffalo, N. Y.; F. G. Simmons, Milwaukee, Wis.; E. C. Foster, New Orleans, La.; B. B. Davis, Columbus, O.; C. M. Graves, Spokane, Wash.; F. R. Henry, St. Louis, Mo.; A. W. Warnock, Minneapolis, Minn.; H. J. McGowan, Indianapolis, Ind.; C. L. S. Tingley, Philadelphia, Pa.; W. A. House, Baltimore, Md.; S. W. Mower, London, Ont.; T. K. Glenn, Atlanta, Ga.; A. H. Ford, Birmingham, Ala.; J. H. McGraw, New York, N. Y.; H. M. Wilson, Chicago, Ill.; C. B. Fairchild, Jr., Cleveland, O.; Ernest Gonzenbach, Sheboygan, Wis.; P. P. Crafts, Clinton, Ia.; T. E. Mitten, Chicago, Ill.; A. H. Classen, Oklahoma City, Okla.; J. McMillan, Los Angeles, Cal.

**Subjects.**—T. E. Mitten, chairman, Chicago, Ill.; J. F. Calderwood, Brooklyn, N. Y.; R. I. Todd, Indianapolis, Ind.; F. R. Henry, St. Louis, Mo.; F. G. Simmons, Milwaukee, Wis.; H. R. Goshorn, Philadelphia, Pa.; C. L. Allen, Utica, N. Y.

**Compensation for Carrying Mail.**—G. T. Rogers, chairman, Binghamton, N. Y.; Robert McCulloch, St. Louis, Mo.; G. H. Harries, Washington, D. C.; W. B. McKinley, Champaign, Ill.; P. F. Sullivan, Boston, Mass.

**Insurance.**—H. J. Davies, chairman, Cleveland, O.; C. O. Kruger, Philadelphia, Pa.; G. L. Estabrook, Philadelphia, Pa.; A. H. Ford, Birmingham, Ala.; R. B. Stearns, Highwood, Ill.

**Municipal Ownership and Public Relations.**—W. Caryl Ely, chairman, Buffalo, N. Y.; J. B. Parsons, Philadelphia, Pa.; C. W. Wetmore, Milwaukee, Wis.; J. C. Hutchins, Detroit, Mich.; H. M. Thygeson, Minneapolis, Minn.; J. A. Beeler, Denver, Colo.; H. M. Sloan, Chicago, Ill.; J. J. Stanley, Cleveland, O.; Russell Rohh, Boston, Mass.; Bernard Corrigan, Kansas City, Mo.

**Welfare of Employees.**—E. G. Connette, chairman, Worcester, Mass.; W. A. House, Baltimore, Md.; J. M. Roach, Chicago, Ill.; J. B. Crawford, Ft. Wayne, Ind.; R. R. Smith, Louisville, Ky.

**Federal and State Regulation.**—G. H. Harries, chairman, Washington, D. C.; J. I. Beggs, Milwaukee, Wis.; H. J. McGowan, Indianapolis, Ind.; C. L. Allen, Utica, N. Y.; T. E. Byrnes, New Haven, Conn.

**To Confer with Interstate Commerce Commission on Depreciation.**—G. H. Harries, chairman, Washington, D. C.; J. I. Beggs, Milwaukee, Wis.; F. R. Ford, New York, N. Y.; A. W. Brady, Anderson, Ind.; C. S. Sergeant, Boston, Mass.

**To Confer with Interstate Commerce Commission on Classification.**—G. H. Harries, chairman, Washington, D. C.; C. L. Allen, Utica, N. Y.; F. R. Ford, New York, N. Y.; A. W. Brady, Anderson, Ind.; W. B. McKinley, Champaign, Ill.

## Accountants' Association.

**Standard Classification of Construction and Equipment Accounts and Form of Report.**—W. F. Ham, chairman, Washington, D. C.; H. L. Wilson, Boston, Mass.; F. R. Henry, St. Louis, Mo.; W. G. McDole, Cleveland, O.; C. N. Duffy, Milwaukee, Wis.

**International Standard Form of Report.**—H. J. Davies, chairman, Cleveland, O.; W. G. Ross, Montreal, Que.; F. E. Smith, Chicago, Ill.

**Collection of Blanks and Forms.**—E. M. White, New York, N. Y.

## Claim Agents' Association.

**Employment.**—B. B. Davis, chairman, Columbus, O.; H. V. Drown, Newark, N. J.; T. B. Donnelly, Connellsville, Pa.

**Ways and Means.**—William Tichenor, chairman, Indianapolis, Ind.; M. S. Rausch, Milwaukee, Wis.; Louis Lipphardt, Wheeling, W. Va.; H. K. Bennett, Fitchburg, Mass.

## Transportation and Traffic Association.

**Express and Freight Traffic.**—H. H. Polk, chairman, Des Moines, Ia.; W. S. Dimmock, Tacoma, Wash.; A. L. Eastman, Utica, N. Y.; Charles Paxton, Dayton, O.; J. L. Lathrop, Spokane, Wash.

**Passenger Traffic.**—M. C. Brush, chairman, Boston, Mass.; F. W. Coen, Cleveland, O.; E. F. Peck, Schenectady, N. Y.; Franklin Woodman, Haverhill, Mass.

**Rules, City Operation.**—D. McDonald, chairman, Montreal, Que.; E. J. Ryon, Schenectady, N. Y.; G. O. Nagle, Wheeling, W. Va.; R. S. Goff, Boston, Mass.

**Interurban Rules.**—J. N. Shannahan, chairman, Baltimore, Md.; L. E. Fischer, Danville, Ill.; J. E. Duffy, New York Association; F. D. Carpenter, Central Electric Association; Charles Currie, Akron, O.

**Training of Employees.**—J. W. Brown, chairman, Connellsville, Pa.; E. P. Shaw, Jr., South Framingham, Mass.; W. C. Ludwig, Baltimore, Md.; W. R. W. Griffin, Rochester, N. Y.; C. D. Emmens, Ft. Wayne, Ind.; H. W. Fuller, Washington, D. C.

The membership of the standing committees of the Engineering association was announced in last week's issue of the Electric Railway Review.

## HEAVY ELECTRIC TRACTION.

Albert H. Armstrong, railway engineering department General Electric Company, addressed the Minnesota section of the American Institute of Electrical Engineers in St. Paul, March 16, on "Heavy Electric Traction." The meeting was very well attended and the presence of a number of steam railway men testified to their interest in the progress of electrification work.

Mr. Armstrong opened his paper by reviewing briefly, with the aid of lantern slides, the modern development of electric haulage, using as illustrations the West Jersey & Seashore, New York Central and New York New Haven & Hartford installations. He also showed the gasoline-electric car as an example of what could be done on branch lines where infrequent service—say at two or three hour intervals—was all that was required. The car shown, with a capacity of 40 passengers, will make a schedule speed of 25 to 30 miles per hour, with stops 5 or 10 miles apart on a consumption of about 0.4 gallon of gasoline per car-mile. This car is not recommended as a competitor of the electric railway but rather to take the place of the light locomotive-hauled train in sparsely settled districts, where the first cost of a trolley line is not justified. [The General Electric gas-electric car was described and illustrated in the Electric Railway Review, January 25, 1908, page 110.]

The speaker dwelt particularly on the application of electricity to tunnel operation at the present time. In this connection he referred to the Cascade tunnel of the Great Northern Railway, where 200-ton three-phase locomotives will haul all traffic through the 2½-mile tunnel. Three-phase locomotives were chosen because of their adaptability to operation on continuous grades and on account of the probability that electricity will supersede steam over the entire Cascade division some time in the future. Another count in favor of the three-phase locomotives is the simplicity of braking by means of regeneration with this type of apparatus.

One thousand tons is the maximum train it is now feasible to handle over a 2.2 per cent grade, on account of the draft and brake rigging. Up this grade the present locomotives haul freight trains at a maximum speed of 10 miles per hour and passenger trains 16 or 17 miles per hour, while descending the speed is perhaps twice as great. It is safe to operate at high speeds going up than it is going down grade, and here it is that a strong feature of the electric locomotive is apparent, for with it there is no difficulty in making power enough available to handle trains up grade at the highest speeds allowable with the given curvature and track condition. In other words, the electric locomotive eliminates the ruling grade. With braking accomplished by regeneration there is a great added safeguard available in electric operation, which on a large division furnishes at the same time a material saving in the power station generating equipment required.

In answering a question as to the equipment he would recommend for a long overland route, Mr. Armstrong did not regard it as necessary or desirable to confine himself to any one type. He would possibly use direct current for terminals, single-phase alternating current for long prairie divisions and three-phase current on mountain divisions, taking advantage of the desirable features of each class of equipment.

The operating officials of the Marion Bluffton & Eastern Traction Company, Bluffton, Ind., have formed an officers' club and will hold frequent meetings to discuss matters pertaining to the operation of the road.

SIGN POST FOR HIGHWAY CROSSING TWO RAILWAYS.

The Indiana Union Traction Company will install at all highway crossings where its lines immediately parallel steam railroads a crossing sign of the type herewith illustrated. It will be noted that this sign comprises a main post 6 by 6 inches in section and 14 feet high, set 4 feet in the ground. At the top of the post are the two usual 5-foot signboards and underneath these, placed horizontally, is a board 5 feet long by 8 inches high, lettered, "Two Crossings." These three

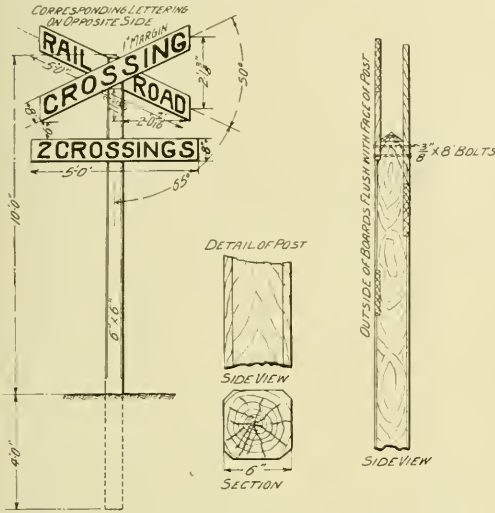

Indiana Union Traction Company—Sign Post for Highway Crossing Two Railways.

signboards are mortised flush with the surface of the upright post and securely fastened with bolts 8 by 3 inches.

POWER STATION IMPROVEMENTS AT SPRINGFIELD.

The Springfield Street Railway Company, Springfield, Mass., has recently increased the capacity of its power plant

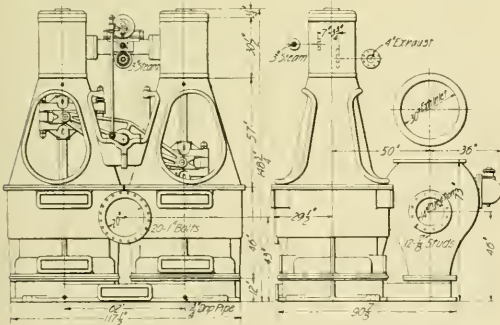

Springfield Street Railway—Air Pumps and 48-Inch Jet Condenser.

by the addition of a 3,000-horsepower engine and a large jet condenser.

The new engine, built by McIntosh, Seymour & Co., Auburn, N. Y., drives a 2,000-kilowatt generator. The engine has a high-pressure cylinder 38 inches in diameter and a low-

pressure cylinder 78 inches in diameter. The stroke is 60 inches and the unit runs at 75 revolutions per minute. The engine weighs 723,000 pounds and the flywheel 130,000 pounds. The bearings of the main shaft are 25 inches in diameter.

The condensing equipment which has been installed in connection with the new engine was built by the Blake Pump & Condenser Company, Fitchburg, Mass. This unit comprises twin vertical air pumps with steam cylinders 18 inches in diameter designed for 200 pounds pressure. The buckets are 44 inches in diameter and have a 24-inch stroke. An accompanying illustration exhibits the general dimensions of the air pump and the 48-inch jet condenser. We are indebted to R. G. Tyler, superintendent of motive power Springfield Street Railway, for the data and illustration presented herewith.

PAY-AS-YOU-ENTER CARS TO BE OPERATED IN NEW YORK.

The receivers of the New York City Railway have announced that 155 pay-as-you-enter cars will be placed in operation on the Fourth and Madison avenue line on March 22. These cars were built by The J. G. Brill Company and were described and illustrated in the Electric Railway Review of October 26, 1907, page 709. They are 48 feet long over all, or 11 feet longer than the present standard car of the New York City Railway, the car body being 32 feet long, 4 feet longer than the present car and slightly wider. The platforms are 7 feet 6 inches long by approximately 6 feet wide, and will accommodate more than 20 persons. The cars are built for double-end operation and as far as the operation of the pay-as-you-enter system is concerned are like those used by the Chicago City Railway and the International Railway of Buffalo. The interior is handsomely finished in maple.

Passengers will be allowed to stand on the front platform but smoking will not be permitted. The conductors will be instructed not to admit more than 75 passengers and after a car is full no more stops will be made except to let off passengers.

The fares will be collected and registered by the conductor. Later, if the public receives the new cars favorably, the Tec automatic register, as described in the Electric Railway Review of January 4, page 32, will be adopted.

An experiment will be made with a colored light signal displayed at night upon the front of the car and indicating by the colors blue, green, yellow or red the destination for which the car is bound.

The company has conducted a campaign of advertising to prepare the public for a favorable reception of the cars. Folders and booklets describing the pay-as-you-enter system have been distributed through the territory served by the Fourth and Madison avenue cars, and statements have been given to the newspapers setting forth the advantages of the pay-as-you-enter plan in the way of reduction of accidents and increased comfort to passengers, with directions as to how the public may co-operate with the company to secure the best results. On Thursday of this week Oren Root, general manager, took a party of press representatives on a trial trip in one of the cars and on Friday morning all of the leading papers published prominent articles, with photographs, describing the cars.

The company states that many persons whose testimony should be regarded as expert have maintained that it is impracticable to operate a car of this character under the conditions prevailing in New York City, but it is the belief of the company that the use of the pay-as-you-enter car should prove a step in advance toward bettering transportation systems.

The Kanauga Traction Company, Kanauga, O., has begun operating gasoline cars on its lines between Gallipolis and Kanauga, O. Two 35-foot cars are now in operation and others will be purchased.

## A WELL-DESIGNED ARMATURE CARRIAGE.

There are but few street railway shops that are built so that overhead travelers can carry the armatures from the cars to the winding room and back again. In fact, many shops which have been in use for several years are so designed that the armature is removed from a car in one portion of the building anywhere from 100 to 300 feet—and in some cases yards—from the winding room, thus making it necessary to retrace this distance after the armature has been wound and ready to replace on the car. Again, there are instances when, after the armature is wound or the repairs are made, it is necessary to move the armature to the machine shop, as not all shops are fitted with lathes for turning the armatures in the winding room. The armature must then be transported back to the winding room until such time as it is needed for a car, when it must be moved again. This condition, it will be seen, calls for transporting the armature four times, from the time it is taken from the car until it is returned.

The sketch shown herewith illustrates an interesting method used on a western road for the handling of armatures without the use of an overhead traveler. There is no tugging or lifting; the armature is simply straddled with the truck and the lever raised so that the collars will come under the arma-

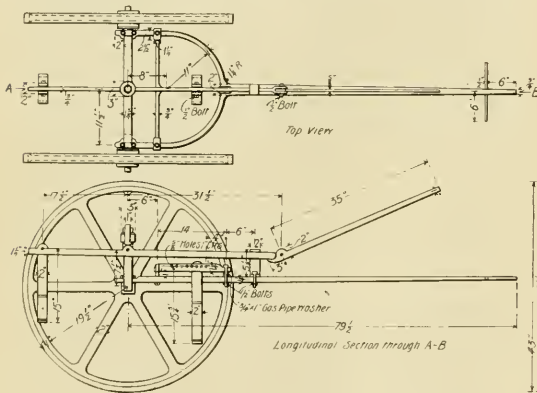

Armature Truck for General Use.

ture shaft ends. It then becomes an easy matter for one man with the assistance of the leverage to lift from the floor and lock into place an 800-pound armature and walk off with it. This probably is as simple and convenient a method for handling armatures as could be found without the use of an overhead traveler.

## Depreciation of Steam Plant.

It is impossible to establish a hard and fast basis for depreciation of a power plant. But Mr. Charles T. Main, mill engineer, Boston, very concisely presents the average condition as follows: "With water and good care, running about 12 hours a day, the life of a boiler should be about 20 years, or the depreciation 5 per cent a year. Slow-speed engines, running 10 hours a day, can be estimated as having a life of about 25 years, or a depreciation of 4 per cent a year. High-speed engines are much shorter lived, and will not average over fifteen years, or a depreciation of about 7 per cent a year; and oftentimes it is greater when run 10 hours a day. The depreciation when run 20 to 24 hours a day is correspondingly greater. Boiler settings and piping should be included with the boilers, and engine foundations and piping with the engines. The life of economizers varies with the initial temperature of the entering water from about ten years up to forty."

## BOOK TABLE.

**Negligence in Law (Third Edition).** By Thomas Beven. 1908. Published by Stevens & Haynes, London; Canada Law Book Company, Toronto; Cromarty Law Book Company, Philadelphia. Cloth, two volumes, 1505 pages, 6½ by 10 inches.

The author states that the preparation of this edition has taken up a very large portion of his time during the last three or four years, and the result is not the mere bringing up to date which at regular intervals is necessary in order to keep a law book in life, but the presentation of a considerable body of new problems and conclusions. He says, too, that he has used considerable freedom in inquiring into the validity of the decisions arrived at. Nor does he recognize the validity of the representation made to him more than once that he should omit everything not fitted for the purposes of practitioners in a hurry.

It is also important to note that the author says that he has made some alteration in his point of view. In the first instance he made an attempt to present the law of the United States side by side with the English. But he is now convinced that such an attempt is impossible of success and also inexpedient. To illustrate this he says that he has in his possession a vast American treatise on negligence. It is in six volumes, has 7,741 pages, and deals with 36,000 cases or thereabouts. Yet even in these generous limits very many American decisions on negligence of the greatest weight are not included. What hope then of dealing with a body of law so enormous in addition to his prolific own? Moreover, the study of this Encyclopedia of Negligence has made plain to him what he before suspected—that, though of the same parentage as the English,

American law has in late years been developing along divergent lines, and accepts principles as widely applicable that are to the English people not only novel, but fundamentally unsound.

It was the author's conviction of the utter uselessness, for his purposes at any rate, of drawing out this opposition in detail, necessarily at considerable length, that induced him to abandon any attempts systematically to range and compare the two systems. Some three or four

hundred, but not all, American cases have in consequence been dropped out of this edition. The American decisions left out have been replaced by colonial. This will show, perhaps better than anything else, the character of work done on this edition, the more important changes made in it, and for whom it will be useful. The subject is a vitally important one, and for those who wish for any reason to get at the English and colonial law on it this work ought to be very valuable.

The word "electric," it may be added, has but three references under it, in the index, "motor car" and "motor car act" together, 3; "tramcar," 9; and "tramway," 11.

The Visalia Electric Railroad on March 10 began regular operation over its new line from Visalia to Lemon Cove, Cal., a distance of 24 miles. The tracks of the Southern Pacific Railroad are used from Visalia to Exeter, 13 miles. Power is purchased from the Mt. Whitney Power Company and transmitted at 17,500 volts pressure to the main substation at Exeter, where it is changed to 11,000-volt 15-cycle single-phase current for transmission to three transformer substations. In these substations the current is stepped down to 3,300 volts for operation. The rolling stock equipment comprises four passenger motor cars, two trailers and a 50-ton electric locomotive, besides several freight cars. The overhead construction is of the single-pole bracket type.

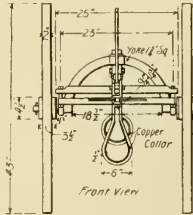

## RECENT ELECTRIC RAILWAY LEGAL DECISIONS.

BY J. L. ROSENBERGER, LL. B., OF THE CHICAGO BAR.

### Not Every Increase of Speed or Sudden Jerk Amounts to Negligence.

Mobile Light & Railroad Company v. Bell, 45 Southern Reporter, 56.—The supreme court of Alabama says that the mere charge that the motorman increased the speed of a car with a sudden jerk does not impute negligence to him. The jerk may not have been due to the negligence of the motorman. It is not every increase of speed or sudden jerk of a car that amounts to negligence.

### Moving of House Along Track Not Consistent with Company's Rights.

Ft. Madison Street Railway Company v. Hughes and others, 114 Northwestern Reporter, 10.—The supreme court of Iowa says that the defendants proposed to move a house along the plaintiff's track for a distance of a mile and a quarter, thereby not only stopping the running of its cars for many hours and probably for several days, but requiring the removal of its trolley and other wires as well. This would be inconsistent with the company's right to occupy the street.

Again, the court says that where the use of the street has been lawfully appropriated in so far as essential for the operation thereon of an electric street railway, one of the modern conveniences of travel and transportation, there is no tenable ground for demanding that its operation shall cease or be unduly interfered with, or that the value of its franchise shall be impaired or its property destroyed to enable another to make an unusual and extraordinary use of the street in the moving of houses or other structures over it. This would be inconsistent with the franchise granted to which the street has become subject.

The rights of the defendants to the use of the street were limited by those of the company to operate its cars thereon, and they could not insist upon the elimination of its franchise rights in order to give way to them over the road in moving the house. In other words, the defendants had the right to the use of the street as it was, with the trolley line in operation, and not as it would have been had no franchise been granted by the city, and, as they could not move the house lengthwise on the street as they intended without occupying the company's track, destroying the trolley line, and interrupting for a considerable time the operation of its cars, the jury was rightly instructed that they were not entitled to take the house into that street.

### Things Company Must Know and Acts of Conductor for Which It Must Provide with Reference to Objects Along the Line.

Indianapolis Traction & Terminal Company v. Holtzclaw, 82 Northeastern Reporter, 986.—The appellate court of Indiana, division No. 2, says that in this case the company constructed the road, and it knew exactly the distance from a certain telephone pole to its track. It knew what kind of cars would be run over the track. It knew what kind of service its employe operating the car would have to perform. It knew that in operating the summer cars the conductor would be required to pass along the running board to take up the fares, and that while passing along the running board his attention would necessarily be drawn to the passengers on the inside of the car; it knew, and was bound to know, that the conductor would be required to move his body in various positions, that he would be required to reach into the car to get fares and to withdraw his body to an upright position, that he would be required to lean back to reach up over his head to take hold of the appliance by which the fares were registered; it was bound to know, too, that at times, when the cars would be crowded and passengers would be standing upon the running board, that the conductor, in pass-

ing back and forth along the running board, would be compelled to go around the body of each passenger; and it was its duty to construct its road with reference to objects along the line, where it was reasonably practical to be done, to leave ample room for the movement of its employes and of the passengers who might be expected to ride upon the running board. If the circumstances were different, if the object with which the conductor had collided was some character of structure that could not have been avoided, and to which it was necessary the road should run in close proximity, it would be different; but here the object was a telephone pole which, from its nature, could easily have been moved a distance of one or two feet. The court holds that the question as to whether or not the danger of collision with this telephone pole was a danger that was so open and apparent that the conductor was bound to know of it and therefore to assume the risk, was properly submitted to the jury. For the same reason that the danger was not an assumed risk, the question of whether or not the conductor was guilty of contributory negligence in failing to observe the pole, and the danger that was to be apprehended from it, was a question for the jury.

### Rights of Pedestrian Crossing in Front of Standing Car at Curve.

Mittleman v. New York City Railway Company, 107 New York Supplement, 108.—The supreme court of New York, appellate term, says that at the time of the accident in this case the defendant was running cars through Delancey street from west to east and across the Williamsburg bridge. The car tracks, before reaching the bridge, curved sharply toward the south, and then easterly, so that a car running along Delancey street turned and proceeded southerly for a space, turning easterly again before crossing the bridge. On the westerly side of this curve, about two or three feet from the car tracks, was an unguarded excavation about three feet deep. The plaintiff was crossing from Delancey street, going in a southerly direction to Broome street. In so doing she was compelled to pass along a path between the excavation and the car tracks as they curved toward the south. As she, with several others, was about to cross the tracks, a car approaching the curve was stopped by a policeman to enable them to pass. The plaintiff was the last to cross, and she had passed the front end of the car, when it started and she was struck by the rear fender. At that time she was about two feet from the track. The side of the car passed her safely, but the fender, which was fastened to the car by a strap, and one corner of which projected beyond the car about a foot, struck her and threw her into the excavation.

Under these circumstances it could not be said either that the plaintiff was negligent or that she failed to show negligence on the part of the defendant. The motorman knew that the plaintiff and those who had crossed ahead of his car were proceeding near to the track and between the track and the excavation, and it was his duty to wait before starting his car until they had had an opportunity of reaching a place of safety, especially when, as it appeared, even the overhang of the car, as well as the projecting fender, was liable to strike a pedestrian as the car rounded the curve. This duty he evidently failed to recognize.

Although it has been held that a person at or near a curve in a railroad track may be charged with knowledge that the rear end of a car will project a certain distance beyond the track, the decisions declaring this principle had no application to the facts disclosed in the case at bar. The plaintiff crossed in front of a car while it was at a standstill, and she had a right to assume that the car would not be started or so operated as to strike her until she had enjoyed a reasonable opportunity to pass the point of danger.

The court is of the opinion that the plaintiff proved a cause of action, reverses a judgment rendered for the defendant and orders a new trial.

# News of the Week

## Central Electric Traffic and Railway Associations.

The committee of the Central Electric Traffic Association, appointed at the meeting at Dayton, O., on January 23 to aid in the selection of a chairman for that association and a secretary and treasurer for the Central Electric Railway Association, will meet at the Claypool hotel, Indianapolis, on March 25. The committee will prepare a report to be submitted at the meeting of the Central Electric Railway Association at the same hotel on March 26. The programme for this meeting was announced in last week's issue of the Electric Railway Review.

## Progress of the Cleveland Negotiations.

At a meeting of representatives of the Cleveland Electric Railway and of the city of Cleveland on March 11, a tentative plan for a reorganization of the street railway companies was agreed upon. According to this plan, the name of the Cleveland Electric Railway is to be retained. The stock of the Cleveland Electric Railway is to be decreased to an amount equal to the agreed value of the property, and will then be increased by an amount sufficient to acquire the Forest City Railway. Treasury stock will be issued to provide for immediate development of the properties and a lease to the Municipal Traction Company will be executed and given to a trust company to be held in escrow. Further details have been considered in secret meetings. It is stated that the directors of the Forest City Railway object to a consolidation with the Cleveland Electric Railway, and a consequent elimination of the company as an independent concern. Plans have been discussed for holding a special meeting on March 21 to consider the matter before the stockholders meeting on March 28.

## Annual Meeting Maintenance of Way Association.

The ninth annual convention of the American Railway Engineering and Maintenance of Way Association was held at the Auditorium hotel, Chicago, on March 17, 18 and 19. Some of the subjects considered were: Uniform rules; signaling and interlocking; water service; strength and endurance of steel rails; iron and steel structures; buildings; ballasting; open versus ballast deck structures; wooden bridges and trestles; rails; track; yards and terminals; roadway; masonry; records, reports and accounts. The results of the election of officers for the ensuing year were announced as follows:

President—Walter C. Berg, chief engineer Lehigh Valley, New York, N. Y.

First Vice-President—W. McNab, principal assistant engineer Grand Trunk, Montreal, Can.

Second Vice-President—L. C. Fritch, assistant to president Illinois Central, Chicago, Ill.

Treasurer—W. S. Dawley, chief engineer Missouri & North Arkansas, St. Louis, Mo.

Secretary—E. H. Fritch, 762 Monadnock, Chicago, Ill.

Directors—Charles S. Churchill, chief engineer Norfolk & Western Railway, Roanoke, Va.; E. W. Wendt, assistant engineer Pittsburg & Lake Erie, Pittsburg, Pa.; D. D. Carothers, chief engineer Baltimore & Ohio, Baltimore, Md. (to fill vacancy).

## New Wage Scale on the Inter-Urban Railway.

H. H. Polk, president and general manager of the Inter-Urban Railway, Des Moines, Ia., advises us that the new wage scale recently put in effect is as follows: For conductors and motormen, 19 cents per hour for the first year's service with an increase of 1 cent per hour for each succeeding year including the sixth; for passenger brakemen, 15 cents per hour for the first year, 16 for the second and 17 for the third year and thereafter; for freight brakemen, 17 cents per hour for the first year, 18 for the second and 19 for the third and thereafter. Other provisions are as follows: "All regular run men shall be paid full time for all necessary deadheading. All regular run men called to take out special cars or special trains shall be paid for the number of hours actually in their regular runs, with overtime allowed for all time in excess of such regular run. When the company finds it necessary to issue a special timecard governing the movements of trains on holidays and special occasions, all regular run men operating under such special timecard shall be paid overtime for all hours in excess of their regular runs. Men in the train service may, with the consent of the company, change from one branch of the train service to another, each man changing to a different branch of the service to comply with all rules prescribed for applicants for work in such

branch. In determining the rate of pay of men changing from one branch of the service to another, they shall be allowed full credit for their entire time in the train service of the company. Their seniority standing shall be fixed by the actual duration of their continuous employment in the particular branch of the train service in which they are engaged when the question of seniority arises."

The men asked for an increase of from 44 per cent upward but on March 7 entered into a contract on the basis of this scale dating from February 12, 1908, to March 4, 1910.

## Order Preventing Sale of Newspapers on Cars Causes Conflict.

The attempt of certain Chicago newspapers to prevent the Chicago City Railway from enforcing an order prohibiting the selling of newspapers on its new pay-as-you-enter cars reached the proportions of a riot on Tuesday and Wednesday of this week, during the evening rush hour.

Led by the circulation managers of the evening papers and assisted by a large number of adult rowdies, the newsboys made an organized assault on the company's cars on Wabash avenue in the business district and attempted to board the cars to sell their papers in spite of the conductors. Previous attempts of a similar character had been made and the company had made preparations by stationing a guard on each car. The result was a series of conflicts between the boys and their assistants, the company's employes and the police, in which many were injured. The boys and their backers threw stones and other missiles, pulled the trolleys from the wires and before the rioting was stopped by the police, had succeeded in blockading the cars in the loop district for several blocks. Many of them resorted to the plan of offering to pay fare, although the company's position is that they shall not be allowed to sell papers on the cars in any case. Five of the boys were arrested and were arraigned in the municipal court on Thursday, but the cases were continued.

A statement has been issued from President Mitten's office explaining that the order to keep the boys off the pay-as-you-enter cars was made partly for the purpose of preventing accidents and partly because to permit newsboys to rush through the cars would defeat one of the main purposes of the pay-as-you-enter system by interfering with the comfort of the passengers. It is also stated that "although this fight was being advertised as a newsboys' war, it is in fact a war of certain newspapers to compel the company to rescind its rule excluding newsboys. Threats were openly made by adults claiming to represent certain newspapers that if the order were not revoked the company would be compelled to back down. The newsboys did not come into the situation until threats were made by apparently responsible agents of these newspapers."

## Educating the Public by Bulletins.

Taxation is discussed in Bulletin No. 5 in the series which President William A. House of the United Railways & Electric Company of Baltimore is publishing in the daily newspapers of that city. This bulletin states that the company pays an average of about 10 per cent of its gross and 20 per cent of its net earnings for taxes, as compared with 6.3 gross and 13.9 per cent net average for cities of 500,000 population or over in the country. The taxes borne by the company are stated as follows:

"(1) It pays a park tax on 9 per cent of all of its receipts in the city before anything is paid toward operating expenses or to creditors; (2) it also pays at the same rate as the citizen, taxes upon its power houses, car houses and other valuable real estate; (3) it also pays taxes on its tracks, which are assessed as real estate; (4) it also pays a tax upon its outstanding shares; (5) it pays heavily for the repair of streets between and beside its tracks, notwithstanding the fact that this requirement is simply a survivor of horsecar days, when the company's horses hammered the streets. Today, with electricity, no injury is done to the streets by the cars, and yet the company continues to pay for the repairs made necessary by carts and wagons, which wear out its tracks and the adjacent street surface; (6) the company pays a license tax for every car put in service; (7) it pays for clearing the ice and snow from its tracks, a larger burden than many people imagine, and not imposed by the city upon any other corporation. In addition to this, the company is heavily burdened by city ordinance requiring it to keep in repair the city bridges to the extent of the space between its tracks and for two feet on either side."

The bulletin then argues that the street car is the poor man's carriage, and if it is taxed too heavily, its efficiency is impaired.

Bulletin No. 4, published in two parts, discussed the "Street Railway as a Developing Agent." After showing how

the healthy growth of a city is influenced by the character of the transportation facilities the bulletin states:

"Prior to 1888 the city area (including the harbor) was 13.2 square miles. In 1888 the city annexed 16.9 square miles, mainly farming lands. Due to the rapid extension of the street railway lines, much of this has since become improved city property, making a tremendous increase in the taxable basis of the city.

"The suburban and country lines accomplish two things. First, a great number of people who have their offices in the city are enabled to live in the country. Second, the sections of the country traversed by the electric lines are brought into much closer relationship to each other, thus greatly enlarging and developing the field of business activity in these sections. The most forcible argument in favor of the value of rapid transit as a developing agent in the country districts is the increase in population and prosperity in these districts which has taken place since the electric lines were built."

**Transit Affairs in New York.**

Since the city's financial authorities have stated that the city is already indebted to such an extent that it will be impossible to issue additional bonds for subway construction for the next two years, those most interested in the plans for new subways have been studying to find a method by which they may be financed. On March 13, the board of estimate received from Corporation Counsel Pendleton and Ex-Judge John F. Dillon an opinion that the city may let contracts for subway construction in sections so that the entire cost of a subway need not be charged against the constitutional debt limit. The opinion states that providing the rapid transit laws authorize, or may be amended so as to authorize the making of contracts for sections of the work, only the amount of the contracts let need be charged against the debt limit if they are so drawn that the city may terminate the work at the expiration of a contract without further liability.

Mayor McClellan and Comptroller Metz are said to be considering the advisability of recommending that the form of contract for the Fourth Avenue, Brooklyn, subway shall be amended so as to provide for bids for both construction and operation. The contract as it stands calls for bids for building only. It is the opinion of the mayor and comptroller that by advertising bids it might be possible to attract private capital for the building of the new subway.

On March 15 the board of estimate approved the plans for the Broadway-Lexington subway route as laid out by the public service commission. It will now be necessary to apply to the appellate division of the supreme court for the appointment of a commission to decide whether or not the proposed route is a public necessity, so as to avoid the necessity of securing consents of abutting property owners, many of whom are opposed to the plans. Chairman Willcox of the commission says that the commission is ready to let contracts for subways in sections or for the entire work, provided the city authorities will provide for the money. The Fourth avenue subway is divided into six sections, and the form of contract for each section is now ready to be let and awaits only the approval of the board of estimate and apportionment.

Corporation Counsel Pendleton has rendered an opinion that neither the board of estimate nor the public service commission has the power under existing laws to purchase railroads or tunnels already constructed or in process of construction, which, of course, includes the Belmont or Steinway tunnel, which the Interborough Rapid Transit Company has proposed to sell to the city. Mr. Pendleton states, however, that bills have been prepared to be submitted to the legislature which if adopted will authorize the public service commission and the board of estimate, acting together, to purchase existing railroads, including tunnel roads, constructed or in process of construction, suitable for rapid transit purposes.

The commission continued on March 12 the public inquiry into the methods of operation on the Brooklyn bridge. W. S. Menden, chief engineer of the Brooklyn Rapid Transit Company, stated that the new plan of running through elevated trains across the bridge, instead of shuttle cars, made a great improvement in the service, making it possible to run more cars. On the morning of March 10, between 8 and 9 o'clock, he said, 67 cars were operated across the bridge, whereas the greatest number of shuttle cars ever secured in an hour was 62. Mr. Menden added that the service on the bridge will be improved when several changes now contemplated have been put into effect. These include the installation of block signals on the bridge, the widening of the platforms of the Park Row terminal, the enlarging of the track capacity of the Brooklyn yard, the equipment of the platforms at the Manhattan terminal with railings so as to provide for better and speedier means of loading trains and the completion of the elevated structure for trolley cars over Sands street.

On the following day E. E. Winter, president of the Brook-

lyn Rapid Transit Company, testified in regard to the tolls paid to the city for running cars across the bridge. He said that in 1907 the company paid the city \$57,083.90 for surface cars, \$91,250 for through elevated cars and \$20,306.28 for bridge car rentals and that although the amount of the tolls were deducted from the franchise tax paid to the city there had been a deficit of \$2,500,000 from the bridge service since 1900. He said that the company had paid \$63,000 toward the cost of reconstructing the Brooklyn terminal and \$15,000 for the reconstruction of the tracks at the Manhattan terminal.

On March 14, the public service commission adopted an order directing the Union Railroad, of the Bronx, to thoroughly overhaul its cars and to place them in a condition "substantially as good as new."

**Calumet & South Chicago Franchise Ordinance Completed.**

The ordinance providing for the consolidation of the Calumet Electric Street Railway and the South Chicago City Railway under the name of the Calumet & South Chicago Railway, and an extension of the present franchises from 1912 and 1915 to 1928, was reported to the Chicago City Council in complete form on March 16 by the local transportation committee. The ordinance was ordered published and is expected to come up for consideration at the next council meeting on March 23. The ordinance requires the construction of seven important extensions before January 1, 1910, a complete rehabilitation of the properties within 3½ years, 40 miles of track to be rebuilt at once, and the company is to purchase 15 new cars within a year.

The city is to receive 55 per cent of the net receipts after operating expenses, taxes and depreciation have been deducted and may purchase the property at the end of the grant for the present value of the property plus the amount expended for rehabilitation and a 12 per cent bonus. The Chicago City Railway may also purchase the property on the same terms but any other company must pay 20 per cent bonus. The valuation of the property is fixed at \$5,000,000. Bion J. Arnold and George Weston, the engineers appointed to make a valuation of the property, reported a total of \$6,174,545, as follows:

**Calumet Electric Street Railway Company.**

Physical property .....	\$2,486,868.86
Intangible property .....	546,095.43
Total .....	\$3,032,964.29
Paving, filling and subways .....	1,015,642.47
Grand total .....	\$4,048,606.76

**South Chicago City Railway Company.**

Physical property .....	\$1,503,588.94
Intangible property .....	183,872.58
Total .....	\$1,687,461.52
Paving, filling .....	438,476.74
Grand total .....	\$2,125,938.26

The ordinance provides for universal transfers in the territory south of Sixty-third street, in which the companies operate. This territory is also divided into four transfer zones. In the first zone transfers must be exchanged with the Chicago City Railway at once and the privilege shall be extended to other zones as the earnings increase, to the second zone when the earnings amount to 6¼ per cent on the investment.

**Legislation Affecting Electric Railways.**

**District of Columbia.**—A draft of a proposed bill providing for a public utilities commission for the District of Columbia has been distributed to members of the house district committee by Representative Smith. The bill provides for the appointment of a commission of three members, appointed by the president at a salary of \$7,500 a year, one of whom shall have been a resident of the district for five years, another must have had experience as a public service accountant and the third must be qualified to value the properties of public service corporations. The commission is to have power to investigate and regulate public service corporations, with jurisdiction over rates, service and intercorporate relations, and may prescribe maximum rates and limit capital issues. Other provisions of the bill are generally similar to those of the New York public service law.

**New York.**—Senator Travis and Assemblyman Robinson have introduced in the legislature a bill amending the laws with regard to contracts for rapid transit railways. The public service commission is empowered to let contracts for construction and operation as at present, for a term not exceeding

35 years, but with a provision that the city may, at the end of a specified period not to exceed 25 years, terminate the contract for operation and purchase the property at a valuation not to exceed the original cost. It is also provided that the commission may grant indeterminate franchises for construction and operation by private corporations, with a provision that the city may purchase the property at any time after the expiration of a specified period, not to exceed 25 years. The same provision is to apply to extensions of existing lines.—Senator Hartje has introduced a bill authorizing the city of New York to acquire the Steinway tunnel at cost. It is provided that in determining the cost, no consideration shall be taken of the franchises or real estate, and that the cost of labor shall be estimated on the basis of the prevailing rate of wages and the cost of materials at the open market value. All real estate needed is to be acquired separately by condemnation proceedings and the amount realized from the sale of rock and dirt excavated is to be deducted from the cost of the tunnel.

**Ohio.**—Senator Patterson has introduced a bill giving interurban roads the right of eminent domain in crossing streets, alleys and highways, except where this right would conflict with present franchise laws.

**Tests on Plain and Reinforced Concrete.**—Bulletin No. 197 of the University of Wisconsin comprises 68 pages reporting a series of tests on plain and reinforced concrete, by Morton O. Withey, instructor in mechanics. The report is illustrated by 30 figures and eight plates, and there are also included 14 tables of data and results. For engineers interested in the performance of reinforced concrete under various loadings this bulletin will be found of especial value.

**Western Society of Engineers.**—The extra meeting of the Western Society of Engineers announced for Wednesday evening, March 18, has been postponed to March 25, on account of the meeting of the American Railway Engineering and Maintenance of Way Association. J. N. Darling, principal assistant engineer of the South Side Elevated Railroad, will present a paper on "Some Features of Construction of the South Side Elevated Railroad," with lantern slide illustrations. The meeting will be held in the society rooms in the Monadnock block, Chicago.

**Accidents in New York.**—The New York public service commission of the first district has issued a statement of the accidents on railroad lines within its jurisdiction for the month of February. The total number of accidents for February was 3,951, as compared with 3,921 and 3,993 for January and December, respectively. The number of persons injured in February was 2,157, as compared with 2,500 and 1,937 in January and December, respectively. The serious injuries, however, were only 139, as compared with 188 in January and 200 in December. The number of deaths from such injuries were only 26 in February, whereas there were 44 deaths in January and 51 in December.

**Peoria Electrolysis Case.**—Some 10 years ago the Peoria Water Company brought action against the Central Railway Company of Peoria, Ill., claiming that the double trolley was the only method of preventing the destruction of the water company's pipes by stray currents from the railway. The water company prayed the court for an injunction restraining the railway company from the use of the single-trolley rail return. The case again came up for hearing at Chicago on Tuesday morning, March 10, before Special Master Frank L. Wean, appointed by Judge Sanburn of the United States circuit court. The original hearing of the case took place about 10 years ago before the same special master. At that time a large number of cities throughout the country were visited by those engaged in the case and testimony taken in such cities. After the hearing was closed, the special master made his report to the court in which he upheld the water company and recommended that an injunction against the operation of the single trolley be granted. The court took no action on the recommendation and in October, 1907, the case was reopened by the complainant's application to the court to hear arguments on the special master's recommendation. In answer the defendant prayed the court for a reopening of the case for the purpose of taking further testimony on account of the advance in the art since the close of the previous testimony. A special order of court was issued permitting that to be done. The railway company presented its testimony last week. The water company then requested an adjournment of the case until April 7 at which time it will present its testimony in rebuttal after which the case will be considered by the special master and his report and recommendations presented to the court and arguments heard thereon. Judge I. C. Pinkney of Peoria is counsel for the railway company and Edward E. Winters of New York is the technical expert.

## Traffic and Transportation

### Petition for Reduced Fares in Chicopee Denied by Massachusetts Railroad Commission.

The Massachusetts railroad commission has dismissed the petition of the mayor and aldermen of Chicopee for a reduction in the fares on the Holyoke Street Railway and the Springfield Street Railway during the rush hours. The decision of the board follows:

"The petitioners, to whom a hearing has been given, ask for a special rate of fare on these street railways for workmen and workingwomen on week days, between the hours of 5 and 7 in the morning and 5 and 7 in the evening. It appears that the fare from all points in Chicopee served by the Holyoke Street Railway to Holyoke is 5 cents, and from all points in Chicopee served by the Springfield Street Railway to Springfield is 5 cents.

"The request of the petitioners, if granted, would result in a service for less than 5 cents between Chicopee and Holyoke and Chicopee and Springfield during the so-called 'rush' hours of the day, when a very substantial amount of travel exists, thus materially reducing the revenues of the companies.

"The board is unable to recommend to either company any decrease in existing fares and, therefore, dismisses the petition."

### Answers Concerning Coney Island Fare Complaints.

Subsidiary roads of the Brooklyn Rapid Transit Company have filed with the New York public service commission, first district, an answer regarding the complaint that a 10-cent fare to Coney Island is excessive. The answer was signed by officers of the Brooklyn Union Elevated Railroad, the Brooklyn Heights Railroad, the Nassau Electric Railroad, the Brooklyn Queens County and Suburban Railroad and the Coney Island & Gravesend Railroad.

The answer denies that the companies are charging more than the legal fares on any of the lines and asserts that any reduction in fare would work a loss in operation. The answer states: "Any reduction of fares charged would effect such a reduction in the receipts as to render all the profits less than 10 per cent per annum upon the capital actually expended. The commission has no jurisdiction or authority to make any reduction in such rates of fare. Any order of the commission requiring a less fare to be charged by said companies, respectively, would impair the obligation of the contracts constituted by the charters and franchises, and of their predecessors in interest respectively and the contracts between them, by the provisions of which each company is legally authorized to charge the rate of fare charged by it. Any order of this commission requiring a less fare would be unconstitutional and void, and in violation of the provisions of the constitution of the United States prohibiting any state from impairing the obligations of contracts. A reduction in fare, if enforced by the commission, would work a confiscation of the property, without due process of law, and would be unconstitutional and void. In so far as the commission law purports to authorize said commission to make any such orders, the law is unconstitutional and void."

Attention is called to the temporary character of the heavy service to Coney Island, which exists principally in the summer season, and only for a few months of each year. It is declared that the average distance traveled by each passenger who pays a total fare of 10 cents exceeds 10 miles.

The Coney Island & Brooklyn Railroad has filed its answer to the complaint concerning a 10-cent fare to Coney Island. This company charges a 10-cent fare to Coney Island on Saturdays, Sundays and holidays only, the rate being 5 cents on other days. An abstract of the answer of this company follows: "While the average amount collected annually in second fares to Coney Island from 1903 to 1907, inclusive, was \$97,500, these collections amounted to only \$38,541 last year. If the receipts should be depleted by abolition of the second fare the net earnings would not equal the interest on the funded debt, irrespective of depreciation, reserve, contingencies or dividends. A lower fare than 10 cents would not be sufficient to cover the cost of transportation, reserve for depreciation, contingencies and an adequate return upon the capitalization or upon the value of the properties and franchises, which exceed \$9,000,000. The actual cost of carrying passengers to and from Coney Island, plus a reasonable return upon the capital, exceeds the revenue received for such transportation at the rate of fare now charged. The company does 75 per cent of its Coney Island business from June to September of each year, and the maximum equipment maintained for this service earns no income for the remainder of the



year. It is more expensive to operate cars in summer than in winter because of the cost of extra men. For that reason it is reasonable to charge a greater rate of fare than for ordinary travel. The lines barely earn their operating expenses from November to May.

"For the year 1907, the company operated 6,651,168 car-miles and its gross earnings were \$1,566,146.92, or 23.5 cents a car-mile. Operating expenses and taxes were \$1,298,495.86, or 19.5 cents a car-mile. Fixed charges were 6.1 cents a car-mile, making the expense of operating its service, including fixed charges, 25.6 cents a car-mile. The distance of the round trip from New York to Coney Island by way of the Smith street line, is 22,556 miles. To meet operating expenses, taxes, depreciation, reserve, and interest, without any return upon capital stock or reserve for contingencies, the company would have to earn \$5.87 a round trip to Coney Island. This would require at a 5-cent fare, 58 passengers each way on every car, day and night, for 365 days in the year. This condition has never existed, and it is manifestly impossible of existence. In the fiscal year ended June 30, 1907, the company carried 39,158,626 passengers, and collected \$1,612,924, some of the fares were half or 3-cent fares, the average revenue for each passenger was 4.118 cents above operating expenses and taxes, the net earnings per passenger were 0.831 cent and the net income after the payment of all charges was 0.184 cent."

The company asks that the complaint be dismissed, and that the public service commission adjudge a 10-cent fare as not excessive.

#### Evidence in Atlanta, Ga., Fare Case.

The Georgia railroad commission now has under consideration the evidence on the application for reduction in the fares charged by the Atlanta Northern Railway, which is controlled by the Georgia Railway & Electric Company of Atlanta.

At the hearing before the commission, P. S. Arkwright, president of the Atlanta Northern Railway, introduced evidence showing the cost of the road and its earnings and expenses; the charges of other interurban roads; and evidence distinguishing an interurban road from the ordinary street railroad, and the ordinary steam railroad. In addition to this, the company had a petition signed by a large number of representative people on the line of the road. This petition was drawn up voluntarily by them and was an expression on their part to the commission that they considered the service excellent and the fares reasonable and did not think the fares should be reduced.

In its answer the Atlanta Northern Railway said that "it has complete and accurate accounts of the actual expenditures made in the construction of its railroad; the total cost, to December 31, 1907, of constructing and equipping the railroad was \$598,087.62; the cost of supplies on hand was \$3,408.65; cash on hand amounted to \$2,596.72; accounts receivable, \$346.30; prepaid accounts, \$591.96, making the total assets \$605,031.25.

"The item of 'Organization' consists only of expenses connected with the engraving of bonds and the preparation of the mortgage to secure the bonds. The item 'Engineering and Superintendence' is only a small part of the engineering and superintendence properly chargeable to the construction, the balance of such charge being distributed in the other items, and a large portion of the engineering and superintendence having been furnished by the Georgia Railway & Electric Company without charge. The item 'Right of way,' includes only the actual payments to the owners of the land for the privilege of constructing the road."

"The gross receipts for the year ending December 31, 1907, were \$128,445.65; operating expenses, as charged on the books, were \$99,303.72. In the operating expenses no allowance has been made for depreciation and final renewals, or contingencies. A fair annual allowance, in addition to maintenance, required to take care of such depreciation, would be at least \$20,732.98, being 5 per cent of the cost of those items of the property which deteriorate. The amount of taxes paid for 1907 was \$3,279.42. The net earnings for the year, above operating expenses, taxes and allowance for depreciation, will be \$15,206.38, which is a return of 2½ per cent on the total cost of the property, \$605,031.25.

"The year 1907 was a prosperous year in all lines of business but toward the latter part of the year there was a general falling off in all business. Respondent's earnings reflect this general condition and there has been a decrease in its gross earnings and an increase in the operating expenses. For January, 1908, the gross receipts, as compared with January, 1907, decreased \$2,528.81, or 25.66 per cent; operating expenses increased \$857.22, or 12.35 per cent, and were 106.4 per cent of the gross receipts, whereas operating expenses for January, 1907 were 70.4 per cent of the gross receipts. In February, 1908, the gross receipts decreased \$2,223.72, as compared with

February, 1907. For December, 1907, gross receipts were \$863.94 less than for December, 1906, showing a decrease of 7.58 per cent; operating expenses for December were 95.18 per cent of the gross receipts, whereas for the month of December, 1906, the operating expenses were only 60.39 per cent of the gross receipts. Instead of decreasing revenues, it is absolutely essential to increase the revenues or to decrease the service furnished and thereby lessen expenses, in order that respondent may be able to earn sufficient to pay its operating expenses and taxes, without any regard for the cost of the property or any return whatever on such cost or on any valuation whatever.

"No dividend whatever has been paid. The entire earnings have been required for the operation and maintenance of the property, and in paying interest and no sum has been left over, and in fact not enough accumulated to meet the expenses with which respondent is now faced. About a year ago application was made to the railroad commission for a reduction of the passenger fares, and as a result of such investigation the commission decided that the fares charged were reasonable and should not be reduced.

"The rate of fare now charged is not unreasonable. It is reasonable to the public because the service rendered is well worth the charge made, and from the standpoint of the company it does not yield any profit to its projectors and stockholders, or any return for money invested, risk undertaken, or the energy, efforts, skill and ability required in its construction and operation. The rates are no higher than those charged by similar railroads in other sections of the United States and, its fares are lower than those charged by other railroads in Georgia. Respondent is in no condition to stand a reduction of its present fares; such reduction would destroy its ability to provide such service as its patrons are entitled to and would render it unable to earn operating expenses and interest on its debts. This road is the first railroad of its class to be built in Georgia; the building of such roads is of great advantage to the people. It would be against public policy and the interest of the people to discourage the building of such roads by forcing the amount of their charges so low as to deprive them of a reasonable return on the investment necessary to be made. The charges made by respondent are as low as it is possible for them to be made for such a road and leave any hope for any return."

**Orders Affecting Service in New York.**—The New York public service commission, first district, has ordered the Interborough Rapid Transit Company to run three additional 7-car trains on the Third Avenue elevated road in the rush hours. The company is also ordered to "satisfy or answer" a complaint that there are too few ticket booths at the Brooklyn bridge station of the subway.

**Contract with Express Company Not Renewed.**—The receivers of the New York City Railway have ordered that the contract with the American Express Company, which expired on March 15, shall not be renewed. The receivers maintain that the large number of package cars required impaired the efficiency of the passenger service. The American Express Company will probably inaugurate an automobile truck service to meet the new conditions.

**Rates to Brazil, Ind.**—The Terre Haute Indianapolis & Eastern Traction Company of Indianapolis has filed an answer to the petition of residents of Brazil, Ind., to the Indiana railroad commission, requesting the commission to compel the company to readjust rates on the line between Brazil and Terre Haute. In its answer the company declared that it had petitions from the majority of their patrons along the territory asking that the new rates be maintained, and expressing themselves as being perfectly satisfied with the new rates.

**Transfer Station Decision in Boston.**—The Massachusetts railroad commission has disapproved the application of the Boston Elevated Railway for permission to abandon the free transfer station at Coolidge Corner. The commission holds that the maintenance of the transfer system tends to improve the facility of travel and the accommodation of the public.

**More Through Routes in Chicago.**—The board of supervising engineers, Chicago traction, has ordered the introduction of more through routes, following the introduction of route No. 22 on March 17. The latter route was described in last week's issue of the Electric Railway Review. Routes Nos. 1, 11, 12 and 14, for which provision is made in the ordinances of the Chicago City Railway and the Chicago Railways Company, will be combined as Route No. 23. This route will extend from Ogden and Fortieth avenues on the west side to the car house on North Clark street, and is to be introduced not later than April 7. Route No. 9 will be established on March 30.

# Construction News

## FRANCHISES.

**Columbia, Mo.**—The Missouri Land Improvement & Development Company has applied to the city council for a franchise for a street railway.

**Gary, Ind.**—The Gary & Interurban Railroad has applied for an extension of time in which to complete its line under the provisions of its franchise.

**Greeley, Colo.**—The Denver & Greeley Railroad, Denver, Colo., has been granted a franchise to enter Greeley with its proposed electric line between Denver and Greeley, Colo., contingent upon having the line completed within three years. Right of way is said to have been secured. J. D. Houseman, Denver, general manager. (Noted November 2, 1907.)—The Greeley & Northern Railway & Utility Company secured a franchise some time ago for the operation of its line in Greeley, which the city council contends has expired. The company has done considerable grading between Greeley and Evans, Colo., and has purchased a right of way paralleling the route of the Union Pacific. It is reported that the two companies may be merged.

**Greensboro, N. C.**—Charles L. Van Noppen and associates have been granted a franchise in Greensboro for the construction of a 3-mile electric railway in West Market and Lateral streets. It is stated that construction work will be started as soon as the weather permits.

**Haverstraw, N. Y.**—The West Shore Traction Company has been granted a franchise for a line through the village.

**Portland, Ore.**—A franchise has been granted to the United Railways Company for the construction of its line to Mt. Calvary and Hillsboro, Ore. The company has one year in which to complete the work. A franchise also has been applied for to construct an electric line on the east 20 feet of the White House road to Riverview cemetery, the company agreeing to complete the line within two years or forfeit the franchise. E. E. Lytle, president, Portland, Ore. (Noted January 11.)

**Pueblo, Colo.**—The Pueblo & Arkansas Valley Electric Railway Company has secured an extension of time in which to start construction work on its proposed interurban line from Pueblo, Colo., to points in the Arkansas valley. The delay is said to have been caused by the inability of the company to secure right of way owned by various holders near Pueblo. (Noted December 28, 1907.)

**Redding, Cal.**—The franchise of the Redding & Red Bluff Electric Railway is said to have been revoked by the board of supervisors because the time for beginning construction on its proposed electric line from Redding to Red Bluff, 33 miles, had lapsed. (Noted September 21, 1907.)

**Springfield, Mass.**—The Springfield (Mass.) Street Railway Company has presented to the city council petitions for six separate locations of track, including those on Federal and State streets, the latter affording trolley freight facilities for the United States armory. The locations are in accordance with the plans outlined before the board of aldermen a few weeks ago. A hearing of the petitions will be given on April 6.

**Taylorville, Ill.**—The St. Louis Terre Haute & Quincy Traction Company has secured a franchise in Taylorville for the operation of its interurban line in that city. Most of the right of way in Christian county has been secured. Edward Yates, Pittsfield, Ill., is president. (Noted December 28, 1907.)

**Wilmington, Del.**—The People's Railway Company has applied for a franchise to build an electric railway from Seventh and Church to Fourth and Church streets, Wilmington, connecting with the boats of the Wilmington Steamboat Company. R. W. Crook, general manager, Wilmington.

## RECENT INCORPORATIONS.

**Baltimore & North Branch Railway, Baltimore, Md.**—This company has applied for a charter for an electric railway from Woodlawn, near the city limits of Baltimore, Md., between Windsor Mills and Libertypike, to Hebbville, Randallstown and Long Branch. It is proposed to carry both freight and passengers. The line will connect with the Woodlawn line of the United Railways & Electric Company, which will be asked to operate the line on its completion. The road is being promoted by property-holders along the route and arrangements for securing right of way have been made. Capital stock, \$50,000. Incorporators: B. J. Vlack, Emory

George, H. M. Benzinger, Isaac Price, James Bosley and George D. Lynch.

**Calumet & South Chicago Railway, Chicago, Ill.**—Incorporated in Illinois to effect a consolidation of the South Chicago City Railway and the Calumet Electric Street Railway, under the provisions of a new franchise extension ordinance now pending before the Chicago city council. Capital stock, \$1,000. Incorporators: L. A. Bushy, H. P. Weber and E. B. Hamilton.

**Interstate Traction Company, Jersey City, N. J.**—Incorporated in New Jersey to operate steam and electric railways, etc. Capital stock, \$200,000. Incorporators: G. R. Warner, B. S. Mantz, A. C. Baer.

**Irwin & Herminie Street Railway.**—Incorporated in Pennsylvania to construct an electric railway between Irwin and Herminie, Pa., 5½ miles. Construction is to be started at once. Capital stock, \$35,000. Holman B. Lynn, president, Pittsburg, Pa.

**Jefferson Interurban Railway, Jefferson, Ia.**—Incorporated in Iowa to build an interurban railway from Jefferson to Des Moines and Perry. Two routes are under advisement, one by way of Bagley to a connection with the proposed Des Moines & Sioux City Railway of Lake City, Ia., and the other by way of Ft. Dodge Junction and Paton connecting with another proposed electric line out of Ft. Dodge. Capital stock, \$10,000. Incorporators: Albert Head, president; Henry Haag, vice-president; Mahlon Head, treasurer. P. L. Cockerill, E. H. Carter, S. J. Sayers, Judge Z. A. Church, J. M. Forbes, A. D. Howard and Fred E. Gamble, are the directors. (Noted February 29.)

**Marlam Construction Company.**—Incorporated in Kansas to build the Kansas City & Kansas Southwestern Electric Railway (noted March 14), connecting Topeka, Kansas City, Independence and Lawrence, Kan. It is stated that work will be started at once. Capital stock, \$500,000. Incorporators: J. E. Martin, Minneapolis; E. M. Lambkin, Kansas City; W. L. Moyer, New York; W. Laming, Tonganoxie; S. W. Brewster, Chanute, Kan.; H. E. Hopper, Indianola, Ia.; C. S. Dudley, Minneapolis, Minn.

**Oregon Rapid Transit & Power Company, Jacksonville, Ore.**—Incorporated in Oregon to construct and operate electric railways serving the entire Rogue river valley. According to present plans the northern and southern termini of the line will be at Grant's Pass and Ashland, respectively, connecting the towns of Woodville, Gold Hill, Tolo, Central Point, Medford, Phoenix, Talent, Jacksonville and Eagle Point. Officers will be elected this week and engineers started on the survey of the line in the near future. Capital stock, \$3,000,000. Incorporators: J. E. Watt, F. E. Metrick, F. E. Page, A. S. Bliton, S. A. Nye, F. L. Evans.

**United Railways, Jersey City, N. J.**—Incorporated in New Jersey to operate steam and electric railways. Capital stock, \$200,000. Incorporators: John R. Turner, H. O. Coughlan, L. H. Gunther.

## TRACK AND ROADWAY.

**Ardmore (Okla.) Traction Company.**—It is announced that tracklaying on this company's 2¼-mile extension to its summer park will be started as soon as the rails have arrived. Most of the trolley poles have been erected and the ties are now being distributed. J. F. Robinson, general manager, Ardmore. (Noted February 8.)

**Asheville & Hendersonville Railroad, Asheville, N. C.**—Engineers are said to be making surveys for this proposed line from Asheville to Hendersonville, N. C., 22 miles, work on which has progressed to a point beyond Hillgirt, N. C. C. F. White, Skyland, N. C., is interested. (Noted January 11.)

**Athens & Anderson Electric Railway, Hartwell, Ga.**—This company will make surveys at once for an electric railway 73 miles long, through Carleesville, Hartwell, Cannon and Iler, Ga. W. L. Hodges of Hartwell is interested.

**Baltimore & Washington Transit Company, Washington, D. C.**—The senate has passed a bill authorizing this company to extend its lines in the District of Columbia.

**Chicago Kankakee & Champaign Electric Railway.**—It is stated that work on this proposed line will be started this spring. A survey of the route has been made and right of way is being secured. When completed direct communication by trolley from Champaign to Chicago will be afforded. F. B. Vennum, Champaign, Ill., is interested. (Noted December 21, 1907.)

**Chicago South Bend & Northern Indiana Railway, South Bend, Ind.**—This company has a large force of men at work on its 27-mile extension from South Bend to Laporte, Ind.

During the summer the company will open a park at Chain lakes, seven miles west of South Bend, on the line of the new extension, which will be one of the largest of its kind in northern Indiana. Samuel Riddle, general manager, South Bend. (Noted February 29.)

**Corsicana-Palestine Interurban Railway, Corsicana, Tex.**—This company, after an inactivity of about five months on account of the financial situation, is preparing to begin construction on its line between Corsicana and Palestine, Tex., 58 miles. Surveys will be made and it is expected that the final location of the route will be adopted by April 15.

**Denver & Interurban Railway, Denver, Colo.**—Work on this line is being pushed, and it is expected that regular service will be started between Denver and Boulder, Colo., by June 1. The cars will operate from Globeville to Denver over the tracks of the new Globeville line of the Denver City Tramway Company, which it is expected will be completed within 60 days. Most of the poles for the Denver & Interurban line have been set and the wire is being strung. The cars will be 55 feet long with four 125-horsepower motors and will run hourly from Denver to Boulder. It is expected to use the new electric line for the local traffic, the express traffic being cared for by the Colorado & Southern steam road, the owner of the new interurban line. The interurban company will operate the Eldorado Springs (steam) Railway from Marshall to the summer resort at Eldorado Springs, Colo., which it recently purchased and electrified. This line also will be ready for operation this summer. E. E. Hartman, superintendent, Denver. (Noted February 15 and 29.)

**Elizabethtown & Florin Street Railway.**—This company has filed notice with the state department at Harrisburg, Pa., of an extension of route. The extension will pass through Florin, Mt. Joy, Rheems and Elizabethtown, seven miles, with a terminus at Middletown, Pa., where connection with the Central Pennsylvania Traction Company's lines will be made. It is expected that work will be started about April 1. The company is capitalized at \$220,000. It is stated that the Conestoga Traction Company, Lancaster, Pa., will lease the line upon its completion. The officers are: W. W. Griest, president; C. Edgar Titzel, manager; J. S. Graybill, Jr., secretary and treasurer; H. W. Crawford, chief engineer; all of Lancaster, Pa.

**Franklin & Towamensing Street Railway, Slatington, Pa.**—This company is said to have completed surveys and secured most of the right of way for its proposed electric line from Slatington to Bowmans, by way of Leighton and Palmerton, Pa. Construction work will probably be started late in the spring or early in the summer. A. P. Berlin, president, Slatington. (Noted February 1.)

**Ft. Smith Checotah & Shawnee Interurban Railway, Checotah, Okla.**—R. G. Smith, vice-president and general manager, states that this company, recently incorporated to build an electric railway from Ft. Smith, Ark., to Shawnee, Okla., is now considering propositions from several engineering companies to make the surveys. (Noted January 11.)

**Gray's Harbor Railway & Light Company, Aberdeen, Wash.**—It is stated that this company will make extensive improvements to its city and interurban lines during the coming summer. Jay D. Crary, general manager, Aberdeen.

**Interborough Rapid Transit Company, New York.**—This company is building an elevated extension of the Broadway subway line from Two Hundred and Thirtieth street to Van Cortland Park, one mile; also a subway extension from Borough Hall, Brooklyn, to Atlantic avenue, 0.89 mile.

**Lawton Denton & Dallas Electric Railway, Dallas, Tex.**—S. E. McCully, secretary and general manager, states that the plans for building this proposed 80-mile electric railway are being revived and that money has been secured for obtaining right of way and doing the preliminary work.

**Lederachville & Pennsburg Traction Company.**—This company is said to have awarded contracts for the construction of two concrete bridges, one of which will cross Branch creek near Lederachville and the other over Swamp creek at Summeytown, Pa., on the route of its proposed electric railway from Lederachville to Pennsburg, Pa.

**Ohio Electric Railway, Cincinnati, O.**—The contractors are about to resume work on the completion of the Lima-Toledo line, between Deshler and Waterville only a portion of the track has been laid and there is a considerable amount of tracklaying to be done between Waterville and Toledo. The 1,200-foot concrete bridge over the Maumee river is completed, except for the approaches. F. T. Hepburn, district manager Lima, O. (Noted March 7.)

**Los Angeles (Cal.) Railway.**—A large force of men under the direction of George Kuhrts, chief engineer, has begun the construction of the line from Riverside to Colton, Cal.

**McMinnville, Tenn.**—John Henderson of this city is interested in a proposed electric railway from Cincinnati to Huntsville, Ala., by way of Nashville, Woodbury and McMinnville. Surveys for the line were made some time ago and work was started on a dam at Caney Fork Falls, from which power for the operation of the line was to be secured. This work was abandoned on account of legal complications, which are now said to have been settled. It is stated that \$138,000 has been subscribed by Cannon county.

**Oregon Electric Railway, Portland, Ore.**—W. S. Turner of New York has been sent to Portland by the engineering firm of W. S. Barstow & Co. to take charge of the construction of the extension from Portland to Hillsboro and Forest Grove.

**Philadelphia Rapid Transit Company.**—Tracklaying has been started in the section of the Market street subway east of Eighth street.

**Pittsfield (Mass.) Street Railway.**—It is reported that construction will begin this spring on the extension from the present terminus of the Pittsfield lines to the New York-Massachusetts state line, a part of the proposed connection between Albany and Pittsfield.

**Portland (Ore.) Railway Light & Power Company.**—It is stated that this company will build a double-track extension to its east side interurban lines, commencing at a point near the Southern Pacific main line at the Inman-Poulsen mill, north to Hawthorne avenue and from there westward across the Madison street bridge. By this means the heavy passenger traffic will be carried around the company's freight yards instead of through them, as formerly. B. S. Josselyn, president, Portland, Ore.

**Pottstown & Reading Street Railway, Pottstown, Pa.**—It is understood that this company is planning an extension to Linfield, Pa., surveys for which have been made. Work will be started during the summer. Harry Sweinhart, general manager, Pottstown.

**St. Louis Terre Haute & Quincy Traction Company, Springfield, Ill.**—This company, which was incorporated last year to build an electric railway from Terre Haute, Ind., to Quincy, Ill., has purchased the property of the Virden & Taylorville Railway and the Roodhouse & Virden Traction Company, including right of way which will be used for a portion of the line between Taylorville and Quincy, Ill.

**St. Tammany & New Orleans Railway & Ferry Company.**—It is stated that this company will shortly let contracts for material and equipment for its proposed electric line connecting Covington, Abita Springs and Mandeville, La., 18 miles. Clav Riggs, Covington, La., president. (Noted December 14, 1907.)

**Santa Ana Tustin & Huntington Beach Railroad.**—Plans for the building of an interurban line from Tustin to Santa Ana and Huntington Beach, Cal., which were submitted to the Chamber of Commerce and the Merchants & Manufacturers Association of Santa Ana, have been endorsed by those bodies and committees have been appointed to secure the necessary capital, all of which it is stated will be supplied by local business men. The road will afford a through route to the beach and to the peat lands in the vicinity of Huntington Beach, and will be operated by gasoline motor cars.

**Sheridan, Wyo.**—S. A. Broadwell, Omaha, Neb., representing eastern capitalists, has applied for a franchise to build an electric railway in Sheridan, agreeing to have part of the line in operation by next fall. The road will connect the large coal camps in the vicinity with this city. It is stated that power for the operation of the line will be secured from Big Goose Falls as well as from an auxiliary steam plant to be installed at one of the mines. Mr. Broadwell obtained a franchise last fall from the council of Thermopolis, Wyo. (Noted October 26, 1907.)

**Spokane & Inland Empire Railroad, Spokane, Wash.**—It is reported that 14 miles have been graded and ½ mile of track laid on the extension from Palouse, Wash., south to Moscow, Idaho, 15.5 miles. Grant, Smith & Co. of St. Paul, Minn., have the contract. (Noted February 15.)

**Springfield (Mass.) Street Railway.**—It is stated that this company has under way plans for an extension of its line on East street in Chicopee, Mass. A franchise will be applied for as soon as the plans have been completed. H. C. Page, general manager, Springfield, Mass. (Noted January 11.)

**United Traction Company, Albany, N. Y.**—It is expected that work on the extensions of the east side line in Upper Rensselaer will be started by this company by April 1 or April 15. The material has been ordered and as soon as it arrives, a large force of men will be put to work with a view to having the improvements completed and in operation by next fall. (Noted December 28, 1907.)

**Utica & Mohawk Valley Railway, Utica, N. Y.**—This company expects to build a ½-mile extension in Rome, N. Y., this spring if conditions warrant.

**West Chester & Wilmington Electric Railway.**—This company, which has been chartered to build an electric railway 17 miles long between West Chester, Pa., and Wilmington, Del., with the right to operate in both states, will be practically an air line south from West Chester and will be on private right of way parallel to and adjoining the old concrete turnpike. Seventy-pound T-rails will be used. The overhead construction will be of the bracket type, using No. 0000 copper wire. Double-truck semi-convertible cars will be operated. Freight traffic also will be handled. Thomas E. O'Connell, president, Wilmington, Del. (Noted February 22.)

**York & Shrewsbury Electric Railway.**—This company has commenced the survey for its proposed electric line from York to Shrewsbury, Pa. D. B. Goodling, president, Loganville, Pa.; J. H. Keller, secretary, Shrewsbury; S. M. Manifold, chief engineer, York, Pa.

#### POWER HOUSES AND SUBSTATIONS.

**Albany & Hudson Railroad, Albany, N. Y.**—R. H. Smith, general manager, writes that a contract has been let to the Babcock & Wilcox Company for a 550-horsepower boiler to be installed in the power house at Stuyvesant Falls, N. Y. The W. K. Mitchell Company of Philadelphia will make the necessary pipe changes and the Ehret Magnesia Manufacturing Company will supply the pipe covering. (Noted March 7.)

**Connecticut Company, New Haven, Conn.**—This company has contracted with the Hariford Electric Company for a supply of power for the lines in New Britain, Berlin and Plainville, Conn., from its power plant at Dutch Point.

**Gray's Harbor Railway & Light Company, Aberdeen, Wash.**—This company has recently completed a \$250,000 power station located between Hoquiam and Aberdeen, Wash. J. D. Cray, general manager, Aberdeen. (Noted November 16, 1907.)

**Houghton County Street Railway, Houghton, Mich.**—This company is said to be preparing plans for the construction of a power station at Laurium, Mich. W. H. McGrath, manager, Houghton, Mich.

**Lewiston Augusta & Waterville Street Railway, Lewiston, Me.**—It is announced that this company will erect a transmission line from the power plant now under construction on the Sebasticook river to Winslow and Lewiston, 36 miles, for which franchises have been obtained in Vassalboro, Sidney, Augusta, Manchester, West Gardiner and Litchfield. The company has leased for 99 years the power plant of the Fort Halifax Power Company in Winslow, Me., and has recently let contracts for the construction of two substations, one at Vassalboro and the other at Monmouth. E. D. Reed, general manager, Lewiston, Me. (Noted February 22.)

**Pittsburg & Butler Street Railway, Pittsburg, Pa.**—This company is reported to be installing a new turbo-generator in its power station at Renfrew, Pa.

**San Bernardino Valley Traction Company, San Bernardino, Cal.**—This company has awarded a contract to the Pacific Light & Power Company to furnish power for the operation of its lines. Power will be supplied from the power plant at Santa Ana canyon to two substations at San Bernardino and at Arrowhead.

**Veblen (S. D.) Traction Company.**—It is reported that this company, recently incorporated to build an electric railway from Lidgerwood, N. D., to Veblen, S. D., will begin construction work this spring. H. P. Hammersbach of Veblen is president and George F. Anderson of Veblen is secretary.

**West Chester & Wilmington Electric Railway.**—This company, which owns charters to operate an electric railway in both Pennsylvania and Delaware, will build a brick power house at Brandywine Summit, the central location of the line. Two 500-kilowatt generators will be installed connected to Corliss engines, together with an equipment of water tube boilers. Thomas E. O'Connell, Wilmington, Del., is president.

**Milwaukee Electric Railway & Light Company, Milwaukee, Wis.**—It is announced that a 2,500-horsepower engine will be installed in the power house at Racine, Wis.

## Personal Mention

Mr. Frederick L. Hutchinson has been appointed assistant secretary of the American Institute of Electrical Engineers, with office at New York City.

Mr. Francis S. Peabody of Chicago has been elected president of the Mattoon City Railway, Mattoon, Ill., succeeding Mr. E. A. Potter, resigned.

Mr. Daniel K. Harrington has been appointed superintendent of the Hamburg and Orchard Park line of the Buffalo Southern Railway, Gardenville, N. Y.

Mr. Howard M. Bougher has been elected president of the Burlington County Railway, Mt. Holly, N. J., succeeding his father, Josia K. Bougher, who died recently.

Mr. F. A. Burkhardt, division passenger and freight agent of the Ohio Electric Railway, at Lima, O., has had his jurisdiction extended over the lines from Dayton to Toledo and from Lima to Ft. Wayne and Defiance, O.

Mr. Frank M. Lott has been appointed master mechanic of the Green Bay Traction Company, Green Bay, Wis. Mr. Lott formerly was chief wireman of the southern division of the Public Service Corporation of New Jersey.

Mr. A. F. Schoepf, superintendent of the Columbus Grove City & Springfield line of the Ohio Electric Railway at Columbus, O., has had his jurisdiction extended over the Dayton Springfield & Urbana line, succeeding Mr. M. J. Loftus.

Mr. E. W. Hendershot has been appointed to the new position of comptroller of the Illinois Traction System at Champaign, Ill. Mr. Hendershot has been for several years auditor of agencies for the Sun Life Assurance Company of Canada at Montreal.

Mr. Harry McColgin, heretofore general freight agent of the Indianapolis Columbus & Southern Traction Company, Columbus, Ind., has resigned to become auditor of the Indianapolis & Louisville Traction Company, with headquarters at Scottsburg, Ind. Mr. Thomas C. King will succeed him as general freight agent at Columbus.

Mr. Wayne Hendricks, who has been connected with the Winnebago Traction Company, Oshkosh, Wis., since 1900, has been appointed superintendent of the Sterling Dixon & Eastern Electric Railway, Dixon, Ill., succeeding Mr. Lee H. McCray, who has resigned to accept a position with the Atlantic Shore Line Railway, Portsmouth, N. H.

Mr. A. A. Barnes has been elected president of the Indianapolis Crawfordsville & Western Traction Company of Indianapolis, Ind., succeeding Mr. A. E. Reynolds, resigned. Mr. A. M. Hewes, of the Electrical Installation Company, Chicago, Ill., which is operating the road, has been appointed general manager and Mr. A. H. Stocking has been appointed acting manager.

Mr. Ward Hubbard, formerly assistant superintendent of roadway of the Indiana Union Traction Company, has been appointed division superintendent with headquarters at Tipton, Ind., in charge of the lines between Indianapolis and Logansport, Kokomo and Peru, and Tipton and Anderson. He will be succeeded by Mr. A. Dunlap as assistant superintendent of roadway.

Mr. George E. Hamilton has been elected president of the Capital Traction Company, Washington, D. C., to succeed the late George T. Dunlop. Mr. Hamilton is a member of the law firm of Hamilton, Colbert, Yerkes & Hamilton, and has been a director of the Capital Traction Company for two years. Mr. D. S. Carl, for several years superintendent and chief engineer, has been elected to the newly created office of second vice-president and general manager.

Mr. C. S. Compton, chief engineer of the Northern Electric Company at Chico, Cal., has resigned, effective on April 1, to become president of the Paradise Polytechnic Institute of Paradise, Cal. Mr. Compton is a graduate of the Iowa State College and has had charge of the construction of the Northern Electric Company's lines since the preliminary work was started. He will be retained by the company as consulting engineer and in this capacity will direct the engineering work on the extensions now in progress.

The office of general master mechanic of the New York City Railway has been abolished with the resignation of Mr. Thomas Millen, which was announced in last week's issue. Mr. Alexander McIver has been appointed superintendent of equipment and will have charge of all the carpenter and paint-

ing work in connection with car repairs, in addition to his former duties as superintendent of electrical car houses, which position has been abolished. Mr. H. P. Clarke has been appointed master mechanic in charge of shops. He will have charge of the machine, plow and wheel shops of the system in addition to shops formerly under his jurisdiction as master mechanic of the One Hundred and Forty-sixth street electrical shops, which position has been abolished.

Mr. E. T. Munger, heretofore master mechanic of the Metropolitan West Side Elevated Railway of Chicago, has been appointed superintendent of motive power and equipment, effective on March 14, succeeding Mr. Benjamin H. Glover, whose title was superintendent of motive power. Mr. Munger was born at Mukwonago, Wis., in 1870. He graduated from the Menominee (Mich.) High School in 1886 and from the University of Wisconsin in 1892. After leaving college he entered the service of the Hall Signal Company as draftsman and was soon promoted to foreman of construction. He was then for two years connected with the National Switch & Signal Company at Chicago engaged in railway interlocking installation. From 1896 to 1898 he was construction foreman for the Metropolitan West Side Elevated Railway and from 1898 to 1899 he was general foreman of the Englewood & Chicago Railroad, an electric storage battery line in Chicago. In 1899 he went to Havana, Ill., as general manager of the Havana Electric Light & Telephone Company. On September 15, 1903, he was appointed master mechanic of the Metropolitan Elevated road, which position he has held until his present promotion. As superintendent of motive power and equipment, Mr. Munger has charge of the company's power house, substations, cars and car shops, as well as of the entire feeder and transmission system, storage batteries and the lighting and telephone system. His office will be at the Centre avenue shops, 146 Throop street.

Mr. Frank R. Henry has been elected vice-president and secretary of the Majestic Manufacturing Company of St. Louis, Mo., and expects to be actively engaged with that company shortly after April 1.

This will necessitate his resignation as auditor of the United Railways Company of St. Louis. While Mr. Henry will sever his active connection with street railways, he will still be identified with the United Railways Company in the honorary capacity of president or vice-president of a number of its constituent companies. Mr. Henry was born and brought up in St. Louis and his active service with street railways in that city covers a period of 24 years. During that time there have been numerous changes in the street railways of the city, with four complete changes in management. Prior to the organization of the United Railways Company, Mr. Henry was auditor of the St. Louis Transit Company, the property of which was acquired by the United Railways. As the duties of Mr. Henry with the Majestic Manufacturing Company will require his undivided attention, he has found it necessary to resign as a member of the "classification" committee of the American Street and Interurban Railway Accountants' Association. Mr. W. B. Brockway has been appointed as his successor on that committee. Mr. Henry has not yet determined whether it will be necessary for him to resign from the office of president of the American Street and Interurban Railway Accountants' Association, to which he was elected at the annual meeting at Atlantic City in October of last year. He has been an active worker in the Accountants' Association and in the Street Railway Accountants' Association of America, which preceded the present larger and more influential organization.

**OBITUARY.**

William Jones, for a number of years general manager of the Oakwood Street Railway, Dayton, O., died last week. He had been connected with the company in various capacities for the past 35 years, starting in as a carpenter and rising through successive promotions to the position of general manager and superintendent of tracks.



Frank R. Henry.

# Financial News

**American Light & Traction Company, New York.**—At the annual meeting of stockholders, George Blumenthal was elected a director to succeed L. H. Withey.

**Boston Elevated Railway.**—W. A. Bancroft, the president, has issued a statement saying that the company does not consider that it is its duty at the present time to press house bill 613 against any substantial opposition, and it will, therefore, request the committee on street railways to withdraw the bill. The statement gives the following reasons, however, why the bill should be enacted: "The Boston Elevated Railway owns the terminal railway of the metropolitan district. Other street railway lines run in from different points in the metropolitan district to connections with the company. The company can, in connection with its own properties, manage at least some of these tributary lines with greater economy and give better public service than is being done at present. The simplest and best way would undoubtedly be for the company to consolidate with or lease such lines. That cannot be done without extending the 5-cent fare beyond all reasonable limits. The only way in which the public can obtain the advantages arising from the management by the company of tributary lines is by permitting the company to acquire the stock of such lines. By requiring in each case a previous determination by the railroad commission that such purchase is in the public interest the rights of the public are safeguarded, and any danger of the abuse of the power given to the Boston Elevated Railway is eliminated. The company believes that the acquisition of tributary surface lines by the main terminal company of the metropolitan district is for the public benefit and along the line of modern development in other large centers."

**Camden (W. Va.) Interstate Railway.**—Stockholders have voted to change the name of this company to the Ohio Valley Traction Company and to issue \$400,000 of preferred stock. It is reported that the preferred stock will be used for the purpose of acquiring control of the Kanawha Valley Traction Company, Charleston, W. Va.

**Central California Traction Company, San Francisco, Cal.**—An assessment of \$5.00 a share has been announced on the stock.

**Charleston & Summerville Electric Railway, Summerville, S. C.**—A committee has approved a plan for completion of the road. To provide the \$600,000 which it is estimated will be required to finish the main line, subscriptions are being received for an issue of about \$600,000 bonds. Existing claims will be liquidated with an issue of preferred stock at par.

**Chicago Railways Company.**—Holders of the stocks of the Chicago Union Traction Company and the underlying companies will be assessed \$905,978 on account of the expenses of reorganization, including the sale of the property to the Chicago Railways Company. Union Traction preferred stock is to be assessed \$3.33 a share and the common stock \$1.00 a share. Underlying stocks owned outright by the Union Traction Company are not to be assessed, but independent holders of the underlying stocks must make payments as follows: West Chicago Street Railroad stock, \$1.28 a share; Chicago West Division Railway stock, \$7.65 a share; North Chicago Street Railroad stock, \$1.98 a share; North Chicago City Railway stock, \$7.65 a share.

**Dayton & Xenia Transit Company, Dayton, O.**—Upon application of the Worcester (Mass.) Trust Company, Judge Albert C. Thompson of the United States district court at Cincinnati appointed, on March 12, C. J. Ferneding, president of the company, as receiver. The application stated that the interest due in 1906 and 1907 on the second mortgage 5 per cent bonds was in default. The trust company is trustee under the mortgage securing those bonds. The Transit Company operates 51 miles of track from Dayton to Xenia and from Dayton to Spring Valley. The company was formed in 1901 to acquire the properties of the Dayton & Xenia Traction Company and the Rapid Transit Company of Ohio. The outstanding stock is \$800,000 and the outstanding bonds aggregate \$800,000, of which \$500,000 are first mortgage bonds.

**Delaware & Hudson Company, Albany, N. Y.**—Holders of 4 per cent debenture bonds of this company have gone into court in an effort to enjoin permanently the payment of the regular quarterly dividend of the stock of this company. They have attacked the purchase of control of the Hudson Valley Railway of Glens Falls, N. Y., and of various coal lands.

**Interborough Rapid Transit Company, New York.**—The New York public service commission, first district, held a

hearing on March 16 on the application of this company for approval of the proposed mortgage securing an issue of \$55,000,000 bonds. E. F. J. Gaynor, auditor of the company, testified that the Brooklyn subway extension cost \$10,066,205 in excess of the amount paid by the city of New York. This was paid by the Rapid Transit Subway Construction Company. On December 31, 1907, the Interborough Company owed the Subway Construction Company \$7,431,306. Since that date the Interborough Company has advanced to the Construction Company about \$3,000,000, leaving a balance still due of approximately \$4,431,306. William M. Ivins, special counsel for the commission, suggested that the company submit a schedule of its capital requirements during the year so that they could all be considered at once. The hearing was adjourned until March 28.

**Lackawanna & Wyoming Valley Rapid Transit Company, Scranton, Pa.**—Judge Young of the United States circuit court, Pittsburg, has authorized the receivers of the Westinghouse Electric & Manufacturing Company to pay the interest due on February 1 on \$6,000,000 first mortgage bonds of the transit company, held by a trust company as collateral for a loan.

**Lehigh Valley Transit Company, Allentown, Pa.**—The Philadelphia stock exchange has listed \$323,575 additional preferred stock voting trust certificates and \$217,250 additional common stock voting trust certificates.

**Massachusetts Electric Companies, Boston.**—Shareholders of the Old Colony Street Railway, a controlled line, have voted to apply to the Massachusetts railroad commission for approval of an issue of \$750,000 stock. Stockholders of the Boston & Northern Street Railway, another controlled property, voted to apply to the commission for approval of an issue of \$1,250,000 stock.

**New York City Railway.**—The receivers have filed a petition with the state board of tax commissioners asking that the special franchise taxes be reduced. The substance of the petition follows: The New York City Railway became the lessee of the system in 1902, and ever since that time in each year the property as a whole has never been a paying one, and each year the company has faced and paid an increasing deficit. The defaults in interest or guaranteed rentals under the receivership aggregate \$7,481,245. The changes in gross earnings of the surface lines and passenger traffic since 1902 have been as follows:

Year.	Revenue passengers.	Transfer passengers.	Gross earnings.
1903.....	396,243,922	158,626,750	\$21,864,835
1904.....	389,608,537	168,267,818	21,865,899
1905.....	374,258,395	168,957,760	21,305,421
1906.....	391,354,877	178,639,866	22,362,688
1907.....	376,629,571	194,765,342	21,874,630

An analysis of the income account for the year ended June 30, 1907, is presented, constructed on the theory that in the current fiscal year the company should provide for special franchise taxes, for which only partial provision has been made in the past; an adequate depreciation fund, not included heretofore; and should offset from the 1906-07 earnings an amount equivalent to the estimated shrinkage in gross earnings and increase in operating expenses for the present fiscal year. The figures follow:

Gross earnings, year ended June 30, 1907.....	\$21,874,630.72
Operating expenses and maintenance, excluding interest, rentals, taxes and depreciation.....	13,172,571.03
Taxes, including special franchise taxes as claimed by the state equalized at 89 per cent.....	2,039,355.91
Balance.....	\$ 6,662,703.78
Deduct—	
Estimated decrease gross earnings for 1908.....	1,100,000.00
Estimated increase operating cost for 1908.....	1,000,000.00
Depreciation.....	3,000,000.00

Balance applicable to return on investment. \$ 1,562,703.78

The fixed charges on the New York City Railway system, which were met up to last September, were in excess of \$12,000,000. This sum included the \$7,481,245 of guaranteed rentals and interest now in default.

**Ontonata & Mohawk Valley Railroad, Ontonata, N. Y.**—Gross earnings in the quarter ended December 31, 1907, were \$41,173, an increase of \$5,254 over the corresponding quarter of the previous year. Operating expenses were \$43,655, an increase of \$4,696. The net deficit was \$2,482 as compared with a deficit of \$3,040. The final deficit, after payment of fixed charges, was \$13,651 in the 1907 quarter as compared with \$14,136 in the 1906 quarter.

**Rutland (Vt.) Railway Light & Power Company.**—Gross earnings in the year ended February 29, 1908, were \$253,112,

expenses were \$143,162 and net earnings were \$109,950. Gross earnings of the railway department in this period were \$105,561, expenses were \$57,822 and net earnings were \$47,739.

**Syracuse (N. Y.) Rapid Transit Company.**—Gross earnings in the quarter ended December 31, 1907, were \$326,478 as compared with \$293,573 in the corresponding quarter of the previous year. Expenses were \$241,875 as compared with \$181,976. Net earnings were \$84,603 as compared with \$111,597. The final surplus after provision for fixed charges was \$1,762 in the 1907 quarter as compared with \$22,191 in the 1906 quarter.

**Utica & Mohawk Valley Railway, Utica, N. Y.**—Gross earnings in the quarter ended December 31, 1907, were \$272,418 as compared with \$257,527 in the corresponding quarter of the previous year. Expenses were \$159,500 as compared with \$159,731. Net earnings were \$112,918 as compared with \$97,796. The final surplus after the payment of fixed charges was \$65,200 in the 1907 quarter and \$49,732 in the 1906 quarter.

**Westchester Traction Company, Ossining, N. Y.**—Edward G. Benedict was appointed receiver for this company on March 13 by Judge Ward of the United States circuit court, New York, following proceedings instituted by the Industrial Construction Company of Delaware, to recover \$32,059 advanced to the traction company. The company admitted its indebtedness and its inability to pay the amount at present. The company formerly operated an electric railway in Ossining, but its franchise was declared void last year.

**ELECTRIC RAILWAY EARNINGS.**

Houghton County Street Railway, Houghton, Mich.			
December—	1907.	1906.	
Gross earnings.....	\$19,704.26	\$19,972.88	
Operating expenses and taxes.....	12,204.49	12,326.18	
Net earnings.....	7,535.77	7,646.70	
Interest charges.....	3,980.89	3,955.62	
Balance.....	3,554.88	3,691.08	

Jacksonville (Fla.) Electric Company.			
December—	1907.	1906.	
Gross earnings.....	\$33,242.77	\$31,882.16	
Operating expenses and taxes.....	21,148.85	18,309.17	
Net earnings.....	12,093.92	13,572.99	
Interest charges.....	5,142.36	3,475.00	
Balance.....	6,951.56	10,097.99	
Improvement fund.....	786.67		
Balance.....	6,164.89	10,097.99	

Pensacola (Fla.) Electric Company.			
December—	1907.	1906.	
Gross earnings.....	\$19,585.61	\$16,129.02	
Operating expenses and taxes.....	13,680.41	11,367.45	
Net earnings.....	5,905.20	4,761.57	
Interest charges.....	3,618.54	3,156.66	
Balance.....	2,286.66	1,604.91	

United Railways Company of St. Louis.			
February—	1908.	1907.	
Gross earnings and other income.....	\$775,454	\$764,680	
Expenses, taxes and depreciation.....	519,540	548,479	
Net earnings.....	255,914	216,201	
Charges.....	233,418	231,325	
Net income.....	22,496	\$15,124	

\*Deficit.

Whatcom County Railway & Light Company, Bellingham, Wash.			
December—	1907.	1906.	
Gross earnings.....	\$33,195.33	\$28,903.44	
Operating expenses and taxes.....	19,501.05	17,143.01	
Net earnings.....	13,694.28	11,760.43	
Interest charges.....	6,584.30	6,213.90	
Balance.....	7,109.98	5,546.53	

**Dividends Declared.**

- American Cities Railway & Light Company, New York, preferred, quarterly, 1½ per cent.
- Houghton County Street Railway Company, Houghton, Mich., preferred, 3 per cent.
- Manhattan Elevated Railway, New York, guaranteed, quarterly, 1¼ per cent.
- Ridge Avenue Passenger Railway, Philadelphia, quarterly, 6 per cent.
- St. Joseph (Mo.) Railway Light Heat & Power Company, preferred, quarterly, 10 per cent.
- Seattle (Wash.) Electric Company, preferred, 3 per cent.
- Union Traction Company of Indiana, Anderson, Ind., preferred, 2½ per cent.
- West End Street Railway, Boston, common, ¾ per cent.
- Winnipeg Electric Railway, quarterly, 2½ per cent.

# Manufactures and Supplies

## ROLLING STOCK.

**Chicago Lake Shore & South Bend Railway**, South Bend, Ind., is asking prices on four double-truck cars.

**New York City Railway** is asking prices on 150 new cars of its standard type and 100 pay-as-you-enter cars.

**Ardmore Traction Company**, Ardmore, Okla., has ordered four double-truck interurban cars and two open cars from the McGuire-Cummings Manufacturing Company.

**Illinois Traction System**, Champaign, Ill., which was reported in the Electric Railway Review of March 7 to be asking prices on 60 cars, has placed an order with the Danville Car Company for 22 double-truck passenger cars.

**New Orleans Railway & Light Company**, New Orleans, La., which was reported in the Electric Railway Review of February 29 to be in the market for a number of cars, has placed an order with the McGuire-Cummings Manufacturing Company for 35 single-truck cars. Delivery is to commence in May.

**New York New Haven & Hartford** is in the market for a number of all-steel passenger cars, reported as 12, to weigh approximately 160,000 pounds and to be equipped with multiple-unit control for operation with alternating or direct current. It is reported that the order has been placed, but we are unable to verify this before going to press.

**New Bedford & Onset Street Railway**, Wareham, Mass., has placed an order with J. M. Jones' Sons for one express car, as reported in the Electric Railway Review of February 29. Delivery is to be made in May. The specifications include the following details: Length of body, 30 feet; over vestibule, 38 feet; length over all, 39 feet; width inside, 7 feet 4 inches; over all, 8 feet; height inside, 6 feet 6 inches; from sill to trolley base, 8 feet 9 inches; height track to trolley base, 11 feet 11 inches.

**Chicago Railways Company** on March 19 placed an order with the Pullman Company for 300 pay-as-you-enter type semi-convertible double-truck cars. Delivery is to commence in June. Fifty of the cars may be built of steel, but this has not yet been definitely decided. No orders for the special equipment have yet been placed. Included in the specifications are the following details:

Seating capacity .....	Length of body.....	32 ft. 5 in.
.....40 passengers	Of platform.....	8 ft. 4½ in.
Weight .....	Over all .....	49 ft. 2 in.
.....52,000 lb.	Width over all .....	8 ft. 6 in.
Wheel base .....	.....	11 ft. 8 in.
Height track to trolley base	Underframe .....	Composite

## SHOPS AND BUILDINGS.

**West Chester & Wilmington Electric Railway**.—It is stated that this company will build a steel frame car barn with corrugated iron roof and sides. Thomas E. O'Connell, president, Wilmington, Del.

## TRADE NOTES.

**Westinghouse Air Brake Company** has declared a quarterly dividend of 2½ per cent, payable April 10.

**Frank F. Fowle** announces the opening of an office in the Marquette building, Chicago, as a consulting electrical and telephone engineer.

**Henry Tripp**, who has been connected with the St. Louis office of the Westinghouse Machine Company, has joined the sales department of the Green Engineering Company of Chicago.

**C. S. Hawley** of the Consolidated Car-Heating Company at a recent meeting of the executive committee of the American Street and Interurban Railway Manufacturers' Association, was appointed chairman of the finance committee for the next annual convention.

**Ridgeway Dynamo & Engine Company**, Ridgeway, Pa., announces that it has opened a district sales office at 907 Andrews building, Cincinnati, O. George W. Euker, who has had extensive experience in electrical and power plant work, is in charge as manager.

**Maryland Railway Supply Company** of Baltimore City, the organization of which was reported in the Electric Railway Review of January 25, has changed its name to the Maryland Railway & Electric Supply Company. Several changes in the

official personnel have also been made. Charles Elliott is now president and general manager, Nelson Perin, vice-president and Thomas D. Claiborne, secretary and treasurer. The general offices of the company will be retained at 510 Continental building, Baltimore.

**Harold A. Clark**, president of the Central Inspection Bureau, 17 State street, New York, died on March 7 at Phoenix, Ariz., of tuberculosis, and was buried in Detroit on March 16. He was also auditor and domestic sales agent of the Middletown Car Works.

**Nathan Manufacturing Company**, New York, has appointed Clifford Nathan general western manager. Mr. Nathan will make his headquarters at the Chicago office in the Old Colony building and will have charge of the Nathan Manufacturing Company's business in the west.

**Canadian Crocker-Wheeler Company**, Limited, has been incorporated with an authorized capital of \$250,000 to manufacture metals and do a general foundry and machine business. The headquarters of this new branch of the Crocker-Wheeler Company of Amperé, N. J., are at Montreal, Que.

**George R. Carr**, vice-president of the Dearborn Drug & Chemical Works, Chicago, is on a combination business and pleasure trip to the City of Mexico. John W. Brashears, who for many years has been first assistant to W. A. Converse, chemical director of the company in charge of the analytical laboratories, has been appointed assistant superintendent of the manufacturing department.

**Archbold-Brady Company**, Syracuse, N. Y., has closed a contract with the Niagara Lockport & Ontario Power Company for four special crossings for the tension power lines over the tracks of the New York Central, and one for the Syracuse & South Bay Electric Railway. Hewlett strain insulators will be used, requiring five 10½-inch tube discs and three 6½-inch discs. The structures will be provided with a special device so that in case of a wire breaking it will be grounded and not left alive.

**Toch Brothers**, manufacturers and specialists in technical paints, colors, varnishes and raw materials, 320 Fifth avenue, New York, have the contract for painting the Metropolitan Life Insurance tower, which is now under construction in that city. This tower is being protected against chemical and electrolytic corrosion by means of two coats of paint, the priming coat being their Tockolith brand and the finishing coat their No. 110 R. I. W., which is waterproof. The company states that the application of these two coats of paint will do the work more effectually than the usual three coats applied to work of this character.

**Chester Railway Supply Company** of Chester, Pa., has been incorporated for \$50,000 to manufacture and sell the Dyer improved trolley ear and other railway and electric supplies. The officers are: Elwood Tyson, president; William A. Dyer, secretary and treasurer; and H. G. Dyer, manager. The Dyer ear, as its name indicates, is a mechanical trolley ear of improved design, some of which have been in service for two years on the lines of the Chester Traction Company, with very satisfactory results. The ear is indorsed by officials of that company, is in use on other lines and is having a gratifying sale within the short time it has been on the market.

**Expanded Metal & Corrugated Bar Company**, St. Louis, reports that among the larger orders recently received are the following: Philippine government at Manila, 500 tons of corrugated bars for use on the island, purchased through Paul S. Carter, purchasing agent, New York; Hiram Lloyd Contracting & Building Company, contractor for the new high school at St. Louis, 500 tons corrugated bars; William A. Engeman, contractor for reinforced concrete retaining wall to be built at St. George Ferry Landing, Staten Island, N. Y., as part of plan for municipal improvements of Borough of Richmond, 600 tons corrugated bars.

**Western Electric Company**, Chicago, has issued its report for the year ended November 30, 1907. On December 1, 1906, the indebtedness of the company was \$27,082,552, including a contingent liability of \$4,201,189 for bills receivable discounted. The financial condition of the company, in the early part of the year, made curtailment of expenses necessary, so that the indebtedness could be materially decreased. The success of the efforts to meet the situation is shown by the fact that the indebtedness was decreased during the year \$9,380,759, which, with an increase in cash of \$1,147,425, makes an improved condition to the extent of \$10,528,184. The sales were \$52,724,168, as compared with \$69,245,332 in the previous year, a decrease of 23.9 per cent. The amount charged off for depreciation, according to the usual practice, is more than three times the average amount of the previous three years, and exceeds that average by more than the

amount of the dividends. The total deductions from inventory costs of merchandise at the close of 1907 were about \$2,000,000. From year to year, as the volume of the company's business has increased, decreasing shop costs have resulted and the practice has been followed of reducing prices to customers as lower costs have been attained. The large volume of business and the resultant lower shop costs in 1906 seemed to justify certain reductions in prices to customers. As a result certain important articles of the company's manufacture sold for lower prices in 1907, although costing more than in 1906. This accounts for a reduction of \$335,000 in the profits for the year. At the end of the fiscal year 1906 the capital and surplus as reported were, in round figures: Capital, \$15,000,000; surplus, \$20,102,000; total capital and surplus on December 1, 1906, \$35,102,000. If an adequate reserve for the decrease in value of the merchandise and for expenses incurred in 1907, but really applicable to the business of 1906, could have been foreseen and provided, the accounts for 1907 would have shown earnings sufficient for a dividend and a small addition to the surplus. The capital and surplus as reported on December 1, 1906, aggregated \$35,102,000. If the depreciation on merchandise carried over from the abnormal year 1906 is figured at \$934,000 and the expenses applicable to sales of 1906, incurred in 1907, at \$395,000, making a total of \$1,338,000, this would leave a capital and surplus of \$33,764,000. The net earnings on 1907 sales were \$1,217,000, and the dividends paid in 1907 amounted to \$1,200,000, leaving \$17,000 as addition to surplus from 1907 earnings, and making total of \$33,781,000. The condensed statement of assets and liabilities December 1, 1907, is as follows:

	December 1, 1907.	Increase since December 1, 1906.
<b>Assets—</b>		
Plants (51.9 per cent of cost).....	\$11,817,905	\$ 541,726
Merchandise .....	15,998,805	*6,184,111
Sundry investments .....	2,640,725	96,569
Cash .....	2,773,609	1,147,425
Bills and accounts receivable.....	18,252,060	*6,303,014
<b>Grand total .....</b>	<b>\$51,483,104</b>	<b>*\$10,701,405</b>
<b>Liabilities—</b>		
Capital stock issued .....	\$15,000,000	
Surplus .....	18,781,311	*\$ 1,320,646
<b>Total capital and surplus.....</b>	<b>\$33,781,311</b>	<b>*\$ 1,320,646</b>
<b>Mortgages and bonds payable.....</b>	<b>\$ 1,328,087</b>	<b>*\$ 198,355</b>
Pension fund .....	576,661	17,983
Bills payable .....	9,337,168	*6,427,724
Accounts payable .....	2,111,449	*2,919,502
Bills receivable discounted.....	4,348,028	146,839
<b>Total payables .....</b>	<b>\$17,701,793</b>	<b>*\$ 9,380,759</b>
<b>Grand total .....</b>	<b>\$51,483,104</b>	<b>*\$10,701,405</b>

\*Decrease.

**United Gas Machinery Company**, incorporated under the laws of the state of New York with offices in the Engineering building, 114-118 Liberty street, New York City, has taken over the business formerly conducted by Thomas F. Fitzsimmons at 100 Broadway, and will manufacture a complete line of gas generators for making producer gas for gas engines and heating and water gas for high temperature furnaces, forges, annealing, etc. These generators gassify either bituminous or anthracite coal, and are simple, most efficient and economical in their operation. One of its soft coal gas producers has recently been installed at the S. S. White Dental Company's works at Staten Island. Thomas F. Fitzsimmons remains with the company as its president and general manager and his long experience in the application of producer gas to gas engines and water gas to furnaces insure to the purchaser the best possible results.

#### ADVERTISING LITERATURE.

**Buckeye Engine Company, Salem, O.**—A clever 4-page note in imitation hand-writing serves to call attention to the Buckeye electric blue printing machine.

**Green Fuel Economizer Company, Matteawan, N. Y.**—"Mechanical Draft" is the subject of Bulletin No. 108, recently published. A number of installations are described and illustrated.

**Hart Steel Company, Elyria, O.**—This company's 1908 catalogue of tie plates and spikes is an unusually handsome book of 48 pages and cover. The latter is embossed and decorated in green and gold. A number of fine half-tones illustrate different types of tie plates, while many pages are devoted

to diagrams showing standard tie plates of various railways. A special envelope with a label of unique design is used for mailing.

**American Casting Company, Birmingham, Ala.**—A leaflet entitled, "Dollars and Sense," conveys reasons why the short-length lightweight cast-iron culvert pipe made by this company should be specified for railway use.

**Western Electric Company, Chicago, Ill.**—Bulletin No. 5910-2 devotes 20 pages to descriptions and illustrations of power equipment for boot and shoe factories.—Bulletin No. 5910-3 describes power equipment for cement mills and illustrates a number of installations.

**General Electric Company, Schenectady, N. Y.**—"G-I" flame arc lamps are described in a recently issued leaflet.—Bulletin No. 4561 is an interesting 16-page pamphlet on illumination. It contains a large number of illustrations of the "GLM" lamps and of fixtures especially suited for their installation.

#### PRESENT STEAM TURBINE DEVELOPMENT.

That the steam turbine is not losing ground in its rapid introduction into all classes of power service is evidenced by the following table showing the aggregate turbine business of the Westinghouse Machine Company at the beginning of the year, classified according to industries. The table shows a summary of 640,700 kilowatts in 493 machines, distributed among 282 plants.

In addition to this output there were at that time under construction at East Pittsburgh 148 machines. These bring the grand total of the turbine business of this company up to the grand total figure of 864,300 kilowatts, or 1,253,000 brake horsepower, so that the 1,250,000-horsepower mark has been passed in the operations of the Westinghouse Companies alone.

Referring to the accompanying table rapid advancement in turbine installation for steam railroading is noted. Although there are comparatively few railroad electrification plants yet installed, their capacity is large—11,670 kilowatts per plant. An idea of the size to which modern central stations have grown is furnished by the fact that nearly 35 per cent of the total capacity tested is contained in stations of over 10,000 kilowatt capacity.

In this connection some data on the development of the Parsons type turbine for marine work in Europe are of particular interest. Sir William Mathews in his recent presidential address before the British Institute of Civil Engineers, cited the following facts:

"In the middle of the present year (1907) there were in service 61 steamships fitted with Parsons turbines and 65 vessels under construction to be furnished with them. The total horsepower of these ships approached 1,400,000. Of this about 42 per cent was in merchant vessels and yachts and 58 per cent in warships. In new ships of the Royal navy reciprocating engines have given place to turbines."

#### Summary of Westinghouse Turbines Shipped or on Order to December 31, 1907.

	Plants.	Av. Cap. of turbines in kw.	Total capacity in kw.
<b>Electric Traction—</b>			
Electric railways .....	69	1,975	282,600
*(Railroad electrification) .....	4	3,250	46,900
<b>Total .....</b>	<b>73</b>	<b>.....</b>	<b>329,500</b>
<b>Electric Lighting—</b>			
Central stations .....	73	1,440	180,100
Isolated plants .....	7	400	3,200
Municipal plants .....	11	570	8,700
<b>Total .....</b>	<b>91</b>	<b>.....</b>	<b>192,000</b>
<b>Steam Railroads—</b>			
Railroad electrification .....	4	3,350	46,900
*(Railroad car shops).....	17	490	15,700
<b>Total .....</b>	<b>21</b>	<b>.....</b>	<b>62,600</b>
Industrial .....	81	.....	76,300
Mining and irrigation .....	19	686	21,950
United States government.....	4	1,225	12,250
Miscellaneous .....	14	483	8,700
<b>Grand total .....</b>	<b>282</b>	<b>.....</b>	<b>640,700</b>

\*Industries in parentheses are allowed for in grand total.

The business uncompleted December 31, 1907, follows: 60 turbines of 153,550 kilowatts, total, leaving shipped or in operation 433 machines, or 487,150 kilowatts, averaging 1,122 kilowatts.



## The Boilers Will be Out of Service a Much Shorter Time for Washing

thereby requiring very much less labor, to say nothing of the saving in fuel and the increased efficiency of the boilers, if the incrusting solids and other deleterious salts in the water are acted upon by *Dearborn Compounds* and their injurious properties destroyed. Send us gallon sample of your feed water for analysis.

### Dearborn Drug & Chemical Works

ROBT. F. CARR, PRESIDENT

299 BROADWAY, NEW YORK      POSTAL TELEGRAPH BLDG., CHICAGO

Passengers soon become accustomed to the

## Rooke Automatic Fare Collector

and make it a point to have their nickels ready.

They like the plan—all honest conductors like it—and its use puts every nickel collected into the company's treasury.

### Rooke Automatic Register Company

Providence, Rhode Island

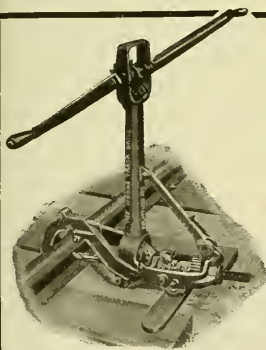
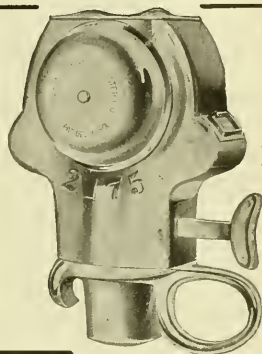

## The Moore Track Drill

does not interfere with traffic!

The shifting of one lever and a few seconds' time takes down the drill—the operation reversed makes it ready for work again.

This is only one of the many strong points about the Moore Track Drill that make it worth buying.

Ask for descriptive catalogue.



**Kalamazoo Railway Supply Co.** Kalamazoo Michigan

Avoid  
Accidents

By Using  
This  
Switch

## Anti-Straddling or Anti-Kicking Tongue Switch

SPECIAL TRACK WORK OF  
EVERY DESCRIPTION

**New York Switch & Crossing Co.**

HOBOKEN, N. J.

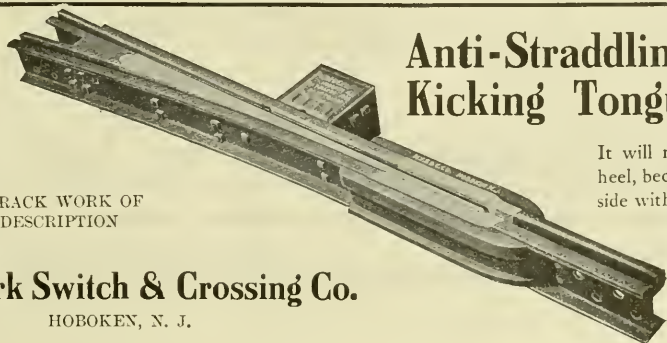

It will not drive down at the heel, because it is held to either side with a spring tension and firmly down on its bed. A car can not straddle this tongue.

WRITE FOR SPECIAL  
CIRCULAR

## THE J. G. BRILL COMPANY, PHILADELPHIA, PA.

AMERICAN CAR COMPANY, ST. LOUIS, MO.  
G. C. KUHLMAN CAR COMPANY, CLEVELAND, OHIO  
JOHN STEPHENSON COMPANY, ELIZABETH, N. J.  
WASON MANUFACTURING CO. SPRINGFIELD, MASS.

MAIN OFFICE: PHILADELPHIA, PA.  
LONDON OFFICE: 110 CANNON ST. E. C.  
PACIFIC COAST AGENTS: PIERSON  
ROEDING & CO., SAN FRANCISCO.  
AUSTRALIAN AGENTS: NOYES  
BROTHERS, SYDNEY. CABLES:  
"BRILL," PHILA., "AXLES" LONDON.

CARS TRUCKS SEATS RATTAN SPRINGS SPECIALTIES SUPPLIES

## SAFE SUMMER SERVICE

The "Narragansett" is the right car for handling crowds safely in excursion service and is the only practical double-truck open car. The width over all is the same as a single-step open car as the upper step is on the flange of a Z-bar sill and within the line of the posts. The best possible arrangement of the running board of a single step car with the minimum height of floor is 19½ inches to board and 17 inches to floor. The same height in the "Narragansett" is divided into 16, 13 and 7½ inches. Companies which have used "Narragansett" cars for a number of years have recently reported that they have had no accidents. Women, children and elderly persons can get in and out easily and quickly. The Z-bar sills make it the strongest open car ever built. The arrangement does not reduce the length of the seats. Write for catalog.

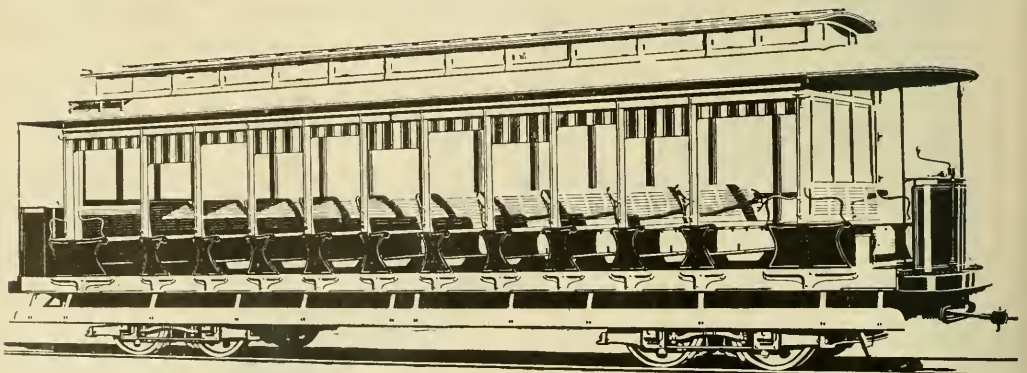

THE BRILL "NARRAGANSETT" CAR (PATENTED)

# General Electric Company



## Sub-Station Equipment

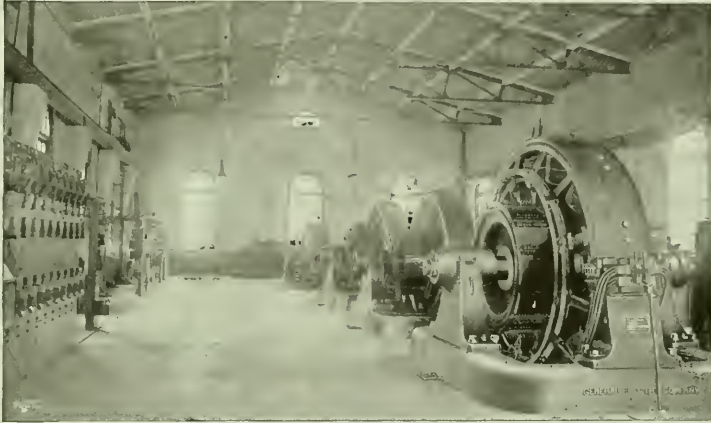

Metropolitan Street Ry. Co., Kansas City, Mo., Cleveland Street Station

The General Electric Company's activity in the development and improvement of sub-station apparatus is shown by the thousands of kilowatt capacity in successful daily operation.

Examples of efficient practical application of high engineering standards are exhibited in sub-stations equipped with GE apparatus, as shown on this page.



International Ry. Co., Buffalo, N. Y.  
Virginia Street Station

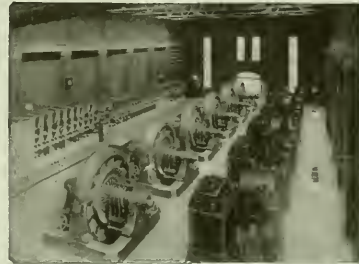

United Railways Co., St. Louis  
Locust Street Station

1567

Chicago Office:  
Monadnock Bldg.

Principal Office:  
Schenectady, N. Y.

Sales Offices in  
all large cities

**When buying steel measuring tapes** for absolutely accurate work it's worth while seeing to it that they were made by



**THE LUFKIN RULE CO.** New York  
London, England  
Windsor, Canada  
SAGINAW, MICH., U. S. A.

The Recording Fare Register Company



New Haven, Conn.

**The Green Fuel Economizer Co.**  
MATTEAWAN, N. Y.

New York, Boston, Chicago, Atlanta, San Francisco, Los Angeles, Seattle, Salt Lake City, Montreal.

Engineers: Builders of Green's Fuel Economizers, Fans, Blowers and Exhausters, Steam Air Heater Coils, Waste Heat Air Heaters, Mechanical Draft, Heating and Ventilating and Drying Apparatus, Draft Dampers and Engines.

WRITE FOR CATALOGS.

**VALVES—FITTINGS—STEAM SPECIALTIES**

**CRANE CO.**  
CHICAGO  
ESTABLISHED 1855

**"Not an Experiment"**

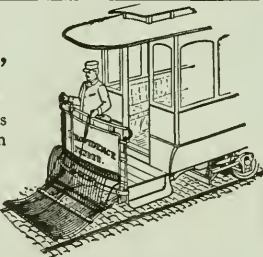

The Providence Fender has been in successful operation on hundreds of roads for 13 years, and has proved itself reliable under all conditions of Street Railway service.

**CONSOLIDATED CAR FENDER COMPANY**  
Office and Factory: PROVIDENCE, R. I.  
Branch Office: 110 E. Twenty-third St., New York  
European Agents: Comptoir d'Electricite, 6, Rue Boudreau, Paris, France

**STEEL WOOL JOURNAL PACKING**

- saves one-half the packing
- saves one-third the oil
- saves labor and wear
- prevents hot boxes **positively**

No other packing you ever heard of can do these things!  
*Send today for free sample*

**WM. ROBERTSON & COMPANY**  
General Office: Great Northern Bldg., CHICAGO  
Factory: 75 S. Jefferson St., BATTLE CREEK, MICH.

**Baltimore Center and Side Bearings**  
FOR ELECTRIC TRUCKS

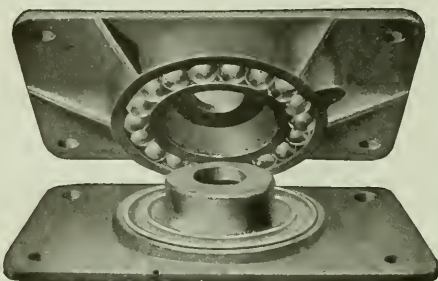

**Impossible to Clog Balls**      **No Lubrication Necessary**

**SAVES:** { FLANGE WEAR  
RAIL WEAR  
TRUCK REPAIRS

**DURABILITY:** { PROVEN UNDER HEAVIEST LOADS

BALTIMORE MD. **THE T. H. SYMINGTON CO.** CHICAGO ILL.

# Electric Railway Review

PUBLISHED EVERY SATURDAY.

FORMERLY THE STREET RAILWAY REVIEW.

THE WILSON COMPANY, CHICAGO

160 Harrison Street, Chicago  
150 Nassau Street, New York  
1529 Williamson Bldg., Cleveland

VOL. XIX  
No. 13

CHICAGO, MARCH 28, 1908

Whole No.  
257

Subscription: Domestic . . . \$2  
Foreign . . . \$5  
Canada . . . \$3.50

“All things come to him  
who hustles while  
he waits!”

A present-day application of this truth is that the man who hustles for business now while waiting for business conditions to improve will have business come to him later on.

And remember that a mighty important part of hustling for business is advertising—*real* advertising—which means telling prospective customers the facts back of your goods so attractively, so sensibly, so persistently that when brisk buying time comes you and your goods will be remembered.

The right medium for this advertising is the best edited, illustrated and printed publication in its field—

## Electric Railway Review

—because it is *read* (not merely glanced at) by a large and constantly increasing number of the men who buy and the men who influence buying for America's electric railways



# Westinghouse

## Trolley Line Material

Send for  
Special  
Publications 7059 and 7060

They contain full details and illustrations of a complete line of Westinghouse Catenary and Low Voltage Trolley Line Material for both alternating and direct current traction service.

Address nearest office

### Westinghouse Electric & Mfg. Co.

Atlanta  
Baltimore  
Boston

Buffalo  
Chicago  
Cincinnati

Cleveland  
Dallas  
Denver

Detroit  
Kansas City  
Los Angeles  
Minneapolis

New Orleans  
New York  
Philadelphia

Pittsburg  
St. Louis  
Salt Lake City

San Francisco  
Seattle  
Syracuse

Canada: Canadian Westinghouse Co., Ltd., Hamilton, Ontario Mexico: G. & O. Braniff & Co., City of Mexico

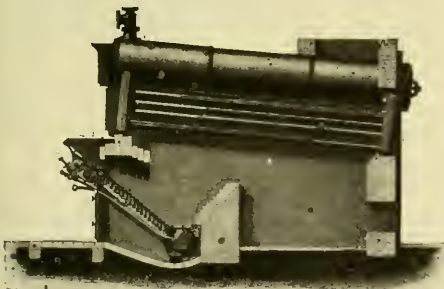

Where Roney Stokers are used the operation is based on knowledge, not on guesswork.

### Roney Stokers

allow the entire bed of the fire to be seen from the underside of the grate, so that clinkers can be seen as they form, and dislodged without opening doors. If the fire is burning unevenly it can be instantly detected and the condition corrected.

Write for Roney Stoker Catalogues.

The Westinghouse Machine Co.

Pittsburg, Pa.

## The Maximum Speed

at which cars may be called upon to operate must always be considered when equipping them with air brakes. Cars which are at times required to maintain a speed of sixty miles an hour or more, must have brakes capable of stopping them within the minimum distance, from such speeds. The higher the speed, the more essential the most efficient brake.

### The Westinghouse "A M M" Automatic Air Brake

meets every condition of high-speed service. It is designed for one to five car trains and gives graduated release, quick recharge, quick service and high pressure in emergency; features found in no other make of brakes. It combines great power and great flexibility, two essential elements of opposite character in braking.

Westinghouse Traction Brake Co.

Pittsburg, Pa.







We carry in stock a complete line of standard Trolley Overhead Material, insulated with the well known

**ELECTROSE INSULATION**

Send us a list of your requirements and we will send you our catalogue and prices.

WRITE TODAY.



**of J-M Giant Strain Insulators**

is the insulation—because all strains act directly on Sheet Mica Discs—which are unbreakable. The entire outer surface, from eye to eye, is Moulded Mica—the most durable moulded insulation known.

The superiority of these Insulators is shown by their general adoption by all of the larger electric railway and lighting interests, where under actual test and service conditions their superior tensile strength and insulating properties have been demonstrated.

*Write nearest Branch for booklet*

**H. W. JOHNS-MANVILLE CO.**



New York  
Milwaukee  
Chicago  
Boston  
Philadelphia  
St. Louis

Pittsburg  
Cleveland  
Buffalo  
Baltimore  
New Orleans  
Kansas City

Minneapolis  
San Francisco  
Los Angeles  
Seattle  
Dallas  
London 763

**THE SYMINGTON JOURNAL BOX IS NOW STANDARD**

ON 95 PER CENT OF ALL MODERN ELECTRIC TRUCKS

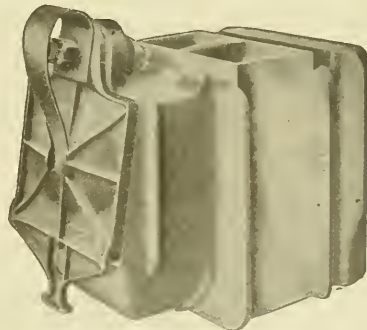
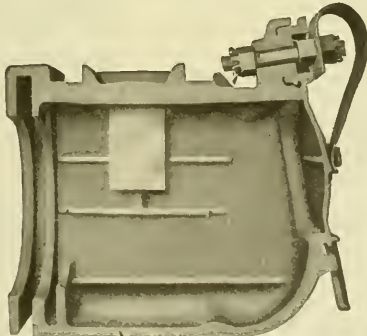

**Special Notice!**

WE ARE PREPARED TO FURNISH AT ONCE **REPAIR BOXES**

FOR ANY MAKE OF TRUCK IN SERVICE

BALTIMORE MD.

**THE T. H. SYMINGTON CO.**

CHICAGO ILL.

## CLASSIFIED LIST OF ADVERTISERS—Continued.

- Brake Shoes—Continued.**  
Marshall, R. W. & Co., 95 Liberty St., New York.  
St. Louis Car Co., St. Louis, Mo.  
Standard Brake Shoe Co., Aurora, Ill.  
Stephenson, John, Co., Elizabeth, N. J.  
Wason Mfg. Co., Springfield, Mass.  
Wharton, Wm., Jr., & Co., Philadelphia.  
Wheel Truing Brake Shoe Co., Detroit.
- Bridges.**  
Johann, F. A., 1624 Pierce Bldg., St. Louis.
- Bridge Timbers.**  
Beidler, Francis, & Co., Chgo.
- Brushes, Motor and Dynamo.**  
Electric Service Supplies Co., 200 Plymouth Bldg., Chicago.  
General Electric Co., Schenectady, N. Y.  
Ridlon, Frank, Co., 200 Summer St., Boston.  
Speer Carbon Co., St. Marys, Pa.
- Bumpers, Car.**  
American Car Co., St. Louis.  
Brill, The J. G., Co., Philadelphia.  
Kuhlman, The G. C., Car Co., Cleveland.  
St. Louis Car Co., St. Louis, Mo.  
Stephenson, John, Co., Elizabeth, N. J.  
Wason Mfg. Co., Springfield, Mass.
- Car House Doors.**  
Wilson, J. G., Mfg. Co., New York.
- Car Replacers.**  
Electric Service Supplies Co., 200 Plymouth Bldg., Chicago.  
Fairbanks, Morse & Co., Chgo.  
Kalamazoo Railway Supply Co., Kalamazoo, Mich.  
Ohio Brass Co., Mansfield, O.  
U. S. Metal & Mfg. Co., 25 Broad St., New York.
- Car Roof Paint, Canvas.**  
St. Louis Surfacor & Paint Co., St. Louis, Mo.
- Car Seats.**  
American Car Co., St. Louis.  
Brill, The J. G., Co., Philadelphia.  
Hale & Kibburn Mfg. Co., Philadelphia.  
Heywood Bros. & Wakefield Co., Wakefield, Mass.  
Kuhlman, The G. C., Car Co., Cleveland.  
St. Louis Car Co., St. Louis, Mo.  
Stephenson, John, Co., Elizabeth, N. J.  
Wason Mfg. Co., Springfield, Mass.
- Car Signs—(See Signs, Cars and Track).**
- Car Steps.**  
Electric Service Supplies Co., 200 Plymouth Bldg., Chicago.
- Car Trimmings, Car.**—(See Trimmings, Car).
- Cars, Ballast.**  
Rodger Ballast Car Co., Chgo.  
St. Louis Car Co., St. Louis, Mo.
- Cars, Dump.**  
Fairbanks, Morse & Co., Chgo.  
Rodger Ballast Car Co., Chgo.  
Russell Car & Snow-Plow Co., Ridgway, Pa.  
St. Louis Car Co., St. Louis, Mo.
- Cars, Passenger and Freight—Continued.**  
American Car Co., St. Louis.  
Brill, The J. G., Co., Philadelphia.  
Cincinnati Car Co., Cincinnati.  
Detroit Carbuilding & Equipment Co., Detroit, Mich.  
Electric Railway Improvement Co., Cleveland, O.  
Fairbanks, Morse & Co., Chgo.  
Jewett Car Co., Newark, O.  
Johann, F. A., 1624 Pierce Bldg., St. Louis.  
Kuhlman, The G. C., Car Co., Cleveland.  
McGuire-Cummings Mfg. Co., Chicago.  
Niles Car & Mfg. Co., Niles, O.
- Cars, Passenger and Freight—Continued.**  
Pressed Steel Car Co., Pittsburgh.  
Rodger Ballast Car Co., Chgo.  
Russell Car & Snow-Plow Co., Ridgway, Pa.  
St. Louis Car Co., St. Louis, Mo.  
Standard Motor Truck Co., Pittsburg.  
Stephenson, John, Co., Elizabeth, N. J.  
Wason Mfg. Co., Springfield, Mass.
- Cars, Pay-As-You-Enter.**  
Pay-As-You-Enter Car Co., 26 Cortlandt St., New York.
- Cars, Rebuilt.**  
Detroit Carbuilding & Equipment Co., Detroit, Mich.
- Cars, Second-Hand.**  
Detroit Carbuilding & Equipment Co., Detroit, Mich.  
Marshall, R. W. & Co., 95 Liberty St., New York.  
Zelnicke, Walter A., Supply Co., St. Louis.
- Cars, Steel.**  
Pressed Steel Car Co., Pittsburgh.  
St. Louis Car Co., St. Louis, Mo.  
Standard Motor Truck Co., Pittsburg.
- Castings, Brass.**  
Star Brass Works, Kalamazoo, Mich.
- Castings, Iron and Steel.**  
American Brake Shoe & Foundry Co., Mahwah, N. J.  
Green Engineering Co., Com'l Nat. Bk. Bldg., Chicago.  
National Brake & Electric Co., Milwaukee.  
Washburn Steel Castings & Coupler Co., Minneapolis.
- Catchers—(See Trolley Retrievers and Catchers).**
- Cattle Guards.**  
Fairbanks, Morse & Co., Chgo.
- Circuit-Breakers.**  
Electric Service Supplies Co., 200 Plymouth Bldg., Chicago.  
General Electric Co., Schenectady, N. Y.  
Western Electric Co., Chicago.
- Coal Handling Machinery—(See Conveyors).**
- Colls—(See Armatures and Colls)**  
Cleveland Armature Works, Cleveland.  
Electric Service Supplies Co., 1020-24 Filbert St., Phila.  
General Electric Co., Schenectady, N. Y.  
Marshall, R. W., & Co., 95 Liberty St., New York.  
Ohio Brass Co., Mansfield, O.  
Stuart-Howland Co., Boston.
- Compressors, Air.**  
Fairbanks, Morse & Co., Chgo.  
General Electric Co., Schenectady, N. Y.  
National Brake & Electric Co., Milwaukee.  
Westinghouse Traction Brake Co., Pittsburg.
- Concrete Mixers.**  
Contractors' Supply & Equip. Co., Chicago.
- Condensers.**  
Wheeler Condenser & Engineering Co., Carteret, N. J.
- Conduits.**  
Electric Service Supplies Co., 200 Plymouth Bldg., Chicago.  
Western Electric Co., Chicago.
- Connectors, Solderless.**  
Dossert & Co., 242 W. Forty-first St., New York.
- Contractors.**  
Arnold Company, 131 La Salle St., Chicago.  
Bylesby, H. M., Co., Am. Trust Bldg., Chicago.  
Columbia Construction Co., Milwaukee, Wis.  
Craghead Engineering Co., Cincinnati, O.
- Contractors—Continued.**  
Green Engineering Co., Com'l Nat. Bk. Bldg., Chicago.  
Register, R. W. & Co., 112 N. Broad St., Philadelphia.  
Sanderson & Porter, 52 William St., New York.  
Saxton, E., 341 Bladensburg E., Washington, D. C.  
Sheaff & Jaastad, 88 Broad St., Boston.  
Stone & Webster Engineering Co., Boston.  
Wharton, Wm., Jr., & Co., Philadelphia.  
White, J. G., & Co., 49 Exchange Pl., New York.
- Controllers and Attachments.**  
Electric Service Supplies Co., 200 Plymouth Bldg., Chicago.  
General Electric Co., Schenectady, N. Y.  
Johns-Manville, H. W., Co., New York.  
Marshall, R. W. & Co., 95 Liberty St., New York.  
Western Electric Co., Chicago.  
Westinghouse Electric & Mfg. Co., Pittsburg.
- Conveyors and Coal Handling Machinery.**  
Green Engineering Co., Com'l Nat. Bk. Bldg., Chicago.  
Northern Engineering Works, Detroit, Mich.
- Cord, Bell and Trolley.**  
American Car Co., St. Louis.  
Brill, The J. G., Co., Philadelphia.  
Electric Service Supplies Co., 1020-24 Filbert St., Phila.  
Kuhlman, The G. C., Car Co., Cleveland.  
St. Louis Car Co., St. Louis, Mo.  
Stephenson, John, Co., Elizabeth, N. J.  
Stuart-Howland Co., Boston.  
Wason Mfg. Co., Springfield, Mass.
- Couplers, Car.**  
American Car Co., St. Louis.  
Brill, The J. G., Co., Philadelphia.  
Kuhlman, The G. C., Car Co., Cleveland.  
McGuire-Cummings Mfg. Co., Chicago.  
Ohio Brass Co., Mansfield, O.  
St. Louis Car Co., St. Louis, Mo.  
Stephenson, John, Co., Elizabeth, N. J.  
Van Dorn, W. T., Co., Paulina St., Chicago.  
Washburn Steel Castings & Coupler Co., Minneapolis.  
Wason Mfg. Co., Springfield, Mass.
- Coverings, Pipe and Boiler.**  
Johns-Manville, H. W., Co., New York.
- Cranes, Hoists and Lifts.**  
American Car Co., St. Louis.  
Brill, The J. G., Co., Philadelphia.  
Brown Holsting Machinery Co., Cleveland, O.  
Kuhlman, The G. C., Car Co., Cleveland.  
Northern Engineering Works, Detroit, Mich.  
Railway Specialty & Supply Co., Chicago.  
Stephenson, John, Co., Elizabeth, N. J.  
Van Dorn & Dutton Co., Cleveland, O.  
Wason Mfg. Co., Springfield, Mass.
- Cross Arms—(See Brackets and Cross Arms).**
- Crossing Gates—(See Gates and Guards).**
- Crossings, Track—(See Switches).**
- Curtains, Fixtures and Materials—Continued.**  
Pantano Co., 11 Broadway, New York.  
St. Louis Car Co., St. Louis, Mo.  
Stephenson, John, Co., Elizabeth, N. J.  
Wason Mfg. Co., Springfield, Mass.
- Cylinder Oil.**  
Power Specialty Co., 111 Broadway, N. Y.
- Derailing Devices.**  
American Frog & Switch Co., Hamilton, O.  
Cleveland Frog & Crossing Co., Cleveland, O.
- Detective Agency.**  
Drummond Detectives Agency, New York.
- Doors and Fixtures.**  
American Car Co., St. Louis.  
Brill, The J. G., Co., Philadelphia.  
Kuhlman, The G. C., Car Co., Cleveland.  
St. Louis Car Co., St. Louis, Mo.  
Stephenson, John, Co., Elizabeth, N. J.  
Wason Mfg. Co., Springfield, Mass.
- Doors, Steel Rolling.**  
Wilson, J. G., Mfg. Co., New York.
- Draft, Mechanical—(See Mechanical Draft).**
- Draft Rigging.**  
Van Dorn, W. T., Co., Chgo.  
Washburn Steel Castings & Coupler Co., Minneapolis.
- Drills, Track.**  
Brown, H. P., 120 Liberty St., New York.  
Electric Service Supplies Co., 200 Plymouth Bldg., Chicago.  
Fairbanks, Morse & Co., Chgo.  
Kalamazoo Railway Supply Co., Kalamazoo, Mich.  
Marshall, R. W., & Co., 95 Liberty St., New York.  
Ridlon, Frank, Co., 200 Summer St., Boston.
- Drying Appliances.**  
Green Fuel Economizer Co., Matteawan, N. Y.
- Dynamics and Generators.**  
Cleveland Armature Works, Cleveland, O.  
Fairbanks, Morse & Co., Chgo.  
General Electric Co., Schenectady, N. Y.  
National Brake & Electric Co., Milwaukee, Wis.  
Western Electric Co., Chicago.  
Westinghouse Electric & Mfg. Co., Pittsburg, Pa.
- Economizers, Fuel.**  
Green Fuel Economizer Co., Matteawan, N. Y.
- Electrical Instruments.**  
Electric Service Supplies Co., 200 Plymouth Bldg., Chicago.  
General Electric Co., Schenectady, N. Y.  
Johns-Manville, H. W., Co., New York.  
Queen & Co., Philadelphia.  
Western Electric Co., Chicago.  
Westinghouse Electric & Mfg. Co., Pittsburg, Pa.  
Weston Electrical Instrument Co., Newark, N. J.
- Electric Railway Supplies, General.**  
Cleveland Armature Works, Cleveland, O.  
Craghead Engineering Co., Cincinnati, O.  
Electric Service Supplies Co., 200 Plymouth Bldg., Chicago.  
Fairbanks, Morse & Co., Chgo.  
General Electric Co., Schenectady, N. Y.  
Johns-Manville, H. W., Co., New York.  
Marshall, R. W., & Co., 95 Liberty St., New York.  
Ohio Brass Co., Mansfield, O.  
Stuart-Howland Co., Boston.  
Western Electric Co., Chicago.

# ST. LOUIS CAR CO. ST. LOUIS-MO.

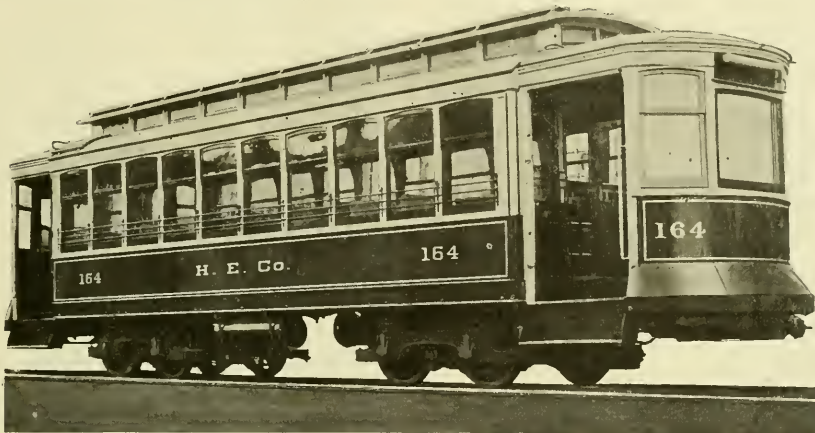

## St. Louis Car Company's Semi-Convertible Type

The illustration represents one of the cars recently shipped by us to the Houston Electric Company, Houston, Texas.

These cars are of our own design—a practically perfect Semi-Convertible type. Both lower and upper sashes raise into the roof. They move easily and when in the roof pockets are securely fastened, with no possible danger of falling and injuring passengers.

### Our construction of the Semi-Convertible Car is the very best that has yet been devised

These Houston cars are 28' over corner posts and 31' 6" over all. Width over arm rail, 8' 6". They are finished with very handsomely figured mahogany, provided with curtains at each window and each door opening and have the St. Louis Car Company's latest improved "Walkover" seat.

The cars are mounted on St. Louis Car Company's No. 47 Short Wheel Base Truck, which has been adopted as standard in a great many of the larger cities. The channel-iron and steel construction of the "Robertson type" permits the arm rail of the car to be placed very low and adds much to the appearance.

*Photographs, Blue Prints and Specifications will be mailed upon request.*

## CLASSIFIED LIST OF ADVERTISERS—Continued.

- Enamels.**  
Acme White Lead & Color Works, Detroit, Mich.  
St. Louis Surfer & Paint Co., St. Louis, Mo.
- Engine Apparatus.**  
Green Fuel Economizer Co., Matteawan, N. Y.
- Engineers and Contractors.**  
Arnold Company, Chicago.  
Ebley, H. M., & Co., Chgo. Columbia Construction Co., Milwaukee, Wis.  
Ford, Bacon & Davis, New York.  
Register, A. L., & Co., Philadelphia.  
Sanderson & Porter, New York.  
Saxton, E., Washington, D. C.  
Sheaff & Jaastad, Boston.  
Stone & Webster Eng. Corporation, Boston.  
White, J. G., & Co., New York.
- Engines, Gas and Oil.**  
Buckeye Engine Co., Salem, O.  
Fairbanks, Morse & Co., Chgo.  
Westinghouse Machine Co., Pittsburg.
- Engines, Hoisting.**  
Fairbanks, Morse & Co., Chgo.
- Engines, Steam.**  
Buckeye Engine Co., Salem, O.  
Westinghouse Machine Co., Pittsburg.
- Fans, Exhaust and Ventilating.**  
General Electric Co., Schenectady, N. Y.  
Green Fuel Economizer Co., Matteawan, N. Y.  
Western Electric Co., Chicago.  
Westinghouse Elec. & Mfg. Co., Pittsburg.
- Fare Boxes—(See Electric Railway Supplies).**
- Fare Registers and Register Fittings.**  
Electric Service Supplies Co., 200 Plymouth Bldg., Chicago.  
Rooke Automatic Register Co., Providence, R. I.
- Feedwater Apparatus.**  
Green Fuel Economizer Co., Matteawan, N. Y.  
Wheeler Condenser & Engineering Co., Carteret, N. J.
- Feed Wire—(See Wire and Cables).**
- Fenders and Guards.**  
Consolidated Car Fender Co., Providence, R. I.  
Eclipse Railway Supply Co., Cleveland, O.  
Electric Service Supplies Co., 1020-24 Filbert St., Phila.  
McGuire-Cummings Mfg. Co., Chicago.  
Marshall, R. W., & Co., 95 Liberty St., New York.
- Flangers, Snow.**  
McGuire-Cummings Mfg. Co., Chicago.  
Ohio Brass Co., Mansfield, O.  
Kalamazoo Railway Supply Co., Kalamazoo, Mich.  
Van Dorn & Dutton Co., Cleveland, O.
- Frogs—(See Switches, Frogs and Crossings).**
- Fuel Economizers—(See Economizers, Fuel).**
- Fuses and Fuse Devices.**  
Chase-Shawmut Co., Newburyport, Mass.  
Electric Service Supplies Co., 200 Plymouth Bldg., Chicago.  
General Electric Co., Schenectady, N. Y.  
Johns-Manville, H. W., Co., New York.  
Western Electric Co., Chicago.  
Westinghouse Elec. & Manufacturing Co., Pittsburg.
- Gaskets, Bronze.**  
Power Specialty Co., 111 Broadway, New York.
- Gates and Guards.**  
Kalamazoo Railway Supply Co., Kalamazoo, Mich.
- Gear Cases.**  
Electric Service Supplies Co., 200 Plymouth Bldg., Chicago.  
General Electric Co., Schenectady, N. Y.  
Marshall, R. W., & Co., 95 Liberty St., New York.
- Gears and Pinions.**  
Electric Service Supplies Co., 200 Plymouth Bldg., Chicago.  
General Electric Co., Schenectady, N. Y.  
Marshall, R. W., & Co., 95 Liberty St., New York.  
Nuttall, R. D., Co., Pittsburg.  
Van Dorn & Dutton Co., Cleveland, O.
- Generators—(See Dynamos).**
- Gongs—(See Bells and Gongs).**
- Graphite Paint—(See Paint).**
- Grates, Chaln.**  
Green Engineering Co., Com'l Nat. Bk. Bldg., Chicago.
- Grease—(See Lubricants).**
- Grinders.**  
Brown, Harold P., 120 Liberty St., New York.
- Ground Connection Clamps.**  
Chase-Shawmut Co., Newburyport, Mass.
- Guy Anchors—(See Anchors).**
- Harps, Trolley—(See Trolley Poles and Fittings).**
- Headlights.**  
Electric Service Supplies Co., 200 Plymouth Bldg., Chicago.  
Fairbanks, Morse & Co., Chgo.  
General Electric Co., Schenectady, N. Y.  
Ridlon, Frank Co., 200 Summer St., Boston.  
St. Louis Car Co., St. Louis, Mo.  
Stuart-Howland Co., Boston.  
Trolley Supply Co., Canton, O.
- Heaters, Car, Electric.**  
Consolidated Car-Heating Co., Albany, N. Y.  
Johns-Manville, H. W., Co., New York.
- Heaters, Car, Hot Water, and Stoves.**  
Baker, The Wm. C., Heating & Sup. Co., New York.  
Electric Service Supplies Co., 1020-24 Filbert St., Phila.  
McGuire-Cummings Mfg. Co., Chicago.  
Smith, Peter, Heater Co., Detroit, Mich.
- Heating and Ventilating Apparatus—(See Mech. Draft).**
- Hoists—(See Cranes, Hoists and Lifts).**
- Hose Bridges.**  
Ohio Brass Co., Mansfield, O.
- Hydraulic Machinery.**  
Watson-Stillman Co., 26 Cortlandt St., New York.
- Inspection.**  
Central Inspection Bureau.
- Inspection Cars, Gasoline.**  
Stover Motor Car Co., Freeport, Ill.
- Instruments, Measuring and Testing—(See Electrical Instruments).**
- Insulating Tapes.**  
General Electric Co., Schenectady, N. Y.  
Johns-Manville, H. W., Co., New York, N. Y.  
Okonite Co., Ltd., 253 Broadway, New York.  
Western Electric Co., Chicago.
- Insulations and Insulating Materials.**  
Anderson, A. & J. M., Mfg. Co., Boston.  
Creaghead Engineering Co., Cincinnati, O.  
Electric Railway Equipment Co., Cincinnati, O.  
Electric Service Supplies Co., 200 Plymouth Bldg., Chicago.  
General Electric Co., Schenectady, N. Y.  
Johns-Manville, H. W., Co., New York.  
Macallen, The Co., Boston.  
Ohio Brass Co., Mansfield, O.  
Okonite Co., Ltd., 253 Broadway, New York.  
Ridlon, Frank Co., 200 Summer St., Boston.  
Standard Paint Co., 100 William St., New York.  
Stuart-Howland Co., Boston.  
Western Electric Co., Chicago.
- Jacks.**  
American Car Co., St. Louis.  
Brill, The J. G., Co., Philadelphia.  
Electric Service Supplies Co., 200 Plymouth Bldg., Chicago.  
Fairbanks, Morse & Co., Chgo.  
Kalamazoo Railway Supply Co., Kalamazoo, Mich.  
Kuhlman, The G. C., Car Co., Cleveland.  
Marshall, R. W., & Co., 95 Liberty St., New York.  
Morden Frog & Crossing Co., Chicago.  
Stephenson, John, Co., Elizabeth, N. J.  
Wason Mfg. Co., Springfield, Mass.  
Watson-Stillman Co., 26 Cortlandt St., New York.
- Joints, Expansion—(See Steam Fittings).**
- Joints, Rail.**  
Rail Joint Co., 29 W. 34th St., New York.
- Joints, Welded—(See Rail Joints, Welded).**
- Journal Boxes.**  
American Car Co., St. Louis.  
Brill, The J. G., Co., Philadelphia.  
Kuhlman, The G. C., Car Co., Cleveland.  
McGuire-Cummings Mfg. Co., Chicago.  
St. Louis Car Co., St. Louis, Mo.  
Stephenson, John, Co., Elizabeth, N. J.  
Symington, T. H., Co., Baltimore, Md.  
Wason Mfg. Co., Springfield, Mass.
- Journal Lubricators—(See Lubricants).**
- Journal Packing, Steel Wool.**  
Robertson, Wm., & Co., Fifth Floor Great Northern Bldg., Chicago.
- Lamps, Arc and Incandescent.**  
Anderson, A. & J. M., Mfg. Co., Boston.  
Electric Service Supplies Co., 200 Plymouth Bldg., Chicago.  
General Electric Co., Schenectady, N. Y.  
Ridlon, Frank Co., 200 Summer St., Boston.  
Stuart-Howland Co., Boston.  
Western Electric Co., Chicago.  
Westinghouse Electric & Mfg. Co., Pittsburg, Pa.
- Lamp Sockets.**  
Electric Service Supplies Co., 200 Plymouth Bldg., Chicago.  
General Electric Co., Schenectady, N. Y.  
Johns-Manville, H. W., Co., New York, N. Y.
- Lantern Globes.**  
Railway Specialty & Supply Co., Chicago.
- Lifting Magnets.**  
Porter Mfg. Co., 29 Griswold St., Detroit, Mich.
- Lifts—(See Cranes, Hoist and Lift).**
- Lightning Arresters.**  
Electric Service Supplies Co., 200 Plymouth Bldg., Chicago.  
General Electric Co., Schenectady, N. Y.  
Stuart-Howland Co., Boston.  
Western Electric Co., Chicago.  
Westinghouse Elec. & Manufacturing Co., Pittsburg.
- Line Material.**  
Anderson, A. & J. M., Mfg. Co., Boston.  
Creaghead Engineering Co., Cincinnati, O.  
Johns-Manville, H. W., Co., New York.  
Electric Ry. Equipment Co., Cincinnati, O.  
Electric Service Supplies Co., 200 Plymouth Bldg., Chicago.  
General Electric Co., Schenectady, N. Y.  
Macallen, The Co., Boston.  
Marshall, R. W., & Co., 95 Liberty St., New York.  
Stuart-Howland Co., Boston.  
Western Electric Co., Chicago.
- Lock and Nut Washers.**  
National Lock Washer Co., Newark, N. J.
- Lockers, Metal.**  
Electric Service Supplies Co., 200 Plymouth Bldg., Chicago.
- Locomotives.**  
Baldwin Locomotive Works, Philadelphia.  
Johann, F. A., 1624 Pierce Bldg., St. Louis.
- Locomotives, Electric.**  
American Car Co., St. Louis.  
Baldwin Locomotive Works, Philadelphia.  
Brill, The J. G., Co., Philadelphia.  
General Electric Co., Schenectady, N. Y.  
Kuhlman, The G. C., Car Co., Cleveland.  
McGuire-Cummings Mfg. Co., Chicago.  
Stephenson, John, Co., Elizabeth, N. J.  
Wason Mfg. Co., Springfield, Mass.  
Westinghouse Elec. & Manufacturing Co., Pittsburg.
- Locomotives, Gasoline.**  
Fairbanks, Morse & Co., Chgo.  
Stover Motor Car Co., Freeport, Ill.
- Lubricants.**  
Dearborn Drug & Chemical Works, Chicago.  
Galena-Signal Oil Co., Franklin, Pa.  
Whitmore Mfg. Co., Cleveland, O.
- Lumber.**  
Barnes, G. H., Hardwood Lumber Co., St. Louis, Mo.  
Beider, Francis, & Co., Chgo.  
Berthold & Jennings, St. Louis.  
Lindsay Bros. Co., Spokane, Wash.  
S-E. Missouri Cypress Co., Campbell, Mo.
- Magnets and Solenoids.**  
Porter Mfg. Co., 29 Griswold St., Detroit, Mich.
- Malleable Iron.**  
St. Louis Car Co., St. Louis, Mo.
- Measuring Tapes.**  
Lufkin Rule Co., Saginaw, Mich.
- Mechanical Draft.**  
Green Fuel Economizer Co., Matteawan, N. Y.
- Meters.**  
Johns-Manville, H. W., Co., New York.  
Queen & Co., Philadelphia.  
Weston Electrical Instrument Co., Newark, N. J.
- Mica, Raw and Manufactured.**  
Chicago Mica Co., Valparaiso, Ind.
- Motor Cars, Gasoline.**  
Stover Motor Car Co., Freeport, Ill.

# Pay-As-You-Enter Cars

are the Only Kind Desired by  
America's Second Largest City

Since Chicago's people have had modern Pay-As-You-Enter Car service (beginning in November, 1907, on the Chicago City Railway) they have formed so favorable an opinion of it that nothing else will satisfy them on important lines.



Chicago's Board of Supervising Engineers (which very largely controls the traction situation) has recognized the public's desire by authorizing the purchase of 300 Pay-As-You-Enter Cars for congested lines of the Chicago Railways Company, operating on the great west and north sides of the city.

The result is that Chicago's people generally feel more friendly toward the traction companies than they ever have before. And the lines equipped with Pay-As-You-Enter Cars are more safely operated, with closer adherence to schedules, and at greater profit.

We license manufacturers and railways to build and use the Pay-As-You-Enter Car, the patents on which are owned by

## The Pay-As-You-Enter Car Company

DUNCAN McDONALD  
President

26 Cortlandt Street, New York

THOS. W. CASEY  
Manager

11

## CLASSIFIED LIST OF ADVERTISERS—Continued.

- Motors, Electric.**  
Cleveland Armature Works, Cleveland, O.  
Fairbanks, Morse & Co., Chgo. General Electric Co., Schenectady, N. Y.  
National Brake & Electric Co., Milwaukee.  
Western Electric Co., Chicago. Westinghouse Elec. & Manufacturing Co., Pittsburg.
- Nut Locks.**  
Chase-Shawmut Co., Newburyport, Mass.  
National Lock Washer Co., Newark, N. J.  
Railway Specialty & Supply Co., Chicago.  
St. Louis Car Co., St. Louis, Mo.  
U. S. Metal & Mfg. Co., 25 Broad St., New York.
- Nuts and Bolts.**  
National Lock Washer Co., Newark, N. J.  
Railway Specialty & Supply Co., Chicago.
- Oilers.**  
Armstrong Oiler Co., 31st and Chestnut St., Philadelphia.
- Oils—(See Lubricants).**
- Overhead Equipment—(See Electric Railway Supplies).**
- Packings.**  
Electric Service Supplies Co., 200 Plymouth Bldg., Chicago.  
Johns-Manville, H. W., Co., New York.  
Power Specialty Co., 111 Broadway, New York.
- Packing, Steel Wool Journal.**  
Robertson, Wm., & Co., Fifth Floor Great Northern Bldg., Chicago.
- Paints.**  
Standard Paint Co., 100 William St., New York.  
St. Louis Surfacor & Paint Co., St. Louis, Mo.
- Pay-As-You-Enter Cars.**  
Pay-As-You-Enter Car Co., 26 Cortlandt St., New York.
- Pipe Bends and Fittings—(See Steam Fittings).**
- Poles, Metal.**  
Creshead Engineering Co., Cincinnati, O.  
Electric Railway Equipment Co., Cincinnati, O.  
Electric Service Supplies Co., 200 Plymouth Bldg., Chicago.
- Poles and Ties, Wood.**  
Barnes, G. H., Hardwood Lumber Co., St. Louis, Mo.  
Beldier, Francis, & Co., Chgo. Berthold & Jennings, St. Louis.  
Churchill Cedar Co., Spokane, Wash.  
Humbird Lumber Co., Sand Point, Idaho.  
Lindsay Bros. Co., Spokane, Wash.  
National Pole Co., Escanaba, Mich.  
Naugle Pole & Tie Co., 226 La Salle St., Chicago.  
Pacific Coast Pole Co., Spokane, Wash.  
S-E, Missouri Cypress Co., Campbell, Mo.  
Worcester, C. H., Co., Tribune Bldg., Chicago.
- Promoters of Railway Projects.**  
Shimer & Chase Co., Omaha, Neb.
- Punches—(See Ticket Punches).**
- Rail Benders.**  
Electric Service Supplies Co., 200 Plymouth Bldg., Chicago.  
Fairbanks, Morse & Co., Chgo.
- Rail Bonds—(See Bonds, Rail).**
- Rail Bonds, Flexible.**  
Chase-Shawmut Co., Newburyport, Mass.
- Rail Drills—(See Drills, Track).**
- Rail Feed Wire—(See Wire and Cables).**
- Rail Joints and Chairs—(See Joints, Rail).**
- Rails, New.**  
New York Switch & Crossing Co., Hoboken, N. J.  
Wharton, Wm., Jr., & Co., Philadelphia.
- Rails, Relaying.**  
Zelnicke, Walter A., Supply Co., St. Louis.
- Railway Equipment.**  
Johann, F. A., 1824 Pierce Bldg., St. Louis.
- Railway Velocipedes.**  
Fairbanks Morse & Co., Chgo. Kalamazoo Railway Supply Co., Kalamazoo, Mich.
- Registers and Fittings—(See Fare Registers).**
- Relays.**  
Weston Electrical Instrument Co., Newark, N. J.
- Roofing.**  
Johns-Manville, H. W., Co., New York.
- Sand Apparatus.**  
American Car Co., St. Louis.  
Brill, The J. G., Co., Philadelphia.  
Electric Service Supplies Co., 200 Plymouth Bldg., Chicago.  
Kuhlman, The G. C., Car Co., Cleveland.  
Marshall, R. W., & Co., 95 Liberty St., New York.  
Ohio Brass Co., Mansfield, O.  
Ridlon, Frank Co., 200 Summer St., Boston.  
St. Louis Car Co., St. Louis, Mo.  
Stephenson, John, Co., Elizabeth, N. J.  
Wason Mfg. Co., Springfield, Mass.
- Sash Balances and Fixtures.**  
National Lock Washer Co., Newark, N. J.
- Sash Operating Devices.**  
Drouvé, The G. Co., Bridgeport, Conn.  
Lord & Burnham, Irvington-on-Hudson, New York.
- Seats, Car—(See Car Seats).**
- Shade Rollers—(See Curtains, Fixtures and Materials).**
- Signals.**  
Blake Signal & Manufacturing Co., Boston.  
Telegraph Signal Co., Rochester, N. Y.
- Signal Supplies.**  
Railway Specialty & Supply Co., Chicago.
- Skylights.**  
Drouvé, The G. Co., Bridgeport, Conn.  
Lord & Burnham, Irvington-on-Hudson, New York.
- Snow Plows, Sweepers and Scrapers.**  
American Car Co., St. Louis.  
Brill, The J. G., Co., Philadelphia.  
Kalamazoo Railway Supply Co., Kalamazoo, Mich.  
Kuhlman, The G. C., Car Co., Cleveland.  
McGuire-Cummings Mfg. Co., Chicago.  
Russell Car & Snow-Plow Co., Ridgway, Pa.  
Stephenson, John, Co., Elizabeth, N. J.  
Wason Mfg. Co., Springfield, Mass.
- Sockets, Waterproof.**  
Johns-Manville, H. W., Co., New York.
- Solder Paste.**  
Chase-Shawmut Co., Newburyport, Mass.
- Springs.**  
American Car Co., St. Louis.  
Brill, The J. G., Co., Philadelphia.  
Kuhlman, The G. C., Car Co., Cleveland.  
McGuire-Cummings Mfg. Co., Chicago.  
Marshall, R. W., & Co., 95 Liberty St., New York.  
Railway Steel Spring Co., 71 Broadway, New York.  
St. Louis Car Co., St. Louis, Mo.  
Stephenson, John, Co., Elizabeth, N. J.  
Wason Mfg. Co., Springfield, Mass.
- Sprinkling Cars.**  
American Car Co., St. Louis.  
Brill, The J. G., Co., Philadelphia.  
Kuhlman, The G. C., Car Co., Cleveland.  
McGuire-Cummings Mfg. Co., Chicago.  
Stephenson, John, Co., Elizabeth, N. J.  
Wason Mfg. Co., Springfield, Mass.
- Stage Pockets and Plugs.**  
Chase-Shawmut Co., Newburyport, Mass.
- Steam Apparatus.**  
Green Fuel Economizer Co., Matteaue, N. Y.
- Steam Fittings, Etc.**  
Crane Co., Chicago.  
Davis, The John, Co., Chgo.  
Simmons, John, Co., 110 Centre St., New York.  
Power Specialty Co., 111 Broadway, New York.
- Steel Cars.**  
American Car Co., St. Louis.  
Brill, The J. G., Co., Philadelphia.  
Kuhlman, The G. C., Car Co., Cleveland.  
St. Louis Car Co., St. Louis, Mo.  
Stephenson, John, Co., Elizabeth, N. J.  
Wason Mfg. Co., Springfield, Mass.
- Steel Tapes.**  
Lufkin Rule Co., Saginaw, Mich.
- Stokers.**  
Babeck & Wilcox Co., 85 Liberty St., New York.  
Green Engineering Co., Com'l Nat. Bk. Bldg., Chicago.  
Model Stoker Co., Dayton, O.  
Under-Feed Stoker Co. of Am., Chicago.  
Westinghouse Machine Co., Pittsburg.
- Storage Batteries—(See Batteries).**
- "Strike-Breakers."**  
Drummond Detective Agency, 3 Ann St., New York.
- Superheaters.**  
Power Specialty Co., 111 Broadway, New York.
- Switches, Frogs and Crossings.**  
American Frog & Switch Co., Hamilton, O.  
Barbour-Stockwell Co., Cambridgeport, Mass.  
Cleveland Frog & Crossing Co., Cleveland, O.  
Fairbanks, Morse & Co., Chgo.  
Morden Frog & Crossing Co., Rookery, Chicago.  
New York Switch & Crossing Co., Hoboken, N. J.  
Railway Specialty & Supply Co., Chicago.  
Wharton, Wm., Jr., & Co., Philadelphia.
- Switchboards and Switchboard Instruments.**  
Anderson, A., & J. M., Mfg. Co., Boston.  
Chase-Shawmut Co., Newburyport, Mass.  
General Electric Co., Schenectady, N. Y.  
Western Electric Co., Chicago.  
Westinghouse Electric & Mfg. Co., Pittsburg.  
Weston Electrical Instrument Co., Newark, N. J.
- Tapes and Webbing.**  
Hope Webbing Co., Providence, R. I.  
Johns-Manville, H. W., Co., New York.  
Okonite Co., Ltd., 263 Broadway, New York.
- Testing Instruments.**  
Queen & Co., Philadelphia.  
Weston Electrical Instrument Co., Newark, N. J.
- Test Lamps, Pocket.**  
Chase-Shawmut Co., Newburyport, Mass.
- Ticket Choppers and Destroyers.**  
Patten, Paul B., Salem, Mass.
- Ticket Punches.**  
Meyers, Fred J., Mfg. Co., Hamilton, O.  
Woodman Mfg. & Sup. Co., Boston.
- Ties and Poles, Wood—(See Poles and Ties).**
- Timber.**  
Beldier, Francis, & Co., Chgo. Lindsay Bros. Co., Spokane, Wash.  
S-E, Missouri Cypress Co., Campbell, Mo.
- Tools, Pneumatic—(See Pneumatic Tools).**
- Track Cleaners and Scrapers.**  
American Car Co., St. Louis.  
Brill, The J. G., Co., Philadelphia.  
Kalamazoo Railway Supply Co., Kalamazoo, Mich.  
Kuhlman, The G. C., Car Co., Cleveland.  
McGuire-Cummings Mfg. Co., Chicago.  
Marshall, R. W., & Co., 95 Liberty St., New York.  
Ohio Brass Co., Mansfield, O.  
Stephenson, John, Co., Elizabeth, N. J.  
Van Dorn & Dutton Co., Cleveland, O.  
Wason Mfg. Co., Springfield, Mass.
- Track Drills—(See Drills, Track).**
- Tracklaying Machinery.**  
Holman, D. F., Ry. Tracklayer Co., 1102 Ellsworth Bldg., Chicago.
- Track Tools.**  
Electric Service Supplies Co., 200 Plymouth Bldg., Chicago.  
Kalamazoo Railway Supply Co., Kalamazoo, Mich.
- Trimings, Car.**  
American Car Co., St. Louis.  
Brill, The J. G., Co., Philadelphia.  
Curtain Supply Co., Park Row Bldg., New York.  
Kuhlman, The G. C., Car Co., Cleveland.  
National Lock Washer Co., Newark, N. J.  
St. Louis Car Co., St. Louis, Mo.  
Stephenson, John, Co., Elizabeth, N. J.  
Wason Mfg. Co., Springfield, Mass.
- Trolley Guards.**  
Automatic Trolley Guard Co., 391 Ellicott Sq., Buffalo, N.Y.  
Electric Service Supplies Co., 200 Plymouth Bldg., Chicago.
- Trolley Poles and Fittings.**  
General Electric Co., Schenectady, N. Y.  
Johns-Manville, H. W., Co., New York.  
Marshall, R. W., & Co., 95 Liberty St., New York.  
Star Brass Works, Kalamazoo, Mich.

# STANDARD HIGH-SPEED "INTERBOROUGH" DOUBLE TRUCK

TYPE C-60

## "Solid Forged"

WITHOUT WELDS

FRAMES ARE MADE FROM ROLLED OPEN-HEARTH STEEL WITHOUT WELDS. ALL WEARING BOLTS ARE TURNED AND CASE HARDENED, AND WEARING HOLES STEEL THIMBLED. M. C. B. STANDARD PRINCIPLES ARE FOLLOWED. WE ARE PREPARED TO BUILD TRUCKS IN ACCORDANCE WITH PURCHASER'S DESIGNS AND SPECIFICATIONS.

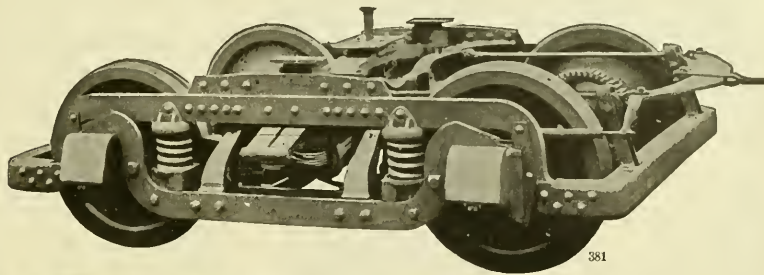

381

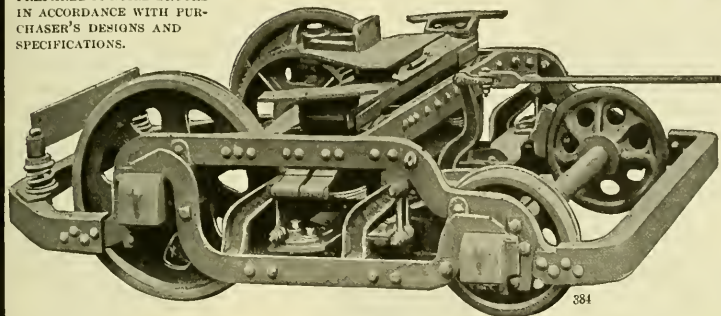

384

## STANDARD "MAXIMUM TRACTION" DOUBLE TRUCK

CITY AND SUBURBAN TYPE O-45

OVER TWO HUNDRED OF THESE "MAXIMUM TRACTION" TRUCKS ARE IN SERVICE IN BROOKLYN, NEW YORK, AND ARE PRONOUNCED "HIGHLY SATISFACTORY."

STANDARD MOTOR TRUCK COMPANY, FRICK BUILDING, PITTSBURGH, PENNSYLVANIA  
NEW YORK OFFICE: 170 BROADWAY WORKS: NEW CASTLE, PA. CHICAGO OFFICE: FISHER BUILDING

# Save Money on Repairs and Parts for Railway Motors

by patronizing our works—the largest of their kind in America—where we

- make Armatures complete, re-shaft and rewind them
- furnish Commutators complete, refilled and assembled
- do all kinds of field work for nearly all different makes of Dynamos and Motors.



We give the best of service. You can pay freight both ways (unless very far distant) and still save money.

Cleveland Armature Works  
Cleveland, Ohio

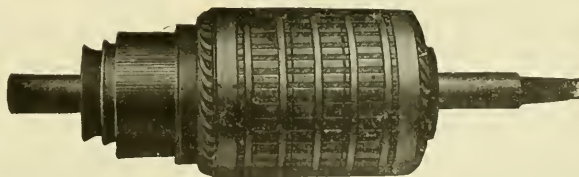

26

CLASSIFIED LIST OF ADVERTISERS—Continued.

- Trolley Retrievers and Catchers. Electric Service Supplies Co., 1029-24 Filbert St., Phila.  
 Milloy Electric Co., Bucyrus, O.  
 Ridlon, Frank, Co., 200 Summer St., Boston.  
 Trolley Supply Co., Canton, O.
- Trolley Wagons. Kalamazoo Railway Supply Co., Kalamazoo, Mich.
- Trolley Wheels—(See Trolley Poles and Fittings).
- Trolley Wire—(See Wire and Cables).
- Trolleys, Track. Cleveland Armature Works, Cleveland, O.
- Trucks, Car. American Car Co., St. Louis.  
 Baldwin Locomotive Works, Philadelphia.  
 Brill, The J. G., Co., Philadelphia.  
 Kuhlman, The G. C., Car Co., Cleveland.  
 McGuire-Cummings Mfg. Co., Chicago.  
 St. Louis Car Co., St. Louis, Mo.  
 Standard Motor Truck Co., Pittsburg, Pa.  
 Standard Varnish Works, New York City.  
 Stephenson, John, Co., Elizabeth, N. J.
- Trucks, Car—Continued. Van Dorn & Dutton Co., Cleveland, O.  
 Wason Mfg. Co., Springfield, Mass.
- Turbines. General Electric Co., Schenectady, N. Y.  
 Westinghouse Machine Co., Pittsburg, Pa.
- Valves—(See Steam Fittings).
- Varnish. Electric Service Supplies Co., 200 Plymouth Bldg., Chicago.  
 Harrison Elec. & Mfg. Co., 169 South St., New York.  
 Marshall, R. W., & Co., 95 Liberty St., New York.  
 Milloy Electric Co., Bucyrus, O.  
 Nuttall, R. D., Co., Pittsburg, Pa.  
 Ridlon, Frank, Co., 200 Summer St., Boston.  
 Standard Paint Co., 100 William St., New York.  
 Star Brass Works, Kalamazoo, Mich.  
 Trolley Supply Co., Canton, O.  
 Wallace Supply Co., Chicago.  
 Westinghouse Electric & Mfg. Co., Pittsburg, Pa.
- Ventilators. Drouvé, The G. Co., Bridgeport, Conn.  
 Lord & Burnham, Irvington-on-Hudson, New York.
- Vestlettes. Bellamy Vestlette Mfg. Co., Cleveland, O.
- Waste, Cotton and Wool. Hagy, J. Milton, Waste Wks., Philadelphia, Pa.  
 Railway Specialty & Supply Co., Chicago.
- Water Softening Apparatus. Dearborn Drug & Chemical Works, Chicago.
- Wheels and Axles. American Car Co., St. Louis.  
 Brill, The J. G., Co., Philadelphia.  
 Griffin Wheel Co., Chicago.  
 Kuhlman, The G. C., Car Co., Cleveland.  
 McGuire-Cummings Mfg. Co., Chicago.  
 Marshall, R. W., & Co., 95 Liberty St., New York.  
 Railway Steel-Spring Co., New York.  
 St. Louis Car Co., St. Louis, Mo.  
 St. Louis Car Wheel Co., St. Louis, Mo.  
 Standard Steel Works, Philadelphia.  
 Stephenson, John, Co., Elizabeth, N. J.  
 Wason Mfg. Co., Springfield, Mass.
- Wheel Grinders. Wheel Truing Brake Shoe Co., Detroit, Mich.
- Window Fixtures. Drouvé, The G. Co., Bridgeport, Conn.
- Wiping Rags. Hagy, J. Milton, Waste Wks., Philadelphia, Pa.
- Wire, Aluminium. Aluminium Co. of America, Pittsburg, Pa.
- Wire, Insulated. Aluminium Co. of America, Pittsburg, Pa.  
 American Electrical Works, Providence, R. I.  
 General Electric Co., Schenectady, N. Y.  
 Okonite Co., Ltd., 253 Broadway, New York.  
 Standard Underground Cable Co., Pittsburg, Pa.  
 Stuart-Howland Co., Boston.
- Wire and Cables. Aluminium Co. of America, Pittsburg, Pa.  
 American Electrical Works, Providence, R. I.  
 Bridgeport Brass Co., Bridgeport, Conn.  
 General Electric Co., Schenectady, N. Y.  
 Okonite Co., Ltd., 253 Broadway, New York.  
 Standard Underground Cable Co., Pittsburg, Pa.

**Coach and Car (Metal) Surfacer**

Elastic — Durable — Economical



**ST. LOUIS SURFACER & PAINT COMPANY**  
 St. Louis, U. S. A.

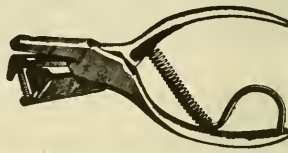

**The Fred. J. Meyers Mfg. Co. Hamilton, O.**

Largest Manufacturers in the World of **TICKET AND CONDUCTORS' PUNCHES**  
 Send for catalog of 75 different styles of punches with 1000 different dies.  
 Write for special prices.

**ALUMINUM**

**Railway Feeders**

And all kinds of **Electrical Conductors**

Aluminum Feeders are less than one-half the weight of copper feeders and are of equal conductivity and strength. If insulated wire or cable is required, high grade insulation is guaranteed.

Write for prices and full information.

**Aluminum Company of America**

PITTSBURGH, PA.

Formerly The Pittsburgh Reduction Company

“The Oasis in the Desert of Waste”

**Motor Packing Waste**

No dirt or grit  
 All long strands and satisfaction

**The J. Milton Hagy Waste Works**

433 Spruce Street, Philadelphia

**THE BABCOCK & WILCOX COMPANY**

85 Liberty Street, New York

Babcock & Wilcox ——— Stirling ——— A & T Horizontal ——— Cahall Vertical

**WATER TUBE STEAM BOILERS**

STEAM SUPERHEATERS

Works: Bayonne, N. J. Barberton, Ohio.

MECHANICAL STOKERS

BRANCH OFFICES:

BOSTON, Delta Bldg.  
 PHILADELPHIA, 1110-1112 North American Bldg.  
 SAN FRANCISCO, 63 First Street  
 PITTSBURGH, Farmers Deposit Nat. Bank Bldg.  
 NEW ORLEANS, 343 Baronne St.

DENVER, 410 Seventeenth St.  
 SALT LAKE CITY, 313 Atlas Block  
 WASHINGTON, Colorado Building  
 CHICAGO, Marquette Bldg.  
 ATLANTA, Ga., 1132 Candler Bldg.

CLEVELAND, 706 New England Bldg.  
 MEXICO CITY, 7 Avenida, Juarez  
 HAVANA, CUBA, 116 1/2 Calle de la Habana  
 LOS ANGELES, 321 Trust Bldg.  
 CINCINNATI, O., Traction Bldg.



This 14-inch Hochfeldt Eclipse Combination Back Pressure and Relief Valve was installed three years ago in the boiler plant of the Chicago City Railway, located at 77th and Vincennes Road, and is operating with best results.

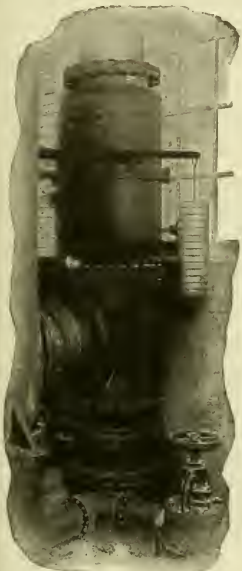

**THE JOHN DAVIS COMPANY**  
 HALSTED 22<sup>ND</sup> AND UNION STS - CHICAGO

**TUBULAR POLES**  
 IRON OR STEEL



FOR  
 ELECTRIC RAILWAYS  
 ELECTRIC LIGHTING CO'S  
 SIGNAL TELEPHONE TELEGRAPH SERVICE  
 TRANSMISSION LINES  
 AND CATENARY SUSPENSION LINES

**ELECTRIC RAILWAY EQUIPMENT CO.**  
 General Office: CINCINNATI-O-U-S-A  
 Shops: READING PA - WHEELING WVA



Established 1877.



**ALBERT & J. M. ANDERSON MFG. CO.,**

Makers of

**ELECTRICAL APPLIANCES:  
 SWITCHES, SWITCHBOARDS,  
 TIME SWITCHES, LINE MATERIAL,  
 COPPER CASTINGS (75% CONDUCTIVITY.  
 289-293 A ST., BOSTON, MASS., U. S. A.**

Branches:

New York, 135 Broadway. Chicago, 175 Dearborn Street.

Agencies:

Boston, Pettingell-Andrews Co. San Francisco, Eccles & Smith Co.  
 New York, R. W. Marshall & Co. Atlanta, Newcomer-Manry Co.  
 St. Louis, J. C. White. Denver, E. M. Messiter.  
 Toronto, Ont., H. J. Surtees.



The

**SIGNAL SYSTEM**

that prevents accidents, facilitates traffic and promotes adherence to schedules

is made by the

**Telegraph Signal Co.**  
 82 State St., Rochester, N. Y.

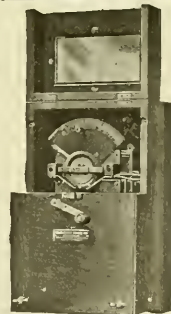

**WESTON Electrical Instrument Co.**

Main Office and Works:  
 WAVERLY PARK, NEWARK, N. J.

**Illuminated  
 Dial Station  
 Instruments**

SEND FOR NEW CATALOGUE



Weston Standard Illuminated Dial Station Voltmeter Model 11

Berlin—European Weston Electrical Instrument Co., Ritterstrasse, No. 88  
 Paris, France—E. H. Cadiot, 12 Rue St. Georges  
 London—Audrey House, Ely Place, Holborn  
 New York Office—74 Cortlandt St.

**Queen Testing Sets**

"The Recognized Standard"

Voltmeters  
 Ammeters  
 Switchboard and Portable  
 Alternating and Direct Current



Queen Aemie Testing Set

U. S. Standard Testing Sets  
 Rail Bond Testers  
 Galvanometers, etc., etc.  
 Electrical Instruments for All Purposes

**QUEEN & CO., Inc., Philadelphia, Pa.**

**THE ARNOLD COMPANY**  
ENGINEERS—CONSTRUCTORS.  
ELECTRICAL—CIVIL—MECHANICAL  
191 LA SALLE STREET  
CHICAGO

**H. M. Bylesby & Company**  
Incorporated  
ENGINEERS  
Americo Trust Bldg., Chicago

Design, Construct and Operate  
Railway, Light, Power and  
Hydraulic Plants

EXAMINATIONS AND  
REPORTS

**J. G. WHITE & COMPANY**  
INCORPORATED  
**Engineers, Contractors**

43-49 Exchange Place,  
41-43 Wall Street

New York, N. Y.

Principal Philippine Office: Manila, P. I.

**Complete Plants for the Rapid  
Handling of Material**

Every Sort of Hoisting Apparatus

BROWN HOISTING MACHINERY CO. Cleveland, Ohio

**COLUMBIA CONSTRUCTION CO.**  
BUILDERS OF  
**Electric Railways**

Colby and Abbot Building : MILWAUKEE, WIS.

**Surface, Jet and Barometric Condensers**  
**Edwards Air Pumps** **Centrifugal Pumps**  
**Water Cooling Towers**

Wheeler Condenser & Engineering Company  
CARTERET, N. J.

90 West Street, NEW YORK Monadnock Block, CHICAGO, ILL.

**E. SAXTON**  
**CONTRACTOR**

SPECIALTIES:

**CONDUIT ELECTRIC RAILWAYS**  
**TROLLEY LINES**  
CITY AND SUBURBAN  
**CONDUIT SYSTEMS, ETC.**

OFFICE, 841 BLADENBURG ROAD, WASHINGTON, D. C.  
Long Distance Telephone, East 887

**A. L. REGISTER & CO.**  
Engineers and General Contractors—Electric Railway  
112 North Broad St. PHILADELPHIA, PA. Established 1889

**SHIMER & CHASE CO.**  
**Experienced Promoters of Electrical Railway Projects**  
Correspondence Solicited OMAHA, NEB.

**CENTRAL INSPECTION BUREAU**  
Inspection of Rails, Ties, Cars, Motors, Bridges, Buildings, Etc.  
17 STATE STREET - - - NEW YORK CITY

**LINE MATERIAL**  
ELECTRIC SUPPLIES FOR RAILWAYS, POWER PLANTS, ETC.  
THE CREEHEAD ENGINEERING CO., 348 Main Street, Cincinnati, Ohio

**THE CURTAIN SUPPLY CO.**  
CAR CURTAINS  
CHICAGO, 85-93 Ohio Street 1819 Park Row Bldg., NEW YORK

**Gongs** For Street Cars **Bells**  
G. C. REITER, Canton, Ohio

**HOT WATER HEATERS FOR CARS**  
THE PETER SMITH HEATER COMPANY, Detroit, Mich.

**AUTOMATIC TROLLEY GUARD CO.**  
391-393 Ellicott Square, Buffalo, N. Y. 3  
"IT PUTS THE WHEEL ON THE WIRE"

**BRAKESHOES**  
STANDARD  
BRAKESHOE COMPANY  
GEN'L OFFICES & WORKS—AURORA, ILL. CHICAGO OFFICE, 310 N. EXCH.

WRITE TO **MODEL STOKER COMPANY** DAYTON OHIO  
for detailed information about the best  
**AUTOMATIC SMOKELESS FURNACE**

**GEARS AND PINIONS**  
FOR ALL TYPES OF MOTORS  
THE VAN DORN & DUTTON CO., CLEVELAND, OHIO

**RE-ENFORCED SPOKE WHEELS**  
For City and Suburban Cars  
ST. LOUIS CAR WHEEL CO., St. Louis, Mo.

**ENGINEERS**

who wish to be numbered among the  
elect should be represented on this page

The cost is small—ask us about it

**ELECTRIC RAILWAY REVIEW**  
160 Harrison Street, Chicago

## Shawmut Soldered Bond Cap

to make over your  
**PLUG BONDS**



Why not look this up

**CHASE-SHAWMUT CO.**

Newburyport, Mass.

## Plastic Rail Bond Durability

When you see one you think of the other.

A bond that shows but 5 percent depreciation after eleven years' severe service has earned the right to be known as the

### Durable Rail Bond

The plug type can be installed without disturbing the pavement or removing the angle plate.



This shows you how.

**When Put,  
Stays Put!**

**HAROLD P. BROWN,**

*The Bond Expert,*

120 LIBERTY STREET, NEW YORK.

## Galena-Signal Oil Company

FRANKLIN, PA.

THEIR SPECIALTIES

**STREET RAILWAY LUBRICATION** including both rolling stock and power house equipment.

Same skillful expert supervision given in this service as in steam railway service has produced very satisfactory results. The business of our Street Railway Department has increased beyond every expectation. In 1906 this department sold ten times the number of barrels of oil sold by the same department in 1903.

We are under contract with many of the largest street and interurban railroads of the country.

We guarantee cost per thousand miles in street railway service when conditions warrant it.

Write to Franklin, Pennsylvania, for further particulars.

**STEAM RAILWAY LUBRICATION** Sole manufacturers of the celebrated *Galena Coach, Engine and Car Oils* for steam railway lubrication. *Sibley's Perfection Valve Oil* for cylinder lubrication, and *Perfection Signal Oil* for use in railway signal lanterns.

**GALENA RAILWAY SAFETY OIL** Made especially for use in headlights, cab, classification and tail lights, and for switch and semaphore lamps. Burns equally well with the long time as with the one-day burner; with or without chimney as the burner requires. Is pure water white in color; high fire test, low cold test, and splendid gravity.

**CHAS. MILLER, President**

## Trolley Catchers

THE RIDLON No. 2



Made  
a  
little  
stronger  
than  
the  
service  
requires

Thoroughly up-to-date and embodying many exclusive advantages. Manufactured by skilled mechanics in our own factory, where every detail is given careful supervision.

*Catchers sent on 30 days' trial*

**FRANK RIDLON COMPANY**

200 Summer St., Boston, Mass.

Pacific Coast Representatives:

**THE H. M. ESTES CO.**

GENERAL OFFICE, SAN FRANCISCO, CAL.

Los Angeles, Cal.

Branch Offices:

Portland, Ore.

*Put into practice the principles  
laid down in this book*

# “The Motorman and His Duties”

*and the result will be better, safer  
and more economical operation.*

¶ Electric railway companies can well afford to place copies of this book in the hands of motormen. Its purpose is to familiarize the reader with the operation of electric railway cars. It explains in simple language, devoid of mathematics and technicalities, many points not generally understood by the average employe who has to do with the operation or care of electric railway rolling stock. Such knowledge cannot fail to make his services more valuable to his company and more satisfactory to himself, and it will also better fit him for promotion.

The revised, enlarged and improved sixth edition is now ready. Two hundred pages; 138 illustrations; three folding sheets of charts and diagrams; cloth binding.

Price, \$1.50 per copy, prepaid

Send for 16-page descriptive pamphlet

**The Wilson Company** 160 Harrison Street  
Chicago

# FOR SALE. FOR QUICK DELIVERY

## 6 55-ft. Passenger, Baggage and Smoking Car Bodies

Main Compartment 26' 0"  
 Smoking " 10' 6"  
 Baggage " 10' 0"  
 Seating Capacity, 54

## 8 60-ft. Passenger, Baggage and Smoking Car Bodies

Main Compartment 28' 6"  
 Smoking " 11' 0"  
 Baggage " 8' 0"  
 Seating Capacity, 58

## 5 52-ft. Passenger and Smoking Car Bodies — Double End

Seating Capacity, 60

## 3 52-ft. Passenger and Baggage Car Bodies — Double End

Seating Capacity, 56

## 2 50-ft. Express Car Bodies

*Write or wire us for further information.*

# The Jewett Car Co. Newark Ohio

### THE MIGHTY MIDGET

## HOT WATER CAR HEATER

Adapted for Large Electric Cars and Long Distance Lines. Exclusively used on Largest Electric Systems. Ask for Catalog

THE WILLIAM C. BAKER HEATING & SUPPLY CO., 143 LIBERTY STREET NEW YORK



## NILES CARS — THE ELECTRIC PULLMANS

LARGE, FAST INTERURBANS  
OUR SPECIALTY

### NILES CAR & MFG. COMPANY

WORKS: NILES, OHIO

Sales Office: J. A. HANNA Co., 312 Electric Bldg., Cleveland, O.

#### FOUNDRIES

CHICAGO DETROIT  
 DENVER ST. PAUL  
 TACOMA BOSTON  
 KANSAS CITY

GENERAL OFFICES  
WESTERN UNION BLDG.

CHICAGO

## GRIFFIN WHEEL COMPANY

### CHILLED IRON

# Car Wheels

OF EVERY DESCRIPTION  
 FOR ALL CLASSES OF SERVICE  
 IRON OR STEEL AXLES. REFITTING A SPECIALTY

### Baldwin Locomotive Works

BURNHAM, WILLIAMS & CO., PHILADELPHIA, PA., U. S. A.

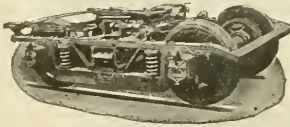

Builders of  
**LOCOMOTIVES**

of every description  
including

**ELECTRIC  
LOCOMOTIVES**

**ELECTRIC TRUCKS**

### Standard Steel Works Co.

HARRISON BLDG., PHILA., PA., U. S. A.

New York, N. Y. Cleveland, O. St. Louis, Mo. Denver, Colo.  
Portland, Ore. Richmond, Va. Chicago, Ill. St. Paul, Minn.  
San Francisco, Cal. Seattle, Wash. Winnipeg, Can.

**Solid Forged  
Rolled and Steel Tired Wheels**

Mounted on axles fitted with Motor Gears  
for Electric Railway Service.

**LOCOMOTIVE TIRES      RAILWAY SPRINGS  
FORGINGS                      CASTINGS**



## CONSOLIDATED CAR-HEATING COMPANY

NEW YORK

CHICAGO

Office and Station  
Heaters

**ELECTRIC HEATERS**

For All Classes of Cars

Independent  
Vestibule Heaters



CONTINUOUS JOINT

Over  
25,000  
miles  
in use



WEBER JOINT

Rolled  
from  
Best Quality  
Steel



WOLHAUPTER JOINT

Catalogs at Agencies  
Baltimore, Md.      Portland, Ore.  
Boston, Mass.      Seattle, Wash.  
Chicago, Ill.      St. Paul, Minn.  
Denver, Colo.      St. Louis, Mo.  
Pittsburg, Pa.      Troy, N. Y.  
London, Eng.      Montreal, Can.

Highest Awards—Paris, 1900;  
Buffalo, 1901; St. Louis, 1904

Additional safety and economy in **Track Maintenance** has been proved by the use of Continuous, Weber and Wolhaupter base-supported rail joints—after ten (10) years' service, having a record of over 25,000 miles in use—the extent of which is evidence of their excellence.

### THE RAIL JOINT COMPANY

General Offices: 29 West 34th Street, New York City  
Makers of Rail Joints for Standard and Special Rail Sections, also Girders, Step or Compromise, and Insulating Rail Joints, protected by patents in United States and Foreign Countries.

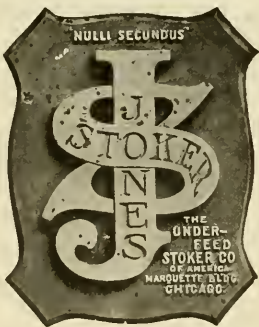

## PIPE FITTINGS AND VALVES

FOR THE  
HEATING AND PLUMBING TRADE

TRADE  MARK

**JOHN SIMMONS CO.**  
104-110 Centre Street, NEW YORK

IF YOU wish to keep posted on all steam railway matters you must read **THE RAILWAY AGE**, for it is the leading railway journal of the world and the only one that covers all phases of the industry.

Sample copies sent on request.

## THE RAILWAY AGE

160 HARRISON STREET - - CHICAGO

# A Non-Arcable Trolley Wheel

will aid you in eliminating your trolley wheel troubles.

## Our Humphrey Wobble Trolley Wheel

is non-arcable. Runs on a globe bearing and has an oiling device that lubricates for seven days.

*Write today for catalog and sample wheel.*

**HUMPHREY TROLLEY & MFG. CO., Detroit, Mich.**



## Whitmore's Gear Protective Composition

One road reports gear cases packed with

car in continuous operation one year and one week, no further applications made, absolutely no wear on either gears or pinions. These results are what cause our competitors to make false statements about the use of our goods. Try it and be convinced.

**The Whitmore Manufacturing Company**  
LUBRICATING ENGINEERS  
Cleveland, Ohio, U. S. A.

## Mica Prices Reduced

*Compare our prices on Raw Mica and Manufactured Mica with prices you have been paying our competitors.*

**WHY PAY FANCY PRICES?**

**CHICAGO MICA CO.**  
VALPARAISO : : : INDIANA

## GREEN TRAVELING LINK GRATES

- Highest Capacity
- Highest Efficiency
- Automatic Smokeless
- Labor Saving
- Cheap Fuel

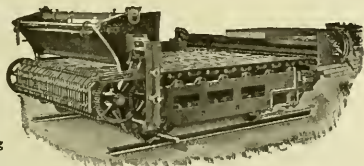

**GREEN ENGINEERING CO.**  
Main Office: Commercial National Bank Bldg., Chicago, Ill.  
BRANCH OFFICES: Pittsburgh : St. Louis : St. Paul : Louisville  
General Foundry Work a Specialty

## "Not an Experiment"

The Providence Fender has been in successful operation on hundreds of roads for 13 years, and has proved itself reliable under all conditions of Street Railway service.

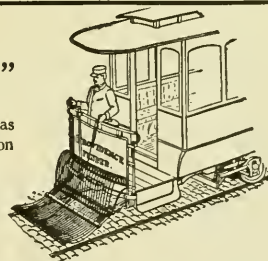

**CONSOLIDATED CAR FENDER COMPANY**  
Office and Factory: PROVIDENCE, R. I.  
Branch Office: 110 E. Twenty-third St., New York  
European Agents: Comptoir d'Electricite, 6, Rue Boudreau, Paris, France

## THE WHEEL TRUING BRAKE SHOE

quickly repairs the crippled wheel and does it while the wheel is running. No argument is needed. Practical railroad men take in the situation at a glance. That is why we sell so many. Best material. Best workman-hip. Great experience in this line of work. Low prices.

**The Wheel Truing Brake Shoe Co.**  
DETROIT, MICHIGAN



## Railway Steel-Spring Co.

GENERAL OFFICES: 71 Broadway, NEW YORK

**Springs**  
**Steel-tired Wheels**  
**Latrobe Motor Wheel Tires**

BRANCHES: Chicago, Detroit, Louisville, Mexico City,  
St. Louis, St. Paul, Washington

# CLASSIFIED ADVERTISEMENTS

Undeveloped advertisements are inserted under this heading at the uniform rate of one cent a word; minimum charge twenty-five cents. Replies directed to this office will be forwarded when required to any address in the United States, Canada or Mexico without extra charge. Advertisements received at the Chicago office by 9 a. m. Thursday will appear in the issue for the same week.

## POSITIONS WANTED.

Position as chief engineer and machinist wanted. Will go to responsible company on trial. Have had 25 years' practical experience. Address "No. 563," care of Electric Railway Review, Chicago.

Young man with four years' experience in office, drafting room, and field work, alternately, desires position as utility man with electric road, in east preferably. Address "No. 569," care of Electric Railway Review, Chicago.

Stenographer and office man with number of years' experience in railway supply business desires to secure position with good firm. Best reference. Would leave city. Address "No. 571," care of Electric Railway Review, Chicago.

Position as chief clerk or auditor by young, single man with seven years' experience electric railway work. Good knowledge of operating departments; exceptional references. Address "No. 559," care of Electric Railway Review, Chicago.

Position wanted as track foreman by a reliable and practical construction man of many years' experience on both city and interurban roads. Can give good engineering reference; do not drink. Address "No. 565," care of Electric Railway Review, Chicago.

Officers of electric railway properties desiring services of an experienced operating superintendent, young, energetic and reliable, having successfully handled a 200-car system, are requested to address "No. 555," care of Electric Railway Review, Chicago.

Experienced electrical engineer wants position with manufacturing concern or with company operating electric railways. Graduate Purdue University, 1905. Will go anywhere for permanent position. Age 26; married; A No. 1 references as to habits and ability. Address "No. 570," care of Electric Railway Review, Chicago.

## POSITIONS WANTED.

Wanted—A young man experienced in street railway and electric light accounting desires position as auditor. Best of references as to character and ability. Address "No. 573," care of Electric Railway Review, Chicago.

Wanted—To correspond with company needing the services of high-class general manager or general superintendent. Electrical and civil engineer; 17 years' experience with large properties and in construction and operation. Address "No. 568," care of Electric Railway Review, Chicago.

Accountant, first-class, desires position. Good executive ability and a strict business man. Can keep any kind of accounts; render comparative statistical statements, and not afraid to go against anything. Make me an offer. Address C. K. Tilton, Suite A-1, Champion Bldg., Atlantic City, N. J.

An experienced supply salesman, who also has had thirteen years' operating experience on city lines, desires to form connection with a railway supply house handling either electric or steam supplies or both. Would consider proposition to open sales agency. Address "No. 566," care of Electric Railway Review, Chicago.

Master mechanic of undeniable ability and experience is at liberty to accept reasonable offer. Has had 15 years' experience in both steam and electric service. Has exceptional ability in equipping new rolling stock and handling shops and men on economical basis. Address "No. 560," care of Electric Railway Review, Chicago.

Position as superintendent or assistant to general manager wanted. Eighteen years' experience in railway work. For the last six years have been superintendent of an electric railway company. Can get best of references from present employers. Can also give good reason for wishing to make change. Address "No. 572," care of Electric Railway Review, Chicago.

## POSITIONS OPEN.

Park superintendent wanted. State experience and salary wanted; also give references. Address "No. 561," care of Electric Railway Review, Chicago.

Twelve offices, covering entire street railway and manufacturing world, 1,000 technical and office positions open. Confidential service; write today, HAP-GOODS, 305 Broadway, New York, or 1010 Hartford Bldg., Chicago.

## BUSINESS OPPORTUNITIES

Wanted—Man with some capital and a knowledge of railway track supplies to join the advertiser—a salesman handling locomotive and car supplies—in a general railway supply business. Address "No. 558," care of Electric Railway Review, Chicago.

Don't throw away your old batteries. We have a preparation which will positively renew old dry batteries at the cost of two cents each. Trial package and electrical catalogue 10 cents. Adams Electric Co., Dept. E. R., Kewanee, Ill.

## MISCELLANEOUS WANTS.

Want to buy second-hand equipment, machinery or material? A card inserted in the Electric Railway Review, stating just what you want, will bring immediate response. The cost is small—only \$1.20 an inch (measuring 1 inch deep by 1½ inches wide) per insertion. Send orders to Electric Railway Review, 160 Harrison St., Chicago.

What have you to sell in the way of second-hand equipment, machinery or material? Buyers read the "For Sale" cards on the following page and there is the place to tell your story. "For Sale" cards are inexpensive—only \$1.20 an inch (measuring 1 inch deep by 1½ inches wide) per insertion. Special rates on contracts for 100 inches or more to be used within one year. Now is the time to send your order to Electric Railway Review, 160 Harrison St., Chicago.

## BOOKS AND PUBLICATIONS.

Wanted—Copies of the Street Railway Review of July, 1904, and June, 1906. State condition and price. Address "No. 567," care of Electric Railway Review, Chicago.

Wanted—Copies of the Street Railway Review of April, 1900, May, 1901, and August, 1903. State price and condition. Address "No. 553," care of Electric Railway Review, Chicago.

We want your friends to read the Electric Railway Review. You will do them—and us—a favor by sending their addresses. We will gladly mail free sample copies. Electric Railway Review, 160 Harrison Street, Chicago.

If interested in any phase of steam transportation, you will find every development covered fully and accurately in The Railway Age. It is the leader and acknowledged authority in this field. Ask for free sample copies. The Railway Age, 160 Harrison Street, Chicago.

A copy of "The Motorman and His Duties," the standard handbook on the theory and practice of electric car operation, is worth many times its cost to every man interested in the subject. Send for 16-page pamphlet of sample pages. The Wilson Company, 160 Harrison Street, Chicago.

Interstate commerce national legislation to July 1, 1906, is fully covered in our reference pamphlet. It contains the full text of the act, interstate commerce as amended, including the Elkins and Hepburn acts, and of the supplementary act relating to the testimony of witnesses before the Interstate commerce commission. It also contains the texts of the expedition act, the anti-trust act of 1890, the employers' liability act and the safety equipment laws. Difference in type shows the parts expunged from, and the parts added to, the interstate commerce and Elkins acts by the Hepburn act. This pamphlet is of special value to railway men and lawyers. Mailed prepaid for 25 cents in stamps or coin. Special prices for quantities. The Wilson Company, 160 Harrison St., Chicago.

## If You Have a Position for a High Grade Man

you can quickly secure his services in one of two ways

- by answering "Positions Wanted" advertisements on this page, or
- by advertising on this page under the heading, "Positions Open"

*Either plan will prove a winner—try it now*





**Black Baking Varnish**  
 —especially adapted for insulating street railway motors. Possesses the same high insulative efficiency as P. & B. Clear Baking Varnish. Repels water, oil and dirt, and is non-corrosive. Bakes to a smooth, tough, lustrous, flexible coat, possessing great strength.  
*Write for interesting booklet.*

**The Standard Paint Co.** 100 William Street  
 NEW YORK, N. Y.  
 Chicago St. Louis Kansas City Boston Philadelphia New Orleans

**R.W. MARSHALL & CO.**  
 95 and 97 Liberty St., New York  
 Second-Hand Machinery and Equipment  
**ELECTRIC RAILWAY MATERIALS**

**RAILS**  
*Locomotives Cars Etc.*  
 Bought & Sold  
*Water & ZELNICKER Supply Co.*  
 ST. LOUIS

**FOR SALE CHEAP!**  
 One 14x22 eight-wheel locomotive  
 Ten 24-foot 50,000 capacity flat cars  
 Two Greatest Turntables  
 70 bar cars, 40 and 50,000 capacity  
 80 Good Second-hand Bridges  
 Specifications and Blue Prints on application  
**F. A. JOHANN**  
 1624 Pierce Bldg., St. Louis, Mo.

**Pantasote**  
 The National Standard for Car Curtains and Car Upholstery.

**AGOSOTE HEADLINING**  
 The only headlining made in one solid piece. Will not separate, warp or blister. Waterproof and homogeneous.

**THE PANTASOTE COMPANY**  
 707 Fisher Building, Chicago, Ill. 11 Broadway, New York

**FOR SALE:** A number of **Nine-Bench Open Motor Cars**, monitor decks, in good condition.  
 Address: Rockford & Interurban Ry. Co., Rockford, Ill.

**NO SNOW TO DELAY CARS**  
 The Russell Snow-Plow is used by more than 50 roads to maintain schedules and prevent blockades.  
 Russell Car & Snow-Plow Co., Ridgway, Pa.  
 Wendell & MacDuffie, Cortlandt St., New York; C. A. Ralston, Fisher Bldg., Chicago; Robinson & Cary Co., Saint Paul.  
**IF YOU HAVE A RUSSELL**

**FOR SALE: Three Car Bodies and Three Pairs of Double Trucks**  
 with or without electric equipment and air brakes; all new and never used. Compelled to sell, as these cars will not operate over a leased line by reason of their width and length.  
**R. W. MARSHALL & CO., 97 Liberty St., New York, N. Y.**

**FOR SALE CHEAP**  
**200 Second Hand STREET CAR BODIES**  
 Vestibule and Open, in elegant condition.  
 Also 1,000 New Car Folding Gates and 300 Car Stoves  
**THE ISAAC JOSEPH IRON CO. OF CHICAGO** 1247 First National Bank Building.

**Armstrong Journal Oiler**  
 SAVES OIL SAVES MONEY  
 PREVENTS HOT BOXES

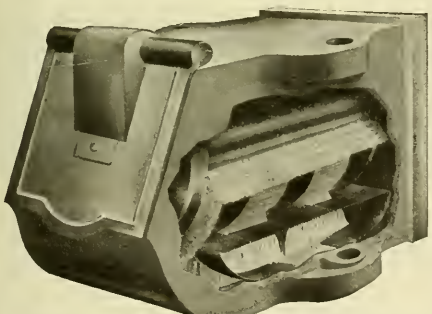

**A Perfect Journal Lubricator**  
 Will last several seasons without renewal, like waste; and can not shake away from the journal. Catalogue and trial sample for the asking.

**Armstrong Oiler Co.**  
 31st and Chestnut Streets PHILADELPHIA  
**OHIO BRASS COMPANY**  
 MANSFIELD, OHIO Agents West of Pennsylvania

**VALVES—FITTINGS—STEAM SPECIALTIES**  
**CRANE CO.**  
 CHICAGO  
 ESTABLISHED 1855

**Replies to Want Ads**  
 may come in care of the ELECTRIC RAILWAY REVIEW and are forwarded without charge.  
 The cost of want ads is only one cent a word per insertion.

**THE ARNOLD COMPANY**  
 ENGINEERS - CONSTRUCTORS  
 ELECTRICAL - CIVIL - MECHANICAL  
 181 LA SALLE STREET  
 CHICAGO

**A. L. REGISTER & CO.**  
 Engineers and General Contractors—Electric Railways  
 112 North Broad St. PHILADELPHIA, PA. Established 1888

**H. M. Bylesby & Company**  
 Incorporated  
 ENGINEERS  
 American Trust Bldg., Chicago  
 Design, Construct and Operate  
 Railway, Light, Power and  
 Hydraulic Plants EXAMINATIONS AND  
 REPORTS

**SHIMER & CHASE CO.**  
 Experienced Promoters of Electrical Railway Projects  
 Correspondence Solicited OMAHA, NEB.

**CENTRAL INSPECTION BUREAU**  
 Inspection of Rails, Ties, Cars, Motors, Bridges, Buildings, Etc.  
 17 STATE STREET - - - NEW YORK CITY

**LINE MATERIAL**  
 ELECTRIC SUPPLIES FOR RAILWAYS, POWER PLANTS, ETC.  
 THE CREGHEAD ENGINEING CO., 348 Main Street, Cincinnati, Ohio

**J. G. WHITE & COMPANY**  
 INCORPORATED  
**Engineers, Contractors**  
 43-49 Exchange Place,  
 41-43 Wall Street New York, N. Y.  
 Principal Philippine Office: Manila, P. I.

**THE CURTAIN SUPPLY CO.**  
 CAR CURTAINS  
 CHICAGO, 85-93 Ohio Street 1819 Park Row Bldg., NEW YORK

**Gongs** For Street Cars **Bells**  
 G. C. REITER, Canton, Ohio

**Ford, Bacon & Davis,**  
 Engineers,  
 115 BROADWAY,  
 NEW YORK.

**HOT WATER HEATERS FOR CARS**  
 THE PETER SMITH HEATER COMPANY, Detroit, Mich.

**ELECTRIC HEATERS** For All Classes  
 of Cars  
 New York Consolidated Car-Heating Co. Chicago

**COLUMBIA CONSTRUCTION CO.**  
 BUILDERS OF  
**Electric Railways**  
 Colby and Abbot Building : MILWAUKEE, Wis.

**BRAKESHOES**  
 STANDARD  
 BRAKESHOE COMPANY  
 GEN'L OFFICES & WORKS - AURORA, ILL. - CHICAGO OFFICE 319 N. W. EACH

**GRIFFIN WHEEL CO.**  
 CHICAGO  
 CHILLED IRON CAR WHEELS IRON OR STEEL AXLES

**The Roberts & Abbott Co.**  
 E. P. ROBERTS ENGINEERS W. H. ABBOTT  
**Electric Railways, Light and Power**  
 Complete Industrial Plants Water Power Development  
 CLEVELAND CHICAGO PHILADELPHIA BALTIMORE

WRITE TO **MODEL STOKER COMPANY** DAYTON OHIO  
 for detailed information about the best  
**AUTOMATIC SMOKELESS FURNACE**

**WHEEL TRUING BRAKE SHOES**  
 Repair Cripped Wheels While Running  
 THE WHEEL TRUING BRAKE SHOE CO., Detroit, Mich.

**Surface, Jet and Barometric Condensers**  
**Edwards Air Pumps Centrifugal Pumps**  
**Water Cooling Towers**  
 Wheeler Condenser & Engineering Company  
 CARTERET, N. J.  
 90 West Street, NEW YORK Monadnock Block, CHICAGO, ILL.

**ENGINEERS**  
 who wish to be numbered among the  
 elect should be represented on this page  
 The cost is small—ask us about it  
**ELECTRIC RAILWAY REVIEW**  
 160 Harrison Street, Chicago

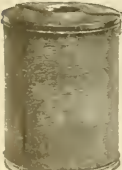
 **SOLENOIDS AND MAGNETS**  
 for any purpose; lift and travel guaranteed.  
 Special electrical work and motors.  
**THE PORTER MFG. CO.** 29 Griswold Street  
 DETROIT, MICH.

**CAR ADVERTISING**  
*Barron & Collier*  
**ALMOST EVERYWHERE**  
*Flat Iron Building, New York.*

**THE NATIONAL LOCK WASHER CO.,** NEWARK, N. J.  
 Curtains - Curtain Fixtures - Sash Locks - Sash Balances - Nut Locks  
 CHICAGO OFFICE: 419 MONADNOCK BLOCK

Specify the Genuine Roller. It is that Element that makes a Car Curtain a Success. Every Genuine Roller has the Name of Manufacturer



**HARTSHORN'S**  
**TIN ROLLER**

**STEWART HARTSHORN**  
 —IN SCRIPT ON LABEL—  
**STEWART HARTSHORN CO.**  
 Office and Factory, E. NEWARK, N. J.  
 NEW YORK, 382 Lafayette St. CHICAGO, 338-344 Wabash Ave.

Special Car Rollers are made. Brackets are made for all classes of fittings. Used all over the world wherever cars are run.



**NILES CARS** —THE—  
**ELECTRIC PULLMANS**

LARGE, FAST INTERURBANS  
 OUR SPECIALTY

**NILES CAR & MFG. COMPANY**  
 Works: NILES, OHIO  
 Sales Office:  
 J. A. HANNA CO., 312 Electric Bldg., Cleveland, O.

**Galena-Signal Oil Company**  
 FRANKLIN, PA.  
 THEIR SPECIALTIES

**STREET RAILWAY LUBRICATION** including both rolling stock and power house equipment.  
 Same skillful expert supervision given in this service as in steam railway service has produced very satisfactory results. The business of our Street Railway Department has increased beyond every expectation. In 1906 this department sold ten times the number of barrels of oil sold by the same department in 1903.  
 We are under contract with many of the largest street and interurban railways of the country.  
 We guarantee cost per thousand miles in street railway service when conditions warrant it.  
 Write to Franklin, Pennsylvania, for further particulars.

**STEAM RAILWAY LUBRICATION** Sole manufacturers of the celebrated *Galena Coach, Engine and Car Oils* for steam railway lubrication. *Sibley's Perfection Valve Oil* for cylinder lubrication, and *Perfection Signal Oil* for use in railway signal lanterns.

**GALENA RAILWAY SAFETY OIL** Made especially for use in headlights, cab, classification and tail lights, and for switch and semaphore lamps. Burns equally well with the long time as with the one-day burner; with or without chimney as the burner requires. Is pure water white in color; high fire test, low cold test, and splendid gravity.

CHAS. MILLER, President



Passenger Paying Fare

Street Railways using the

**Rooke Automatic Fare Collector**

get every nickel collected because every nickel is registered before it reaches the conductor's hand. No chance to go astray!

**Rooke Automatic Register Co.**  
 Providence, Rhode Island

# ROLLING DOORS

In Steel, Wood or Bronze

FOR CAR BARNs, FREIGHT SHEDS, ETC.

Made by the

## JAS. G. WILSON MFG. CO.

New York Office: 3 W. 29th Street

ESTABLISHED 1876

Incorporated 1903

## Do away with the Hot Box Habit on your road

by using STEEL WOOL JOURNAL PACKING—the perfect packing that has accomplished this result on many roads

*Send now for a free sample and test it*

### WM. ROBERTSON & COMPANY

General Office: Great Northern Bldg., CHICAGO  
Factory: 75 S. Jefferson St., BATTLE CREEK, MICH.

10

# U.S. Metal & Mfg. Co.

25 Broad Street, New York

Pittsburg, 1509 Arrott Bldg. Chicago, 414 Railway Exchange

## Perfect <sup>Pressed Steel</sup> Car Replacer



Size No. 2. For Interurban and Electric Railroads

Weight, 55 pounds per set. Will fit any size rail from 5 inches down.

3

# A Portable Bonding Car

that will save a sum equal to its cost in six months' work. It does perfect bonding and rebonding by modern methods—

## Electric Brazing AND Copper Welding

*Our definition of perfect bonding is:*

An amalgamation of rail and bond possessing greatest conductivity and longest life, produced at least cost.

*May we tell you more bonding facts?*

### THE ELECTRIC RAILWAY IMPROVEMENT COMPANY

6005 Carnegie Ave. - - - CLEVELAND, OHIO

12

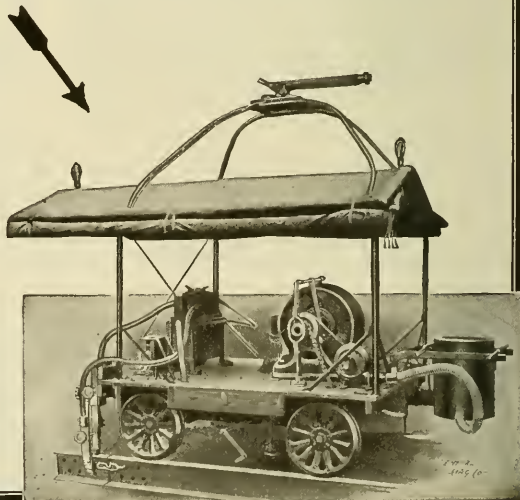

# Electric Railway Review

PUBLISHED EVERY SATURDAY BY THE WILSON COMPANY, CHICAGO

Entered as second-class matter January 5, 1907, at the postoffice at Chicago, Ill., under the act of March 3, 1879.

160 Harrison Street, Chicago  
150 Nassau Street, New York  
1529 Williamson Bldg., Cleveland

Vol. XIV  
No. 13

CHICAGO, MARCH 28, 1908

Whole No.  
257

Subscription: Domestic . . . \$2  
Foreign . . . \$5  
Canada . . . \$3.50

"How much does it cost?" is a question often expressed and always a fair one, too. If your company is not a member of the American Street and Interurban Railway Association and if you have any hesitancy about joining the association it would be well to read the booklet just issued outlining the purposes, plans and work of this

body. In this attractive booklet are found answers to the questions of what good a membership will do your road and the heads of its departments, what the association and the affiliated bodies have done, what are the objects of the association, how it is organized and how much it will cost your road to receive the many benefits now accruing to its broadly scattered membership. The scope of the work is broad and you cannot well afford to stay outside.

---

Suit was recently brought against the Chicago South Bend & Northern Indiana Railway because a passenger had littered the floor with peanut shells and, upon being asked by the conductor to desist, became abusive. This resulted in the ejection of the passenger from the car. The case, which was tried before a jury, ended in

**The Courts Uphold Cleanliness.** the judge sustaining a motion made by the defense to instruct the jury to bring in a verdict for the defendant. Thus the court upholds the right of an electric railway company to establish rules for preserving sanitary conditions on its cars, clothing the company with the right to enforce such rules. On the other hand, had the court favored a judgment for the ejected passenger, it would have discouraged electric railway companies from well-directed attempts to maintain their cars in a clean condition. Such attempts are made by the companies even though a large part of the traveling public seems to have no regard for the other portion which appreciates cleanliness.

---

It is particularly satisfactory to be able to note the apparent success of the pay-as-you-enter car in New York during the few days it has been in operation on the Madison avenue line. Its advent has been hailed with delight by all who are accustomed to use the line in their daily travels and on Sunday, the first day of its use, the cars narrowly escaped being swamped with eager patrons, with whom, however, curiosity was the controlling impulse. After several days it has not been possible to discover any serious objection to the use of this type of car, and the New York patron, who believes himself worse treated in the matter of transportation facilities than his fellow countryman anywhere, has taken most kindly to what seems the first attempt toward the amelioration of his condition. Whether he will take so kindly to a development of the system of handling fares which has been proposed is quite another question. Pleased with the success of the experiment in general, General Manager Oren Root now announces that as soon as the public has become fully accustomed to the new cars he will put in a nickel-in-the-slot machine for collecting fares. That the new cars have been received so considerably and have operated with so few instances of friction is a result of a careful

**Pay-As-You-Enter in New York.**

campaign of education under which the company took its patrons into its confidence as to what it was going to do and stated clearly the assistance it expected from them. When the first car appeared most of its patrons knew how to use it. Since that time the correctness of the principle on which the car is arranged has been amply demonstrated, especially at the Grand Central station, where passengers enter and leave the cars in unusually large numbers. The only probable source of difficulty in making the use of this type of car general is the physical one of streets too narrow to afford room at intersections for the turning of cars of such length. But there are still a number of lines in New York on which this objection does not obtain. Because it is so the favor with which the cars have been received in their experimental service is of great importance.

---

It is a long step from the 22-account classification proposed by the interstate commerce commission for the use of roads having gross annual revenues of less than \$50,000 to the classification with over five times as many accounts prescribed for those roads having larger incomes. We do not wonder at the protests now so frequently expressed against this definition of a large and a small road. Such protests, of course, carry the most weight when they are combined with suggestions as to how the dividing line can better be chosen. We publish such a suggestion this week. Among the communications to the editors presented in this issue the vice-president of a large metropolitan system suggests a method for defining companies entirely different from that of comparing the gross annual revenues. His suggestion is that companies can best be classified for this purpose according to the number of cars operated daily. With the companies rated according to serviceable cars it would be possible for the revenues to be increased without an expansion of the then existing classification. The number of employees of any company is closely proportionate to the number of cars operated, and, as nearly all companies might handle more passengers with the number of cars operated than they now do, there are attractive features in this method of rating.

**Classifying According to Cars Used.**

---

How important are some of the electric railroad installations that have recently been made or are now in progress, in comparison with steam railroads recognized as leaders in the matter of passenger business. This was clearly shown by figures presented at the annual electrical meeting of the New York Railroad Club on March 20 by L. B. Stillwell, consulting electrical engineer for the Hudson Companies and the Interborough Rapid Transit Company. In this connection emphasis was laid upon the difference between the development of steam railroads from small beginnings to their present proportions—a development in capacity rather than an improvement in kind—and the bringing up from the horse-car era of an entirely new system of operation to a point where its trains equal or exceed the capacity of those hauled by the steam locomotive. In view of this, the status of development of electrical power is remarkable. Upon the basis

**Comparing Steam and Electric Systems.**

of the service performed in five weeks by the Brooklyn extension of the Interborough Rapid Transit Company—a line whose present terminus is such as to minimize the demands made upon it—and of that which has been performed in a shorter period by the Hoboken line of the Hudson Companies, it appears that the passenger miles of each of these two installations will annually exceed those of the New York New Haven & Hartford, the New York Central, nearly double the business of the Erie and be about equivalent to that of the Pennsylvania Lines East of Pittsburg. Most of these roads are exceptional in the volume of their passenger traffic. Additional complications are introduced into the operating problem owing to the limited distances over which the trains operate, requiring an average headway of about two minutes, and this with trains of a capacity exceeding that of the average steam railroad train. Electrical service appears to have arrived nearly at the standardization stage and the elements which make each separate installation more or less of an experiment have been materially diminished. The significance of this fact from an economic standpoint is of course proportionate to the magnitude of each individual installation and comparisons are therefore not merely the satisfaction of an idle curiosity.

---

### LIVE AND DEAD TRAILERS.

---

There are many attractive reasons for using trail cars. Some of these reasons are quite general, applying to nearly all street railways. Trail car operation also must have its disadvantages or it would be more generally practiced throughout the country. We should like to learn of these disadvantages so that they may be weighed against the credits.

Notable among the electric railway systems which find trail and multiple car operation advantageous for city service are the Denver City Tramway, Columbus (O.) Railway & Light Company and the St. Joseph (Mo.) Railway Light Heat & Power Company. The equipments of the latter company are described and illustrated in this issue of the Electric Railway Review. It may be of interest to review briefly the types of motor and trail cars used on these three representative railways, outlining meanwhile the advantages of the combination service.

Referring to the illustrated description of the Denver cars presented in the Electric Railway Review for May 4, 1907, page 578, we find that these equipments, both motor and trailer, are notably light in weight per unit of seating capacity. Both motor and trail cars are provided with center side entrances and thereby differ from the types more common to eastern street railways. The motor cars are designed for high schedule speeds during the middle of the day when running as single units and thus have the necessary motor capacity to handle light trailers during the rush hours. The type of motor car thus used seats 52 passengers and weighs complete, equipped with four 43-horsepower motors, 38,000 pounds. The weight per unit seating capacity is 730.8 pounds.

There has been developed in Denver a trail car with probably as low weight per unit seating capacity as would be consistent with a proper regard for maintenance. The trailers are 38 feet long over all, 8 feet 2 inches wide over all and weigh complete but 13,000 pounds. They provide seats for 46 passengers, with a generous amount of standing space. This is a total weight per unit of seating capacity of 282.7 pounds.

In Denver the trail and motor cars are equipped with straight air brakes having the emergency features. Electric lighting is effected by a simple plug connection with the motor car. Trailer cars are used only as traffic demands them. Results of meter readings over long periods show that while the power required for motor cars only at a schedule speed of 10.3 miles per hour with six stops per mile is 2.8 kilowatt-hours per car-mile, the addition of trailers to these

motors increases the power used by only 41.1 per cent or to 3.95 kilowatt-hours per train-mile. For this additional power the gain in seating capacity is from 52 to 98. The Denver Tramway service is trailer operation in the strict sense of the word. In Columbus, O., the rush-hour traffic is handled with 2-car trains, each car having a motor equipment and control system. The leading car of a train has type M control, while the rear car has a K-10 controller. The platform controller is not used, however, when the cars are coupled. Each car has two 40-horsepower motors. A bus line connects the motor circuits on the two cars so that multiple-unit operation is possible.

The leading car of tests recently made at Columbus weighed 34,366 pounds and had seats for 40 passengers. This car was 40 feet 8 $\frac{1}{2}$  inches long over vestibules. The second car of the train had like characteristics except that it was one foot shorter. In the tests mentioned with the running conditions as to speed, length of run, stops per mile, etc., approximately the same as those mentioned as average conditions for the Denver runs, each car of a train of two cars in Columbus consumed 3.04 kilowatt-hours per mile as compared with a consumption of 3.95 kilowatt-hours per train-mile for a motor and trailer in Denver. The seating capacities of the two trains were: Columbus, 80 passengers; Denver, 98. The salient feature of this comparison is that on the score of power no gain is to be expected from multiple-unit operation because the total weight of two motor cars will likely exceed the total weight of a motor car and a trailer. Other valuable features resulting from 2-car service are the same for 2-motor cars as for a motor car with a trailer.

The St. Joseph Railway Light Heat & Power Company has put into use a system of train operation which combines the desirable features of both the Denver and Columbus systems. It uses both "live" and "dead" trailers, as traffic conditions warrant, thereby obtaining the greatest possible flexibility in adjusting service to traffic. The live trailers used in St. Joseph are single-truck, long wheel base equipments, carrying two motors with neither trolley poles nor control equipments. Seven main power wires leading from the two motors on a trailer terminate in coupler heads on the dashes, so that by means of a jumper connecting with a similar head on the motor car the two motors on the live trailer may take power through the control system of a leading fully equipped motor car. The result is a train of two cars, the forward one of which receives current from the trolley wire and handles it through a multiple-unit control equipment designed for four motors, two motors of which are mounted on maximum traction trucks under the leading car; the two other motors are on the so-called "live" single-truck trailer.

Each type of car is provided with a straight air brake equipment, including emergency features, so that no danger from collision may arise in case of a parting of the train. The cars equipped with controllers also have the regular multiple-unit control train line with 9-point coupler heads, so that it is possible to operate them in trains of several units, each of the cars having two motors and its own set of contactors.

Still another combination is possible which comprises a motor car equipped with full control hauling a live trailer, and both in combination hauling an ordinary trail car without motors; or a "dead" trailer may be hauled, as is the customary practice with other roads.

The reasons for the success attained with these three kinds of cars are not far to seek. St. Joseph is not so large a city that traffic is congested except during special periods. These occur when the employes of the large packing houses go to and from their work and when the crowds on pleasure bent ride to and from the railway company's attractive park at Lake Contrary. During the periods of ordinary traffic the single cars equipped with two motors and multiple-unit control apparatus can satisfy the schedules in excellent shape.

When rush hours come or when the park crowds are to be moved the maximum schedule speeds are maintained by coupling live trailers with the motor cars and operating them as units either with or without a dead trailer as the traffic may demand. For high schedule speeds on suburban lines two straight motor cars may be operated in multiple.

Some of the advantages which may be set out to the credit of live and dead trailer operation seem worthy of mention. They are: Low investment per unit seating capacity; reduced idle investment during periods of light traffic; low insurance cost on account of the small number of electrical equipments; reduced necessity for covered storage because trailers have no equipment to become damaged by exposure; low maintenance cost because of fewer motors; less wear on special track work because of low average weight per seat; considerable reduction in power used per passenger carried (about 30 per cent) and its desirable resultant effect on the power station during rush-hour peak loads; a more uniform number of trains in crowded streets during the entire day; motormen not required for trippers, therefore a gain of 50 per cent in platform labor cost for the handling of the trailer loads; all of which tend toward better service at less cost per passenger carried.

#### INTERSTATE COMMERCE COMMISSION'S CLASSIFICATION OF ACCOUNTS.

The tentative classification of operating expense accounts for electric railways devised by the interstate commerce commission has been severely criticized because of the fact that it is based so largely on steam railway practice. In view of this some data as to how the classification for steam railways fits the steam railway conditions will be of interest. The interstate commerce commission's classification for steam railways in effect prior to July 1, 1907, had a total of 53 primary accounts; the new classification which has been in use since that date has 123 primary accounts. Analysis of the reports of two steam railways for the month of January, 1908, shows some rather startling facts as to what may be called the lack of symmetry of the new classification.

In the case of one of these roads, operating between 2,000 and 3,000 miles of main line, only 23 of the 123 primary accounts included as much as 1 per cent of the total operating expenses. Of the 100 accounts, each of which was less than 1 per cent of the total, six had no entries and 26 others were each less than 0.1 per cent, and of these 26 there were six each of which was less than 0.01 per cent of the total, two being less than 0.001 per cent. On the other hand the 23 accounts each of which included over 1 per cent of the total ranged from 1.04 per cent to 9.9 per cent, and 21 of them aggregated over 85 per cent of the total operating expenditures, the other account being a credit.

In the case of the other steam railway, which operates about 500 miles, only 29 of the 123 primary accounts exceeded in amount 1 per cent of the total. One of these was a credit item; the other 28 in the aggregate included nearly 95 per cent of the total operating expenses.

It must be apparent that when from one-fourth to one-third of the accounts aggregate four-fifths to nineteen-twentieths of the total amount involved, the system is sadly lacking in symmetry. The old standard of the Street and Interurban Railway Accountants' Association provided for 38 operating expense accounts, which in practice were subdivided as required to meet the needs of each company adopting the standard, and it appears to us that this plan of optional subdivision might better have been followed by the commission.

If the steam railway classification evolved after years of experience fits the steam lines so badly it is not surprising that a similar scheme when applied to the electric railways should fit them even worse.

## Communications

### CLASSIFICATION—SEPARATION OF BOILER HOUSE AND ENGINE ROOM EXPENSES.

To the Editors:

There is one feature of the tentative classification which I am certain could be revised with benefit to the industry. The accounts relating to generation of power, as outlined, do not follow in their natural order the physical processes involved in the production of electrical energy from fuel, and therefore are not in accordance with correct accounting principles.

The boilers and their accessories are devices for the production of steam from fuel only, and the boiler house expenses should be kept separate from those of the engine room. The function of the machinery in the boiler house is the conversion of the steam supplied to it into electrical energy.

The activities on one side of the boiler house wall are entirely distinct from those on the other, and the data of operating cost given separately would furnish a basis for discussion of the nature of equipment and other conditions of value to engineers and managers.

The accounts referred to are as follows: Under "maintenance of equipment," account No. 60, "power operating plant equipment," includes in the government classification: "Steam and water plant. Cost of materials used (less salvage) and labor expended in repairing and renewing steam and water plant equipment, including engines and engine parts, appliances and fixtures, belt tighteners and fixtures, receivers, lubricators and oiling devices, shafting, clutches, cranes, hoists and other engine room appliances, boilers, boiler fittings and appliances, furnaces, economizers, stacks, mechanical draft machinery, pumps, feed water heaters, purifiers, tanks, condensers, coal and ash conveying machinery, mechanical stokers and other boiler room appliances; piping and steam fitting, including valves, separators, water and sewer connections, and water meters." This should be separated into several accounts, as follows: Boiler plant—"Cost of materials used (less salvage) and labor expended in repairing and renewing boilers, boiler fittings and appliances, furnaces, economizers, stacks, mechanical draft machinery, pumps, feed water heaters, purifiers, tanks, coal and ash handling machinery, mechanical stokers and other boiler room appliances, cranes, belting, piping and steam fittings in boiler house, water and sewer connections and water meters, and all things used in generating steam from fuel." Engine room or water plant—"Cost of materials used (less salvage) and labor expended in repairing and renewing steam engine and water plant equipment, including engines and engine parts, appliances and fixtures, belts in engine room, receivers, lubricators and oiling devices, shafting, clutches, cranes, hoists and other engine room appliances, condensers and piping and steam fittings in engine room, separators, etc., and all things used in converting steam or water power into electrical energy, except electric plant, as enumerated below." Electric plant—"Cost of materials used and labor expended in repairing and renewing all electric equipment within the power house (not including the method of transmission of power beyond the power house), including generators and generator parts, dynamos, switchboards, cables and feeder terminals and wiring in connection therewith; storage batteries, transformers, boosters, rheostats, circuit-breakers, meters and other equipments."

Transportation Expenses.—Group 1—Power. Account No. 73, "wages of power generating plant employes," includes in the government classification: "Pay of employes engaged in operating electric power generating stations, including engine rooms, boiler houses, dynamo or power houses, etc., such as engineers, firemen, electricians, dynamo men, oilers, cleaners,

coal passers and other employes, except those engaged in making repairs and renewals." This account should be divided into two accounts, as follows: Boiler house—"Pay of employes engaged in operating boiler houses, such as firemen, cleaners, coal passers and other boiler house employes, and part of chief engineer's salary, or of such others as may exercise immediate joint supervision over boiler and engine plant." Engine room—"Pay of all employes engaged in operating boiler room, such as shift engineers, electricians, dynamo men, oilers and other engine room employes, and part of the chief engineer's salary, or of such others as may exercise immediate joint supervision over boiler and engine plant."

The following accounts should also be divided between engine room and boiler house: No. 76. Lubricants for power generating plants—"Cost of lubricants, oil, waste, grease, etc., used on engines, shafting, dynamos and pumps." No. 77. Other supplies and expenses of power generating plants—"Cost of carbon brushes, fuses, lamps and other supplies, heat, light and other expenses not elsewhere specified."

With these changes it would be easy to find the total boiler house expense, by combining the items concerning it, under accounts Nos. 60, 73, 74, 75, 76 and 77.

WILLIAM R. GAITHER,

Assistant Treasurer and Auditor South Chicago City Railway, Chicago, Ill., March 20, 1908.

#### ELIMINATE THE WORD FRANCHISE.

To the Editors:

Replying to your favor I would state that in my judgment any policy which would in effect eliminate the word "franchise" from our municipal lexicons would be a wise policy for everybody concerned.

Massachusetts, with seeming wisdom, has met this question with indeterminate franchises. A similar policy might be pursued in other states with similarly good results, though it must be remembered that the governments of Massachusetts are studious and unemotional. Massachusetts began a scientific study of the questions involved upon the first introduction of electricity as a new element of progress by appointing a commission of its ablest citizens to study the subject and report upon it. The report of this commission was made the basis of procedure in that state.

The pioneers and promoters of electric railway lines entered upon their work in that state as in other parts of the country enthusiastically, hopeful of vast profits. Their glowing prospectuses fell not only into the hands of investors, bringing about the outlay of much capital, but at the same time fell into the hands of the general public. And it came to be believed that inordinate profits were to be reaped to the disadvantage of the people. Both investors and the general public have been fooled. Investors are counting themselves lucky if they receive a small rate of interest upon their actual capital. Many have not been fortunate enough to get even that much. But the public still clings to the belief that millions of profits are being reaped. That fact gives the office-seeker his advantage. By telling the people how they are abused under their franchises the politician, without knowing or caring anything about the real conditions, erects himself into control of the government, and the power of the government, revolving around the word "franchise," is then used in ways which threaten to put the electric railway out of business.

In the state of Michigan—and I presume this fact applies to other states—no study of the subject has ever been made by the government through any commission appointed by the state legislature or by the administrators of any municipality. In fact, the whole state is in dense ignorance of the entire subject because it has not been systematically studied and reported upon by government authority, while whatever is said about it by those directly concerned in the management of

such properties is disbelieved as being prompted by selfish motives.

Whether under these conditions indeterminate franchises would be an improvement is questionable, but indeterminate franchises could not at least be worse than periodic franchises as they are now treated by municipal governments.

J. C. HUTCHINS,

President Detroit United Railway,  
Detroit, Mich., March 23, 1908.

#### CLASSIFICATION—A NEW METHOD FOR DETERMINING WHAT IS A SMALL COMPANY.

To the Editors:

Circular No. 20, submitted by the interstate commerce commission for criticism and suggestions upon the tentative classification for electric railways, contains two classifications, one for companies having a gross annual revenue of less than \$50,000, with 22 accounts, and a classification for companies having a gross annual revenue of \$50,000 or over, containing 116 accounts.

The classification submitted for the smaller companies commends itself by its simplicity and could be enlarged and improved by adding to Group "I" the following accounts: "Wages for power plant employes," "fuel for generating power plant" and "other expenses and supplies." These additions could be made without destroying the simplicity of the classification or adding to the expense of keeping it, and they would show figures which a manager would want to have at hand.

The line drawn by the interstate commerce commission, \$50,000, as the limit between a small and a large company, is too low, and if it insists on taking the gross annual revenue as a basis for classifying the companies it should increase the figures to at least \$300,000. A company the revenue of which had been under \$300,000, that had been keeping 22 accounts, would be caused unnecessary expense if obliged to adopt the classification containing 116 accounts for large companies because its revenue had reached \$300,000, when the simpler classification would still answer all the requirements of the managers and stockholders.

It is a hard nut to crack to name a figure as a limit between a large and a small company and have it satisfactory to all, and I do not believe that the amount of revenue should be the controlling factor in classifying the companies. I believe a better and more satisfactory way would be to classify companies according to the number of cars operated daily, and to have it optional with the companies to keep their accounts according to the classification of accounts for the class in which they were rated or the classification provided for any of the higher classes, the managers of the companies to decide which classification was best for its needs. For instance, the companies could be divided as follows:

- A. Companies that operate 501 cars and upward.
- B. Companies that operate 301 to 500 cars inclusive.
- C. Companies that operate 101 to 300 cars inclusive.
- D. Companies that operate 1 to 100 cars inclusive.

Companies in class D operating 100 cars or less daily should be privileged to keep accounts according to the classifications for classes D, C, B or A.

Companies in class C operating 101 cars to 300 cars daily should have the privilege of keeping accounts according to the classifications for classes C, B or A.

Companies in class B operating 301 cars to 500 cars daily should have the privilege of keeping accounts according to the classifications for classes B or A.

This would necessitate four classifications. There would be no objection to four classifications on the part of the railway companies and I hope there will be none on the part of the interstate commerce commission, as it is a long step from the classification for small companies to the classification for large companies as submitted by the commission.



To classify or rate the companies according to the number of cars operated is to my mind a better way than to classify or rate them according to the amount of revenue received.

If a company is obliged to increase the number of cars operated on account of traffic increases beyond the limit of its present carrying capacity it may be obliged to increase the mechanical force and car house employes to look after the additional equipment, and to add trackmen and linemen on account of the additional wear on roadway, track and line, and its needs may call for a more refined system of accounting.

VICE-PRESIDENT.

March 23, 1908.

CLASSIFICATION—THE LINE BETWEEN LARGE AND SMALL ROADS.

To the Editors:

Referring to the tentative classification of operating expenses submitted by the interstate commerce commission, I fail to see the benefits to be derived by requiring a road the receipts of which exceed \$50,000 to use 116 accounts.

The gross receipts of the property which I represent are a little over \$300,000 per year, with operating expenses of \$139,000. I have used the standard classification with 38 accounts and find that it gives us all the information necessary.

In my mind there are two results to be obtained from a classification of operating expenses and from maintenance accounts: First, a distribution of expenses for the purpose of arriving at the cost of the various departments of the service for your own information.

way Journal, covers the situation as it relates to "small" roads, and describes a property almost identical with the one with which I am connected. I would say, however, that his limit of \$200,000 for a "small" road is not large enough. I would raise that to between \$300,000 and \$400,000.

As secretary-auditor of this company I have but one man in the office eight months in the year, and two men four months in the year. I handle all the accounts, investigate and adjust all claims and do the buying. We consider that we have an up-to-date road in all respects, but I fear that with the use of a classification with which I would have to make 116 subdivisions we would add a considerable sum to the expense and not accomplish any beneficial results.

The adoption or change of any classification is of great importance, and as our present one is the result of careful and conscientious thought by the committee which prepared it, with a great deal of work, I feel that the question should be fully discussed by all interested.

G. B. CADE,

Secretary-Auditor Atlantic Coast Electric Railway. Asbury Park, N. J., March 19, 1908.

THE RAILWAY BLUE BOOK.

To the Editors:

If the result of your kind editorial in reference to the blue book which has been issued by our engineering department

Table with columns: U. INCHES IN COLUMN UNDER SPEED MILES PER HR., PRACTICAL LEADS USED BY THE F. W. WAYNE & WABASH VALLEY TRACTION CO., FROG, SWITCH, POINTS, CLEARANCE, etc.

Railway Blue Book—A Page for the Track Men.

ment under the supervision of our chief engineer, H. L. Weber, is an index of the value of your paper as an advertising medium, we can certainly recommend the same highly,

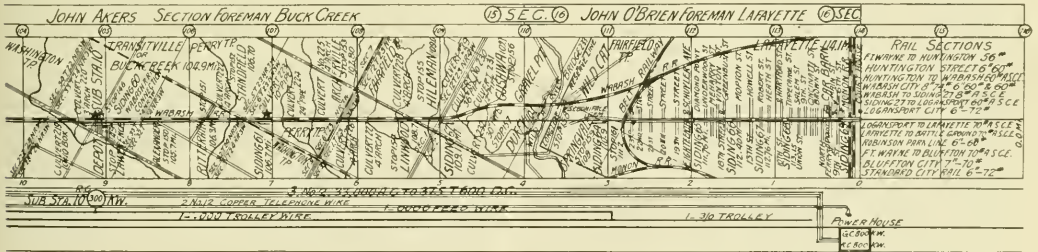

Railway Blue Book—Section of the Very Complete Right of Way Map.

comparison of the principal accounts upon which all estimates or statistics are based. When you subdivide beyond this you get into detail which, while it may be of advantage to yourself, does not enter into the object of comparison with other properties.

W. B. Brockway, in his recent article in the Street Rail-

for we have received requests from roads from the Atlantic to the Pacific almost, requesting copies of this book.

This book, as you know, is merely a blue print, and the preparation in a great quantity is quite troublesome to an engineering office with a limited force. Therefore we would suggest, if you could do so, your printing merely a part of the diagrams, to show the general character of the work to those who desire the information.

ing to persons on other properties.

You have gotten us into this difficulty by your popularity among your readers, and we will look to you to help us out.

C. D. EMMONS,

General Manager Ft. Wayne & Wabash Valley Traction Company.

Ft. Wayne, Ind., March 23, 1908.

[We are willing to help Mr. Emmons out of the difficulty in which we seem to have placed him by our editorial comment on a railway "blue book," as published in the Electric Railway Review for March 14, 1908, page 318. Therefore we reproduce herewith one page showing the tables of super-elevation of curved track, etc., and a small part of the very complete route map of which the larger portion of the book is comprised. These specimens amply show the character of this ingeniously made blue book and will serve to illustrate its value as a means of reference for the various heads of departments.—Eds.]

#### RESOLUTIONS OF NEW YORK STATE ASSOCIATION CONCERNING TENTATIVE CLASSIFICATION.

The following resolutions in relation to the tentative classification of operating expenses were passed at the meeting of the Street Railway Association of the State of New York at Albany, on March 18:

Whereas, At the request of the public service commission of the second district of the state of New York the Street Railway Association of the State of New York, by its representatives, met in Albany in October last with representatives of the commission, to consider a classification of accounts for street and interurban railroads, to be adopted by said public service commission; and

Whereas, At a subsequent meeting a classification of accounts was presented which in substance agreed with that which had been adopted after a great deal of study by the American Street and Interurban Railway Accountants' Association, which classification embodies the best practical modern thought of street and interurban railway accounting; and

Whereas, It was then suggested on behalf of the public service commission that the system of accounts for the second district of the state of New York would be adopted substantially to conform with any system of accounts which might be prescribed by the interstate commerce commission, and it was further suggested that inasmuch as representatives of the interstate commerce commission were then engaged in preparing a classification of accounts for electric railroads engaged in interstate commerce, that it would be possible for representatives of this association to meet with representatives of the interstate commerce commission and the American Street and Interurban Railway Association and various railroad commissions, with a view to agreeing upon a classification of accounts; and

Whereas, In pursuance of such suggestion, representatives of this association did meet with representatives of the interstate commerce commission in Washington for a discussion of the standard system of accounting to be adopted by the electric railroads, which discussion did take place; and

Whereas, At such meeting the classification of accounts which had been adopted by the American Street and Interurban Railway Accountants' Association with modifications was presented as the views of the American Street and Interurban Railway Association and the Street Railway Association of the State of New York as the best classification of accounts for electric railroads, copy of which is herewith attached and made a part of this resolution [This classification was published in the Electric Railway Review of December 21, 1907, page 956.—Eds.]; and

Whereas, The classification so presented did not meet with the approval of the representatives of the interstate commerce commission, who took the position that not only should there be a standard system of accounting for all transportation agencies, but also that the method of accounting for electric railroads should conform to methods heretofore adopted for steam railroads; and

Whereas, The representatives of the interstate commerce commission have prepared subsequently a tentative classification of operating expenses of electric railroads and a tentative classification of expenditures for road and equipment of electric railroads and text therefor, which have been carefully examined by members of this association and have been found to embody the theory and practice of and are conformable to the classification of accounts for steam roads; and

Whereas, The members of this association believe that

this view is erroneous and that its adoption and promulgation by the public service commission of the second district of the state of New York, to whose jurisdiction alone the majority of the members of this association are subject, would result in great inconvenience and hardship, both to such companies and to their security-holders; now therefore, be it

Resolved, That in order to prevent a serious injustice which in the opinion of this association would result to its members and their security-holders from the adoption by the public service commission of any such plan of classification of accounts as has been proposed by representatives of the interstate commerce commission, the president of this association appoint a committee of six members, whose duties shall be to make a detailed report of the objections to the tentative classifications proposed by the statistician of the interstate commerce commission, and to prepare and present a brief showing the actual conditions and probable results to the electric railroads subject to the control of the public service commission of the second district of the state of New York from an adoption by it of the proposed system of classification of accounts; and said committee is further authorized to perform any such acts which in its judgment will be necessary and proper to secure the adoption of the classification of accounts as shown on the plan hereto annexed. [Referred to in the foregoing.—Eds.]

Resolved, That in the judgment of this association the mandatory establishment of any depreciation accounts is, in the present state of the electric railway development, and under existing financial and industrial conditions, unwise and unnecessary and would impose a serious burden and hardship upon existing electric railway properties and their security-holders, and the committee appointed under this resolution is directed to make all proper efforts to prevent the establishment of any depreciation accounts chargeable to either operation or maintenance, and to secure the establishment of a permissive depreciation account to be treated as a deduction from income, as may be from time to time recommended by said public service commission.

Resolved, That said committee be instructed to request a hearing before the public service commissioners of the second district of the state of New York for the purpose of enabling this association to be heard upon the questions involved.

The names of the members of the committee to which the resolution refers were published in last week's issue, page 350. The meeting of this committee, which was to have been held on March 23, has been postponed until March 30, to be held in the office of C. Loomis Allen, vice-president of the Utica & Mohawk Valley Railway, at Syracuse, N. Y.

#### Electric Shocks.

D. S. Arnold of Purdue University delivered an address on "Electric Shocks at Different Potentials" at a meeting of the Purdue branch of the American Institute of Electrical Engineers, held on March 17, 1908, at Purdue University, Lafayette, Ind. The speaker first dwelt upon the action of electricity on the body producing death. One investigator had advanced the theory that the action of the shock on the nerves caused contraction of the capillary blood vessels and in this way stopped the heart, since there was no circuit of the blood. Another theory advanced was that death is due to electrolytic action of the current in the blood. If this is true direct currents must be considered more dangerous than alternating currents. In the investigation of the effect of electric shocks a number of things were considered, the first being the susceptibility of different persons. People differ in this respect and the susceptibility of the same person may vary at different times. Certain diseases also have an effect on the susceptibility to shock and a number of cases are recorded where persons of weak mind were affected very little by shocks. Again, the physiological condition of a person may change the effect of the shock. The path of the current through the body is given very little consideration by doctors, but the nature of the contact made with the electric circuit has much to do with the effect. The resistance of a man holding two copper pennies, to which were soldered wires, was found to be 20,000 ohms less than when he held the bare wires. The resistance of a man from thumb to thumb varies from 30,000 to 100,000 ohms. It was found that the burning increased when the area of contact was small. To sum up, it may be said that a current of less than 30 to 35 milli-amperes is not fatal, and as the resistance of the body is 30,000 ohms, at the lowest a voltage of from 100 to 110 is necessary to kill. Usually, however, the resistance of an accidental contact is much higher, so that shocks at higher voltages are received without fatal results. The burning varies inversely as the area of contact and severe burns usually indicate poor contact.

## CENTRAL ELECTRIC RAILWAY AND TRAFFIC ASSOCIATIONS.

The meeting of the Central Electric Railway Association was called to order by the president, F. D. Carpenter, general manager Western Ohio Railway, at 10 a. m. on Thursday of this week at the Claypool hotel, Indianapolis. There were 75 present.

### Chairman of Traffic Association.

W. S. Whitney, general passenger and freight agent Ohio Electric Railway, presented the report of the committee appointed at the meeting of the Central Electric Traffic Association in January to further the selection of a chairman for that organization, recommending A. L. Neereamer, formerly general superintendent Columbus Delaware & Marion Railway. The report states that this committee met with the committee of the Central Electric Railway Association on March 25 to effect a permanent organization and to select a chairman, who should also be elected permanent secretary of the Central Electric Railway Association. "After listening to various applications made in person," the report continues, "it was the unanimous opinion of the committee that A. L. Neereamer was the most competent of the various applicants."

It was estimated that \$7,000 would be necessary to defray the expenses of salary, traveling expenses, office expenses, etc., for 1908, and that each road within the territory covered by the association should be taxed pro rata according to its mileage, with a minimum of \$2.50 per month. Statements covering the expense will be forwarded to the various member roads each month, payment to be made in advance.

The election of Mr. Neereamer to these two offices was therefore announced. W. F. Milholland continues as treasurer of the association.

### Uniform Rules.

Mr. Carpenter called attention to the work of the committees which are drafting uniform rules for operation of trains and maintenance of way in Indiana. The rules submitted by these committees are to be recommended for adoption by the Indiana railroad commission. Mr. Carpenter thought it would be desirable to have uniformity of rules in Ohio and Indiana. As the Indiana committee on rules for train operation had practically adopted the Central Electric Railway Association rules as a foundation he thought that a committee should be appointed to take up the subject on behalf of the Ohio roads. The rules should be known as revised Central Electric Railway Association rules or the association would lose the credit for the work it had done.

H. A. Nicholl, general manager Indiana Union Traction Company, said that he believed the association would have the credit of furnishing the basis for the rules in Indiana and that the members of the committees felt that the book adopted in Indiana would be satisfactory to Ohio railway officials.

Alexander Shane, chief inspector of the Indiana railroad commission, was asked to speak regarding the work of the committees, which has been practically completed. He said that if there was anything needed to promote economical and safe operation it was the frequent exchange of ideas which an association permitted. The practical men who had attained positions of responsibility in the past had secured their education at the cost of thousands of dollars to the railway companies, but the day was fast passing when the railways would educate their men. The men would have to be educated before they could get responsible positions. The Indiana commission did not intend in any way to presume to operate the railways. If the commission considered the rules safe it would approve them. Uniform rules would make it easier for employes to work on different roads than if there were a different system on each line.

President Carpenter, following the offering of a resolution, announced that he would appoint a committee of Ohio

officials at the afternoon session to act with the Indiana committees.

C. D. Emmons, general manager Ft. Wayne & Wabash Valley Traction Company, brought up the subject of the Central Electric mileage book. So many notices had been given of withdrawal of the use of this book that there were now very few companies still using it. Individual books introduced by separate roads had very largely taken the place of the Central Electric mileage book. If the book was to be used still it should be reconstructed.

On motion of Mr. Emmons the president was directed to appoint a committee to ascertain how many companies desire to use the book and to make a full report recommending the continuance or the abolition of the book. Mr. Carpenter said that he would announce the committee at the afternoon session.

E. C. Carpenter, claim agent Indiana Union Traction Company, spoke of the effectiveness of index bureaus in locating dishonest claimants, and on his motion the president was authorized to appoint a committee of three to devise a plan whereby information regarding dishonest claimants of whom the members of the association have knowledge can be exchanged.

### Classification of Operating Expenses.

Strathearn Hendrie, general manager Grand Rapids Holland & Chicago Railway, urged that action be taken concerning the classification of operating expenses. The Central Electric Association more truly represented the roads in the middle west than the Street Railway Association of the State of New York or the American Street and Interurban Railway Association, which had taken action regarding the classification.

On the motion of Walter Shroyer, auditor Indiana Union Traction Company, the following resolutions were passed:

Whereas, By reason of the revolutionary character and the intricacy of the system of electric railway accounts promulgated by the division of statistics and accounts of the interstate commerce commission under Circular No. 20, Accounting Series, time beyond the date fixed by the division, namely, March 28, 1908, for the receipt of replies to the circular, is essential to well-considered action which will be of value to the interstate commerce commission and just to the electric railroad interests.

Resolved, therefore, That it is the sense of the Central Electric Railway Association that an extension of time for the making of replies to such circulars be granted to and including April 30, 1908, and that the president and secretary of the association are authorized and instructed to communicate a copy of this resolution to Henry C. Adams, in charge of such division, and to take any further action necessary to secure the desired extension.

Arthur W. Brady, president Indiana Union Traction Company, discussed the classification. An abstract of the remarks of Mr. Brady follows:

Additional time for answers to Circular No. 20 ought to be secured. While the circular is dated in January copies of it were not received until about March 1. The companies have had a very short time to consider such an involved system. The accountants of the companies are of the opinion that the system is altogether too complicated for use by companies generally. Plenty of time should be granted by the commission, so that companies may analyze the system and prepare the objections which should be made. While the interstate commerce commission does not desire to embarrass the companies, the system will add considerably to the expense of operation and will not result in giving any information of especial value to the commission. Objections are raised to the classifications, not because there are 116 primary accounts, but on account of the number of indefinite items concerning which information is asked. Some of the information can be furnished only by guesswork and the guesses will vary with the men who make them. When the current expense and power expense in shops are divided analyses will have to be made which will not be possible without exorbitant cost. Unless such divisions are made with extreme care at heavy expense they could be of no value. The circular of the commission should be analyzed as closely as possible and all objections which are entertained should be included in the reply to the commission.

Adam Cole, Vaile & Kimes Company, Dayton, O., then read his paper on "Standardization of Trolley Wheel, Harp and Pole." This paper appears elsewhere in this issue.

G. H. Kelsay, superintendent power Indiana Union Traction Company, had seen stems with grooves cut in the base from the swiveling of the trolley. The current passing through had burned out the oil between the two surfaces. To overcome this difficulty he had used a flexible bond between the base and the stand to shunt the current around the joint. He had seen roller bearing stands tried, but the rollers were reduced to one-third their size after service, due to arcing. He had had little or no trouble with other parts of the trolley.

#### Committees.

At the afternoon session President Carpenter announced the members of the three committees whose appointment was authorized at the morning session, as follows:

"Claims"—E. C. Carpenter, Indiana Union Traction Company; Walter G. Robinson, Ohio Electric Railway; F. R. Fahlsing, Ft. Wayne & Wabash Valley Traction Company; Charles A. Floyd, Grand Rapids Holland & Chicago Railway; A. L. Neereamer, secretary.

"Mileage Book"—F. D. Norviel, Indiana Union Traction Company; W. S. Whitney, Ohio Electric Railway; F. W. Brown, Michigan United Railways.

"Rules"—F. J. J. Sloat, Ohio Electric Railway; C. N. Wilcox, Cleveland Southwestern & Columbus Railway; F. W. Coon, Lake Shore Electric Railway.

H. D. Murdock, master mechanic and electrical engineer Indianapolis & Louisville Traction Company, read his paper on the 1,200-volt direct-current system of that company. This paper appears elsewhere.

A. C. Vauclain of the Baldwin Locomotive Works read his paper on "Electric Motor and Tractor Trucks," which was illustrated with stereoscopic views. W. P. Deppe then read a paper. These papers appear elsewhere.

The following were admitted to membership: Charles A. Floyd, general passenger and freight agent Grand Rapids Holland & Chicago Railway; George MacLeod, superintendent of railroads Lexington & Interurban Railways; C. P. Leibold, Ohio Brass Company; G. M. Patterson, general freight and passenger agent Toledo & Chicago Interurban Railway; W. S. Whitney, general passenger and freight agent Ohio Electric Railway; Carl H. Peterson, Baldwin Locomotive Works and Standard Steel Works; A. M. Hewes, general manager Indianapolis Crawfordsville & Western Traction Company.

The next regular meeting will be held at Cleveland.

After adjournment a number of members accepted the invitation of A. A. Anderson, general manager Indianapolis & Louisville Traction Company, to make a trip over the road. A special car left Indianapolis at 5 p. m. for the accommodation of those who made the trip.

#### Mr. Neereamer's Valuable Experience.

Mr. Neereamer, the new chairman of the Central Electric Traffic Association and secretary of the Central Electric Railway Association, has had a valuable experience with both steam and electric railways. He was in the accounting department of the Hocking Valley Railway from 1883 to 1889. During the ensuing four years he was in the general passenger office of the Cleveland & Marietta road at Mansfield, O. From 1893 to 1903 Mr. Neereamer was with the Columbus Sandusky & Hocking road at Columbus. In that time he filled successively the positions of chief clerk in the general passenger office, traveling passenger agent and chief clerk in the general freight and passenger department. In 1903 Mr. Neereamer became general agent at Columbus for the Columbus Delaware & Marion Railway, and during 1904 he was made general passenger and freight agent and then traffic manager. Mr. Neereamer was made general superintendent in 1906 and resigned on January 15, 1908. During the time he was with the Columbus Sandusky & Hocking road Mr. Neereamer was secretary for eight years of the Columbus passenger committee.

## TWELVE HUNDRED-VOLT SYSTEM OF THE INDIANAPOLIS & LOUISVILLE TRACTION COMPANY.\*

BY H. D. MURDOCK, MASTER MECHANIC AND ELECTRICAL ENGINEER.

Ever since the introduction of electric traction for interurban service the economical transmission of electric power to the moving car at a voltage that could be successfully used by the motors has been a great problem.

In the earlier institutions the booster system was used—but this at its best was not very economical—no real progress was made until the development of the rotary converter with high-tension alternating-current transmission, but this system, while capable of covering a large territory from a single power station, requires substations at frequent intervals, equipped with costly machinery needing constant attention to transform the high-voltage alternating current to the low-voltage direct current required at the motors.

To overcome these objections the single-phase railway system has been developed, using very high voltage on the trolley wire and a reducing transformer on the car. This in the abstract is ideal, but up to date the alternating-current motor has "refused" to be as good a motor as the direct-current one and for that reason the direct-current motor is still a favorite.

A remarkable development in the direct-current railway motor has recently taken place—the application of the commutating pole principle has already doubled the usual voltage and the end is not yet. This improvement in voltage capacity is a great advance in the art. The fact is noted that the voltage of railway motors has been raised only 150 volts in 20 years.

This type of motor was first used in this country with 1,200 volts on the trolley wire in the equipment of the Indianapolis & Louisville Traction Company system. It may be of interest to note how free from complication the entire system is from the power house to the car equipment.

The section of road operated at 1,200 volts is 41 miles in length, connecting with the Indianapolis Columbus & Southern Traction Company at Seymour and the Louisville & Northern Traction Company at Sellersburg, with an operating agreement with the above roads for through service from Louisville to Indianapolis without change of cars. [The equipment of the new road was described and illustrated in the Electric Railway Review for November 30, 1907, page 852.—Eds.]

The feeder system consists of two sections, extending 17 miles each way from the power house; in each section the copper is distributed as follows: Five miles, 500,000 circular-mils; 10 miles, 300,000 circular-mils; 2 miles, No. 0000. The balance of each 20-mile section is fed only by the trolley wire. The trolley is tapped to feed every 1,000 feet. The line is protected by Garton lightning arresters, designed for 1,200 volts, which are installed every 1,000 feet.

The car equipment consists of eight passenger and two express cars. The passenger cars are of the combination type arranged for single end operation and are 50 feet 4 inches in length, mounted on Baldwin trucks with rolled steel wheels 34 inches in diameter. Each car is equipped with four General Electric type 205 motors, which are commutating pole units rated at 75 horsepower and insulated for 1,200 volts; the windings of the commutating poles are connected in series with the armature. The current in the exciting fields is reversed to change the direction of rotation of the armature.

For 1,200-volt operation the two motors on each set of trucks are connected in series and each group in parallel in the free running position. On 600 volts the usual series-parallel connections are used. To make this change in grouping a commutating switch is used which is located next to the master controller in the motorman's cab.

The General Electric type M multiple-unit control system is used with a C-35A master controller which combines automatic acceleration with multiple-unit operation. A motor cut-out switch is installed on each car and is designed to cut out a pair of motors when operating on either 600 or 1,200 volts. The contacts are arranged to prevent the control system being operated beyond the series position on 1,200 volts.

As this equipment is designed to operate at 600 as well as 1,200 volts the lights, air compressor and control circuits are operated at 600 volts to use standard apparatus and insure greater safety. To obtain 600 volts for this purpose when the car is being operated at 1,200 volts a motor generator or dynamotor is used. This is the most important piece of special apparatus in the car equipment, as the operation of the entire equipment depends absolutely upon its uninterrupted operation. The dynamotor is controlled by an automatic switch or contactor, which will operate only on a voltage

\*Abstract of paper read before the Central Electric Railway Association at Indianapolis, Ind., March 26, 1908.

somewhat in excess of 600 volts. This switch is provided with a contact so arranged that when the switch is open on the dynamotor it connects the auxiliary apparatus to the 600 volts from the trolley when the car is being operated at this voltage.

To facilitate changing from 600 to 1,200 volts, or vice versa, a 50-foot dead section in the trolley wire is built at each end of the 1,200-volt line. On a car coming from 1,200 to 600 volts the following changes take place. The automatic dynamotor switch drops out, the motorman throws the commutating switch to the 600-volt position and as soon as the car is on the 600-volt section an automatic 3-point switch is thrown to the normal 600-volt position, the entire change being made in less than five seconds.

The car wiring is all run in iron conduit and all wire used is heavily insulated. So far no trouble has been caused by the 1,200 volts on any of the apparatus or wires carrying this voltage. The commutation of the motors is exceptionally good. The wear of the commutators and brushes is almost imperceptible. So far as the wear of the brushes is concerned the indications are that a set will run a million miles. Since the equipment was placed in operation last October it has run more than 260,000 car-miles, 200,000 on 1,200 volts and 60,000 on 600 volts, and has operated equally well on either.

Every system has its advantages and disadvantages and the 1,200-volt system is no exception to the rule. As compared with 600 volts it requires less copper in the feeder system, a less number of power houses or substations and a smaller power carrying capacity in the trolley wheel, which is quite an important feature. The 600-volt system has the advantage in the less cost in the car equipment as compared with the single-phase system. The motors are more efficient, weigh less, have better commutation and there is less complication in car control. The single-phase system has the advantage in the feeder system and substation equipment, but the application of 1,200 volts direct current to electric traction has placed in the hands of the electrical engineer another system to select from, which should enable him to solve some of the perplexing problems in electric traction, more economically than heretofore.

#### POSSIBILITIES OF ELECTRIC RAILWAYS.\*

BY W. P. DEPPE, VICE-PRESIDENT AND GENERAL MANAGER MABOU & GULF COAL COMPANY, LTD., CAPE BRETON, N. S.

There are two ways to make increased profits on any railway, either by increasing the traffic with a ratio of increase in operating expense less than the increased ratio of traffic or by carrying a given amount of traffic at greatly reduced operating cost.

It is axiomatic in the transportation world, in the more densely populated sections at least, that business always increases faster than the facilities. There is a possible limit for each existing electric line in expansion of local travel within a city, to resorts, etc., although there seems to be a continual increase where the management is watchful and caters to any new fad, shift of population or new attraction.

First of all it is absolutely necessary that the various lines in your territory should adopt standard tracks, cars and equipment of all kinds in all departments. This applies to interurban lines as well as city lines, because both are seriously handicapped if interurban lines find radical differences in equipment, voltage, etc., at every city.

It should be possible in the near future for any electric car to run from one end of the territory to another if a motor car with a very limited amount of changes in current requirements. On a standard gauge, however, for all lines, through express, freight and passenger cars can be operated as trailers, and it is not necessary to confine through cars to motor cars. Trailers are not half so dangerous as generally thought, where proper precautions against accidents are taken in advance.

Through cars as trailers can carry light freight, express, mail and passengers and there is a fine opportunity in this territory to establish a parcels express on a blanket rate for each state, with proper rate for interstate business. The express business of the steam lines in your territory amounts to \$6,500,000 annually, and the mail to \$8,200,000, and there is no reason why you should not have a fairly good part of that traffic. There are a great many details to overcome, but there is no good reason why all cannot be overcome. Heavy freight business requiring quick and prompt movement can be secured as lines become standardized and through car lines established.

In summer months and in some cases in winter large organized parties gotten up through societies of various kinds

can be worked up for circle tours, where the total rates include hotel, side trip and other expenses. This business has paid the steam lines well where they have properly organized for handling such business.

Proper effort should be made to establish full interchange with the steam roads, in a limited way at first perhaps. This will enable electric lines to strive for the location of large industries on their roads. It has been my observation during my connection with the steam lines that, with a few possible exceptions, the electric lines have not handled their negotiations with steam lines in a way that will ever bring about the friendship and exchange of traffic with steam lines until such time as the steam roads feel obliged to absorb the electric lines, as has been done in other sections, where the electric lines have been simple feeders for the steam lines.

It is quite possible to hasten interchange with the steam lines under certain conditions by legislation. The lake lines and coast lines have forced recognition by all the steam lines, although it took some time to do it, and in most cases they are now directly allied with the several steam systems.

It is also possible in many of the larger cities where electric lines are of steam railway standard gauge to readily arrange to do a switching business of freight between the terminals of the steam lines and warehouses of merchants and manufacturers.

Standardization of gauge, cars, equipment of all kinds, etc., means less complications mechanically and electrically. If this work is not pressed now it will but put off the day of reckoning and each year's delay to bring it about will only add to the expense when finally it is done.

It is likely that standardization will have a tendency to bring about consolidation of lines, but the fact is that the best results for some time to come will more likely accrue to the various electric lines if they remain in control of men who built up the lines into systems along natural traffic routes, thus giving personal direction to increase of business and profit, which does not as a rule occur in a large system in so thorough a manner because of rigid rules in management applying over a widely varying territory, to the detriment of peculiar local conditions which require careful nursing in the transformation stage of the development of a new industry and which are throttled when consolidation comes before these possibilities are developed.

One of the greatest causes contributing to the hatred shown by the people and legislative bodies today against steam lines lies in the fact that much injustice in detail does exist on large systems, for the reason that ranking officers on the large systems fear to alter rules and make exceptions. This should be carefully guarded against in electric line management as the properties develop and consolidation ensues.

It seems to me that all labor questions should be handled through your association in cases where your employees call in their state or national officers. The managing officers could stay in the background, although dictating the association's action. In the past the steam railways have been at a disadvantage with labor unions for the reason that the men have one single policy expressed through one head as a rule, while the railways as systems or territories consider their local conditions first. This has practically taken the discipline of the steam lines out of the hands of the roads' officers and put it into the labor union leaders' power to dictate.

In advertising certain standards can be worked out, distribution properly attended to, and good results obtained for less money, through some central agency where interurban business is involved.

The largest item of expense next to installation and wages of car men is probably the cost of producing power. While there is a tendency on the part of new lines to use existing power houses by purchasing power from established lines, the time is approaching when the lines in this association should get together in a more comprehensive power house plan. A large power house located in one of the coal fields in Ohio, in Indiana and in one of the fields in Illinois, cutting out the freight charges on coal, as well as the mining companies' profit, cost of the handling now incurred, using the largest turbine units, with main distributing lines carrying high potential current, joining the three plants on the main distributing lines across Ohio, Indiana and Illinois, will produce current and deliver it in present distributing points for approximately one-half of the present power house costs on the average. It will also save the wages and incidental expenses of scores of plants now existing for railways, lighting, power, etc. I will venture the prediction that coal will increase in cost of production at the mines at the rate of five cents per ton per annum, because of increased wages, increased cost of plants for the protection of labor, taxes and the purchase and control by large coal companies of unopened

\*Abstract of paper read before the Central Electric Railway Association at Indianapolis, Ind., March 26, 1908.

areas which are being capitalized and carrying fixed charges. The agreement of all your lines to take a certain amount of current at cost plus fixed charges in such a system of power houses would give a company sufficient credit to sell bonds for the purchase of mines, cost of power houses and transmission lines.

### ELECTRIC MOTOR AND TRAILER TRUCKS.\*

BY A. C. VAUCLAINE, BALDWIN LOCOMOTIVE WORKS.

The electric motor truck is in itself a locomotive and must be so considered in its design and construction. Purely car truck principles of design will not do. It must not only carry the weight put upon it by the car body and load, but must in addition successfully withstand the various strains produced

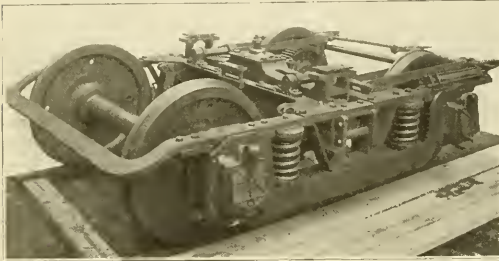

Electric Trucks—Figure 1—M. C. B. Equalized Type for 28,000-Pound Center Loading.

in it by the weight and torque of the motors, the severity of these strains being influenced by the number of motors per car or per train and their distribution. Heavy cars, great variations of loads, high speeds, high rates of acceleration and retardation, frequency of stops, irregularity of road profile, etc., augment the severity of its requirements.

Being the medium between car and roadbed, its design, workmanship and materials are important factors in the economical maintenance of both. The design of motor trucks is generally beset with the difficulty of certain restricted dimensions. With the development of higher speeds and heavier and larger cars, necessitating the use of more powerful motors and heavier trucks, the problems of motor truck design have grown more difficult.

Experience has shown that a rigid truck with springs properly designed and distributed is a better unit than a so-called electric truck. Figure 1 shows an electric motor truck of the M. C. B. equalized type, designed for a maximum center-pin load of 28,000 pounds and for Westinghouse 135-B motors, inside hung. The wheel base is 78 inches.

#### Wheel Base.

Usually the greatest difficulty with which the designer has to deal, when motors are inside hung, is a too restricted wheel base. For transoms, bolsters, bolster hangers, motor suspensions and clearances, there is only that space which is left by the motors, and sometimes so little is this that it becomes necessary to fall back on the purchaser for permission to increase the wheel base a few inches to enable the guarantee of a good job. Transom and bolster widths are important, not the least reason being that the riding qualities of the elliptic springs are impaired by restricted width. A generous wheel base not only simplifies the problems of design, but helps to keep down maintenance costs through lessened rail distortion and wheel

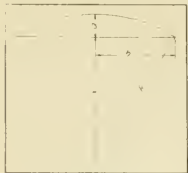

Electric Trucks—  
Figure 2.

flange wear. It is important to carefully analyze the smallest existing curve around which a truck is intended to operate, before determining upon its wheel base. The radius of an existing curve may be formed by laying off on the inside rail, by means of a tape measure, a chord of any desired length as shown by Figure 2.

Measure the middle ordinate (a) in feet or fractions

thereof and apply the following formula:  $R = (a^2 + b^2) \div 2a$ , in which  $R$  = radius of curve in feet,  $a$  = middle ordinate in feet,  $b$  = one-half the chord in feet.

Having found the radius of the curve, the greatest wheel base which will pass safely around it can be determined by the following formula, assuming M. C. B. standards in flanges and rails, no increase of gauge in curve and 31 to 40 inch diameter of wheels:  $W = R \times 0.18$ , in which  $W$  = wheel base in inches,  $R$  = radius of curve in inches.

Any spread in the curve will, of course, increase the permissible wheel base, as will also certain variations of flanges of wheels.

Now, while a sufficient wheel base is desirable, too great wheel base has its evils also. As will be explained later, the suspensions for inside hung motors should be located as near to the center of the truck as possible and with any given design and size of motor these suspensions must naturally be located farther from the center of the truck for every increase in wheel base.

The final determination of the wheel base, therefore, should, if curves will permit, be based entirely upon a transom width sufficient to allow proper width of bolster and bolster springs and the fixed length of the motors measured from their axle journals to their supporting nose.

#### Frame.

The design of a frame depends necessarily upon the conditions to be dealt with. Figure 3 shows a design of frame for an M. C. B. equalized type of motor truck with inside hung motors. It is based upon many years of locomotive experience and is undoubtedly the best design of electric motor truck frame known. The proper distribution of metal can be provided for equally well in both solid and built-up frames, and if properly designed and constructed the built-up frame is as permanent and will stay together as well as the solid frame, with the added advantage that, built as it is from commercial shapes and sizes of materials, it can be repaired at a minimum cost in shops having only the ordinary repair shop facilities, while a solid frame cannot, if seriously damaged by collisions or other accidents. It is, of course, necessary that the workmanship put into it be of the proper quality, but this holds good with the solid frame as well, being a question of machine shop in one case and of smith shop or foundry in the other.

Properly proportioned and constructed it is practically impossible for this frame to get out of square in the hardest kind of service.

For outside hung motors this frame is necessarily modified generally as shown by Figure 4. The end frames are of angle iron bolted to the side frame extensions. The location of motors requires the equalizing springs to be placed outside the pedestals to give a longer spring base, which necessitates

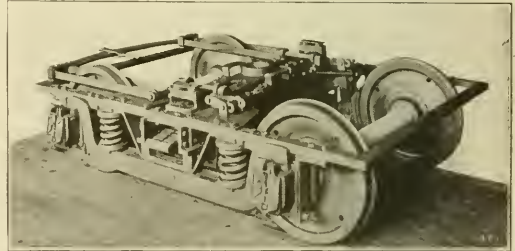

Electric Trucks—Figure 3—Equalized Type of Truck for Inside Hung Motors.

a proportionately greater depth of section in the top members of the side frame, due to the overhang from the truss. The end braces also become necessary to support the end frames, which carry about 40 per cent of the dead weight of the motor. For trailer trucks the frames usually conform in general design to those of the motor trucks with which they are to be used.

#### Equalizers.

The chief advantages of the equalizers are a shorter truss in the side frame, a slightly added resiliency of the helical springs and diminution of frame height over the journal boxes which could be avoided otherwise only by a multiple of helical springs. The transfer of weight from one axle to another is entirely uninfluenced by them. Sometimes these equalizers are fastened rigidly to the journal boxes, but this is not good

\*Abstract of paper read before the Central Electric Railway Association at Indianapolis, Ind., March 26, 1908.

practice. The object sought is a prevention of spread of wheel base during brake application, which means a loss of brake piston travel. In a high-grade electric truck the journal boxes are accurately machined inside and outside, as are also the pedestal legs, and the clearances are small. Therefore the spread of the wheel base during braking is small. When the journal boxes are thrown out of alignment with the faces of the pedestal legs the riding qualities of the truck will be affected.

**Suspension of Motors.**

It is customary to carry about 60 per cent of the dead motor weight upon the axles and the remaining 40 per cent upon the frame. The ordinary types of motor suspension are the nose and bar supported by the transoms, for inside hung motors, and the bar and knee supported by the end frames for outside hung motors. Helical springs are usually interposed

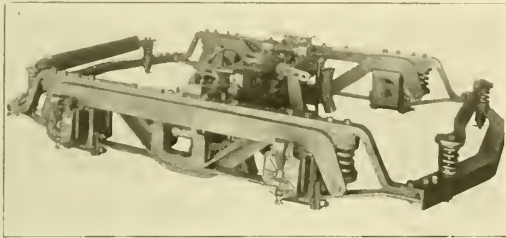

Electric Trucks—Figure 4—Truck for Outside Hung Motors.

between the motor nose and the suspension to minimize shocks, of starting and accelerating, relieving the helical truck springs of this particular function.

Upon the location of the motor suspensions with regard to the center of truck or of the axles, depends the amount of motor weight transferred through the frame from one axle to the other by the torque and the tendency of the motor to revolve upon the axle when brakes are applied. Let us assume a truck having a wheel base of 6 feet, carrying two motors inside hung, one upon each axle, and weighing 4,000 pounds each, of which 60 per cent is carried upon the axles and 40 per cent upon a suspension supported by the frame at a distance of one foot from the center of the truck. We know that frequently in starting the torque of the rear outside hung motor will lift its supporting nose free from the motor suspension. Let us assume that it does so in this case, then 1,600 pounds will be transferred from the rear motor suspension to the rear axle and a like amount will be transferred from the forward axle to the forward motor suspension. The total motor weight upon the frame will remain the same as it was before, but it will be differently distributed, and instead of 1,600 pounds supported each side of the transom at one foot from the center of the truck, we will have 3,200 pounds supported one side of the transom at one foot from the center of the truck and the frame will tilt in consequence.

Let us next assume a truck having a 6-foot wheel base also, and carrying the same motors as the previous truck, but having them outside hung with 40 per cent of the dead motor weight carried by suspensions supported on the end frames. In this case the transfer of motor weight will be from the rear axle to the rear motor suspension and from the forward motor suspension to the forward axle and, instead of 1,600 pounds of dead motor weight supported at each end of the frame, we will have 3,200 pounds supported at the rear end of the frame, and as this is supported outside of the spring base of the truck we will have a negative motor weight at the forward end of the spring base and a greater tendency of the frame to tilt than with the inside hung motors.

Tilting of the frame throws the pedestal legs out of vertical, impairing the riding qualities of the truck by reason of the added friction and shocks. Ordinarily, therefore, for inside hung motors the frame suspensions should be located as near as possible to the center of the truck and for outside hung motors as near to the center of the axle as possible.

**Brakes and Braking.**

In an ordinary 2-truck car which is not self-propelled the application of the brake results in a transfer of weight from the center plate of the rear truck to that of the forward truck, due to the brake pressure being exerted below the center of gravity of the car body and the consequent tendency of the car body to rotate about an axis at the center plate of the forward truck. In the same way, the brake pressure being ex-

erted below the center of gravity of the truck, each truck tends to rotate about an axis at the point of contact of its forward wheels with the rails—the rear wheels of the rear truck then will carry less weight during the braking period than any of the other wheels.

In the electric car with motors supported partly by the wheels and partly by the truck frames the dead weight of the motors is an additional factor, affecting the transfer of weight from one axle of the truck to the other. When brakes are applied to the wheels of the trucks the motors tend to revolve upon the axles and with inside hung motors part of the weight of the forward motor is moved forward from the motor suspension to the axle and part of the weight of the rear motor is moved forward to the motor suspension, increasing the rotative tendency of the truck, while, with outside hung motors, partly supported by the end frames, part of the weight of forward motor will be moved backward from the motor suspension to the axle and part of the weight of the rear motor will be moved backward, from the axle to the motor suspension, decreasing the rotative tendency of the truck. With inside hung motors, therefore, the shifting of weight from the rear to the forward axles of a motor truck is greater than the shifting which occurs in an ordinary car truck. With outside hung motors the shifting is less. Wheel base also is a factor involved with weight during braking; these conditions being less important, of course, with a long wheel base than with a short one.

With inside hung brakes the difference in weight upon the two axles of the truck during the braking period can partly be compensated for. Referring to the rear truck, which will be carrying the lighter load, the live lever end of the truck is always forward and the live lever hanger links are in compression.

By a proper inclination of these hanger links a toggle joint is formed and an increase of brakeshoe pressure upon the forward wheel results. This cannot be done with outside hung brakes.

Outside hung brakes, while more "getatable" than inside hung, are less desirable. During the braking period the hanger links of inside hung brakes oppose the tilting tendency of the frame, while those of the outside hung augment it.

In the case of an ordinary passenger car, not self-propelled, it is customary to use a calculated braking power of from 90 to 98 per cent of the light weight of the car. For motor-driven cars the energy exerted by the rotation of the armatures is taken into consideration and a much higher percentage is used, sometimes as high as 115 per cent.

Flanged shoes were first introduced for the purpose of keeping the flange of the wheel ground down to compensate for the wear of the tread. As the motors of electric trucks

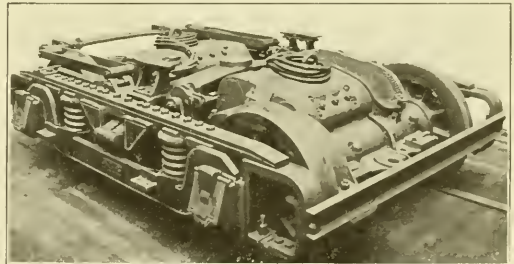

Electric Trucks—Figure 5—Motor Truck Design for 28,000-Pound Center Pin Loading.

usually prevent the use of brakebeams, these flanges are retained in electric truck practice as guides for keeping the shoes in line with the wheels. This is no doubt the simplest form of guide that could be devised for this purpose, but used without a brakebeam it contributes to the tendency of the brakes to chatter, making more careful manipulation of the brake necessary.

Chattering of brakes has given rise to various anti-chattering devices, some of them very good ones, but it would seem better to eliminate, if possible, the underlying causes, rather than to complicate the brake mechanism by additional parts. The Baldwin Locomotive Works is making a careful investigation of this question at the present time.

The side swing of a car can be limited in a variety of ways, but the usual, and perhaps the best, method is by expanding the energy in work performed in lifting the weight

of the car body. Generally, therefore, the truck bolster and the bolster springs are carried upon a spring plank, which is suspended from fixed points at the top of the transom by means of links called swing links, in such a manner that it can move sidewise only. Every side movement of this spring plank being attended by a lifting of the car body, the energy is expended in work, thereby limiting the amount of swing. Gravity acting upon the car body brings the spring plank back into place.

Inclining the swing links toward the center of the truck increases the height through which the car body is lifted per unit of side swing of the spring plank, thereby decreasing the amount of swing of spring plank. The car body is at the same time thrown out of its vertical and its swing becomes less than that of the spring plank itself.

The shocks which occur when bolster swing is limited by springs between bolster and frame are eliminated by this method.

#### Wheels.

While chilled cast-iron wheels are still used extensively in electric street railway service, solid forged steel or steel-tired wheels are now almost universally used upon interurban

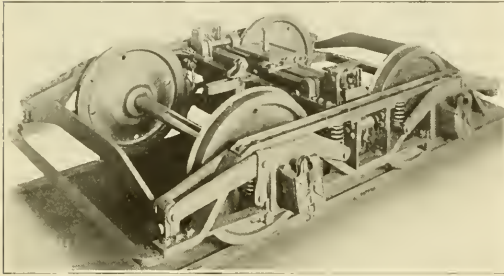

Electric Trucks—Figure 6—Recently Designed Truck with New Method of Suspension for Outside Hung Motors.

electric railways upon which the severity of the requirements has reached such a stage that chilled cast-iron wheels may no longer be considered even comparatively safe.

The most important requisites of a wheel are strength and durability, with a minimum of weight, and it is probable that the solid steel wheel will eventually replace the built-up wheel. The steel used in rolled and forged solid wheels is exactly the same as that used for tires of medium hardness and its method of manufacture seems to increase the density of the material.

Brakeshoes having unequal coefficients of friction will vary the flange wear directly; also indirectly through varying the diametrical wear of the wheel tread.

[The author then exhibited lantern slides illustrating a few of the designs of motor and trailer trucks built by the Baldwin Locomotive Works.—Eds.]

Figure 5 shows an inside hung truck, designed for a specified maximum center pin load of 28,000 pounds; wheel base, 80 inches; wheels, 34 inches in diameter; journals, 5 by 9 inches; brakes, inside hung; bolsters, cast steel.

Figure 6 shows a truck designed for Westinghouse 101-B motors, outside hung, and for a specified maximum center pin load of 17,000 pounds; wheel base, 54 inches; wheels, 33 inches; journals, 3½ by 7 inches; total weight, exclusive of motors, 6,100 pounds. The weight of this truck, exclusive of wheels, axles, brasses and wedges, is approximately only 2,600 pounds. The method of motor suspension has recently been patented by B. R. Van Kirk, mechanical engineer of the truck department of the Baldwin Locomotive Works. The motor weight upon the suspension is fulcrumed over the driving box and applied to the frame in an upward direction at a point near the center of the truck. This relieves the end frame of the motor weight and decreases the tilting effect of the motor reactions.

#### Maintenance.

The maintenance cost of a Baldwin truck should be small, but the old adage, "A stitch in time, etc.," holds good. The experience of more than three-fourths of a century of locomotive building has been applied to the design and construction of the trucks. The characteristics of the Baldwin locomotive are combined with the advantages of the M. C. B. running gear. The materials and workmanship conform rigidly to locomotive specifications.

#### ANNUAL MEETING NEW ENGLAND STREET RAILWAY CLUB.

The annual meeting of the New England Street Railway Club was held at the Hotel Somerset, Boston, on Thursday of the present week. The following officers were elected for the ensuing year:

President—Matthew C. Brush, vice-president and general manager Boston Suburban Electric Companies, Newtonville, Mass.

Vice-Presidents—W. D. Wright, master mechanic the Rhode Island Company, Providence, R. I.; C. H. Hile, assistant to vice-president Boston Elevated Railway; C. E. Hubbard, general manager Farmington Street Railway, Hartford, Conn.; J. Brodie Smith, general manager Manchester (N. H.) Street Railway; J. H. Foote, general manager St. Albans (Vt.) Street Railway; E. A. Newman, general manager Portland (Me.) Railway.

Secretary—John J. Lane, Boston.

Treasurer—N. L. Wood, Boston.

Executive Committee—Henry C. Page, vice-president and general manager Springfield (Mass.) Street Railway; Alba H. Warren, manager Brockton & Plymouth Street Railway, Plymouth, Mass.; George W. Palmer, Jr., Boston; Franklin Woodman, general manager New Hampshire Electric Railways, Haverhill, Mass.; George W. Knowlton, Boston; H. R. Luther, Cambridgeport, Mass.

Finance Committee—M. C. Brush, Newtonville, Mass.; J. F. McCabe, purchasing agent Worcester (Mass.) Consolidated Street Railway; E. P. Shaw, Jr., general superintendent Boston & Worcester Street Railway, South Framingham, Mass.

Matthew C. Brush, the newly elected president, is a well-known street railway man, being vice-president and general manager of the Boston Suburban Electric Companies, with office at Newtonville, Mass. Mr. Brush graduated from the Armour Institute of Technology in Chicago and from the Massachusetts Institute of Technology, Boston. He has had



Matthew C. Brush.

a broad steam railroad and steamship experience, together with street railway experience, for several years past. He was purser on the great lakes for the Northern Steamship Company for five years; machinist, foreman and roundhouse foreman on the Union Pacific Railroad at Omaha, Neb.; general foreman in charge of shops and roundhouses Chicago Rock Island & Pacific Railway in western Kansas. Mr. Brush commenced his street railway work in 1903, when he was appointed assistant to the president of the Boston Suburban Electric Companies. The following year he was made general manager of the Newton Lexington & Natick Railway systems and in 1905 was elected vice-president of the same companies. Mr. Brush has been very active in the New England Street Railway Club since he has been located in New England, serving on various committees of the organization. In 1907 he was elected vice-president.

The dinner, which was held at 6 o'clock in the evening at the Hotel Somerset, was presided over by Charles C. Peirce as toastmaster. Samuel L. Powers of Boston responded for the commonwealth of Massachusetts. No state, he said, is better served in the matter of transportation facilities and better relations are coming between the companies and the public. One-ninth of the entire wealth of the United States is invested in electric and steam transportation and fair legislation is imperative.



James F. Shaw, Boston, responded for the American Street and Interurban Railway Association. He discussed the objects of the national organization and emphasized the need for increased fares in New England if reasonable dividends are to be realized. The present franchise taxes and stock laws of Massachusetts are too severe for the necessary development of commercial industries in the state, he said.

T. E. Byrnes, vice-president of the New York New Haven & Hartford Railroad, Boston, then spoke on the need for broader co-operation between the New England people in the interest of better commercial development and the modernization of industry in that section.

George A. Post, president of the Standard Coupler Company, New York, was the last speaker of the evening and delivered a witty address.

During the meeting a standing toast was drunk to the recovery of Governor Guild of Massachusetts from his serious illness.

**TROLLEY WHEELS, HARPS AND POLES.\***

BY ADAM COLE, VAILE & KIMES COMPANY, DAYTON, O.

This subject is an important one in electric railway equipment and it is not receiving the attention it should. We manufacture the V. & K. Simpson's patent, oilless bearing trolley wheels. Thousands of dollars have been spent and

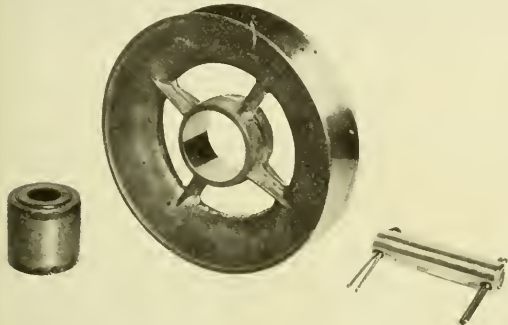

The Vaile & Kimes Trolley Wheel and Bushing.

hundreds of trials and experiments have been made by us. The oilless bearing feature was a success from the start, but the manner in which it was used in many cases proved that this feature was no advantage if not properly used. Our bearings are all made under one process, with no deviation whatever.

After sending out trial wheels reports came back that our wheels had made mileages which ran into thousands, and in numerous cases sounded ridiculous. Reports also came that our wheels had made but a few hundred miles, and were not suited for their work. No two systems of railways are the same, and conditions vary materially. A variation in mileage of from 3,000 to 36,000 miles set us to thinking and we immediately made an investigation to locate the trouble. We found that where the wheels had failed the trouble was due wholly to the harp.

We believe that every one present will agree that the spindle should fit as tightly as possible in the harp, and yet be capable of easy removal. In the past, if the spindle fitted tightly in the beginning, it was but a short time until the spindle, as well as the shell, began to show wear. This was caused by the constant hammering on the overhead wires. Our wheel was assembled in the harp with a loose-fitting spindle, and as our wheel had a greater conductivity than other wheels, an arcing took place, and hence the bearings were of short life. From our experience we believe that a good fitting spindle in the harp will increase the life of any wheel. It was not our intention to go into the harp business, but we were forced into it by the results of our experiments.

In assembling wheels in harps a hammer should never be

used. I have in mind a case where a new wheel was being placed on a car. The man who was doing the work simply threw the pole and wheel from the car to the ground and ruined the wheel. Many good dollars could be saved annually by dispensing with careless employes.

**Trolley Poles.**

A pole of a given length should be of uniform weight. A 12-foot pole should weigh, say, 22 pounds. If you place an order for 100 poles, each to be 12 feet long, and to weigh 22 pounds, a little care on the part of the manufacturers will assure delivery of poles weighing within a few ounces of the specified weight. At present poles will vary as much as six pounds.

In applying trolley poles to the car you may have the tension on the base set for 20 pounds. A new pole possibly weighs six pounds in excess, or one-fourth more, than the pole discarded. It is applied hurriedly, and when the car is a few miles away you receive a telephone message that the wheel will not stay on the wire. The wheel is then at once condemned, when the fault should be charged to the weight of the pole. Another matter of vital importance is that of a close fit between harp and pole. Did you ever see a harp that fitted tightly on the pole, or where there was a good contact? Too much stress cannot be laid upon the importance of this. Ordinarily, about all the contact you have is the rivets that go through the harp and pole. The loss of power is surely great. This evil can be remedied easily by having the end of the pole turned to a standard size, say for three or four inches. Then the harp should be bored and reamed to a standard size, say 1-64 inch larger. The ends of the poles should not be painted, but a grease of some kind should be used to prevent rusting, and the ends should be thoroughly cleaned before the harps are placed in position. It is a well-known fact that grease or oil is a non-conductor. By this method almost a perfect contact would be obtained at that point. Would the manufacturers of trolley poles do the turning? Manufacturers are usually willing to comply with reasonable demands from their customers, as the additional cost would be small. A hollow spindle lathe could be used, and what is known as a box tool, and the poles could be turned out as rapidly as two men could handle them. The users of poles could well afford to pay the additional cost.

Up to the base we believe every effort has been exercised to make the equipment almost perfect, but from the base to the overhead wire it has been sadly neglected.

Many electric roads have realized the importance of the standardization of their equipment as far as it is possible. A number of roads operate different lines, some as many as seven, and have almost as many sizes of wheels, harps and pins. The roads are now figuring what sizes will best suit the combined system and are adopting one size for all of the lines.

**Selection of Materials for Concrete.**

The importance of careful discrimination in the selection of materials for the making of concrete is forcibly shown by Leonard C. Wason, president of the Aberthaw Construction Company, Boston, in a recent paper, in part as follows:

"In the selection of sand care should be used to avoid that which is fine and not sharp. The difference in strength due to these qualities alone in some tests of the writer's on sand that was used in foundations amounted to a loss of 52 per cent from standard sand. Dirt should also be avoided. There has been some controversy as to how much can be permitted but the writer believes that the ordinary test which is performed on the work of throwing a handful into a glass of water is sufficiently reliable for all cases. When the water is badly muddied and remains clouded for a considerable time, the sand should be washed or rejected.

"There is little difference obtained in results of broken stone or gravel. By actual test the writer has found that a broken stone having a rough surface with angular fractures will give an increase in strength over a rough bank gravel of about 15 per cent in most cases. In some, however, the gravel has given the greatest strength. If the stone has a glossy surface, such as is found with some trap rocks, the gravel will always give the greatest strength. In the first instance, if the specifications required 1:3:6 broken stone concrete and there is a difference in cost between broken stone and gravel screenings of 0.02 per cubic foot, it will be cheaper to use a mixture of 1:2½:5 with gravel and still obtain an equal strength with the broken stone. The writer makes the rule never to allow the size of stone in its greatest dimension to be more than half the thickness of the work into which the concrete is to be placed. In large size work, very much larger stone can be used than is ordinarily done with very good results, the only limitation being that of convenience in handling."

\*Abstract of paper read before the Central Electric Railway Association at Indianapolis, Ind., March 26, 1908.

### MULTIPLE CAR OPERATION IN ST. JOSEPH, MO.

The St. Joseph Railway Light Heat & Power Company of St. Joseph, Mo., has had in service for several months 10 cars which are especially well adapted to their service requirements. Among other services the company does a large summer business in providing transportation facilities to amusement parks and resorts about St. Joseph, the most notable of which is located on Lake Contrary, where the company owns 230 acres of land on the east shore of the lake. At certain hours during the summer months the traffic becomes unusually heavy between the city and this park, and at all seasons of

open car bodies, mounted on Brill 22-E maximum traction trucks with forged steel frames, 33-inch driving wheels and 18-inch pony wheels. On each truck of these cars is mounted a G.E.-90 50-horsepower motor with a gear ratio of 4.06 to 1. During the past season 10 closed bodies were purchased by the company for its winter business, the same trucks being used under both open and closed bodies.

#### Electrical Equipment.

Both the open and the closed bodies are fitted complete with controllers, couplers and air brake equipment, so that the changing of bodies on the trucks requires only about an



Multiple Car Operation in St. Joseph, Mo.—Two Motor Cars Coupled for Multiple Operation.

the year the traffic during the morning and evening rush hours between St. Joseph and South St. Joseph, where the stock yards are situated, is unusually heavy.

With the growth of the popularity of these amusement parks and the increase in other traffic it became necessary to increase the facilities. Until the season of 1907 this was done by the use of dead trailers drawn by motor cars. Three and four trailers were frequently used in a train. To make

hour's time. Both bodies are fitted with the General Electric emergency and straight air brake equipment the two pipe lines running the full length of the car and being attached to coupler hose entering at the dash. The bodies are equipped with seven main power buses. The main motor circuits are tapped at the reverser and are brought into a 7-conductor cable which terminates at a 7-point coupler box located at the dash of the car. These coupler boxes enable a connection of

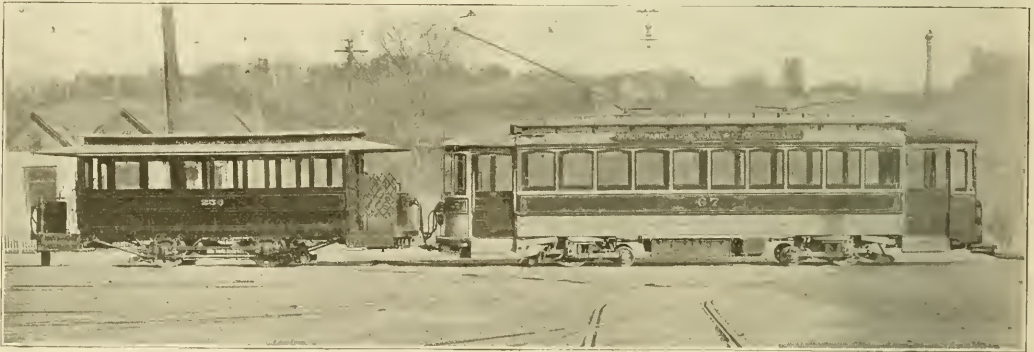

Multiple Car Operation in St. Joseph, Mo.—Motor Car Coupled to Live Trailer.

reasonable schedules under these conditions required the use of heavier motors than there was need for during the hours when the use of trailers was not necessary. To overcome this necessity for hauling about, wearing out and supplying current to heavy motors during the hours of light traffic, the company equipped a number of light trailer cars with second-hand G.E.-800 motors, equipped for multiple control train operation in connection with ordinary motor cars. Trail cars thus equipped are called "live" trailers. These "live" trailers are not provided with trolley poles, but take their power from the motor car ahead.

In the spring of 1907 the company purchased ten 12-bench

the new cars with "live" trailers equipped with motors, as already mentioned.

In addition to the 7-point coupler a 9-point coupler box is also provided on the dash, which makes it possible to connect together two of the new motor cars for regular multiple-unit operation, in which case each car takes its power over its own trolley. The controllers are of the Sprague C-6 type, made by the General Electric Company, and are for 4-motor control. Controllers are placed in both ends of the cars. The coupling arrangements for both air and current permit of flexible operation which has proved entirely satisfactory after a season's trial. It has resulted in a great

improvement in the schedules and a greater reliability of service. The company proposes to continue the use of this style of equipment in increasing its facilities and will probably so equip all its rolling stock.

The open car bodies which are used in summer are illus-

trated in one of the accompanying engravings. The underframe is of wood with longitudinal sills encased outside by a steel plate and on the inside and bottom by 3½ by 6 inch angles. The details of arrangement are shown in the drawing. The interior, seats and posts are finished in ash and the



Multiple Car Operation in St. Joseph, Mo.—Air and Coupler Attachments Between Two Motor Cars.



Multiple Car Operation in St. Joseph, Mo.—New Type of Motor Car as Used for Single Car Service.

trated in one of the accompanying engravings. The following are their principal dimensions: Length over vestibule fronts, 38 feet 10 inches; length over bumpers, 40 feet 2¾

inches. The Sterling-Meaker No. 12 printing registers used are operated by ringing rods supported on side brackets, the bell cord being carried on the

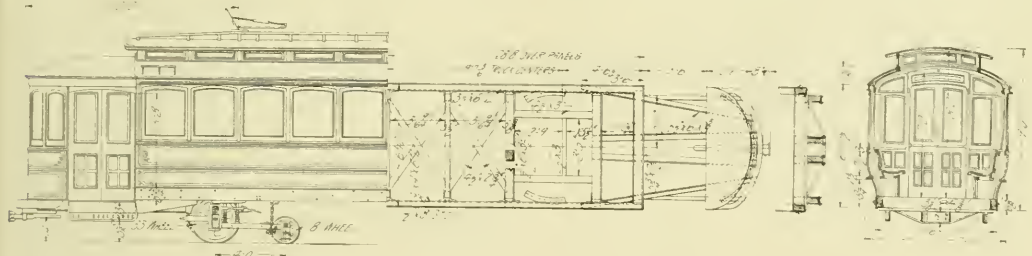

Multiple Car Operation in St. Joseph, Mo.—Plan Elevation and Section of Closed Car Body.

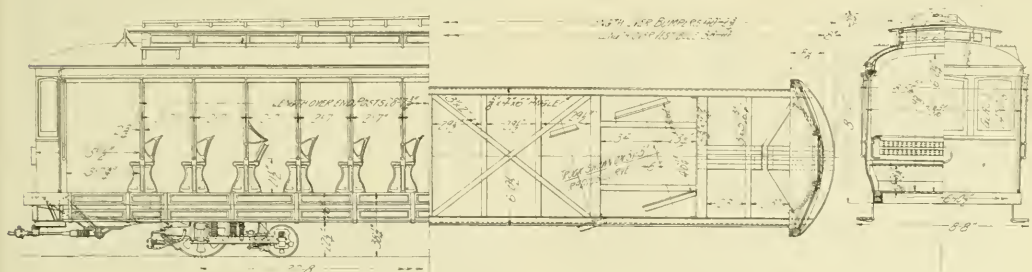

Multiple Car Operation in St. Joseph, Mo.—Plan Elevation and Section of Open Car Body.

inches; width of car over sill plates, 6 feet 10½ inches; width over posts at top of seat, 7 feet 8⅝ inches; width over running boards down, 8 feet 8 inches; sweep of post, 5 inches; height from bottom of sill to top of roof, 8 feet 11 inches; height

same bracket. Incandescent bulbs are used for lighting, the headlight and destination sign on the dash also being lighted by bulbs. Roofs are provided with eave troughs draining to down spouts at the corners to prevent dripping over the

running boards. The bench seats over the trap doors are pivoted to facilitate the repairing of motors.

**Closed Bodies.**

The 10 closed car bodies intended for use in winter service were delivered in September, 1907. They are illustrated herewith by reproduced photographs and drawings. The principal dimensions are as follows: Length over end panels or sills, 38 feet 10 inches; length over vestibule fronts, 40 feet 8 inches; length of platforms in the clear, 6 feet; length over bumpers, 42 feet; width over sills, 6 feet 11 inches; width over posts above belt rail, 7 feet 11 inches; width over all above belt rail, 8 feet 3 inches; sweep of posts, 6 inches; height from bottom of sill to top of roof, 9 feet; height from top of sill to inside of roof, 8 feet 2 inches; height from bottom of sill to under side of roof plates, 7 feet.

The cars have longitudinal seats, which are considered more desirable than cross seats because of the small width of the cars and the necessity for hauling heavy loads during the rush hours. The cars are finished inside with cherry, the headlining being 3-ply birdseye maple. The windows, sashes, sills, molding and frames are in cherry and the vestibules are wainscoted with ash. Central rod ringing devices supported on triangular brackets of special design are used, the bell cord as in the open cars being supported on the rod brackets. The same register is used as in the open bodies. The 6-foot vestibules are equipped with Brill patent folding doors on each side of each vestibule, giving an entrance at each corner of the car. Lighting is, as in the open cars, done by incandescent bulbs.

The cars herein described were built by the American Car Company of St. Louis, Mo. We are indebted to C. F. Hewitt, general superintendent of the St. Joseph Railway Light Heat & Power Company for drawings reproduced herewith.

**BORING ARMATURE BEARINGS.**

An efficient and inexpensive method for boring out armature bearings with an ordinary drill press is in use in the railway shops of the Quincy Horse Railway & Carrying Company, Quincy, Ill.

Each armature bearing is bored to a size that will fit each armature shaft.

This is done by an ordinary drill press with simple arrangement consisting of a boring rod turned down to fit the spindle socket of the drill, and a jig for holding the bearings. The jig is bored out to a size to fit the outside diameter of the bearing, which is held from turning by two set bolts. The flange of the jig is fastened by two bolts to a guide plate, in the center of which is a hole the size of the long boring rod and through which the rod passes. By this arrangement the center of the bearing is easily located.

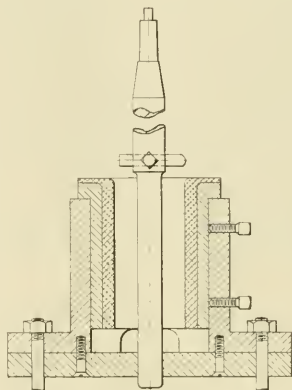

**Cross Section of Jig for Boring Armature Bearings.**

A. Johnson, master mechanic of this road, states that the device does the work just as well and as quickly as a more expensive and complicated machine and its simplicity makes it possible for anyone to do the boring.

**ELECTRIC RAILROADS IN INDIANA.**

The second annual report on the electric railroads of Indiana, compiled by the state statistician for the year ended June 30, 1907, includes data from 41 companies operating street and interurban roads, as compared with 32 companies for the year 1906. The number of miles of main track owned and operated in 1907 was 1,607, as compared with 1,112.66 owned and 1,286.73 operated in 1906. (Statistics compiled by the Indiana railroad commission, which were published in the Electric Railway Review of January 4, 1908, page 18, show 1,538.93 miles of interurban railroad, not including street railroads.) The gross earnings of street and interurban roads for the year were \$10,238,776.80, as compared with \$8,712,775.72 in 1906. A classification of the earnings and expenses follows:

	Earnings.	
	1907.	1906.
From passengers	\$9,080,872.26	\$7,411,693.36
From freight	389,052.69	527,612.05
From mail	5,471.28	4,501.39
From rentals	321,875.86	197,492.91
From all other sources	441,504.21	552,076.01
	Expenses.	
	1907.	1906.
Maintenance of way and structures	\$ 544,522.68	\$ 501,854.07
Maintenance of equipment	674,722.48	558,655.37
General expenses	310,698.57	1,260,533.76
Conducting transportation	2,964,573.48	2,517,547.28
Additions and betterments	806,242.21	702,866.02

The number of passengers carried by the street and interurban lines of Indiana during 1907 was 152,867,595, and the total number of tons of freight carried was 179,685.

**Compensation.**

The amount of wages and salaries paid to the various classes of officers and employes is shown in the following table:

	Number.	Total number of days employed.	Total yearly compensation worked.
General officers	106	3,467	\$233,428.56
Other officers	63	20,796	70,109
General office clerks	230	70,318	119,915.45
Station agents	202	68,290	69,371.74
Motormen	1,105	360,235	687,920.24
Conductors	1,061	358,423	668,820.26
Linemen	156	44,911	102,301.97
Electricians	271	45,864	84,026.64
Mechanics	372	115,110	254,046.27
Section foremen	169	57,447	116,369.05
Operators and dispatchers	60	21,659	42,225.23
All other employes and laborers	1,934	527,826	795,950.71

**Accidents.**

The persons killed or injured in accidents on the electric railroads of Indiana during the year are classified as follows:

	Passengers.	Employees.	All others.
Amount of damages paid during year	\$37,533.33	\$4,976.19	\$171,487.83
From causes beyond their own control—			
Killed	3	1	6
Injured	245	51	38
From their own carelessness—			
Killed	8	7	42
Injured	2,097	297	2,398

An electric railway system comprising 23 miles of track has recently been completed in Shanghai, China. The trackage has been divided into 11 sections, the first-class fare for traveling over any one of the sections being 2½ cents. The motormen and conductors will be Chinese, but twice during each journey a foreign inspector will visit each car. The terms of the concession permitting the construction of the road do not allow any exterior disfigurement by advertisements. Each car is divided into two compartments, which seat 12 first and 20 second class passengers, respectively. Notices in English, French and Chinese warn passengers against smoking or spitting and prohibit the carrying of dogs on the cars.

## MEETING OF THE NEW YORK RAILROAD CLUB.

The regular monthly meeting of the New York Railroad Club was held on the evening of March 20. As this was the fourth annual electrical night a programme was arranged consisting of several short talks by men who are authority on the subjects of electricity as applied to railway operation. About 600 members and guests were present; President Vreeland presided.

A description of the construction, signal installation and electrification of the tunnel systems of New York was presented with illustrative lantern slides by L. B. Stillwell, electrical director Interborough Rapid Transit Company; J. M. Waldron, signal engineer; and Hugh Hazleton, electrical engineer Hudson & Manhattan Railroad. Commenting on the advancement in transportation facilities in New York City, Mr. Stillwell said that between September, 1907, and February, 1908, there had been six tunnels completed and while there had been considerable progress in the development of construction and operation there was nothing radically new. The evolution of the small trolley car as first operated by electricity to a train of several cars operated as a unit marks a period of progress in the New York systems. He said the Interborough Rapid Transit Company, including both elevated and subway lines, made 326,357 car-miles a day, carrying 1,519,000 passengers daily. Mr. Stillwell's discussion of the Forty-second street tunnel of the New York & Long Island Railroad was accompanied by views showing a profile of the new tunnel as far as completed and the installation of the overhead contact rail and pantagraph. This contact rail weighing 20 pounds to the yard is hung from the top of the tunnel over the center of the track by means of an insulated bracket adjustable in four directions and supported at intervals of nine feet. On account of the slight clearance it was necessary to design a pantagraph occupying when in its lowest position but eight inches under the base of the contact rail.

To provide for the leakage or an extraordinary discharge of water in the East river tunnel of the Interborough company, sumps were constructed with a capacity of 50,000 gallons. Six electrically operated pumps of the Cameron type with a capacity of 600 gallons per minute are provided, which it is calculated will under any conditions keep the tunnel free from water.

Mr. Waldron in speaking of the new features of the signal apparatus in the East river tunnel said that the grades approaching the Manhattan and Brooklyn sides were 3.1 per cent and that blocks had been installed at intervals of sufficient length to permit a train to come to a full stop when traveling at the rate of 60 miles per hour. He said that the tunnel signaling was designed with a view to eliminating if possible the blocking of trains while in the tunnel, as each stop meant a loss of from 12 to 15 seconds, the time required to get under full headway again. An effort is being made to get the authority to install at the approaches of express stations a track indicator similar to the one in the Bowling Green station. If the authority can be secured it will permit of the operation of two additional express trains.

Hugh Hazleton in reviewing the Hudson tunnels said that by January 1, 1909, it was expected that 16 miles of the tunnels will be completed and in operation. Estimating the value of the East river tunnel as a means of relieving the congestion of the Brooklyn bridge during rush hours Mr. Hazleton said that the tunnel carried from one-tenth to one-sixth and the bridge about one-eighth of the total number of passengers crossing the river each day. A feature of the Church street and Hoboken terminals of the Hudson tunnels will be the method of loading and unloading the cars. It is arranged that all passengers getting off will go out one side of the car and the outgoing passengers enter from the opposite side. The protection board over the contact rail is of jarrah wood imported from Australia and, having a fiber much

harder than oak, is almost incombustible. A test of the jarrah wood, oak and pine was made to ascertain which, in case of fire in the tunnel, would resist combustion the longest. It was found that jarrah would withstand the flames of a blow torch 11 minutes, oak 8 minutes and pine 2 minutes, and that upon the removal of the torch the jarrah wood that had ignited would cease burning. Several views were shown and a description given of the new cars; also of the power house in Jersey City, which is now under construction and which will be equipped with two 3,000 and two 6,000 kilowatt turbines of the Curtis type.

W. J. Wilgus spoke of the operation of the New York Central electric zone since its completion last July, stating that all trains are now operated by electricity successfully both from an operating and financial standpoint. In a terminal like that at New York with electrical operation it is feasible to use other than ground surface, greatly increasing the value of the property. A considerable saving of money can also be made in lighting the yards and terminals, as where a power house is necessary for train operation current for lighting can be arranged for with little additional expense, and the saving in the New York Central zone for lighting of yards was placed at \$200,000 per year. Also a large power house provides cheaper current for labor-saving devices, such as motors for drawbridges, cranes, moving platforms, etc. Another economy in the substitution of electric for steam locomotives is the saving of power in hours when travel is very light. Mr. Wilgus said that in one yard he had in mind a saving of \$114,200 per year could be effected. Another feature of the electrically operated train was the substitution of automatic check devices for an additional motorman on the locomotive.

W. S. Murray, electrical engineer of the New York New Haven & Hartford, spoke briefly on the electrification work of the New Haven between Stamford and Woodlawn. He said the New Haven has ordered a few equipments to try out the multiple-unit control system.

George Gibbs, consulting engineer Pennsylvania & New York, read a paper referring to the many engineering problems in railway operation that had been successfully solved by the use of electricity as a means of power.

Walter C. Kerr of Westinghouse, Church, Kerr & Co. presented a paper describing the advancement that had been made in the electrification of trains or train signaling, in the course of which he said that he had wondered why more work in the application of electricity to the operation of trains had not been done. The one great drawback was first cost and the time had come to reduce this cost. He said in work of this character it was necessary to get good men on the job and then keep them there.

B. G. Lamme, chief engineer Westinghouse Electric & Manufacturing Company, gave a talk on the "Freight Locomotives for the Spokane & Inland Single Phase Railway." After reviewing briefly the nature of the roadbed, grades, lengths of hauls, etc., of the system, Mr. Lamme said that they had found in the type of locomotive first used on this line that the motor could not pull continuously a heavy train up grade on account of heating, but that, in new equipment built, motors of greater capacity were used, with the result that the desired operating features were obtained. A steam locomotive can develop a maximum continuous tractive effort, but the electric locomotive cannot stand continuous extra tractive effort, therefore the heating of the motor fixes the tractive effort of the electric locomotive. He said that the question of how long it will be until the steam locomotive is eliminated had come to his attention so many times that he had done some figuring on the matter and found according to his figures that if every railway were to begin now to do nothing else but build electric locomotives it would take from 10 to 20 years to replace the steam equipment, this not providing the increase in capacity during that time.

William McClellan of the Campion-McClellan Company said it had been proved that with the electric locomotive equipped with multiple control all work can be done that has formerly been done with the steam locomotive. He said that in the future development of electrification great problems would have to be overcome, but that no greater problems will have to be solved than have already been. Of the five systems—third-rail system, single-phase, three-phase, 1,200-volt direct-current and gasoline-electric systems—probably one of these would be better adapted to meet the requirements of certain sections, but in the electrification of a road the engineer, must stand far enough away to get a broad view of the entire subject and then install a type of electrification best adapted for the road's needs.

**SHOP WORK AT TAMPA.**

BY LEWIS P. M'ARTY, MASTER MECHANIC.

In the shops of the Tampa (Fla.) Electric Company we have lately installed for facilitating our repair work, two over-

cluding blacksmithing, drilling and erecting, and \$125 for iron.

Another illustration from a photograph shows a car body hoist which we built and which cost for timber, building and erecting about \$225. This cost included raising the track rails and building the pit and the adjacent concrete floors.

The existing posts in the shop that supported the roof were used and opposite these were set on 11-foot centers five other posts to carry the overhead runway. The track is 55 feet long and the stringers are 8 by 8 inches in section, with bolsters underneath. On top of these stringers are rails made of 5/8 by 2 inch iron. The carriage was made from an old truss taken out of a dismantled building. It is built of 4-inch angle irons and was cut to fit the span, which is 12 feet. The carriage is five feet wide and runs on 8-inch wheels having their journals in pieces of I-beams forming the ends of the

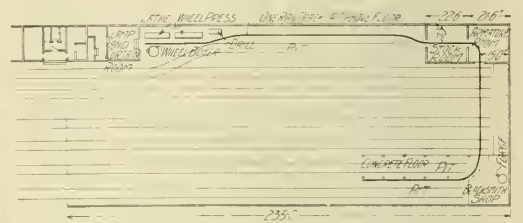

Tampa Shops—Plan Showing Location of Overhead Runway for Trolley Hoist.

carriage. Sections of 60-pound T-rails are laid across the top of the carriage supporting the two 5-ton chain hoists.

With this rigging two men have changed wheels in 1 3/4 hours, while with the old way it took four men to jack up the car and perform the same task.

Some of our standards and specialties are as follows: American inserted brakeshoe; Decatur car wheels, 20, 30 and 33 inches in diameter; 12-foot trolley poles with 22 pounds

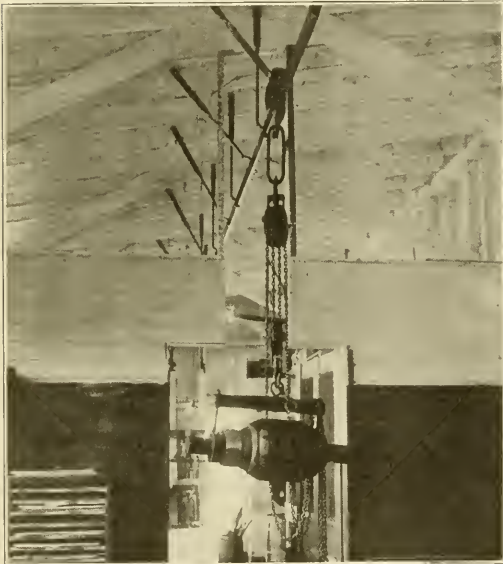

Tampa Shops—Traveling Hoist Carrying an Armature.

head hoists, one for raising car bodies and another system of traveling hoists.

One of the accompanying halftone engravings shows the first overhead hoist which we built. An illustration reproduced from a line drawing also shows the location of the supporting trolley rail for the hoist which serves the various departments of the shops and car house. The rail hung from the roof structure of the building is an iron bar 4 by 1 inch in section held in place by hangers and braces of 5/8 by 2 inch iron. The supports are six feet apart and between each pair of supports is a diagonal brace. The traveler which runs on this overhead rail carries the upper block of a set of differential pulleys and by means of this hoist and trolley heavy parts, such as wheels, axles, armatures, etc., can easily be lifted and transported between the various tools and parts of the building. The overhead structure is of sufficient capacity so that we can carry loads of about 2,000 pounds.

This very effective means for handling heavy material was built complete in our shops at a cost of \$80 for labor, in-

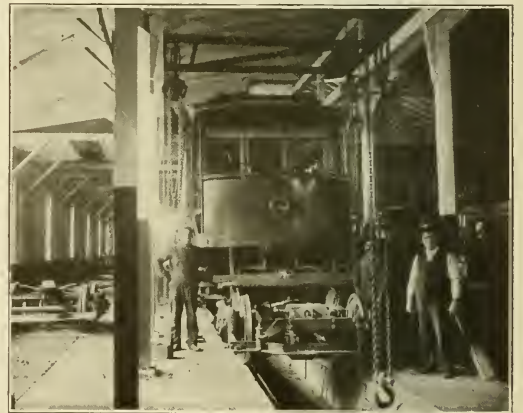

Tampa Shops—Hoist and Chain Blocks for Handling Car Bodies.

tension 16 feet from the rail, using 5-inch Kalamazoo wheels; body color, orange yellow, which is found very satisfactory for our local conditions, the paint and varnish being made by Lowe Brothers, Dayton, O. Castile soap only is used for washing cars. We find it very good practice to groove the armature bearing on the commutator end, thus keeping the oil from flowing out.

Our rolling stock comprises about 60 cars, four of which are of the Brill semi-convertible type.



## RECENT ELECTRIC RAILWAY LEGAL DECISIONS.

BY J. L. ROSENBERGER, LL. B., OF THE CHICAGO BAR.

**Liability for Injury to Person Going on Narrow Platform Between Tracks to Take Car.**

*Hunn v. City & Suburban Railway of Washington*, 28 Supreme Court Reporter, 63.—The supreme court of the United States says that at a point where it was customary to board the defendant's cars from a platform there were two tracks, running north and south. The distance between the inner rails of the two tracks was 7 feet, 10 inches, and between two cars when they passed, 3 feet, 6 inches. The plaintiff, who had come there, had come to a place where passengers had habitually boarded the defendant's cars. The defendant had encouraged and invited persons to enter its cars going south from the space between the tracks, by opening the doors and receiving them from that side. It was a place which, in itself, was perfectly safe, unless made otherwise by the manner in which the defendant used the east track for the passage of cars. The plaintiff, therefore, was not a trespasser nor a mere traveler upon the highway. It was not important to determine whether she had become a passenger. Intending to become a passenger, she had come to a place recognized by the practice of the defendant as a convenient and suitable one from which to enter the car, and the car stopped to receive her.

The defendant owed the plaintiff an affirmative duty. It was bound to use that care for her protection which was reasonably required in view of the situation in which she had, at the defendant's invitation, placed herself, of the purpose for which she was there, of the approach of the car which she was intending to enter, and of the dangers to be apprehended from contact with a rapidly moving car, propelled by mechanical power. A jury might well say that, under such circumstances, reasonable care demanded the exercise of the utmost vigilance, foresight and precaution.

The motorman of the northbound car could see plainly that the southbound car for Washington was about to stop, and that passengers were standing upon the space between the tracks, intending to enter it. He might readily have understood that the noise of the transit of the two cars would be commingled, and that those who intended to enter the other car would naturally direct their attention to it, and might fail to notice the approach of his own car. In point of fact, the motorman took no precaution whatever; he assumed that those who were standing on the platform would take care of themselves, and ran his car by them at full speed as if oblivious of their existence. The court thinks that from the evidence the jury might have found that the defendant was negligent.

Nor does the court think that it could be said, as a matter of law, that the plaintiff was guilty of contributory negligence. There was room to stand between the two cars and escape contact with either. But the margin of safety was narrow and left little allowance for the infirmities of mankind. In the confusion of two cars, approaching from opposite directions, it was too much to expect nice calculations of distances. It was not to be wondered at that in the attempt to escape the one, the plaintiff fell foul of the other. The court thinks that the plaintiff, if she was rightly where she was, was not, as a matter of law, guilty of negligence in failing to appreciate accurately the boundaries of the narrow zone of safety which the defendant's conduct had left to her. The 3-foot 6-inch width of the clear platform could not fairly be considered without taking into account the dangers which infested the borders upon each side.

The plaintiff was not necessarily wanting in due care by taking her place between the tracks. It was the usual place from which entrance to the Washington car was made. It was safe enough under ordinary circumstances. It was made unsafe only by reason of the defendant's negligent act in run-

ning another car rapidly by. The plaintiff had the right to assume that the defendant would not commit such an act of negligence, and that, when it stopped one car and thereby invited her to enter it, it would not run another rapidly by the place of her entrance and put her in peril.

Nor was it clear that, even if the plaintiff was not free from fault, her negligence was the proximate cause of the injury. If she carelessly placed herself in a position exposed to danger, and it was discovered by the defendant in time to have avoided the injury by the use of reasonable care on its part, and the defendant failed to use such care, that failure might be found to be the sole cause of the resulting injury.

**Passenger on Platform Falling Off After Opening of Door by Conductor.**

*Nirk v. Jersey City, Hoboken & Paterson Street Railway Company*, 68 Atlantic Reporter, 158.—The court of errors and appeals of New Jersey says that the plaintiff was a passenger on a closed trolley car with a high winter door on each side, extending from the platform to the top of the car. He stood on the rear platform. The car was running in an eastwardly direction in a street where there were parallel tracks. As the car was coming to a stop to let off some passengers, the conductor opened the door on the north side of the car, and in some manner the plaintiff fell off.

In affirming a judgment for the defendant, the court holds that a passenger standing upon the rear platform of a trolley car has no right to rely, in preserving his equilibrium, upon the protection of the closed door, and it is not the duty of the conductor to warn him before opening the door, suddenly, when it appears from the evidence that the passenger was not leaning against the door, and was not in such a position that the opening of the door required him to move or in any way interfered with him. Therefore a request to charge the jury that "a carrier owes to its passengers a high degree of care and the plaintiff in preserving his equilibrium had a right to rely upon the protection of the closed door, and it was the duty of the conductor to warn the plaintiff before opening the door suddenly," was properly refused, especially when it was reasonably to have been inferred from the evidence that there was room for the passenger inside the car.

Again, the court holds that when it does not appear that the door was maintained for the purpose of assisting passengers in preserving their equilibrium, but rather that one of its purposes was to allow ingress and egress of passengers, it was not negligence to open the door on the north side of the car to enable passengers to alight unless it was a dangerous place for passengers to get down. Therefore an instruction that "it might be a question whether the conductor would be negligent in opening the door on that side, unless it was in a place where it would be dangerous for passengers to get down; that would be the only reason that would make it negligent to do it at all"—was not erroneous, especially when the evidence was most persuasive, if, indeed, it did not compel the conclusion, that the place where the north door was opened was a safe place to alight, and that it would have been, on account of the snow, unsafe to have let the passengers out on the other side.

While it is not negligence per se (by itself) for a passenger to ride upon the platform of an electric street railway car, nevertheless a passenger who voluntarily rides upon the platform when there is room for him inside the car takes upon himself the duty of looking out for, and of protecting himself against, the usual and obvious perils attendant upon his position, such as the danger of being thrown from the platform by the ordinary jolting and swinging of the car.

It is announced that the Washington Baltimore & Annapolis Electric Railway will begin regular operation early in April on its line between Washington and Baltimore and on the branch to Annapolis. On the main line a 15-minute headway will be maintained.



# News of the Week

## Educating the Public by Bulletins.

"From Coal Pile to Car Wheel" is the title of Bulletin No. 6 of the series which the United Railways & Electric Company of Baltimore is publishing in the daily newspapers of that city in order to promote a clearer understanding of the company's business by the public. This bulletin describes briefly, in non-technical language, the methods by which the electrical current is generated and distributed and explains carefully the various steps in its course through transmission lines, substations, feeders and trolley wires before reaching the car motors.

To give an idea of the intricacy and extent of the power system it is explained that 780 miles of cable are necessary for the transmission and distribution of the current, in addition to over 400 miles of trolley wires and connections and the great amount of complicated machinery at the power houses.

The concluding paragraph is as follows:

"When you consider that the car service is interrupted in some sections of the city by a mishap to any one of these complicated parts, from the coil-hoisting buckets to the wiring and the motors in the cars, then you can form an estimate of the great care that has to be taken in the operation and maintenance of such a vast electric system."

## Transit Affairs in New York.

The forms of contract for the Brooklyn Fourth avenue subway were considered by the board of estimate and apportionment on March 20. The route, as laid out by the public service commission, extends from the Brooklyn terminal of the Manhattan bridge to Forty-third street, Brooklyn, and is divided into six sections. The matter was finally referred to a select committee, consisting of the comptroller, the corporation counsel and the chief engineer of the board, for the purpose of determining whether it would not be better, if the finances of the city will permit, to approve the forms of contract for only three of the six sections, providing for the construction of the route from Nassau street to Sackett street. The estimated cost of the entire route is about \$20,000,000. At a meeting on Monday of this week the committee decided to report in favor of letting contracts at once for the first two sections, extending as far as Flatbush avenue.

Justice Davis of the New York supreme court on March 16 sustained a claim for damages against the Manhattan Elevated Railway brought by property owners on account of the construction of a third track on the elevated structure in 1897 without their consent. The court awarded damages of \$30,000 and a rental charge of \$1,800 a year for six years. The company claimed that as the elevated structure had been in existence since 1880 and had been in continuous use for over 20 years prior to the bringing of the action in 1902, it had acquired an absolute right by prescription to the use of the structure. The court held, however, that as only two tracks were included in the original grant, the building of the third track in 1897 constituted an effective interruption of the original grant and defeated the claim of prescriptive right.

F. L. Fuller, president of the New York & Queens County Railway, has announced that plans have been drawn for a connection of the company's tracks with the Blackwell's Island bridge, and that it is proposed to carry passengers from the Manhattan terminal of the bridge to all parts of the borough of Queens for a 5-cent fare.

## Pay-As-You-Enter Cars in New York a Success.

The 155 pay-as-you-enter cars that were put in operation on Sunday, March 21, on the Madison avenue line of the New York City Railway have been pronounced an unqualified success by the company and have thus far met with the full co-operation of the public, although many had doubted the feasibility of adopting a service that would entail a delay in the seating of passengers. The situation was even more complex than in Chicago, where this type of equipment was first operated in the United States, owing to the fact that the people in New York City view a street railway corporation a little more critically than is usual elsewhere. In anticipation of possible difficulty in enforcing the new rules incidental to the operation of the pay-as-you-enter car the company stationed lawyers in a number of the courts in East Manhattan throughout the first day of operation to defend any of the employees who might be arrested for enforcing the rules. No disagreements occurred, however, that the conductors were not able to cope with.

On Monday, March 22, a very severe test of the new cars was experienced. During the evening rush hours, between

4 and 6 o'clock, the usual difficulty in handling the crowds was enhanced by a rainstorm, yet there was practically no delay in the movement of the cars. The fact that a passenger could obtain shelter from the rain by stepping onto the platform as soon as the car had stopped, instead of waiting for passengers to alight, doubtless tended to produce a favorable impression of the pay-as-you-enter feature. Another advantage was that the cars seldom stopped longer than was necessary to allow passengers to get on or off, thus reducing the running time. At the Grand Central station, Fifty-ninth street and the Brooklyn bridge terminal inspectors had been stationed to aid the conductors in handling the crowds. It was found that this was hardly necessary except at the Brooklyn bridge. At this point the motorman changes to the other end of the car and the doors are arranged preparatory to taking on the uptown traffic. While this was being done spectators crowded around the entrance of the car in sufficient numbers to interfere with the passengers who wished to board, so that few could get on before the conductor had given the signal to start. This temporary inconvenience will, of course, abate as soon as the curiosity of the public is satisfied.

The New York City Railway has adopted three new rules for the pay-as-you-enter cars which have not been attempted elsewhere. No more than 50 passengers are allowed to board the cars at terminals, no more than 75 passengers are permitted to be carried at one time, and smoking on the front platform is prohibited. In a few days, as soon as the public has become accustomed to paying fares on the platform, nickel-in-the-slot fare boxes will be installed. The Tec automatic fare register, which was described in the Electric Railway Review of January 4, page 32, is the type adopted.

Oren Root, Jr., general manager for the receivers of the New York City Railway, expressed his opinion of the new cars after the first day's operation as follows: "The operation of the pay-as-you-enter cars has proved an unqualified success. The commendation of the cars by the passengers, so far as I have been able to learn, has been universal. What has been claimed for these cars has been actually demonstrated. Two features of the day's operations are especially worthy of mention. First, the ease and pleasure with which the public grasped the new conditions, and second, the rapidity and lack of friction with which the people were handled at congested points. The possible criticism is the height of the steps, which I have arranged with our engineer to modify as rapidly as possible, so that they will be approximately the same height as those on the present equipment."

## Progress of the Cleveland Settlement Negotiations.

The representatives of the city of Cleveland and of the Cleveland Electric Railway have been engaged for several days in efforts to determine the final plans for the reorganization of the street railways. Aside from the valuation of the property, which has not yet been agreed upon, the principal points to be settled are the terms of the lease to a holding company, the plan of organization of the holding company and the terms of the security franchise. F. H. Goff and Mayor Johnson are acting as a committee on organization; Mayor Johnson, City Solicitor Baker and Secretary Davies of the Cleveland Electric Railway as a committee on the security grant; and Attorneys Westenhaver and Crawford as a committee on lease.

The tentative form of the security franchise which is to be granted to the Cleveland Electric Railway as a protection to the stockholders in case the holding company, which is to operate the lines after the settlement, should prove a failure, was published on Tuesday of this week. The ordinance provides for a new 25-year franchise, covering the entire Cleveland Electric system, in return for a surrender of the present franchises. After the settlement the security franchise is to be introduced into the city council by Robert Koch, chairman of the street railway committee, and when passed it is to be held in escrow by a trust company until the lease of the property to a holding company becomes operative. The ordinance provides for a 5-cent cash fare, with universal transfers, but the amount of the ticket fare is yet to be determined. The tracks in the downtown district are to be used jointly by another company at the discretion of the council. The right of purchase by the city at the end of the grant is reserved, provided the city has the power. The price may be agreed upon or may be fixed by arbitration at the cost of reproduction less depreciation, plus 10 per cent. The franchise is revocable in case its provisions are not complied with.

It has not yet been determined whether the Cleveland Electric Railway shall take over the Forest City Railway before the lease to the holding company, although it is understood that the two companies will be consolidated. Mayor Johnson has announced that the holding company will probably be called the "Cleveland Street Railway." It is understood that the holding company is to operate under the terms

of the security franchise, but at a rate of fare less than five cents, which will permit a return of 6 per cent on the investment. The plan of organization cannot be settled definitely until the stockholders' meetings of both companies are held. That of the Forest City Railway has been called for March 28 and that of the Cleveland Electric Railway for April 6.

The question of price is still to be determined. Mayor Johnson's estimate is \$41.75 per share for the stock after deducting indebtedness; Mr. Goff's latest offer is about \$12 higher, with additional claims for outlying franchises and good will. Mr. Davies has submitted an estimate of \$71 per share.

The personnel of the board of directors of the new company has been generally discussed in a tentative way and it has been suggested that both Mr. Goff and Mr. Johnson should be members. Mr. Goff, however, has announced that he would not accept.

The city council, at its meeting on Monday night, passed a resolution authorizing the board of public service to reconstruct the tracks on Central avenue and Quincy street in accordance with a suggested plan that the money should be borrowed from the Cleveland Electric Railway and the Forest City Railway, each company to operate one line. The Forest City Railway offered to lend the money for all or part of the work. The Cleveland Electric Railway has taken the matter under consideration.

#### Legislation Affecting Electric Railways.

**Massachusetts.**—The committee on street railways has reported to the house a bill providing that cities of over 75,000 inhabitants may grant street railways the right to carry freight by a two-thirds vote of the aldermen and the approval of the mayor.

**New Jersey.**—The house has passed the Martin bill, which provides for the establishment of a state public service commission similar to the New York commissions.

**New York.**—Assemblyman Wagner has introduced a bill amending the rapid transit act so as to give the public service commission for the first district power to acquire by purchase, with the approval of the board of estimate and apportionment, railways already constructed or in process of construction. Upon obtaining the required consents the public service commission may, with the approval of the board of estimate, enter into a contract for the equipment, maintenance and operation of the roads for a term of years, to be specified in the contract, not to exceed 25 years, with the privilege of a renewal for a like period.—Senator Frawley has also introduced a bill authorizing the city to purchase railways, providing that the city authorities shall make an agreement as to price with the owners. No provision is made for condemnation proceedings.—Comptroller Metz and John E. Eustis of the public service commission of the first district appeared before the judiciary committee on March 24 to advocate an amendment to the Elsberg law which will permit the construction of subways by private capital, also a bill to exclude bond issues for subway and dock construction from the constitutional debt limit.

**Ohio.**—Senator Lamb has introduced a bill conferring on the state railroad commission authority to require the installation of safety appliances at all crossings of steam and electric railways.—The senate has passed the Huffman bill, which requires interurban railways to equip their passenger cars with toilet rooms and provides a fixed fine per day for cars operated in violation of the law.

**Canadian Electrical Association.**—It has been decided to hold the annual convention of the Canadian Electrical Association this year at Toronto, Ont., on June 10, 11 and 12.

**Ordered to Remove Crossings with Steam Road.**—The Pennsylvania & Maryland Street Railway, operating between Meyersdale and Salisbury, Pa., has been ordered by the court to remove its rails and frogs from the tracks of the Baltimore & Ohio Railroad at three points where the lines intersect.

**Cars Must Stop at Crossings.**—The city council of Newcastle, Ind., has passed an ordinance requiring the Terre Haute Indianapolis & Eastern Traction Company to stop both local and limited cars at all street crossings when signaled by intending passengers. A penalty of \$10 is provided for violation of the ordinance.

**Attempt to Wreck Interurban Car.**—An attempt was made on the night of March 23 to wreck an interurban car of the Boston & Northern Street Railway near Saugus, Mass. The motorman discovered a pile of fence timbers and other debris on the track just in time to prevent an accident. Two men who are suspected have been arrested.

**American Institute of Electrical Engineers, Worcester Branch.**—At a meeting of the Worcester Polytechnic Institute

branch of the society, held in the Electrical Engineering building, Worcester, Mass., on Friday evening, March 27, Dr. Charles P. Steinmetz, consulting engineer the General Electric Company, delivered an address on "Electrical Conduction."

**Proposed Snow Removal Contract for Montreal.**—The Montreal Street Railway has submitted to the city council an offer to make a 10-year contract with the city under which the company agrees to remove the snow from the streets occupied by its tracks at a maximum cost of \$3,000 per year per mile, half the cost to be paid by the city, provided the city would provide dumping grounds.

**Not Required to Erect Shelter Stations.**—The Massachusetts railroad commission has declined to grant a petition of residents of Wellesley, Mass., that the Boston & Worcester Street Railway be required to erect two shelter stations on Worcester street, stating that only traffic conditions are a basis for requiring waiting stations. The commission suggests that the town furnish land and erect the shelters, on condition that the company light, heat and maintain them.

**Tax Case Before Supreme Court.**—The case of the city of St. Louis against the United Railways Company of St. Louis, involving the right of the city to impose a tax of one mill for each passenger carried, in addition to the usual car license fees, was argued before the United States supreme court this week. H. S. Priest represented the company. The federal court at St. Louis decided in favor of the company about two years ago, granting an injunction restraining the city from imposing the tax.

**Annual Convention Oklahoma Electric Light Railway and Gas Association.**—Announcement has been issued from the office of President F. H. Tidnam stating that the second annual meeting of the Oklahoma Electric Light Railway and Gas Association will be held at Guthrie, Okla., on May 25, 26 and 27, 1908. An exhibit of electric and gas appliances, the power for which will be furnished free to exhibitors, will form an interesting feature of the convention. An announcement of the programme will be made later.

**American Institute of Electrical Engineers Nominations.**—The board of directors of the American Institute of Electrical Engineers has selected the following nominees for the forthcoming annual election: President, L. A. Ferguson, Chicago; vice-presidents, C. C. Chesney, Pittsfield; Calvert Townley, New Haven; Hancock Gherardi, New York; managers, D. B. Rushmore, Schenectady; H. E. Clifford, Boston; W. G. Carlton, New York; C. A. Stone, Schenectady; treasurer, G. A. Hamilton, New York; secretary, Ralph W. Pope, New York.

**Indiana Rules Practically Finished.**—The committees which have been formulating train operation and maintenance of way rules for interurban railways of Indiana at the suggestion of the railroad commission of that state held a joint meeting at the state house, Indianapolis, on March 25. It has been decided to combine the rules in one book. The work of the committees has been practically finished. Copies of the rules which have been prepared will be sent to the various companies for consideration, and a short time later a conference will be called at the state house at which the rules will be discussed. As stated in the account of the meeting of the Central Electric Railway Association in another part of this issue, that organization took action concerning the rules.

**Western Society of Engineers.**—At a meeting of the Western Society of Engineers on Wednesday evening of this week, J. N. Darling, principal assistant engineer of the South Side Elevated Railroad, Chicago, presented a paper on "Some Features of the Construction of the South Side Elevated Railroad," which was illustrated by lantern slides. Mr. Darling outlined the recent construction and extension work of the South Side road and described in detail some of the difficult features of the reconstruction and third-tracking of the line between Twelfth and Forty-third streets. This work was described and illustrated in the Electric Railway Review of August 31, 1907, page 251. At the meeting on April 1 in the society rooms in the Monadnock block, Chicago, William M. Torrance will present a paper on "Reinforced Concrete Structures in the Hudson River Tunnel Work."

**Charter Forfeiture Suit Concerning New York City Railway.**—Paul D. Cravath, attorney for the New York City Railway and H. R. Limburg, special counsel for the attorney-general in the action brought to forfeit the charter of the company, have entered into a stipulation concerning the stock of the Twenty-eighth and Twenty-ninth Streets Crosstown Railroad. The agreement eliminates \$750,000 in the assets reported by the New York City Railway in the trial of the suit before Justice Davis of the New York supreme court. The stipulation says: "The lines of this company are entirely operated

by horse cars, and it has not thus far earned amounts sufficient to pay the interest on its funded debt, which interest has been paid by the New York City Railway in part. The deficit of this company for the year ended June 30, 1906, was \$51,819.78, after charging said interest. Total receipts from operation for that period were \$160,736.80. The above deficit does not include special franchise taxes in litigation. No dividends have at any time been declared on the stock of this company, and there have been no transactions in this company's stock. For the purposes of this trial it is stipulated that the stock of this company represents no actual cash investment, and has up to the present time had no market value."

#### DIRECTORY OF ELECTRIC RAILWAY ASSOCIATIONS.

American Street and Interurban Railway Association. Secretary, Bernard V. Swenson, 29 West Thirty-ninth street, New York.

American Street and Interurban Railway Accountants' Association. Secretary, Elmer M. White, 29 West Thirty-ninth street, New York.

American Street and Interurban Railway Claim Agents' Association. Secretary, B. B. Davis, claim adjuster Columbus Railway & Light Company, Columbus, O.

American Street and Interurban Railway Engineering Association. Secretary, J. W. Corning, electrical engineer Boston Elevated Railway, Boston, Mass.

American Street and Interurban Railway Manufacturers' Association. Secretary, George Keegan, 2321 Park Row building, New York, N. Y.

American Street and Interurban Railway Transportation and Traffic Association. Secretary, Bernard V. Swenson, 29 West Thirty-ninth street, New York.

California Electric Railway Association. Secretary, L. E. W. Pioda, Oak and Broderick streets, San Francisco, Cal.

Canadian Street Railway Association. Secretary, Acton Burrows, 157 Bay street, Toronto, Ont.

Central Electric Railway Association. Secretary, A. L. Neereamer, Indianapolis, Ind.

Central Electric Traffic Association. Chairman, A. L. Neereamer, Indianapolis, Ind.

Colorado Electric Light Power and Railway Association. Secretary, John F. Dostal, Denver Gas & Electric Company, Denver, Colo.

Electric Railway Shop Foremen's Association. Secretary, W. D. Bower, Public Service Corporation of New Jersey, Elizabeth, N. J.

Iowa Street and Interurban Railway Association. Secretary, L. D. Mathes, general manager Union Electric Company, Dubuque, Ia. Annual meeting Des Moines, Ia., April 23 and 24, 1908.

Massachusetts Street Railway Association. Secretary, Charles S. Clark, 70 Kilby street, Boston, Mass. Meetings held in Boston on second Wednesday of each month, except July and August.

Michigan Electrical Association. Secretary, A. C. Marshall, Port Huron, Mich.

Missouri Electric Light Gas and Street Railway Association. Secretary, Charles Z. Pierson, St. Charles Electric Light & Power Company, St. Charles, Mo. Annual meeting St. Louis, Mo., April 23, 24 and 25.

National Amusement Park Association. Secretary, C. H. Oberheide, Trenton, N. J. Annual meetings third Tuesday of each November.

New England Street Railway Club. Secretary, John J. Lane, 12 Pearl street, Boston, Mass. Meetings held on fourth Thursday of every month, Boston, Mass.

Northwestern Electrical Association. Secretary, Roger N. Kimball, Kenosha, Wis.

Oklahoma Electric Light Railway and Gas Association. Secretary, Galen Crow, Guthrie, Okla. Annual convention, May 23, 26 and 27, Guthrie, Okla.

Pennsylvania Street Railway Association. Secretary, Charles H. Smith, superintendent Lebanon Valley Street Railway, Lebanon, Pa.

Southwestern Electrical and Gas Association. Secretary, R. B. Stichter, Dallas, Tex. Annual meeting May 7, 8 and 9, El Paso, Tex.

Street Railway Association of the State of New York. Secretary, J. H. Pardee, 611 West One Hundred and Thirty-seventh street, New York N. Y. Annual meeting June 23 and 24, Niagara Falls, Ont.

Wisconsin Electric and Interurban Railway Association. Secretary, Clement C. Smith, president Columbia Construction Company, Milwaukee, Wis.

The electrified line of the Ohio Electric Railway between Lima and Defiance, O., formerly the Columbus & Lake Michigan steam road, will be put in operation about June 1.

# Traffic and Transportation

## Contest for Trademark Design.

The Cleveland Painesville & Eastern Railroad, Willoughby, O., has announced a contest for a design for a trademark. A prize of \$25 will be awarded for the most satisfactory design, which is to be selected by a committee of newspaper men. A circular signed by J. Jordan, the general manager, states that sketches must be on blank paper 8 by 11 inches, and that the designs should not be less than 6 by 8 inches. A number or initial should be enclosed in a sealed letter with each sketch as a means of identification after the contest is closed and the prize is awarded. All sketches and designs are to become the property of the railroad company. The name or initials of the company must be incorporated in the design.

Sketches will be received until May 4, 1908, by E. L. Schmock, assistant secretary and treasurer, Willoughby, O.

## Interchange and Joint Rates Ordered.

The interstate commerce commission, in a recent opinion rendered by Commissioner Harlan, announced its decision in the case of the Cedar Rapids & Iowa City Railway Company against the Chicago & Northwestern Railway Company.

This is a case where the commission ordered through routes and joint rates to be established between an electric railway company and a steam railroad company. It appeared on complaint of failure by the steam railroad company to establish through routes and joint rates with the electric line between interstate points on their respective roads, that the shipping communities at points on the electric line between Coralville, Ia., and Cedar Rapids, Ia., do not at this time enjoy the benefit of any reasonable or satisfactory through route from and to Chicago and other points reached by the defendant steam railroad company.

The commission held that through routes and joint rates thereover which shall not exceed by more than 10 per cent the class and commodity rates of defendant between Chicago and common points and Cedar Rapids, should be established and maintained for the transportation of interstate traffic from and to Coralville and on all other points on the electric line intermediate to Cedar Rapids and from Chicago and other points on the line of the steam railroad via junction point of the two roads at Cedar Rapids.

A former decision of the commission in regard to the Chicago & Milwaukee Electric Railroad (Electric Railway Review, January 4, 1908, page 24) was cited and affirmed and the distinction made between the transportation requirements of mere loading points serving one or more farms, as described in that case, and the more extensive requirements of small centers where general merchandising is done and the products of the countryside are concentrated for shipment, and coal, lumber and other commodities are brought in to supply local needs.

**Advance in Fares.**—The Portsmouth & Exeter Street Railway, Portsmouth, N. H., will advance fares to eight cents commencing on April 1. The reason given is that the company has accumulated a floating indebtedness of \$41,000 in the last five years.

**Illinois Tunnel Company.**—A circular issued by J. B. Russell & Co. of New York in relation to the property states that the following connections have been finished with railways: Atchison Topeka & Santa Fe, 2 in and 2 out bound; Baltimore & Ohio, 2 in and 2 out bound; Chicago & Alton, 1 in and 1 out bound; Chicago Burlington & Quincy, 4 in and 1 out bound; Chicago & Erie, 1 in and 1 out bound; Chicago & Eastern Illinois, 2 in, and 1 out bound; Chicago Great Western, 1 inbound; Chicago Milwaukee & St. Paul, 1 in and 1 out bound; Chicago Indianapolis & Louisville, 1 in and 1 out bound; Chicago & Northwestern, 2 in and 2 out bound; Chicago Rock Island & Pacific, 1 in and 1 out bound; Illinois Central, 2 in and 2 out bound; Lake Shore & Michigan Southern, 1 in and 1 out bound; Michigan Central, 4 in and 2 out bound; New York Chicago & St. Louis, 1 inbound; Pittsburg Cincinnati Chicago & St. Louis, 2 in and 2 out bound; Pittsburg Ft. Wayne & Chicago, 2 in and 2 out bound; Wabash, 2 in and 2 out bound; Wisconsin Central, 1. The circular adds: "The connections made with the six passenger terminals gave the company an opportunity to accept a contract from the government to handle United States mails to and from the stations and the postoffice, as well as the through mails east and west, which are transferred from station to station. This tonnage has averaged a little over 1,000 cars per day, the handling of which is recognized to have been practically perfect."

# Construction News

## FRANCHISES.

**Bellefontaine, O.**—The city council has granted the Ohio Electric Railway a 20-year franchise for an entrance to the city for its Lima-Bellefontaine line.

**Birmingham, Ala.**—The Birmingham Railway Light & Power Company has been granted an extension of one year in which to build proposed street railways on various streets in Birmingham.

**Chicago, Ill.**—The South Side Suburban Railway has applied for a 50-year franchise for an electric railway from Chicago Heights to a connection with the South Side Elevated Railroad at Sixty-third street and South Park avenue, Chicago, through Thornton, Dolton, Fernwood, Roseland and West Pullman. Between Seventy-fifth and Sixty-third streets the road is to be elevated. The road will occupy a private right of way; the franchise is asked to permit the crossing of streets and alleys. C. C. Heisen, S. A. Foster and Cornelius J. Ton are interested.

**Dallas, Tex.**—The Dallas Interurban Electric Railway Company has asked for an extension of two years in which to begin work on the construction of its proposed system of local and interurban lines. The present franchise expires on April 1, 1908. Under the new franchise the company must have 30 miles of track laid by December, 1910. The company was incorporated by local men several months ago to build 30 miles of street railway in Dallas and interurban lines from Dallas to Sherman, Denison, Greenville, Terrell and Tyler, Tex. A portion of the right of way has been secured and preliminary surveys made. Henry Dorsey, president, Dallas, Tex. (Noted February 22.)

**Klamath Falls, Ore.**—W. H. Mason, representing the Inland Electric Company, has applied for a franchise to build an electric railway from the eastern city limits of Klamath Falls to the terminus of the Klamath Falls Land & Transportation Company's line at Morrill, Ore., 25 miles.

**Mincola, N. Y.**—The South Shore Traction Company, Patchogue, N. Y., has received an extension of one year in which to complete the construction of its line through Nassau county.

**North Adams, Mass.**—The Berkshire Street Railway has presented five petitions to the North Adams common council asking permission to extend its lines in the city. The company desires to build two stretches of track serving the north section of the city, to double-track Main street, to build a new route for freight carrying purposes on the north side of the city and to build a line down River street for the same purpose. A hearing will be given on April 7, and there is said to be little doubt but that all the petitions will be granted.

**Ogden, Utah.**—The Ogden Rapid Transit Company has applied for a franchise to lay its tracks in Wall avenue, agreeing to have the line in operation within a year.

**Shreveport, La.**—John Lorenz, president of the recently incorporated Shreveport Suburban Railway, which will be built from Shreveport, La., to Marshall, Tex., has been granted a franchise in Shreveport. (Noted February 29.)

**Springfield, Ill.**—The Springfield Consolidated Street Railway has applied for a new franchise in place of its present franchises, which expire at different times, and has agreed to build the Eighth street subway, which the city desires, in return.

**South Bend, Ind.**—The Indianapolis Logansport & South Bend Traction Company has petitioned the county commissioners of St. Joseph county for a franchise to operate over the Michigan road instead of paralleling the Vandalia line. S. S. Perley, South Bend, Ind., is president. (Noted October 26, 1907.)

**Toledo, O.**—The city council has defeated an ordinance granting a 6-year franchise to the Toledo Fostoria & Findlay Railway for its entrance to the city. The franchise was for a distance of but two blocks, and as the company owns the right of way the grant applied only to two street crossings.

**Washington, D. C.**—The house has passed a bill extending for 12 months the time allowed the East Washington Heights Traction Company in which to begin construction of its line.

**Wenatchee, Wash.**—The Seattle Electric Company has applied for a franchise for an electric railway on Wenatchee avenue. It is stated that a line from Wenatchee to Leavenworth is contemplated.

## RECENT INCORPORATIONS.

**Cherokee Belt & Interurban Railway, Tulsa, Okla.**—Incorporated in Oklahoma to build an electric railway from a point on the Midland Valley Railroad to a connection with the Missouri Kansas & Texas Railway, serving Collinsville and other points in northeastern Oklahoma and passing through the counties of Craig, Tulsa, Rogers and Myers. Capital stock, \$500,000. Incorporators: F. E. Montee, Kansas City, Mo.; C. W. Butterworth, Tulsa; J. R. Caudley, E. Pease and A. E. Leawe, Collinsville, Okla.

**Gallatin Valley Electric Railway.**—Incorporated in Montana to build an electric railway 26 miles long, from Bozeman, Mont., to points in the farming districts of that section. Incorporators: W. S. Hartman and C. D. Hartman, Bozeman, Mont.; and C. H. Winfree, Spokane, Wash.

**Goose Creek Railway & Power Company, Jesup, Ga.**—Incorporated in Georgia to build an electric railway and power plant. Capital stock, \$500,000. Incorporators: D. M. Clark, Jesup, Ga.; D. G. Zeigler, Columbia, S. C., and others. (Noted February 15.)

**Rural Electric Railway & Power Company.**—A bill has been introduced in the Maryland senate incorporating this company to build an electric railway from Lauraville, Md., to the Falls road at or near Belvidere avenue, and from Baltimore to Sparrows Point by way of the North Point road, with extensions as desired. Capital stock, \$500,000. Incorporators: Hugh J. Gallagher, Walter & Kephart, W. T. Dietrick, Dr. Harry C. Hess, Robert W. Mowbray and Jacob S. Parr.

**Short Line Terminal Company, Baltimore, Md.**—This company has applied to the Maryland legislature for a charter to build an independent terminal line in Baltimore for the Baltimore & Annapolis Short Line, which is owned by the Maryland Electric Railways Company. Construction is said to have been started from Clifford station to the city. Incorporators: John Wilson Brown, Baltimore; Shellman B. Brown, Arthur D. Foster, Daniel R. Radall, J. Winfield Henry.

## TRACK AND ROADWAY.

**Albany (Ore.) Street Railway.**—It is announced that this company's 4-mile horse car line will be converted for electrical operation within 60 days. Work has already been started. Power will be purchased. J. E. Ross, general manager.

**Albia (Ia.) Interurban Railway.**—This company is reported to be in the market for rails, ties and trolley wire for the construction of a half-mile extension. J. P. Reese, president, Albia, Ia. (Noted January 11.)

**Augusta & Columbia Railway, Augusta, Ga.**—Construction work on this line, which will afford connection with Aiken and Columbia, S. C., was started last week at a point just beyond the North Augusta bridge. A contract for a portion of the construction work has been awarded and it is understood that a large force of men will be added to the force now at work and construction pushed as rapidly as possible. James U. Jackson, Augusta, Ga., president. (Noted March 14.)

**Berlin & Bridgeport Electric Street Railway.**—During the present year this line will probably be extended through Bloomingdale, New Germany, Conestoga, Winterbourne and West Montrose, connecting with the Guelph & Goderich Railway.

**Boston Elevated Railway.**—Construction work has been started on the elevated car storage yard near Forest Hills. The yard will be located on private land owned by the company at the intersection of Washington street and the Arborway, and the lead tracks of the yard will be extended from Washington street in a double line for a distance of about 1,000 feet. The land provides for the construction of storage tracks 500 feet long, if necessary, and the property is extensive enough to care for the extra cars required by the business anticipated for the Forest Hills extension of the elevated structure. In connection with the completion of the main line structure, which now ends at a point about 150 feet short of the Arborway, excavations have been made for the foundation posts needed in the connection with the terminal and storage yard. At Dudley street the extra spans of steel to support the new third track have been placed in position. This extra track will be used for handling trains in and out of the Guild street car house after the two main tracks have been turned over to the Forest Hills service. Steel for platforms, passages and stairways at the Eggleston square station is now in place.

**Branford & Hamilton Electric Railway, Hamilton, Ont.**—The line between Branford and Hamilton is now practically completed and it is expected that it will be in operation before the end of May. W. C. Hawkins, general manager.

**Charlotte Electric Railway Light & Power Company, Charlotte, N. C.**—Announcement is made that a 1½-mile extension of this company's line will be built through Belmont, N. C., by the Charlotte Consolidated Construction Company.

**Connecticut Company, New Haven, Conn.**—It is stated that work will be resumed this week on the Stafford-Rockville electrified division of this company's lines and that it will be ready for operation in May. The most important work remaining to be done is the completion of the bridge at Stafford Springs and the leveling of the tracks in Rockville. It is understood that through cars will operate from Stafford to Hartford, using the tracks of the Hartford Manchester & Rockville Tramway Company from Rockville.

**Decatur, Ind.**—M. M. Lacey, Fountain City, Ind., is said to be interested in a project to build an electric railway between Decatur and Richmond, Ind.

**Hattiesburg (Miss.) Traction Company.**—Negotiations are said to have been closed by this company for a \$200,000 bond sale, the proceeds of which will be applied toward the extension of its street railway from the business to the residence district, and for the construction of a large power plant. C. Z. Stephens, general manager, Hattiesburg. (Noted August 3, 1907.)

**Illinois Traction System, Champaign, Ill.**—L. E. Fischer, general manager, has announced that the line from Springfield to Jacksonville, Ill., on which considerable grading was completed last year, will not be built this year, because of the financial situation.

**Interurban Construction Company, Denver, Colo.**—It is reported that this company has made financial arrangements for beginning the construction of its line from Denver to Greeley, Colo. Surveys have been made and much of the right of way has been obtained. The main line parallels the Platte river the entire distance. Construction is to begin at once on a branch line from Ft. Lupton to Longmont, passing through a coal field in which the power house will be located, at Fireston. It is proposed to begin construction on the main line by June 1.

**Missouri & Kansas Interurban Railway, Kansas City, Mo.**—W. B. Strang of the Strang Gas-Electric Car Company, New York, has announced that this line from Kansas City, Mo., to Olathe, Kan., 22 miles, will be converted for electrical operation. The road is now operated by Strang gasoline-electric cars, which will still be used to furnish an auxiliary service.

**Morrisburg (Ont.) Electric Railway.**—This company is planning the construction of an electric railway from Morrisburg, through Williamsburg, Winchester, Chesterville and Morewood to Russell, with a branch line to Winchester village, and an application is to be made to the Ontario legislature for a charter. I. Hilliard of Morrisburg, Ont., is acting for the applicants.

**Nashville Interurban Railroad, Nashville, Tenn.**—President H. H. Mayberry has announced that construction work on the electric railway to Mt. Pleasant, Tenn., which was suspended in January, will be resumed the first week in April. (Noted January 18.)

**Omaha and Council Bluffs Street Railway, Omaha, Neb.**—Surveys are now being made over several routes for the proposed extension to the Iowa School for the Deaf.

**Pacific Electric Railway, Los Angeles, Cal.**—The overhead construction is now being erected on the line between Riverside and Crestmore, Cal. Grading is also in progress on the line from Riverside to Colton. Garney & Pitter are the contractors.

**Pana Girard & Jacksonville Railway.**—This company has been organized to build an electric railway from Pana to Jacksonville by way of Girard, Ill. B. F. Danielli, J. M. Anderson, W. F. Bercher, Springfield, Ill.; John J. Stowe, Girard; Charles E. Sargent, Greenfield, Ill., are interested.

**Pittsburg Harmony Butler & New Castle Street Railway, Pittsburg, Pa.**—Orders have been issued to the construction forces to work night and day in order to complete the line between New Castle and Harmony by June 1. The track has been laid, the poles have been erected and the power house at Eidenau is already in operation, furnishing power for lighting. Owing to the destruction by floods of the false work for the bridge at Ellwood City the section from Harmony to Pittsburg will not be completed until about the middle of summer. James Bryan, chief engineer, Pittsburg.

**Pittsburg, Pa.**—Robert A. Carter, president of the Carter Iron Company, is interesting the Pittsburg chamber of commerce in a plan to build elevated railway tracks on the Smith-

field street bridge and to construct a loop system of elevated lines in the downtown district.

**St. Matthews, S. C.**—An electric railway from St. Matthews, S. C., to the Congaree river is being promoted by D. G. Zeigler & Co. of Columbia, S. C., and Atlanta, Ga., engineers. A. R. Able, J. A. Banks, J. S. Wannamaker and others of St. Matthews are interested.

**Salt Lake & Ogden Railway, Salt Lake City, Utah.**—It is stated that this company will have its line ready for electrical operation in time to care for the summer tourist business. Until the company builds a plant of its own power will be purchased from one of the independent companies in Salt Lake. From the terminus of the road at Lincoln and Twenty-fifth streets the company will operate an automobile line to Ogden canyon, a summer resort. Simon Bamberger, president, Salt Lake City.

**Seattle (Wash.) Electric Company.**—In regard to recent reports that this company proposed to make extensive improvements and extensions, H. F. Grant, manager, advises us that the company is not contemplating any extensions, improvements or additions to the system during 1908, owing to the stringent financial conditions prevailing.

**Taylorville, Ill.**—W. B. Adams of Taylorville is said to be interested in the construction of an interurban line from Mt. Auburn to Taylorville, Ill. Residents along the proposed route are asked to subscribe \$5,000 for the preliminary work.

**Taylorville Street Railway Light Heat & Power Company, Taylorville, Ill.**—This company has been organized to build an electric railway and power plant in Taylorville, Ill. I. J. Perkins, Albert Morgan, J. A. Adams and others are interested.

**Texas Traction Company, Dallas, Tex.**—President J. F. Strickland has recently issued a statement in regard to the progress of the road between Dallas and Sherman, Tex., in which he states that the road will probably be in operation in June. The grading is practically completed, the bridge and trestle work is nearly finished, 32 miles of track have been laid and 25 miles of poles have been erected. All of the rails have been delivered and much of the material for the overhead work. Most of the equipment has been installed in the power house at McKinney and the four substations will be completed early in April. F. A. Jones, chief engineer. (Noted March 14.)

**Washington Railway & Electric Company, Washington, D. C.**—A bill has been introduced in the house of representatives authorizing this company to lay a double-track extension serving the section between Fourteenth street on the east and Connecticut avenue on the west in Washington, D. C., the extension to be completed within a year.

**Waterloo Cedar Falls & Northern Railway, Waterloo, Ia.**—It is stated that this company expects to extend its lines to Westfield and other outlying districts of the city, connecting them with the business district and completing a loop between the west side loop and the Cedar Falls line on the north. The improvements will cost about \$75,000. C. D. Cass, general manager, Waterloo. (Noted February 22.)

**Windsor Essex & Lake Shore Rapid Railway, Windsor, Ont.**—W. C. Crawford, first vice-president, states that the extension from Kingsville to Leamington, Ont., 10 miles, will be ready for operation about April 15. It is proposed to extend the line an additional 20 miles to Tilbury during the present year under the charter of the Windsor Chatham & London Railway and to ultimately extend the line to Chatham.

**Youngstown & Ohio River Railroad, Youngstown, O.**—Construction has been started on the 6-mile line between East Liverpool and West Point, O., which will complete the line from Youngstown to East Liverpool.

#### POWER HOUSES AND SUBSTATIONS.

**Hattiesburg (Miss.) Traction Company.**—Announcement is made that this company has completed plans for the construction of a power plant to furnish power for the operation of its proposed street railway system in Hattiesburg. C. Z. Stephens, general manager. (Noted August 3, 1907.)

**Nashville (Tenn.) Railway & Light Company.**—A new 3,000-kilowatt turbo-generator has recently been installed.

**Olio Electric Railway, Cincinnati, O.**—Rapid progress is now being made on the construction of a combined substation and depot at Leipsic, O.

**Shamokin & Mt. Carmel Transit Company, Shamokin, Pa.**—This company proposes to build an addition to its power station, 40 by 75 feet. A 750-horsepower Corliss-Cooper engine and one 500-kilowatt General Electric generator will be installed. E. W. Samuel, president and general manager, Mt. Carmel, Pa.

## Personal Mention

Dr. H. C. Harrison has been appointed chief surgeon of the United Railways & Electric Company, Baltimore, Md., succeeding the late Dr. I. R. Trimble. Dr. Harrison has been on the surgical staff of the company for a number of years.

The recent appointment of Mr. Arthur L. Linn, Jr., as general auditor of the Schenectady Railway on March 2, 1908, places him in charge of the accounting of all of the railway and lighting companies in which the Mohawk Valley Company is interested, in addition to which he is either the secretary or assistant secretary of 15 of the 19 companies. Mr. Linn's office is located in the Night and Day Bank building, New York City.

Mr. Frank R. Henry has resigned as president of the American Street and Interurban Railway Accountants' Association. As stated in last week's issue of the Electric Railway Review, Mr. Henry has resigned as auditor of the United Railways Company of St. Louis to become vice-president and secretary of the Majestic Manufacturing Company of St. Louis. Mr. Henry felt that his new duties would require his undivided attention for some time and that therefore in justice to the association and the success of its next annual meeting he should resign.

Mr. Lester G. French, formerly editor-in-chief of Machinery, has been appointed to take charge of the editorial work of the American Society of Mechanical Engineers. An improvement is to be made in the monthly "Proceedings" of the society by establishing departments, thus providing a greater variety of technical articles. All such articles, however, will first be presented and discussed before the society at its meetings, as before. Mr. French is a graduate of the Massachusetts Institute of Technology and has written several text books on mechanical subjects.

Mr. F. F. Barbour, who was recently appointed assistant to President B. S. Josselyn of the Portland (Ore.) Railway Light & Power Company, has been for several years manager of the sales department of the General Electric Company at San Francisco. He was born in Boston, Mass., and was educated in the public schools of Cambridge, Mass., and the Massachusetts Institute of Technology, class of 1887. After three years in civil engineering work in Minnesota, Dakota and Illinois in connection with steam railway construction he began electrical work with the Thomson-Houston Company, Lynn, Mass., in the railway construction department. While in this department he was connected with the electric railway lines at Louisville, Ky., Topeka, Kan., and for a year was at Denver, Colo., installing equipment for the Denver City Tramway. From Denver he went to California as engineer of the San Francisco office of the Thomson-Houston Company, remaining in that position for a number of years. He was then transferred to the selling organization, and for several years past has been manager of the sales department of the General Electric Company at the San Francisco office. During his association with the General Electric Company in California, he contracted for the first three-phase long-distance transmission system on the Pacific coast, at Redlands, Cal., which is now a part of the system of the Edison Electric Company of Los Angeles.

Mr. D. S. Carl, who recently was elected second vice-president and general manager of the Capital Traction Company, Washington, D. C., as announced in the Electric Railway Review of March 21, was born in 1855 at Huntington, L. I. He graduated from the Huntington Union School in 1875 and immediately engaged in surveying work, from 1877 to 1881 being surveyor to the commissioners of highways of Huntington, N. Y., and later assistant engineer in charge of construction of seven miles of the Long Island Railroad's line from Patchogue to Eastport, N. Y. From September, 1881, to May, 1883, he was assistant engineer in charge of construction of eight miles of the New York West Shore & Buffalo Railway in Ulster county, New York. From 1883 to 1887 he served in the department of public works, New York City, as leveler and later as transitman on surveys, borings, etc., for the new aqueduct and reservoirs. In March, 1887, he went to Kansas City, Mo., as assistant engineer of construction for the Grand Avenue Railway. While in Kansas City he served for a time with the Metropolitan Street Railway and was assistant engineer for the firm of Knight & Bontecou of that city. From October, 1889, to September, 1890, he was superintendent of grading and construction in the city engineer's office at Kansas City, resigning in November, 1890, to become assistant engineer, with entire charge of constructing the cable system for the Washington & Georgetown Railroad, Washington,

D. C. In 1892 he was appointed chief engineer and in 1895, when this company and the Rock Creek Railway of the District of Columbia were merged by a special act of congress into the Capital Traction Company, Mr. Carl, in addition to his duties as chief engineer, was made superintendent of the merged lines, which positions he has held until his recent election as vice-president and general manager. Mr. Carl is a member of the American Society of Civil Engineers.

Mr. F. A. Burkhardt, whose portrait is presented herewith, has been appointed assistant general passenger and freight agent of the Ohio Electric Railway, with headquarters at Lima and Dayton, O.;

effective on March 19. His jurisdiction will extend over all divisions. Mr. Burkhardt entered railway service in 1897 as assistant ticket agent of the Cincinnati Hamilton & Dayton Railway at Lima, O., and three years later became agent at Lima of the New York Central Lines. In 1901 he was appointed joint agent of the Cincinnati Hamilton & Dayton and the New York Central Lines at Lima. In 1906 he was appointed division passenger and freight agent for the Schoepf syndicate at Lima, O., with jurisdiction over the Lima & Toledo Traction Company, the Ft. Wayne Van Wert & Lima Traction Company and the Columbus & Lake Michigan Railroad, which have been absorbed and are now operated by the Ohio Electric Railway.



F. A. Burkhardt.

Mr. W. C. Crawford of Tilbury, Ont., was recently elected first vice-president of the Windsor Essex & Lake Shore Rapid Railway of Windsor, Ont., a new single-phase line between

Windsor and Kingsville, Ont., which was placed in operation in September, 1907, and was described in the Electric Railway Review of December 21, 1907, page 946. Mr. Crawford has been connected with the Windsor Essex & Lake Shore for about three years and has heretofore been treasurer of the company. He was born near St. Mary's, Ont., 49 years ago and has resided for the past 20 years in Tilbury, Ont., where he owns one of the largest retail stores in the province. He has also been engaged for 17 years as a manufacturer of turned goods. He has been a member of the city council for 17 years.



W. C. Crawford.

Mr. Crawford has recently become actively interested in electric railways, which are now performing an important function in the development of Ontario. He is also one of the directors of the Windsor Chatham & London Railway, which is allied with the Windsor Essex & Lake Shore, and which proposes to build an extension from Leamington to Tilbury this year, and ultimately to Chatham. An extension from Kingsville to Leamington will be in operation about April 15.

Mr. George B. Thomas of Cleveland, O., has been appointed general manager of the New York & North Shore Traction Company, Mineola, N. Y., which has recently completed the first 10-mile section of its interurban road from Mineola to Roslyn and Port Washington, N. Y., succeeding Mr. Thomas Wood, resigned. Mr. Thomas resigned as secretary and assistant treasurer of the Cleveland Construction Company to accept his present position.

# Financial News

**Brooklyn Rapid Transit Company.**—It is reported that J. P. Morgan & Co. have purchased a block of bonds of this company and will be represented on the board of directors.

**Delaware River & Atlantic City Railroad.**—At the conclusion of the proceedings before Vice-Chancellor Leaming in Camden, N. J., the vice-chancellor said that he could not and ought not to name a receiver. Another application was made by counsel for an estate which is a creditor, for a rule to show cause why a receiver should not be appointed.

**Elmira (N. Y.) Water Light & Railroad Company.**—Approval of the issue of \$372,000 of first consolidated mortgage bonds, due on September 1, 1956, has been given by the New York public service commission, second district. The bonds are to be issued at not less than 80 per cent of par and will provide for refunding and for the completion, extension and improvement of the property. With this addition there will be \$1,604,000 of bonds of this issue outstanding.

**Hudson Companies, New York.**—The circular issued by Harvey Fisk & Sons of New York, offering for sale the 2-year 6 per cent notes, states: "There has been expended by the Hudson Companies to December 31, 1907, upon the Hudson and Manhattan system, including tunnels, stations, power houses, terminal buildings, equipment, electrical and other machinery and expenses incident thereto, the sum of \$34,190,164.41. Annual net earnings of the system are conservatively estimated at \$4,000,000, a sum largely in excess of all fixed charges. From present schedules rental sources alone, including the rentals from the terminal buildings at New York, where the company's station occupies the entire underground section, will produce more than one-half the amount of the interest charges on the Hudson & Manhattan Railroad first mortgage bonds."

**International Traction Company, Buffalo, N. Y.**—Gross earnings in 1907 were \$5,445,070, an increase of \$420,772 over 1906. Henry J. Pierce, the president, states in the annual report: "Fifty new pay-as-you-enter cars were purchased and put in service in January, 1908, on our Niagara street line in Buffalo. They have proved a marked success, the municipal authorities, the public and the newspapers joining in praise of the new system of car operation. The work of installing the pay-as-you-enter feature upon 150 of our standard cars has been begun at the Cold Springs shops, and will be pushed to completion, so that before the end of this year there will be 200 pay-as-you-enter cars in operation in Buffalo out of a total of 600 operated."

**Metropolitan Street Railway, New York.**—The protective committee representing holders of the general mortgage collateral trust 5 per cent bonds has been enlarged by the addition of William P. Dixon and Henry Evans.

**New York City Railway.**—A hearing on the application of the receivers for authority to issue \$3,500,000 took place before Judge Lacombe of the United States circuit court, New York, on March 20. Judge Lacombe said that the first thing to be considered was the benefit to the traveling public. "If cars and barns are burned they must be replaced," he said, "and the sole purpose of issuing certificates is to improve the property on which the trust companies hold mortgages. The First Avenue line should be put in proper shape to run and the way the money is to be spent can be amply arranged for in the order."

**New York New Haven & Hartford Railroad.**—The majority report of the commission on commerce and industry to the Massachusetts legislature favoring the proposed merger of the Boston & Maine Railroad with the New York New Haven & Hartford Railroad states that of the total assets of the latter road on June 30, 1907, there was invested in street railway, lighting and power properties and securities 19.93 per cent, or \$74,705,464. The commission finds that the New Haven company controls 16 electric street railways in Massachusetts, representing about one-fifth of the total mileage and nearly one-sixth of the total capital of street railways in the state. The report of the commission continues: "There have been two large questions underlying the problem of street railway management: first, how far they should be allowed to combine with each other; second, how far steam railroads should be allowed to control them. The first of these questions was settled in 1897 by the passage of an act allowing street railways to consolidate and the railroad commissioners, in their report for the year 1901, speak with decision of the good results of consolidations. To permit combination of street railways among themselves may be accepted, therefore, as the settled policy of this state. A combination of manage-

ment between steam railroads and street railways, on the other hand, is now forbidden by law; but the subject is so far under active discussion that it cannot be said that the policy is finally settled." The commission therefore recommends that for the purpose of holding together these 16 street railways, at least until it appears desirable to dismember the combination, and of putting them in a manageable position, the New Haven company be required, as a condition of its acquiring control of the Boston & Maine road, to transfer the shares of Massachusetts street railway companies which it holds or controls to a new corporation to be formed for the purpose, on the board of directors of which the state would be represented.

**Northern Texas Electric Company, Ft. Worth, Tex.**—The report of the Northern Texas Traction Company, a subsidiary company, has been filed with the city secretary of Dallas, Tex. Of the gross earnings of \$1,060,157, \$772,313 was received from passengers and \$275,885 from the sale of tickets. The amount of claims outstanding against the company for damages on December 31, 1907, was \$1,079,766.

**Ohio Electric Railway.**—A block of general and refunding mortgage 5 per cent bonds of the Indiana Columbus & Eastern Traction Company, an underlying road, is offered by Drexel & Co. and Ervin & Co. of Philadelphia and E. H. Rollins & Sons and Adams & Co. of Boston. The bonds are dated May 1, 1906, and are offered at 96 and interest. The total authorized issue is \$12,000,000, of which there are outstanding, including an amount reserved to retire \$1,255,000 divisional liens, \$7,600,000. The Indiana Columbus & Eastern Traction Company has 444.79 miles of track. The Ohio Electric Railway guarantees the interest on the bonds and 5 per cent dividends on the \$1,000,000 of preferred stock of the traction company. With connecting lines in Ohio and Indiana, controlled by the same interests, the road forms part of a system of over 1,700 miles.

**Public Service Railway, Newark, N. J.**—Edward J. Moore has been elected a director of the South Jersey Gas Electric & Traction Company, a subsidiary, to fill the vacancy caused by the death of Thomas C. Barr.

**Spokane & Inland Empire Railroad, Spokane, Wash.**—An offering of \$250,000 of first and refunding mortgage 5 per cent bonds has been made by the Harris Trust & Savings Bank of Chicago. A letter from Jay P. Graves, president of the company, states: "The lines should be considered from the steam railroad standpoint rather than from that of the electric railroad, as they transport all kinds of heavy and light freight, as well as passengers, have freight and passenger terminals in the heart of the city, and interchange freight with the trunk line steam railroads on favorable terms."

**Third Avenue Railroad, New York.**—Coupons due on January 1, 1908, on the \$5,000,000 of first mortgage 5 per cent bonds were paid on and after March 20, 1908.

**West India Electric Company, Ltd., Kingston, Jamaica.**—The annual report for 1907, presented at the meeting of shareholders in Montreal, showed gross earnings of \$198,845, operating expenses of \$94,805, and net earnings of \$104,040. Taxes, interest and rentals were \$46,953, leaving a surplus of \$57,087.

**West Jersey & Seashore Railroad, Camden, N. J.**—Gross earnings in 1907 were \$5,654,903, an increase of \$448,619 over 1906. In the annual report James McCrea, president, states that "judging by past experience and the business that is being developed through the electric service and improved facilities, the earnings will produce in the near future commensurate increases in your net revenues."

## Dividends Declared.

Bangor (Me.) Railway & Electric Company, quarterly, 1 per cent.  
Cincinnati (O.) Street Railway, quarterly, 1½ per cent.  
Havana (Cuba) Electric Railway, preferred, quarterly, 1½ per cent.  
Louisville (Ky.) Traction Company, common, quarterly, 1 per cent; preferred, 2½ per cent.  
Rochester (N. Y.) Railway, preferred, quarterly, 1¼ per cent.  
Springfield (Ill.) Railway & Light Company, quarterly, 1 per cent.  
United Railways of St. Louis, preferred, quarterly, 1¼ per cent.  
Washington Water Power Company, Spokane, Wash., quarterly, 1¼ per cent.

The membership of the American Institute of Electrical Engineers has increased more than 25 per cent during the past year and now exceeds 5,400. There are now 37 active sections or branches located in the principal electrical sections of the country.

# Manufactures and Supplies

## ROLLING STOCK.

**Columbus Urbana & Western Electric Railway, Columbus, O.**, is asking prices on one interurban car.

**Interborough Rapid Transit Company, New York**, has ordered 125 equipments from the General Electric Company.

**New York Central Lines** have placed an order with the American Locomotive Company and the General Electric Company for 12 electric locomotives.

**Third Avenue Railroad, New York**, through its receiver, has placed an order with the General Electric Company for motors, controllers and brakes for 125 cars.

**International Railway, Buffalo, N. Y.**, is remodeling 150 of its standard type cars, in order that the pay-as-you-enter system of fare collection may be used on them. This work is being done at the company's Cold Spring shops.

**Montgomery Traction Company, Montgomery, Ala.**, has placed an order with The J. G. Brill Company for eight convertible Narragansett type double-truck cars, as reported in the Electric Railway Review for February 29. These cars will be mounted on Brill 27 G.E. 1 trucks and will be equipped with Brill seats and gongs. Some of the details follow:

Seating capacity	40 passengers
Wheel base	4 ft. 6 in.
Length of body	28 ft. 4 in.
Over vestibules	40 ft. 4 in.
Over all	42 ft.
Width over posts	8 ft. 6 1/4 in.
Height floor over roof board	8 ft. 7 1/2 in.
Track over trolley board	12 ft. 5/8 in.

**Chicago Ottawa & Peoria Railway, H. E. Chubbuck**, general manager, Ottawa, Ill., has placed an order with the Danville Car Company for six closed double-truck cars, as reported in the Electric Railway Review of March 14. These cars will be used as trailers. They are to be mounted on Danville Car Company trucks and equipped with Acme curtain fixtures, Pantasote curtain material, Peacock hand brakes and Hale & Kilburn seats. Delivery is to be made June 1. The following details are included in the specifications:

Seating capacity	48 passengers	Width inside	8 ft. 2 1/2 in.
Weight	35,000 lb.	Over all	9 ft.
Wheel base	4 ft.	Height inside	8 ft. 4 1/2 in.
Length of body	32 ft.	Sill to trolley base	9 ft. 7 in.
Over vestibule	39 ft. 10 in.	Track to trolley base	11 ft. 11 in.
Over all	40 ft. 10 in.	Body	Semi-steel
		Underframe	Semi-steel

**Northern Ohio Traction & Light Company, Akron, O.**, which was reported in the Electric Railway Review of January 18 to be in the market for four interurban cars, has placed this order with the G. C. Kuhlman Car Company. Delivery is to be made in April. Included in the specifications are the following details:

Seating capacity	58 passengers	Width inside	8 ft. 1 in.
Weight	74,000 lb.	Over all	8 ft. 8 in.
Wheel base	7 ft.	Height inside	7 ft. 10 in.
Length of body	43 ft.	Track to trolley base	12 ft. 10 in.
Over all	53 ft.	Body	Wood
		Underframe	Composite

## Special Equipment.

Air brakes	Westinghouse automatic	Journal bearings	Symington
Brakeshoes	Brill	Journal boxes	Symington
Center bearings	Symington	Markers	Lintern
Curtain fixtures	Forsyth	Motors	General Electric
Curtain material		Paint	Sherwin-Williams
	Curtain Supply Co.	Safety tread	Mason
Door fastenings	Brill	Seats	Nichols-Lintern
Fenders	Eclipse	Side bearings	Brill
Gears and pinions		Springs	Brill
	General Electric	Trolley retriever	Knutson
Gongs	DeDenda	Trucks	Brill 27 E
Hand brakes	Peacock	Varnish	Chicago
Heating system	Germer stoves	Ventilators	Globe
Headlights	Crouse-Hinds		

**Chippewa Valley Railway Light & Power Company, Eau Claire, Wis.**, which the Electric Railway Review of January 25 reported to be in the market for two interurban cars, ad-

vises that the purchase of this equipment is again under consideration.

**Chicago Railways Company** has specified the following special equipment for the 300 cars ordered from the Pullman Company on March 19, as reported in the Electric Railway Review for March 21: General Electric motors and control system, Hale & Kilburn seats, Forsyth curtain fixtures, Pantasote curtain material.

## SHOPS AND BUILDINGS.

**Connecticut Railway & Lighting Company, Bridgeport, Conn.**—It is reported that this company has had plans prepared for the construction of car houses at Bridgeport.

## TRADE NOTES.

**Northern Engineering Works, Detroit, Mich.**, is building two 3-motor 66-foot span electric traveling cranes, equipped with new type E trolley, for a steel plant in Japan.

**Standard Steel Tie Company** has been incorporated with a capital stock of \$133,000 by A. V. Jones, 123 West One Hundred and Sixteenth street, F. W. Mills and H. M. Browne, 154 Nassau street, all of New York.

**Freeborn Engineering & Construction Company, Kansas City, Mo.**, has been awarded a contract for the engineering and construction work on a plant for the Crushed Stone & Filler Company, to be erected at Sugar Creek, Mo. The engineering work has been started and construction work will follow immediately.

**John A. Brill**, vice-president of The J. G. Brill Company, died in Philadelphia, Pa., on March 25. Mr. Brill had a broad knowledge of the operating conditions of railways, as is evidenced by nearly 200 patents issued to him on cars and trucks and parts of their equipment. He conceived the fundamental principle of electric truck construction—an independent frame for the support of the motor—and the first truck built on this principle was of his design.

**T. H. Symington Company, Baltimore**, has lately secured an order through its London agents, G. D. Peters & Co., for ball bearing center and side bearings for 153 passenger coaches under construction in England for the Northwestern Railway of India, and for side bearings for 38 passenger coaches for the same railway. This order follows very shortly an order received for center and side bearings for 54 coaches likewise under construction in England for the Bombay Baroda & Central India Railway. Baltimore center and side bearings have been very thoroughly tested during the past two years under the rolling stock of a number of English railways with such satisfactory results that the Symington company reports there is every indication of a large foreign business in prospect for this device. Some of the foreign roads which are using Baltimore bearings are the London Underground, London & Northwestern, Great Central Railway of England, Lancashire & Yorkshire Railway of England, Belfast & Northern Counties Railway of Ireland, Buenos Aires Western Railway of Brazil, Imperial Government Railway of Japan and the Bengal Nagpur Railway of India.

**American Locomotive Company's** strong financial position is shown in a circular issued by Harvey Fisk & Sons, bankers, New York, in which the 7 per cent cumulative preferred stock of the locomotive company is offered for sale. The following are comparative figures taken from the company's first report, published in 1902, and its last report, published in 1907:

Year ending June 30—	1902.	1907.
Capital stock, preferred	\$25,000,000	\$25,000,000
Capital stock, common	25,000,000	25,000,000
Cost of property as per balance sheet	45,482,293	46,925,096
Bonded debt of constituent companies	1,612,500	2,992,500
Working capital	4,998,916	13,756,587
Profit and loss, surplus	224,235	7,963,580
Plants	8	10
Acreeage	157	469
Earnings	\$26,398,394	\$49,515,486
Expenses	23,291,217	42,744,381

Net earnings .....\$ 3,107,177     \$ 6,771,105

Since its organization the American Locomotive Company has expended from its earnings \$8,052,250 for improvements and additions to properties, aside from the annual appropriations for betterments and replacements. The company has also expended \$1,833,556 in acquisition of the stock of the Locomotive & Machine Company of Montreal, Limited, and \$1,972,115 for the stock of the Rogers Locomotive Works, Paterson, N. J. During the same period the working capital of the company has been increased \$8,757,671, which, added to the sums above enumerated as provided for extraordinary im-



improvements and expended in the acquisition of new property, makes an increase of \$20,665,592 in the value of the assets, with practically no increase in capital liabilities.

**ADVERTISING LITERATURE.**

**H. W. Johns-Manville Company, 100 William Street, New York, N. Y.**—A leaflet is devoted to a description of Arido dry furnace cement.

**H. W. Johns-Manville Company, 100 Williams Street, New York, N. Y.**—A combination mailing card folder is devoted to J-M asbestos roofings.

**Koehring Machine Company, Milwaukee, Wis.**—A new catalogue of handy size is devoted to descriptions and illustrations of concrete machinery.

**General Compressed Air & Vacuum Machinery Company, St. Louis, Mo.**—Pneumatic cleaning equipment for passenger cars is illustrated and described in Bulletin No. 60.

**National Brake & Electric Company, Milwaukee, Wis.**—National type "3VS" air compressors are described and illustrated on a card of tasteful design and convenient form.

**B. F. Sturtevant Company, Hyde Park, Mass.**—Bulletin No. 153 of the engineering series is entitled "There is Nothing New—Not Even in Fans," being a reprint from a technical magazine.

**Ohmer Fare Register Company, Dayton, O.**—A 4-page leaflet presents facts and figures to prove that the fare registers of its manufacture will prevent the usual losses in fare collections.

**J. A. Boughton, 1515 St. Clair Street, Cleveland, O.**—An illustrated booklet is devoted to a special design of cast semi-steel tie, which has been patented in the leading countries of the world.

**Bryant Zinc Company, Chicago and New York.**—A handsomely bound catalogue of 200 pages has been issued showing the complete line of signal and battery supplies manufactured and handled.

**Allis-Chalmers Company, Milwaukee, Wis.**—Bulletin No. 1513 describes portable air compressors, which are built for capacities of 11, 16, 20 and 50 cubic feet of free air per minute. Each is constructed throughout with strength to withstand a working pressure of 100 pounds per square inch.

**The J. G. Brill Company, Philadelphia, Pa.**—The March number of Brill's Magazine contains the usual amount of interesting matter, including an illustrated description of the second lot of 150 pay-as-you-enter cars for the Indiana avenue line of the Chicago City Railway. A number of both foreign and domestic car shipments are illustrated and described.

**KALAMAZOO TROLLEY WHEELS.**

When the "Kalamazoo" trolley wheel was first placed on the market a few years ago some very strong prejudice against anything new in trolley wheels was encountered. It was then believed by railway men that nothing better than the common brass wheel could profitably be used. Since that time the "Kalamazoo" wheel is said to have demonstrated its service value by giving a surprisingly large mileage per wheel.

This wheel is now used on many of the largest electric railways in the United States and it is claimed for the wheel that no railway which has once adopted it has ever discarded it for one of another make. The wheel is made of pure lake copper, treated by a special process known only to the manufacturer, which gives it the quality of softness combined with a requisite toughness. No scrap nor alloy is used in the manufacture of the wheel.

The oiling device, which is one of the unique features, insures thorough lubrication of the bearing surface at all times and thereby prevents unusual wear of the conductor wire and destruction of the bushings.

The Starr Brass Company, Kalamazoo, Mich., is now making 22 different styles of the "Kalamazoo" wheel, many of which have been designed to give the highest possible mileage on the various types of overhead construction found on different railways. The company is also making an improved trolley harp, which is giving exceedingly good results. Some of the advantages claimed for the harp are that it prevents

the contact springs from wearing and breaking and makes it possible to change wheels quickly.

**FERRACUTE ARMATURE DISC NOTCHER.**

The armature disc notching machine shown in the accompanying illustration exhibits the latest improvements in this class of presses built by the Ferracute Machine Company of Bridgeton, N. J. The appearance of the machine is pleasing. The castings are well proportioned with neatly rounded corners.

The indexing mechanism is operated from the crank shaft through the medium of the bell crank shown at the side. The connection from this crank to the pawl lever is by means of a telescopic pitman made of bicycle tubing so that it can be adjusted to the different positions of the saddle (carrying vertical indexing spindle) required by the varying sizes of discs. On the lower end of the indexing spindle is placed

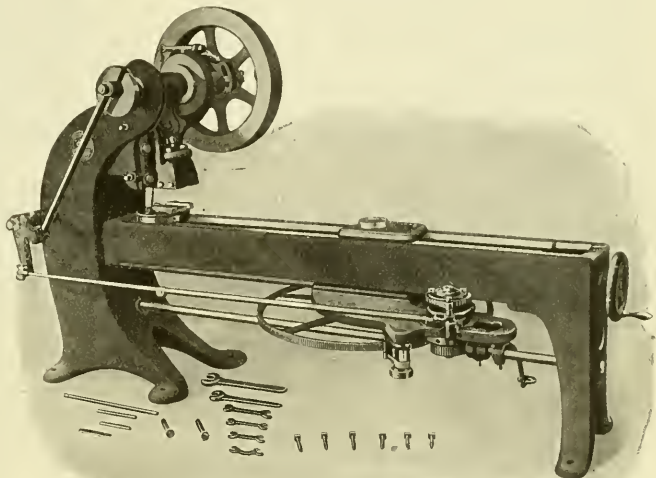

Ferracute Armature Disc Notcher—Side View.

a large gear wheel, into which engages the pinion that is on the same shaft with the ratchets.

Various ratchets are supplied and they can be quickly changed when required, although a given disc will give a considerable range of indexing by varying the number of notches taken at each stroke. On the large gear is a tappet, which, when the wheel has made one revolution, throws out the clutch and stops the machine, and, when the wheel has been moved for a notch, a brake, operated by the same connection to the crank shaft, prevents the gear from going beyond its proper position or overrunning when moving fast, thus holding it still while the punch is descending. This brake enables the machine to be operated at a higher rate of speed than would be possible without it up to 200 strokes on the smaller discs. The die bed is adjustable vertically so that the die can always be set at the right height, and the depth of the notches can be accurately secured by means of the screw movement of the saddle upon the bed.

There are three sizes of presses in this series. Press C93 (the one illustrated) notches discs up to 84 inches in diameter; press C92 up to 48 inches; and Press C94 up to 120 inches in diameter. The length of the machine (right to left) is about 8 feet; width, 3½ feet; height, 5 feet 3 inches. The total weight is 2,600 pounds.

**VERA CRUZ, MEXICO, TO HAVE ELECTRIC RAILWAY.**

The Vera Cruz Electric Light Power & Traction Company of Vera Cruz, Mexico, which company is owned by S. Pearson & Son, has completed arrangements to provide that city with electric railway service in addition to the power and lighting service it is now supplying. A very large extension is being made to this company's power plant equipment at Vera Cruz. The new machinery includes six 470-kilowatt alternating-current generators, which are to be run by Diesel

oil engines. The current for the power and lighting throughout the city will be distributed underground.

For the traction service the company has recently ordered of G. & O. Braniff & Co., to come from the works of the Westinghouse Electric & Manufacturing Company of Pittsburgh, Pa., two 120-kilowatt motor generator sets, which will be used to furnish direct current for railway use.

Storage batteries will be employed. The order for new equipment includes a 30-panel switchboard complete with all the instruments for the control of the new generators, power and lighting feeders, motor generator sets, battery, railway feeders, etc.

There will be 11 double motor equipments for the cars, including motors, controllers and auxiliary apparatus.

When this plant is completed Vera Cruz will be provided with one of the best and most modern installations of its kind in the republic and the first of its size employing this type of engine in this country.

#### THE WOBBLE TROLLEY WHEEL.

The attractive features of the Humphrey "wobble" trolley wheel are its globe-shaped bearing, special oiling scheme and the simplicity of construction. Each of these the manufacturer claims tends to reduce and eliminate many of the trolley wheel troubles experienced with the ordinary wheel and bearing.

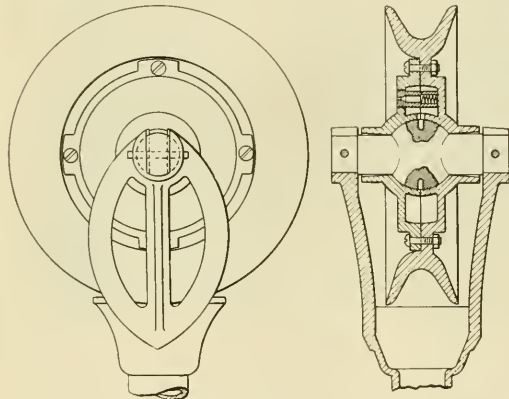

The Humphrey Wobble Trolley Wheel.

As is shown in the illustration, the wheel is made in two parts. The main section includes the rim and one-half of the oil chamber and hub. A complementary section or cap fits into the concave surface provided at one side of the main casting and completes the formation of an oil chamber for carrying oil for lubricating the bearing. It will be noted that the hub of the wheel is cast with a spherical bearing surface and with shoulders slightly tapered to allow the wheel to freely change its position on the axle. This allows the wheel to follow the trolley wire, even at acute angles, without unnecessary friction on the hub or on the wire.

The axle is made of drop-forged steel and is spherical in shape at the center. The axle fits into pockets in the hub and is held in position by cotter pins. This arrangement makes it a simple matter to change wheels.

The wheel has no contact springs. It is well known that whenever an arc is formed on a trolley wheel a hurf is left on the inside of the groove, which increases the wear on the overhead wire to a great extent. The globe bearing of the Humphrey wheel insures at all times a perfect contact between the hub and the axle and between the wheel and the wire, thus assuring high conductivity and long life at the wheel.

The oiling scheme consists of an oil chamber filled with felt, which, when saturated with oil, distributes the lubricant evenly over the surface of the bearing. The oil is inserted through an opening in the oil chamber, which is closed by a ball held in place by a spring. Under the severest operating conditions this chamber needs filling only once in seven days.

In severe service the wheel is guaranteed by its maker to run 10,000 miles. It is manufactured and sold by the Humphrey Trolley & Manufacturing Company, Detroit, Mich.

#### IMPROVED LOCKING SOCKET FOR INCANDESCENT LAMPS.

A special lamp socket has recently been placed on the market by the General Electric Company, which should prove very attractive to managers of amusement resorts and electric railways who suffer lamp losses by petty thievery or by jarring from car fixtures.

In the old style of locking socket the lamp was held rigid in the socket, and attempts to remove it generally resulted in



A Locking Lamp Socket.

breaking the globe. In the new style the screw shell turns freely and the lamp cannot be removed until the shell is unlocked with the key.

The socket is shown in the accompanying illustration, and it should be noted that the addition of the locking feature has been made without detracting in any way from the neat appearance of the standard socket.

This locking socket should also appeal to those who had contemplated using the higher priced tantalum and tungsten lamps, but who had deferred doing so on account of the extra inducements offered to the sneak thief.

#### WORCESTER DOUBLE-ACTING FENDER.

The Worcester Railway Supply Company is manufacturing at Worcester, Mass., a double-acting fender illustrated in the accompanying halftone engraving. In this illustration

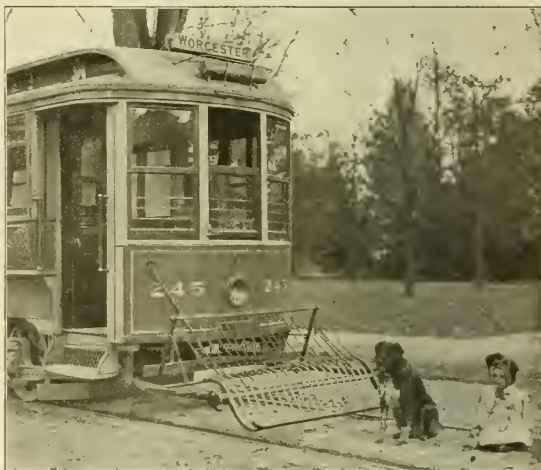

Worcester Double-Acting Fender—Operating Position.

the fender is set in its running position. The lower portion of the fender, it will be noted, is a curved steel grid carried on a horizontal shaft. A protective basket extends from the dash of the car to this same shaft. When an object is struck by the fender, the forward portion immediately opens up and

withholds the object until the fender is again set in position by the motorman. When not in use, the fender may be folded closely against the dash of the car.

**ELECTRIC FLOOR SURFACER.**

Electric railways which operate dance pavilions, roller skating rinks and bowling alleys are often put to considerable expense for resurfacing the floors as they become worn or warped. To facilitate this work and enable floors to be surfaced at a low cost the Real Estate Improvement Company, Providence, R. I., is promoting the sale of the Wattles electric floor surfacing machine. The accompanying illustration shows three of these machines as they appear in service.

The device comprises an electric motor driving surfacing cutters which plane wooden floors so that they are as smooth as when newly laid. Special claims are made for the effective work done by this machine. Economy is gained by its use



The Wattles Electric Floor Surfacers in Use.

the roof were designed with the most careful attention to mechanical details.

Owing to the extremely long platforms, which are seven feet in length at each end of the car, it was necessary to provide for a very heavy live load on each platform. The middle platform knees are made of 60-pound T-rails, extending through and back of the body bolsters, firmly riveted to cross bracing. In order to allow the platform flooring to be securely fastened to these middle knees, an oak strip was bolted to each, to which the platform flooring is screwed. The outside knees consist of heavy channel irons, bent to shape and bolted at the rear ends, through the side sills and truss plate.

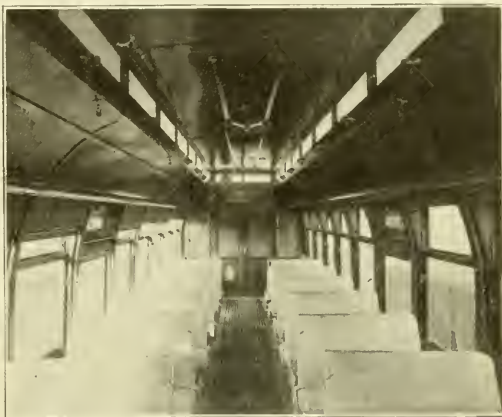

Semi-Convertible Cars for Salt Lake City—Interior Finish.

because, even though power is required, the work can be done more quickly than by hand and with better results. Meanwhile there is no dust and dirt stirred up.

**SEMI-CONVERTIBLE CARS FOR THE UTAH LIGHT & RAILWAY COMPANY.**

There have just been delivered to the Utah Light & Railway Company 50 handsome cars of the latest semi-con-

The car body is provided with an extra heavy truss plate and in addition a very heavy truss.

While the bodies are of the concave and convex panel type, the rails and strainer were made sufficiently heavy to take care of any stresses which might be put upon the body. While the ordinary semi-coach type of car is considered stiffer than the panel type, these cars are said to be not only lighter but very much stronger than the straight side car could have been built with the same weight of material.

The Utah Light & Railway Company has adopted the St.

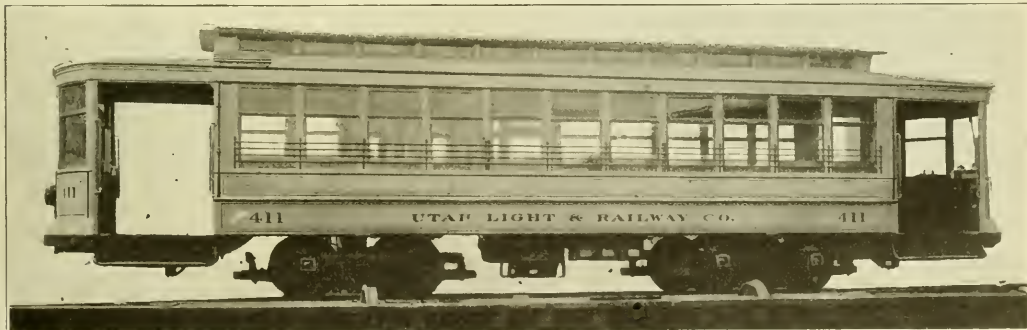

Semi-Convertible Cars for Salt Lake City—Side View.

vertible type, designed and built by the St. Louis Car Company. The car bodies are 30 feet over corner posts, 44 feet over all and are mounted on the builder's No. 47 trucks. The width from arm rails is 8 feet 4 inches. The interior of the cars is finished in natural cherry, rubbed to a dead finish and then polished. They are provided with the St. Louis Car Company's latest type of Walkover rattan covered cross seats. The car builder has furnished these semi-convertible cars free of all the weak features heretofore said to obtain in this type. The arrangement of the sashes and the various mechanical devices used in connection with storing them under

Louis Car Company's No. 47 truck as its standard and will replace by it all of its other older types of double trucks.

Dossert & Co., 242 West Forty-first street, New York, report a steady increase in orders received for the Dossert solderless connectors. Among the recent orders are third-rail clamp connectors for 1,000,000-circular-mil cables for the New York Central & Hudson River, cable taps, 400,000 circular-mils, main to No. 0000 feeders for the Chicago City Railway and cable taps for 1,000,000-circular-mil cables for the Syracuse & South Bay Electric Railway.

### WESTINGHOUSE DIRECT-CURRENT STARTING RHEOSTATS.

The increasing use of electric drive in repair shops warrants attention to the choice and care of starting boxes. Direct-current motors, except in the smallest sizes, require some sort of starting device to keep the current within safe limits and also to prevent the motor from starting with too great a rush. The necessity of using satisfactory starting devices is therefore as great as to have the motor itself reliable. The Westinghouse Electric & Manufacturing Company has developed a line of face plate starters which are thoroughly satisfactory and fully meet the specifications and conditions laid down by the National Board of Fire Underwriters and the American Institute of Electrical Engineers.

All starting rheostats are intended for use only when bringing the motor up to speed, and are not designed for regulating the speed. Speed regulating rheostats may be obtained, but they are intended either to vary the field current of the motor or else they must be able to regulate the much larger armature current. The rheostat which regulates the armature current must be capable of carrying the full line current continuously. Therefore this type of rheostat is considerably more expensive than the starting rheostats which are in service for only the short and infrequent periods of starting. The lower cost of the starting rheostat does not interfere with its absolutely satisfactory operation for the intermittent service of starting for which it is designed.

The starters for motors on 110 volts up to 22 horsepower or 220 volts up to 35 horsepower use the bar type of resistance, which consists of a resistance wire wound on iron bars which are first covered with a fireproof material. The ends of the bars are held in place by porcelain pieces, clearly shown in one of the illustrations. The construction is strong and rigid, so that adjacent turns on the same bar cannot short-circuit, nor can turns on one bar come in contact with turns

the larger motors larger contacts are required; this requirement is met by furnishing renewable contacts, as shown in one of the illustrations of the 160-ampere rheostat. In this larger type of starter a special short-circuiting brush is provided which cuts out the last contact, insuring the lowest resistance possible.

For starting motors on 110 volts of 25 horsepower or 220 volts 45 horsepower and larger, the grid type of resistance is used, which is fully ventilated and will stand the heavy duty required in starting large motors. All contacts, brushes, fingers and springs may be removed from the front with ease.

The line of rheostats is described in Leaflet No. 9000, with full information as to dimensions, carrying capacities, etc. This line of starters is adapted for 110, 220 and 500 volt motors.

As these rheostats are used only in starting the handle will not remain on any point except the last unless held.

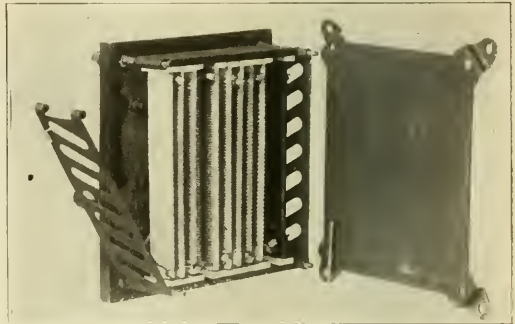

Direct-Current Starting Rheostats—Grid Type Starter with 240-Ampere Face Plate.

They are intended to bring the motor up to speed in 15 to 30 seconds according to size, and are made for full load conditions.

### ELECTRIFICATION IN MEXICO.

Compania Minera Las Dos Estrellas is the first in the republic of Mexico to electrify a steam railroad, by doing which its locomotive equipment is increased to seven locomotives. In view of the considerable saving made in the last two years in operating this property by electricity in place of steam, orders have been placed for machinery for electrically equipping a part of the present steam road operating between the company's mines and El Oro. To supply current for this work the Westinghouse Electric & Manufacturing Company is now building a 450-horsepower motor generator set, which will be located centrally with regard to the part of the road to be electrified. This set will take its power from the circuits of the Mexican Light & Power Company. The motor will drive a 300-kilowatt direct-current generator, thereby changing the energy into direct current for use on the trolley. A suitable marble switchboard, with necessary panels, instruments, switches and operating devices will be located with the motor generator set.

The first installation will consist of one locomotive, weighing 60,000 pounds, provided with double trucks and a steel cab. It will be a Baldwin-Westinghouse unit. Freight cars will be loaded with ore on the surface at a shaft above the mill and this will be hauled to the Cedro mill of the company on a track over the ore bins, where they will be emptied. The grade is 3.8 per cent, being down grade with load.

Although the Dos Estrellas company already has in operation six Westinghouse electric locomotives, some of which are operating in the mine, others on the surface, and since the introduction of which the cost of hauling per ton has been reduced one-half, this large new locomotive is the first in the country converting a former steam haul into electric.

Whereas this is but the beginning of the electrification of steam roads in Mexico, there is every reason to expect that on account of the economy derived this will spread throughout the country, as it is doing in the United States and abroad.

General Electric Company, Schenectady, N. Y., has received, among recent orders, one from the Sao Paulo Light & Power Company, Sao Paulo, Brazil, for 40 type H oil-cooled transformers.

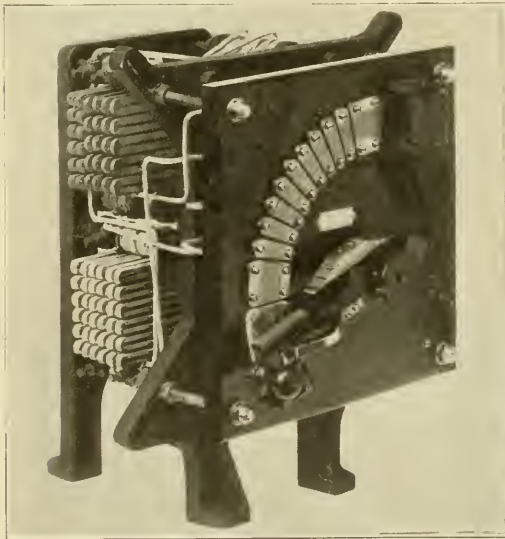

Direct-Current Starting Rheostats—Bar Type Open for Inspection.

on another bar. The whole construction, resistance, iron frame, slate front, contact arm, etc., is fireproof.

Another feature embodied in these starters is the low voltage release. The contact arm will positively fly back to the off position if the current is shut off from the line or if the voltage falls below a fixed limit. This prevents damage to the motor should the current again be thrown on or the voltage rise suddenly to its full value. The method of connecting the magnet of the release coil will be found of special benefit where the field of the motor is to be regulated. The magnet is connected across the line independently of the shunt field and is unaffected by variations in the field current.

A small button type of rheostat is used on the smaller types of motors and is capable of carrying 80 amperes. For

# Dearborn Water Purifying Reagents

Increase the efficiency and the years of service of steam boilers by keeping them in good condition internally. Gallon sample of the water required for analysis before preparing treatment.

## Dearborn Drug & Chemical Works

ROBT. F. CARR, PRESIDENT

299 BROADWAY, NEW YORK POSTAL TELEGRAPH BLDG., CHICAGO

### WASHBURN Traction Draft Rigging

The highest development of its kind, so designed and constructed that the draft rigging is always directly in the line of all pulling and buffing strains. In other words, the spring takes up all shocks without undue strains on the rigging.

This is the draft rigging that enabled heavy interurban cars to be hauled on their own wheels in trains from St. Louis to Los Angeles without a breakage.

Further comment on their strength is unnecessary.

*Ask for new catalogue of traction devices.*

**Washburn Steel Castings & Coupler Co., Minneapolis, Minn.**

Western Agents: Tweedy, Hood & Finlen, 2014 Fisher Bldg., Chicago

Canadian Agent: John Taylor, Montreal

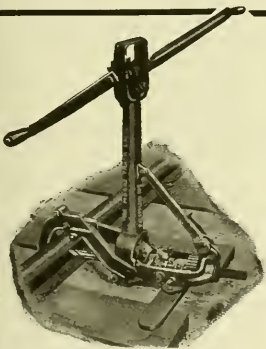
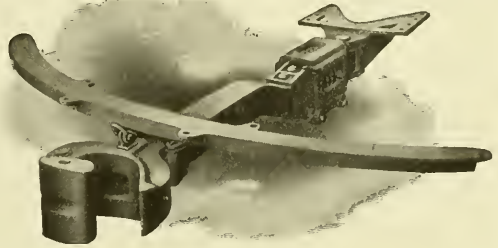

## The Moore Track Drill

does not interfere with traffic!

The shifting of one lever and a few seconds' time takes down the drill—the operation reversed makes it ready for work again.

This is only one of the many strong points about the Moore Track Drill that make it worth buying.

*Ask for descriptive catalogue.*

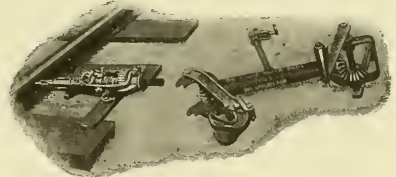

**Kalamazoo Railway Supply Co.** Kalamazoo Michigan

## The Cleveland Frog & Crossing Co.

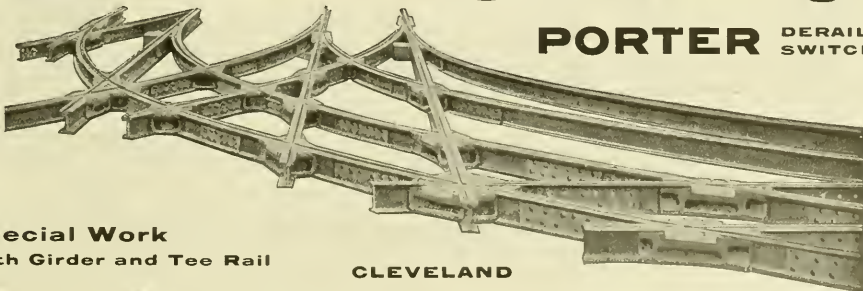

**PORTER DERAILING SWITCHES**

**Special Work**  
Both Girder and Tee Rail

**CLEVELAND**

# THE J. G. BRILL COMPANY, PHILADELPHIA, PA.

AMERICAN CAR COMPANY, ST. LOUIS, MO.  
 G. C. KUHLMAN CAR COMPANY, CLEVELAND, OHIO  
 JOHN STEPHENSON COMPANY, ELIZABETH, N. J.  
 WASON MANUFACTURING CO. SPRINGFIELD, MASS.

MAIN OFFICE: PHILADELPHIA, PA.  
 LONDON OFFICE: 110 CANNON ST. E. C.  
 PACIFIC COAST AGENTS: PIERSON  
 ROEDING & CO., SAN FRANCISCO.  
 AUSTRALIAN AGENTS: NOYES  
 BROTHERS, SYDNEY. CABLES:  
 "BRILL," PHILA., "AXLES" LONDON.

*CARS TRUCKS SEATS RATTAN SPRINGS SPECIALTIES SUPPLIES*

## FOR HIGH EFFICIENCY

The centrifugal pump is used in fire engines because it is the simplest and most effective means of producing pressure. It is used in the Brill power sprinkler for the same reason. The centrifugal pump is operated by a direct-connected motor (both located on the platform at one end of the car) and supplies pressure for distributing the water uniformly over fifty feet of roadway on each side of the track. The pump shaft has the only wearing surface in the entire mechanism, so no trouble is caused by heated parts. The amount and direction of the water is always under perfect control by the patented type of sprinkling head employed. Write for catalog.

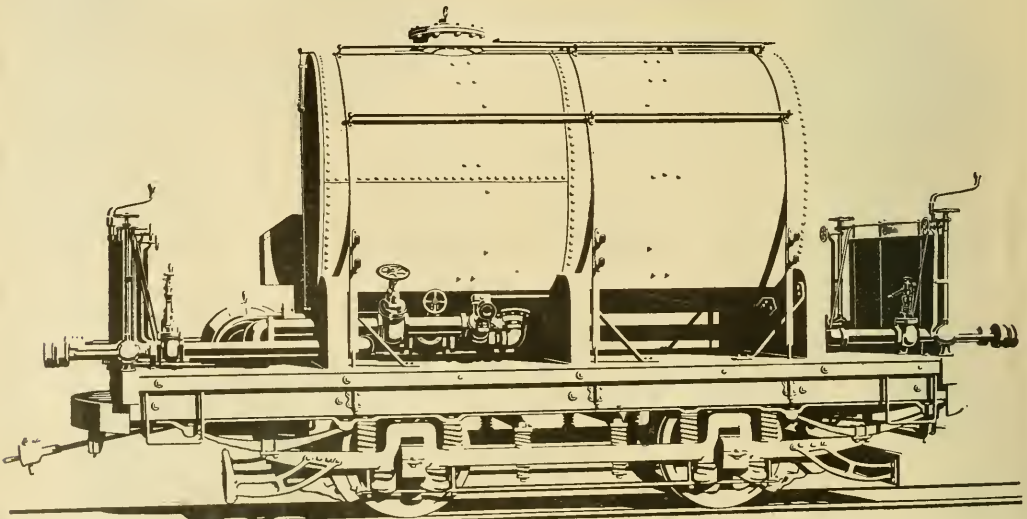

*THE BRILL CENTRIFUGAL SPRINKLER (PATENTED)*

# General Electric Company

## Rotary Converters FOR Electric Railway Service

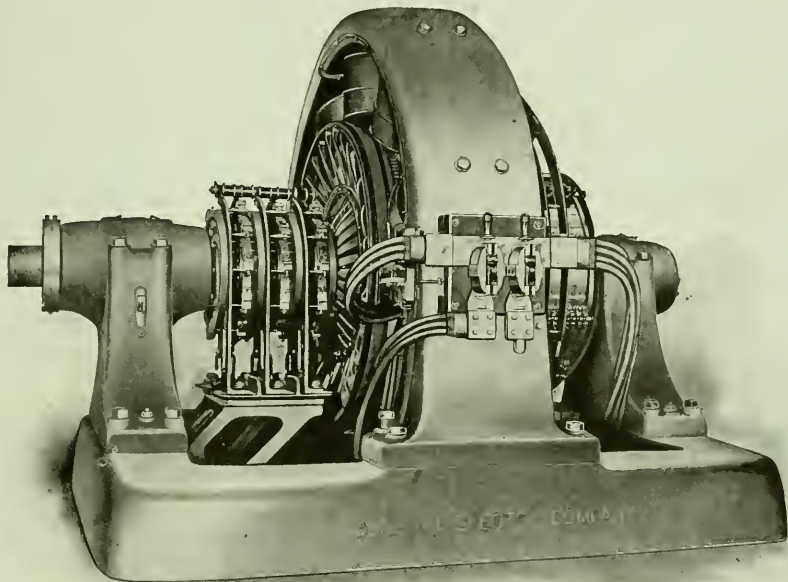

GE PUBL'N  
BUREAU

H. C. 8-1000-375, 600-Volt Compound-Wound Rotary Converter.

General Electric Rotary Converters are noted for their reliable and stable operation even under all momentary abnormal conditions of load, voltage and frequency.

### Endorsed by Managers of the Leading Electric Railways.

This is what one satisfied manager says :

"The commutation of the machines is apparently entirely satisfactory, taking swing loads up to 250% of their capacity without sparking and running on a variation of A. C. voltage amounting in some instances to 30% and a variation in frequency of 20%."

1545

Chicago Office:  
Monadnock Bldg.

Principal Office:  
Schenectady, N. Y.

Sales Offices in  
all large cities

# AMERICAN ELECTRICAL WORKS

PROVIDENCE, R. I.

## BARE AND INSULATED ELECTRIC WIRE

New York Office, 26 Cortlandt St. Chicago Office, 135 Adams St.  
MONTREAL BRANCH: Eugene F. Phillips Electrical Works, Limited.



Wherever absolute accuracy is demanded the best steel measuring tapes to use are those made by

**THE LUFKIN RULE CO.**

New York, London, England, Windsor, Canada  
SACINAW, MICH., U. S. A.



## It's Great!

Have you received a working model of the Atlas Anchor?

Ask for one—free.

THE ATLAS ANCHOR CO., Cleveland, Ohio

Specify the Genuine Roller. It is that Element that makes a Car Curtain a Success. Every Genuine Roller has the Name of Manufacturer



## STEWART HARTSHORN

IN SCRIPT ON LABEL

STEWART HARTSHORN CO.

Office and Factory, E. NEWARK, N. J.  
NEW YORK, 382 Lafayette St. CHICAGO, 338-344 Wabash Ave.

Special Car Rollers are made. Brackets are made for all classes of fittings. Used all over the world wherever cars are run.



## THE Bellamy Vestlette

For Street Railway Conductors

**ABSOLUTELY SAFE. Money cannot be lost or stolen from these pockets OVER 150,000 IN USE**

Saves the price of a coat yearly. Conductor's uniform always presentable. Adopted as a part of the uniform by over 200 Street Railway Companies. Price \$2.00, sent to any address prepaid, where we have no agent. Agents wanted on every line.

The Bellamy Vestlette Mfg. Co., Cleveland, O. and A. F. JURY, 205 Yonge St., Toronto, Canada

Patented April 27, 1897



DESIGNS for ADVERTISING

BIRDS EYE VIEWS

**HALF TONES**  
Photographing Machinery & Retouching ART PRINTING  
**WOODBURY CARLTON & CO.**  
WORCESTER, MASS.



Factory of The Milloy Electric Company Bucyrus, Ohio

## The Milloy Trolley Base

built in our new and specially equipped factory, insures a quality which will give excellent service under ordinary and extraordinary conditions.

The Milloy Base is unusually low, has even tension on high or low wire. Has no fulcrum, no friction, no oil, no center post. Always efficient. Particulars on request.

**THE MILLOY ELECTRIC COMPANY**  
Bucyrus, Ohio

UP-TO-DATE

## Shop Equipment

We illustrate in our catalogues Nos. 69 and 70 over five hundred hydraulic tools, comprising Wheel Presses, Crank Pin Presses, Broaching Presses, Forcing Presses and other tools essential in an up-to-date shop.

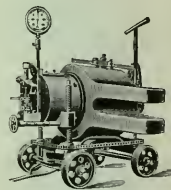

Write for Catalogues 69 and 70.

**THE WATSON-STILLMAN CO.**

Main Office: 26 Cortlandt Street, New York City  
Branch Office: 453 The Rookery, Chicago, Ill.

**Drummond's Detective Agency**  
RAILWAY WORK A SPECIALTY  
A. L. DRUMMOND, GENERAL MANAGER, EX-CHIEF U. S. SECRET SERVICE, NEW YORK.



# Electric Railway Review

PUBLISHED EVERY SATURDAY.

FORMERLY THE STREET RAILWAY REVIEW.

THE WILSON COMPANY, CHICAGO.

170 Harrison Street, Chicago  
150 Nassau Street, New York  
1529 Williamson Bldg., Cleveland

VOL. XIX  
No. 14

CHICAGO, APRIL 4, 1908

Subscription: Domestic . . . \$2  
Foreign . . . \$5  
Canada . . . \$3.50  
Whole No. 254

**M**ORE electric railway men who count in making purchases are reading the Electric Railway Review today than ever before. And why?

Because the Review has proved up on its claim to first place editorially and is continuing to publish more news while it is news and more practical articles of particular interest to electric railway men generally than any other paper in the field.

The Electric Railway Review has demonstrated beyond question that it is better edited, better illustrated, better printed, more progressive, more up-to-date than any publication claiming to be in its class—and this is why the Review is acquiring prestige and circulation most rapidly.

If you are a good electric railway man, some day you will subscribe for the Electric Railway Review.

If you are an electric railway supply man, some day you will advertise in the Electric Railway Review.

But why wait—why postpone receiving the good things that are waiting for you—why not come into the fold *right now?*

## The Story of a Keystone Giant Strain Insulator



Cut No. 1

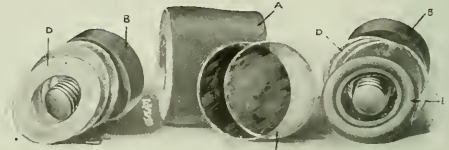

Cut No. 2

☛ Cut No. 1 shows a cross section of a Keystone Giant Strain Insulator. The strain shell is of **one piece**, malleable iron, of extra quality. The very black lines indicate solid mica washers and the light parts malleable iron.

☛ Cut No. 2 shows the unassembled Insulator, "A" being the malleable one-piece shell, "B" the insulated bolts, "C" the solid mica discs between the two insulated bolts, "D" the mica washers, and "E" the strain ring over which the shell is folded.

☛ For mechanical strength and perfect insulation, Keystone Giant Strain Insulators are unsurpassed. Their approximate breaking strength varies from 3,500 to 10,000 pounds, according to size.

## ELECTRIC SERVICE SUPPLIES Co.

Railway Material & Electrical Supplies

MAYER & ENGLUND DEPT.  
PHILADELPHIA

NEW YORK

GARTON-DANIELS DEPT.  
KEOKUK

PITTSBURG

SAINT LOUIS

SAINT LOUIS

PORTER & BERG DEPT.  
CHICAGO

ATLANTA

## For Public Utility Corporations

### PREVENTION OF ACCIDENTS AND BREAKDOWNS

should be the first consideration in street railway power plants. Crane cast steel valves and fittings cost more, but they cannot be ruptured under any conditions met with in practice, and the extreme high temperatures of superheated steam do not affect them. Then, too, steel valves and fittings are cheaper in the long run, as they last indefinitely without repairs.

## CRANE STEEL VALVES

These valves have pure nickel seats and nickel-steel stems. As nickel has the same co-efficient of expansion as steel, seats cannot work loose. Nickel does not deteriorate under excessive temperatures, while bronze and other alloys fail at about 600° Fahrenheit. With proper usage the stems and seats should last as long as valve bodies.

All parts of our steel valves are made in our own works under the most rigid inspection and tests, which insure castings of uniform quality.

We solicit correspondence regarding  
steel valves and fittings.

**CRANE CO.**  
CHICAGO  
ESTABLISHED 1855



# Westinghouse

## Protective Apparatus

Money invested in lightning arresters is money spent for insurance against interruptions to service and damage to apparatus; if spent for Westinghouse Arresters it is a good investment.



Ask for Arrester Circulars Nos. 1132 and 1146

### Westinghouse Electric & Mfg. Co.

Atlanta  
Baltimore  
Boston

Buffalo  
Chicago  
Cincinnati

Cleveland  
Dallas  
Denver

Detroit  
Kansas City  
Los Angeles  
Minneapolis

New Orleans  
New York  
Philadelphia

Pittsburg  
St. Louis  
Salt Lake City

San Francisco  
Seattle  
Syracuse

Canada: Canadian Westinghouse Co., Ltd., Hamilton, Ontario Mexico: G. & O. Braniff & Co., City of Mexico

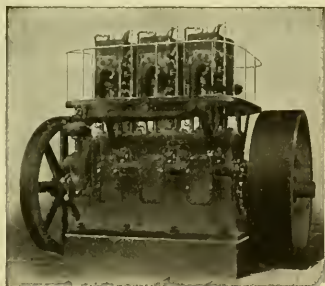

### Single-Acting Gas Engine Lubrication

A cast-iron housing encloses all main working parts of the engines, except pistons and valves. This housing contains a bath of oil into which the cranks and connecting rods dip, splashing it over journals and cylinder walls, thus automatically providing all internal lubrication.

Full particulars in publication 7006.

**The Westinghouse Machine Co.**  
Pittsburg, Pa.

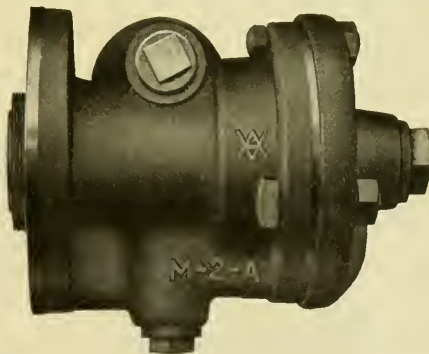

The most important part of the Westinghouse "AMM" automatic-brake equipment, the part upon which the whole action of the brake depends, is the Westinghouse Type "M" Triple Valve. It is this valve which makes possible the quick-recharge, graduated-release, quick-service and high-pressure in emergency features of the "AMM" equipment for one to five cars.

Fully described in Instruction Pamphlet T-5033.

**Westinghouse Traction Brake Co.**  
Pittsburg, Pa.

ALPHABETICAL INDEX TO ADVERTISEMENTS.

Allis-Chalmers Co. ....	Dossert & Co. ....14	Morden Frog & Crossing Wks..	Standard Motor Truck Co. ....11
Aluminum Co. of America...11	Drouvé, G. Co. ....23	National Brake & Electric Co.24	Standard Paint Co. ....23
American Brake Shoe & Fdry. Co. ....13	Drummond Detective Agency...	National Lock Washer Co. ....16	Standard Steel Works. ....18
American Electrical Works...	Eclipse Railway Supply Co. ....28	National Pole Co. ....22	Standard Underground Cable Co. ....11
American Frog & Switch Co. ....	Electric Railway Equipment Co. ....12	Naugle Pole & Tie Co. ....22	Star Brass Works. ....13
Anderson, Albert & J. M., Mfg. Co. ....21	Electric Ry. Improvement Co.28	New York Switch & Crossing Co. ....12	Stone & Webster Engineering Corporation ....15
Armstrong Oiler Co. ....	Electric Service Supplies Co. 2	Niles Car & Mfg. Co. ....16	Stuart-Howland Co. ....28
Arnold Company ....14	Engineers and Contractors....14	Northern Engineering Works... Nuttall, R. D., Co. ....15	Symington, T. H., Co. ....15
Automatic Trolley Guard Co.21	Fairbanks, Morse & Co. ....	Ohio Brass Co. ....5	Telegraph Signal Co. ....19
Babcock & Wilcox Co. ....12	Ford, Bacon & Davis. ....	Okonite Co., Ltd. ....	Trolley Supply Co. ....13
Baker, Wm. C., Heating & Supply Co. ....16	Galena-Signal Oil Co. ....15	Pacific Coast Pole Co. ....22	Under-Feed Stoker Co. ....18
Baldwin Locomotive Works.18	General Electric Co. ....27	Pantassote Co. ....	U. S. Metal & Mfg. Co. ....
Barbour-Stockwell Co. ....25	Hartshorn, Stewart, Co. ....	Patton, Paul E. ....	Van Dorn & Dutton Co. ....14
Barnes, G. H., Hardwood Lumber Co. ....22	Green Fuel Economizer Co. ....11	Pay-As-You-Enter Car Co. 9	Van Dorn, W. T., Co. ....11
Beldler, Francis, & Co. ....22	Griffin Wheel Co. ....22	Power Specialty Co. ....	Van Valkenburgh, E. C. ....28
Bellamy Vestlette Mfg. Co. ....	Hagy, J. Milton, Waste Wks.11	Pressed Steel Car Co. ....17	Wanted and For Sale Cards. ....20, 21
Berthold & Jennings ....22	Hale & Kilburn Mfg. Co. ....	Queen & Co. ....19	Washburn Steel Castings & Coupler Co. ....25
Bridgport Brass Co. ....	Hansbrough, Stewart, Co. ....	Rail Joint Co. ....18	Watson, Wm. Jr., & Co. ....23
Brill, J. A., Co. ....26	Heine Safety Boiler Co. ....12	Railway Specialty & Supply Co. ....	Western Electric Co. ....25
Brown, Harold P. ....	Heywood Bros. & Wakefield Co. ....	Register, A. L., & Co. ....14	Westinghouse Elec. & Mfg. Co. ....3
Brown Hoisting Machy. Co. ....14	Holman, D. F., Ry. Tracklayer Co. ....	Reiter, G. C. ....	Westinghouse Machine Co. 3
Buckeye Engine Co. ....13	Hope Webbing Co. ....	Robertson, Wm., & Co. ....28	Westinghouse Traction Brake Co. ....3
Burnham, Williams & Co. ....18	Humbird Lumber Co., Ltd. ....	Rodgers Ballast Car Co. ....17	Weston Electrical Instrument Co. ....19
Byllesby, H. M., & Co. ....14	Jewett Car Co. ....17	Rockford & Interurban Ry. Co. ....21	Wheeler Condenser & Eng'g Co. ....
Central Inspection Bureau...14	Johns-Manville, H. W., Co. 5	Rooke Automatic Register Co.23	Wheel Truing Brake Shoe Co. ....14
Chase-Shawmut Co. ....15	Kalamazoo Ry. Supply Co. ....25	Russell Car & Snow-Plow Co.21	White, J. G., & Co. ....14
Chicago Mica Co. ....28	Lindsey Bros. Co. ....22	S-E, Missouri Cypress Co. ....22	Whitmore Mfg. Co. ....19
Churchill Cedar Co. ....22	Lord & Burnham Co. ....21	St. Louis Car Co. ....7	Wilson, J. G., Mfg. Co. ....
Cincinnati Car Co. ....	Lufkin Rule Co. ....28	St. Louis Car Wheel Co. ....14	Woodbury, Carlton Co., Inc. ....
Cleveland Frog & Cross. Co. ....	Lumen Bearing Co. ....18	Sanderson & Porter. ....14	Woodman, R., Mfg. & Supply Co. ....
Collier, Barron G. ....	Macallen Co. ....16	Shimer & Chase Co. ....14	Wooster, C. H., Co. ....22
Columbia Construction Co. ....	McGuire-Cummings Mfg. Co. ....	Sheaff & Jastaad. ....14	Zelnicke, Walter A., Supply Co. ....21
Consolidated Car Fender Co.19	McGill, R. W., & Co. ....21	Simmons, John, Co. ....18	
Consolidated Car-Heating Co.14	Meyers, Fred J., Mfg. Co. ....	Smith, Peter, Heater Co. ....18	
Contractors' Supply & Equipment Co. ....14	Milroy Electric Co. ....16	Speer Carbon Co. ....18	
Crane Co. ....2	Model Stoker Co. ....14	Standard Brake Shoe Co. ....14	
Craghead Engineering Co. ....14			
Curtain Supply Co. ....23			
Davis, John, Co. ....			
Dearborn Drug & Chemical Works ....25			

CLASSIFIED LIST OF ADVERTISERS.

Advertising Designs and Plates. Woodbury-Carlton Co., Worcester, Mass.	Axles—(See Wheels and Axles).	Blowers—(See Mechanical Draft)	Brakes and Brake Parts—Continued.
Advertising Service. Van Valkenburgh, E. C., 2117 West One Hundred and Second St., Chicago.	Babbitt Metals—(See Alloys and Bearing Metals).	Blus Printing Machines. Buckeye Engine Co., Salem, O.	Brill, The J. G., Co., Philadelphia. Electric Service Supplies Co., 200 Plymouth Bldg., Chicago. General Electric Co., Schenectady, N. Y. Kuhlman, The G. C., Car Co., Cleveland. McGuire-Cummings Mfg. Co., Chicago. National Brake & Electric Co., Milwaukee. Stephenson, John, Co., Elizabeth, N. J. Wason Mfg. Co., Springfield, Mass. Westinghouse Traction Brake Co., Pittsburg, Pa.
Advertising, Street Car. Collier, Barron G., Flat Iron Bldg., New York.	Badges and Buttons. Electric Service Supplies Co., 200 Plymouth Bldg., Chicago.	Boilers. Babcock & Wilcox Co., N. Y. Fairbanks, Morse & Co., Chicago. Chase-Fuel Economizer Co., Matteawan, N. Y. Heine Safety Boiler Co., 421 Olive St., St. Louis. Lord & Burnham, Irvington-on-Hudson, New York.	Brushes. American Brake Shoe & Fdry. Co., Mahwah, N. J. American Car Co., St. Louis. Barbour-Stockwell Co., Cambridgeport, Mass. Brill, The J. G., Co., Philadelphia. Kuhlman, The G. C., Car Co., Cleveland. McGuire-Cummings Mfg. Co., Chicago. Marshall, R. W., & Co., 96 Liberty St., New York. St. Louis Car Co., St. Louis, Mo. Standard Brake Shoe Co., Aurora, Ill. Stephenson, John, Co., Elizabeth, N. J. Wason Mfg. Co., Springfield, Mass. Wharton, Wm. Jr., & Co., Philadelphia. Wheel Truing Brake Shoe Co., Detroit.
Air Brakes—(See Brakes and Brake Parts).	Ballast Cars—(See Cars, Ballast).	Boller Cleaning Compound. Dearborn Drug & Chemical Works, Chicago. Johns-Manville, H. W., Co., New York.	Bridge Timbers. Beldler, Francis, & Co., Chgo.
Air Compressors—(See Compressors, Air).	Ball Bearings. Symington, T. H., Co., Baltimore, Md.	Bonds, Rail. Brown, H. P., 120 Liberty St., New York. Chase-Shawmut Co., Newburyport, Mass. Electric Railway Improvement Co., Cleveland, O. Electric Service Supplies Co., 200 Plymouth Bldg., Chicago. General Electric Co., Schenectady, N. Y. Johns-Manville, H. W., Co., New York. Ohio Brass Co., Mansfield, O.	Brushes, Motor and Dynamo. Electric Service Supplies Co., 200 Plymouth Bldg., Chicago. General Electric Co., Schenectady, N. Y. Speer Carbon Co., St. Marys, Pa.
Alloys and Bearing Metals. Brown, H. P., 120 Liberty St., New York. General Electric Co., Schenectady, N. Y. Lumen Bearing Co., Buffalo, N. Y. Ohio Brass Co., Mansfield, O. St. Louis Car Co., St. Louis, Mo.	Bases—(See Trolley Poles and Fittings).	Brackets and Cross Arms. Anderson, Albert & J. M., Mfg. Co., Boston. Craghead Engineering Co., Cincinnati, O. Electric Railway Equipment Co., Cincinnati, O. Electric Service Supplies Co., 200 Plymouth Bldg., Chicago. Johns-Manville, H. W., Co., New York. Lindsey Bros. Co., Spokane, Wash. Ohio Brass Co., Mansfield, O. Stuart-Howland Co., Boston. Western Electric Co., Chicago.	Brushes, Motor and Dynamo. Electric Service Supplies Co., 200 Plymouth Bldg., Chicago. General Electric Co., Schenectady, N. Y. Speer Carbon Co., St. Marys, Pa.
Aluminum Wire, Etc. Aluminum Co. of America, Pittsburg.	Bearings. Electric Service Supplies Co., 200 Plymouth Bldg., Chicago. General Electric Co., Schenectady, N. Y. Lumen Bearing Co., Buffalo, N. Y. McGuire-Cummings Mfg. Co., Chicago. Marshall, R. W., & Co., 96 Liberty St., New York. Nuttall, R. D., Co., Pittsburg. Ohio Brass Co., Mansfield, O. Symington, T. H., Co., Baltimore, Md. Van Dorn & Dutton Co., Cleveland, O.	Brakes and Brake Parts. Allis-Chalmers Co., Milwaukee, Wis. American Car Co., St. Louis.	
Anchors. Electric Service Supplies Co., 200 Plymouth Bldg., Chicago. Miller Anchor Co., Norwalk, O. Ohio Brass Co., Mansfield, O.	Bells and Gongs. American Car Co., St. Louis. Brill, The J. G., Co., Philadelphia. Electric Service Supplies Co., 1020-24 Filbert St., Phila. Kuhlman, The G. C., Car Co., Cleveland. McGuire-Cummings Mfg. Co., Chicago. Ohio Brass Co., Mansfield, O. Reiter, G. C., Canton, O. St. Louis Car Co., St. Louis, Mo. Stephenson, John, Co., Elizabeth, N. J. Wason Mfg. Co., Springfield, Mass. Western Electric Co., Chicago.		
Armatures and Coils, Winding and Repairing. Electric Service Supplies Co., 200 Plymouth Bldg., Chicago. General Electric Co., Schenectady, N. Y. Marshall, R. W., & Co., 96 Liberty St., New York. Stuart-Howland Co., Boston.			
Armature Lifts. Electric Service Supplies Co., 200 Plymouth Bldg., Chicago.			
Asbestos Materials. Johns-Manville, H. W., Co., New York.			

# Cut Your Switchboard in Half!

Don't waste money and valuable space with a switchboard twice as large as necessary. One VICTOR COMBINATION METER occupies the space of but one single-unit meter, yet accomplishes the same results as three—therefore requires *only half* as large a switchboard.

## Victor Combination Meter

tells at a glance, on one dial, the voltage, current, power consumed in kilowatts and the horsepower consumption on any direct current circuit. It is substantial in construction—permanent in calibration—requires a minimum of energy to operate—is dead beat—unaffected by temperature variations—and beautifully finished.

With all these advantages, the "VICTOR" costs but little more than an ordinary meter.

Made in two types—Portable and Switchboard.

WRITE NEAREST BRANCH FOR CATALOG.

## H. W. JOHNS-MANVILLE CO.

NEW YORK  
MILWAUKEE  
CHICAGO  
BOSTON  
PHILADELPHIA  
ST. LOUIS

PITTSBURG  
CLEVELAND  
BUFFALO  
BALTIMORE  
NEW ORLEANS  
KANSAS CITY

MINNEAPOLIS  
SAN FRANCISCO  
LOS ANGELES  
SEATTLE  
DALLAS  
LONDON



775

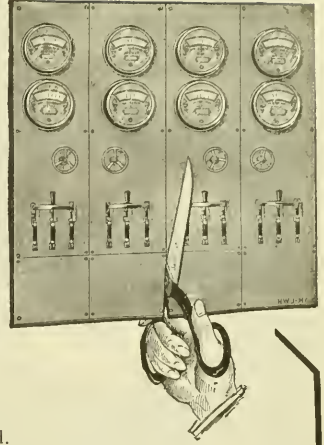

35,000 Volt Insulator. Cat. No. 9413.

# RAILWAY INSULATORS

For Transmission and Feeder Work

We control the entire output of one of the largest insulator factories in the country.

We are prepared to meet your requirements in every detail, ship promptly and furnish a product that is unsurpassed in design and quality of porcelain.

## Exceptionally Low Prices

on insulators of 5,000 volts and under  
Address High Tension Division.

*Please mention this advertisement.*

## The Ohio Brass Co., Mansfield, Ohio

NEW YORK: 43-49 Exchange Place      ST. LOUIS: 10 N. Fourth Street  
CHICAGO: 321 Dearborn Street



5,000 Volt Insulator. Cat. No. 9404.

## CLASSIFIED LIST OF ADVERTISERS—Continued.

- Bumpers, Car.  
American Car Co., St. Louis.  
Brill, The J. G., Co., Philadelphia.
- Kuhlman, The G. C., Car Co., Cleveland.  
St. Louis Car Co., St. Louis, Mo.
- Stephenson, John, Co., Elizabeth, N. J.
- Wason Mfg. Co., Springfield, Mass.
- Car House Doors.  
Wilson, J. G., Mfg. Co., New York.
- Car Replacers.  
Electric Service Supplies Co., 200 Plymouth Bldg., Chicago.  
Fairbanks, Morse & Co., Chgo. Kalamazoo Railway Supply Co., Kalamazoo, Mich.  
Ohio Brass Co., Mansfield, O.  
U. S. Metal & Mfg. Co., 25 Broad St., New York.
- Car Seats.  
American Car Co., St. Louis.  
Brill, The J. G., Co., Philadelphia.
- Hale & Kilburn Mfg. Co., Philadelphia.
- Heywood Bros. & Wakefield Co., Wakefield, Mass.
- Kuhlman, The G. C., Car Co., Cleveland.  
St. Louis Car Co., St. Louis, Mo.
- Stephenson, John, Co., Elizabeth, N. J.
- Wason Mfg. Co., Springfield, Mass.
- Car Signs—(See Signs, Cars and Track).
- Car Steps.  
Electric Service Supplies Co., 200 Plymouth Bldg., Chicago.
- Car Trimmings—(See Trimmings, Car).
- Cars, Ballast.  
Rodger Ballast Car Co., Chgo. St. Louis Car Co., St. Louis, Mo.
- Cars, Dump.  
Fairbanks, Morse & Co., Chgo. Rodger Ballast Car Co., Chgo. Russell Car & Snow-Flow Co., Ridgway, Pa.  
St. Louis Car Co., St. Louis, Mo.
- Cars, Passenger and Freight.  
American Car Co., St. Louis.  
Brill, The J. G., Co., Philadelphia.
- Cincinnati Car Co., Cincinnati.  
Detroit Carbuilding & Equipment Co., Detroit, Mich.  
Electric Railway Improvement Co., Cleveland, O.
- Fairbanks, Morse & Co., Chgo. Jewett Car Co., Newark, O.
- Kuhlman, The G. C., Car Co., Cleveland.
- McQuire-Cummings Mfg. Co., Chicago.
- Niles Car & Mfg. Co., Niles, O.
- Pressed Steel Car Co., Pittsburg.
- Rodger Ballast Car Co., Chgo. Russell Car & Snow-Flow Co., Ridgway, Pa.  
St. Louis Car Co., St. Louis, Mo.
- Standard Motor Truck Co., Pittsburg.
- Stephenson, John, Co., Elizabeth, N. J.
- Wason Mfg. Co., Springfield, Mass.
- Cars, Pay-As-You-Enter.  
Pay-As-You-Enter Car Co., 26 Cortlandt St., New York.
- Cars, Rebuilt.  
Detroit Carbuilding & Equipment Co., Detroit, Mich.
- Cars, Second-Hand.  
Detroit Carbuilding & Equipment Co., Detroit, Mich.
- Marshall, R. W., & Co., 95 Liberty St., New York.
- Zelnicker, Walter A., Supply Co., St. Louis.
- Cars, Steel.  
Pressed Steel Car Co., Pittsburg.
- St. Louis Car Co., St. Louis, Mo.
- Standard Motor Truck Co., Pittsburg.
- Castings, Brass.  
Star Brass Works, Kalamazoo, Mich.
- Castings, Iron and Steel.  
American Brake Shoe & Foundry Co., Mahwah, N. J.  
Green Engineering Co., Com'l Nat. Bk. Bldg., Chicago.
- National Brake & Electric Co., Milwaukee.
- Washburn Steel Castings & Coupler Co., Minneapolis.
- Catchers—(See Trolley Retrievers and Catchers).
- Cattle Guards.  
Fairbanks, Morse & Co., Chgo.
- Circuit-Breakers.  
Electric Service Supplies Co., 200 Plymouth Bldg., Chgo.  
General Electric Co., Schenectady, N. Y.  
Western Electric Co., Chicago.
- Coal Handling Machinery—(See Conveyors).
- Coils—(See Armatures and Coils).
- Commutators and Parts.  
Electric Service Supplies Co., 1020-24 Filbert St., Phila.  
General Electric Co., Schenectady, N. Y.
- Marshall, R. W., & Co., 95 Liberty St., New York.
- Ohio Brass Co., Mansfield, O.
- Stuart-Howland Co., Boston.
- Compressors, Air.  
Fairbanks, Morse & Co., Chgo. General Electric Co., Schenectady, N. Y.
- National Brake & Electric Co., Milwaukee.
- Westinghouse Traction Brake Co., Pittsburg.
- Concrete Mixers.  
Contractors' Supply & Equip. Co., Chicago.
- Condensers.  
Wheeler Condenser & Engineering Co., Carteret, N. J.
- Conduits.  
Electric Service Supplies Co., 200 Plymouth Bldg., Chicago.  
Western Electric Co., Chicago.
- Connectors, Solderless.  
Dossert & Co., 242 W. Forty-first St., New York.
- Contractors.  
Arnold Company, 181 La Salle St., Chicago.
- Byllesby, H. M., Co., Am. Trust Bldg., Chicago.
- Columbia Construction Co., Milwaukee, Wis.
- Craghead Engineering Co., Cincinnati.
- Green Engineering Co., Com'l Nat. Bk. Bldg., Chicago.
- Register, A. L., & Co., 112 N. Broad St., Philadelphia.
- Sanderson & Porter, 52 William St., New York.
- Saxton, E., 341 Bladenburg Ave., Washington, D. C.
- Sheaff & Jaastad, 88 Broad St., Boston.
- Stone & Webster Engineering Corporation, Boston.
- Wharton, Wm., Jr., & Co., Philadelphia.
- White, J. G., & Co., 49 Exchange Pl., New York.
- Controllers and Attachments.  
Electric Service Supplies Co., 200 Plymouth Bldg., Chicago.  
General Electric Co., Schenectady, N. Y.
- Johns-Manville, H. W., Co., New York.
- Marshall, R. W., & Co., 95 Liberty St., New York.
- Western Electric Co., Chicago.
- Westinghouse Electric & Mfg. Co., Pittsburg.
- Conveyors and Coal Handling Machinery.  
Green Engineering Co., Com'l Nat. Bk. Bldg., Chicago.
- Northern Engineering Works, Detroit, Mich.
- Cord, Bell and Trolley.  
American Car Co., St. Louis.  
Brill, The J. G., Co., Philadelphia.
- Electric Service Supplies Co., 1020-24 Filbert St., Phila.
- Cord, Bell and Trolley—Continued.  
Kuhlman, The G. C., Car Co., Cleveland.
- St. Louis Car Co., St. Louis, Mo.
- Stephenson, John, Co., Elizabeth, N. J.
- Wason Mfg. Co., Springfield, Mass.
- Couplers, Car.  
American Car Co., St. Louis.  
Brill, The J. G., Co., Philadelphia.
- Kuhlman, The G. C., Car Co., Cleveland.
- McQuire-Cummings Mfg. Co., Chicago.
- Ohio Brass Co., Mansfield, O.
- St. Louis Car Co., St. Louis, Mo.
- Stephenson, John, Co., Elizabeth, N. J.
- Van Dorn, W. T., Co., Paulina St., Chicago.
- Washburn Steel Castings & Coupler Co., Minneapolis.
- Wason Mfg. Co., Springfield, Mass.
- Coverings, Pipe and Boiler.  
Johns-Manville, H. W., Co., New York.
- Cranes, Hoists and Lifts.  
American Car Co., St. Louis.  
Brill, The J. G., Co., Philadelphia.
- Brown Hoisting Machinery Co., Cleveland, O.
- Kuhlman, The G. C., Car Co., Cleveland.
- Northern Engineering Works, Detroit, Mich.
- Railway Specialty & Supply Co., Chicago.
- Stephenson, John, Co., Elizabeth, N. J.
- Van Dorn & Dutton Co., Cleveland, O.
- Wason Mfg. Co., Springfield, Mass.
- Cross Arms—(See Brackets and Cross Arms).
- Crossing Gates—(See Gates and Guards).
- Crossings, Track—(See Switches, Frogs and Crossings).
- Curtains, Fixtures and Materials.  
American Car Co., St. Louis.  
Brill, The J. G., Co., Philadelphia.
- Curtain Supply Co., 93 Ohio St., Chicago.
- Electric Service Supplies Co., 200 Plymouth Bldg., Chicago.
- Hartshorn, Stewart, Co., East Newark, N. J.
- Kuhlman, The G. C., Car Co., Cleveland.
- Marshall, R. W., & Co., 95 Liberty St., New York.
- National Lock Washer Co., Newark, N. J.
- Fantasote Co., 11 Broadway, New York.
- St. Louis Car Co., St. Louis, Mo.
- Stephenson, John, Co., Elizabeth, N. J.
- Wason Mfg. Co., Springfield, Mass.
- Cylinder Oil.  
Power Specialty Co., 111 Broadway, N. Y.
- Derailing Devices.  
American Frog & Switch Co., Hamilton, O.
- Cleveland Frog & Crossing Co., Cleveland, O.
- Detective Agency.  
Drummond Detective Agency, New York.
- Doors and Fixtures.  
American Car Co., St. Louis.  
Brill, The J. G., Co., Philadelphia.
- Kuhlman, The G. C., Car Co., Cleveland.
- St. Louis Car Co., St. Louis, Mo.
- Stephenson, John, Co., Elizabeth, N. J.
- Wason Mfg. Co., Springfield, Mass.
- Doors, Steel Rolling.  
Wilson, J. G., Mfg. Co., New York.
- Draft, Mechanical—(See Mechanical Draft).
- Draft Rigging.  
Van Dorn, W. T., Co., Chgo. Washburn Steel Castings & Coupler Co., Minneapolis.
- Drills, Track.  
Brown, H. P., 120 Liberty St., New York.
- Electric Service Supplies Co., 200 Plymouth Bldg., Chicago.
- Fairbanks, Morse & Co., Chgo. Kalamazoo Railway Supply Co., Kalamazoo, Mich.
- Marshall, R. W., & Co., 95 Liberty St., New York.
- Drying Appliances.  
Green Fuel Economizer Co., Matteawan, N. Y.
- Dynamos and Generators.  
Fairbanks, Morse & Co., Chgo. General Electric Co., Schenectady, N. Y.
- National Brake & Electric Co., Milwaukee, Wis.
- Western Electric Co., Chicago.
- Westinghouse Electric & Mfg. Co., Pittsburg, Pa.
- Economizers, Fuel.  
Green Fuel Economizer Co., Matteawan, N. Y.
- Electrical Instruments.  
Electric Service Supplies Co., 200 Plymouth Bldg., Chicago.
- General Electric Co., Schenectady, N. Y.
- Johns-Manville, H. W., Co., New York.
- Queen & Co., Philadelphia.
- Western Electric Co., Chicago.
- Westinghouse Electric & Mfg. Co., Pittsburg, Pa.
- Weston Electrical Instrument Co., Newark, N. J.
- Electric Railway Supplies, General.  
Craghead Engineering Co., Cincinnati, O.
- Electric Service Supplies Co., 200 Plymouth Bldg., Chicago.
- Fairbanks, Morse & Co., Chgo. General Electric Co., Schenectady, N. Y.
- Johns-Manville, H. W., Co., New York.
- Marshall, R. W., & Co., 95 Liberty St., New York.
- Ohio Brass Co., Mansfield, O.
- Stuart-Howland Co., Boston.
- Western Electric Co., Chicago.
- Engine Apparatus.  
Green Fuel Economizer Co., Matteawan, N. Y.
- Engineers and Contractors.  
Arnold Company, Chicago.
- Byllesby, H. M., & Co., Chgo. Columbia Construction Co., Milwaukee, Wis.
- Ford, Bacon & Davis, New York.
- Register, A. L., & Co., Philadelphia.
- Sanderson & Porter, New York.
- Saxton, E., Washington, D. C.
- Sheaff & Jaastad, Boston.
- Stone & Webster Engineering Corporation, Boston.
- White, J. G., & Co., New York.
- Engines, Gas and Oil.  
Buckeye Engine Co., Salem, O.
- Fairbanks, Morse & Co., Chgo. Westinghouse Machine Co., Pittsburg.
- Engines, Hoisting.  
Fairbanks, Morse & Co., Chgo.
- Engines, Steam.  
Buckeye Engine Co., Salem, O.
- Westinghouse Machine Co., Pittsburg.
- Fans, Exhaust and Ventilating.  
General Electric Co., Schenectady, N. Y.
- Green Fuel Economizer Co., Matteawan, N. Y.
- Western Electric Co., Chicago.
- Westinghouse Elec. & Mfg. Co., Pittsburg.
- Fare Boxes—(See Electric Railway Supplies).
- Fare Registers and Register Fittings.  
Electric Service Supplies Co., 200 Plymouth Bldg., Chicago.
- Rooke Automatic Register Co., Providence, R. I.

# ST. LOUIS CAR CO. ST. LOUIS-MO.



## St. Louis Car Company's Semi-Convertible Type

The illustration represents one of the cars recently shipped by us to the Houston Electric Company, Houston, Texas.

These cars are of our own design—a practically perfect Semi-Convertible type. Both lower and upper sashes raise into the roof. They move easily and when in the roof pockets are securely fastened, with no possible danger of falling and injuring passengers.

### Our construction of the Semi-Convertible Car is the very best that has yet been devised

These Houston cars are 28' over corner posts and 31' 6" over all. Width over arm rail, 8' 6". They are finished with very handsomely figured mahogany, provided with curtains at each window and each door opening and have the St. Louis Car Company's latest improved "Walkover" seat.

The cars are mounted on St. Louis Car Company's No. 47 Short Wheel Base Truck, which has been adopted as standard in a great many of the larger cities. The channel-iron and steel construction of the "Robertson type" permits the arm rail of the car to be placed very low and adds much to the appearance.

*Photographs, Blue Prints and Specifications will be mailed upon request.*

## CLASSIFIED LIST OF ADVERTISERS—Continued.

- Feedwater Apparatus.**  
Green Fuel Economizer Co.,  
Matteawan, N. Y.  
Wheeler Condenser & Engi-  
neering Co., Carteret, N. J.
- Feed Wire—(See Wire and  
Cables).**
- Fenders and Guards.**  
Consolidated Car Fender Co.,  
Providence, R. I.  
Eclipse Railway Supply Co.,  
Cleveland, O.  
Electric Service Supplies Co.,  
190-24 Fifth St., Phila.  
McGuire-Cummings Mfg. Co.,  
Chicago.  
Marshall, R. W., & Co., 95  
Liberty St., New York.
- Flangers, Snow.**  
Kalamazoo Railway Supply  
Co., Kalamazoo, Mich.  
McGuire-Cummings Mfg. Co.,  
Chicago.  
Ohio Brass Co., Mansfield, O.  
Van Dorn & Dutton Co.,  
Cleveland, O.
- Frogs—(See Switches, Frogs and  
Crossings).**
- Fuel Economizers—(See Econo-  
mizers, Fuel).**
- Fuses and Fuse Devices.**  
Chase-Shawmut Co., New-  
buryport, Mass.  
Electric Service Supplies Co.,  
200 Plymouth Bldg., Chicago.  
General Electric Co., Schene-  
ctady, N. Y.  
Johns-Manville, H. W., Co.,  
New York.  
Western Electric Co., Chicago.  
Westinghouse Elec. & Manu-  
facturing Co., Pittsburg.
- Gaskets, Bronze.**  
Power Specialty Co., 111  
Broadway, New York.
- Gates and Guards.**  
Kalamazoo Railway Supply  
Co., Kalamazoo, Mich.
- Gear Cases.**  
Electric Service Supplies Co.,  
200 Plymouth Bldg., Chicago.  
General Electric Co., Schene-  
ctady, N. Y.  
Marshall, R. W., & Co., 95  
Liberty St., New York.  
Nuttall, R. D., Co., Pittsburg.  
Van Dorn & Dutton Co.,  
Cleveland, O.
- Generators—(See Dynamos).**
- Gongs—(See Bells and Gongs).**
- Graphite Paint—(See Paint).**
- Grates, Chain.**  
Green Engineering Co., Com'l  
Nat. Bk. Bldg., Chicago.
- Grease—(See Lubricants).**
- Grinders.**  
Brown, Harold P., 120 Liberty  
St., New York.
- Ground Connection Clamps.**  
Chase-Shawmut Co., New-  
buryport, Mass.
- Guy Anchors—(See Anchors).**
- Harps, Trolley—(See Trolley  
Poles and Fittings).**
- Headlights.**  
Electric Service Supplies Co.,  
200 Plymouth Bldg., Chicago.  
Fairbanks, Morse & Co., Chgo.  
General Electric Co., Schene-  
ctady, N. Y.  
St. Louis Car Co., St. Louis,  
Mo.  
Stuart-Howland Co., Boston.  
Trolley Supply Co., Canton, O.
- Heaters, Car, Electric.**  
Consolidated Car-Heating Co.,  
Albany, N. Y.  
Johns-Manville, H. W., Co.,  
New York.
- Heaters, Car, Hot Water, and  
Baker, The Wm. C., Heating  
& Sup. Co., New York.  
Electric Service Supplies Co.,  
190-24 Fifth St., Phila.  
McGuire-Cummings Mfg. Co.,  
Chicago.  
Smith, Peter, Heater Co., De-  
troit, Mich.**
- Heating and Ventilating Appa-  
ratus—(See Mech. Draft).**
- Hoists—(See Cranes, Hoists and  
Lifts).**
- Hose Bridges.**  
Ohio Brass Co., Mansfield, O.
- Hydraulic Machinery.**  
Watson-Stillman Co., 26 Cort-  
landt St., New York.
- Inspection.**  
Central Inspection Bureau.
- Inspection Cars, Gasoline.**  
Stover Motor Car Co., Free-  
port, Ill.
- Instruments, Measuring and  
Testing—(See Electrical In-  
struments).**
- Insulating Tapes.**  
General Electric Co., Schene-  
ctady, N. Y.  
Johns-Manville, H. W., Co.,  
New York, N. Y.  
Okonite Co., Ltd., 253 Broad-  
way, New York.  
Western Electric Co., Chicago.
- Insulations and Insulating Ma-  
terial.**  
Anderson, A. & J. M., Mfg.  
Co., Boston.  
Creshead Engineering Co.,  
Cincinnati, O.  
Electric Railway Equipment  
Co., Cincinnati, O.  
Electric Service Supplies Co.,  
200 Plymouth Bldg., Chicago.  
General Electric Co., Schene-  
ctady, N. Y.  
Johns-Manville, H. W., Co.,  
New York.  
Macallen, The, Co., Boston.  
Ohio Brass Co., Mansfield, O.  
Okonite Co., Ltd., 253 Broad-  
way, New York.  
Standard Paint Co., 100 Will-  
iam St., New York.  
Stuart-Howland Co., Boston.  
Western Electric Co., Chicago.
- Jacks.**  
American Car Co., St. Louis.  
Brill, The J. G., Co., Phila-  
delphia.  
Electric Service Supplies Co.,  
200 Plymouth Bldg., Chicago.  
Fairbanks, Morse & Co., Chgo.  
Kalamazoo Railway Supply  
Co., Kalamazoo, Mich.  
Kuhlman, The G. C., Car Co.,  
Cleveland.  
Marshall, R. W., & Co., 95  
Liberty St., New York.  
Morden Frog & Crossing Co.,  
Chicago.  
Stephenson, John, Co., Eliza-  
beth, N. J.  
Wason Mfg. Co., Springfield,  
Mass.  
Watson-Stillman Co., 26 Cort-  
landt St., New York.
- Joints, Expansion—(See Steam  
Fittings).**
- Joints, Rail.**  
Rail Joint Co., 29 W. 34th St.,  
New York.
- Joints, Welded—(See Rail Joints,  
Welded).**
- Journal Boxes.**  
American Car Co., St. Louis.  
Brill, The J. G., Co., Phila-  
delphia.  
Kuhlman, The G. C., Car Co.,  
Cleveland.  
McGuire-Cummings Mfg. Co.,  
Chicago.  
St. Louis Car Co., St. Louis,  
Mo.  
Stephenson, John, Co., Eliza-  
beth, N. J.  
Symington, T. H., Co., Balti-  
more, Md.  
Wason Mfg. Co., Springfield,  
Mass.
- Journal Lubricators—(See Lu-  
bricants).**
- Journal Packing, Steel Wool.**  
Robertson, Wm., & Co., Fifth  
Floor, Great Northern Bldg.,  
Chicago.
- Lamps, Arc and Incandescent.**  
Anderson, A. & J. M., Mfg.  
Co., Boston.  
Electric Service Supplies Co.,  
200 Plymouth Bldg., Chicago.  
General Electric Co., Schene-  
ctady, N. Y.  
Stuart-Howland Co., Boston.  
Western Electric Co., Chicago.  
Westinghouse Electric & Mfg.  
Co., Pittsburg, Pa.
- Lamp Sockets.**  
Electric Service Supplies Co.,  
200 Plymouth Bldg., Chicago.  
General Electric Co., Schene-  
ctady, N. Y.  
Johns-Manville, H. W., Co.,  
New York, N. Y.
- Lantern Globes.**  
Railway Specialty & Supply  
Co., Chicago.
- Lifts—(See Cranes, Hoist and  
Lift).**
- Lightning Arresters.**  
Electric Service Supplies Co.,  
200 Plymouth Bldg., Chicago.  
General Electric Co., Schene-  
ctady, N. Y.  
Stuart-Howland Co., Boston.  
Western Electric Co., Chicago.  
Westinghouse Elec. & Manu-  
facturing Co., Pittsburg.
- Line Material.**  
Anderson, A. & J. M., Mfg.  
Co., Boston.  
Creshead Engineering Co.,  
Cincinnati, O.  
Johns-Manville, H. W., Co.,  
New York.  
Electric Ry. Equipment Co.,  
Cincinnati, O.  
Electric Service Supplies Co.,  
200 Plymouth Bldg., Chicago.  
General Electric Co., Schene-  
ctady, N. Y.  
Macallen, The, Co., Boston.  
Marshall, R. W. & Co., 95  
Liberty St., New York.  
Stuart-Howland Co., Boston.  
Western Electric Co., Chicago.
- Lock and Nut Washers.**  
National Lock Washer Co.,  
Newark, N. J.
- Lockers, Metal.**  
Electric Service Supplies Co.,  
200 Plymouth Bldg., Chicago.
- Locomotives.**  
Baldwin Locomotive Works,  
Philadelphia.  
Locomotives, Electric.  
American Car Co., St. Louis.  
Baldwin Locomotive Works,  
Philadelphia.  
Brill, The J. G., Co., Phila-  
delphia.  
General Electric Co., Schene-  
ctady, N. Y.  
Kuhlman, The G. C., Car Co.,  
Cleveland.  
McGuire-Cummings Mfg. Co.,  
Chicago.  
Stephenson, John, Co., Eliza-  
beth, N. J.  
Wason Mfg. Co., Springfield,  
Mass.  
Westinghouse Elec. & Manu-  
facturing Co., Pittsburg.
- Locomotives, Gasoline.**  
Fairbanks, Morse & Co., Chgo.  
Stover Motor Car Co., Free-  
port, Ill.
- Lubricants.**  
Dearborn Drug & Chemical  
Works, Chicago.  
Galena-Signal Oil Co., Frank-  
lin, Pa.  
Whitmore Mfg. Co., Clevel-  
and, O.
- Lumber.**  
Barnes, G. H., Hardwood  
Lumber Co., St. Louis, Mo.  
Beldier, Francis, & Co., Chgo.  
Berthold & Jennings, St. Louis.  
Churchill Cedar Co., Spokane,  
Wash.  
Humbird Lumber Co., Sand  
Point, Idaho.  
Lindsay Bros. Co., Spokane,  
Wash.  
National Pole Co., Escanaba,  
Mich.  
Naugle Pole & Tie Co., 225  
La Salle St., Chicago.  
Pacific Coast Pole Co., Spoka-  
ne, Wash.  
S-E. Missouri Cypress Co.,  
Campbell, Mo.  
Worcester, C. H., Co., Tribune  
Bldg., Chicago.
- Promoters of Railway Projects.**  
Shimer & Chase Co., Omaha,  
Nebr.
- Punches—(See Ticket Punches).**
- Rail Benders.**  
Electric Service Supplies Co.,  
200 Plymouth Bldg., Chicago.  
Fairbanks, Morse & Co., Chgo.
- Mechanical Draft.**  
Green Fuel Economizer Co.,  
Matteawan, N. Y.
- Meters.**  
Johns-Manville, H. W., Co.,  
New York.  
Queen & Co., Philadelphia.  
Weston Electrical Instrument  
Co., Newark, N. J.
- Mica, Raw and Manufactured.**  
Chicago Mica Co., Valparaiso,  
Ind.
- Motor Cars, Gasoline.**  
Stover Motor Car Co., Free-  
port, Ill.
- Motors, Electric.**  
Fairbanks, Morse & Co., Chgo.  
General Electric Co., Schene-  
ctady, N. Y.  
National Brake & Electric Co.,  
Milwaukee.  
Western Electric Co., Chicago.  
Westinghouse Elec. & Manu-  
facturing Co., Pittsburg.
- Nut Locks.**  
Chase-Shawmut Co., New-  
buryport, Mass.  
National Lock Washer Co.,  
Newark, N. J.  
Railway Specialty & Supply  
Co., Chicago.  
St. Louis Car Co., St. Louis,  
Mo.  
U. S. Metal & Mfg. Co., 25  
Broad St., New York.
- Nuts and Bolts.**  
National Lock Washer Co.,  
Newark, N. J.  
Railway Specialty & Supply  
Co., Chicago.
- Oilers.**  
Armstrong Oiler Co., 31st and  
Chestnut St., Philadelphia.
- Oil—(See Lubricants).**
- Overhead Equipment—(See Elec-  
tric Railway Supplies).**
- Packing.**  
Electric Service Supplies Co.,  
200 Plymouth Bldg., Chicago.  
Johns-Manville, H. W., Co.,  
New York.  
Power Specialty Co., 111  
Broadway, New York.
- Packing, Steel Wool Journal.**  
Robertson, Wm., & Co., Fifth  
Floor, Great Northern Bldg.,  
Chicago.
- Paints.**  
Standard Paint Co., 100 Will-  
iam St., New York.
- Pay-As-You-Enter Cars.**  
Pay-As-You-Enter Car Co., 26  
Cortlandt St., New York.
- Pipe Bends and Fittings—(See  
Steam Fittings).**
- Poles, Metal.**  
Creshead Engineering Co.,  
Cincinnati, O.  
Electric Railway Equipment  
Co., Cincinnati, O.  
Electric Service Supplies Co.,  
200 Plymouth Bldg., Chicago.
- Poles and Ties, Wood.**  
Barnes, G. H., Hardwood  
Lumber Co., St. Louis, Mo.  
Beldier, Francis, & Co., Chgo.  
Berthold & Jennings, St. Louis.  
Churchill Cedar Co., Spokane,  
Wash.  
Humbird Lumber Co., Sand  
Point, Idaho.  
Lindsay Bros. Co., Spokane,  
Wash.  
National Pole Co., Escanaba,  
Mich.  
Naugle Pole & Tie Co., 225  
La Salle St., Chicago.  
Pacific Coast Pole Co., Spoka-  
ne, Wash.  
S-E. Missouri Cypress Co.,  
Campbell, Mo.  
Worcester, C. H., Co., Tribune  
Bldg., Chicago.
- Promoters of Railway Projects.**  
Shimer & Chase Co., Omaha,  
Nebr.
- Punches—(See Ticket Punches).**
- Rail Benders.**  
Electric Service Supplies Co.,  
200 Plymouth Bldg., Chicago.  
Fairbanks, Morse & Co., Chgo.





“The operation of  
**Pay-As-You-Enter Cars**  
 has proved an unqualified success”

This is the opening sentence of a public statement made by Oren Root, general manager of the New York City Railway, following the recent installation of the first modern street cars in that city. Mr. Root said further:

“The commendation of the cars by the passengers, so far as I have been able to learn, has been universal. What has been claimed for these cars has been actually demonstrated.”

Here you see the same story of success as told by Pay-As-You-Enter operation in Chicago, Montreal and Buffalo.

We license manufacturers and railways to build and use the Pay-As-You-Enter Car, the patents on which are owned by

## The Pay-As-You-Enter Car Company

DUNCAN McDONALD  
 President 26 Cortlandt Street, New York

THOS. W. CASEY  
 Manager

## CLASSIFIED LIST OF ADVERTISERS—Continued.

- Rail Bonds—(See Bonds, Rail).
- Rail Bonds, Flexible.  
Chase-Shawmut Co., Newburyport, Mass.
- Rail Drills—(See Drills, Track).
- Rail Feed Wire—(See Wire and Cables).
- Rail Joints and Chairs—(See Joints, Rail).
- Rails, New.  
New York Switch & Crossing Co., Hoboken, N. J.  
Wharton, Wm., Jr., & Co., Philadelphia.
- Rails, Relaying.  
Zelnicker, Walter A., Supply Co., St. Louis.
- Railway Velocipedes.  
Fairbanks Morse & Co., Chgo.  
Kalamazoo Railway Supply Co., Kalamazoo, Mich.
- Registers and Fittings—(See Fare Registers).
- Relays.  
Weston Electrical Instrument Co., Newark, N. J.
- Roofing.  
Johns-Manville, H. W., Co., New York.
- Sand Apparatus.  
American Car Co., St. Louis.  
Brill, The J. G., Co., Philadelphia.  
Electric Service Supplies Co., 200 Plymouth Bldg., Chicago.  
Kuhlman, The G. C., Car Co., Cleveland.  
Marshall, R. W., & Co., 95 Liberty St., New York.  
Ohio Brass Co., Mansfield, O.  
St. Louis Car Co., St. Louis, Mo.  
Stephenson, John, Co., Elizabeth, N. J.  
Wason Mfg. Co., Springfield, Mass.
- Sash Balances and Fixtures.  
National Lock Washer Co., Newark, N. J.
- Sash Operating Devices.  
Drouvé, The G. Co., Bridgeport, Conn.  
Lord & Burnham, Irvington-on-Hudson, New York.
- Seats, Car—(See Car Seats).
- Shade Rollers—(See Curtains, Fixtures and Material).
- Signals.  
Telegraph Signal Co., Rochester, N. Y.
- Signal Supplies.  
Railway Specialty & Supply Co., Chicago.
- Skylights.  
Drouvé, The G. Co., Bridgeport, Conn.  
Lord & Burnham, Irvington-on-Hudson, New York.
- Snow Plows, Sweepers and Scrapers.  
American Car Co., St. Louis.  
Brill, The J. G., Co., Philadelphia.  
Kalamazoo Railway Supply Co., Kalamazoo, Mich.  
Kuhlman, The G. C., Car Co., Cleveland.  
McGuire-Cummings Mfg. Co., Chicago.  
Russell Car & Snow-Plow Co., Ridgway, Pa.  
Stephenson, John, Co., Elizabeth, N. J.  
Wason Mfg. Co., Springfield, Mass.
- Sockets, Waterproof.  
Johns-Manville, H. W., Co., New York.
- Solder Paste.  
Chase-Shawmut Co., Newburyport, Mass.
- Springs.  
American Car Co., St. Louis.  
Brill, The J. G., Co., Philadelphia.  
Kuhlman, The G. C., Car Co., Cleveland.  
McGuire-Cummings Mfg. Co., Chicago.
- Spring—Continued.  
Marshall, R. W., & Co., 95 Liberty St., New York.  
Railway Steel Spring Co., 71 Broadway, New York.  
St. Louis Car Co., St. Louis, Mo.  
Stephenson, John, Co., Elizabeth, N. J.  
Wason Mfg. Co., Springfield, Mass.
- Sprinkling Cars.  
American Car Co., St. Louis.  
Brill, The J. G., Co., Philadelphia.  
Kuhlman, The G. C., Car Co., Cleveland.  
McGuire-Cummings Mfg. Co., Chicago.  
Stephenson, John, Co., Elizabeth, N. J.  
Wason Mfg. Co., Springfield, Mass.
- Stage Pockets and Plugs.  
Chase-Shawmut Co., Newburyport, Mass.
- Steam Apparatus.  
Green Fuel Economizer Co., Matteawan, N. Y.
- Steam Fittings, Etc.  
Crane Co., Chicago.  
Davis, The John, Co., Chgo.  
Simmons, John, Co., 110 Centre St., New York.  
Power Specialty Co., 111 Broadway, New York.
- Steel Cars.  
American Car Co., St. Louis.  
Brill, The J. G., Co., Philadelphia.  
Kuhlman, The G. C., Car Co., Cleveland.  
St. Louis Car Co., St. Louis, Mo.  
Stephenson, John, Co., Elizabeth, N. J.  
Wason Mfg. Co., Springfield, Mass.
- Steel Tapes.  
Lufkin Rule Co., Saginaw, Mich.
- Stokers.  
Eabcock & Wilcox Co., 85 Liberty St., New York.  
Green Engineering Co., Com'l Nat. Bk. Bldg., Chicago.  
Model Stoker Co., Dayton, O.  
Under-Red Stoker Company of America, Chicago.  
Westinghouse Machine Co., Pittsburg.
- Storage Batteries—(See Batteries).
- "Strike-Breakers."  
Drummond Detective Agency, 3 Ann St., New York.
- Superheaters.  
Power Specialty Co., 111 Broadway, New York.
- Switches, Frogs and Crossings.  
American Frog & Switch Co., Hamilton, O.  
Barbour-Stockwell Co., Cambridgeport, Mass.  
Cleveland Frog & Crossing Co., Cleveland, O.  
Fairbanks, Morse & Co., Chgo.  
Morden Frog & Crossing Co., Rookery, Chicago.  
New York Switch & Crossing Co., Hoboken, N. J.  
Railway Specialty & Supply Co., Chicago.  
Wharton, Wm., Jr., & Co., Philadelphia.
- Switchboards and Switchboard Instruments.  
Anderson, A. & J. M., Mfg. Co., Boston.  
Chase-Shawmut Co., Newburyport, Mass.  
General Electric Co., Schenectady, N. Y.  
Western Electric Co., Chicago.  
Westinghouse Electric & Mfg. Co., Pittsburg.  
Weston Electrical Instrument Co., Newark, N. J.
- Tapes and Webbing.  
Hope Webbing Co., Providence, R. I.  
Johns-Manville, H. W., Co., New York.  
Okonite Co., Ltd., 253 Broadway, New York.
- Testing Instruments.  
Queen & Co., Philadelphia.  
Weston Electrical Instrument Co., Newark, N. J.
- Test Lamps, Pocket.  
Chase-Shawmut Co., Newburyport, Mass.
- Ticket Choppers and Destroyers.  
Patten, Paul B., Salem, Mass.
- Ticket Punches.  
Meyers, Fred J., Mfg. Co., Hamilton, O.  
Woodman Mfg. & Sup. Co., Boston.
- Ties and Poles, Wood—(See Poles and Ties).
- Timber.  
Beldier, Francis, & Co., Chgo.  
Lindberg Bros. Co., Spokane, Wash.  
S-E. Misauril Cypress Co., Campbell, Mo.
- Tools, Pneumatic—(See Pneumatic Tools).
- Track Cleaners and Scrapers.  
American Car Co., St. Louis.  
Brill, The J. G., Co., Philadelphia.  
Kalamazoo Railway Supply Co., Kalamazoo, Mich.  
Kuhlman, The G. C., Car Co., Cleveland.  
McGuire-Cummings Mfg. Co., Chicago.  
Marshall, R. W., & Co., 95 Liberty St., New York.  
Ohio Brass Co., Mansfield, O.  
Stephenson, John, Co., Elizabeth, N. J.  
Van Dorn & Dutton Co., Cleveland, O.  
Wason Mfg. Co., Springfield, Mass.
- Track Drills—(See Drills, Track).
- Tracklaying Machinery.  
Holman, D. F., Ry. Tracklayer Co., 1102 Ellsworth Bldg., Chicago.
- Track Tools.  
Electric Service Supplies Co., 200 Plymouth Bldg., Chicago.  
Kalamazoo Railway Supply Co., Kalamazoo, Mich.
- Trimming Cars.  
American Car Co., St. Louis.  
Brill, The J. G., Co., Philadelphia.  
Curtain Supply Co., Park Row Bldg., New York.  
Kuhlman, The G. C., Car Co., Cleveland.  
National Lock Washer Co., Newark, N. J.  
St. Louis Car Co., St. Louis, Mo.  
Stephenson, John, Co., Elizabeth, N. J.  
Wason Mfg. Co., Springfield, Mass.
- Trolley Guards.  
Automatic Trolley Guard Co., 391 Elliott Sq., Buffalo, N. Y.  
Electric Service Supplies Co., 200 Plymouth Bldg., Chicago.
- Trolley Poles and Fittings.  
General Electric Co., Schenectady, N. Y.  
Johns-Manville, H. W., Co., New York.  
Marshall, R. W., & Co., 95 Liberty St., New York.  
Milloy Electric Co., Bucyrus, O.  
Niles, R. D., Co., Pittsburg.  
Star Brass Works, Kalamazoo, Mich.  
Trolley Supply Co., Canton, O.  
Westinghouse Electric & Mfg. Co., Pittsburg, Pa.
- Trolley Retrievers and Catchers.  
Electric Service Supplies Co., 200 Plymouth Bldg., Chicago.  
Milloy Electric Co., Bucyrus, O.  
Trolley Supply Co., Canton, O.
- Trolley Wagons.  
Kalamazoo Railway Supply Co., Kalamazoo, Mich.
- Trolley Wheels—(See Trolley Poles and Fittings).
- Trolley Wire—(See Wire and Cables).
- Trucks, Car—Continued.  
Brill, The J. G., Co., Philadelphia.  
Kuhlman, The G. C., Car Co., Cleveland.  
McGuire-Cummings Mfg. Co., Chicago.  
St. Louis Car Co., St. Louis, Mo.  
Standard Motor Truck Co., Pittsburg, Pa.  
Stephenson, John, Co., Elizabeth, N. J.  
Van Dorn & Dutton Co., Cleveland, O.  
Wason Mfg. Co., Springfield, Mass.
- Turbines.  
General Electric Co., Schenectady, N. Y.  
Westinghouse Machine Co., Pittsburg, Pa.
- Valves—(See Steam Fittings).
- Varnish.  
Electric Service Supplies Co., 200 Plymouth Bldg., Chicago.  
Standard Paint Co., 100 William St., New York.
- Ventilators.  
Drouvé, The G. Co., Bridgeport, Conn.  
Lord & Burnham, Irvington-on-Hudson, New York.
- Vestiettes.  
Bellamy Vestiette Mfg. Co., Cleveland, O.
- Waste, Cotton and Wool.  
Hazy, J. Milton, Waste Wks., Philadelphia, Pa.  
Railway Specialty & Supply Co., Chicago.
- Water Softening Apparatus.  
Dearborn Drug & Chemical Works, Chicago.
- Wheels and Axles.  
American Car Co., St. Louis.  
Brill, The J. G., Co., Philadelphia.  
Griffin Wheel Co., Chicago.  
Kuhlman, The G. C., Car Co., Cleveland.  
McGuire-Cummings Mfg. Co., Chicago.  
Marshall, R. W., & Co., 95 Liberty St., New York.  
Railway Steel-Spring Co., New York.  
St. Louis Car Co., St. Louis, Mo.  
St. Louis Car Wheel Co., St. Louis, Mo.  
Standard Steel Works, Philadelphia.  
Stephenson, John, Co., Elizabeth, N. J.  
Wason Mfg. Co., Springfield, Mass.
- Wheel Grinders.  
Wheel Truing Brake Shoe Co., Detroit, Mich.
- Window Fixtures.  
Drouvé, The G. Co., Bridgeport, Conn.
- Wiping Rags.  
Hazy, J. Milton, Waste Wks., Philadelphia, Pa.
- Wire, Aluminum.  
Aluminum Co. of America, Pittsburg, Pa.
- Wire, Insulated.  
Aluminum Co. of America, Pittsburg, Pa.  
American Electrical Works, Providence, R. I.  
General Electric Co., Schenectady, N. Y.  
Okonite Co., Ltd., 253 Broadway, New York.  
Standard Underground Cable Co., Pittsburg, Pa.  
Stuart-Howland Co., Boston.
- Wire and Cables.  
Aluminum Co. of America, Pittsburg, Pa.  
American Electrical Works, Providence, R. I.  
Bridgeport Brass Co., Bridgeport, Conn.  
General Electric Co., Schenectady, N. Y.  
Okonite Co., Ltd., 253 Broadway, New York.  
Standard Underground Cable Co., Pittsburg, Pa.

**STANDARD HIGH-SPEED "INTERBOROUGH" DOUBLE TRUCK**

TYPE C-60

**"Solid Forged"**

WITHOUT WELDS

FRAMES ARE MADE FROM ROLLED OPEN-HEARTH STEEL WITHOUT WELDS. ALL WEARING BOLTS ARE TURNED AND CASE HARDENED, AND WEARING HOLES STEEL THIMBLED. M. C. B. STANDARD PRINCIPLES ARE FOLLOWED. WE ARE PREPARED TO BUILD TRUCKS IN ACCORDANCE WITH PURCHASER'S DESIGNS AND SPECIFICATIONS.

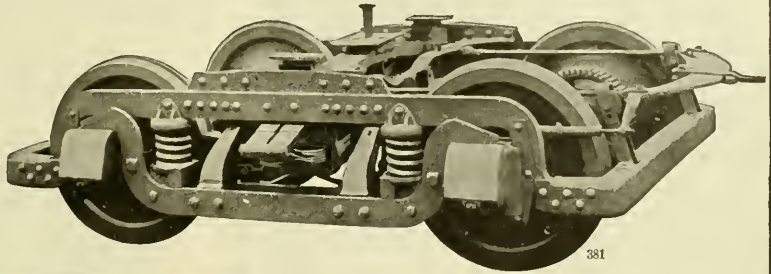

381

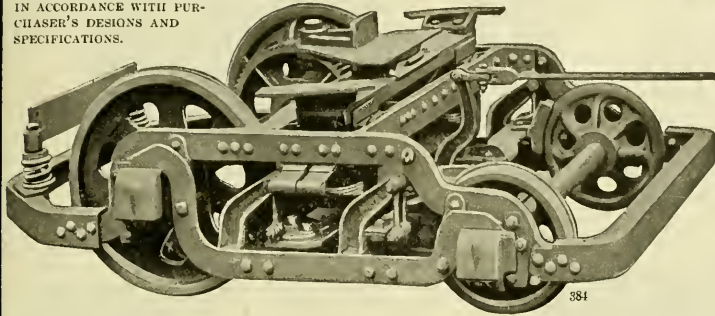

384

**STANDARD "MAXIMUM TRACTION" DOUBLE TRUCK**

CITY AND SUBURBAN  
TYPE O-45

OVER TWO HUNDRED OF THESE "MAXIMUM TRACTION" TRUCKS ARE IN SERVICE IN BROOKLYN, NEW YORK, AND ARE PRONOUNCED "HIGHLY SATISFACTORY."

STANDARD MOTOR TRUCK COMPANY, FRICK BUILDING, PITTSBURGH, PENNSYLVANIA  
NEW YORK OFFICE: 170 BROADWAY WORKS: NEW CASTLE, PA. CHICAGO OFFICE: FISHER BUILDING

For CABLE, ELECTRIC and ELEVATED CARS

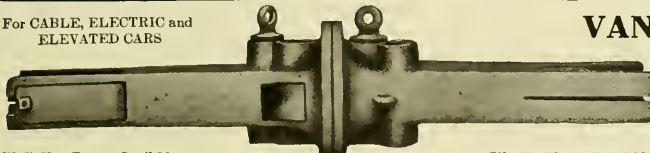

W. T. VAN DORN, Gen'l Manager.

No. 5

**VAN DORN AUTOMATIC COUPLERS**

The records go farther than talk. Look up the records. Send for booklet of information on Couplings.

W. T. VAN DORN COMPANY, 1076 S. Paulina Street, CHICAGO

**TROLLEY WIRE, BARE COPPER CABLES WEATHERPROOF WIRE AND CABLES**

RUBBER COVERED CABLES AND LEAD COVERED UNDERGROUND CABLES FOR ANY SERVICE. WRITE US FOR SPECIAL PRICES AT THIS TIME

**STANDARD UNDERGROUND CABLE CO.**

Pittsburg New York Boston St. Louis San Francisco Chicago Philadelphia Los Angeles Atlanta

**The Green Fuel Economizer Co.**

MATTEAWAN, N. Y.

New York, Boston, Chicago, Atlanta, San Francisco, Los Angeles, Seattle, Salt Lake City, Montreal.

Engineers: Builders of Green's Fuel Economizers, Fans, Blowers and Exhausters, Steam Air Heater Coils, Waste Heat Air Heaters, Mechanical Draft, Heating and Ventilating and Drying Apparatus, Draft Dampers and Engines.

WRITE FOR CATALOGS.

**In Buying Waste It is Important to Know—**

- FIRST—That it is free from dirt and grit.
- SECOND—That it is easy to pack.
- THIRD—That it is made up of all long strands.
- FOURTH—That it will absorb the oil in a manner insuring a free and even lubrication.

Hagy Waste meets specific conditions and ordinary ones

**The J. Milton Hagy Waste Works**

433 Spruce Street Philadelphia

**ALUMINUM**

**Railway Feeders**

And all kinds of **Electrical Conductors**

Aluminum Feeders are less than one-half the weight of copper feeders and are of equal conductivity and strength. If insulated wire or cable is required, high grade insulation is guaranteed.

Write for prices and full information.

**Aluminum Company of America**

PITTSBURGH, PA.

Formerly The Pittsburgh Reduction Company

# TUBULAR POLES

## IRON OR STEEL



FOR

**ELECTRIC RAILWAYS**

**ELECTRIC LIGHTING CO'S**

**SIGNAL** } SER  
**TELEPHONE** } VICE  
**TELEGRAPH** }

**TRANSMISSION**

**LINE** ~

AND

**CATENARY**

**SUSPENSION**

**LINE** ~

**ELECTRIC RAILWAY EQUIPMENT CO.**  
 General Office: CINCINNATI-O-U-S-A  
 Shops: READING PA - WHEELING WVA

# HEINE WATER TUBE BOILERS

are designed and built with special reference to safety and durability.

They are made of the very best materials for the purpose of giving satisfactory service for many years. Hence they are not cheap in first cost, but they are most economical in the long run.

Our little book, "*Boiler Logic*," is quite interesting.

A complimentary copy by return mail, if you want it.

## HEINE SAFETY BOILER CO.

421 Olive St., ST. LOUIS, MO.

2

# THE BABCOCK & WILCOX COMPANY

85 Liberty Street, New York

Babcock & Wilcox — Stirling — A & T Horizontal — Cahall Vertical

# WATER TUBE STEAM BOILERS

STEAM SUPERHEATERS

Works: Bayonne, N. J. Barberton, Ohio.

BRANCH OFFICES:

MECHANICAL STOKERS

BOSTON, Delta Bldg.  
 PHILADELPHIA, 1110-1112 North American Bldg.  
 SAN FRANCISCO, 63 First Street  
 PITTSBURGH, Farmers Deposit Nat. Bank Bldg.  
 NEW ORLEANS, 343 Baronne St.

DENVER, 410 Seventeenth St.  
 SALT LAKE CITY, 313 Atlas Block  
 WASHINGTON, Colorado Building  
 CHICAGO, Marquette Bldg.  
 ATLANTA, GA., 1132 Candler Bldg.

CLEVELAND, 706 New England Bldg.  
 MEXICO CITY, 7 Avenida, Juarez  
 HAVANA, CUBA, 116 1/2 Calle de la Habana  
 LOS ANGELES, 321 Trust Bldg.  
 CINCINNATI, O., Traction Bldg.

**Avoid Accidents**

By Using This Switch

SPECIAL TRACK WORK OF EVERY DESCRIPTION

**New York Switch & Crossing Co.**

HOBOKEN, N. J.



## Anti-Straddling or Anti-Kicking Tongue Switch

It will not drive down at the heel, because it is held to either side with a spring tension and firmly down on its bed. A car can not straddle this tongue.

WRITE FOR SPECIAL CIRCULAR

# The Knutson Trolley Retriever



—most successfully used by high-speed electric railways because it is a *real* retriever—not a mere catcher with a misleading name.

And there is a mighty big difference between the Knutson and all others! Better investigate fully *before* you spend your money.

Write us for facts or send for a sample lot to test on your road at our expense.

## The Trolley Supply Co.

Canton, Ohio

10

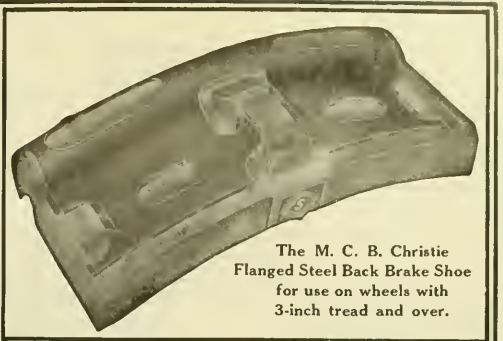

The M. C. B. Christie Flanged Steel Back Brake Shoe for use on wheels with 3-inch tread and over.

# Why Use Steel Back Brake Shoes?

Because our M. C. B. Christie type steel back shoes are stronger, safer and wear longer than others.

That means the maximum of useful wear, because the shoes can be worn thin. They scrap at about 20% of their weight. Many of the antiquated combined brake heads and shoes scrap at 50%.

Steel back brake shoes of our make are the only absolutely safe shoes for heavy and high-speed equipment. They are made both flanged and unflanged and for both wide and narrow treads.

We can show you how to eliminate brake shoe troubles and save brake shoe money. Just write our nearest office.

# BUCKEYE ENGINE CO.

SALEM, OHIO

Builders of High Class

## STEAM AND GAS ENGINES

in powers from 25 to 10,000 H. P.

Correspond with us before placing orders.

Catalogues on application.

# American Brake Shoe & Foundry Company

Mahwah, N. J.

170 Broadway  
New York

Western Union Bldg.  
Chicago

9

**THE ARNOLD COMPANY**  
ENGINEERS-CONSTRUCTORS  
ELECTRICAL - CIVIL - MECHANICAL  
101 LA SALLE STREET  
CHICAGO

**H. M. Bylesby & Company**  
Incorporated  
ENGINEERS  
American Trust Bldg., Chicago

Design, Construct and Operate  
Railway, Light, Power and  
Hydraulic Plants

EXAMINATIONS AND  
REPORTS

**J. G. WHITE & COMPANY**  
INCORPORATED  
**Engineers, Contractors**

43-49 Exchange Place,  
41-43 Wall Street

**New York, N. Y.**

Principal Philippine Office: Manila, P. I.

**Complete Plants for the Rapid  
Handling of Material**

Every Sort of Hoisting Apparatus

BROWN HOISTING MACHINERY CO. Cleveland, Ohio

**SANDERSON & PORTER**

**ENGINEERS AND CONTRACTORS**

EXAMINATIONS - REPORTS - DESIGNS - SPECIFICATIONS  
CONSTRUCTION - EQUIPMENT - SUPERVISION AND MANAGEMENT

OF RAILWAY, LIGHT AND POWER PROPERTIES

HYDRO-ELECTRIC DEVELOPMENTS  
52 WILLIAM STREET NEW YORK

**Send Us Your Book List**

We publish a number of standard works on railway and allied subjects, both electric and steam. We sell all that are in print. Write us.

**The Wilson Company** 160 Harrison Street  
CHICAGO

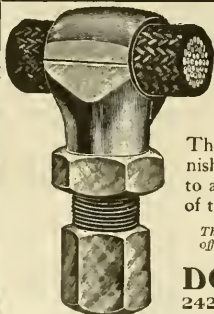

**Dossier Solderless  
Cable Taps  
are Economical**

These connectors will be furnished to tap from any size Main to any size Branch. No cutting of the cable. Save their cost in cable.

The standard for splicing. The only officially approved mechanical joint.

**DOSSERT & CO.**  
242 W. 41st Street, New York

**A. L. REGISTER & CO.**

Engineers and General Contractors—Electric Railways  
112 North Broad St. PHILADELPHIA, PA. Established 1889

**SHIMER & CHASE CO.**

**Experienced Promoters of Electrical Railway Projects**  
Correspondence Solicited OMAHA, NEB.

**CENTRAL INSPECTION BUREAU**

Inspection of Rails, Ties, Cars, Motors, Bridges, Buildings, Etc.

17 STATE STREET - - - NEW YORK CITY

**LINE MATERIAL**

ELECTRIC SUPPLIES FOR RAILWAYS, POWER PLANTS, ETC.  
THE CREADHEAD ENGINEERING CO., 348 Main Street, Cincinnati, Ohio

**SMITH CONCRETE MIXER**

does the work better, quicker, cheaper and lasts longer.

CONTRACTORS' SUPPLY & EQUIPMENT COMPANY  
Old Colony Building, Chicago 170 Broadway, New York 9

A. U. Jaastad

P. J. Harleman

F. E. Greenwood

**SHEAFF & JAASTAD**

ENGINEERS

Broad Exchange Building, 88 Broad Street, BOSTON, MASS.

**Gongs** For Street Cars **Bells**  
G. C. REITER, Canton, Ohio

**HOT WATER HEATERS FOR CARS**

THE PETER SMITH HEATER COMPANY, Detroit, Mich.

**BRAKESHOES**  
STANDARD  
BRAKESHOE COMPANY  
GEN'L OFFICES & WORKS - AURORA, ILL. - CHICAGO OFFICE 310 IVY EXCH.

WRITE TO **MODEL STOKER COMPANY** DAYTON OHIO

for detailed information about the best  
**AUTOMATIC SMOKELESS FURNACE**

**GEARS AND PINIONS**

FOR ALL TYPES OF MOTORS

THE VAN DORN & DUTTON CO., CLEVELAND, OHIO

**RE-ENFORCED SPOKE WHEELS**

For City and Suburban Cars

ST. LOUIS CAR WHEEL CO., St. Louis, Mo.

**ELECTRIC HEATERS** For All Classes of Cars

New York Consolidated Car-Heating Co. Chicago

**WHEEL TRUING BRAKE SHOES**

Repair Crippled Wheels While Running

THE WHEEL TRUING BRAKE SHOE CO., Detroit, Mich.

SPRINGS—TIRES—STEEL-TIRED WHEELS

**RAILWAY STEEL-SPRING CO.**

General Offices: 71 Broadway, New York

**For Sale** Cards produce results in the  
Electric Railway Review

# Baltimore Center and Side Bearings

## FOR ELECTRIC TRUCKS

**Impossible  
to Clog  
Balls**

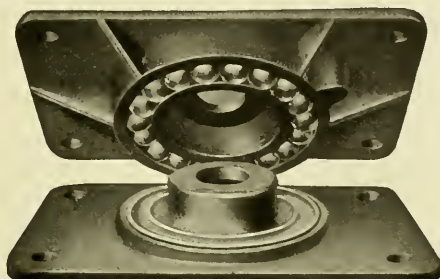

**No  
Lubrication  
Necessary**

**SAVES:** { FLANGE WEAR  
RAIL WEAR  
TRUCK REPAIRS

**DURABILITY:** { PROVEN  
UNDER  
HEAVIEST  
LOADS

BALTIMORE  
MD.

**THE T. H. SYMINGTON CO.**

CHICAGO  
ILL.

# Galena-Signal Oil Company

FRANKLIN, PA.

THEIR SPECIALTIES

**STREET RAILWAY LUBRICATION** including both rolling stock and power house equipment.

Same skillful *expert supervision* given in this service as in steam railway service has produced very satisfactory results. The business of our Street Railway Department has increased beyond every expectation. In 1906 this department sold ten times the number of barrels of oil sold by the same department in 1903.

We are under contract with many of the largest street and interurban railways of the country.

We guarantee cost per thousand miles in street railway service when conditions warrant it.

Write to Franklin, Pennsylvania, for further particulars.

**STEAM RAILWAY LUBRICATION** Sole manufacturers of the celebrated *Galena Coach, Engine and Car Oils* for steam railway lubrication. *Sibley's Perfection Valve Oil* for cylinder lubrication, and *Perfection Signal Oil* for use in railway signal lanterns.

**GALENA RAILWAY SAFETY OIL** Made especially for use in headlights, cab, classification

and tail lights, and for switch and semaphore lamps. Burns equally well with the long time as with the one-day burner; with or without chimney as the burner requires. Is pure water white in color; high fire test, low cold test, and splendid gravity.

CHAS. MILLER, President

# Shawmut Soldered Bond Cap

to make over your  
PLUG BONDS



Why not look this up

**CHASE-SHAWMUT CO.**

Newburyport, Mass.

# The Macallen Company

FORMERLY THE W. T. C. MACALLEN CO.

## Electric Railway Material

### BRASS FOUNDERS

Foundry and Division Sts., Boston, Mass.

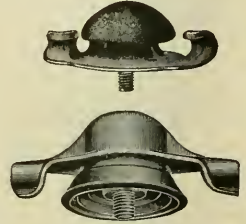

ELECTRIC SERVICE SUPPLIES CO.	Philadelphia, Pa.
ELECTRIC SERVICE SUPPLIES CO.	Chicago, Ill.
OTTO NEISSER	Los Angeles, Cal.
FRANK RIDLON CO.	Boston, Mass.
F. BISSELL COMPANY	Toledo, Ohio
JAS. CLARK, Jr. & CO.	Louisville, Ky.
J. A. DAWSON & CO.	Montreal and Winnipeg, Canada

## THE NATIONAL LOCK WASHER CO., NEWARK, N. J.

Curtains - Curtain Fixtures - Sash Locks - Sash Balances - Nut Locks

CHICAGO OFFICE: 419 MONADNOCK BLOCK

### THE MIGHTY MIDGET

## HOT WATER CAR HEATER

Adapted for Large Electric Cars and Long Distance Lines. Exclusively used on Largest Electric Systems. Ask for Catalog

THE WILLIAM C. BAKER HEATING & SUPPLY CO., 143 LIBERTY STREET NEW YORK

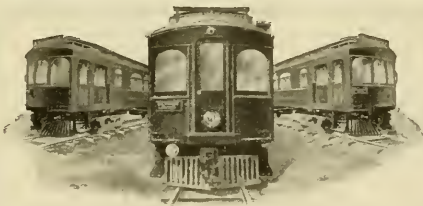

## NILES CARS — THE ELECTRIC PULLMANS

LARGE, FAST INTERURBANS  
OUR SPECIALTY

### NILES CAR & MFG. COMPANY

WORKS: NILES, OHIO Sales Office: J. A. HANNA Co., 312 Electric Bldg., Cleveland, O.



Factory of The Milloy Electric Company  
Bucyrus, Ohio

## The Milloy Trolley Base

built in our new and specially equipped factory, insures a quality which will give excellent service under ordinary and extraordinary conditions.

The Milloy Base is unusually low, has even tension on high or low wire. Has no fulcrum, no friction, no oil, no center post. Always efficient. Particulars on request.

THE MILLOY ELECTRIC COMPANY  
Bucyrus, Ohio

## Hydraulic Wheel Presses

Our Special Forcing Press Catalogue contains eighteen different types of wheel presses, comprising vertical, inclined and horizontal types; hand, belt and electric driven, in sizes from 30 to 600 ton capacity.

Each tool thoroughly guaranteed.

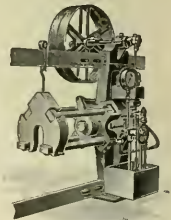

Send for Forcing Press Catalogue No. 70.

### THE WATSON-STILLMAN CO.

26 Cortlandt Street, New York City  
Branch Office: 453 The Rookery, Chicago, Ill.



# FOR SALE. FOR QUICK DELIVERY

## 6 55-ft. Passenger, Baggage and Smoking Car Bodies

Main Compartment 26' 0"  
 Smoking " 10' 6"  
 Baggage " 10' 0"  
 Seating Capacity, 54

## 8 60-ft. Passenger, Baggage and Smoking Car Bodies

Main Compartment 28' 6"  
 Smoking " 11' 0"  
 Baggage " 8' 0"  
 Seating Capacity, 58

## 5 52-ft. Passenger and Smoking Car Bodies — Double End

Seating Capacity, 60

## 3 52-ft. Passenger and Baggage Car Bodies — Double End

Seating Capacity, 56

## 2 50-ft. Express Car Bodies

*Write or wire us for further information.*

**The Jewett Car Co. Newark Ohio**

## Hart Convertible CONSTRUCTION BALLAST CAR and GONDOLA

A Center-Dump, Side-Dump and Flat-Bottom Gondola—All in One

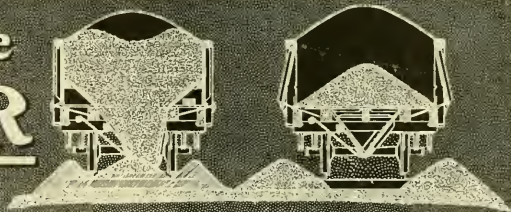

Diagonal shading shows position of ballast after being spread by the Rodger Distributing Car which follows the Hopper cars

**Rodger Ballast Car Co. Railway Exchange, CHICAGO.**

# Steel Passenger Cars and Trucks

For Steam and Electric Railways

Steel and Composite Freight Cars for all Classes of Service

# Pressed Steel Car Co.

NEW YORK, PITTSBURGH, CHICAGO, ST. LOUIS, ATLANTA, MEXICO CITY, BUENOS AIRES, SYDNEY, N. S. W.

# Baldwin Locomotive Works

BURNHAM, WILLIAMS & CO., PHILADELPHIA, PA., U. S. A.

Builders of  
**LOCOMOTIVES**  
of every description  
including  
**ELECTRIC  
LOCOMOTIVES**

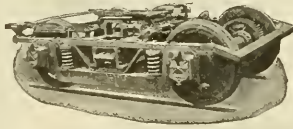

## ELECTRIC TRUCKS

# Standard Steel Works Co.

HARRISON BLDG., PHILA., PA., U. S. A.

New York, N. Y. Cleveland, O. St. Louis, Mo. Denver, Colo.  
Portland, Ore. Richmond, Va. Chicago, Ill. St. Paul, Minn.  
San Francisco, Cal. Seattle, Wash. Winnipeg, Can

**Solid Forged  
Rolled and Steel Tired Wheels**

Mounted on axles fitted with Motor Gears  
for Electric Railway Service.

**LOCOMOTIVE TIRES RAILWAY SPRINGS  
FORGINGS CASTINGS**



We've eliminated machine work in

**Lumen Metal Mold Axle Bearings.**

Our claim that these bearings will effect a saving of about  
30 per cent is worth investigating. Write us—today!

Buffalo **LUMEN BEARING CO.** Toronto



CONTINUOUS JOINT

Over  
25,000  
miles  
in use



WEBER JOINT

Rolled  
from  
Best Quality  
Steel



WOLHAUPTER JOINT

Catalogs at Agencies  
Baltimore, Md. Portland, Ore.  
Boston, Mass. Seattle, Wash.  
Chicago, Ill. St. Paul, Minn.  
Denver, Colo. St. Louis, Mo.  
Pittsburg, Pa. Troy, N. Y.  
London, Eng. Montreal, Can.

HIGHEST AWARDS—Paris, 1900;  
Buffalo, 1901; St. Louis, 1904

Additional safety and economy in **Track Maintenance** has been proved  
by the use of Continuous, Weber and Wolhaupter base-supported rail  
joints—after ten (10) years' service, having a record of over **25,000**  
miles in use—the extent of which is evidence of their excellence.

## THE RAIL JOINT COMPANY

General Offices: 29 West 34th Street, New York City  
Makers of Rail Joints for Standard and Special Rail Sections, also  
Girder, Step or Compromise, and Insulating Rail Joints, protected by  
patents in United States and Foreign Countries.

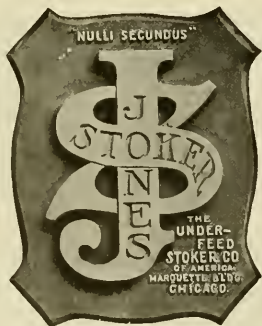

# PIPE FITTINGS AND VALVES

FOR THE  
HEATING AND PLUMBING TRADE

TRADE  MARK

**JOHN SIMMONS Co.**  
104-110 Centre Street, NEW YORK

IF YOU wish to keep posted on  
all steam railway matters you  
must read **THE RAILWAY AGE**, for  
it is the leading railway journal of  
the world and the only one that  
covers all phases of the industry.

Sample copies sent on request.

## THE RAILWAY AGE

160 HARRISON STREET - - CHICAGO

# Your road needs the Telegraph Signal System

No signal system approaches it in positive results which produce safe operation, or in economical cost, both of installation and maintenance. One bare iron wire only is required for signaling. One dollar a month per station pays the maintenance. One bad smashup will pay many times over for installation. Delays are dangerous! Don't put off investigation another day! Write today—*now*.

**Telegraph Signal Company** 282 State Street  
Rochester, N. Y. 12

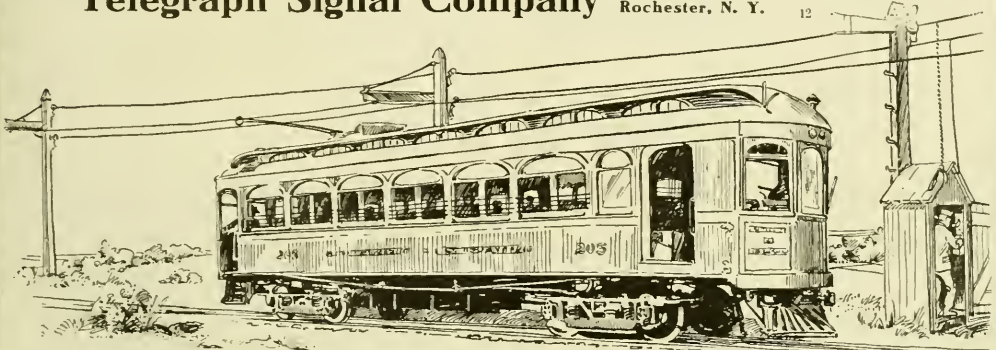

## Roads that are using Whitmore's Gear Protective Composition

have reduced their gear and pinion cost one half what it previously cost with other lubricants. The proof of this the users will substantiate.

**The Whitmore Manufacturing Company**  
LUBRICATING ENGINEERS  
Cleveland, Ohio, U. S. A.

## "Not an Experiment"

The Providence Fender is the Children's Fender. It is equally as effective in saving a child, and the person who has stumbled, as it is in saving those who are on their feet.

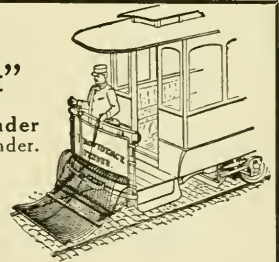

**CONSOLIDATED CAR FENDER COMPANY**  
Office and Factory: PROVIDENCE, R. I.  
Branch Office: 110 E. Twenty-third St., New York  
European Agents: Comptoir d'Electricite, 6, Rue Bondreau, Paris, France

## Queen Testing Sets

"The Recognized Standard"

- Voltmeters
- Ammeters
- Switchboard and Portable
- Alternating and Direct Current



Queen Acme Testing Set

- U. S. Standard Testing Sets
- Rail Bond Testers
- Galvanometers, etc., etc.
- Electrical Instruments for All Purposes

**QUEEN & CO., Inc., Philadelphia, Pa.**

## WESTON Standard Portable Direct-Reading

- Voltmeters
- Millivoltmeters
- Voltammeters
- Ammeters
- Milliammeters
- Ohmmeters
- Ground Detectors and Circuit Testers



Our STATION VOLT METERS and AMMETERS are unsurpassed in point of extreme accuracy and low consumption of energy.

**WESTON ELECTRICAL INSTRUMENT CO.**  
Main Office and Works: Waverly Park, Newark, N. J.

London Branch: Audrey House, Ely Place, Holborn, Paris, France: E. H. Cadot, 12 Rue St. Georges. New York Office: 74 Cortlandt St. Berlin: European Weston Electrical Instrument Co., Ritterstrasse, No. 88.

# CLASSIFIED ADVERTISEMENTS

Undeveloped advertisements are inserted under this heading at the uniform rate of one cent a word; minimum charge twenty-five cents. Replies directed to this office will be forwarded when required to any address in the United States, Canada or Mexico without extra charge. Advertisements received at the Chicago office by 9 a. m. Thursday will appear in the issue for the same week.

## POSITIONS WANTED.

Detective, thoroughly experienced all-round inside man, open for engagement. Best of references. Address "No. 574," care of Electric Railway Review, Chicago.

Wanted—A young man experienced in street railway and electric light accounting desires position as auditor. Best of references as to character and ability. Address "No. 573," care of Electric Railway Review, Chicago.

Stenographer and office man with number of years' experience in railway supply business desires to secure position with good firm. Best reference. Would leave city. Address "No. 571," care of Electric Railway Review, Chicago.

Position as chief clerk or auditor by young single man with seven years' experience electric railway work. Good knowledge of operating department; exceptional references. Address "No. 555," care of Electric Railway Review, Chicago.

Position as superintendent or assistant to general manager wanted. Eighteen years' experience in railway work. For the last six years have been superintendent of an electric railway company. Can get best of references from present employers. Can also give good reason for wishing to make change. Address "No. 572," care of Electric Railway Review, Chicago.

Young man familiar with overhead construction of all kinds (including catenary), installation of transformers, lighting, telephones and substation work; also some experience on car and switchboard work, desires position with city or interurban road. Employed but desires change. Best of references. Address "No. 576," care of Electric Railway Review, Chicago.

Position wanted as auditor and accountant. Sixteen years of steam, electric and general experience; good working knowledge of details of general contracting business; clever buyer; possess ability to organize. Can furnish first-class reference as to character and ability and work accomplished in past; leaving present work because closed; at liberty to accept position any time. Address "No. 575," care of Electric Railway Review, Chicago.

## POSITIONS WANTED.

Position as chief engineer and machinist wanted. Will go to responsible company on trial. Have held 25 years' practical experience. Address "No. 563," care of Electric Railway Review, Chicago.

Management of street railway amusement park wanted; experienced, up-to-date, sober and reliable. Park playing vaudeville and bands preferred. Experienced in park designing and construction. Best of references. Don't put it off, write me today. Address E. B. Wilmarth, Massillon, Ia.

Wanted—To correspond with company needing the services of high-class general manager or general superintendent. Electrical and civil engineer; 17 years' experience with large properties and in construction and operation. Address "No. 568," care of Electric Railway Review, Chicago.

An experienced supply salesman, who also has had thirteen years' operating experience on city lines, desires to form connection with a railway supply house handling either electric or steam supplies or both. Would consider proposition to open sales agency. Address "No. 566," care of Electric Railway Review, Chicago.

Experienced electrical engineer wants position with manufacturing concern or with company operating electric railways. Graduate Purdue University, 1905. Will go anywhere for permanent position. Age 26; married; A No. 1 references as to habits and ability. Address "No. 570," care of Electric Railway Review, Chicago.

Master mechanic of undeniable ability and experience is at liberty to accept reasonable offer. Has had 15 years' experience in both steam and electric service. Has exceptional ability in equipping new rolling stock and handling shops and men on economical basis. Address "No. 560," care of Electric Railway Review, Chicago.

## POSITIONS OPEN.

Park superintendent wanted. State experience and salary wanted; also give references. Address "No. 561," care of Electric Railway Review, Chicago.

## POSITIONS OPEN.

Superintendents, street railway, machine shop, car works, power house, engineers, electrical and mechanical, draftsmen, electrical and mechanical. Salaries, \$800 to \$5,000. Other positions open. Write, HAP-GOODS, 646 Broadway, New York, or 1010 Hartford Bldg., Chicago.

A thoroughly competent superintendent wanted to take charge of 163 miles of electric railway track to join the overhead work. Must be fully conversant with latest developments in track and overhead work. Send full particulars regarding experience, age and salary required. B. C. Electric Railway Co., Ltd., Vancouver.

## BUSINESS OPPORTUNITIES.

Wanted—Man with some capital and a knowledge of railway track supplies to join the advertiser—a salesman handling locomotive and car supplies—in a general railway supply business. Address "No. 558," care of Electric Railway Review, Chicago.

Don't throw away your old batteries. We have a preparation which will positively renew old dry batteries at the cost of two cents each. Trial package and electrical catalogue 10 cents. Adams Electric Co., Dept. E. R., Kewanee, Ill.

## MISCELLANEOUS WANTS.

Want to buy second-hand equipment, machinery or material? A card inserted in the Electric Railway Review, stating just what you want, will bring immediate response. The cost is small—only \$1.20 an inch (measuring 1 inch deep by 1 1/2 inches wide) per insertion. Send orders to Electric Railway Review, 160 Harrison St., Chicago.

What have you to sell in the way of second-hand equipment, machinery or material? Buyers read the "For Sale" cards on the following page and there is the place to tell your story. "For Sale" cards are inexpensive—only \$1.20 an inch (measuring 1 inch deep by 1 1/2 inches wide) per insertion. Special rates on contracts for 100 inches or more to be used within one year. Now is the time to send your order to Electric Railway Review, 160 Harrison St., Chicago.

## BOOKS AND PUBLICATIONS.

Wanted—Copies of the Street Railway Review of July 20, 1904, and June, 1906. State condition and price. Address "No. 577," care of Electric Railway Review, Chicago.

Ask us about any book on electric railway and allied subjects. We publish some and sell all that are in print. The Wilson Company, 160 Harrison Street, Chicago.

Wanted—Copies of the Street Railway Review of April, 1900, May, 1901, and August, 1902. State price and condition. Address "No. 553," care of Electric Railway Review, Chicago.

We want your friends to read the Electric Railway Review. You will do them—and us—a favor by sending their addresses. We will gladly mail free sample copies. Electric Railway Review, 160 Harrison Street, Chicago.

If interested in any phase of steam transportation, you will find every development covered fully and accurately in The Railway Age. It is the leader and acknowledged authority in this field. Ask for free sample copies. The Railway Age, 160 Harrison Street, Chicago.

A copy of "The Motorman and His Duties," the standard handbook on the theory and practice of electric car operation, is worth many times its cost to every man interested in the subject. Send for 16-page pamphlet of sample pages. The Wilson Company, 160 Harrison Street, Chicago.

Interstate commerce national legislation to July 1, 1906, is fully covered in our reference pamphlet. It contains the full text of the act to regulate commerce as amended, including the Elkins and Hepburn acts, and of the supplementary act relating to the testimony of witnesses before the interstate commerce commission. It also contains the texts of the expedition act, the anti-trust act of 1890, the employers' liability act and the safety equipment laws. Difference in type shows the parts expunged from, and the parts added to, the interstate commerce and Elkins acts by the Hepburn act. This pamphlet is of special value to railway men and lawyers. Mailed prepaid for 25 cents in stamps or coin. Special prices for quantities. The Wilson Company, 160 Harrison St., Chicago.

# Want Ads

25 cents for any number of words under 25—more than 25 words, one cent a word per insertion. Replies forwarded without charge. Want Ads produce results—

# Try them

**FOR SALE: Three Car Bodies and Three Pairs of Double Trucks**  
 with or without electric equipment and air brakes; all new and never used. Compelled to sell, as these cars will not operate over a leased line by reason of their width and length.  
**R. W. MARSHALL & CO., 97 Liberty St., New York, N. Y.**

**Rare Bargains in RAILS AND EQUIPMENT**  
 WALTER A. **"ZELNICKER"** SUPPLY CO.  
 In ST. LOUIS  
 DO YOU RECEIVE OUR STOCK LISTS?

**FOR SALE: A number of Nine-Bench Open Motor Cars,**  
 monitor decks, in good condition.  
 Address: **Rockford & Interurban Ry. Co.,**  
 Rockford, Ill.

One cent a word for want ads in the Electric Railway Review.

**NO SNOW TO DELAY CARS**  
 The Russell Snow-Plow is used by more than 50 roads to maintain schedules and prevent blockades.  
 Russell Car & Snow-Plow Co., Ridgway, Pa.  
 Wendell & MacDuffie, Coriandt St., New York; C. A. Ralston, Fisher Bldg., Chicago; Robinson & Cary Co. Saint Paul.  
**IF YOU HAVE A RUSSELL**

**R.W. MARSHALL & CO.**  
 95 and 97 Liberty St., NEW YORK  
 Second-Hand Machinery and Equipment  
**ELECTRIC RAILWAY MATERIALS**

Established 1877.  
**ALBERT & J. M. ANDERSON MFG. CO.,**  
 Makers of  
**ELECTRICAL APPLIANCES: SWITCHES, SWITCHBOARDS, TIME SWITCHES, LINE MATERIAL, COPPER CASTINGS (75% CONDUCTIVITY. 289-293 A ST., BOSTON, MASS., U. S. A.**  
 Branches: New York, 135 Broadway. Chicago, 175 Dearborn Street.  
 Agencies: Boston, Pettigell-Andrews Co. San Francisco, Eccles & Smith Co.  
 New York, R. W. Marshall & Co. Atlanta, Newcomer Manry Co.  
 St. Louis, J. C. White. Denver, E. M. Messiter.  
 Toronto, Ont., H. J. Surtees.

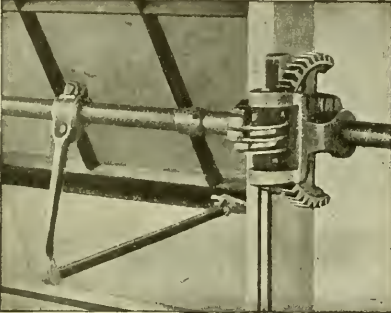

**The Ventilation**  
 of your Shops, Foundries and Car Barns is made especially effective by a speedy, positive and easily manipulated **Sash Operating Apparatus** which automatically locks the sash at any position.  
*Let us send you our catalogue.*  
**Lord & Burnham Company**  
 Irvington-on-Hudson, N. Y.

**AUTOMATIC TROLLEY GUARD**  
*"It puts the wheel on the wire"*  
*"It puts the wheel on the wire"*  
**Prevents Accidents**  
**Increases Safety**  
 when installed at steam railway crossings, subways or under crossings, or on curves, bridges or other dangerous places. Not like other trolley guards with which you are familiar.  
*Send for detailed description, please.*  
**Automatic Trolley Guard Co.** 391-393 **Buffalo, N. Y.**

**"For Sale" and "Wanted" Cards**  
 especially for the marketing of second-hand equipment, machinery, material, etc., are carried on this page at a uniform rate of **\$1.20 an inch** (measuring 1 inch deep by 1 1/2 inches wide) per insertion.  
*Send orders to*  
**Electric Railway Review**  
 160 Harrison Street - - - CHICAGO

Special rates made on contracts covering 100 inches or more.

**The Lindsley Brothers Company**  
 Producers and Shippers of **WESTERN CEDAR POLES** and Manufacturers of **RED FIR CROSS ARMS**  
 Eastern Sales Office, Monadnock Bldg., CHICAGO SPOKANE, WASHINGTON

**POLES and PILING** 20,000 35s and 40s, Ready to Ship at Once  
 S-E. MISSOURI CYPRESS CO., CAMPBELL, MO.

**GRIFFIN WHEEL CO.**  
 CHICAGO  
 CHILLED IRON CAR WHEELS IRON OR STEEL AXLES

**G. H. BARNES HARDWOOD LUMBER CO.**  
 Office and Yard: Main and Warren Sts., ST. LOUIS, MO.  
 Ties, Car Oak, Poplar, Ash, Cherry, Plain and Quartered Oak

We are Producers and Wholesale Dealers in Western  
**CEDAR POLES**  
 Yards in Washington, Idaho, Montana and British Columbia  
 WRITE US FOR DELIVERED PRICES  
**CHURCHILL CEDAR CO.,** Box 1409, Spokane, Wash.

For prompt deliveries of  
**Cedar Poles** Red or White  
 write either office today.  
**NATIONAL POLE COMPANY**  
 EVERETT, WASH. ESCANABA, MICH. 3

**C. H. WORCESTER CO.**  
**CEDAR POLES**  
 PRODUCERS AND WHOLESALERS  
 Suite 1710 Tribune Building CHICAGO

**Idaho Cedar Poles**  
 PACIFIC COAST POLE CO. SPOKANE, WASH.

**Poles and Ties**  
 A Selected Stock in Chicago for Rush Shipment  
 A Number of Large Yards in the North  
**NAUGLE POLE & TIE CO.**  
 CHICAGO OFFICE: 226 LA SALLE STREET

INSULATING VARNISHES (BAKING; AIR-DRYING) COMPOUNDS TAPE  
  
 Possess the Highest Insulative Efficiency.  
 The Standard Paint Co.  
 100 William St. New York.

**BERTHOLD & JENNINGS**  
 LUMBERMENS' BLDG. SAINT LOUIS, MO.  
**TIMBERS**  
 L. L. Pine, Oak  
**POLES**  
 Cedar, Cypress, Chestnut  
**TIES**  
 Oak, Cypress, Chestnut

**WHITE CEDAR POLES** Large Stock 14 to 65 ft. Prompt Shipment  
**POLES**  
**YARDS:** Menominee, Mich. Escanaba, Mich. Superior, Wis. Deer River, Minn.  
**FRANCIS BEIDLER & CO.** Chicago, Ill.

**ANY BOOK** on Railway and Allied Subjects now in print sent prepaid upon receipt of price by  
**THE WILSON CO.,** 160 HARRISON STREET CHICAGO



W. E.

# D. C. GENERATORS

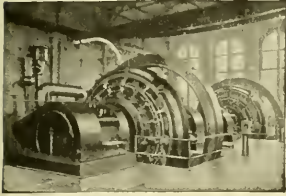

have the highest average or all-day efficiency

One of the reasons is because we use laminated cast-in pole pieces.

There are many other good reasons that our Bulletin No. 5112-C will tell you all about. Write today.

PROMPT DELIVERIES

# CAR CURTAINS

Did you ever stop to think how much is added to the appearance of your cars by tasteful window curtains?

Let us give you an estimate upon new ones for those cars you are renovating.

## The Curtain Supply Company

Main Office and Works,  
83-93 Ohio Street, CHICAGO, ILL.  
530 Mission Street SAN FRANCISCO 1819 Park Row Bldg. NEW YORK

## Perfect Ventilation

of power houses, car shops and barns is best accomplished by the

## Lovell Window Operator

because of its positive, quick and easy operation, and its strong, simple and durable construction.

Any length of windows up to 500 feet may be opened or closed from one station, and the farthest windows operate in unison with those nearest. A boy is strong enough to do it.

The windows in any run may be opened just as much or just as little as may be required and locked open at that particular point. Any desired change is made quickly and easily.

Before deciding upon building or reconstruction plans, make it a point to know about the Lovell Window Operator—made only by

## THE G. DROUVÉ CO.

Bridgeport, Conn., U. S. A.

Western Office: 40 Dearborn Street, Chicago



Passenger Paying Fare

Yes! It is safe to use the

## Rooke Automatic Fare Collector

because it is accurate, reliable and non-tamperable

Any attempt made to interfere with its mechanism breaks a seal and affords indisputable evidence of the attempt.

Rooke Automatic Register Co.  
Providence, Rhode Island

# National

Motor-Driven

# Air Compressors

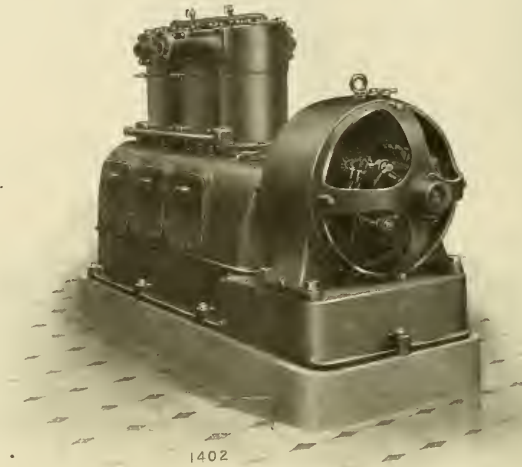

150 Cubic Foot "3VS" Type Air Compressor with Direct Current Motor

These compressors are especially adapted for service in car shops where compressed air is used for various purposes, such as drilling, chipping and riveting, for operating air hoists and air jacks, and for blowing dust and other matter out of car motors, controllers, seats, etc. They are of the single stage type, and are designed to stand hard service and usage. Either direct or alternating current motors can be furnished for operating same. Built in capacities of 50, 100, 150 and 225 cubic feet of free air per minute.

Write for Bulletin 84F.

**National Brake & Electric Co.**  
Milwaukee, U. S. A.

NEW YORK: 111 Broadway

PHILADELPHIA:

W. H. Goble, 1722 Westmoreland St.

General Sales Office

519 First National Bank Building

CHICAGO

BOSTON: F. E. Huntress, 131 State Street

SAN FRANCISCO, CAL.:

W. F. McKenny, 69-71 First Street

LONDON: 14 Great Smith St., Westminster



# Electric Railway Review

PUBLISHED EVERY SATURDAY BY THE WILSON COMPANY, CHICAGO

Entered as second-class matter January 5, 1907, at the postoffice at Chicago, Ill., under the act of March 3, 1879.

160 Harrison Street, Chicago  
150 Nassau Street, New York  
1529 Williamson Bldg., Cleveland

VOL. XIX  
No. 14

CHICAGO, APRIL 4, 1908

Whole No.  
258

Subscription: Domestic . . . \$2  
Foreign . . . \$5  
Canada . . . \$3.50

Flaunt as abuses of transfers are, the limitation of transfer points to a very few intersecting lines of track sometimes tends to increase the congestion of traffic on very busy systems. Any system that encourages the distribution of travel is preferable to the concentration of transfer movement at a very few points. The even distribution of travel on cars going in the same general direction is a great help to the maintenance of good service, both in urban and interurban transit. It is difficult to prevent overcrowding under the most favorable conditions, and if transfers are too restricted in the matter of intersection points, at least in the busy sections of a city, the delays to car service may become troublesome. Ideal conditions are out of the question in the usual transfer problem, but when transfers are given by conductors undue restriction of the points of intersection not only decreases the flexibility of the service from the standpoint of the public, but tends to create excessively slow movements of cars and passengers at the remaining intersections at the street level. American street railways have been too liberal in the matter of transfers, but there still remain cases where the smoothness of car movement would be much bettered by a little wider application of the principle whereby a transfer is valid at all track intersections in the same general direction.

## Transfers and Traffic Congestion.

Recent studies and experiments made by the government forest service emphasize very clearly the importance of treating with preservatives the various woods more commonly used for street paving. The growing tendency toward the use of wood blocks in street paving warrants such studies. After many cities throughout the country had experienced decided failures with pavements of untreated native woods attention was turned to the use of these same woods after they had been subjected to various preservative treatments. In Baltimore, Md., in the summer of 1907 there were laid several adjacent strips of experimental pavement composed of the more generally used materials, such as asphalt, brick and creosoted wood. After five years of service and after passing through the great fire the wood was found to be in better condition than any of the other paving materials. Creosoting has generally been supposed to weaken timber. The results of recent experiments conducted by the forest service, however, indicate that the creosote itself does not lessen the strength of the timber, but that this weakening has been due chiefly to improper methods of impregnation. The same requirements which have caused creosote to supersede other preservatives for wood paving call for a larger proportion of high distilling constituents in creosote than is necessary in the preservation of timber for many other purposes. In paving material the necessity for the prevention of moisture absorption makes imperative the use of a larger amount of oil per cubic foot than ordinarily given to railroad ties or other construction timbers. To inject this amount of preservative material into the wood the vacuum-pressure method of treatment has recently been introduced. The experimental pavements now being watched by government engi-

## Preserving Paving Blocks.

neers will undoubtedly afford new light upon the subject of street surfaces which will be gladly received by electric railway track engineers.

An editorial article in a recent issue of the Railroad Gazette comments on the stability of electric railway earnings in periods of financial depression as compared with those of the steam roads. The article shows that for the month of December, 1907, a group of 18 fairly representative electric railways increased their earnings 2 per cent over December, 1906. In the same month 61 steam roads decreased 4.28 per cent. In January six electric roads increased their earnings 3.6 per cent, while 53 steam roads decreased 7.45 per cent. Although there is no assumption that these figures possess any comprehensive value as statistics, the results are at least significant as indicating the status of the electric railways as a public necessity which is not materially affected by hard times. A more important comparison is presented in the analysis of the earnings for January, 1908, of the New York New Haven & Hartford system, which includes 1,300 miles of electric railways, city, suburban and interurban, located in four states. The New Haven system presents the more favorable opportunity for comparison because during the year 1907 no important change was made in the mileage of either the steam or the electric lines and because in this case both classes of roads are affected equally by local conditions. In January, 1908, the gross earnings of the lines operated by steam fell off \$643,000, or 16 per cent, as compared with January, 1907, while the electric railway earnings in the same period decreased only \$21,000, or 2 per cent, and in one state there was a positive gain. While it must be considered that the small loss of the electric roads probably indicates what would have been an increase in normal times, the figures are interesting as showing the results of the first real test of the strength of the electric railways in resisting the effects of a period of stringency.

In his communication to the editors, published in last week's issue, J. C. Hutchins, president of the Detroit United Railway, referred with approval to the policy of the commonwealth of Massachusetts in granting indeterminate franchises. An indeterminate franchise presumably confers the right to operate perpetually if adequate service is afforded. Mr. Hutchins speaks of the studious and unemotional officials of governments in Massachusetts. These officials reflect the predominating sentiment of their constituents. In Massachusetts there is a powerful sentiment which assures protection of the rights of property; and the railroad commission of that state recognizes the right of capital to a fair return on investment, and is not swayed by occasional local political movements against street railways. It must be apparent that if it is to be assumed that limited franchises confer no rights which are to be extended upon expiration, the rates of fare provided in initial franchises should be large

**Electric Railways**  
**During**  
**Hard Times.**

Franchise  
Policy of  
Massachusetts.

service is afforded. Mr. Hutchins speaks of the studious and unemotional officials of governments in Massachusetts. These officials reflect the predominating sentiment of their constituents. In Massachusetts there is a powerful sentiment which assures protection of the rights of property; and the railroad commission of that state recognizes the right of capital to a fair return on investment, and is not swayed by occasional local political movements against street railways. It must be apparent that if it is to be assumed that limited franchises confer no rights which are to be extended upon expiration, the rates of fare provided in initial franchises should be large

enough to permit companies to return the capital investment to security-holders by the time franchises expire.

---

### CAR HOUSE RECORDS AND TERMINAL CLEANING.

---

The value of thorough methods for inspecting and cleaning rolling stock does not need demonstration. However, whenever a railway considers this subject worthy of the expert attention which is given it by the Chicago City Railway Company, it is a pleasure to comment on the more important features of such work.

As a factor in successful railway operation the car cleaning and inspection work of any road should maintain its integrity. This departmental unity can only be obtained by strictly following some system of reports and these reports must be so designed that at any time the head of the cleaning and inspection department can deliver to the head of any other department accurate advice regarding any maintenance work, including cleaning and repairing, which has been carried out on any or all cars. It may be said that such a requirement is too broad. If this criticism were made it would be because the immediate value of the system of reports necessary was not at once realized.

A system of complete reports is, however, worth the comparatively slight additional expense required for its preparation. The elaborateness of the records that may be kept should, of course, be adjusted to the property and operating organization. With the records available showing the nature of all repairs made on cars, and the dates when these repairs or clear inspections were made, and also when, by the use of these same records, it is possible to determine accurately what employe was responsible for any detail of the work, the operating company is in a far better position, not only to perfect and thereby reduce the proportionate cost of its cleaning and inspection department, but also to go into court on any damage suit with a statement, verified and sworn to, of the exact condition of the rolling stock at the time any accident may have occurred. The assertion that these results are valuable to an operating company needs no confirmation.

Again, when employes know that every part of the work which they perform is entered in a permanent record, the results of the work surely must be better than when it is known that after any particular job has been accepted by the foreman, all responsibility for the men doing the work ceases.

Granting that a well-kept system of records would thus increase the efficiency of the men, the results to the company are twofold. First, there is an inspiration for the men to do good work, and any man who desires to do good work will also be industrious. Therefore the company realizes the maximum value of the money spent for wages. The second result of benefit to the company is realized in the reduction of the number of car pull-ins. One of the fundamental requirements for economical operation is that the cars, representing as they do a considerable investment, be kept in active service for the greatest possible number of hours during their life. To do this requires two things: (1) The repair work and inspection must be so thoroughly done that the number of pull-ins will approach the lowest consistent limit. (2) When it is necessary to make a repair on a disabled rolling stock equipment, those parts of the equipment which are in operable condition should be returned to service with the least possible delay.

These are the fundamental principles on which the car cleaning and inspection department of any electric railway may safely be founded. How thoroughly the Chicago City Railway Company adheres to the central idea just suggested may be learned in detail from an article presented elsewhere in this issue.

Strict adherence to a systematic plan of car inspection and cleaning is a fundamental requirement observed by the

Chicago City Railway Company. To illustrate: The cars, whether for cleaning, inspection or light repair work, are all received at the same end of the car house buildings. Each car, unless otherwise required by some special repair work, is spotted on the same track in the same bay each time it is run through the car house. When a car is turned in at the rear of the car house it immediately is taken in hand by cleaners and repair men, each of which groups successively performs its duties, and passes the car along toward the forward end of the car house, where it receives final inspection and has its trolley pulled down to indicate that it is ready for any service to which the transportation department may desire to put it.

Combined with the very thorough cleaning and inspection practices as followed out at the car houses is the recently installed practice of terminal inspection and cleaning. We do not recall that this system of cleaning and inspection is used by any other railway. The methods are said to have been found both economical and practical. Each car as it approaches an outlying terminal is met by a cleaner and inspector, who sweeps the floors and makes any light repairs that may be called to his attention by the car crews. The repair men are provided with a supply of small parts so that even under comparatively severe service conditions they can make repairs which will permit the cars to be safely operated throughout the runs and thereby save the company the expense of replacing them with cars from storage.

The value of clean cars and the character of the impression they leave on the mind of the traveling public is too well known to require emphasis here. With the system of terminal cleaning each car is swept as well as inspected on each round trip. The results are a better feeling toward the company on the part of those passengers who appreciate clean cars and a substantial reduction in pull-ins due to the availability of repair men at outlying terminals. The system of records exhibits accurate evidence of each detail as it is completed.

---

### OVERHAULING CARS FOR STORAGE.

---

In a few weeks the approach of warm weather will necessitate the setting aside of box cars on many systems in northern climates and if sufficient care is taken to put the closed equipments in good condition at an early period we predict that many troubles will be avoided in the late fall. It is a widely accepted custom on roads that use both open and closed cars to make general repairs during the off season for each type of rolling stock. Therefore it is well to have definitely in mind the exact kind of defects to look for in preparing to overhaul box cars for summer storage.

Wood in truck frames tends to decay under the exposure to water and temperature changes and often needs renewal. Holes in brakebeams tend to wear oblong, calling for new beams in the best practice. Holes in levers also tend to get worn. If journal boxes have not been cleaned out and the felt wicking has become glazed, preventing the oil from reaching the bearing, it is good practice to renew the boxes or clean them by soaking in kerosene.

An important point to observe in handling bearings is to mark them when they are taken from the boxes, as many hot boxes are caused by shifting the bearings after they have become properly seated to their axles. An arrangement of lockers was provided in one shop in which the bearings were kept. They were numbered the same as the journals. When an axle was taken out of service the corresponding journals were put in a certain locker and kept there until the axle went back in service again. This at once reduced the number of hot boxes 90 per cent, and the cost of doing the work was nominal.

Before a car goes back into service the trolley adjustment is one of the most important things to make sure of and one

which is often overlooked by inspectors. If the trolley contact springs are not kept in good condition to carry current from wheel to pole, independent of the spindle, the result is likely to be worn and burned trolleys, spindles and bushings and burned cotter pins. The latter lead to losses of wheels or parts on the street—small matters from the expense point of view, but very annoying in relation to service interruptions.

Whether the repairs on the closed cars are to be made at once or later in the warm season, it is an advantage to prepare lists as soon as possible at different car houses of the materials needed in the work in sight. Otherwise the stores department is likely to be overloaded with a rush of requisitions later in the season and often at a time when orders cannot be rapidly filled. The farther a road gets from the factories the more necessary it is to keep a large stock of spare parts on hand, and if orders for these are placed early the deliveries stand a much better chance of enabling the work to be done in time for the opening of traffic with the closed cars in the fall. Only a careful system of life records of equipment parts will, with large allowances for late deliveries, serve as a basis for approximate estimates of the supplies needed.

**ANNUAL REPORTS.**

**West Jersey & Seashore Railroad.**

Operating expenses of the West Jersey & Seashore Railroad, the electrified division of the Pennsylvania system, aggregated 78.27 per cent of gross earnings in 1907, as compared with 76 per cent in the previous year. As a result of the increase in expenses, which was due principally to the greater cost of conducting transportation, the net earnings from operation in 1907 were less than in 1906. Figures for the two years compare as follows:

	1907.	1906.	Increase.
Miles of road .....	363	358	5
Gross earnings .....	\$5,654,904	\$5,206,284	\$448,620
Operating expenses .....	4,426,040	3,956,914	469,126
Net earnings .....	\$1,228,864	\$1,249,370	*\$20,506
Other income .....	79,193	40,086	39,107
Total net income.....	\$1,308,057	\$1,289,456	\$18,601
Charges, taxes, rentals, etc.....	652,863	491,808	161,055
Net divisible income.....	\$ 655,194	\$ 797,648	*\$142,454
Dividends .....	578,496	475,704	102,792
Surplus .....	\$ 76,698	\$ 321,944	\$245,246

\*Decrease.

The proportion of the gross earnings contributed by the passenger traffic was substantially the same as in the previous year, being in each instance 63.9 per cent.

Conducting transportation costs amounted to \$2,626,186 in 1907, or 46.6 per cent of gross earnings, as compared with \$2,256,366 in 1906, or 43.3 per cent of gross earnings. The total maintenance expenditures during 1907 were \$1,550,868, as compared with \$1,485,452 in 1906.

From the surplus for 1907, shown in the foregoing table, there were deducted \$52,973 for sinking fund requirements and \$8,890 on account of maturing car trusts and guaranteed dividends. From the profit and loss surplus accumulated in previous years there was taken \$106,523, mainly for settlement of accident claims on account of liabilities of preceding years.

The passenger traffic increased in a greater ratio than the earnings therefrom. The number of passengers carried was 8,512,958, a gain of 16 per cent. The passenger train mileage increased 17 per cent. More favorable results were shown in the freight department. With an increase in the number of ton-miles of 15 per cent and in the total tonnage of over 10 per cent there was an increase in freight revenue of 16.7 per cent.

The charges to property account during the year agree-

gated \$2,177,878, and are set forth in detail. James McCrea, the president, discusses the important improvements made during the last few years. In order to provide for and protect the increasing traffic, and particularly the seashore business, it was deemed wise in 1905 to add extensively to facilities. Plans formed at that time comprised the double-tracking and electrification of the line from Camden via Newfield to Atlantic City, and also electrification from Newfield to Vine-land and Millville; the improvement of the road between Camden and Cape May and other seaside resorts south of Ocean City and the separation of steam from electric service by using for steam trains the Camden and Atlantic road to Winslow Junction, and, from that point jointly with the Philadelphia & Reading Railway, the road to Woodbine; the construction of a freight cut-off between Westville and Had-donfield, permitting the carrying of freight around Camden; and the elimination of grade crossings in Camden. Additional equipment and other improvements were also needed. Under an agreement made by the company in 1904 it paid to Atlantic City during the last year \$150,000 toward the cost of paving Atlantic avenue and expended \$366,927 in regrading and relaying the tracks of the company on that avenue. To meet the cost of these improvements and of changes in the terminal at Camden, involving altogether about \$9,300,000, there were issued \$4,689,550 capital stock and \$2,061,000 consolidated mortgage bonds. The sums required beyond the proceeds of these securities have been advanced temporarily by the Pennsylvania Railroad, but \$1,000,000 more will be needed during 1908 to make the improvements of proper utility and to provide additional facilities.

After referring to the reduction in the dividend from the basis of 6 per cent to 4 per cent per annum Mr. McCrea states that, judging by past experience and the business which is being developed by electric service and improved facilities, it is hoped that the expenditures for protection and development of the increase in traffic will produce in the near future increases in the net revenues. Trackage rights have been given by the company to the Atlantic City & Shore Railroad on Atlantic avenue, Atlantic City, and to Longport, with the use of the steamboat lines from the latter point to Ocean City. The West Jersey & Seashore road receives a fixed rental under the agreement for this joint use of its property and also shares in the increased revenues resulting from the development of the territory.

Traffic statistics for two years make the following comparison:

	1907.	1906.	Increase.
Passenger-miles .....	252,388,770	214,464,347	37,924,423
Passenger-mile revenue, cts. . . .	1.312	1.337	*0.025
Pass. train-mile earnings. . . . .	\$1.099	\$1.212	*\$0.113
Ton-miles .....	76,901,514	66,972,628	9,928,886
Ton-mile revenue, cents. . . . .	2.195	2.160	0.035
Freight train-mile earnings . . . . .	\$2.949	\$2.727	\$0.222

\*Decrease.

**Power Improvements at Jacksonville.**

The Stone & Webster Engineering Corporation has nearly completed the installation of additional power house equipment for the Jacksonville Electric Company. This work has included the installation of an 800-kilowatt General Electric railway generator direct connected to a 24 by 48 by 48 inch horizontal cross-compound condensing Rice & Sargent engine. The boiler capacity has been increased by the addition of a 520-horsepower Aultman & Taylor water tube boiler, and a new 2,500-horsepower self-supporting steel stack, together with flues connecting it with present and new boilers, has been erected. The old steel stack, which had become inadequate, has been removed and a barometric condenser with necessary circulating and dry vacuum pumps has been installed in its former location. The new condenser is of sufficient capacity to condense steam from two 800-kilowatt units.

# Communications

## CLASSIFICATION—DIFFICULTY OF APPLICATION TO COMPANIES OPERATING SEVERAL CLASSES OF PUBLIC UTILITIES.

To the Editors:

I do not believe that a road with small gross receipts can adopt the classification on account of the heavy expense required by the number of accounts and the necessary number of forms.

In roads or systems that can afford the expense I believe that even then the division of expenses under 116 primary accounts would be top-heavy and cumbersome. The proper curtailment of this very voluminous classification should receive very earnest and serious consideration.

We are dealing now with a classification of accounts that will be permanent, until further amplified by the accession of other public utility corporations, and due care should be exercised if we are not to be carried away by dealing with minutiae. If these details could be carried out by ourselves as individuals they would probably work out some generally good results, but we are dependent for our information as to the actual use of supplies and the employment of labor upon the superintendents, foremen and others in charge, and if the classification is made burdensome to them it will most surely lack the attention it deserves and will therefore be unsatisfactory and of no value.

For instance, consider primary account No. 44, "other than railway operation—cr.," under subgeneral account F, general account I. In a system operating an electric light and commercial power plant in connection with railway power, where there is an income from the sale of light and power, the tentative classification conveys the idea that further separate accounts should be kept, and that the expense in this connection should be charged against gross income directly, and the primary account should show a credit on account of certain expenses. How is it possible to determine the cost or expense for the service for light and power sales with the almost innumerable charges in connection with account No. 44, when all the machines are in one building, and still expect to receive anything like a correct report from those in charge of the building? If a new plank was necessary for the floor or new panes of glass were needed for the windows, is it possible to know accurately what proportion of these two expenses should be charged to account No. 44, for the light and power service, respectively? It seems to me that account No. 44 is unnecessary, as it is fully covered by primary account No. 26, "power generating plant buildings." Other accounts could also be eliminated and the primary accounts brought down to a number within reason, and with something of the expectancy of accuracy.

On the other hand, I do not see where provision has been made in this voluminous classification for certain important accounts, such as "maintenance of ferry boats," as well as for the operation of ferry boats.

Charges to both of these accounts amount to large sums annually.

I do not think it is wise or good business to attempt to apportion the injury and damages accounts, insurance and store expenses. They are best treated and understood when classified under general expenses.

In the treatment of "depreciation" I do not see where it should enter into the cost of operation of the property. Maintenance is an operating charge, because it means holding or keeping the property in a particular state or condition. "Depreciation" should be a charge against net income, because it means that the property has lessened in value. A certain defined percentage should be set aside annually from net income to provide for the generally lessened value of the prop-

erty, which it is not possible for even the strictest method of maintenance to overcome.

The company with which I am associated operates a railway plant, a gas plant, an electric light and power plant and a combination ferry and railway plant connecting seashore resorts, so that while I am interested in interurban railway accounting, I am as much interested in the accounting for electric light and commercial power and gas plants, and each one is more or less of a proposition in itself. In addition to these there are to be dealt with water companies, heating companies, the interstate and state commissions and the United States bureau of census. It therefore seems to me that a general committee composed of members of these several associations and bureaus should meet and determine upon such a classification of accounts as will best serve the interests of investors. This agitation concerning interurban and street railway accounting is simply a forerunner of a combination system of accounting of other public utility corporations and it seems to me that while the matter is under discussion it would be just as well to consider the accounting of gas, electric light and commercial power, water and heating properties in connection with the railway interests, and adopt such classification as will best serve all interests involved—the investor, the accountant, the interstate and state commissions and the bureau of census of the United States.

PINCKNEY J. BALAGUER,

Secretary and Auditor Charleston Consolidated Railway Gas & Electric Company.

Charleston, S. C., March 27, 1908.

## CLASSIFICATION—PAST STATISTICS RENDERED USELESS.

To the Editors:

Inasmuch as there are to be separate accounts for steam and electric roads why not continue the present classifications of the American Street and Interurban Railway Accountants' Association, which have been in service for eight years or over? Any railroad that wishes more detail than those provide can add as many subaccounts to the present classifications as will answer the purpose. If a few new accounts must be used to keep up with the development of the traction business they can be added by placing letters after the nearest accounts or using half numbers. This practically would not change the present classifications and would not render the statistical work of the past several years useless for comparison with the results of the coming years. I think the tentative classifications go too far into detail for roads the annual receipts of which are not \$300,000, and that they would necessitate the employment of extra help in each of the different departments to make the distribution of the accounts.

E. L. SCHMOCK,

Assistant Secretary Cleveland Painesville & Eastern Railroad.

Willoughby, O., March 23, 1908.

## CLASSIFICATION—REVISION NEEDED.

To the Editors:

I am of the belief that the interstate commerce commission will not press the adoption of the classification of operating expenses but will consent to a number of changes which will doubtless be urgently submitted by a majority of the operating roads in their replies to Circular No. 20.

It seems almost unfair for the commission to impose on the operating roads the necessity of furnishing it with certain detailed statistics which would be secured for no other purpose and, if provided at all, could be but the result of a burdensome task. There appear in the classification a number of primary accounts which would not accurately convey the information desired. Such accounts deal with minor matters of accounting which are not required or desired by the officials

of most roads, especially when the cost of securing the data is considered in connection with the very slight advantage of having the information. This detailed information would necessitate excessive clerical work and, even with the application of the most careful thought in the distribution of charges, the accounts in most instances would not represent reliably the totals properly chargeable to them. It is doubtless true that a number of these accounts would portray to the officials of the roads and the commission results practically estimated or guessed at, and it is my belief that the commission will be convinced of this fact, and as a result revise the classification.

IRA E. GUTHRIE,

Auditor Indianapolis Columbus & Southern Traction Company.

Columbus, Ind., March 28, 1908.

**PAT AND THE NEW ACCOUNTING—WITH APOLOGIES TO MR. DOOLEY.**

BY PAT'S EMPLOYER.

Pat (the lineman): "Well, Bill, Oi've jist asked fur a job as sieshun hand."

Bill (the motorman): "Fur why was that now, Pat? Are ye sacked?"

Pat: "Sacked! Naw; but the boss wants t' make a damned bukkeeper of me."

Bill: "A foine bukkeeper ye'd make with them fists o' yourn. What's the joke?"

Pat: "It's in sober earnest I am. It's loike this: He calls me in, nice and friendly lolke, and he says: 'Pat,' says he. 'Pat, some fules doon in Washin'ton have made an order that your pay must be subdivoided.'

"Ye're not fur cuttin' me pay? says I.

"'No, no, Pat,' says he. 'Jist fur keepin' thrack of it and the toime ye put in so's t' count fur it loike.'

"'Verry well, sur,' says Oi, 'so long's it's not fur cuttin' Oi can shtand it.'

"With that he brings out a noice new toime buk loike's used by a toimekeeper on a thrack gang, but bigger, and shtarts in t' explain t' me: 'It's loike thish, ye see, Pat. Ye're gettin' a hunder a month—that's three somethin' in Janiery, March, and—I misremember the other munths he named—and three somethin' else in Apreel and—a lot more, and—three somethin' else in Fibrooary.' I remember that Fibrooary was all alone except that he sed it was diffrunt thish year, but we wudn't count that.

"'Now, Pat,' says he, 'Oi've laid it all out fur ye in this buk and ye're t' divoide oop the wurruk ye do ivery day betwix the diffrunt accounts.'

"'But, mither of Moses!' says Oi, 'Oi'm not wurkin' all day, sur,' says Oi. 'Mosht iv me toime is spint roidin' tu a job, an' fur a job an' inshtpectin' th' loine,' says Oi.

"'Niver moid that,' says he. 'Ye'll have t' eshtimate ut.'

"'Eshitimate ut! An' what's that?' says Oi.

"'Guess at it,' says he, sort-a-mad lolke; an' thin he opens the buk and shows ut t' me all noiceily rhuled up an' down an' chris-chros, an' procheeds t' explain. Ut seems Oi'm doin' a lot of diffrunt things t' wanst.

"'Ye see, ut's rhuled across th' top,' says he, 'intu twenty-wan colomes, manin' twenty-wan diffrunt jobs. On top iv each colome is a number denotin' the koind iv job, an' in frunt here Oi've had printed the koind iv job oppisit the number, so's ye can refer to ut. Now,' says he, 'if ye're fixin' a lamp in a switchstand ye must put down ye're toime in the furst colome with a foive over ut, but uf ye're puttin' a new lamp in mol offs here ye put it down in this lasht colome under a hunder an' ate.'

"'An' he wint on fur 'bout fifteen minits exshplainin', as he called ut, all what Oi was t' du when Oi dhruv a cow off the rhoit uv whay an' chlosed th' gate on her, an' what Oi was t' du whin Oi was ridin' on a car inshtpectin' th' loine, how

much was t' go t' this woire an' how much t' that wan, until Oi shtopped him by ashkin' where was me runnin' mate, Moike.

"'Oi've jist put him on practisin' motorman,' says he.

"'Thin git a college purfeshur fur this job an' put me in a sieshun gang,' says Oi—an' out Oi cum."

Note.—Pat was somewhat short in his count or the book was too small. Twenty-one accounts would not cover Pat's multifarious duties.

**HAND LATHE FOR ARMATURE BOXES.**

BY R. D. COLBURN.

The accompanying halftone engraving illustrates a machine which was designed by the writer for turning armature boxes and axle bearings for railway motors in the shops of the Dayton Covington & Piqua Traction Company at West Milton, O. We found that the armature shafts, after being used for a short time, showed some wear, and as no two armature shafts wore down to the same size we had to make the box to fit each individual shaft. This necessitated considerable expense and labor, which, after five years of service, the machine herewith illustrated has reduced very appreciably.

The illustration shows the machine with the self-centering jig for holding the boxes to be turned wide open, in position to

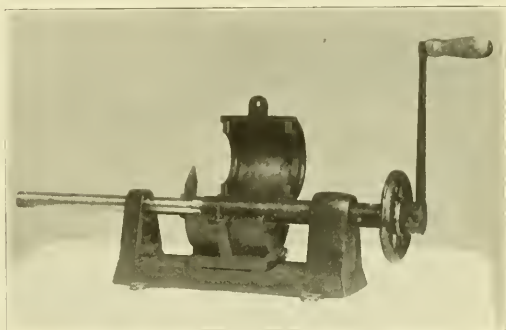

Hand-Driven Lathe for Boring Armature Boxes.

insert the box. This inserting is done by taking the center of the arbor and pushing the arbor back through the feed screw until there is room enough to insert the box. The cover is then clamped down, the arbor pushed back and the cutter put in place. By means of different sized rings which are placed in grooves inside the jig the machine will hold any size of box. We used a different shaped cutter for facing off the ends of the box.

Since using this device we have had no trouble from boxes not being truly centered and in 15 minutes a G.E.-67 armature bearing can be put into the machine and turned to fit any armature. A box also can be turned in less time than with a lathe, and, on a road having no regular machine shop, such a simple method becomes almost a necessity by reason of the expense of labor, loss of time and cartage charges incurred when a box must be sent away to be turned. The labor charges alone represent a cost of from 50 to 60 cents an hour when the work is done outside, while with this machine one man who is paid 20 cents an hour can do the work in almost the same time he would use in taking measurements ready to send away with the box to be turned. As a further saving in time we always keep our old shells babbitted ready to be turned at any time.

The new stock yards branch of the South Side Elevated Railroad, Chicago, will be opened for traffic in a few days.

### CAR CLEANING AND INSPECTION—CHICAGO CITY RAILWAY.

The methods of inspection, making light repairs and car cleaning as practiced by the Chicago City Railway Company at its car houses located at Seventy-seventh street and Vincennes road are typical of the work at the other five car houses of this company.

Before describing in full the practices in the car cleaning and inspection work of the Chicago City Railway Company it seems best to outline the general idea upon which the various details of the work are based.

A system of records of a thorough yet simple nature has been established. These records are not complicated and little clerical work is required in their keeping. As a result the company has available at all times records comprising an accurate statement of all the repairs that have been made on any car before it was put into service on any date. In other words, it is possible by referring to the records to learn the location and condition of every car housed on every date. Similarly the records show when the car has been cleaned and inspected and what were the repairs made, if any, on any date.

With regard to the repair work, the system of handling the cars in the car houses and shops has been formulated with a

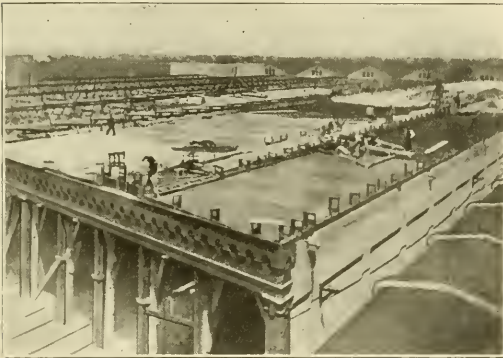

Chicago City Railway—Roof of Car House During Construction.

view to keeping as much as possible of the capital invested in cars in operating service for the maximum time. Briefly this is effected by having available at the car houses supplementary parts with which a damaged equipment can be put into operable condition by the simple process of replacing the damaged parts. For instance, if a truck is damaged it is the plan to save the car as a capital investment by placing the body on new trucks at once and thus putting it back into service where it has an earning value.

#### Buildings.

The new Seventy-seventh street building comprises six bays, each with five tracks extending through from end to end. The average length of each of these covered tracks is such that it will accommodate 10 of the company's large double-truck cars. Immediately at the rear and in line with the new building, but separated from it by a paved concourse 66 feet wide, is a similar car house, also having six bays, with five through tracks in each bay. This rear car house is long enough to accommodate seven cars on each of its 30 tracks. The total housing capacity at this location is about 600 cars.

Rolling steel doors of Kinnear manufacture serve to close the ends of each bay of the car houses. The track arrangement is such that cars may be received at the rear end of the rear car house, passed through the rear building, across the concourse and through the new car house to the street on

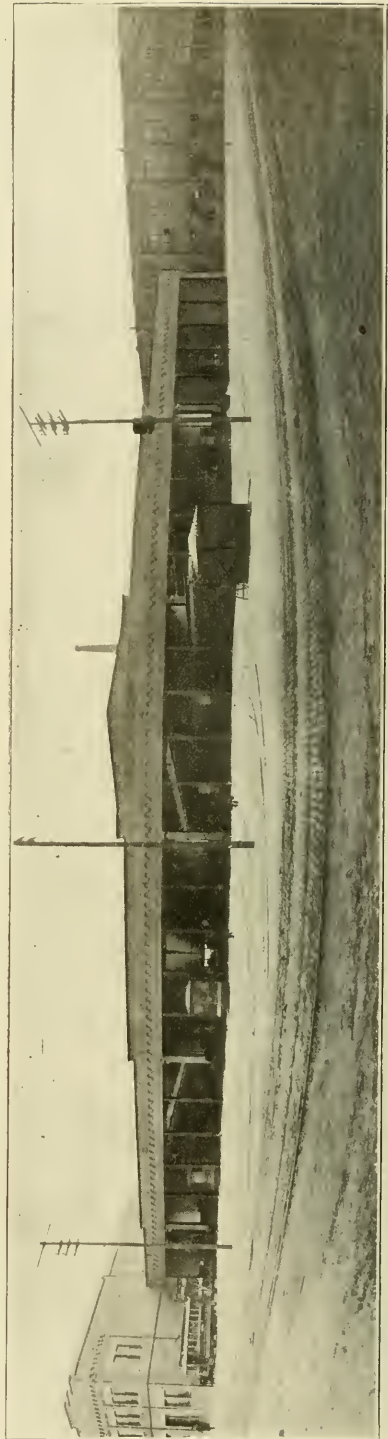

Chicago City Railway—Panoramic View of Division Headquarters (Left), New Car House (Center) and Machine Shop (Right) Fronting on Vincennes Road, Between Seventy-seventh and Seventy-eighth Streets.

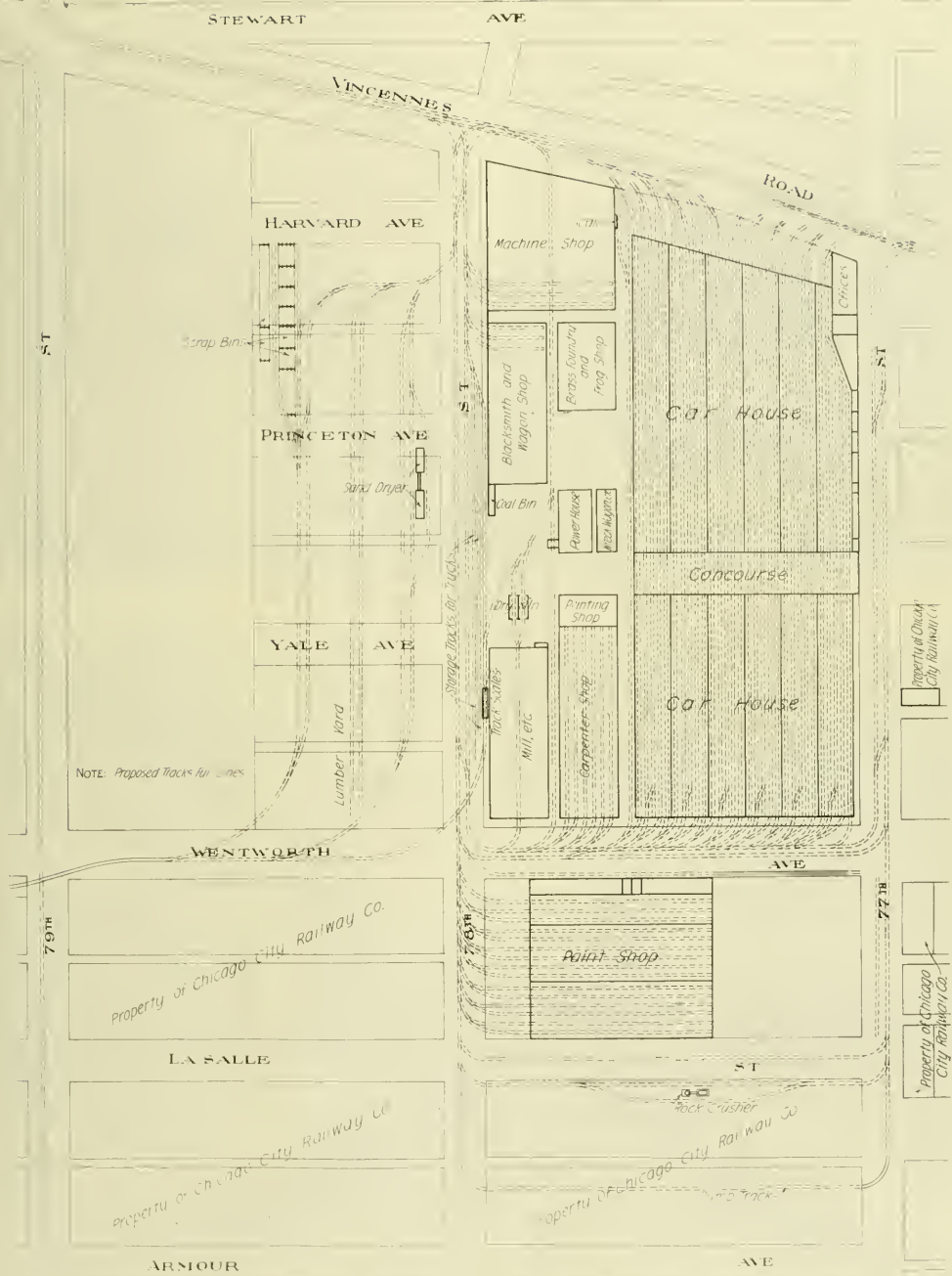

Chicago City Railway—General Ground Plan Showing Relative Location of Shop Buildings and Car Houses.



Chicago City Railway—Concourse Between Car Houses.



Chicago City Railway—Interior View of One Bay in New Car House.







to make room for another. While over the pits the cars receive a very thorough inspection and all light repairs are immediately made. The inspection force is divided up into six gangs of two men each, with work classified as follows: Trolleys, brakes, controllers, brake rigging and wheels, motors and bodies. The gangs are assigned to individual tracks, so that each takes a line of cars and inspects it progressively. In this way, as a car has been cleaned and then inspected, it can be passed along toward the front of the car house, where it later will receive the finishing touches, and then be moved up to the front, ready to go out in service.

The inspection over the pits is carried out on each car very thoroughly once a day. The air brakes are operated by the inspection men, the shoes and piston travel are inspected and adjusted if necessary, and if it is found necessary to replace brakeshoes this is done and the adjustment then made. Each air tank is bled every night and, as there are two tanks to each car, practically no trouble is occasioned from condensation. The motors are looked over very carefully and all journals on the car are "felt," irrespective of whether or not they are freshly oiled. Each night the inspectors of the mechanical department test the air sanders to see that they

forms by means of which it is possible to learn the location and condition of every car owned by the Chicago City Railway and ascertain definitely the nature of the cleaning, inspection and repair work done on any car on any day. The system of blank forms is not complicated, and but a comparatively small amount of clerical work is required to keep these complete and desirable records.

After a motorman has turned in his car to one of the car placers he goes to the division headquarters at the corner of the car house and there fills in the information required by a so-called "motorman's daily signing-in sheet." These sheets, which are kept in frames with only those portions exposed which are to be used by the motorman, are 11 3/4 inches wide by 16 3/4 inches long and have headings ruled as shown in the accompanying illustration. It will be noted that the motorman is required to indicate on a sheet the time at which the car was turned in, the car number and the nature of the defects or breakages, if any exist (otherwise indicate good condition by an "O. K.") on the car when turned in, and affix his signature, thus certifying to the correctness of this defect report. An additional column at the right of the report is ruled for the use of the car house foreman. Here he indicates the action

Form 4042					
<b>CHICAGO CITY RAILWAY COMPANY</b>					
<b>MOTORMAN'S DAILY SIGNING-IN SHEET.</b>					
STATION _____				190__	
TIME IN		CAR NO.	NOTE HERE ANY DEFECT OR BREAKAGE FOUND TO EXIST IN YOUR CAR	I CERTIFY TO MY CAR BEING IN CONDITION AS NOTED HEREON MOTORMAN'S SIGNATURE	FOREMAN'S COLUMN ACTION TAKEN
A. M.	P. M.				
SIGNED _____			*BY MASTER MECHANIC	SIGNED _____	
THIS REPORT SHOWING CONDITION OF ALL CARS USED IN PASSENGER SERVICE MUST BE MADE DAILY; PROPER NOTATION SHOWING THAT CARS HAVE BEEN "REPAIRED," "HELD IN" OR SENT "TO SHOPS" SHOULD BE NOTED THEREON BY CAR HOUSE FOREMAN, WHOSE SIGNATURE MUST BE THEN AFFIXED. REPORT WILL THEN BE CAREFULLY CHECKED OVER BY ASSISTANT MASTER MECHANIC, WHO WILL FORWARD SAME TO MASTER MECHANIC, WHO WILL CERTIFY TO THE CORRECTNESS OF THE SAME AND PASS TO CLAIM DEPARTMENT FOR PERMANENT FILE.					

Chicago City Railway—Motorman's Daily Signing-In Sheet, on Which He Notes Condition of His Car.

are not clogged, and again as the car is taken out the motorman fills the box and tests the discharge, so that the responsibility for the sander being in operative condition rests with the motorman himself.

As the inspectors complete their work on a car it is moved along toward the front of the car house. Here such light work as replacing windows, inspecting and replacing lights, testing bell circuits, sliding steps, fenders, etc., is carried on. The bells on each car are rung every day. Two shifts of one man each test and make minor repairs on the bell circuits.

The men making the minor repairs on the cars act as secondary inspectors and advise their foreman of any defects noted. As soon as the final cleaning and repairing are completed the car is moved as far as possible toward the front end of the car house, the lights are turned out and the trolley pole is pulled down, thus indicating that the car is ready for service. In cold weather, however, the trolley is put on the wire and the heaters are turned on one point for an hour or an hour and a half before any car goes into service.

**Car House Records.**

The car placer's record, by means of which the motorman reports verbally any defect noted in his equipment, has been described. Following this record is a complete chain of blank

taken with regard to the defects reported by the motorman. Thus in this column opposite a reported defect he states whether the car was repaired, held in or sent to the shops. In the frames in which these signing-in sheets are fastened this latter "foreman's" column is covered by a strip of wood so that it may not be touched by the motorman. At the bottom of the blank form are signing spaces for the assistant master mechanic and the car house foreman. Beneath the signatures is the following statement:

"This report, showing condition of all cars used in passenger service, must be made daily; proper notation showing that cars have been 'repaired,' 'held in' or sent 'to shops' should be noted thereon by car house foreman, whose signature must be then affixed. Report will then be carefully checked over by assistant master mechanic, who will forward same to master mechanic, who will certify to the correctness of the same and pass to claim department for permanent file."

**Daily Repair Sheet.**

The foreman of the car house keeps close watch of these signing-in sheets, checking them with the verbal defect reports received by the car placers. He transfers any defect reports made by a motorman to a large "daily record of car repairs." This record sheet kept at one side of the car

house, is readily accessible at all times. The so-called "daily record of car repairs" is printed on a sheet 21½ inches wide by 26 inches high. At the top appears a heading in which is written the name of the car house at which the particular sheet is used, together with the date on which it was used. The ruling of the sheet is simple. Down the left-hand side are listed, one on each line running across the page, the parts of a car most frequently requiring attention. This list follows: Air canopies, controllers, curtains, doors, engineers' valves, electric bells, fenders, fuse boxes, floors, glass, grab handles, gongs, headlights, heaters, hot journals, lights, motors, register cords, resistance, sashes, sander, seats, signal

of the work done by the inspection and repair men each day; and there is also afforded a means for ascertaining which man is responsible for any particular repair made. When any defects scheduled on the daily report are not repaired on the same day the car number is transferred to the daily car repair record for the day following.

**Repairer's Report and Held-In Slip.**

To assist the men in taking off their assignments from the large daily record of car repairs and as a further check on the responsibility for each job, a "repairer's report" is used, 5 by 8½ inches in size. Onto one of these sheets each man

FORM #13

**CHICAGO CITY RAILWAY COMPANY**  
CAR HOUSE FOREMAN'S REPORT OF CARS SENT TO SHOPS FOR REPAIRS

CAR HOUSE, \_\_\_\_\_ 19\_\_

CAR \_\_\_\_\_ RUNNING ON \_\_\_\_\_ LINE. IS DISABLED AS FOLLOWS:

\_\_\_\_\_

\_\_\_\_\_

REPORTED DISABLED BY MOTORMAN \_\_\_\_\_ BADGE \_\_\_\_\_ FOREMAN \_\_\_\_\_

NOTE.—THIS SLIP MUST ACCOMPANY EVERY CAR SENT TO SHOPS FOR REPAIRS

FORM #14

**CHICAGO CITY RAILWAY COMPANY**  
FOREMAN'S REPORT OF CARS RETURNED TO SERVICE.

MASTER MECHANIC, \_\_\_\_\_

CAR \_\_\_\_\_ REPORTED AS "HELD IN" ON THE SIGN IN SHEET OF \_\_\_\_\_ FOR \_\_\_\_\_

\_\_\_\_\_

NECESSARY REPAIRS HAVE BEEN MADE, CAR HAS BEEN THOROUGHLY INSPECTED BY ME, IS IN GOOD OPERATIVE CONDITION, AND RETURNED TO SERVICE \_\_\_\_\_ 19\_\_

\_\_\_\_\_ FOREMAN

NOTE.—CAR HOUSE FOREMAN WILL FILL OUT ONE OF THESE REPORTS FOR EACH CAR REPORTED "HELD IN" ON SIGN IN SHEET. WHEN CAR IS RETURNED TO SERVICE, REMAINDER OF REPORT TO BE FILLED OUT AND FORWARDED TO MASTER MECHANIC AND THEN TO CLAIM DEPARTMENT FOR PERMANENT FILE

Chicago City Railway—Report Accompanying Each Car Sent to the Shops for Repairs.

Chicago City Railway—Report Advising that a Car Held In for Repairs Has Been Returned to Service.

bell, steps, signs, trucks, truck fenders, trolley, ventilators, wheels, wiring.

It will be noted that this list of parts is arranged alphabetically, so that no time need be lost in referring to any division of the list. Columns are ruled up and down the car repair record, so that opposite each one of the parts as listed are nine clearly separated blank spaces. In each of these spaces two sections are set off for recording the car number and the payroll number of each man who makes the repairs noted on the same line.

As the car house foreman inspects the motormen's sign-in sheets he transfers to this "daily record of car repairs"

transfers from the large record the numbers of the cars having any defects which it is his duty to repair. After the work as exhibited on this repairer's report has been done, he signs his name at the bottom and also his payroll number. When thus completed the blank shows the repair work done in one day by one man. The various men using this report are those assigned to work on car bodies, motors, trolleys, air brakes, controllers, trucks, wheels and brake rigging. If the nature of the difficulty assigned to any man is such that it cannot be repaired on the same day he notifies the foreman, who fills in a "held-in" slip.

This held-in slip is used by the foreman to inform the

**CHICAGO CITY RAILWAY COMPANY**

DAILY RECORD OF CAR REPAIRS AT \_\_\_\_\_ CAR HOUSE \_\_\_\_\_ 19\_\_

CAR PARTS	CAR NO.	REP #1	CAR NO.	REP #1	CAR NO.	REP #1	CAR NO.	REP #1	CAR NO.	REP #1	CAR NO.	REP #1	CAR NO.	REP #1	CAR NO.	REP #1
AIR																
BEARINGS																
BELL ROPE																
BRAKES																
CONTROLLERS																

Chicago City Railway—Daily Car Repair Record Sheet on Which the Numbers of Cars to be Repaired are Distributed.

the numbers of the cars on which defects occur, placing these numbers on the daily record of car repairs opposite the defective part as listed in the left-hand column. In this way the daily record of car repairs at each car house automatically distributes the work for the repair men, who go to the large record and take off the numbers of the cars which are defective in the parts for which these men are responsible.

Thus the overseeing work of the general foreman is not interfered with by his being called upon to assign jobs to the various subforemen and gangs. As defects are repaired the payroll number of the man making the repairs is placed opposite the proper car number on the large sheet and thus there is exhibited a permanent record of the amount and nature

assistant master mechanic and later the claim department of the nature of defects to each car and the time when the repairs on that car were made, so that it could be returned to service. This blank form, which is 9% by 4¾ inches in size, is also illustrated.

**Shopping Slip and Foreman's Report.**

When it becomes necessary to send a car to the shops the car house foreman makes out a blank of the accompanying form, which is sent to the repair shop with the car. As the repairs are completed the information called for on the back of the blank is filled in in the office of the master mechanic, including the time and number of the car as it is

returned to service. If the damage requiring the shopping of the car has been occasioned by accident, there are entered on the back of this shopping report the expense for labor and materials required in making the repairs. These blank forms, which the foremen use for reporting cars sent to the shops for repairs, are 8½ by 4½ inches in size and are ruled as shown in the accompanying illustration.

The daily report of the car house foreman, which is illustrated in part, is 8½ by 14½ inches in size, and is used to inform the assistant master mechanic of the total number of cars housed, held in, pulled in or sent to the shops each day. This blank also indicates the car number, time and nature of

broken axles, flat wheels, truck and the heavier motor repairs, which necessitate raising the car bodies, are handled at the east end of the north bay of the rear car house, which is equipped with traveling cranes, hoists and shop tools suitable for making such repairs.

The records of the work in this bay are the same as those for inspection and lighter repairs, with the addition of a blank form which covers the placing and removal of wheels. This blank, after having been filled in, is sent to the master mechanic, so that the information exhibited may be entered in a large wheel mileage record.

**Repair Record Book.**

As a means for ready reference for the foreman by which he can quickly ascertain the nature of the repairs that have been made to any particular car during any desired period, a key with symbols is used so that the various repairs can, with facility, be placed opposite the car numbers in a repair record book. This book has pages 6 by 9½ inches in size. At the left of the page is a space for indicating car numbers and at the right space is left for making any special remarks. The key used in this work and a portion of one page of this repair record are reproduced herewith. This scheme for recording motor car repairs with a key is found very useful in fixing the blame for careless work and also for keeping track of supplies. It is easily kept, requiring but little time, and therefore forms a valuable record for the car house foreman in his efforts to assure that careful repairs are being made.

This record book does not exhibit the name or number of the man making the repairs, but by referring to this record the foreman can learn the day and nature of the repair made on any car coming under his jurisdiction. With this informa-

1908		CHICAGO CITY	
FARM 48 27		77th CAR HOUSE	
CAR NO.	DATE		
5001	1/6	1/7	2/1
	1/3	3/1	3
5002	1/7	2/1	3/1
	1/7	2/20	
5003	1/8	1/7	3/9
	4	1	1
5004	1/21	1/31	1/22
	1/27	3/7	

**KEY**

- < signifies Armature bearings
- " " Pinions
- " " Fields
- " " 4 pairs of Wheels
- " " 3 " "
- " " 2 " "
- " " 1 pair " "
- 1 --- " #1 Armature
- 2 --- " #2 " "
- 3 --- " #3 " "
- 4 --- " #4 " "

Note.—In entering bearings, pinions and fields add the numerals 1, 2, 3, 4, as required to denote the motor number. "S" signifies car sent to shop for overhauling. "P" signifies car sent to paint shop.

Chicago City Railway—Page from Car Repair Record Book.

the defects of each car pulled in, together with the time at which the repairs were completed. It also shows the car number, repairs necessary, materials short and probable date for completing the repairs for all cars being held in at the car house. After these reports are made out and signed by the foreman they are sent to the assistant master mechanic, who checks them and keeps them on file for one month. The reports for the month are then vised by the master mechanic and sent to the claim department for permanent filing.

**Pull-In Chart.**

In the office of the assistant master mechanic is a pull-in chart showing the number of pull-ins at each car house each day in percentages of operable cars. The chart is plotted on cross section paper about 30 inches wide by 12 inches high. The ordinates of the curves are percentages and the abscissæ represent the time in days. The percentage curves for all the car houses are plotted on this one chart and therefore a key is exhibited at the left of the chart, listing opposite the names of each car house its indicative color. In a parallel column opposite the list of car houses is shown the number of cars required for the schedules operated from each car house.

Each day as the car house foremen's pull-in reports are received the percentage of pull-ins to total operable cars is figured for each car house. These percentages are plotted on the chart above their respective dates and in the colors as shown by the key. Connecting the percentages for each car house with lines drawn in ink representing that car house, results in the graphical exhibition of the comparative percentages of pull-ins for the entire system. The weather is noted on the chart each day. It is thus, by the aid of the chart, easily possible for the assistant master mechanic to compare the character of the work of the men at the various car houses and note any deficiency in the average results of that work.

In making car repairs at the car house such defects as

CHICAGO CITY RAILWAY COMPANY				
DAILY REPORT OF CAR HOUSE FOREMAN.				
CAR HOUSE				19__
<b>CAR STATEMENT.</b>				
TOTAL CARS HOUSED _____				
CARS "HELD IN" _____				
CARS AT SHOP _____				
TOTAL OPERABLE CARS _____				
<b>DEFECTIVE CARS "PULLED IN"</b>				
CAR NO.	RUN NO.	TIME	NATURE OF BREAKAGE, DAMAGE, OR DEFECT	REPAIRS COMPLETED
<b>CARS "HELD IN" FOR REPAIRS</b>				
CAR NO.	REPAIRS NECESSARY	MATERIAL SHORT	REPAIRS WILL BE COMPLETED	
FOREMAN _____				

Chicago City Railway—Car House Foreman's Daily Report.

tion he then refers to the repair men's work records, which have earlier been described, as showing all the work done by each man for any particular day. These records are kept on file in 31 pigeonholes in the foreman's office. Each pigeonhole contains all the repair men's records for one day's work. Therefore, with the book and daily records handy there always is available a detailed statement of the repair work done by any man during a preceding month. A similar method, utilizing 12 spaces in the cabinet, is used for filing

the daily records of car repairs. The records for one month are kept in each space in the cabinet, and therefore with the 12 spaces a complete record of a year's repair work on all cars is available on instant notice.

#### Shop Trucks.

With a view to minimizing the idle investment in equipment because of cars being held in the shops, the shop department keeps a supply of shop trucks at the car houses. When it is necessary to repair a car body the good trucks under that body may be kept in service under some other

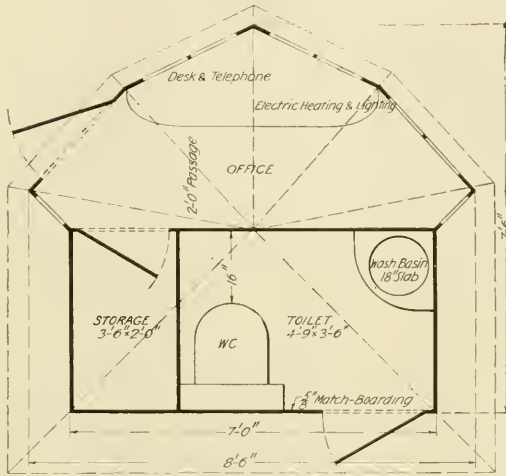

Chicago City Railway—Floor Plan of Terminal Booth.

car and the damaged body sent to the shops on a pair of shop trucks.

#### Terminal Inspection and Cleaning.

In order to maintain the cars in a clean condition while in operating service and thereby relieve the conductors of the duty of sweeping, a system of terminal cleaning and inspection has been inaugurated. Stationed at the terminus of each line of the first division are car cleaners who meet each car as it reaches the terminal on each round trip. The cars are swept and dusted and any minor repairs or adjustments required are at once made. At each terminal a storage closet is provided in connection with the starters' booths, in which are kept an assortment of those parts and fittings that usually are required for minor repairs.

An accompanying illustration shows one of the terminal combination dispatching and cleaning booths. The interior of the booth is divided into three compartments. The front half is used by the dispatcher. Opening off this front half is a tier of compartments in which the terminal car cleaners' supply parts for minor repairs are kept. The remaining portion of the booth is a toilet room with an outside door opening on the side away from the street. Each terminal cleaning station is supplied with a sheet steel rubbish can 24 by 24 by 36 inches in size. Into these cans the cleaners empty all the sweepings from the cars so that no dirt is swept into the streets. Each cleaner also has a sheet steel dustpan about 24 inches long, provided with a hook at one end, which may be placed around the platform stanchion during the sweeping process. The supply of materials at each terminal cleaning booth includes the following: Air fuses, ribbon fuses for double-truck cars, lamps of all kinds, light plugs, motor brushes, compressor brushes, governor fuses, trolley rope, trolley snaps, trolley eye screws, trolley wheels, trolley wheel washers, trolley poles and bases, controller fingers, air gauges,

glass and hands, bell rope, register rope and register pulleys, bell plungers, post grab handles, wood and sockets for same, seat bolts, screen clamps or crossbar, vestibule door hangers and screws, cotter keys, waste, oil, grease and oil can for engineers' valve.

At the more busy terminals two men are required each day, one man reporting at 7 in the morning and working until 7 at night, and the second man reporting at 10 in the morning and working until 10 at night. By this arrangement two men are on duty during the afternoon rush hour. It is not necessary to have two men at each terminal during the morning rush hour because the cars are cleaned thoroughly at the car houses just before they are taken out for the morning runs. After 10 o'clock at night the headway is so increased that the cars for all runs on the first division lines can be cleaned by one man stationed at the downtown terminal of the division. This man is on duty downtown cleaning cars from 11 p. m. until 5:30 a. m., after which he finishes his 10 hours' service at one of the car houses.

This practice of terminal cleaning has been found to be both economical and practical. The value of clean cars in the matter of their impression on the traveling public is inestimable. Also, as the conductors are relieved from their sweeping duties it is possible to shorten the terminal layover time and thereby increase the service performed by each car. The conductors are also able to keep their hands and clothes clean. Another advantage, which is an especially important one, is brought about by the practice of terminal cleaning and



Chicago City Railway—Terminal Booth for Car Cleaner, Repairer and Dispatcher.

inspection. This is the substantial reduction in pull-ins and accidents.

The repair and cleaning men at each terminal report to the assistant master mechanic on blank forms, such as those earlier described for use at the Seventy-seventh street car house.

The organization of the mechanical department comprises a master mechanic, D. A. Faut, reporting to H. B. Fleming, chief engineer, and two assistant master mechanics, R. T. Senter, in charge of car houses and equipment, and D. McGill, in charge of shop work, assisted by car house and shop department foremen. We acknowledge our indebtedness to these heads of departments for assistance rendered in compiling this article descriptive of the interesting car house maintenance work of the Chicago City Railway.

**MILWAUKEE ELECTRIC RAILWAY & LIGHT COMPANY'S  
REPLY TO ACCOUNTING CIRCULAR.**

BY C. N. DUFFY, COMPTROLLER.

Replying on behalf of this company to Accounting Series, Circular No. 20, dated Washington, January 10, 1908, addressed "to accounting officers of electric lines," the circular states: "It is desired that reply to this circular be made not later than March 28, 1908." Circular No. 20, although dated January 10, 1908, was not received at this office until March 2, 1908.

In compliance with your request for certain specific information as outlined in questions Nos. 1 to 11, both inclusive, on pages 4 and 5 of Circular No. 20, the following is submitted:

1. Name of company?
2. Number of miles of line operated?
3. Number of cars operated under normal conditions?

The Milwaukee Electric Railway & Light Company, operating also the Milwaukee Light Heat & Traction Company, covers the following electric railway systems (overhead trolley): (a) Milwaukee city system, the system operated in the city of Milwaukee, Wis., and to and in interurban points adjacent to Milwaukee, comprising approximately 143 miles of single track (revenue track only, tracks in car houses, yards, etc., not considered) and an equipment of 398 double-truck cars. (b) Racine city system, the system operated in the city of Racine, Wis., comprising approximately 18 miles of single track (revenue track only, tracks in car houses, yards, etc., not considered) and an equipment of 20 single-truck cars. (c) Interurban system, composed of three interurban lines radiating from the heart of Milwaukee to Oconomowoc, East Troy and Kenosha, Wis., respectively, comprising approximately 138 miles of single track (revenue track only, tracks in car houses, yards, etc., not considered) and using approximately 15 miles of single track in the city of Milwaukee, Wis., with an equipment of 35 interurban motor cars and 60 interurban trail cars.

This makes a total, as shown in (a), (b) and (c), of approximately 299 miles of single track operated (revenue track only) and approximately 11 miles of single track (non-revenue, tracks in car houses, yards, etc.), or a total trackage of approximately 310 miles measured as single track, with an equipment of 513 cars.

The average maximum number of cars operated per day in the year 1907 was 387, and the average car-hours per car per day was 11.5.

4. Do you favor dividing electric lines into two classes, as outlined in this circular?

No.

5. What limit, in your opinion, should be used as a line of demarcation indicating the distinction between a large and a small company?

If only one line of demarcation is to be drawn, and that line based on "gross annual revenue," then the dividing line should be \$500,000 gross annual revenue, and not \$50,000. Furthermore, the question of having possibly three classes instead of two is worthy of careful consideration, as, for example, the following: (1) For companies having gross annual revenue of \$500,000 or less. (2) For companies having gross annual revenue between \$500,000 and \$1,000,000. (3) For companies having gross annual revenue of \$1,000,000 and over.

It may be that some basis other than "gross annual revenue" could be taken as a line of demarcation, for instance, trackage, cars, etc.

6. What was the gross revenue of your company as shown in its last annual report? \$3,926,469.28.

**Depreciation.**

7. What would be the approximate aggregate charge to

operating expenses for the year ending June 30, 1908, resulting from the application of the theory of depreciation to the equipment of your company as outlined in this classification? (In your reply please explain in detail the method by which you arrive at the amount stated.)

Assuming that "equipment" means the physical property covered in the "tentative classification of expenditures for road and equipment" grouped under "permanent equipment," "revenue equipment" and "service equipment," the approximate aggregate charge to operating expenses for a period of one year would be about \$280,000, based on a "depreciation estimate" of 7 per cent per annum, as being the estimated depreciation over and above maintenance chargeable to operating expenses. "Permanent equipment," as herein treated, is exclusive of "cost of road purchased."

In its relation to "depreciation," "maintenance" is a most important factor. The measure and extent of "depreciation" of physical property is dependent, in so far as wear and tear incident to use is concerned, on the amount of "maintenance" expended in the physical up-keep of the property.

This "depreciation estimate" of \$280,000 is figured at 7 per cent per annum on the cost of reproduction, new, for the physical property covered in "equipment," approximately as valued by the Wisconsin railroad commission as of January 1, 1907, plus additions and betterments made in the year 1907, subsequent to the date of the valuation.

The depreciation charge of 7 per cent per annum is intended to provide only for depreciation resulting from deterioration and wear incident to use, without regard to obsolescence or supersession.

This company believes in the principle of "depreciation" and the practical application of the principle in providing for depreciation in its accounts; it has recognized and applied this principle in its accounts since January 1, 1897. The provision for depreciation has not been to the extent the company considered necessary, but to the extent it was consistently able to provide and give to capital some measure of fair return on its investment.

Referring to "consideration of depreciation," as outlined in Circular No. 20 (pages 7 and 8) and with reference to the "depreciation estimate," as laid down in other places in Circular No. 20, would it not be well to consider, as a means of recognizing the principle of depreciation and the application of that principle, to suggest, or permit, or instruct, if you please, the "accounting officers of electric lines" to take from the gross earnings a certain percentage monthly, from 1 per cent per annum upwards, credit it to a "depreciation reserve account" and distribute the sum so set aside in the proper operating expense accounts, so as to apply to the entire physical property?

This in a way has been the method pursued by this company, the percentage of its gross earnings so set aside being practically 10 per cent since January 1, 1897.

8. What is the present surplus (or deficit) from operation of your company, and in what particular years did it accumulate?

The surplus of this company, as per its books, at the close of business December 31, 1907, was \$884,808.61, accumulated as follows:

Year.	Surplus.	Deficit.
1897.....		\$ 26,447.91
1898.....	\$ 75,870.13	
1899.....	138,686.67	
1900.....	1,439.13	
1901.....	198,543.59	
1902.....	350,849.01	
1903.....		77,264.15
1904.....	150,016.95	
1905.....		120,207.64
1906.....	99,431.54	
1907.....	93,891.29	

\$1,108,728.31      \$223,919.70

9. Please give a list of joint facilities involved in the

operations of your company.

This company has no joint facilities involved in its operations.

10. Do you consider the principles involved in the joint facility accounts as applicable to electric railway carriers?

There is a question as to the practicability of applying to electric railway carriers the principles involved in the joint facility accounts, particularly on such interurban lines as use the tracks of urban companies in operating interurban cars into the heart of and through large cities, especially where the application of said principles would involve a complicated division of fares to cover a complicated ownership or joint use of tracks. The principles involved in the joint facility accounts as laid down in Circular No. 20 are sound and correct.

#### Advisability of Distinct Classifications for Urban and Interurban Roads.

##### 11. General criticisms:

In connection with suggestions made relative to establishing a line of demarcation indicating the distinction between a large and a small company, the advisability of considering two separate and distinct classifications of accounts may be proposed, one for "interurban railway systems," the other for "urban railway systems," as the construction and operation of one is quite different from the other.

The classification of accounts as outlined in Circular No. 20 appears to be essentially a classification better adapted to the conditions and wants of steam railroads rather than electric railways, and is better suited to interurban electric railways than urban electric railways.

It should be borne in mind in speaking of urban electric railways that, in addition to surface lines in cities, there are elevated lines and subway lines as well.

This company, operating two city systems of electric railways aggregating 161 miles of single track, and an interurban system of electric railways aggregating 138 miles of single track, has used continuously for a period of nine years the standard system of electric railway accounting of the Street Railway Accountants' Association of America (amplified for its specific purposes), and has found this system not only fully adapted to its requirements for both its urban and interurban electric railway systems, but entirely satisfactory to the Wisconsin state railroad commission in making annual reports of the operations of the railway systems to that body.

The state of New York found the standard system of electric railway accounting of the Street Railway Accountants' Association of America adapted to its needs, not only for the surface, elevated and subway lines of the city of New York, but also for the interurban lines of the state; and the same statement is true of the state of Illinois with reference to the elevated lines of the city of Chicago, as well as the interurban lines of the state.

This is referred to here in view of statements made to the effect that the classification of accounts of the Accountants' association was suitable only for urban electric railways and was not adapted to interurban electric railways.

The tentative classification of operating expense accounts adopted by the Accountants' association of the American Street and Interurban Railway Association at its convention held in Atlantic City, in October, 1907, was devised for the purpose of meeting the supposed wants of interurban electric railways and with the idea of conforming to the interstate commerce commission classification for steam railways, in so far as was possible and practicable, consistent with the difference in conditions in the construction and operation of electric railways as compared with steam railways, and at the same time meeting the requirements of electric railways. This was accomplished, judged by the action of the convention of the Accountants' association in unanimously adopting the tentative classification after a full and exhaustive discussion and debate of its features, indorsing its principles and their application, and with the conviction that the 50 primary operating expense

accounts and the subaccounts recommended were ample for the purpose of showing the results of the operation of electric railways from the point of view, not only of investors and managers, but state railroad commissions, or other like bodies that exercise or may exercise supervision over the operations of electric railways and their accounts, and the public as well.

The old classification of the Accountants' association, with its 39 primary operating expense accounts and without any subaccounts, used by electric railways for a period of 10 years, officially adopted by the National Association of Railway Commissioners, used by the bureau of the census in gathering and compiling statistics of electric railways for the year 1902, has met all requirements, the 39 accounts being adapted for the wants of the largest electric railway systems and not burdensome for the smallest, by reason of the simplicity and flexibility of the construction and arrangement.

The classification of accounts outlined in Circular No. 20, consisting of 22 primary operating expense accounts for "small companies" and 116 for "large companies," does not prescribe sufficient primary accounts for a small company and it has too many for a large company. A classification of accounts, devised and applied for the purpose of reflecting broadly the results of the operation of a particular business, should be so constructed and arranged as to accomplish this by the application of correct accounting principles in a practical manner to the peculiarities of the business dealt with and cover the specific conditions of the operation of that business. As you yourself, Professor Adams, once said in connection with this question: "Business cannot be put into a strait jacket." To apply the classification of accounts as outlined in Circular No. 20 to the rank and file of the 481 electric railway companies the gross earnings of which were published in 1907, would put the majority of them in a "strait jacket."

The aims and objects of the interstate commerce commission to bring about uniformity of accounts for all carriers, whether operated by steam or electricity, should have the hearty support and co-operation of everyone in any way engaged in the transportation business, whether passenger or freight, or both, or electric or steam. The principles laid down to govern a classification of accounts to accomplish such a result, if said principles are sound and correct and practicable in their application, should be upheld and followed in all classifications of accounts of all railroads. This should obtain, whether dealing with steam or electric railways, urban or interurban, surface, elevated or subway lines in cities, or the operation of parts of the great railroad systems of the country, as they are now operated in part by electricity, notably the New York Central & Hudson River Railroad, or applicable to the operation of the present electric line now in operation underneath the Hudson river, or similar lines under construction and soon to be put into operation. Indeed, the question should be looked at from such a broad, comprehensive and practicable standpoint as to anticipate and provide in advance for what within a few years may be a reality, namely, the substitution of electricity for steam as a motive power, in all lines of railroad transportation.

#### Tentative Classification of Operating Expenses—Adjustment Accounts.

The principles governing "adjustment accounts" for the treatment of "outside operations" are sound and correct, but the points as presented in Circular No. 20 would hardly be applicable to electric railways generally, at least not in the manner and to the extent referred to; and it is questionable whether the questions are of sufficient importance to justify the application of the principles involved in the manner or to the extent suggested.

#### Availability Maintenance Expenses.

Account No. 39, "care of track," intended for and applicable to interurban electric railways, can be properly classi-



fied as a maintenance account without the qualifying term "availability maintenance."

The principles laid down with respect to "availability maintenance account expenses," governing charges under account No. 40, "removal of snow, sand and ice," and No. 41, "cleaning, sprinkling and oiling roadbed," are not applicable to electric railways, as the character of the work performed chargeable to these two accounts does not deal with "maintenance," but with "operation" or "use." The principles involved in connection with the treatment of these two accounts are differently applied with reference to instructions under "lubricating cars" in account No. 95, "car supplies and expenses." The lubrication of car journals dealing with the "operation" or "use" of the cars is classified, and properly so, under "operation of cars," while the up-keep of the car journals dealing with the "maintenance" of the cars is classified, and properly so, under "maintenance of revenue equipment."

There seems to be a difference and contradiction in the application of the same principles in connection with the treatment of "availability maintenance expenses" under "maintenance of way and structures" and under "maintenance of equipment," the latter having no "availability maintenance expenses." Accounts Nos. 40 and 41 should not be grouped under "maintenance of way and structures," but under "transportation expenses," and furthermore, there should not be any such group as "availability maintenance expenses" under "way and structures" or "equipment."

Account No. 42, "injuries to persons," and account No. 43, "other miscellaneous maintenance expenses," are improperly classified when placed in a restricted way under "availability maintenance." The scope of these two accounts, if they are to be applied as outlined, should deal with "maintenance of way and structures" broadly, and not restrictively to "availability maintenance" only.

#### Maintenance of Service Equipment.

"Maintenance of service equipment" should be grouped under "maintenance of equipment," and not under "maintenance of way and structures," as unquestionably the former is the correct subdivision for "maintenance of service equipment" for the reason that all the service equipment, except snow equipment, is used for other purposes than "maintenance of way and structures," just as "shop machinery and tools" are used for all purposes and properly classified under "maintenance of equipment." There is no separation under "maintenance of service equipment" between the electric equipment of the work cars, electric locomotives, etc., and the cars, locomotives, etc., although there is such a separation as applied to the different types of revenue cars operated. This appears to be inconsistent. If separation of the electric equipment is necessary or desirable in one case, it should be in the other, and unquestionably there should be a separation, especially in attempting to arrive at a charge for "depreciation estimate." Furthermore, the experience of electric railways has demonstrated that it is the best practice to carry the maintenance of all electrical equipment of cars, whether for "revenue equipment" or "service equipment," in one account, as these equipments are frequently shifted from one type of car to another.

#### General Expenses.

It is not a desirable arrangement to group "salaries and expenses of general officers" under one account, as provided in account No. 106, or "salaries and expenses of clerks and attendants" in one account, as provided in account No. 107, as these accounts are neither one thing nor the other, with respect to the distinction as between what may be "salaries" and what may be "expenses."

#### Clearing Accounts.

The six clearing accounts as prescribed can be made applicable to electric railways, and the principles governing

them are sound and correct, but it would appear that if there is to be a clearing account for "shop expenses" it should also include account No. 62, "shop machinery and tools," and account No. 63, "other equipment expenditures," and that "work equipment—operation" should also include "maintenance of service equipment," or these clearing accounts, as proposed, will deal only partially with the principles underlying the use of clearing accounts; on the other hand, the important question of drawing the line of demarcation and preserving the integrity of that line absolutely, as between what is "maintenance" and what is "operation" or "use," will be rendered impracticable.

The application and use of "shop expenses" as a clearing account would probably prove somewhat difficult on many electric railways; to treat "insurance" and "injuries and damages" as clearing accounts is an innovation and a departure from former practices in electric railway accounts, but may be the solution of reconciling the differences in the treatment of these two latter accounts as between steam and electric railways, especially as to "injuries and damages." As to "insurance," the practice of electric railways to consider this as one of the "general expenses" of conducting the business, an executive or administrative proposition rather than a departmental one, and by reason thereof carrying all "insurance" in one account and grouping it under "general expenses," is logical and the proper treatment of the question.

If the use of clearing accounts is to be so extensive it might be well to add to the six prescribed an additional one, "stationery and printing."

The clearing account entitled "injuries to persons" should be entitled "injuries and damages," in order that the use and application of this account would be broadened, as indicated by the title, and not be restricted, as it would be, under the title "injuries to persons."

#### Number and Titles of Accounts, Their Grouping and Arrangement.

The number of primary operating expense accounts prescribed by Circular No. 20—116—is objectionable, unnecessary and in many instances impracticable; the number should be condensed into at least one-half of the number proposed.

The titles of many of the accounts are strange and unfamiliar; in a number of cases the titles should be changed for more appropriate and comprehensive ones.

The grouping of the accounts, from the standpoint of electric railways, is not in accord with the best practice based on experience.

These questions are to a considerable degree of minor importance, being questions of detail rather than of principle, outside of the number of primary accounts, which is a matter of the greater importance.

#### Tentative Classification of Expenditures for Road and Equipment.

In the text for account No. 61, "interest and commissions," there is the following note:

"Discounts on securities issued for construction purposes or to raise funds for construction should not be charged to this account or considered as a proper charge against construction."

Discount on securities issued for construction purposes or to raise funds for construction is a "capital expenditure," whether such construction is in connection with a steam railroad or an electric railroad, and if not carried in "expenditures for road and equipment," where is it to be carried?

Under the laws of the state of Wisconsin bonds covering the construction and equipment of electric railways cannot be issued without the sanction and approval of the board of railroad commissioners. The law provides that the bonds so issued may be sold at a discount, said discount not to be more than 25 per cent.

Discount on bonds issued and sold for the construction

and equipment of steam or electric railways is as much a part of the cost of the construction and equipment as the rails or cars.

This principle is sound and correct from an accounting standpoint; just, as far as the public is concerned; equitable, from the standpoint of investors; and a vital question that must be dealt with in financing railroads, steam or electric.

INTERURBAN CARS FOR OKLAHOMA.

The Choctaw Railway & Lighting Company of South McAlester, Okla., has just placed in service two very handsome interurban cars built by the Niles Car & Manufacturing Company of Niles, O. They are modern in every particular,

leaf yellow pine and the two intermediate sills are of 3¼ by 6 inch yellow pine. The end sills are of oak, reinforced with steel plates, and are of the same style and dimensions as the outside sills. The flooring is of yellow pine laid double with waterproof building felt between. The car company's standard method of trussing is used. The needle beams are 6-inch steel I-beams, two to each car, fitted at the ends into truss rod struts fastened to the bottom frame. The bolsters are of steel plate truss form.

The roof is of the monitor deck style, running the full length of the car, with the steam coach type of hood, supported by steel carlines, one over each intermediate side post. Each end of the car is inclosed with permanent vestibules having three sashes and sheathed on the outside below the

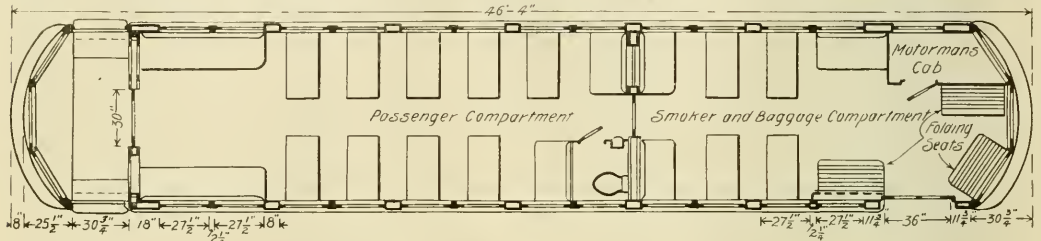

Choctaw Railway Cars—Floor Plan and Seating Arrangement.

and as an indication of the rapid progress that is being made in the interurban and street railway development of that section, a brief description will be of interest.

The cars are of the single-end type, having main passenger and combination smoking and baggage compartments,

sash rest with No. 14 sheet steel. Each side of the rear vestibule is fitted with double steps of the Stanwood type. There are 12 windows on each side between corner posts of the Pullman style, with two sashes to each window. The lower sash is arranged to raise and is fitted with the Edwards



Choctaw Railway Cars—Side View of Finished Body.

with passenger entrances at either side of the rear vestibules. The general dimensions of the cars follow:

Length over end plates .....	34 ft.
Length over vestibules .....	45 ft.
Length over buffers .....	46 ft. 4 in.
Truck centers .....	24 ft. 6 in.
Wheel centers .....	26 ft.
Wheels (diameter) .....	33 in.
Width of car at sills, including panels .....	8 ft. 8 in.
Extreme width of car over all .....	8 ft. 10 in.
Height of car from under side sill to top of roof .....	9 ft. 5 in.
Extreme height from track to top of trolley bridge .....	12 ft. 8 in.
Seating capacity .....	50 persons
Approximate weight of car body without load .....	25,000 lb.

The cars are of semi-steel frame construction. The side sills are composed of one piece of yellow pine 4½ by 7¾ inches and one piece 1¾ by 6 inches, with steel plate ¾ by 7¾ inches bolted between and extending the full length. Each of the two center sills is a 6-inch steel I-beam filled with long-

bevel sash lock and bar. The monitor deck has 12 sashes on each side hung on Hart's ratchet deck fixtures. All sashes in the sides and ends of the car are glazed with polished plate glass, while the upper side sashes and deck sashes are of cathedral art glass. Pantasote curtains on spring rollers with eccentric fixtures are provided for all side and end windows.

The interiors of the cars are finished in quarter-sawed oak. The main passenger compartment has the golden finish, while the smoking compartment is of dark Flemish oak, varnished and rubbed down to a smooth dead finish. The main panels are outlined with a neat inlay of colored woods. The ceilings are of the semi-empire style of 3-ply veneer painted and decorated in green and gold. The toilet room is located in the main passenger compartment against the smoking room partition. As shown in the accompanying floor plan the combination smoking and baggage compartment is arranged to

accommodate the largest possible number of passengers, the motorman's cab being located at the left-hand side and the folding seats being conveniently located for accommodating passengers when the vestibule is not filled with baggage. The seats are of the Hale & Kilburn walkover type, except those against the bulkheads and sides of the car, which have stationary backs. Long longitudinal seats have been placed in the rear of the car so as to facilitate as much as possible the loading and unloading of passengers. The rear vestibule doors are of the swinging type. The end body and partition doors are arranged to slide, the baggage room having a 36-inch sliding door at the right-hand side.

The cars are heated by electricity. Drawbars of the radial type and locomotive form of pilots are used. The exterior of the car is finished in olive green and orange. The Knox Engineering Company of Chicago, engineer for the Choctaw Railway & Lighting Company, prepared the plans and specifications for these cars.

CINCINNATI CAR COMPANY'S PAY-AS-YOU-ENTER CAR.

The Cincinnati Car Company has prepared drawings for a newly designed semi-steel pay-as-you-enter car, which introduces some novel and interesting features. This car is provided at each end of body with the usual swing door, which is used for entrance and exit, according to the direction in which the car is running. An inclosure is built on the platform, which is open to the main body of car, thus eliminating the usual end body bulkhead and sliding doors. The conductor can therefore give all the necessary attention to passengers entering the car, make change and see that the fares are paid. Meanwhile he can watch the passengers inside the car. His presence within the car body makes the calling of streets a simple matter, since there are no doors to open or close. This platform inclosure is provided with a folding and

The partition forming the inclosure can be arranged to take care of a fare box, which will be in full view of the conductor. This arrangement gives the conductor full control of the passengers entering and leaving the car. Should any passenger attempt to pass into the car without paying his fare

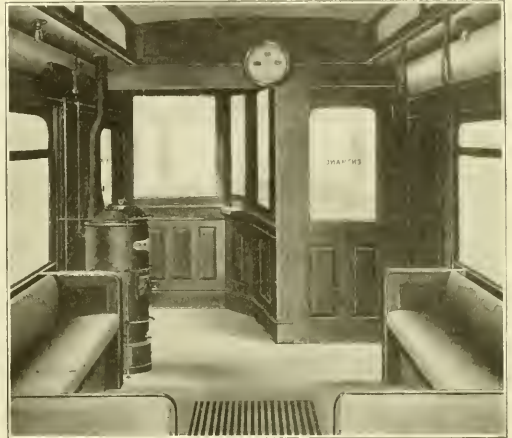

Pay-As-You-Enter Car—Interior View of End.

the conductor may easily stop him by merely stepping in front of the passenger without opening any doors.

At the motorman's end the entrance is inclosed by a sliding door, which is hung on swivel hangers, permitting it to slide back of the controller. It does not take up any more

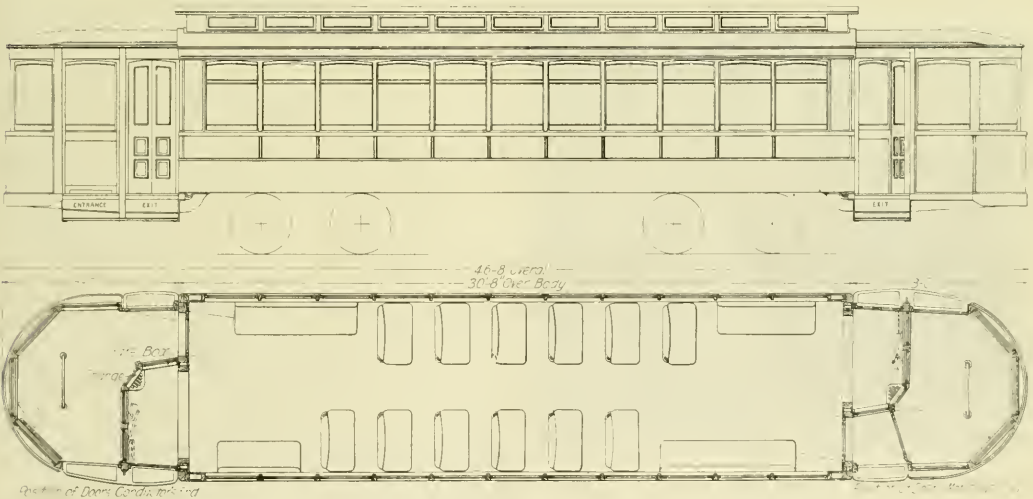

Pay-As-You-Enter Car—Elevation and Floor Plan, Showing Car for Double-End Service.

swinging exit door, which is controlled by the conductor through a lever arrangement with which he can positively lock the door in either position, i. e., open or closed, thereby eliminating any accidents occasioned by passengers leaving the car when it is in motion. The inclosure partition is provided with drop sash, affording ample air circulation in warm weather. This inclosure is further provided with a small window which opens into the entrance side of the platform.

space than the thickness of the door and the necessary allowance to prevent it from being marred by coming in contact with the vestibule finish, etc. The exit door, which is controlled by the conductor (when he is at the rear end), is locked by the lever arrangement earlier described. The front exit door in the body of the car can only be released by the motorman through a magnetic door opener, this door being held closed by a Blount or Corbin door check. The door in-

closing the front platform exit will be hung on double-acting spring hinges and will be swung against the partition, thereby separating the motorman and smokers from any passengers that may be leaving the front end of the car. This door is also controlled by the motorman with swing latch connected to a rod and lever, this lever being directly over the motorman's head. Smokers and others riding on the front platform cannot leave unless the motorman unlocks the door, which, however, is open to passengers who may desire to enter the smoking compartment. This arrangement of door and platform affords a quick exit, as the platform steps are in close proximity to the body door, and passengers leaving the main compartment are not inconvenienced by jostling against the smokers. The car body and front platform can be heated easily because the door arrangement permits no direct drafts.

The designs for cars for both single and double end service are equally simple.

**PAY-AS-YOU-ENTER CAR IN CLEVELAND.**

The first pay-as-you-enter car to be operated in Cleveland was placed in service last week by the Cleveland Electric Railway. The car was reconstructed from one of the company's standard closed cars at the Lake View shops, and, in accordance with the standard practice in Cleveland, it is to be operated from one end only. The car body is 30 feet long and the platforms are each 8 feet long, making a length of 46 feet over all. The arrangement of the rear platform, as shown in the engraving, is practically the same as on the pay-as-you-enter cars which have recently been placed in service in Chicago, Buffalo and New York. The front platform, however, shows several interesting improvements, designed by Terrance Scullin, master mechanic of the Cleveland Electric Railway, which are shown in the accompanying plan.

The front portion of the platform is partitioned off to form the motorman's cab and has a sliding door in one of the

also controls the front exit step, which is dropped as the door opens. A reverse movement closes the door and raises the step, which is folded against the side of the vestibule, so that passengers will not attempt to board the car by means of this door.

On account of the length of the platforms it was necessary to reinforce the sills of the car. On the blind side this was done by means of a 5/8 by 12 inch steel plate bolted to the sill and extending the full length of the outside of the car to the ends of the platforms. On the working side of the car the platforms, which are dropped eight inches, are supported by knees built up from 3/4 by 10 inch steel plates, which extend back along the side of the car for a distance of seven feet.

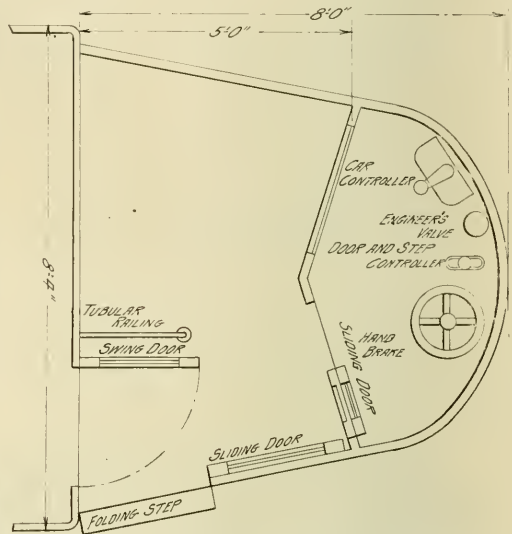

Cleveland Pay-As-You-Enter Car—Plan Showing Arrangement of Front Platform.



Cleveland Pay-As-You-Enter Car—Showing Arrangement of Rear Platform.

sides of the partition which is provided with a catch on the inside so that passengers cannot interfere with the motorman. An iron railing extending outward from the bulkhead separates a space in which smokers may stand from the portion of the platform which is used by outgoing passengers. The door from the car body to the platform folds against the iron railing. The exit door, which is of the sliding type, is controlled by the motorman by means of a lever placed between the hand brake staff and the engineer's valve. This lever

This plate is bolted through the timber side sill and through an outer plate extending the full length of the car body. This method gives a very strong construction for the platforms.

The company is also planning to reconstruct a number of its cars in this way, but the pay-as-you-enter collecting system will not be enforced until there are sufficient cars to equip one line.

We are indebted for the description of the car to George L. Radcliffe, general superintendent of the Cleveland Electric Railway.

The Sapulpa & Interurban Railway Company, which was organized about a year ago to build a street railway system in Sapulpa, Okla., and extensions to the Glenn oil fields, has recently completed its line in Sapulpa. The formal opening of the line occurred on March 18, when members of the Commercial Club and the city council and newspaper representatives made the initial trip in the new cars and later attended a banquet given by the company at its power house. The company expects to continue the line through the Glenn oil fields to a connection with the Midland Valley Railroad.

**Pay-As-You-Enter Cars for Newark.**

It is announced that 50 new cars of the pay-as-you-enter type will be placed in service in Newark, N. J., by the Public Service Railway on Sunday, April 12. These cars were built by the Cincinnati Car Company and were described in the Electric Railway Review of February 15, 1908, page 213.

**PASSENGER AND BAGGAGE CARS FOR THE WATERLOO CEDAR FALLS & NORTHERN RAILWAY.**

The Waterloo Cedar Falls & Northern Railway of Waterloo, Ia., has recently received from the McGuire-Cummings Manufacturing Company three combination passenger and baggage cars which were designed under the personal supervision of C. D. Cass, general manager of the railway company. As this company operates 50 miles of steam road in addition to its 39 miles of electric line, the cars are designed for operation in trains with standard steam railroad cars and are of a substantial type of construction.

The cars are for single-end operation and the baggage compartment, which also serves as the motorman's cab, is at the front end. They have the steam coach type of hood with six double windows and one baggage and one vestibule door on each side. They are equipped with M. C. B. draft gear, with Pitt automatic couplers, 5 by 5 inch shank, at each end. Under the front platform is a locomotive type of pilot so placed as to allow two cars to be coupled without interfering with the pilot.

The details of the side and floor framing are shown in the accompanying drawings. The principal dimensions are as follows:

sash fixtures of the Raymond type. The side sashes are fitted with double-strength glass embedded in rubber, while the gothics and deck sashes are fitted with opalescent glass, the deck sashes being operated by Hart deck sash ratchets. In the rear end of the car body is a single 30-inch sliding door with double sashes in one part on either side of it. The door between the baggage and the main compartments has a 25-inch



Waterloo Cedar Falls & Northern—Exterior of Combination Platform.

opening with panels on either side of the same design as the windows at the rear end. Each car contains 22 Hale & Kilburn No. 10 stationary rattan upholstered seats, 18 by 34 inches, with grip handles on the aisle side, and two stationary rattan seats at the vestibule end of the car, which afford seats

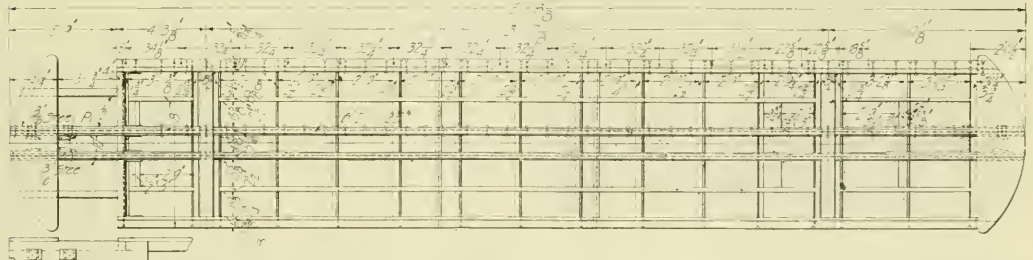
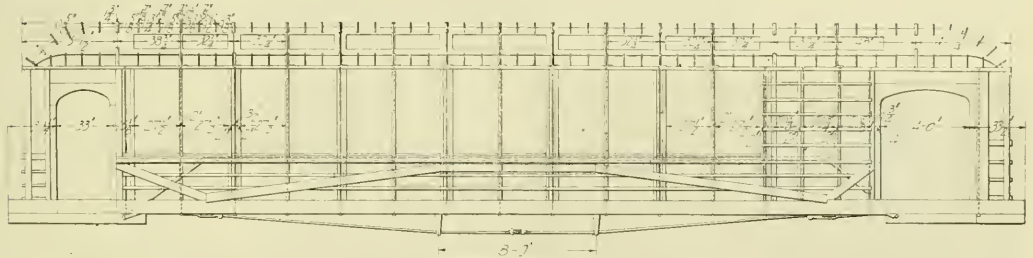

Waterloo Cedar Falls & Northern—Framing of Combination Car.

Length over all .....	51 ft. 8 $\frac{7}{8}$ in.
Width over all .....	8 ft. 10 $\frac{3}{4}$ in.
Width over side sills .....	8 ft. 7 in.
Width inside .....	7 ft. 8 $\frac{3}{4}$ in.
Height from rail over trolley board .....	12 ft. 11 in.
Height from rail to center of drawbar .....	34 $\frac{1}{2}$ in.
Truck centers .....	31 ft. 7 $\frac{7}{8}$ in.

The interior finish is of golden oak with headlinings of birdseye maple. The windows have half oval gothics and 7 $\frac{1}{2}$ -inch pier panels. The sashes are double in two parts, with

for 48 passengers. The curtains are Pantasote, with Keeler eccentric fixtures. A curtain box is built just below each gothic sash.

The baggage room is finished in golden oak and has three sashes in front. The center single sash is in one part and the two side sashes are single in two parts. The segment sashes are glazed with opalescent glass like the gothic sashes. The baggage compartment also has four deck sashes for ventilation.

The vestibule at the rear is finished in golden oak. The doors are double, with oval heads, and are arranged to fold back against the end of the car. The sashes are arranged as in the baggage compartment. The ceiling is provided with a dome painted in light green. The vestibule is also provided with trap doors to fold behind the doors.

The cars are heated with Baker "Mighty Midget" heaters, placed in the baggage room, with a 1¼-inch radiation pipe running back and forth under each seat. A heater pipe grill is placed between the seats. In addition to this hot water heating system there are 12 Consolidated Sar-Heating Company's No. 192-W electric heaters placed in the passenger compartment under the seats and four on the bulkhead partition in the baggage compartment. The electric heaters are for use during mild weather.

The cars are wired for five circuits of five lamps each and two Lintern rear-end markers, which are fed by 12-cell batteries. The cells are placed under the vestibule and the current is controlled by a switch in the vestibule. The five lamps in the baggage compartment are independent of all other circuits and are controlled by a switch over the controller. In the passenger compartment there are 18 lamps and in the vestibule two lamps. The switches for those in the passenger compartment are placed in a small alcove, lined with asbestos, in the baggage compartment. On each post in the passenger compartment is a push button operating a signal bell in the baggage room. The cells for the push buttons are placed in the same alcove as the switches.

The trucks on which the new car bodies are mounted are the McGuire-Cummings Manufacturing Company's standard

The truck bolster is of the built-up type, the top member being 8 by 7/8 inches and the bottom member 8 by 7/8 inches, with a wrought filler placed between at the ends. The bottom bar is gibbed to take the thrust of the end bar. The truck equalizers are 6 by 1 inches in section. The center plate and side bearings are of cast iron and the spring plank is an 8-inch channel. The bolster springs are double elliptic, 32 inches in length. The equalizer springs are 7½ inches in diameter, with a bar 1¼ inches in diameter and 9¾ inches high.

The wheels were made by the St. Louis Car Wheel Company and are 33 inches in diameter, weighing 485 pounds each. The axles, of open-hearth steel, have the following dimensions:

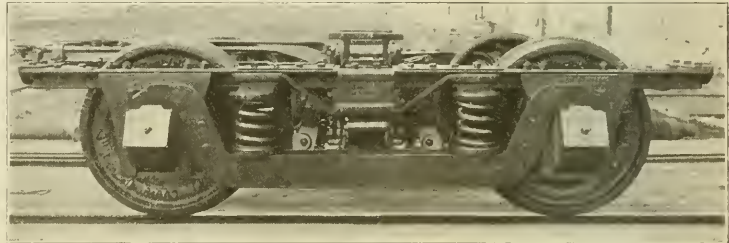

Waterloo Cedar Falls & Northern—Truck for Combination Car.

Diameter at centers, 5 inches; diameter at gear seat, 5¼ inches; diameter at wheel seat, 5¼ inches; journals, 4¼ by 8 inches.

The journals and boxes are in accordance with the standards of the American Street and Interurban Railway Association. The journal bearings are of bronze, lead line. The brakes are inside hung. The approximate weight of the trucks is 7,800 pounds. The McGuire-Cummings Manufacturing Company has also recently shipped to this road seven single-truck closed cars and ten 10-bench single-truck open cars for city service.



Waterloo Cedar Falls & Northern—Interior of Car.

No. 20-A type for heavy interurban service. A side view is presented herewith. They are equipped with four General Electric Company 50-horsepower motors and are designed for nose suspension. The general dimensions are as follows:

Wheel base .....	6 ft. 6 in.
Center to center of journals .....	6 ft. 3 in.
Width of frame over all .....	6 ft. 10 3/8 in.
Length of frame .....	10 ft. 1 in.
Top side members angle iron .....	4x3½x9/8 in.
End sill angle iron .....	3½x3½x3½ in.
Transom .....	1x8 in.
Tension bar .....	3¼x¾ in.

HOME-MADE OIL FILTER.

BY J. L. SULLIVAN.

In power plants it is found that a considerable saving can be effected by close attention to the handling of oil. The accompanying illustration shows a home-made oil filter which has done remarkably good service in the power plant of the St. Francois County Electric Railway Company, Farmington, Mo.

The mixture of oil and water that is received from the engine is poured into the top, being strained through cotton waste, which keeps out everything except water, oil and very fine dirt. It then passes through a 1-inch pipe in the center to within 1 inch of the bottom, the oil rising to the surface of the water and the fine dirt settling to the bottom. In rising the oil is forced through ½ inch of felt and 5 inches of wool waste packed tightly. It comes out of the upper cock as clear as anyone would wish. A steam pipe is run through to be used when cold weather interferes with the free flow of the oil. This pipe is cleaned out by forcing water down the center pipe and allowing it to wash the dirt out through the cock at the bottom.

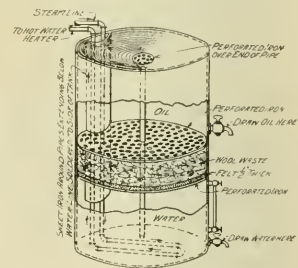

A Simple Oil Filter.

## JOHN ALBERT BRILL.

John Albert Brill, vice-president, director and one of the founders of The J. G. Brill Company, died in Philadelphia on March 25, as noted in last week's issue of the Electric Railway Review. His death was the result of a painful malady from which he had suffered for four years. Mr. Brill was a pioneer in the development of electric cars and trucks and was the inventor of some of the most valuable improvements in the field of electric transportation, as is indicated by nearly 200 patents on cars and trucks and their parts which were issued to him.

He was of German descent, his parents having moved from Cassel, Germany, to Philadelphia, where he was born on December 15, 1852. As a boy he manifested a studious disposition and he received a good education. At the early age of 17 his ambitious desire to begin his active career led him into the works of the company to which the remainder of his life was devoted and whose success is due in such great measure to his personality. He at once gave evidence of the ability that was in him and while doing a boy's work put his whole soul into each task. He was gradually advanced to more responsible positions and was soon placed in charge of the sales department.

With the development of electric car propulsion in 1887 his great abilities found their appropriate sphere. He conceived the fundamental principle of electric truck construction—the necessity for an independent frame to support the motor—and the first truck built on this plan was of his design. Many of the types of truck in general use at present are practically those which he invented. Possessed of ability of a high order, combining keen insight with indomitable perseverance, he brought to his work the highest qualities of the inventor and the improvements due to his efforts have affected nearly every feature which goes to make up the modern electric car.

He was in every sense of the word a pioneer in the art of electric car construction and foresaw, as if by instinct, and usually years in advance, the tendency of direction of electric street railway development. He devoted himself to the task of teaching the railway companies in accordance with the prospective development which he foresaw. His wisdom and sound judgment were recognized and his advice was constantly sought and followed by the men who were foremost in the management of electric railways.

In 1904 he was awarded the John Scott legacy premium and medal by the Franklin Institute in recognition of his valuable inventions.

The accompanying portrait of Mr. Brill, though not recent, is a good likeness.



John Albert Brill.

## NEW CAR CONSTRUCTION—FT. SMITH LIGHT &amp; TRACTION COMPANY.

The Ft. Smith Light & Traction Company has recently built several rolling stock equipments in its shops at Ft. Smith, Ark. Among these is a construction car which measures 34 feet 6 inches long over all by 7 feet 6 inches wide. This narrow width was made necessary by local conditions, as was the short distance between truck centers, which is 22 feet. The side sills are 6 by 12 inches by 33 feet; center sills 6 by 8 inches; needle beams 4 by 8 inches; end sills 5 by 12 inches. The bolsters are built up of 1 by 6 inch iron. A motorman's cab 6 by 5 feet by 6 feet 6 inches is situated about 18 inches from one end. The trucks are Wason Manufacturing Company's No. 18 type, with a 6-foot wheel base. The motor equipment includes four Westinghouse No. 12-A 30-horsepower railway motors with a gear ratio of 14-68. One

type K-12 controller is used. Peacock hand brakes are used in connection with an American Car Company's vertical wheel brake.

Other work which has recently been undertaken includes the reconstruction and enlargement of four single-truck closed cars. These cars were 31 feet long over bumpers and 8 feet 4 inches wide, mounted on two 4-inch axles. After much trouble and expense had been caused by broken axles it was decided to lengthen the cars and equip them with double trucks, and the first one has been completed. This car was cut in two at the center and a section 4 feet 9 inches long, the width of two windows, was spliced in. The car is now 37 feet 9 inches long and 8 feet 4 inches wide over all; length of body, 25 feet 9 inches; distance between truck centers, 17 feet; height from rail to trolley board, 12 feet 1 inch. The end frame is composed of steel I-beams, two 6-inch beams for side sills and two 4-inch beams for center sills. The latter extend from

bumper to bumper. The bolsters are  $\frac{5}{8}$  by 8 inch steel. The steel frame is riveted and bolted together and is a complete unit in itself. These cars will be equipped with Brill No. 27 G-1 trucks with 4-foot 6-inch wheel base, and two Westinghouse No. 38-B railway motors. The cars are to operate double-ended and have K-11 controllers and Peacock brakes.

The plans for the new and reconstructed equipments were drawn and the work executed under the charge of G. W. Chynoweth, foreman of the car house and shops of the Ft. Smith Light & Traction Company.

The Strang Gas-Electric Car Company's new steel passenger car "Irene," operated by a gasoline engine and a storage battery, made a test trip over the tracks of the Pennsylvania Railroad from Jersey City to Philadelphia on March 29 in 1 hour and 45 minutes.

# News of the Week

## Trolley Trip from Chicago to New York.

Elliott Flower, representing the Chicago Tribune, started last Sunday on a trip from Chicago to New York, using electric railways as much as possible. By Thursday night he had reached Buffalo, having covered 783 miles, of which 132 were by steam road, at an expense of \$14.70 for fares.

Mr. Flower's route by days, including Thursday, was as follows: Chicago to Kankakee, via the Chicago & Southern Traction Company; Kankakee to Lafayette, Ind., by steam road; Lafayette to Indianapolis, Terre Haute Indianapolis & Eastern Traction Company; Indianapolis to Dayton, Terre Haute Indianapolis & Eastern Traction Company and Ohio Electric Railway; Dayton to Toledo, Western Ohio Railway and Toledo Bowling Green & Southern Traction Company; Toledo to Cleveland, Lake Shore Electric Railway; Cleveland to Westfield, Cleveland Painesville & Eastern Railroad, Conneaut & Erie Traction Company, Buffalo & Lake Erie Traction Company; Westfield to Buffalo, steam road.

## The Cleveland Situation.

Representatives of the city of Cleveland, the Cleveland Electric Railway and the Municipal Traction Company have been engaged for several days in deciding on the form of the lease under which the street railways are to be turned over to a holding company and it is stated that the draft of the lease is now practically complete. It has been definitely decided that the new company shall be called the "Cleveland Railway Company" and that the lease is to be so drawn as to make forfeiture almost impossible. No rate of fare will be specified.

On March 26 a plan was agreed upon for rebuilding the street railway tracks on Central avenue and Quincy street, which were torn up last year by the Cleveland Electric Railway after its franchise had expired, and on the following day the work of construction was begun by city employees. The plan was suggested by Mr. Goff after the Cleveland Electric Railway had refused to do the work unless granted a franchise. The track is to be owned by the Neutral Street Railway Company, organized by F. H. Goff and A. B. du Pont, president of the Municipal Traction Company, who are to furnish the money for the construction. Operating rights are to be granted to the Cleveland Electric Railway and the Forest City Railway at a nominal rental. A franchise owned by the Low-Fare Railway has been assigned to the new company.

## Accident Frauds in Baltimore.

Bulletin No. 7 in the series which is being published in the daily newspapers by the United Railways & Electric Company of Baltimore discusses "accident frauds and ambulance chasers." The bulletin states that thousands of fraudulent claims are made, and gives two cases where dishonest claimants received jail sentences.

"Out of this hotbed of corruption," the bulletin states, "has sprung the so-called shyster lawyer or ambulance chaser." An abstract of a statement concerning "what this means to the public" follows:

"(a) The activities of the 'shyster lawyer' or 'ambulance chaser' do not cease with us. Everything is grist for his mill. He alleges that his client has been injured by a hole in the city streets and he sues the city. He discovers a claim against the thrifty mechanic or laboring man, and he levies upon the wage earner. He hears that a tradesman is a little behind in his settlements and he wrecks him by throwing him into the hands of a receiver.

"(b) He even finds his way into the home. Many a trifling quarrel between husband and wife, which would otherwise be forgotten in the course of time, is dragged by him into the records of the court.

"(c) Out of a total of nearly 1,000 cases on the January calendars of one of the three civil courts of Baltimore, to wit, the city court, over 80 per cent were damage suits.

"You, as a taxpayer, must pay the costs of judges and jurymen and all other costs which the litigants fail to pay, while hundreds of these false and frivolous cases absorb the time of the court and postpone the consideration of commercial cases and honest disputes."

## Order Barring Newsboys from Cars Upheld.

The order of the Chicago City Railway prohibiting the sale of newspapers on its new pay-as-you-enter cars, which resulted in a newsboys' riot, instigated by the Chicago evening papers, on March 17 and 18, was completely upheld by Judge Goodnow of the municipal court on March 31 in the trial of

several newsboys and others who were arrested for participating in the assault on the conductors, which was described in the Electric Railway Review of March 21. Two of the newsboys were released, others were turned over to the juvenile court, and John Burke, who, although not a newsboy, participated in the riot, was fined \$50. The cases of two others who were arrested have been postponed until April 11.

A portion of the judge's instructions to the jury, which sustains the legality of the company's order, is as follows:

"The jury is instructed by the court that the Chicago City Railway Company has a legal right to prevent any person from selling newspapers or any other article of merchandise on its street cars, and that no person has a right by force and violence to become a passenger on the street car for the express purpose of selling newspapers or any other article of merchandise on such street car; and if you find from the evidence that any person sought to become a passenger on such street car of the Chicago City Railway Company for the express purpose and with the express intention of selling newspapers on such street car, then the employes on such street car had the lawful right to prevent such person from becoming a passenger on such street car, whether such person tendered the payment of his fare or not."

The Chicago City Railway announces that it will adhere strictly to its rule, stating that the rule barring newsboys from the new cars has received the support of the company's patrons, the city administration and the company's employes.

## Calumet & South Chicago Railway Ordinance Passed.

The ordinance extending the franchises of the Calumet Electric Street Railway and the South Chicago City Railway from 1912 and 1915 to 1928 and providing for a consolidation of the two companies under the name of the Calumet & South Chicago Railway was passed by the Chicago city council on March 30. The ordinance is very similar in its provisions to the franchise extension ordinances of the Chicago City Railway and the Chicago Railways Company. The city is to receive 55 per cent of the net receipts after operating expenses, taxes and depreciation have been deducted from the gross receipts, and may purchase the property for municipal operation upon six months' notice, for the present value, which is fixed at \$6,000,000, plus the amount expended for improvements and a 12 per cent bonus. The Chicago City Railway may also purchase the property on the same terms.

The company is required to completely rehabilitate its property within 3½ years and to begin the reconstruction of 40 miles of new track at the expiration of one year from the date of acceptance of the ordinance. Seven specified extensions are to be completed before January 1, 1910, 15 new cars are to be purchased with a year and as many more thereafter as may be determined by the board of supervising engineers.

The board of supervising engineers, which is to have supervision over all of the rehabilitation and extension work and to prepare plans and specifications for such work, is to have duties and powers similar to the board for the Chicago City Railway and the Chicago Railways companies. The board will be composed of three members, of whom one is to be appointed by the city and one by the company. Bion J. Arnold is named as the third member and chairman of the board. He will also act as chief engineer of the rehabilitation work.

The company is authorized to operate express as well as passenger cars. Provision is made for an interchange of transfers with the Chicago City Railway by establishing four transfer zones. In the first transfers are to be exchanged after four months. In the second the council may require an exchange of transfers after one year and four months, provided the net earnings for the year amount to 5 per cent on the investment and the company's share of the net earnings amounts to 1¼ per cent on the investment. The exchange of transfers may be extended to the third and fourth zones under the same provisions.

## Transit Affairs in New York—Brooklyn Subway Approved.

The forms of contract for the Brooklyn Fourth avenue subway were approved on March 26 by the board of estimate, which thus authorized the public service commission for the first district to prepare for the construction of the entire six sections of the subway. The route extends from the Brooklyn end of the Manhattan bridge under Fulton street to Ashland place and thence under Fourth avenue to Forty-third street. The estimated cost of construction is \$15,000,000, with about \$6,000,000 additional as the cost of the real estate to be acquired. A special committee appointed to consider the matter submitted a report recommending the construction of only the first section, on the ground that the city's finances would not permit the construction of the entire subway. B. S.



Coler, president of the borough of Brooklyn, then submitted a resolution authorizing the construction of the entire route. This resolution was adopted in spite of the opposition of Comptroller Metz and Mayor McClellan, who insisted that the required bonds for the subway could not be issued under the city's debt limit.

The public service commission at once passed a resolution authorizing the preparation of the advertisements for bids. The acting corporation counsel on March 30 found the contracts for the subway correct in form, but withheld his formal indorsement of approval because of the apparent lack of appropriation to complete the work. The public service commission has taken the approval of the form of contract as sufficient and has announced that it will begin advertising for bids on Monday, April 6, the time limit for receiving bids being May 8. Bids will be received for construction alone. Arrangements for equipment and operation will be made later. The plans call for a 4-track road, to be excavated under cover, and two years is allowed for the completion of the contract. Bids for the construction of pipe galleries will be received separately. Contracts for the construction of the subway may be awarded within 20 days from the date of receiving the bids, although Comptroller Metz states that the city cannot provide the necessary funds and that he will probably refuse to certify the contracts.

The public service commission has issued an appendix to its annual report, which deals with the relation of the constitutional debt limit of the city to subway construction, and advocates the passage of a bill by the legislature eliminating from consideration in regard to the debt limit all bonds already issued for subway construction so long as the revenue produced by the subways built shall be sufficient to pay the interest on the bonds and provide a sinking fund for their redemption. The existing subway, the commission points out, was authorized by the rapid transit act of 1891, but it was 10 years before the actual work of construction was begun and three years later that the subway was opened for public use. Chief of the hindrances to the beginning and completion of the work was the ever-recurring question of the debt limit.

The appendix reviews the history of the debt limit legislation to show that its object was to prevent the placing of burdens upon the taxpayers, and points out that bonds of such investments as subways and water supply, etc., are not a burden on the city, but are an actual advantage, which produce sufficient revenue to pay not only the ordinary expenses of maintenance and operation, but also the interest and sinking fund charges and perhaps a profit besides.

Chief Engineer Withington of the city finance department on March 27 submitted a report to Comptroller Metz on the request made recently by Bridge Commissioner Stevenson for authority to let a contract for the reconstruction of the Manhattan approach of the Brooklyn bridge, in order to provide a means for running the bridge trains into the new subway loop connecting the Brooklyn and Williamsburg bridges, which is now under construction. Mr. Withington objected to the plan because the heavy grade would require that all trains using the loop be composed of motor cars. He also doubted whether Mr. Stevenson's plan would lessen the congestion of the bridge.

#### Legislation Affecting Electric Railways.

**Maryland.**—The legislature has passed an amendment to the present race separation law, extending its provisions to apply to electric railways operating for more than 20 miles outside of the limits of a city.

**Massachusetts.**—Acting Governor Draper has signed the law allowing street railway companies to install temporary tracks under certain conditions in the event of bridges being repaired. The new law provides that if a bridge upon which a street railway company is authorized to lay and use tracks is being or is to be improved or repaired, the aldermen or selectmen upon petition of the company may grant a temporary location for extension of the company's tracks in any streets so as to provide connection between the existing tracks on each side of the bridge. In case of failure of the local authorities to grant this permission the street railway may appeal to the railroad commission.—The railroad commission has sent to the legislature an answer to inquiries regarding the proposed consolidation of the West End Street Railway with the Boston Elevated Railway, which is provided for in a bill now pending. The board states that the consolidation would be consistent with the public interests provided certain safeguards which it suggests be inserted in the bill: that the Boston Elevated shall be subject to all duties, liabilities and obligations of the West End company under existing laws, that the Boston Elevated shall not acquire any additional rights or privileges except such as are expressly granted by

the act, and that the facilities for travel on the lines of each company shall not be diminished or the rates of fare increased by reason of the act. The bill has been favorably reported by the committee on street railways.

**New Jersey.**—The house has passed a bill requiring the West Jersey & Seashore Railroad to protect its third rail to a distance of 75 feet on each side of all grade crossings. An amendment requiring that the third rail be protected throughout its entire length was defeated.

**New York.**—A bill has been introduced in the legislature to repeal a present law which prohibits the construction of a railroad, steam or electric, on the so-called South Shore road on Long Island, between Bay Shore and Patchogue.—The assembly has passed the railroad committee's bill, drafted as a substitute for the Wagner 5-cent fare bill, which prohibits street railways from charging more than a 5-cent fare, unless authorized to do so by the public service commission. The bill is intended to prevent the Brooklyn Rapid Transit Company from charging more than five cents fare from New York to Coney Island.—The senate judiciary committee has reported a bill, introduced by Senator Grady, which requires the unanimous consent of the stockholders to effect a consolidation of two or more street railways in New York City. The bill is said to be in the interest of minority stockholders of the New York Westchester & Boston Railway and the New York & Portchester Railroad, which are both controlled by the New York New Haven & Hartford Railroad.

**Ohio.**—The house on March 27 voted to postpone indefinitely consideration of the Stockwell bill, which permits cities to own or acquire street railways, but not to operate them.

**To Remove Old Tracks in St. Louis.**—The United Railways Company of St. Louis has agreed to remove about seven miles of unused tracks in the city and to repave the streets.

**Western Society of Engineers.**—At a meeting of the Western Society of Engineers, held in the society rooms in the Monadnock block, Chicago, on April 1, W. M. Torrance presented a paper, illustrated by lantern slide views, on "Reinforced Concrete Structures in Hudson River Tunnel Work."

**Date of New York Meeting Changed.**—The executive committee of the Street Railway Association of the State of New York has announced that the date of the annual meeting has been postponed to June 30 and July 1. The place is the same as announced previously, at the Clifton hotel, Niagara Falls, Ont.

**American Institute of Electrical Engineers, Toledo Section.**—At the regular monthly meeting of the Toledo branch, held on Friday evening, April 3, 1908, in the Builders' exchange at Toledo, O., T. R. Fishbeck of the Electric Controller & Supply Company, Cleveland, O., presented a paper on "Lifting Magnets and Their Application." The lecture was illustrated with lantern slides and a practical demonstration.

**Reduction of Wages Proposed.**—Press reports state that the motormen and conductors of the Pittsburg Railways Company threatened on March 31 to strike rather than accept a proposed reduction of wages of three cents an hour. An agreement between the company and its employes was finally reached, however, under which the present wage scale of 25, 26 and 27 cents an hour is to be continued until April 7, in order that a settlement may be made in the meantime.

**Trial Trip on the Washington Baltimore & Annapolis.**—J. N. Shannahan, vice-president and general manager of the Washington Baltimore & Annapolis Electric Railway, Washington, D. C., in company with his principal assistants, representatives of the Roberts & Abbott Company of Cleveland, O., and of the Fidelity Construction Company of Detroit, Mich., made a trial trip over the new road last week from Washington, D. C., to Baltimore, Md. This was the first car to reach the Baltimore terminal of the line.

**Readjustment of Fares Needed in Massachusetts.**—At the annual meeting of the New England Street Railway Club, Boston, on March 26, an account of which was published in last week's issue of the Electric Railway Review, James F. Shaw, first vice-president of the American Street and Interurban Railway Association, warned those present that the income on electric railway investments, in New England, was not sufficient to induce investors to devote any more money to the development of that industry. He added: "I believe the low rate of income in Massachusetts can be materially increased by a readjustment of fares, either by increasing the fare unit or by shortening the fare limits, and by limiting the use of transfers, and also by the development of the express business, which will not only benefit the street railways but the whole community."

# Traffic and Transportation

## To Discontinue Transfers Between New York City Railway and Third Avenue Road.

Judge Lacombe of the United States circuit court, New York, has rendered a decision that transfers between most of the lines of the New York City Railway and of the Third Avenue Railroad may be abolished after April 11.

Judge Lacombe's decision was rendered upon an application made by the receiver for the Third Avenue road and the receivers for the Metropolitan and New York City Railway companies for instructions. Judge Lacombe says:

"As a business proposition it is sufficient to refer to the detailed statement of conditions set forth in the petitions submitted on this application. It is obvious that a curtailment of transfer privileges in the manner suggested will increase the cash receipts of the properties affected, and since receivers are trustees for the creditors and owners their duty to operate the roads so as to increase earnings is equally obvious."

With several exceptions Judge Lacombe finds no legal reason why the transfers should not be discontinued.

The petition filed by Receiver Frederick W. Whitridge of the Third Avenue road says that he desires to maintain the transfer system between the Third Avenue road and its branches so as "to assist in building up a system of roads better fitted to compete with the Metropolitan system."

Mr. Whitridge has found upon investigation that for the month ending February 15 the Third Avenue road carried 4,067,618 passengers, of whom 2,944,341 paid their fares in money and 1,123,277 paid with transfer tickets obtained on other lines. He is confident that with the abolition of transfers the earnings of the Third Avenue road would be increased by 10 to 20 per cent.

"Public opinion may dislike, but I think it will not fail to justify, the abandonment of the transfer system," says the receiver. "We have been industriously educated to believe that great combinations and monopolies such as the New York traction system was, are abominable evils, but they have afforded the public some advantages, as in this case the transfer system, and fair-minded persons will hardly expect to retain the advantages of a monopoly after the combination which effected it has been destroyed and competition restored. Competition is, intelligent people now generally agree, except when it occasionally becomes ruinous, expensive for everybody."

"In this case the Third Avenue Railroad is owned, operated and will doubtless be reorganized, wholly independently; it is no longer a part of a monopoly, and it cannot afford to offer to its patrons any of the advantages of a monopoly. The additional administrative expenses necessitated by its independent condition will be many thousands of dollars annually, and the company needs all the sources of revenue which it formerly had to meet them, and I cannot doubt that the press and the public will be quick to recognize this fact and will cheerfully pay their fares in cash, when they realize that the transfer system is ruinous to the company, a temptation to its employees and demoralizing to the public itself."

Mr. Whitridge included in his petition the statement of one of his employees, who tells how he rode all day long, from 10 o'clock in the morning until after 6 o'clock at night, on 10 cents and rode to Hoboken through the McAdoo tunnel and back besides. He had to spend the extra five cents to get a northbound transfer. The southbound slip, he found, would carry him almost anywhere east, west and south. He managed to do a little shopping and to eat dinner in between.

### Increased Service Orders in New York.

The New York public service commission, first district, has passed an order requiring the interborough Rapid Transit Company to increase the service on the Second avenue elevated line.

The commission has given the Third Avenue Railroad an extension of 30 days in which to complete the overhauling of its summer cars.

At a hearing before the New York public service commission, first district, regarding a tentative order for an increase in the number of cars on certain lines, Arthur N. Dutton, superintendent of transportation of the Brooklyn Rapid Transit system, protested against the methods followed by the commission in ordering increased service. Mr. Dutton said that the public service commissions law did not intend that it should be within the province of the commission to make hard and fast orders as to the number of cars that should be operated on a given line, but that when the commission determined that increased service was needed it should issue an

order to that effect and allow the company to work out the details. Mr. Dutton added that schedules could not be fixed by set rules because traffic conditions differed from day to day.

### Fare Increases in Massachusetts.

The Connecticut Valley Street Railway of Greenfield, Mass., has increased its fares to a number of points, effective on April 1. The company announces that the object of the revision of fares is to bring, as nearly as possible, the four divisions of the property to a common earning capacity per car-mile. For the year ending September 30, 1907, the average earning capacity of the system per car-mile was 19.2 cents. The Amherst division averaged 22 cents, the Deerfield division 17.8 cents, the Greenfield division 23 cents and the Millers Falls division 14 cents. The management states that to obtain the desired result in the past various experiments of reduced fares with a view to increasing the traffic have been tried.

### Illinois Traction System Rates.

A new timetable of the Illinois Traction System, issued by B. R. Stephens, general traffic manager, Springfield, contains 20 pages. Each Saturday and Sunday, until further notice, the following special rates will be in force: Round trip between East St. Louis and points between Millwood and Springfield, \$1.50; round trip between East St. Louis and Carlinville, \$1.25; round trip between East St. Louis and Gillespie and Bend, \$1; round trip between East St. Louis and Mt. Olive, Litchfield and Hillsboro, \$1. "These low rates," the timetable states, "are made to introduce our service to the public. A trial will demonstrate the possibilities and pleasure of long distance interurban service." Other information is given as follows:

"The rates on the system are, as near as practicable, based on 2 cents per mile in one direction, with lower rates for round-trip tickets. Also \$10 fare books, which practically cover 500 miles of travel, are on sale at all ticket offices at \$7.50 net. The books are unlimited and are issued to individuals or families or firms. The \$5.00 fare books are sold for \$3.75 net, issued to individuals and good for six months. They have become a household necessity along our lines.

"Commutation books, limited to 30 days, 52 rides to a book, are sold at the rate of 1 cent per mile, with a minimum of 5 cents per ride or \$2.60 per book. This rate is given only on condition of using the 52 rides during continuous 30 days, and no extension of time or refund on coupons is given."

### Reasons for Fare Increases in Massachusetts.

The Newton (Mass.) Street Railway and the Newton & Boston Street Railway, which have increased their units of fare from 5 to 6 cents, have sent an explanatory statement to people living on the lines of the companies, which says in part:

"The following facts have brought about present conditions: (1) The wages paid by the companies are very much in excess of those paid a few years ago. (2) The cost of all materials used in construction and operation of a street railway has increased in a varying ratio from 20 to 100 per cent. (3) The distance which patrons can ride for one unit of fare has been steadily increasing by extensions of fare limit points and added transfer facilities. (4) The roadbed and equipment have been gradually and constantly wearing out, with the inevitable result of necessary replacement. (5) Increased burdens have been placed upon street railways by municipalities at the times of added construction.

"Although the wages paid by the companies are very much higher than those paid a few years ago, the management decided not to reduce the wages of its employees, and thereby, possibly, render poorer service; believing that the people, as a whole, prefer good service at a reasonable rate to poor service at a cheap rate.

"It has been impossible for the street railways to market their securities in the recent past because of their very poor and unsatisfactory financial showing. The credit of the companies has been stretched to the limit and their borrowing power is practically exhausted.

"The book value of the Newton & Boston Street Railway on November 1, 1907, was \$545,408, and the appraised value of the property (such appraisal having been made by G. M. Thompson, engineer, who has no connection with the company), as of December 24, 1907, is \$514,941. The total salaries paid the officers of the company per year are \$745.33. The president serves without salary, and the directors give their time without compensation.

"The book value of the Newton Street Railway on November 1, 1907, was \$2,031,971, and the appraisal value by Mr. Thompson as of December 24, 1907, was \$2,030,167. The total salaries of its officers per year are \$3,613. The president serves without salary, and the directors receive no compensation."

# Construction News

## FRANCHISES.

**Edmonds, Wash.**—The Seigfried syndicate has applied to the county commissioners for a franchise to build an electric railway in Edmonds and on to Bitter Lake.

**El Paso, Tex.**—Capt. Thomas A. Davis, president of the El Paso military institute, has applied for permission to build an electric railway from El Paso to the institute by way of Ft. Bliss.

**London, Ont.**—The Southwestern Traction Company has secured an extension of time in which to complete its line from London to Ingersoll, Ont. The North Midland Railway Company also secured an extension of two years.

**St. Louis, Mo.**—The extension of one year recently asked for by the St. Louis Electric Terminal Railway in which to complete the entrance into St. Louis for the Illinois Traction System, has been granted. (Noted March 7.)

## RECENT INCORPORATIONS.

**Chicago Inland Traction Company.**—Incorporated in Illinois to construct an electric railway from Crete to Kankakee, Ill., passing through Goodenow, Beecher, Sollett, Grant Park and Momence, following the Kankakee river from Momence to Kankakee, a distance of 32 miles. Right of way is being secured. It is stated that a portion of the road will be completed by next September. Capital stock, \$900,000. Incorporators: Dr. Edward Doepf, Blue Island; J. W. Rhodes, Elmer Schlesinger, Edwin D. Lawler, Chicago; H. C. Bangs, Glencoe, Ill.

**Chicago Ottumwa & Western Railway, Bussey, Ia.**—Incorporated in Iowa to build an interurban railway from Ottumwa to Des Moines, Ia. Capital stock, \$3,000,000.

**Ellwood City & Wurtemberg Electric Railway.**—Incorporated in Pennsylvania to build a 3-mile electric line in Lawrence county. Capital stock, \$18,000. Incorporators: J. T. Macklin, president, Frisco, Pa.; John M. Curry, S. R. Turner, J. N. Kirker, S. C. Van Gorder, H. G. French, J. H. Newton, Wurtemberg; J. Z. French, A. Tortier, Ellwood City, Pa.

## TRACK AND ROADWAY.

**Anderson & Athens Electric Railway.**—It is stated that the location survey for this proposed 73-mile electric line from Anderson, S. C., to Athens and Hartwell, Ga., has been started. De Camps & Cunningham, Anderson, S. C., have the contract for the work from Anderson to Hartwell, and the Richardson-Wey Engineering Company, Atlanta, Ga., has begun work from Cannon, Ga.

**Atlanta & Carolina Railway, Atlanta, Ga.**—A force of men is now at work at the Atlanta end of this proposed electric railway and another force will be put on at Augusta this week. Right of way is said to have been secured for the entire distance and it is believed that the line will be completed within a year. After entering Augusta it is planned to operate the cars of the company over the tracks of the Augusta Railway & Electric Company to the present terminal of the Augusta & Aiken line. (Noted March 14.)

**Benton Harbor-St. Joe Railway & Light Company, Benton Harbor, Mich.**—This company has agreed to pay one-third of the cost of a \$60,000 bridge over the St. Joe river, connecting St. Joe with Benton Harbor. The remainder of the cost will be shared equally by the cities.

**Canton, O.**—It is announced that the Massillon Wooster & Mansfield Traction Company and the Massillon & Northern Railway will be consolidated and their construction undertaken by a new company. From Massillon to Newman, O., six miles, both lines will use the same tracks. From Newman one branch will extend to Dalton and Mansfield, while the other will go to Turkeyfoot lake, where a summer resort will be established.

**Chambersburg Greencastle & Waynesboro Street Railway, Waynesboro, Pa.**—This company has awarded the contracts for the transmission line between Greencastle and Chambersburg and for the substation at Marion to the J. G. Schaff Electrical Company, Chambersburg, and the Westinghouse Electric & Manufacturing Company. J. MacWolff, general manager, Waynesboro. (Noted February 15.)

**Chicago City Railway.**—The Chicago board of supervising engineers has issued an order for the reconstruction work to be completed by the company this year under the provi-

sions of the franchise ordinance. The work includes the reconstruction of 43½ miles of track with 129-pound grooved rails at an expense of \$2,112,000 and conduit construction amounting to \$316,000. Besides several crosstown lines the Cottage Grove avenue line north of Thirty-ninth street and the State street line between Fifty-fifth and Twelfth streets will be rebuilt. The tracks on Michigan avenue forming a part of the loop at the northern terminus of the Wabash avenue line are to be removed and a new loop constructed using Garland court.—The city council has passed an ordinance authorizing this company to extend its Kedzie avenue line from Twelfth street to Twenty-second street and its Fullerton avenue line from Milwaukee avenue to Fortieth avenue.

**Cleveland Brooklyn & Elyria Railway, Cleveland, O.**—J. J. Breiting, vice-president, has announced that financial arrangements have been made for building the line between South Brooklyn and Orrville, O., this year and that next year the line will be extended to Zanesville, with a branch from Strongsville to Elyria. Right of way is said to have been obtained between Cleveland and Zanesville. The company expects to use the Westinghouse single-phase system. According to the plans the Cleveland Brooklyn & Elyria will be absorbed by a new company, the Cleveland Orrville Coshocton Zanesville & Elyria Railway, with W. E. Brooks of Elyria as president and J. J. Breiting of Cleveland as vice-president.

**Connecticut Company, New Haven, Conn.**—The Connecticut railroad commissioners have approved the proposed method of construction of the line from Woodbury to Waterbury, Conn. (Noted July 27, 1907.)

**El Reno Railway, El Reno, Okla.**—One mile of track has been laid in El Reno since January 1 of this year. Henry Schafer of El Reno is interested. Officers have not yet been elected.

**Evansville & Southern Indiana Traction Company, Princeton, Ind.**—It is stated that the 4-mile extension of this line under construction to Patoka, Ind., will be completed within the next six weeks. Charles M. Murdock, secretary of the company, is reported as announcing that the building of the proposed extension north to Vincennes has been abandoned for the coming year.

**Evansville (Ind.) Terminal Railway.**—It is expected that grading for the line between Evansville and Newburg, Ind., nine miles, will be started about May 1. Contracts for the bridge work have been let. The company is a subsidiary of the Evansville Railways Company, which has been operating between Evansville and Newburg over the tracks of the Evansville Suburban & Newburg Railway. (Noted March 14.)

**Idaho Oregon & Washington Electric Railway.**—It is announced that Frank McKean, representing this company, has placed orders for 1,000 tons of steel rails and 40,000 pounds of copper wire to be used in the construction of the first 10-mile section of its proposed electric line from Lewiston, Idaho, to Clarkston, Asotin and Pomeroy, Wash. The rail order was placed with the Colorado Fuel & Iron Company and the wire order with the American Steel & Wire Company for delivery in June. (Noted February 8.)

**Indianapolis & South Bend Traction Company, Indianapolis, Ind.**—E. Bowman, president, writes that the route for this proposed electric line has been surveyed from Logansport to Burlington, 20 miles. The remainder of the route from Burlington to Indianapolis, 51 miles, is under survey and practically all of the right of way has been secured. Plymouth, Rochester, Logansport, Burlington and Sheridan are on the route, with Indianapolis and South Bend as its termini. The headquarters of the company are at 730 State Life building, Indianapolis. J. Shafer is chief engineer. O. H. Mann, secretary, Sheridan, Ind. J. H. Keller, treasurer, Indianapolis. (Noted February 15.)

**Indianapolis Newcastle & Toledo Electric Railway, Indianapolis, Ind.**—It is reported that the creditors' committee has agreed to a plan whereby the receivers will issue \$400,000 of receivers' certificates to complete the road between Indianapolis and Newcastle. Thirty miles of track had been laid when work was stopped last fall. The Union Trust Company of Indianapolis is acting as receiver. (Noted November 30, 1907.)

**Jacksonville, Tex.**—H. L. Norton of Boston, Mass., who is promoting an interurban line from Jacksonville to Dial, Rusk and Tyler, Tex., has secured a franchise in Jacksonville.

**Janesville, Wis.**—H. H. Zeigler, Columbus, O., who is interested in a proposed interurban railway from Janesville to Madison, Wis., is reported as saying that construction work

will be started immediately. Joseph Ellis and W. L. Jamison of Cincinnati, O., are the engineers. When completed the road will afford direct trolley connection from Madison to Chicago.

**Kansas City & Southeastern Railroad, Kansas City, Mo.**—Surveys for this proposed electric line have been completed and the right of way secured. The line will be 30 miles long and will extend in a southeasterly direction from Kansas City, serving the towns of Leeds, Raytown, Lees Summit, Cockrell and Lone Jack, Mo. Gasoline-electric cars will be operated. Charles A. S. Sims, president; H. W. Gibson, vice-president; B. F. Shouse, treasurer; George P. Norton, general attorney; all of Kansas City, Mo.

**Kansas City, Mo.**—J. B. Quigley, chief engineer of a proposed electric railway from Ava, Douglas county, north to Cedar Gap, Mo., where a connection will be made with the St. Louis & San Francisco Railroad, advises that surveys for the entire distance of 15 miles have been completed and that grading will be started about April 15. The power house equipment will include a 300-kilowatt three-phase 60-cycle 6,600-volt alternator, direct connected to a water turbine, and two motor-generator sets. Contracts for rails, ties, steel, water power plant, auxiliary steam plant of 200-kilowatt capacity, grading, etc., will be let within the next 30 days. The headquarters of the company are at 309 Dwight building, Kansas City, Mo.

**Kentucky & Ohio River Interurban Railway, Paducah, Ky.**—It is reported that this company will build an electric railway from Paducah, Ky., to Cairo, Ill., and that the Royal Investment Company of Minneapolis has purchased \$1,000,000 of the company's bonds. (Noted June 29, 1907.)

**La Crosse (Wis.) City Railway.**—This company will replace a portion of its present special track work with inter-sections having Manard special hard steel centers, furnished by the Pennsylvania Steel Company. The entire track system will also be rebanded with Electric Service Supplies Company's "Protected" rail bonds. G. H. Shaw, superintendent.

**Lake Shore Electric Railway, Cleveland, O.**—It is announced that an extension will be built from the present terminus of the company's branch line at Gibsonburg to Helena, a small town in the oil district. F. W. Coen, general manager, Norwalk, O.

**Montgomery & Chester Electric Railway, Phoenixville, Pa.**—This company has completed a viaduct over the tracks of the Philadelphia & Reading Railway at Ironsides, Pa., thus completing the connection between Phoenixville and Spring City, which has been delayed for several years on account of the refusal of the steam road to let the electric line cross its tracks.

**Mt. Hood Railway & Power Company, Portland, Ore.**—This company, which proposes to build an electric railway from Portland to Mt. Hood, has begun proceedings to condemn a right of way across the Bull Run reserve, which is owned by the city of Portland. The city council recently refused to grant the company a franchise to cross the reserve.

**Pana Girard & Jacksonville Railway.**—At a recent meeting of the stockholders held at Springfield, Ill., the following officers were elected: C. E. Sargent, president; J. N. Anderson, vice-president; B. V. F. Darneille, secretary; J. J. Stowe, treasurer. The road will pass through Pana, Girard and Jacksonville, Ill., connecting with the lines of the Illinois Traction System at Pana. Work on securing franchises and right of way will be started at once. (Noted March 21.)

**Pittsburg Canonsburg & Washington Electric Railway, Pittsburg, Pa.**—Engineers have started surveys for the construction of this line from Washington to Pittsburg, Pa., 31 miles. A portion of the grading contracts have been let. The company is a subsidiary of the Pittsburg Railways. F. Uhlenhaut, president. (Noted February 29.)

**Prosser (Wash.) Traction Company.**—Preliminary surveys for this proposed electric railway from Prosser to points west and south in the Columbia river valley will be started at once from Prosser to Paterson, Wash. At Prosser the line will connect with the North Coast Railroad, which is building from North Yakima toward Prosser. Frederick Finn, president, Prosser, Wash. (Noted January 25.)

**Puget Sound Electric Railway, Tacoma, Wash.**—Work was started by this company on March 1 on the construction of an extension from Brookville to Puyallup, Wash., about seven miles. The contract for a 200-foot span bridge over the Puyallup river has been let to the American Bridge Company. W. S. Dimmock, manager, Tacoma. (Noted February 15.)

**Richmond & Winchester Interurban Railway, Richmond, Ind.**—M. M. Lacey, secretary, writes that this company proposes to build a 25-mile electric line from Richmond to Winchester, Ind., passing through Wayne and Randolph counties and serving Chester, Fountain City, Lynn, Snow Hill and Woods. Stock is being subscribed for purposes of incorporation, making surveys and obtaining right of way. It is planned to start construction some time during the summer.

**San Francisco Oakland & San Jose Railway, Oakland, Cal.**—Plans are being prepared for the extension from Oakland to San Jose, Cal., and it is stated that construction work will begin within two or three months. W. F. Kelly, general manager.

**Spokane & Inland Empire Railroad, Spokane, Wash.**—Work has been started on the grading of this company's extension from Palouse, Wash., to Moscow, Idaho, and it is expected that the roadbed will be ready for tracklaying by summer.

**West Chester & Wilmington Electric Railway.**—President Thomas E. O'Connell of Wilmington, Del., is reported as saying that actual construction work would be started on this proposed line at once. Right of way is being secured and it is expected to have cars running from Wilmington to Lombardy cemetery, three miles, by May 30. An extension will be built later to Brandywine Summit. It is stated that traffic arrangements may be made with the Wilmington City Railway Company, so that the cars may operate over the Concord pike instead of along a new road parallel with the pike. (Noted March 21.)

**Winnebago Traction Company, Oshkosh, Wis.**—It is reported that this company is contemplating an extension of the Oshkosh-Omro line to Berlin, Wis. E. Gunter, chief engineer.

**Winona Interurban Railway, Winona Lake, Ind.**—Grading has been resumed at Mentone and at a point just south of Warsaw, Ind., on the extension from Peru to Warsaw. Rails, ties and copper wire have been purchased and it is expected that the roadbed will be ready for tracklaying about the middle of May. It is intended to push the work and have the entire line completed in time to care for the heavy passenger traffic at the time of the Winona assembly late in the summer. S. C. Dickey, general manager, Winona Lake, Ind. (Noted February 8.)

#### POWER HOUSES AND SUBSTATIONS.

**Indianapolis Columbus & Southern Traction Company, Columbus, Ind.**—This company has contracted with the Allis-Chalmers Company for a 1,000-kilowatt revolving field engine type generator, 25-cycle, three-phase, 370-volt, to be installed in the power house at Edinburg.

**Mt. Hood Railway & Power Company, Portland, Ore.**—It is announced that this company soon will let contracts for hydraulic and electrical equipment. C. W. Miller, general manager, Portland, Ore.

**Northwestern Elevated Railroad, Chicago, Ill.**—Construction has been started on a new substation, located on Clark street, south of Calvary cemetery. Current from this station will feed the Evanston extension of the service over the tracks of the Chicago Milwaukee & St. Paul Railway, now being reconstructed.

**Nashville (Tenn.) Railway & Light Company.**—W. G. Cameron, chief engineer, writes that this company is now installing a 3,000-kilowatt Curtis turbine, which is the third turbine of this size in the power house. A forced draft ventilation system is also being installed, which will enable increasing the capacity of each turbine from 3,000 to 5,000 kilowatts.

**New York New Haven & Hartford Railroad, New Haven, Conn.**—It is reported that contracts will be let during the spring or early summer for the erection of a large power house at Milford, Conn., on the Housatonic river, similar to the plant at Cos Cob.

**Twin City Rapid Transit Company, Minneapolis, Minn.**—E. H. Schofield, engineer of power and equipment, writes that this company is now erecting a substation of a capacity to accommodate two rotary units of 1,500-kilowatt capacity each, one of which will be installed immediately. The external dimensions of the building are 47 feet 10 inches by 44 feet 5 inches by 30 feet high. The construction work of the building is being done by the John Wunder Company, general contractors, Minneapolis. The rotary and switchboard equipment is being furnished by the General Electric Company. The St. Anthony Falls Water Power Company is now equipping a new hydraulic power plant, which will furnish power for the Twin City Rapid Transit Company.

## Personal Mention

Mr. L. H. McCray, who recently resigned as superintendent of the Sterling Dixon & Eastern Electric Railway, Dixon, Ill., has been appointed trainmaster of the Atlantic Shore Line Railway at Sanford, Me., effective on March 31.

Effective on April 1 the offices of superintendent of telegraph and telephone and signal engineer of the Waterloo Cedar Falls & Northern Railway Company, Waterloo, Ia., will be abolished and the duties of these offices will be performed by the superintendent of overhead lines. Mr. A. I. Woodring, chief electrician, has been appointed to fill the new position and will have charge of all the overhead work, power transmission lines, battery station, rotary substation and telegraph and telephone work of the company.

Effective on April 1 the departments of employment and inspection of the Brooklyn Rapid Transit Company, which for a number of years have been combined under one head, will be separated. Mr. Frank Cooley, superintendent of the combined departments at present, will have charge of the inspection service of the system, reporting to Mr. J. F. Calderwood, vice-president and general manager. Mr. J. T. Crabbs will have charge of the employment department and will report to Mr. A. N. Dutton, superintendent of transportation.

Mr. W. S. Hubbard, whose appointment as division engineer of the Indiana Union Traction Company's lines, northern division, was announced in the Electric Railway Review of March 21, has been with the company since 1903, when he started in as rodmán on the engineers' corps. In 1904 he was made timekeeper on construction work and later foreman of the steam shovel construction forces. In 1906 he was promoted to be chief clerk of the roadway department, with headquarters at Anderson, and on March 1 of the present year was made division engineer of the northern division, with headquarters at Tipton, Ind. In his new position he has charge of roadway and buildings on the lines from Indianapolis to Logansport, from Kokomo to Peru, from Tipton to Alexandria, and on the city lines of Elwood, Ind., comprising in all 120 miles of interurban and 15 miles of city lines.

Mr. Adolph M. Barron has been appointed general manager of the Citizens' Electric Railway, Eureka Springs, Ark., effective on March 1. Mr. Barron was born on October 22, 1856, at Milwaukee, Wis., and after finishing a common school education took a course in telegraphy. From 1872 to 1878 he was employed on various railroads as telegraph operator, railroad agent, express agent and train dispatcher, and from 1879 to 1895 was identified with the construction and operating departments of various telegraph companies. He later went to Joplin, Mo., as superintendent of the Southwestern Water Power & Light Company, returning to Kansas City as superintendent of the Commercial Telegraph Company. His experience in the management of various light, power, water and gas plants has been considerable, covering the period from 1895 to 1900 and including properties at Elkhart and South Bend, Ind., and Chicago, Ill., at the latter city serving as consulting engineer for bond companies in Chicago, Cincinnati, New York and other eastern points. In 1904 he again went to Joplin, Mo., in charge of the Southwest Missouri Light Company and the Missouri Ice Company, these and other properties of that section being merged while under his management, and was one of the incorporators of the Consolidated Light Power Water & Ice Company, which furnished service to the cities of Joplin, Webb City and Cartersville, Mo., and Galena, Kan. He severed his connection with this company in 1906 to engage in the hotel business at Cartersville, Mo., where he remained until 1907, when he accepted the position of general manager of the Citizens' Electric Company at



Adolph M. Barron.

Eureka Springs, Ark., as earlier stated. Mr. Barron has been identified with the water, light and gas associations of the country, including the National Electric Light, the Western Gas, the American Waterworks, the Northwestern Electric Light and the Indiana Public Utilities associations, the last two of which he served as vice-president and secretary, respectively.

Mr. Albert L. Neereamer, who has been elected chairman of the Central Electric Traffic Association and secretary of the Central Electric Railway Association, will make his headquarters in Indianapolis. As mentioned in the Electric Railway Review of last week, Mr. Neereamer was secretary of the Columbus passenger committee, a traffic organization of steam roads, for eight years. From 1883 to 1903 he was connected with the accounting and traffic departments of various street railways. He was elected general agent at Columbus for the Columbus Delaware & Marion Railway in 1903, and served successively as general passenger agent, traffic manager and general superintendent of that company. Mr. Neereamer resigned from the latter office on January 15, 1908.



Albert L. Neereamer.

Mr. G. C. Pierce, for the past two years general superintendent of the East St. Louis & Suburban Railway properties at East St. Louis, Ill., has resigned on account of ill health and hereafter will devote his time to less exacting labors in the field of engineering operations. Mr. Pierce asked to be relieved in January, but at the solicitation of Vice-President L. C. Haynes remained until the return of President Clark from California, when a successor could be chosen. Mr. Pierce and his wife will start within a few days on a pleasure trip through the west. He will be succeeded at East St. Louis by Mr. C. F. Hewitt, general superintendent of the St. Joseph (Mo.) Railway Light Heat & Power Company. Mr. Hewitt has been identified with the operating department of the Clark properties, of which both of the above-named companies are a part, for several years, and has had wide experience in the practical operation of railway and lighting properties.

### OBITUARY.

Robert Hough, manager of parks for the United Railways & Electric Company, Baltimore, Md., died last week. He had been identified with the work since 1895, having received his appointment from the old Baltimore Traction Company. Mr. Hough served during the war as an officer of the Confederate army.

Charles A. Kenworthy, superintendent of the Electric Package Company of Cleveland, O., died recently. Mr. Kenworthy had had an extensive experience in the express business and when the Electric Package Company was formed in 1898 by the Cleveland interurban roads he was appointed auditor. In July of the following year he was appointed superintendent.

William Thomas Lewis, station master of the Indianapolis Traction Terminal station and formerly superintendent of the Indianapolis Street Railway, died recently. Mr. Lewis had been connected with the street railways of Indianapolis for 33 years, starting as a driver. At the time of his funeral all city and interurban cars in the city were stopped for three minutes as a mark of respect.

William A. Kreidler, founder and principal owner of the Western Electrician of Chicago, died of apoplexy in Augusta, Ga., on March 26. He was born in South Dansville, N. Y., on August 20, 1858, and attended the University of Rochester. Before graduation he removed to Chicago and entered the employment of the Western Electric Company. In 1887 he established the Western Electrician, and since then has devoted his entire attention to the direction of that paper. He also was one of the organizers of the old Chicago Electric Club and was its secretary for several years. He was a member of the American Institute of Electrical Engineers, of the National Geographic Society and the Chicago Academy of Sciences.

# Financial News

**Chicago & Milwaukee Electric Railroad.**—On petition of the receivers Judge Grosscup of the United States circuit court has granted authority for the issue of \$1,000,000 of receivers' certificates. The petition for leave to issue these certificates, drawn by Howard M. Carter, counsel for the receivers, states that it is desired to create a through line from a point in Milwaukee to a point in Chicago. If the construction of the Milwaukee end of this line can be completed the Chicago & Milwaukee road will connect with the Northwestern Elevated Railroad at Evanston, so that by transfer at that point passengers can make the through trip with but one change from Milwaukee to Chicago. Bion J. Arnold checked the estimates for the expense of completion of the road, which it is expected will be \$896,150. Among the expenses are the following: Grading right of way, \$97,500; rails and track-laying, including work in Milwaukee and on viaduct in Milwaukee, \$84,650; trestle work, culverts and crossings, \$12,400; ballasting, \$17,300; interlocking plant, \$15,100; overhead construction, \$68,650; passenger platforms and shelters, \$7,000; 10 passenger coaches complete for service, \$122,200; substitution near Milwaukee, including equipment and power line, \$155,500; real estate in Milwaukee necessary for terminal purposes, \$43,500; balance of purchase price of right of way, \$45,900. The petition adds that the committee representing the holders of bonds of the Chicago & Milwaukee Electric Railroad of Wisconsin has secured deposits of more than \$5,000,000 of the bonds under an agreement which contains specific authority to the committee to consent to the issue of not exceeding \$1,000,000 certificates for the completion of the road in Wisconsin. The certificates are to be a first lien upon the property.

**Chicago Railways Company.**—Stockholders have authorized an increase in the board of directors from seven to nine.

**Delaware & Atlantic City Railroad.**—Vice-Chancellor Leaming has appointed William S. Casselman of the West Jersey Title & Guaranty Company of Camden, N. J., receiver. The only asset is said to be \$104,000 deposited with the secretary of state of New Jersey as a guarantee that the company would construct a railroad between Camden and Atlantic City.

**Detroit United Railway.**—J. C. Hutchins, the president, has made the following statement regarding the earnings for February and for the two months ended February 29, 1908: "It is proper to state that our decreased net results for the month of February are not due entirely to the prevailing business depression, but in part are due to climatic conditions. The weather encountered in that month was much the most severe we have experienced in several years, resulting in marked interference with the traffic and in largely increased operating expenses."—F. W. Brooks, the general manager, and A. J. Ferguson have been elected directors.

**Interborough Rapid Transit Company, New York.**—Shareholders have approved the execution of a mortgage to secure the proposed issue of \$55,000,000 bonds.

**Interstate Railways Company, Philadelphia, Pa.**—The report for the fiscal year ended January 31, 1908, shows the following: Income from investments and loans, \$514,165; in-

terest on collateral trust bonds, \$431,064; expenses and tolls, \$20,419; net surplus, \$62,682; previous surplus, \$106,464; profit and loss surplus on January 31, 1908, \$169,146.

**New York-Philadelphia Company, Philadelphia.**—The following protective committee of bondholders has been formed: A. Merritt Taylor of Philadelphia, chairman; A. B. Farquhar, York, Pa.; E. C. Miller, Clarence L. Harper and Howard M. Van Court of Philadelphia. This committee will co-operate with holders of underlying bonds and with the committee representing holders of the first mortgage bonds of the subsidiary Camden & Trenton Railway. The receiver of the latter road has filed a statement with the United States court, which shows the following: Total assets, \$791,701, including with other items: Rights of way and franchises, \$425,000; tracks, bridges and overhead equipment, \$279,883; rolling stock, \$2,650. Total liabilities (exclusive of capital stock), \$1,729,646, the principal items being: First mortgage 5 per cent bonds, \$710,000; general mortgage 5 per cent bonds, \$622,500; bills payable, \$231,415, and accrued interest thereon, \$21,000; car trust certificates, \$29,000; bond interest accrued, \$48,296.

**Pacific Electric Railway, Los Angeles, Cal.**—It is reported in Los Angeles that E. H. Harriman has purchased from H. E. Huntington the control of this company and the Los Angeles Railway, the Los Angeles-Pacific Company, the Los Angeles Inter-Urban Railway and the Los Angeles & Redondo Railway. Mr. Huntington is quoted in New York as having said in relation to the rumor that there has been no change in the balance of interests between himself and Mr. Harriman.

**Toledo & Indiana Railway, Toledo, O.**—On the application of S. C. Schenck and J. M. Longnecker, president and director, respectively, Judge Brough of the common pleas court appointed C. F. M. Niles receiver for this company at Toledo on March 30. Mr. Niles is president of the Security Savings Bank & Trust Company of Toledo, which is trustee under the deed securing the first mortgage bonds of the railway. The Toledo & Indiana road did not meet the interest due on its bonds on January 1. Messrs. Schenck and Longnecker filed the petition as judgment creditors. The petition declares that the company is wholly insolvent, having defaulted upon interest aggregating more than \$60,000. Business depression is said to be largely responsible for the default. The company consented to the appointment of a receiver.

**Union Railway, New York.**—Frederick W. Whitridge, receiver for the Third Avenue Railroad, was appointed receiver for this company by Judge Lacombe of the United States circuit court on April 1. The entire capital stock of the Union Railway is owned by the Third avenue road. The appointment was made on a petition filed by the Pennsylvania Steel Company, to which there is due by the Union Railway \$28,323.

### Dividends Declared.

Aurora Elgin & Chicago Railroad, common, quarterly, three-fourths of 1 per cent; preferred, quarterly, 1½ per cent.

Columbus Newark & Zanesville Electric Railway, Newark, O., preferred, quarterly, 1½ per cent.

Forest City Railway, Cleveland, quarterly, 1½ per cent.

Johnstown (Pa.) Passenger Railway, quarterly, three-fourths of 1 per cent.

Public Service Corporation of New Jersey, Newark, N. J., quarterly, 1 per cent.

### ELECTRIC RAILWAY EARNINGS.

	Gross earnings.	Operating expenses.	Net earnings.	Interest charges.	Surplus.
Brockton & Plymouth St. Ry., Plymouth, Mass., January, 1908.	\$ 6,586.73	\$ 7,802.34	*\$ 1,215.61	\$ 1,873.32	*\$ 3,088.93
Columbus (Ga.) Electric Company, January, 1908.	30,432.47	15,268.03	15,164.44	10,503.54	4,660.90
El Paso (Tex.) Electric Company, January, 1908.	46,801.92	33,188.63	13,613.29	5,900.48	7,712.81
Northern Texas Electric Co., Ft. Worth, Tex., January, 1908.	74,201.81	45,855.24	28,346.57	11,572.75	16,773.82
Whatcom County Ry. & Lt. Co., Bellingham, Wash., Jan., 1908.	32,537.76	18,361.30	14,176.46	6,797.82	7,378.64
Pensacola (Fla.) Electric Company, January, 1908.	18,155.89	12,756.35	5,399.54	3,618.54	1,781.00
Tampa (Fla.) Electric Company, January, 1908.	45,293.52	30,974.24	14,319.28	975.75	13,343.53
Jacksonville (Fla.) Electric Company, January, 1908.	32,859.92	23,384.48	9,475.44	5,426.92	4,048.52
Savannah (Ga.) Electric Company, January, 1908.	46,321.35	40,566.31	5,755.04	12,568.34	*6,183.30
Seattle (Wash.) Electric Company, January, 1908.	364,202.97	259,328.51	104,874.46	55,009.55	49,864.91
Houghton County Street Ry., Houghton, Mich., January, 1908.	18,677.51	13,477.80	5,199.71	3,980.91	1,218.80
Galveston-Houston Electric Co., Houston, Tex., January, 1908.	80,615.68	55,084.33	25,531.35	13,886.19	11,645.16
Puget Sound Electric Railway, Tacoma, Wash., January, 1908.	122,978.49	90,235.46	32,743.03	32,476.98	266.05
Dallas (Tex.) Electric Corporation, January, 1908.	89,616.31	68,542.46	21,073.85	20,321.67	752.18
Northern Ohio Traction & Light Co., Akron, O., February, 1908.	149,301.43	78,466.19	40,825.24	42,405.42	*1,570.18
Detroit (Mich.) United Railway, February, 1908.	465,526.00	332,044.00	133,480.00	135,122.00	*2,671.00
Aurora Elgin & Chicago Railroad, February, 1908.	85,552.12	54,825.18	30,726.94	28,605.22	2,121.72
Twin City Rapid Transit Co., Minneapolis, February, 1908.	453,944.37	253,643.58	200,300.79	122,788.92	77,511.87
Toledo (O.) Railways & Light Company, February, 1908.	207,878.39	116,301.94	91,576.45	68,449.11	*23,947.70

\*Deficit. †Other income amounted to \$4,313. ‡Other income amounted to \$820.36.

# Manufactures and Supplies

## ROLLING STOCK.

**San Francisco Oakland & San Jose Railway**, Oakland, Cal., is reported to have 10 interurban cars under construction at its Emeryville shops.

**Louisville & Southern Indiana Traction Company**, New Albany, Ind., has placed an order with the American Car & Foundry Company for four double-truck cars to be used as trailers.

**Forest City Railway**, Cleveland, O., is preparing specifications for 100 pay-as-you-enter type cars and is remodeling 50 cars in its own shops, so that the pay-as-you-enter system of fare collection may be used.

**Columbus Urbana & Western Electric Railway**, Columbus, O., which was reported in the Electric Railway Review for March 28 to be asking prices on one interurban car, has placed the order with the McGuire-Cummings Manufacturing Company.

## TRADE NOTES.

**T. H. Symington Company**, Baltimore, has contracted to equip with Baltimore ball bearing center plates 700 cars of the Philadelphia Rapid Transit Company.

**American Locomotive Company** has declared the regular quarterly dividends of 1¼ per cent on the preferred stock, payable April 21, and 1¼ per cent on the common stock, payable April 22.

**Zelnicker Crayon Works**, St. Louis, Mo., reports a large business with its Sreemark crayon. This is a cheap crayon designed for general use and to mark on anything, and is carried by leading jobbers and dealers.

**P. O. Adams Rail & Safety Appliance Company**, Cameron, Tex., has been incorporated with \$100,000 capital stock to manufacture safety rail joints, brake appliances and railroad crossings. The incorporators are: P. O. Adams, W. H. Triggs, Dr. J. C. Reese and others.

**Thomas Madill**, of the railway department of the Sherwin-Williams Company, has just returned to his office in the Railway Exchange, Chicago, after an absence of four months spent in Florida and Cuba. He has entirely recovered from a severe illness, which necessitated the vacation.

**Canadian Westinghouse Company, Limited**, Hamilton, Ont., at a meeting of shareholders held on March 31 submitted its report for the year ended December 31, 1907. The net profit for the year was \$427,953, an increase of 23 per cent over 1906. All of the officers were re-elected.

**Electric Storage Battery Company**, Philadelphia, at its annual meeting held at Camden, N. J., elected Alexander C. Humphries, Francis E. Bond and D. Windsor as directors to succeed H. P. Whitney, H. H. Vreeland and Thomas Dolan, resigned. The other retiring directors were re-elected.

**Westinghouse Machine Company**, Pittsburg, Pa., at a recent meeting of stockholders increased the membership of its board of directors from five to nine. Application for the discharge of the receivers has been granted by Judge James S. Young of the United States circuit court, and beginning April 1 the company continued business under the direction of the new board.

**American Supply & Machinery Manufacturers' Association**, 309 Broadway, New York, advises that at the convention to be held at Richmond, Va., from May 13 to 15, the Hon. William H. Taft will address a joint open meeting of that association, the National Supply & Manufacturer Dealers' Association and the Southern Supply & Manufacturer Dealers' Association on the afternoon of May 13.

**J. G. Ellendt Company**, engineer, 1 Madison avenue, New York, is sending out a folder descriptive of its Elasto sanitary flooring, which is a composition of cement and is claimed by the company to be admirably adaptable for flooring because of its silent, non-slippery and agreeable contact under foot, also its extreme durability. This company makes a specialty of the design and superintendence of reinforced concrete construction. Reinforcing materials are supplied.

**B. E. Sunny** has resigned as vice-president and western manager of the General Electric Company, with headquarters in Chicago, and has been elected a vice-president of the American Telephone & Telegraph Company, New York. He will still be connected with the affairs of the General Electric

Company, although not actively, for an indefinite period, and probably will continue to reside in Chicago. Mr. Sunny is succeeded as manager of the Chicago office by James W. Johnson, who has been assistant manager for several years.

**Allis-Chalmers Company**, Milwaukee, Wis., has received an order from the Winnebago Traction Company, Oshkosh, Wis., for the car equipments for its new rolling stock, the purchase of which was noted in the Electric Railway Review for March 7. The equipments comprise the Allis-Chalmers type R 50 railway motors with double-end control, and the usual auxiliaries, including circuit-breakers, lightning arresters, trolleys, car lighting and power wiring. The motors are each capable of developing a normal output of 55 horsepower under pressure of 500 volts at the motor terminals.

**American Car & Foundry Company's** report for the quarter ended January 31, 1908, shows the following:

		Increase.
Net earnings .....	\$ 1,772,201	*\$ 536,081
Preferred dividend, 1% per cent .....	525,000	Unchanged
Balance for common .....	1,247,201	*535,081
Common dividend .....	300,000	150,000
Surplus .....	947,201	*685,081
Previous surplus .....	23,271,251	6,921,120
Total surplus .....	24,218,452	6,236,039

\*Decrease.

## ADVERTISING LITERATURE.

(Mention of the Electric Railway Review will assure prompt attention to requests for publications listed here.)

**Arthur S. Partridge**, 421 Olive Street, St. Louis, Mo.—April offerings in second-hand electric railway material and equipment are attractively shown in an illustrated 6-page leaflet.

**Joseph Dixon Crucible Company**, Jersey City, N. J.—The April issue of "Graphite" contains the usual amount of interesting matter, including an article entitled "Dixon's Crayons for Railroad Work."

**Allis-Chalmers Company**, Milwaukee, Wis.—Bulletin No. 4010 shows the 51 standard wiring symbols for use in all wiring specifications as adopted by the National Electrical Contractors' Association.

**Walter A. Zelnicker Supply Company**, St. Louis, Mo.—Rail and equipment bargains for April are listed in the usual comprehensive form.—A circular describes the Zelnicker adjustable car door roller.

**Standard Varnish Works**, 29 Broadway, New York, N. Y.—A new catalogue of 48 pages and cover, entitled "Architectural Finishes and Stains," is addressed especially to architects. All who have to do with railway architecture will find it valuable for reference, as the information shown is accurate and reliable, presented in concise and simplified form.

**H. W. Johns-Manville Company**, 100 William Street, New York, N. Y.—An illustrated booklet, entitled "Asbestos Wood," sets forth the advantages of this material as a fireproof substitute for wood, slate, marble and fiber in building construction and electrical insulation. The text is quite interesting, particularly to those who have not kept posted on fireproofing progress.

**Under-Feed Stoker Company of America**, Marquette Building, Chicago, Ill.—A recent bulletin contains much interesting matter pertaining to installations of the Jones stoker. Among the articles is one descriptive of a recent installation in the general office building of the Buffalo Rochester & Pittsburg at Rochester, N. Y. Several appropriate half-tone views are used in connection with this article.

**Vote-Berger Company**, La Crosse, Wis.—A large illustrated folder of unique design demonstrates the advantage of the "D. & T." pole anchor in an interesting manner. The name is derived from the method of installation, the anchor being first driven into the earth with a sledge, then twisted with a crowbar three turns to the right. This sets the anchor solidly in undisturbed earth, the entire operation requiring the work of one man for one minute only without special tools.

**Cleveland Crane & Car Company**, Wickliffe, O.—A recently issued catalogue of Cleveland electric traveling cranes is a handsome and comprehensive book of 46 pages and cover, 9½ by 12½ inches. It has an attractively embossed cover and is bound with heavy black silk cord. The contents include concise descriptions of the details of construction, together with numerous illustrations of unusual excellence. Many of the latter are prints on heavy enameled stock tipped on the pages. Two pages are utilized to show a partial list of customers.

## NATIONAL TYPE "3VS" AIR COMPRESSORS.

The extensive adoption of compressed air as a medium for performing various industrial operations has brought with it a demand for air compressing apparatus that is simple and durable in design and construction, efficient and reliable in operation and of as low cost as is consistent with good workmanship and materials.

The necessity for economical production and the almost general adoption of electricity as a motive power and its flexibility of transmission render electrically operated compressors preferable to other types.

In the development and placing upon the market of the National "3VS" type of compressors, the aim was to produce a machine the utility of which would be unlimited and which could be depended upon even under most unfavorable condi-

tion cylinder head jackets as soon as the compressors are shut down and in a like manner admit the water when the operation of the machines is resumed. These governors are very simple and reliable in operation.

The "3VS" type of compressor has been developed and is built by the National Brake & Electric Company in capacities of 50, 100, 150 and 225 cubic feet of free air per minute.

## EFFECTIVE TOOL GRINDING.

To efficiently grind steel tools by means of rapid cutting wheels it is absolutely necessary that the contact between the two should be a line and not a surface. Hence, if it is desired to grind a plane face of a tool, the wheel must have a cylindrical or conical surface, past which the surface to be ground must be moved in a plane. A plane face of the wheel cannot be used for this purpose, because it and the surface being ground would soon coincide, with the results of no cutting and much heating.

The tool should be clamped in the holder against its base or the surface upon which it rests when in use in order to avoid any errors due to want of parallelism of its sides and to enable it to be reground with the minimum loss. All of its plane faces should be ground without altering its position in the holder, to insure accuracy of the angles and uniformity in results. This requirement is particularly important in thread tools.

The tool holder should be capable of presenting the tool to the wheel in such manner that any face can be so ground as to have a definite, predetermined relation to the other faces and to the shank, and the adjustments necessary to accomplish this must be easily understood and quickly manipulated. It must be so mounted as to enable the tool face to be easily and quickly reciprocated past the line of cut of the wheel, and to be reliably fed against it and brought to any part of it. The cuts should be light, quick and frequent to produce the best results in the shortest time.

Experiments have demonstrated that for roughing cuts a curved cutting edge is more efficient than a straight one, and

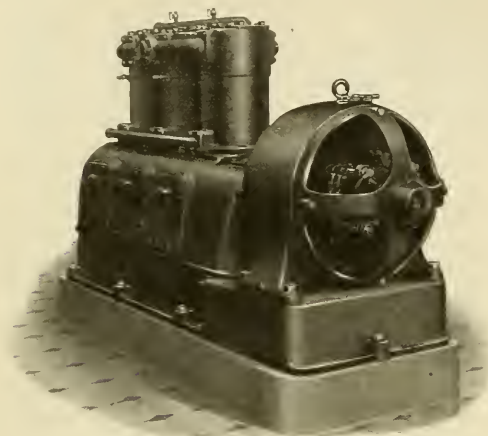

Motor-Driven 3-Cylinder Air Compressor.

tions, to operate economically and efficiently, and as far as possible to be free from breakdown with its attendant expensive repairs.

The "3VS" compressors have been very carefully designed so as to form most compact, self-contained units, both durable and efficient, and very economical in operation. They are a single-stage type of compressor with three vertical cylinders. Placing the cylinders on the vertical plane enables the machines to be built within smaller dimensions than the horizontal type and also eliminates all strain and wear on the pistons and cylinder surfaces. All working parts are entirely inclosed, affording protection from mechanical injury.

The units are designed for continuous service at 90 pounds pressure, but can be furnished for pressures up to 150 pounds at a slightly reduced capacity rating. Driving power is transmitted from the motor to the compressor by means of a herring-bone gear and pinion. Each compressor unit is provided with trunk pistons, the workmanship of which is carefully executed so that they fit the bore of the cylinders properly. Each piston has a self-adjusting metal packing ring, thus dispensing with the use of stuffing boxes. The sections of the rings are very carefully assembled by hand and the completed rings are carefully ground on special machines. The pistons are operated by connecting rods, which are in turn mounted on and operated by the crankshaft. Water jackets inclose the cylinders and serve to keep their temperature at a minimum.

Motors for operation on direct-current or on alternating-current circuits are furnished with and as a part of these compressors. The direct-current motors are of the company's standard "C. S." type, which is particularly adapted to the peculiar characteristics of air compressor loads. These motors are of the 4-pole type and are heavily compounded, so that in case of necessity they may be started by throwing the full line voltage directly across the armature without damage or injury. For starting service armature starters, which consist of an air governor and an automatic rheostat, are furnished. These starters automatically control the operation of the compressors, keeping the air pressure within predetermined limits. Water governors can be furnished to automatically cut off the circulation of water in the cylinder and

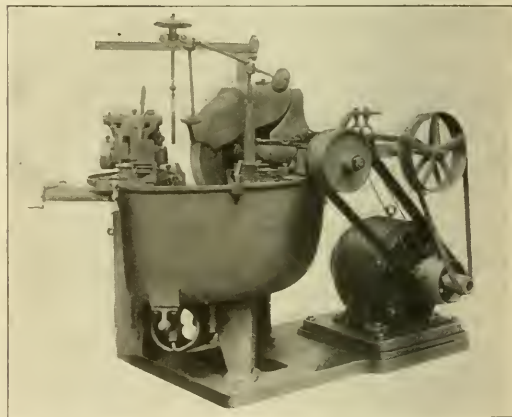

Universal Tool Grinder Belt Driven by an Allis-Chalmers Motor.

that different materials and different depths of cut require different degrees of curvature; also that the cut should be a draw cut and not a gouging cut, so that the bulk of the metal would be removed ahead of the point of the tool. This adds greatly to its life, the point being the most delicate part.

Universal tool grinding machines, manufactured by William Sellers & Co. of Philadelphia, Pa., such as the one illustrated herewith, which is belted to an Allis-Chalmers type "K" motor, have been designed to meet the above requirements. Heat generated by the grinding is carried off by means of a large volume of water at low velocity, which is forced to the tool by a rotary pump through a system of jointed pipes, ending in an adjustable nozzle. The use of such a large quantity of water demands that all working parts should be protected from it on account of the grit carried along with it. This has been effectually done. In fact, every point about these machines has been carefully studied and thoroughly tried.



# The Boilers Will be Out of Service a Much Shorter Time for Washing

thereby requiring very much less labor, to say nothing of the saving in fuel and the increased efficiency of the boilers, if the incrusting solids and other deleterious salts in the water are acted upon by **Dearborn Compounds** and their injurious properties destroyed. Send us gallon sample of your feed water for analysis.

## Dearborn Drug & Chemical Works

ROBT. F. CARR, PRESIDENT

299 BROADWAY, NEW YORK      POSTAL TELEGRAPH BLDG., CHICAGO

# The Moore Track Drill

does not interfere with traffic!

The shifting of one lever and a few seconds' time takes down the drill—the operation reversed makes it ready for work again.

This is only one of the many strong points about the Moore Track Drill that make it worth buying.

Ask for descriptive catalogue.

**Kalamazoo Railway Supply Co.** Kalamazoo Michigan

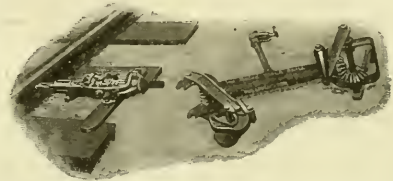
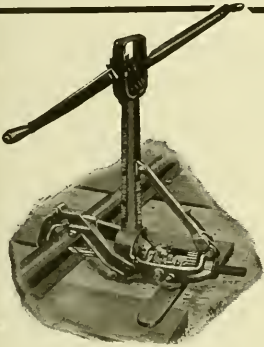

# Washburn "M" Type Traction Coupler

Strongest, Simplest and Cheapest Traction Coupler Ever Made

Illustration shows two "M" Type couplers on a forty-five degree curve and coupled with a short cast link as used on cars having a short wheel base. For longer cars a longer link casting is furnished, giving any amount of distance between cars, and affording the desired clearance when traveling curves.

Ask for new catalogue of traction devices.

Washburn Steel Castings & Coupler Co. MINNEAPOLIS, MINN.

Western Agents: Tweedy, Hood & Finlen, 204 Fisher Bldg., Chicago

Canadian Agent: John Taylor, Montreal

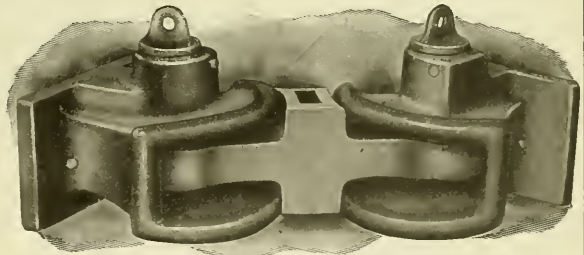

# Special Work for Street Railways

Switches  
Mates  
Frogs



and Crossings  
with Hard  
Steel Centers

Cast Weld Compromise Rail

Barbour - Stockwell Co., 205 Broadway, Cambridgeport, Mass.

## THE J. G. BRILL COMPANY, PHILADELPHIA, PA.

AMERICAN CAR COMPANY, ST. LOUIS, MO.  
 G. C. KUHLMAN CAR COMPANY, CLEVELAND, OHIO  
 JOHN STEPHENSON COMPANY, ELIZABETH, N. J.  
 WASON MANUFACTURING CO. SPRINGFIELD, MASS.

MAIN OFFICE: PHILADELPHIA, PA.  
 LONDON OFFICE: 110 CANNON ST. E. C.  
 PACIFIC COAST AGENTS: PIERSON  
 ROEDING & CO., SAN FRANCISCO.  
 AUSTRALIAN AGENTS: NOYES  
 BROTHERS, SYDNEY. CABLES:  
 "BRILL," PHILA., "AXLES" LONDON.

*CARS TRUCKS SEATS RATTAN SPRINGS SPECIALTIES SUPPLIES*

## SAFE SUMMER SERVICE

The "Narragansett" is the right car for handling crowds safely in excursion service and is the only practical double-truck open car. The width over all is the same as a single-step open car as the upper step is on the flange of a Z-bar sill and within the line of the posts. The best possible arrangement of the running board of a single step car with the minimum height of floor is 19½ inches to board and 17 inches to floor. The same height in the "Narragansett" is divided into 16, 13 and 7½ inches. Companies which have used "Narragansett" cars for a number of years have recently reported that they have had no accidents. Women, children and elderly persons can get in and out easily and quickly. The Z-bar sills make it the strongest open car ever built. The arrangement does not reduce the length of the seats. Write for catalog.

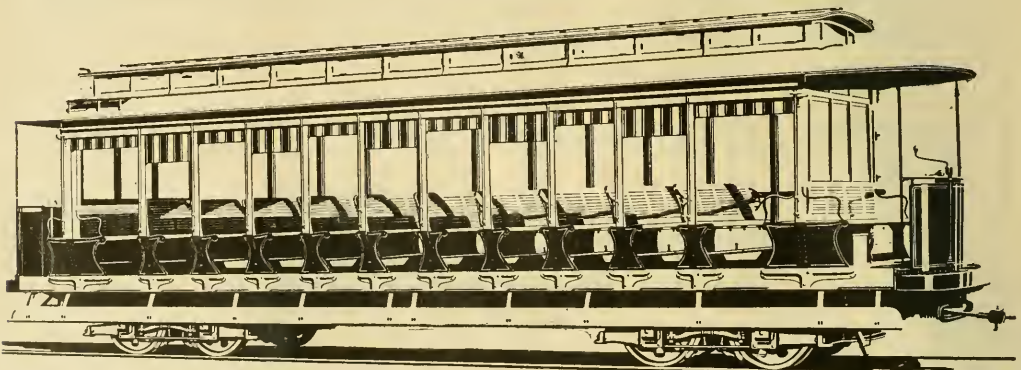

*THE BRILL "NARRAGANSETT" CAR (PATENTED)*

# General Electric Company



## Fuse Boxes

Type MA-13



For Railway Car Equipments

Suitable for requirements  
up to 200 horse-power total.

Magnetic Blowout

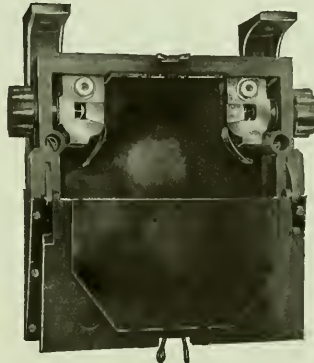

MA-13 Fuse Box, showing fuse bent  
back by action of magnetic blowout.

**Construction:** Sides, top and back of box constructed of one piece of moulded compound. Not affected by heat.

**Operation:** Arc definitely localized. Complete and inconspicuous rupture.

**Fuse Replacement:** Fuses quickly and easily replaced. Good contact secured by wedge clamp terminal.

This fuse box accommodates copper ribbon fuses of the following capacities:

125 Ampere  
150 Ampere  
175 Ampere  
200 Ampere  
250 Ampere  
300 Ampere

CAT. No.

42504  
38633  
38663  
29428  
29429  
38664

1637

Principal Office:

Chicago Office:  
Monadnock Bldg.

Schenectady, N. Y.

Sales Offices in  
All Large Cities

# Stuart-Howland Co.

Everything Electrical  
BOSTON

## FOR EVERY KIND OF MEASURING

there's a reliable and absolutely accurate steel tape made by

**THE LUFKIN RULE Co.**

SAGINAW, MICH., U. S. A.

New York  
London, England  
Windsor, Canada



3



## E. C. Van Valkenburgh

Promotional Advertising  
for Electric Railways

2117 West 102d Street : Chicago

*A well-laid plan and Van Valkenburgh Advertising Service will make your advertising successful.*

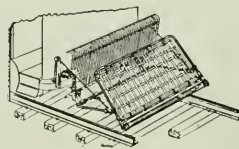

## ECLIPSE Life Guard

Manufactured by the  
**ECLIPSE RAILWAY SUPPLY CO.**  
Cleveland, Ohio

## Mica Prices Reduced

*Compare our prices on Raw Mica and Manufactured Mica with prices you have been paying our competitors.*

**WHY PAY FANCY PRICES?**

**CHICAGO MICA CO.**

VALPARAISO : : : INDIANA

## STEEL WOOL JOURNAL PACKING

really is superior to and far more economical than all other kinds of packing. A comparative test under hard service will prove this to your complete satisfaction.

*We will gladly furnish a liberal sample*

**WM. ROBERTSON & COMPANY**

General Office: Great Northern Bldg., CHICAGO  
Factory: 75 S. Jefferson St., BATTLE CREEK, MICH.

11

# Satisfaction Always Follows BONDING or REBONDING

when done by the modern and economical methods—

## Electric Brazing and Copper Welding

Their superiority can be easily demonstrated on your own road if you give us the opportunity.

Names of users cheerfully furnished.  
Ask them whether they are satisfied.

**THE ELECTRIC RAILWAY  
IMPROVEMENT COMPANY**

6005 Carnegie Avenue

CLEVELAND, OHIO

13

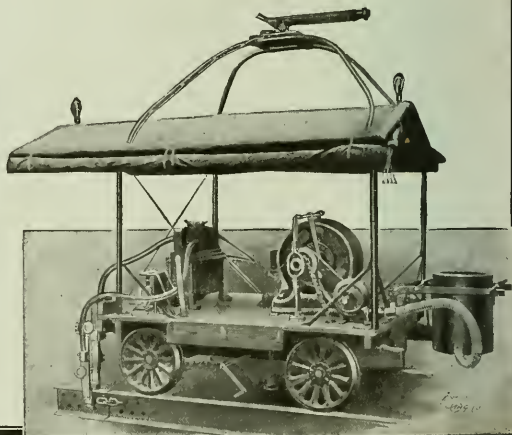

# Electric Railway Review

PUBLISHED EVERY SATURDAY.

FORMERLY THE STREET RAILWAY REVIEW.

THE WILSON COMPANY, CHICAGO.

160 Harrison Street, Chicago  
150 Nassau Street, New York  
1529 Williamson Bldg., Cleveland

Vol. XIX  
No. 15

CHICAGO, APRIL 11, 1908

Whole No. 250      Subscription: Domestic . . . \$2  
Foreign . . . \$5  
Canada . . . \$3.50

## A Practical Book

*For Every Man*

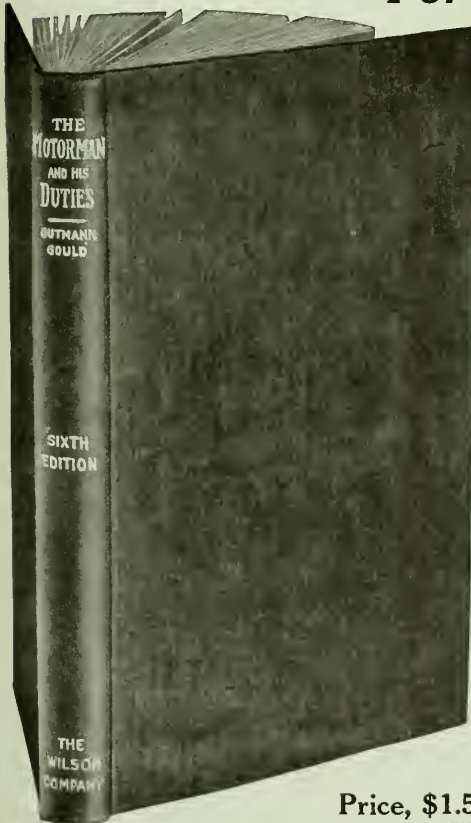

whose services will be made more valuable to himself and to his employer by acquiring intimate knowledge of the principles governing the operation of electric railway cars.

*Buy, read and study this book!* A practical application of the knowledge imparted will result in better, safer and more economical operation.

*“The Motorman and His Duties”* explains in simple language, free from mathematics and technicalities, many points not generally comprehended. It outlines clearly the relation existing between the track, overhead, power station and the car itself.

No other book completely covers the subject in a manner so easily understood!

*“The Motorman and His Duties,”* in the eleven chapters of its recently published sixth edition, comprises 198 pages, 5 by 7 inches, attractively bound in green cloth. It is illustrated by 138 halftones and zinc etchings. It includes a subject index, a glossary and three large inserts of car wiring diagrams.

**Price, \$1.50 per Copy, Prepaid**

Send your address on a postal for a 16-page pamphlet of sample pages, etc.

**The Wilson Company**      160 Harrison Street  
CHICAGO, U. S. A.

# National Air Compressors

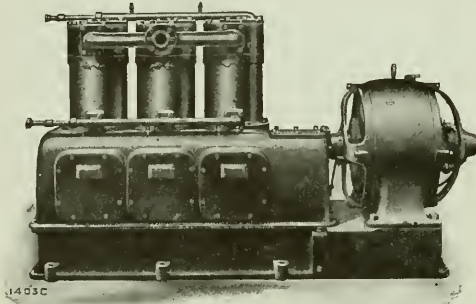

100 cu. ft. Type "3VS" Air Compressor.

These Compressors are especially adapted for service in car shops and barns, where compressed air is used, for various industrial operations, as well as for blowing dust and other accumulations out of car motors, controllers and seats.

Either direct or alternating current motors can be furnished for operating same.

Automatic starters which start and stop the Compressors and keep the air supply within the desired range of pressures are furnished with each Compressor.

Type "3VS" Compressors are built in capacities of 50, 100, 150 and 225 cu. ft. of free air per minute.

Write for Bulletin 84-F

## National Brake & Electric Company

MILWAUKEE, WIS., U. S. A.

NEW YORK: 111 Broadway  
SAN FRANCISCO, CAL.: W. F. McKenny, 69-71 First St.

PHILADELPHIA: W. H. Goble, 1722 Westmoreland St.  
BOSTON: F. E. Huntress, 131 State St.

LONDON: 14 Great Smith St., Westminster

General Sales Office: 519 First National Bank Building, Chicago

## The SIGNAL SYSTEM

that prevents accidents, facilitates traffic and promotes adherence to schedules

is made by the

Telegraph Signal Co.  
82 State St., Rochester, N. Y.

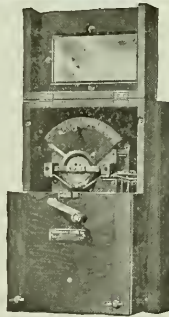

## WESTON Electrical Instrument Co.

Main Office and Works:  
WAVERLY PARK, NEWARK, N. J.

Illuminated  
Dial Station  
Instruments

SEND FOR NEW CATALOGUE



Berlin—European Weston Electrical Instrument Co., Ritterstrasse, No. 88  
Paris, France—E. H. Cadot, 12 Rue St. Georges  
London—Audrey House, Ely Place, Holborn  
New York Office—74 Cortlandt St.  
Weston Standard Illuminated Dial Station Voltmeter Model 11

## Mica Prices Reduced

Compare our prices on Raw Mica and Manufactured Mica with prices you have been paying our competitors.

WHY PAY FANCY PRICES?

CHICAGO MICA CO.

VALPARAISO : : : INDIANA

## Queen Testing Sets

"The Recognized Standard"

Voltmeters  
Ammeters  
Switchboard and Portable  
Alternating and Direct Current



Queen Acme Testing Set

U. S. Standard Testing Sets  
Rail Bond Testers  
Galvanometers, etc., etc.  
Electrical Instruments for All Purposes

QUEEN & CO., Inc., Philadelphia, Pa.

# Westinghouse

## Single-Acting Gas Engines

### Lubrication

A cast-iron housing encloses all main working parts of the engines, except pistons and valves. This housing contains a bath of oil into which cranks and connecting rods dip, splashing it over journals and cylinder walls, thus automatically providing all internal lubrication.

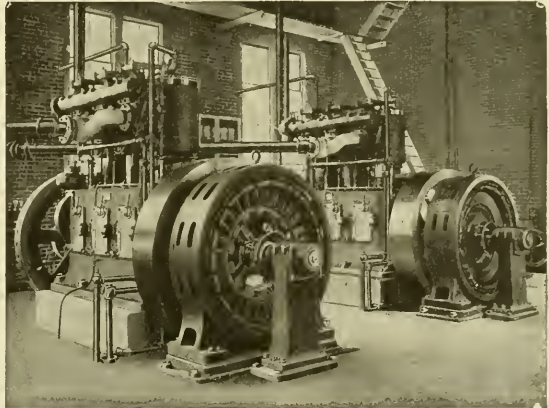

Full particulars in Publication 7066

## The Westinghouse Machine Co.

Steam Turbines, Steam Engines, Gas Engines, Gas Producers, Storage Batteries and The Roney Stoker

New York, 10 Bridge Street  
 Boston, 131 State Street  
 Atlanta, Candler Building  
 St. Louis, Chemical Building

Pittsburg, Westinghouse Building  
 Cleveland, New England Building  
 Chicago, 171 La Salle Street  
 Cincinnati, Traction Building

Philadelphia, North American Building  
 Denver, McPhee Building  
 San Francisco, Hunt, Mirk & Co.



### Any Apparatus Which Saves Time Saves Money

This applies particularly to the Westinghouse "AMM" Automatic Air Brake, the best example of what modern railway appliances have done toward better and more economical traction service. Without improved automatic air brakes electric train service and fast time, with the proper margin of safety, would be impossible.

The Westinghouse "AMM" Automatic Air Brake is designed for one to five car train service and gives graduated release, quick recharge, quick service and high pressure in emergency.

**Westinghouse Traction Brake Co.**  
 PITTSBURG, PA.

### Send for Special Publications 7059 and 7060

They contain full details and illustrations of a complete line of Westinghouse Catenary and Low Voltage Trolley Line Material for both alternating and direct current traction service.

### Westinghouse Electric & Mfg. Co.

Atlanta	Cincinnati	Kansas City	New York	Salt Lake City
Baltimore	Cleveland	Los Angeles	Philadelphia	San Francisco
Boston	Dallas	Minneapolis	Pittsburg	Seattle
Buffalo	Denver	New Orleans	St. Louis	Syracuse
Chicago	Detroit	Mexico: G. & O. Braniff & Co.,	City of Mexico	
Canada: Canadian Westinghouse Co., Ltd., Hamilton, Ont.				

## ALPHABETICAL INDEX TO ADVERTISEMENTS.

Allis-Chalmers Co. ....	Dessert & Stewart.....	Model Stoker Co.....14	Standard Paint Co.....22
Aluminum Co. of America...11	Drouvé, G. Co.....	Morden Frog & Crossing Wks..	Standard Steel Works.....18
American Brake Shoe & Fdry. Co.	Drummond Detective Agency...		Standard Underground Cable Co.
American Electrical Works.....	Eclipse Railway Supply Co.....26	National Brake & Electric Co. 2	Star Brass Works.....13
American Frog & Switch Co....	Electric Railway Equipment Co.	National Lock Washer Co.....12	Stone & Webster Engineering Corporation.....15
Anderson, Albert & J. M., Jr. Co.....22	Electric Ry. Improvement Co..22	Naugle Pole & Tie Co.....21	Stuart-Howland Co.....26
Armstrong Oil Co.....	Electric Service Supplies Co. 14	New York Switch & Crossing Co.	Symington, T. H., Co.....
Arnold Company.....	Engineers and Contractors....14	Niles Car & Mfg. Co.....17	Telegraph Signal Co.....
Automatic Trolley Guard Co.14	Fairbanks, Morse & Co.....19	Northern Engineering Works22	Trolley Supply Co.....
Babcock & Wilcox Co.....12	Forl, Bacon & Davis.....14	Nuttall, R. D., Co.....	Under-Feeder Stoker Co.....18
Baker, Wm. C., Heating & Supply Co.....17	Galena-Signal Oil Co.....15	Ohio Brass Co.....	U. S. Metal & Mfg. Co.....12
Baldwin Locomotive Works.18	General Electric Co.....25	Okonite Co., Ltd.....31	Van Dorn & Dutton Co.....13
Barbour-Stockwell Co.....	Green Engineering Co.....14	Pacific Coast Pole Co.....21	Van Dorn, W. T. Co.....
Barnes, G. H., Hardwood Lumber Co.....21	Green Fuel Economizer Co....	Patten, Paul B.....19	Van Valkenburgh, E. C.....16
Beidler, Francis, & Co.....	Griffin Wheel Co.....14	Pay-As-You-Enter Car Co. 9	Wanted and For Sale Cards.....20
Bellamy Vesthette Mfg. Co.....19	Hagy, J. Milton, Waste Wks. 11	Pressed Steel Car Co.....	Washington Steel Castings & Coupler Co.....23
Berthold & Jennings.....	Hale & Kilburn Mfg. Co.....14	Queen & Co.....2	Watson-Stillman Co.....16
Bridgeport Brass Co.....26	Hartstorn, Stewart, Co.....14	Rail Joint Co.....18	Western Electric Co. & Mfg. Co.....19
Brill, J. G., Co.....24	Heine Safety Boiler Co.....14	Railway Specialty & Supply Co.	Westinghouse Elec. & Mfg. Co. 3
Brown, Harold P.....19	Heywood Bros. & Wakefield Co.	Register, A. L. & Co.....14	Westinghouse Machine Co. 3
Brown Hoisting Machy. Co.13	Holman, D. P., Ry. Tracklayer Co.	Robertson, Wm., & Co.....14	Westinghouse Traction Brake Co. 3
Buckeye Engine Co.....	Hope Webbing Co.....26	Roder Ballast Car Co.....14	Weston Electrical Instrument Co. 2
Burnham, Williams & Co.....18	Humbird Lumber Co., Ltd.....	Rooke Automatic Register Co.23	Wharton, Wm., Jr., & Co.....17
Bylesby, H. M., & Co.....14	Jewett Car Co.....17	Russell Car & Snow-Flow Co.20	Wheeler Condenser & Eng'g Co. 14
Central Inspection Bureau...14	Johns-Manville, H. W., Co.....	S-E. Missouri Cypress Co.....21	Wheel Truing Brake Shoe Co. 14
Chase-Shawmut Co.....15	Kalamazoo Ry. Supply Co.....23	St. Louis Car Co.....7	White, J. G., & Co.....14
Chicago Mica Co.....2	Lindsay Bros. Co.....21	St. Louis Car Wheel Co.....13	Whitmore Mfg. Co.....16
Churchill Cedar Co.....21	Lord & Burnham Co.....16	Sanderson & Porter.....	Wilson, J. G., Mfg. Co.....22
Cincinnati Car Co.....	Lufkin Rule Co.....26	Saxton, A. L. & Co.....14	Woodbury Carlton Co.....19
Cleveland Frog & Cross Co....	Lumen Bearing Co.....11	Shimer & Chase Co.....14	Woodman, R., Mfg. & Supply Co. 19
Collier, Barron G.....21	Macallen Co.....	Sheaff & Jastaad.....	Worcester, C. H., Co.....21
Columbia Construction Co.14	McGuire-Cummings Mfg. Co....	Simmons, John, Co.....18	Zelnicke, Walter A., Supply Co. 20
Consolidated Car Fender Co.16	Marshall, R. W., & Co.....95	Sm. Gly. St., Heater Co. 14	
Consolidated Car-Heating Co.14	Meyers, Fred J., Mfg. Co.....11	Spier Carbon Co.....	
Contractors' Supply & Equipment Co.	Miller Anchor Co.....	Standard Brake Shoe Co.....26	
Crane Co.....21	Milloy Electric Co.....16	Standard Motor Truck Co.....11	
Creshead Engineering Co.14			
Curtain Supply Co.....14			
Davis, John, Co.....			
Dearborn Drug & Chemical Works.....23			

## CLASSIFIED LIST OF ADVERTISERS.

Advertising Designs and Plates. Woodbury-Carlton Co., Worcester, Mass.	Axles—(See Wheels and Axles).	Blowers—(See Mechanical Draft)	Brakes and Brake Parts—Continued.
Advertising Service. Van Valkenburgh, E. C., 2117 West One Hundred and Second St., Chicago.	Babbitt Metals—(See Alloys and Bearing Metals).	Blue Printing Machines. Buckeye Engine Co., Salem, O.	Brill, The J. G., Co., Philadelphia.
Advertising, Street Car. Collier, Barron G., Flat Iron Bldg., New York.	Badges and Buttons. Electric Service Supplies Co., 200 Plymouth Bldg., Chicago.	Boilers. Babcock & Wilcox Co., N. Y. Fairbanks, Morse & Co., Chicago. Green Fuel Economizer Co., Matteawan, N. Y. Heine Safety Boiler Co., 421 Elm St., St. Louis, Mo. Lord & Burnham, Irvington-Hudson, New York.	Electric Service Supplies Co., 200 Plymouth Bldg., Chicago. General Electric Co., Schenectady, N. Y. Kuhlman, The G. C., Car Co., Cleveland. McGuire-Cummings Mfg. Co., Chicago. National Brake & Electric Co., Milwaukee. Stephenson, John, Co., Elizabeth, N. J. Wason Mfg. Co., Springfield, Mass. Westinghouse Traction Brake Co., Pittsburg, Pa.
Air Brakes—(See Brakes and Brake Parts).	Ballast Cars—(See Cars, Ballast).	Boiler Cleaning Compound. Dearborn Drug & Chemical Works, Chicago. Johns-Manville, H. W., Co., New York.	Brakeshoes. American Brake Shoe & Fdry. Co., Mahwah, N. J. American Car Co., St. Louis. Barbour-Stockwell Co., Cambridgeport, Mass. Brill, The J. G., Co., Philadelphia. Cleveland O. Electric Service Supplies Co., 200 Plymouth Bldg., Chicago. General Electric Co., Schenectady, N. Y. Johns-Manville, H. W., Co., New York. Ohio Brass Co., Mansfield, O.
Air Compressors—(See Compressors, Air).	Ball Bearings. Symington, T. H., Co., Baltimore, Md.	Bonds, Rail. Brown, H. P., 120 Liberty St., New York. Chase-Shawmut Co., Newburyport, Mass. Electric Railway Improvement Co., Cleveland, O. Electric Service Supplies Co., 200 Plymouth Bldg., Chicago. General Electric Co., Schenectady, N. Y. Johns-Manville, H. W., Co., New York. Van Dorn & Dutton Co., Cleveland, O.	McGuire-Cummings Mfg. Co., Chicago. Marshall, R. W., & Co., 95 Liberty St., New York. Nuttall, R. D., Co., Pittsburg. Ohio Brass Co., Mansfield, O. Symington, T. H., Co., Baltimore, Md. Van Dorn & Dutton Co., Cleveland, O.
Alloys and Bearing Metals. Brown, H. P., 120 Liberty St., New York. General Electric Co., Schenectady, N. Y. Lumen Bearing Co., Buffalo, N. Y. Ohio Brass Co., Mansfield, O. St. Louis Car Co., St. Louis, Mo.	Bases—(See Trolley Poles and Fittings).	Brackets and Cross Arms. Anderson, Albert & J. M., Mfg. Co., Boston. Creaghead Engineering Co., Cincinnati, O. Electric Railway Equipment Co., Cincinnati, O. Electric Service Supplies Co., 200 Plymouth Bldg., Chicago. Johns-Manville, H. W., Co., New York, N. Y. Lindsley Bros. Co., Spokane, Wash. Ohio Brass Co., Mansfield, O. Stuart-Howland Co., Boston. Western Electric Co., Chicago.	Standard Brake Shoe Co., Aurora, Ill. Stephenson, John, Co., Elizabeth, N. J. Wason Mfg. Co., Springfield, Mass. Wharton, Wm., Jr., & Co., Philadelphia. Wheel Truing Brake Shoe Co., Detroit.
Aluminum Wire, Etc. Aluminum Co. of America, Pittsburg.	Bearings. Electric Service Supplies Co., 200 Plymouth Bldg., Chicago. General Electric Co., Schenectady, N. Y. Lumen Bearing Co., Buffalo, N. Y. McGuire-Cummings Mfg. Co., Chicago. Marshall, R. W., & Co., 95 Liberty St., New York. Nuttall, R. D., Co., Pittsburg. Ohio Brass Co., Mansfield, O. Symington, T. H., Co., Baltimore, Md. Van Dorn & Dutton Co., Cleveland, O.	Brushes. Motor and Dynamo. Electric Service Supplies Co., 200 Plymouth Bldg., Chicago. General Electric Co., Schenectady, N. Y. Spier Carbon Co., St. Marys, Pa.	Bridge Timbers. Beldier, Francis, & Co., Chgo.
Armatures and Coils, Winding and Repairing. Electric Service Supplies Co., 200 Plymouth Bldg., Chicago. General Electric Co., Schenectady, N. Y. Marshall, R. W., & Co., 95 Liberty St., New York. Stuart-Howland Co., Boston.	Bells and Gongs. American Car Co., St. Louis. Brill, The J. G., Co., Philadelphia. Electric Service Supplies Co., 1020-24 Filbert St., Phila. Kuhlman, The G. C., Car Co., Cleveland. McGuire-Cummings Mfg. Co., Chicago. Ohio Brass Co., Mansfield, O. St. Louis Car Co., St. Louis, Mo. Stephenson, John, Co., Elizabeth, N. J. Wason Mfg. Co., Springfield, Mass. Western Electric Co., Chicago.	Electric Service Supplies Co., 200 Plymouth Bldg., Chicago. General Electric Co., Schenectady, N. Y. Kuhlman, The G. C., Car Co., Cleveland. McGuire-Cummings Mfg. Co., Chicago. Marshall, R. W., & Co., 95 Liberty St., New York. Nuttall, R. D., Co., Pittsburg. Ohio Brass Co., Mansfield, O. Symington, T. H., Co., Baltimore, Md. Van Dorn & Dutton Co., Cleveland, O.	Brushes. Motor and Dynamo. Electric Service Supplies Co., 200 Plymouth Bldg., Chicago. General Electric Co., Schenectady, N. Y. Spier Carbon Co., St. Marys, Pa.
Armature Lifts. Electric Service Supplies Co., 200 Plymouth Bldg., Chicago.	Asbestos Materials. Johns-Manville, H. W., Co., New York.	Block System—(See Signals).	



Have You Sent for Your Sample of

# Steel Wool Journal Packing

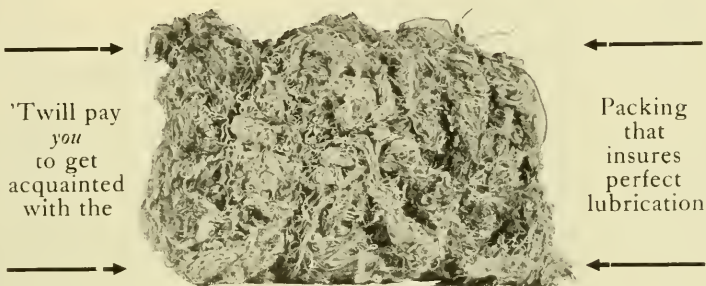

→  
It will pay  
you  
to get  
acquainted  
with the

←  
Packing  
that  
insures  
perfect  
lubrication

A two-cent stamp and a minute will bring enough to enable you to decide whether these claims are true

- 
- |                   |   |
|-------------------|---|
| <b>Steel Wool</b> | → saves one-half the packing            |
| <b>Journal</b>    | → saves one-third the oil               |
| <b>Packing</b>    | → saves labor and wear                  |
|                   | → prevents hot boxes <b>positively.</b> |
- 

You can never know what real economy in journal packing is until you get in touch with

## William Robertson & Co.

General Office: Fifth Floor Great Northern Bldg., Chicago  
 Factory: 75 South Jefferson Street, Battle Creek, Mich.

→ Drop us a line now--while you think of it ←

## CLASSIFIED LIST OF ADVERTISERS—Continued.

- Bumpers, Car.**  
American Car Co., St. Louis.  
Brill, The J. G., Co., Philadelphia.  
Kuhlman, The G. C., Car Co., Cleveland.  
St. Louis Car Co., St. Louis, Mo.  
Stephenson, John, Co., Elizabeth, N. J.  
Wason Mfg. Co., Springfield, Mass.
- Car House Doors.**  
Wilson, J. G., Mfg. Co., New York.
- Car Replacers.**  
Electric Service Supplies Co., 200 Plymouth Bldg., Chicago.  
Fairbanks, Morse & Co., Chgo. Kalamazoo Railway Supply Co., Kalamazoo, Mich.  
Ohio Brass Co., Mansfield, O.  
U. S. Metal & Mfg. Co., 25 Broad St., New York.
- Car Seats.**  
American Car Co., St. Louis.  
Brill, The J. G., Co., Philadelphia.  
Hale & Kilburn Mfg. Co., Philadelphia.  
Heywood Bros. & Wakefield Co., Wakefield, Mass.  
Kuhlman, The G. C., Car Co., Cleveland.  
St. Louis Car Co., St. Louis, Mo.  
Stephenson, John, Co., Elizabeth, N. J.  
Wason Mfg. Co., Springfield, Mass.
- Car Signs—(See Signs, Cars and Track).**
- Car Steps.**  
Electric Service Supplies Co., 200 Plymouth Bldg., Chicago.
- Car Trimmings—(See Trimmings, Car).**
- Cars, Ballast.**  
Rodger Ballast Car Co., Chgo. St. Louis Car Co., St. Louis, Mo.
- Cars, Dump.**  
Fairbanks, Morse & Co., Chgo. Rodger Ballast Car Co., Chgo. Russell Car & Snow-Plow Co., Ridgway, Pa.  
St. Louis Car Co., St. Louis, Mo.
- Cars, Passenger and Freight.**  
American Car Co., St. Louis.  
Brill, The J. G., Co., Philadelphia.  
Cincinnati Car Co., Cincinnati.  
Detroit Carbuilding & Equipment Co., Detroit, Mich.  
Electric Railway Improvement Co., Cleveland, O.  
Fairbanks, Morse & Co., Chgo. Jewett Car Co., Newark, O.  
Kuhlman, The G. C., Car Co., Cleveland.  
McGuire-Cummings Mfg. Co., Chicago.  
Niles Car & Mfg. Co., Niles, O.  
Pressed Steel Car Co., Pittsburg.  
Rodger Ballast Car Co., Chgo. Russell Car & Snow-Plow Co., Ridgway, Pa.  
St. Louis Car Co., St. Louis, Mo.  
Standard Motor Truck Co., Pittsburg.  
Stephenson, John, Co., Elizabeth, N. J.  
Wason Mfg. Co., Springfield, Mass.
- Cars, Pay-As-You-Enter.**  
Pay-As-You-Enter Car Co., 26 Cortland St., New York.
- Cars, Rebuilt.**  
Detroit Carbuilding & Equipment Co., Detroit, Mich.
- Cars, Second-Hand.**  
Detroit Carbuilding & Equipment Co., Detroit, Mich.  
Marshall, R. W., & Co., 95 Liberty St., New York.  
Zelnicke, Walter A., Supply Co., St. Louis.
- Cars, Steel.**  
Pressed Steel Car Co., Pittsburg.  
St. Louis Car Co., St. Louis, Mo.  
Standard Motor Truck Co., Pittsburg.
- Castings, Brass.**  
Star Brass Works, Kalamazoo, Mich.
- Castings, Iron and Steel.**  
American Brake Shoe & Foundry Co., Mahwah, N. J.  
Green Engineering Co., Com'l Nat. Bk. Bldg., Chicago.  
National Brake & Electric Co., Milwaukee.  
Washburn Steel Castings & Coupler Co., Minneapolis.
- Catchers—(See Trolley Retrievers and Catchers).**
- Cattle Guards.**  
Fairbanks, Morse & Co., Chgo.
- Circuit-Breakers.**  
Electric Service Supplies Co., 200 Plymouth Bldg., Chicago.  
General Electric Co., Schenectady, N. Y.  
Western Electric Co., Chicago.
- Coal Handling Machinery—(See Conveyors).**
- Coils—(See Armatures and Coils).**
- Commutators and Parts.**  
Electric Service Supplies Co., 1020-24 Filbert St., Phila.  
General Electric Co., Schenectady, N. Y.  
Marshall, R. W., & Co., 95 Liberty St., New York.  
Ohio Brass Co., Mansfield, O.  
Stuart-Howland Co., Boston.
- Compressors, Air.**  
Fairbanks, Morse & Co., Chgo. General Electric Co., Schenectady, N. Y.  
National Brake & Electric Co., Milwaukee.  
Westinghouse Traction Brake Co., Pittsburg.
- Concrete Mixers.**  
Contractors' Supply & Equip. Co., Chicago.
- Condensers.**  
Wheeler Condenser & Engineering Co., Carteret, N. J.
- Conduits.**  
Electric Service Supplies Co., 200 Plymouth Bldg., Chicago.  
Western Electric Co., Chicago.
- Connectors, Solderless.**  
Dossert & Co., 242 W. Forty-first St., New York.
- Contractors.**  
Arnold Company, 131 La Salle St., Chicago.  
Byrd, H. M., Co., Am. Trust Bldg., Chicago.  
Columbia Construction Co., Milwaukee, Wis.  
Creshead Engineering Co., Cincinnati, O.  
Green Engineering Co., Com'l Nat. Bk. Bldg., Chicago.  
Register, A. L., & Co., 112 N. Broad St., Philadelphia.  
Sanderson & Porter, 52 William St., New York.  
Saxton, E., 841 Madison Bldg., Washington, D. C.  
Sheaff & Jaastad, 83 Broad St., Boston.  
Stone & Webster Engineering Corporation, Boston.  
Wharton, Wm., Jr., & Co., Philadelphia.  
White, J. G., & Co., 49 Exchange Pl., New York.
- Controllers and Attachments.**  
Electric Service Supplies Co., 200 Plymouth Bldg., Chicago.  
General Electric Co., Schenectady, N. Y.  
Johns-Manville, H. W., Co., New York.  
Marshall, R. W., & Co., 95 Liberty St., New York.  
Western Electric Co., Chicago.  
Westinghouse Electric & Mfg. Co., Pittsburg.
- Conveyors and Coal Handling Machinery.**  
Green Engineering Co., Com'l Nat. Bk. Bldg., Chicago.  
Northern Engineering Works, Detroit, Mich.
- Cord, Bell and Trolley—Continued.**  
Kuhlman, The G. C., Car Co., Cleveland.  
St. Louis Car Co., St. Louis, Mo.  
Stephenson, John, Co., Elizabeth, N. J.  
Stuart-Howland Co., Boston.  
Wason Mfg. Co., Springfield, Mass.
- Couplers, Car.**  
American Car Co., St. Louis.  
Brill, The J. G., Co., Philadelphia.  
Kuhlman, The G. C., Car Co., Cleveland.  
McGuire-Cummings Mfg. Co., Chicago.  
Ohio Brass Co., Mansfield, O.  
St. Louis Car Co., St. Louis, Mo.  
Stephenson, John, Co., Elizabeth, N. J.  
Stuart-Howland Co., Boston.  
Washburn Steel Castings & Coupler Co., Minneapolis.  
Wason Mfg. Co., Springfield, Mass.
- Coverings, Pipe and Boiler.**  
Johns-Manville, H. W., Co., New York.
- Cranes, Hoists and Lifts.**  
American Car Co., St. Louis.  
Brill, The J. G., Co., Philadelphia.  
Brown Hoisting Machinery Co., Cleveland, O.  
Kuhlman, The G. C., Car Co., Cleveland.  
Northern Engineering Works, Detroit, Mich.  
Ridway Specialty & Supply Co., Chicago.  
Stephenson, John, Co., Elizabeth, N. J.  
Van Dorn & Dutton Co., Cleveland, O.  
Wason Mfg. Co., Springfield, Mass.
- Cross Arms—(See Brackets and Cross Arms).**
- Crossing Gates—(See Gates and Guards).**
- Crossings, Track—(See Switches, Frogs and Crossings).**
- Curtains, Fixtures and Materials.**  
American Car Co., St. Louis.  
Brill, The J. G., Co., Philadelphia.  
Curtain Supply Co., 93 Ohio St., Chicago.  
Electric Service Supplies Co., 200 Plymouth Bldg., Chicago.  
Hartshorn, Stewart, Co., East Newark, N. J.  
Kuhlman, The G. C., Car Co., Cleveland.  
Marshall, R. W., & Co., 95 Liberty St., New York.  
National Lock Washer Co., Newark, N. J.  
Pantaasote Co., 11 Broadway, New York.  
St. Louis Car Co., St. Louis, Mo.  
Stephenson, John, Co., Elizabeth, N. J.  
Wason Mfg. Co., Springfield, Mass.
- Cylinder Oil.**  
Power Specialty Co., 111 Broadway, N. Y.
- Derailing Devices.**  
American Frog & Switch Co., Hamilton, O.  
Cleveland Frog & Crossing Co., Cleveland, O.
- Detective Agency.**  
Drummond Detective Agency, New York.
- Doors and Fixtures.**  
American Car Co., St. Louis.  
Brill, The J. G., Co., Philadelphia.  
Kuhlman, The G. C., Car Co., Cleveland.  
St. Louis Car Co., St. Louis, Mo.  
Stephenson, John, Co., Elizabeth, N. J.  
Wason Mfg. Co., Springfield, Mass.
- Doors, Steel Rolling.**  
Wilson, J. G., Mfg. Co., New York.
- Draft, Mechanical—(See Mechanical Draft).**
- Draft Rigging.**  
Van Dorn, W. T., Co., Chgo. Washburn Steel Castings & Coupler Co., Minneapolis.
- Drills, Track.**  
Brown, H. P., 120 Liberty St., New York.  
Electric Service Supplies Co., 200 Plymouth Bldg., Chicago.  
Fairbanks, Morse & Co., Chgo. Kalamazoo Railway Supply Co., Kalamazoo, Mich.  
Marshall, R. W., & Co., 95 Liberty St., New York.
- Drying Appliances.**  
Green Fuel Economizer Co., Matteawan, N. Y.
- Dynamos and Generators.**  
Fairbanks, Morse & Co., Chgo. General Electric Co., Schenectady, N. Y.  
National Brake & Electric Co., Milwaukee, Wis.  
Western Electric Co., Chicago.  
Westinghouse Electric & Mfg. Co., Pittsburg, Pa.
- Economizers, Fuel.**  
Green Fuel Economizer Co., Matteawan, N. Y.
- Electrical Instruments.**  
Electric Service Supplies Co., 200 Plymouth Bldg., Chicago.  
General Electric Co., Schenectady, N. Y.  
Johns-Manville, H. W., Co., New York.  
Queen & Co., Philadelphia.  
Western Electric Co., Chicago.  
Westinghouse Electric & Mfg. Co., Pittsburg, Pa.  
Weston Electrical Instrument Co., Newark, N. J.
- Electric Railway Supplies, General.**  
Creshead Engineering Co., Cincinnati, O.  
Electric Service Supplies Co., 200 Plymouth Bldg., Chicago.  
Fairbanks, Morse & Co., Chgo. General Electric Co., Schenectady, N. Y.  
Johns-Manville, H. W., Co., New York.  
Marshall, R. W., & Co., 95 Liberty St., New York.  
Ohio Brass Co., Mansfield, O.  
Stuart-Howland Co., Boston.  
Western Electric Co., Chicago.
- Engine Apparatus.**  
Green Fuel Economizer Co., Matteawan, N. Y.
- Engineers and Contractors.**  
Arnold Company, Chicago.  
Eylesby, H. M., & Co., Chgo. Columbia Construction Co., Milwaukee, Wis.  
Ford, Bacon & Davis, New York.  
Register, A. L., & Co., Philadelphia.  
Sanderson & Porter, New York.  
Saxton, E., Washington, D. C.  
Sheaff & Jaastad, Boston.  
Stone & Webster Engineering Corporation, Boston.  
White, J. G., & Co., New York.
- Engines, Gas and Oil.**  
Buckeye Engine Co., Salem, O.  
Fairbanks, Morse & Co., Chgo. Westinghouse Machine Co., Pittsburg.
- Engines, Hoisting.**  
Fairbanks, Morse & Co., Chgo.
- Engines, Steam.**  
Buckeye Engine Co., Salem, O.  
Westinghouse Machine Co., Pittsburg.
- Fans, Exhaust and Ventilating.**  
General Electric Co., Schenectady, N. Y.  
Green Fuel Economizer Co., Matteawan, N. Y.  
Western Electric Co., Chicago.  
Westinghouse Elec. & Mfg. Co., Pittsburg.
- Fare Boxes—(See Electric Railway Supplies).**
- Fare Registers and Register Fittings.**  
Electric Service Supplies Co., 200 Plymouth Bldg., Chicago.  
Rooke Automatic Register Co., Providence, R. I.

# ST. LOUIS CAR CO. ST. LOUIS-MO.



## St. Louis Car Company's Semi-Convertible Type

The illustration represents one of the cars recently shipped by us to the Houston Electric Company, Houston, Texas.

These cars are of our own design—a practically perfect Semi-Convertible type. Both lower and upper sashes raise into the roof. They move easily and when in the roof pockets are securely fastened, with no possible danger of falling and injuring passengers.

### Our construction of the Semi-Convertible Car is the very best that has yet been devised

These Houston cars are 28' over corner posts and 31' 6" over all. Width over arm rail, 8' 6". They are finished with very handsomely figured mahogany, provided with curtains at each window and each door opening and have the St. Louis Car Company's latest improved "Walkover" seat.

The cars are mounted on St. Louis Car Company's No. 47 Short Wheel Base Truck, which has been adopted as standard in a great many of the larger cities. The channel-iron and steel construction of the "Robertson type" permits the arm rail of the car to be placed very low and adds much to the appearance.

*Photographs, Blue Prints and Specifications will be mailed upon request.*

## CLASSIFIED LIST OF ADVERTISERS—Continued.

- Feedwater Apparatus.**  
Green Fuel Economizer Co., Matteawan, N. Y.  
Wheeler Condenser & Engineering Co., Carteret, N. J.
- Feed Wire—(See Wire and Cables).**
- Fenders and Guards.**  
Consolidated Car Fender Co., Providence, R. I.  
Eclipse Railway Supply Co., Cleveland, O.  
Electric Service Supplies Co., 1020-24 Filbert St., Phila.  
McGuire-Cummings Mfg. Co., Chicago.  
Marshall, R. W., & Co., 95 Liberty St., New York.
- Flangers, Snow.**  
Kalamazoo Railway Supply Co., Kalamazoo, Mich.  
McGuire-Cummings Mfg. Co., Chicago.  
Ohio Brass Co., Mansfield, O.  
Van Dorn & Dutton Co., Cleveland, O.
- Frogs—(See Switches, Frogs and Crossings).**
- Fuel Economizers—(See Economizers, Fuel).**
- Fuses and Fuse Devices.**  
Chase-Shawmut Co., Newburyport, Mass.  
Electric Service Supplies Co., 200 Plymouth Bldg., Chicago.  
General Electric Co., Schenectady, N. Y.  
Johns-Manville, H. W., Co., New York.  
Western Electric Co., Chicago.  
Westinghouse Elec. & Manufacturing Co., Pittsburg.
- Gaskets, Bronze.**  
Power Specialty Co., 111 Broadway, New York.
- Gates and Guards.**  
Kalamazoo Railway Supply Co., Kalamazoo, Mich.
- Gear Cases.**  
Electric Service Supplies Co., 200 Plymouth Bldg., Chicago.  
General Electric Co., Schenectady, N. Y.  
Marshall, R. W., & Co., 95 Liberty St., New York.
- Gears and Pinions.**  
Electric Service Supplies Co., 200 Plymouth Bldg., Chicago.  
General Electric Co., Schenectady, N. Y.  
Marshall, R. W., & Co., 95 Liberty St., New York.  
Nuttall, R. D., Co., Pittsburg.  
Van Dorn & Dutton Co., Cleveland, O.
- Generators—(See Dynamos).**
- Gongs—(See Bells and Gongs).**
- Graphite Paint—(See Paint).**
- Grates, Chain.**  
Green Engineering Co., Com'l Nat. Bk. Bldg., Chicago.
- Grease—(See Lubricants).**
- Grinders.**  
Brown, Harold P., 120 Liberty St., New York.
- Ground Connection Clamps.**  
Chase-Shawmut Co., Newburyport, Mass.
- Guy Anchors—(See Anchors).**
- Harps, Trolley—(See Trolley Poles and Fittings).**
- Headlights.**  
Electric Service Supplies Co., 200 Plymouth Bldg., Chicago.  
Fairbanks, Morse & Co., Chgo.  
General Electric Co., Schenectady, N. Y.  
St. Louis Car Co., St. Louis, Mo.  
Stuart-Howland Co., Boston.  
Trolley Supply Co., Canton, O.
- Heaters, Car, Electric.**  
Consolidated Car-Heating Co., Albany, N. Y.  
Johns-Manville, H. W., Co., New York.
- Heaters, Car, Hot Water, and Stoves.**  
Baker, The Wm. C., Heating & Sup. Co., New York.  
McGuire-Cummings Mfg. Co., Chicago.  
Smith, Peter, Heater Co., Detroit, Mich.
- Heating and Ventilating Apparatus—(See Mech. Draft).**
- Hoists—(See Cranes, Hoists and Lifts).**
- Hose Bridges.**  
Ohio Brass Co., Mansfield, O.
- Hydraulic Machinery.**  
Watson-Stillman Co., 26 Cortlandt St., New York.
- Inspection.**  
Central Inspection Bureau.
- Inspection Cars, Gasoline.**  
Stover Motor Car Co., Freeport, Ill.
- Instruments, Measuring and Testing—(See Electrical Instruments).**
- Insulating Tapes.**  
General Electric Co., Schenectady, N. Y.  
Johns-Manville, H. W., Co., New York, N. Y.  
Okonite Co., Ltd., 253 Broadway, New York.  
Western Electric Co., Chicago.
- Insulations and Insulating Material.**  
Anderson, A. & J. M., Mfg. Co., Boston.  
Creaghead Engineering Co., Cincinnati, O.  
Electric Railway Equipment Co., Cincinnati, O.  
Electric Service Supplies Co., 200 Plymouth Bldg., Chicago.  
General Electric Co., Schenectady, N. Y.  
Johns-Manville, H. W., Co., New York.  
Macallen, The, Co., Boston.  
Ohio Brass Co., Mansfield, O.  
Okonite Co., Ltd., 253 Broadway, New York.  
Standard Paint Co., 100 William St., New York.  
Stuart-Howland Co., Boston.  
Western Electric Co., Chicago.
- Jacks.**  
American Car Co., St. Louis.  
Brill, The J. G., Co., Philadelphia.  
Electric Service Supplies Co., 200 Plymouth Bldg., Chicago.  
Fairbanks, Morse & Co., Chgo.  
Kalamazoo Railway Supply Co., Kalamazoo, Mich.  
Kuhlman, The G. C., Car Co., Cleveland.  
Marshall, R. W., & Co., 95 Liberty St., New York.  
Morden Frog & Crossing Co., Chicago.  
Stephenson, John, Co., Elizabeth, N. J.  
Watson Mfg. Co., Springfield, Mass.  
Watson-Stillman Co., 26 Cortlandt St., New York.
- Joints, Expansion—(See Steam Fittings).**
- Joints, Rail.**  
Rail Joint Co., 29 W. 34th St., New York.
- Joints, Welded—(See Rail Joints, Welded).**
- Journal Boxes.**  
American Car Co., St. Louis.  
Brill, The J. G., Co., Philadelphia.  
Kuhlman, The G. C., Car Co., Cleveland.  
McGuire-Cummings Mfg. Co., Chicago.  
St. Louis Car Co., St. Louis, Mo.  
Stephenson, John, Co., Elizabeth, N. J.  
Syrington, T. H., Co., Baltimore, Md.  
Watson Mfg. Co., Springfield, Mass.
- Journal Lubricators—(See Lubricants).**
- Journal Packing, Steel Wool.**  
Robertson, Wm., & Co., Fifth Floor Great Northern Bldg., Chicago.
- Lamps, Arc and Incandescent.**  
Anderson, A. & J. M., Mfg. Co., Boston.  
Electric Service Supplies Co., 200 Plymouth Bldg., Chicago.  
General Electric Co., Schenectady, N. Y.  
Stuart-Howland Co., Boston.  
Western Electric Co., Chicago.  
Westinghouse Electric & Mfg. Co., Pittsburg, Pa.
- Lamp Sockets.**  
Electric Service Supplies Co., 200 Plymouth Bldg., Chicago.  
General Electric Co., Schenectady, N. Y.  
Johns-Manville, H. W., Co., New York, N. Y.
- Lantern Globes.**  
Railway Specialty & Supply Co., Chicago.
- Lifts—(See Cranes, Hoist and Lift).**
- Lightning Arresters.**  
Electric Service Supplies Co., 200 Plymouth Bldg., Chicago.  
General Electric Co., Schenectady, N. Y.  
Stuart-Howland Co., Boston.  
Western Electric Co., Chicago.  
Westinghouse Elec. & Manufacturing Co., Pittsburg.
- Line Material.**  
Anderson, A. & J. M., Mfg. Co., Boston.  
Creaghead Engineering Co., Cincinnati, O.  
Johns-Manville, H. W., Co., New York.  
Electric Ry. Equipment Co., Cincinnati, O.  
Electric Service Supplies Co., 200 Plymouth Bldg., Chicago.  
General Electric Co., Schenectady, N. Y.  
Macallen, The, Co., Boston.  
Marshall, R. W., & Co., 95 Liberty St., New York.  
Stuart-Howland Co., Boston.  
Western Electric Co., Chicago.
- Lock and Nut Washers.**  
National Lock Washer Co., Newark, N. J.
- Lockers, Metal.**  
Electric Service Supplies Co., 200 Plymouth Bldg., Chicago.
- Locomotives.**  
Baldwin Locomotive Works, Philadelphia.  
Locomotives, Electric.  
American Car Co., St. Louis.  
Baldwin Locomotive Works, Philadelphia.  
Brill, The J. G., Co., Philadelphia.  
General Electric Co., Schenectady, N. Y.  
Kuhlman, The G. C., Car Co., Cleveland.  
McGuire-Cummings Mfg. Co., Chicago.  
Stephenson, John, Co., Elizabeth, N. J.  
Watson Mfg. Co., Springfield, Mass.  
Westinghouse Elec. & Manufacturing Co., Pittsburg.
- Locomotives, Gasoline.**  
Fairbanks, Morse & Co., Chgo.  
Stover Motor Car Co., Freeport, Ill.
- Lubricants.**  
Dearborn Drug & Chemical Works, Chicago.  
Galena Signal Oil Co., Franklin, Pa.  
Whitmore Mfg. Co., Cleveland, O.
- Lumber.**  
Barnes, G. H., Hardwood Lumber Co., St. Louis, Mo.  
Beidler, Francis, & Co., Chgo.  
Berthold & Jennings, St. Louis.  
Linsley Bros. Co., Spokane, Wash.  
St.-E. Missouri Cypress Co., Campbell, Mo.
- Malleable Iron.**  
St. Louis Car Co., St. Louis, Mo.
- Measuring Tapes.**  
Lufkin Rule Co., Saginaw, Mich.
- Mechanical Draft.**  
Green Fuel Economizer Co., Matteawan, N. Y.
- Meters.**  
Johns-Manville, H. W., Co., New York.  
Queen & Co., Philadelphia.  
Weston Electrical Instrument Co., Newark, N. J.
- Mica, Raw and Manufactured.**  
Chicago Mica Co., Valparaiso, Ind.
- Motor Cars, Gasoline.**  
Stover Motor Car Co., Freeport, Ill.
- Motors, Electric.**  
Fairbanks, Morse & Co., Chgo.  
General Electric Co., Schenectady, N. Y.  
National Brake & Electric Co., Milwaukee.  
Western Electric Co., Chicago.  
Westinghouse Elec. & Manufacturing Co., Pittsburg.
- Nut Locks.**  
Chase-Shawmut Co., Newburyport, Mass.  
National Lock Washer Co., Newark, N. J.  
Railway Specialty & Supply Co., Chicago.  
St. Louis Car Co., St. Louis, Mo.  
U. S. Metal & Mfg. Co., 25 Broad St., New York.
- Nuts and Bolts.**  
National Lock Washer Co., Newark, N. J.  
Railway Specialty & Supply Co., Chicago.
- Oilers.**  
Armstrong Oiler Co., 31st and Chestnut St., Philadelphia.
- Oils—(See Lubricants).**
- Overhead Equipment—(See Electric Railway Supplies).**
- Packings.**  
Electric Service Supplies Co., 200 Plymouth Bldg., Chicago.  
Johns-Manville, H. W., Co., New York.  
Power Specialty Co., 111 Broadway, New York.
- Packing, Steel Wool Journal.**  
Robertson, Wm., & Co., Fifth Floor Great Northern Bldg., Chicago.
- Paints.**  
Standard Paint Co., 100 William St., New York.
- Pay-As-You-Enter Cars.**  
Pay-As-You-Enter Car Co., 26 Cortlandt St., New York.
- Pipe Bends and Fittings—(See Steam Fittings).**
- Poles, Metal.**  
Creaghead Engineering Co., Cincinnati, O.  
Electric Railway Equipment Co., Cincinnati, O.  
Electric Service Supplies Co., 200 Plymouth Bldg., Chicago.
- Poles and Ties, Wood.**  
Barnes, G. H., Hardwood Lumber Co., St. Louis, Mo.  
Beidler, Francis, & Co., Chgo.  
Berthold & Jennings, St. Louis.  
Churchill Cedar Co., Spokane, Wash.  
Humbird Lumber Co., Sand Point, Idaho.  
Linsley Bros. Co., Spokane, Wash.  
National Pole Co., Escanaba, Mich.  
Nagle Pole & Tie Co., 226 La Salle St., Chicago.  
Pacific Coast Pole Co., Spokane, Wash.  
S.-E. Missouri Cypress Co., Campbell, Mo.  
Worcester, C. H., Co., Tribune Bldg., Chicago.
- Promoters of Railway Projects.**  
Shimer & Chase Co., Omaha, Neb.
- Punches—(See Ticket Punches).**
- Rail Benders.**  
Electric Service Supplies Co., 200 Plymouth Bldg., Chicago.  
Fairbanks, Morse & Co., Chgo.

# Your Women Passengers Will Praise Pay-As-You-Enter Cars

They have praised them unreservedly in other cities, because their use means comfortable and safe travel.

A New York press report, published after the recent installation of Pay-As-You-Enter cars on the Madison Avenue line of the New York City Railway, says:

“Among the passengers, especially the women, only words of praise were heard. They were free from the usual indecent jamming incidental to surface travel in this city. The little crowding on the platform occasionally did not count.”

There is more money to be made out of a service that pleases passengers than from the other kind. And remember, too, that the strongest feature of Pay-As-You-Enter Car operation from the company's standpoint is that every passenger's fare is collected before the car is entered.



We license manufacturers and railways to build and use the Pay-As-You-Enter Car, the patents on which are owned by

**The Pay-As-You-Enter  
Car Company** 26 Cortlandt Street  
NEW YORK, N. Y.

Duncan McDonald, Pres. Thos. W. Casey, Mgr.



## CLASSIFIED LIST OF ADVERTISERS—Continued.

- Rail Bonds—(See Bonds, Rail).
- Rail Bonds, Flexible.  
Chase-Shawmut Co., Newburyport, Mass.
- Rail Drills—(See Drills, Track).
- Rail Feed Wire—(See Wire and Cables).
- Rail Joints and Chairs—(See Joints, Rail).
- Rails, New.  
New York Switch & Crossing Co., Hoboken, N. J.  
Wharton, Wm., Jr., & Co., Philadelphia.
- Rails, Relaying.  
Zelnicke, Walter A., Supply Co., St. Louis.
- Railway Velocipedes.  
Fairbanks Morse & Co., Chgo.  
Kalamazoo Railway Supply Co., Kalamazoo, Mich.
- Registers and Fittings—(See Fare Registers).
- Relays.  
Weston Electrical Instrument Co., Newark, N. J.
- Roofing.  
Johns-Manville, H. W., Co., New York.
- Sand Apparatus.  
American Car Co., St. Louis.  
Brill, The J. G., Co., Philadelphia.  
Electric Service Supplies Co., 200 Plymouth Bldg., Chicago.  
Kuhlman, The G. C., Car Co., Cleveland.  
Marshall, R. W., & Co., 95 Liberty St., New York.  
Ohio Brass Co., Mansfield, O.  
St. Louis Car Co., St. Louis, Mo.  
Stephenson, John, Co., Elizabeth, N. J.  
Wason Mfg. Co., Springfield, Mass.
- Sash Balances and Fixtures.  
National Lock Washer Co., Newark, N. J.
- Sash Operating Devices.  
Drouvé, The G., Co., Bridgeport, Conn.  
Lord & Burnham, Irvington-on-Hudson, New York.
- Seats, Car—(See Car Seats).
- Shade Rollers—(See Curtains, Fixtures and Materials).
- Signals.  
Telegraph Signal Co., Rochester, N. Y.
- Signal Supplies.  
Railway Specialty & Supply Co., Chicago.
- Skylights.  
Drouvé, The G., Co., Bridgeport, Conn.  
Lord & Burnham, Irvington-on-Hudson, New York.
- Snow Plows, Sweepers and Scrapers.  
American Car Co., St. Louis.  
Brill, The J. G., Co., Philadelphia.  
Kalamazoo Railway Supply Co., Kalamazoo, Mich.  
Kuhlman, The G. C., Car Co., Cleveland.  
McGuire-Cummings Mfg. Co., Chicago.  
Russell Car & Snow-Plow Co., Ridgway, Pa.  
Stephenson, John, Co., Elizabeth, N. J.  
Wason Mfg. Co., Springfield, Mass.
- Sockets, Waterproof.  
Johns-Manville, H. W., Co., New York.
- Solder Paste.  
Chase-Shawmut Co., Newburyport, Mass.
- Springs.  
American Car Co., St. Louis.  
Brill, The J. G., Co., Philadelphia.  
Kuhlman, The G. C., Car Co., Cleveland.  
McGuire-Cummings Mfg. Co., Chicago.
- Springs—Continued.  
Marshall, R. W., & Co., 95 Liberty St., New York.  
Railway Steel Spring Co., 71 Broadway, New York.  
St. Louis Car Co., St. Louis, Mo.  
Stephenson, John, Co., Elizabeth, N. J.  
Wason Mfg. Co., Springfield, Mass.
- Sprinkling Cars.  
American Car Co., St. Louis.  
Brill, The J. G., Co., Philadelphia.  
Kuhlman, The G. C., Car Co., Cleveland.  
McGuire-Cummings Mfg. Co., Chicago.  
Stephenson, John, Co., Elizabeth, N. J.  
Wason Mfg. Co., Springfield, Mass.
- Stage Pockets and Plugs.  
Chase-Shawmut Co., Newburyport, Mass.
- Steam Apparatus.  
Green Fuel Economizer Co., Matteawan, N. Y.
- Steam Fittings, Etc.  
Crane Co., Chicago.  
Davis, The John, Co., Chgo.  
Simmons, John, Co., 110 Centre St., New York.  
Power Co., Springfield, O., 111 Broadway, New York.
- Steel Cars.  
American Car Co., St. Louis.  
Brill, The J. G., Co., Philadelphia.  
Kuhlman, The G. C., Car Co., Cleveland.  
St. Louis Car Co., St. Louis, Mo.  
Stephenson, John, Co., Elizabeth, N. J.  
Wason Mfg. Co., Springfield, Mass.
- Steel Tapes.  
Lufkin Rule Co., Saginaw, Mich.
- Stokers.  
Babcock & Wilcox Co., 85 Liberty St., New York.  
Green Engineering Co., Com'l Nat. Bk. Bldg., Chicago.  
Model Stoker Co., Dayton, O.  
Underwood Stoker Company of America, Chicago.  
Westinghouse Machine Co., Pittsburg.
- Storage Batteries—(See Batteries).
- "Strike-Breakers."  
Drummond Detective Agency, 3 Ann St., New York.
- Superheaters.  
Power Specialty Co., 111 Broadway, New York.
- Switches, Frogs and Crossings.  
American Frog & Switch Co., Hamilton, O.  
Barbour-Stockwell Co., Cambridgeport, Mass.  
Cleveland Frog & Crossing Co., Cleveland, O.  
Fairbanks, Morse & Co., Chgo.  
Jordan Frog & Crossing Co., Rookery, Chicago.  
New York Switch & Crossing Co., Hoboken, N. J.  
Railway Specialty & Supply Co., Chicago.  
Wharton, Wm., Jr., & Co., Philadelphia.
- Switchboards and Switchboard Instruments.  
Anderson, A. & J. M., Mfg. Co., Boston.  
Chase-Shawmut Co., Newburyport, Mass.  
General Electric Co., Schenectady, N. Y.  
Western Electric Co., Chicago.  
Westinghouse Electric & Mfg. Co., Pittsburg.  
Weston Electrical Instrument Co., Newark, N. J.
- Tapes and Webbing.  
Hope Webbing Co., Providence, R. I.  
Johns-Manville, H. W., Co., New York.  
Okonite Co., Ltd., 253 Broadway, New York.
- Testing Instruments.  
Quinn Co., Philadelphia.  
Weston Electrical Instrument Co., Newark, N. J.
- Test Lamps, Pocket.  
Chase-Shawmut Co., Newburyport, Mass.
- Ticket Choppers and Destroyers.  
Patten, Paul B., Salem, Mass.
- Ticket Punches.  
Chicago Fred J., Mfg. Co., Hamilton, O.  
Woodman Mfg. & Sup. Co., Boston.
- Ties and Poles, Wood—(See Poles and Ties).
- Timber.  
Belder, Francis, & Co., Chgo.  
Lindsay Bros. Co., Spokane, Wash.
- S-E. Missouri Cypress Co., Campbell, Mo.
- Tools, Pneumatic—(See Pneumatic Tools).
- Track Cleaners and Scrapers.  
American Car Co., St. Louis.  
Brill, The J. G., Co., Philadelphia.  
Kalamazoo Railway Supply Co., Kalamazoo, Mich.  
Kuhlman, The G. C., Car Co., Cleveland.  
McGuire-Cummings Mfg. Co., Chicago.  
Marshall, R. W., & Co., 95 Liberty St., New York.  
Ohio Brass Co., Mansfield, O.  
Stephenson, John, Co., Elizabeth, N. J.  
Van Dorn & Dutton Co., Cleveland, O.  
Wason Mfg. Co., Springfield, Mass.
- Track Drills—(See Drills, Track).
- Tracklaying Machinery.  
Holman, D. F., Ry. Tracklayer Co., 1102 Ellsworth Bldg., Chicago.
- Track Tools.  
Electric Service Supplies Co., 200 Plymouth Bldg., Chicago.  
Kalamazoo Railway Supply Co., Kalamazoo, Mich.
- Trimming, Car.  
American Car Co., St. Louis.  
Brill, The J. G., Co., Philadelphia.  
Curtain Supply Co., Park Row Bldg., New York.  
Kuhlman, The G. C., Car Co., Cleveland.  
National Lock Washer Co., Newark, N. J.  
St. Louis Car Co., St. Louis, Mo.  
Stephenson, John, Co., Elizabeth, N. J.  
Wason Mfg. Co., Springfield, Mass.
- Trolley Guards.  
Automatic Trolley Guard Co., 391 Elliott Sq., Buffalo, N. Y.  
Electric Service Supplies Co., 200 Plymouth Bldg., Chicago.
- Trolley Poles and Fittings.  
General Electric Co., Schenectady, N. Y.  
Johns-Manville, H. W., Co., New York.  
Marshall, R. W., & Co., 95 Liberty St., New York.  
Milloy Electric Co., Bucyrus, O.  
Nuttall, R. D., Co., Pittsburg.  
Star Brass Works, Kalamazoo, Mich.  
Trolley Supply Co., Canton, O.  
Westinghouse Electric & Mfg. Co., Pittsburg, Pa.
- Trolley Retrievers and Catchers.  
Electric Service Supplies Co., 1020-24 Filbert St., Phila.  
Milloy Electric Co., Bucyrus, O.  
Trolley Supply Co., Canton, O.
- Trolley Wagons.  
Kalamazoo Railway Supply Co., Kalamazoo, Mich.
- Trolley Wheels—(See Trolley Poles and Fittings).
- Trolley Wire—(See Wire and Cables).
- Trucks, Car.  
American Car Co., St. Louis.  
Baldwin Locomotive Works, Philadelphia.
- Trucks, Car—Continued.  
Brill, The J. G., Co., Philadelphia.  
Kuhlman, The G. C., Car Co., Cleveland.  
McGuire-Cummings Mfg. Co., Chicago.  
St. Louis Car Co., St. Louis, Mo.  
Standard Motor Truck Co., Pittsburg, Pa.  
Stephenson, John, Co., Elizabeth, N. J.  
Van Dorn & Dutton Co., Cleveland, O.  
Wason Mfg. Co., Springfield, Mass.
- Turbines.  
General Electric Co., Schenectady, N. Y.  
Westinghouse Machine Co., Pittsburg, Pa.
- Valves—(See Steam Fittings).
- Varnish.  
Electric Service Supplies Co., 200 Plymouth Bldg., Chicago.  
Standard Paint Co., 100 William St., New York.
- Ventilators.  
Drouvé, The G., Co., Bridgeport, Conn.  
Lord & Burnham, Irvington-on-Hudson, New York.
- Vestiettes.  
Bellamy Vestiette Mfg. Co., Cleveland, O.
- Waste, Cotton and Wool.  
Hagy, J. Milton, Waste Wks., Philadelphia, Pa.  
Railway Specialty & Supply Co., Chicago.
- Water Softening Apparatus.  
Dearborn Drug & Chemical Works, Chicago.
- Wheels and Axles.  
American Car Co., St. Louis.  
Brill, The J. G., Co., Philadelphia.  
Griffin Wheel Co., Chicago.  
Kuhlman, The G. C., Car Co., Cleveland.  
McGuire-Cummings Mfg. Co., Chicago.  
Marshall, R. W., & Co., 95 Liberty St., New York.  
Railway Steel-Spring Co., St. Louis Car Co., St. Louis, Mo.  
St. Louis Car Wheel Co., St. Louis.  
Standard Steel Works, Philadelphia.  
Stephenson, John, Co., Elizabeth, N. J.  
Wason Mfg. Co., Springfield, Mass.
- Wheel Grinders.  
Wheel Truing Brake Shoe Co., Detroit, Mich.
- Window Fixtures.  
Drouvé, The G., Co., Bridgeport, Conn.
- Wiping Rags.  
Hagy, J. Milton, Waste Wks., Philadelphia, Pa.
- Wire, Aluminum.  
Aluminum Co. of America, Pittsburg, Pa.
- Wire, Insulated.  
Aluminum Co. of America, Pittsburg, Pa.  
American Electrical Works, Providence, R. I.  
General Electric Co., Schenectady, N. Y.  
Okonite Co., Ltd., 253 Broadway, New York.  
Standard Underground Cable Co., Pittsburg, Pa.  
Stuart-Howland Co., Boston.
- Wire and Cables.  
Aluminum Co. of America, Pittsburg, Pa.  
American Electrical Works, Providence, R. I.  
Bridgeport Brass Co., Bridgeport, Conn.  
General Electric Co., Schenectady, N. Y.  
Okonite Co., Ltd., 253 Broadway, New York.  
Standard Underground Cable Co., Pittsburg, Pa.

**STANDARD HIGH-SPEED "INTERBOROUGH" DOUBLE TRUCK**

TYPE C-60

**"Solid Forged"**

WITHOUT WELDS

FRAMES ARE MADE FROM ROLLED OPEN-HEARTH STEEL WITHOUT WELDS. ALL WEARING BOLTS ARE TURNED AND CASE HARDENED, AND WEARING HOLES STEEL THIMBLED. M. C. B. STANDARD PRINCIPLES ARE FOLLOWED. WE ARE PREPARED TO BUILD TRUCKS IN ACCORDANCE WITH PURCHASER'S DESIGNS AND SPECIFICATIONS.

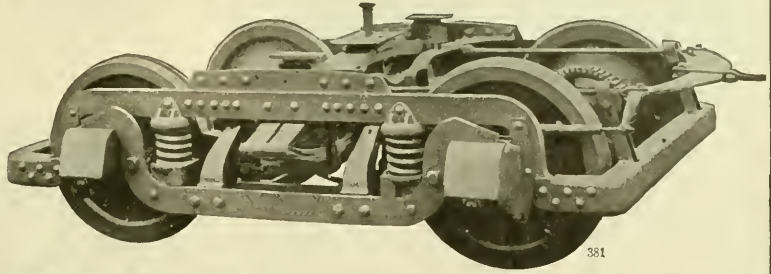

381

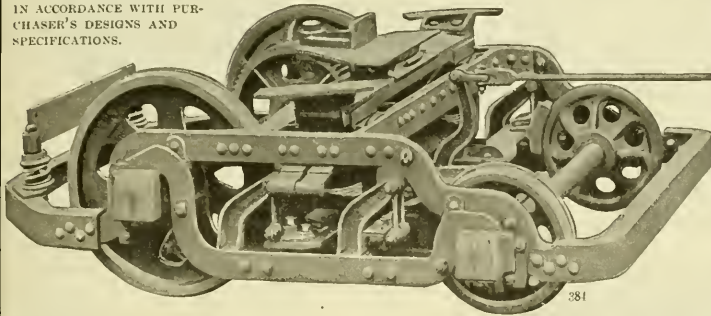

381

**STANDARD "MAXIMUM TRACTION" DOUBLE TRUCK**

CITY AND SUBURBAN TYPE O-45

OVER TWO HUNDRED OF THESE "MAXIMUM TRACTION" TRUCKS ARE IN SERVICE IN BROOKLYN, NEW YORK, AND ARE PRONOUNCED "HIGHLY SATISFACTORY."

STANDARD MOTOR TRUCK COMPANY, FRICK BUILDING, PITTSBURGH, PENNSYLVANIA  
 NEW YORK OFFICE: 170 BROADWAY WORKS: NEW CASTLE, PA. CHICAGO OFFICE: FISHER BUILDING

**OKONITE FEEDER WIRES FOR POWER TRANSMISSION.**

Whether overhead underground or submarine successfully meet the most exacting conditions of modern traction systems. Used by the most prominent Street Railways in the country.

**The Standard for Rubber Insulation**  
 Samples and Estimates on application

**THE OKONITE CO. Ltd., 253 Broadway, NEW YORK**  
 GEORGE T. MANSO, Gen'l Supt.; W. H. HODGINS, Secretary.

TRADE MARK REG. U.S. PAT. OFF.  
 WILLARD L. CANDLER, H. DURANT CHEEVER, MANAGERS.

You buy and scrap 25 per cent less material when you use  
**Ideal Trolley Wheels!**

Unlike the cast wheels you have used in many other important particulars, too. Write for detailed description.

Buffalo **LUMEN BEARING CO.** Toronto 2

**The Fred. J. Meyers Mfg. Co.** Hamilton, O.

Largest Manufacturers in the World of TICKET AND CONDUCTORS' PUNCHES

Send for catalog of 75 different styles of punches with 1000 different dies. Write for special prices.

Do you know the difference between  
**Motor Packing Waste**  
 and other kinds?

The service each renders, of course, proves the case. A sample order for enough **Motor Packing Waste** to pack a few motor boxes will show the difference.

All kinds of high-grade Wastes, Wiping Rags, etc.

**The J. Milton Hagy Waste Works**  
 433 Spruce Street Philadelphia 5

**ALUMINUM**  
**Railway Feeders**  
 And all kinds of **Electrical Conductors**

Aluminum Feeders are less than one-half the weight of copper feeders and are of equal conductivity and strength. If insulated wire or cable is required, high grade insulation is guaranteed.

Write for prices and full information.

**Aluminum Company of America**  
 PITTSBURGH, PA.  
 Formerly The Pittsburgh Reduction Company

# TUBULAR POLES IRON OR STEEL



FOR  
ELECTRIC  
RAILWAYS  
ELECTRIC  
LIGHTING CO'S  
SIGNAL) SER  
TELEPHONE (VICE  
TELEGRAPH)  
TRANSMISSION  
L I N E S  
AND  
CATENARY  
SUSPENSION  
L I N E S

**ELECTRIC RAILWAY EQUIPMENT CO.**  
General Office: CINCINNATI-O-U-S-A  
Shops: READING PA - WHEELING WVA

# U.S. Metal & Mfg. Co.

25 Broad Street, New York

Pittsburg, 1509 Arrott Bldg. Chicago, 414 Railway Exchange

## Columbia Lock Nuts

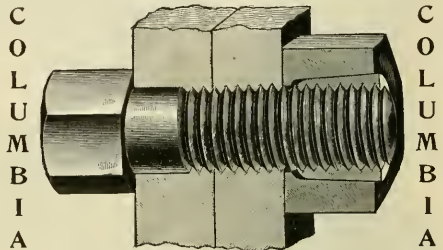

Columbia Lock Nut on Bolt

It is effective and indispensable on locomotives, pitmans, wrists, king bolts, rail joints, fish plates, piston rods, cylinder heads, steam pumps, and, in fact, all kinds of machinery. It is also invaluable on railroad cars, carriages, wagons, automobiles, axles, steam pipes, flanges, etc.

SEND FOR CATALOG AND PRICE LIST

# Pantasote

The National Standard for Car Cur-  
tains and Car Upholstery.

## AGOSOTE HEADLINING

The only headlining made in one solid piece. Will not separate, warp or blister. Waterproof and homogeneous.

## THE PANTASOTE COMPANY

707 Fisher Building, Chicago, Ill.

11 Broadway, New York

# NATIONAL

Curtain Fixtures  
Sash Locks Sash Balances  
and Nut Locks

COMPLETE CURTAINS

## The National Lock Washer Co.

NEWARK, N. J.

CHICAGO OFFICE: 419 Monadnock Block

# THE BABCOCK & WILCOX COMPANY

85 Liberty Street, New York

Babcock & Wilcox — Stirling — A & T Horizontal — Cahall Vertical

# WATER TUBE STEAM BOILERS

STEAM SUPERHEATERS

Works: Bayonne, N. J. Barberton, Ohio.

MECHANICAL STOKERS

BRANCH OFFICES:

BOSTON, Delta Bldg.  
PHILADELPHIA, 110-112 North American Bldg.  
SAN FRANCISCO, 63 First Street  
PITTSBURGH, Farmers Deposit Nat. Bank Bldg.  
NEW ORLEANS, 343 Baronne St.

DENVER, 410 Seventeenth St.  
SALT LAKE CITY, 313 Atlas Block  
WASHINGTON, Colorado Building  
CHICAGO, Marquette Bldg.  
ATLANTA, GA., 1132 Candler Bldg.

CLEVELAND, 706 New England Bldg.  
MEXICO CITY, 7 Avenida, Juarez  
HAVANA, CUBA, 116 1/2 Calle de la Habana  
LOS ANGELES, 321 Trust Bldg.  
CINCINNATI, O., Traction Bldg.



# Brown Hoist Electric Locomotive

## CRANES DO VALUABLE SERVICE IN LIFTING AROUND POWER STATIONS AND CAR HOUSES

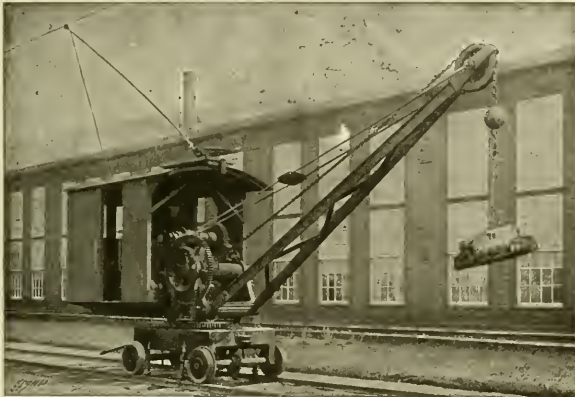

EVERY SORT OF HOISTING APPARATUS IS SHOWN IN OUR CATALOGUE

### THE BROWN HOISTING MACHINERY CO.

HAVEMEYER BLDG., NEW YORK

CLEVELAND, OHIO

FRICK BLDG., PITTSBURG, PA.

## RE-ENFORCED SPOKE WHEELS

For City and Suburban Cars

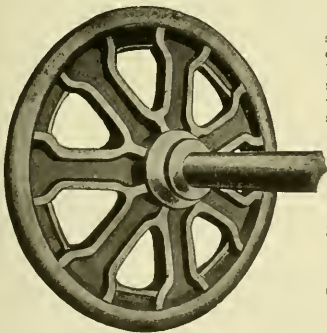

This wheel is being substituted in place of the Old Style Plate Wheel because it does not rumble and roar when on paved city streets.

The only spoke wheel for Heavy High Speed Service.

- Stronger Spokes
- Stronger Flange
- Deep, Even Chill
- Greater Mileage
- Absolute Safety

A Sample Order Will Prove Its Superiority Over the Old Style Spoke Wheel

WRITE FOR BOOKLET ON WHEELS

**ST. LOUIS CAR WHEEL CO.**  
ST. LOUIS, MO.

## THE Van Dorn & Dutton Co.

### CLEVELAND, OHIO

MANUFACTURERS OF

## GEARS AND PINIONS

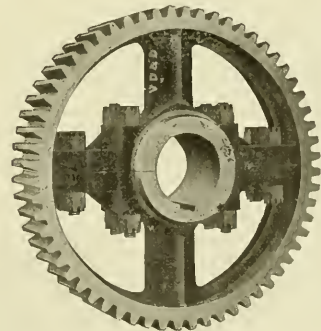

For All Types of Motors  
HIGHEST QUALITY

**THE ARNOLD COMPANY**  
 ENGINEERS-CONSTRUCTORS  
 ELECTRICAL - CIVIL - MECHANICAL  
 181 LA SALLE STREET  
 CHICAGO

**H. M. Bylesby & Company**  
 Incorporated  
 ENGINEERS  
 American Trust Bldg., Chicago

Design, Construct and Operate  
 Railway, Light, Power and  
 Hydraulic Plants

EXAMINATIONS AND  
 REPORTS

**J. G. WHITE & COMPANY**  
 INCORPORATED  
**Engineers, Contractors**

43-49 Exchange Place,  
 41-43 Wall Street

**New York, N. Y.**

Principal Philippine Office: Manila, P. I.

**Ford, Bacon & Davis,**  
**Engineers,**

115 BROADWAY,  
 NEW YORK.

**COLUMBIA CONSTRUCTION CO.**  
 BUILDERS OF  
**Electric Railways**

Colby and Abbot Building : MILWAUKEE, WIS.

**Surface, Jet and Barometric Condensers**  
**Edwards Air Pumps Centrifugal Pumps**  
**Water Cooling Towers**

Wheeler Condenser & Engineering Company  
 CARTERET, N. J.

90 West Street, NEW YORK Monadnock Block, CHICAGO, ILL.

**GREEN TRAVELING LINK GRATES**

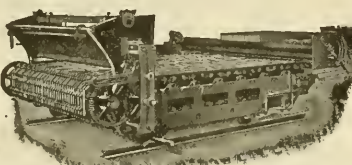

Highest Capacity  
 Highest Efficiency  
 Automatic Smokeless  
 Labor Saving  
 Cheap Fuel

**GREEN ENGINEERING CO.**  
 Main Office: Commercial National Bank Bldg., Chicago, Ill.  
 BRANCH OFFICES: Pittsburgh : St. Louis : St. Paul : Louisville  
 General Foundry Work a Specialty

**A. L. REGISTER & CO.**  
 Engineers and General Contractors—Electric Railway  
 112 North Broad St. PHILADELPHIA, PA. Established 1889

**SHIMER & CHASE CO.**  
**Experienced Promoters of Electrical Railway Projects**  
 Correspondence Solicited OMAHA, NEB.

**CENTRAL INSPECTION BUREAU**  
 Inspection of Rails, Ties, Cars, Motors, Bridges, Buildings, Etc.  
 17 STATE STREET - - - NEW YORK CITY

**LINE MATERIAL**  
 ELECTRIC SUPPLIES FOR RAILWAYS, POWER PLANTS, ETC.  
 THE CREGHEAD ENGINEERING CO., 348 Main Street, Cincinnati, Ohio

**THE CURTAIN SUPPLY CO.**  
 CAR CURTAINS  
 CHICAGO, 85-93 Ohio Street 1819 Park Row Bldg., NEW YORK

**HARTSHORN'S SPRING SHADE ROLLERS**  
 Used the World Over Wherever Cars are Run  
 STEWART HARTSHORN CO.  
 EAST NEWARK, N. J.



**HOT WATER HEATERS FOR CARS**  
 THE PETER SMITH HEATER COMPANY, Detroit, Mich.

**AUTOMATIC TROLLEY GUARD CO.**  
 391-393 Ellicott Square, Buffalo, N. Y.  
 "IT PUTS THE WHEEL ON THE WIRE"

WRITE TO **MODEL STOKER COMPANY** DAYTON OHIO  
 for detailed information about the best  
**AUTOMATIC SMOKELESS FURNACE**

**ELECTRIC HEATERS** For All Classes of Cars  
 New York **Consolidated Car-Heating Co.** Chicago

**WHEEL TRUING BRAKE SHOES**  
 Repair Crippled Wheels While Running  
**THE WHEEL TRUING BRAKE SHOE CO.,** Detroit, Mich.

SPRINGS—TIRES—STEEL-TIRED WHEELS  
**RAILWAY STEEL-SPRING CO.**  
 General Offices: 71 Broadway, New York

**HART CONVERTIBLE BALLAST, GONDOLA AND CONSTRUCTION CAR**  
 RODGER BALLAST CAR CO., Railway Exchange, CHICAGO

**GRIFFIN WHEEL CO.**  
 CHICAGO  
 CHILLED IRON CAR WHEELS IRON OR STEEL AXLES

**HEINE SAFETY BOILER CO.**  
 421 OLIVE STREET, ST. LOUIS, MO.  
 Manufacturers of WATER TUBE BOILERS

**TRACKLAYING BY MACHINERY**  
 SIMPLE, RAPID AND ECONOMICAL  
 D. F. HOLMAN RAILWAY TRACKLAYER CO., 1102 Ellsworth Bldg., Chicago

## Electrical Transmission Lines

Typical sections of a 40 mile electrical transmission line which we designed and built are shown in the accompanying photographs. This line carries 10,000 K. W. of electrical energy, at 50,000 volts pressure, from St. Croix Falls, Wis., to Minneapolis, Minn., where it is used, a distance of about forty miles.

In the designing and construction of electrical transmission lines and distributing systems of any magnitude, in any part of this or foreign countries, our services are at your disposal.

After the inception of the project we relieve you of every detail in its execution. We first make preliminary reports and estimates, then design the plant in all details, select and buy land or right-of-way, purchase equipment, construct the plant and finally turn it over to you ready for operation.

Under the provisions of our contract—based on cost plus a fixed sum or cost plus a percentage—we become your agent, safeguarding your interests at all times.

If you are interested in electrical transmission design and construction, write us for further information.

### Stone & Webster Engineering Corporation

Constructing Engineers

147 Milk Street, Boston, Mass.

We are prepared to design and construct water power developments, power stations, industrial buildings, railways, electrical transmission lines and distributing systems, either new work or extensions. Correspondence invited.



**Steel Tower Construction for Long Spans**



**Typical Railroad Crossing**

## Electric Railway Lubrication

THE same skillful expert supervision given in this service as in steam railway service has produced most satisfactory results. Lower cost of lubrication with better service.

We are under contract with many of the largest Street and Interurban railways in the country.

We guarantee cost per thousand miles in Street and Electric Railway Service when conditions warrant it.

Including both Rolling Stock and Power House Equipment

Write for further particulars.

**Galena-Signal Oil Company**  
FRANKLIN, PENNSYLVANIA

## Shawmut Soldered Bond Cap

to make over your  
**PLUG BONDS**



Why not look this up

**CHASE-SHAWMUT CO.**  
Newburyport, Mass.

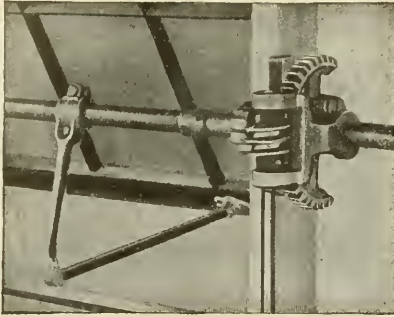

## The Ventilation

of your Shops, Foundries and Car Barns is made especially effective by a speedy, positive and easily manipulated **Sash Operating Apparatus** which automatically locks the sash at any position.

*Let us send you our catalogue.*

**Lord & Burnham Company**  
Irvington-on-Hudson, N. Y.

**W**HEN a salesman calls on you for the purpose of selling you material or supplies, you expect him to show you how and why it is to your advantage to use his goods.

Is there any reason why you should not use as much care in pointing out to your patrons, or those who should be your patrons, the attractions and advantages of your road and your service as does the successful salesman in presenting the strong points of his goods?

The **Van Valkenburgh Advertising Service** applies the methods of the successful salesman in calling the attention of the public to your commodity—transportation.

Let's get together.



**E. C. Van Valkenburgh**  
**Promotional Advertising**  
**for Electric Railways**  
2117 West 102d Street, Chicago

## "Not an Experiment"

The **Providence Fender** is the **Children's Fender**.

It is equally as effective in saving a child, and the person who has stumbled, as it is in saving those who are on their feet.

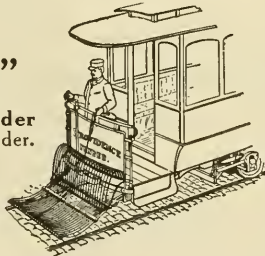

**CONSOLIDATED CAR FENDER COMPANY**

Office and Factory: PROVIDENCE, R. I.  
Branch Office: 110 E. Twenty-third St., New York  
European Agents: Comptoir d'Electricité, 6, Rue Boudreau, Paris, France

Your gear and pinion cost can be reduced over one-half by lubricating them with

## Whitmore's Gear Protective Composition

We can prove this by roads that are using it. Give us an opportunity to demonstrate the merits of our product.

**The Whitmore Manufacturing Company**  
LUBRICATING ENGINEERS  
Cleveland, Ohio, U. S. A.



Factory of The Milloy Electric Company  
Bucyrus, Ohio

## The Milloy Trolley Base

built in our new and specially equipped factory, insures a quality which will give excellent service under ordinary and extraordinary conditions.

The Milloy Base is unusually low, has even tension on high or low wire. Has no fulcrum, no friction, no oil, no center post. Always efficient. Particulars on request.

**THE MILLOY ELECTRIC COMPANY**  
Bucyrus, Ohio

## Hydraulic Jacks

We have every type of hydraulic jacks which are necessary for railway work, whether it be for machine shop, construction work, wrecking car, locomotive or car shop or pit work.

Every tool a perfect one and thoroughly guaranteed.

*Send for Jack Catalogue No. 68*



**THE WATSON-STILLMAN CO.**  
26 Cortlandt Street, New York City  
Branch Office: 453 The Rookery, Chicago, Ill.

# FOR SALE. FOR QUICK DELIVERY

## 6 55-ft. Passenger, Baggage and Smoking Car Bodies

Main Compartment 26' 0"  
 Smoking " 10' 6"  
 Baggage " 10' 0"  
 Seating Capacity, 54

## 8 60-ft. Passenger, Baggage and Smoking Car Bodies

Main Compartment 28' 6"  
 Smoking " 11' 0"  
 Baggage " 8' 0"  
 Seating Capacity, 58

## 5 52-ft. Passenger and Smoking Car Bodies — Double End

Seating Capacity, 60

## 3 52-ft. Passenger and Baggage Car Bodies — Double End

Seating Capacity, 56

## 2 50-ft. Express Car Bodies

*Write or wire us for further information.*

**The Jewett Car Co.** Newark Ohio

**THE MIGHTY MIDGET**

## HOT WATER CAR HEATER

Adapted for Large Electric Cars and Long Distance Lines. Exclusively used on Largest Electric Systems. Ask for Catalog

**THE WILLIAM C. BAKER HEATING & SUPPLY CO.,** 143 LIBERTY STREET NEW YORK



## NILES CARS — THE ELECTRIC PULLMANS

LARGE, FAST INTERURBANS  
 OUR SPECIALTY

## NILES CAR & MFG. COMPANY

WORKS: NILES, OHIO  
 Sales Office: J. A. HANNA CO., 312 Electric Bldg., Cleveland, O.

# WHARTON SPECIAL TRACK WORK

OF EVERY DESCRIPTION  
 FOR ALL CLASSES OF SERVICE

**WM. WHARTON JR. & CO.**  
 INCORPORATED.  
 PHILADELPHIA, PA. JENKINTOWN, PA.

**MANGANESE  
 STEEL  
 TRACK WORK  
 IS OUR SPECIALTY**

### Baldwin Locomotive Works

BURNHAM, WILLIAMS & CO., PHILADELPHIA, PA., U. S. A.



Builders of  
**LOCOMOTIVES**  
of every description  
including  
**ELECTRIC  
LOCOMOTIVES**

**ELECTRIC TRUCKS**

### Standard Steel Works Co.

HARRISON BLDG., PHILA., PA., U. S. A.

New York, N. Y. Cleveland, O. St. Louis, Mo. Denver, Colo.  
Portland, Ore. Richmond, Va. Chicago, Ill. St. Paul, Minn.  
San Francisco, Cal. Seattle, Wash. Winnipeg, Can.

**Solid Forged  
Rolled and Steel Tired Wheels**

Mounted on axles fitted with Motor Gears  
for Electric Railway Service.

**LOCOMOTIVE TIRES RAILWAY SPRINGS  
FORGINGS CASTINGS**



THE RAILWAY SPECIALTY  
AND SUPPLY CO.

SMITH NUTS FOR MOTOR BEARINGS

Great Northern Building  
CHICAGO

## FOSTER SUPERHEATERS

PREVENT CONDENSATION IN LONG STEAM PIPES.

**POWER SPECIALTY COMPANY**  
111 Broadway, New York



CONTINUOUS JOINT

Over  
25,000  
miles  
in use



WEBER JOINT

Rolled  
from  
Best Quality  
Steel



WOLHAUPTER JOINT

Catalogs at Agencies  
Baltimore, Md. Portland, Ore.  
Boston, Mass. Seattle, Wash.  
Chicago, Ill. St. Paul, Minn.  
Denver, Colo. St. Louis, Mo.  
Pittsburg, Pa. Troy, N. Y.  
London, Eng. Montreal, Can.

HIGHEST AWARDS—Paris, 1900;  
Buffalo, 1901; St. Louis, 1904

Additional safety and economy in **Track Maintenance** has been proved by the use of Continuous, Weber and Wolhaupter base-supported rail joints—after ten (10) years' service, having a record of over **25,000 miles in use**—the extent of which is evidence of their excellence.

### THE RAIL JOINT COMPANY

General Offices: **29 West 34th Street, New York City**  
Makers of Rail Joints for Standard and Special Rail Sections, also Girders, Strap or Compromise, and Insulating Rail Joints, protected by patents in United States and Foreign Countries.

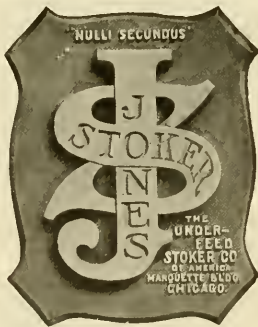

## PIPE FITTINGS AND VALVES

FOR THE  
HEATING AND PLUMBING TRADE

TRADE  MARK

**JOHN SIMMONS Co.**  
104-110 Centre Street, NEW YORK

**IF YOU** wish to keep posted on all steam railway matters you must read **THE RAILWAY AGE**, for it is the leading railway journal of the world and the only one that covers all phases of the industry.

Sample copies sent on request.

**THE RAILWAY AGE**  
160 HARRISON STREET CHICAGO

**Ticket Punches**  
of every kind to meet your requirements fully.  
*Write for description and prices.*  
**R. WOODMAN MFG. & SUPPLY CO. 1**  
53 Oliver St., Boston, Mass., U. S. A.



**PATTEN TICKET DESTROYER**  
Don't burn your used tickets. Destroy them, and avoid fraud. Remember, it is difficult to get a man to destroy anything of value to him. Sell the old stock—it will soon pay for machine.  
In use on the Boston & Northern R. R., Old Colony St. Ry. Co., Brockton St. Ry. Co., Waterbury R. Co., Bridgeport Traction Co., Buffalo Ry. and others.  
*Write for circular.*  
**PAUL B. PATTEN**  
78 Lafayette Street - SALEM, MASS., U. S. A.



**THE Bellamy Vestlette**  
For Street Railway Conductors  
**ABSOLUTELY SAFE. Money cannot be lost or stolen from these pockets OVER 150,000 IN USE**  
Saves the price of a coat yearly. Conductor's uniform always presentable. Adopted as a part of the uniform by over 200 Street Railway Companies. Price \$2.50, sent to any address prepaid, where we have no agent. Agents wanted on every line.  
**The Bellamy Vestlette Mfg. Co., Cleveland, O.**  
and A. F. JURY, 265 Yonge St., Toronto, Canada  
Patented April 7, 1897



**DESIGNS for ADVERTISING**      **BIRDS EYE VIEWS**



**HALF TONES**  
Photographing Machinery  
& Retouching ART PRINTING  
**WODBURY CARLTON & CO.**  
WORCESTER, MASS.

**Gasoline Motor Cars for Street Car Service**

Can be used advantageously for owl car service and on branch lines of large railroads where the passenger traffic does not warrant the maintenance of a regular train schedule.

*Address R. R. Dept. No. 757 MS.*

**Fairbanks, Morse & Co.**  
CHICAGO, ILLINOIS

**RAIL BOND Maintenance.**

The SEMI-PLASTIC PLUG RAIL BOND is applied on either Girder or T Rail without disturbing the pavement or removing the angle plates.

The condition of the Bond can be determined by a track walker from its appearance.

Its conductivity is 900,000 c. m., which can be maintained at a trifling expense without removing Bond.

Cheaper in first cost than No. 4/o copper bond and more easily applied.

*Write for details.*

**HAROLD P. BROWN,**  
120 Liberty Street, New York, N. Y.

**WESTERN ELECTRIC COMPANY**

CHICAGO    DENVER    ST. LOUIS    NEW YORK  
SAINT PAUL    SALT LAKE CITY    PHILADELPHIA  
SAN FRANCISCO    SEATTLE    LOS ANGELES    KANSAS CITY

**ELECTROSE**  
TRADE MARK.

INSULATED  
**RAILWAY**  
LINE  
**Material**



We carry a complete stock and make immediate deliveries.

*Write today for our catalogue.*

**Western Electric Company**

Chicago    New York    Philadelphia    Pittsburgh    St. Louis  
Saint Paul    San Francisco    Los Angeles    Seattle    Kansas City  
Denver    Cincinnati    Atlanta    Salt Lake City

# CLASSIFIED ADVERTISEMENTS

Undisplayed advertisements are inserted under this heading at the uniform rate of one cent a word; minimum charge twenty-five cents. Replies directed to this office will be forwarded when required to any address in the United States, Canada or Mexico without extra charge. Advertisements received at the Chicago office by 9 a. m. Thursday will appear in the issue for the same week.

## POSITIONS WANTED.

Expert street car electrician, city or interurban lines, desires a change. Fifteen years' experience; capable handling men; also railway park manager. Now with a large railway. Address "No. 578," care of Electric Railway Review, Chicago.

Management of street railway amusement park wanted; experienced, up-to-date, sober and reliable. Park playing vaudeville and bands preferred. Experienced in park designing and construction. Best of references. Don't put it off, write me today. Address E. E. Wilmarth, Massillon, Ia.

Experienced electrical engineer wants position with manufacturing concern or with company operating electric railways. Graduate Purdue University, 1905. Will go anywhere for permanent position. Age 26; married; A No. 1 references as to habits and ability. Address "No. 570," care of Electric Railway Review, Chicago.

Master mechanic of undeniable ability and experience is at liberty to accept reasonable offer. Has had 15 years' experience in both steam and electric service. Has exceptional ability in equipping new rolling stock and handling shops and men on economical basis. Address "No. 560," care of Electric Railway Review, Chicago.

Transportation man of seventeen years' experience, young, reliable and thoroughly familiar with organization, dispatching and timetable work, desires a position as superintendent or one of equal responsibility. Highest references regarding character, ability and past service. Address replies to "No. 577," care Electric Railway Review, Chicago.

Position as superintendent or assistant to general manager wanted. Eighteen years' experience in railway work. For the last six years have been superintendent of an electric railway company. Can get best of references from present employers. Can also give good reason for wishing to make change. Address "No. 572," care of Electric Railway Review, Chicago.

## POSITIONS WANTED.

Detective, thoroughly experienced all-round inside man, open for engagement. Best of references. Address "No. 574," care of Electric Railway Review, Chicago.

Position as chief engineer and machinist wanted. Will go to responsible company on trial. Have had 26 years' practical experience. Address "No. 563," care of Electric Railway Review, Chicago.

Wanted—A young man experienced in street railway and electric light accounting desires position as auditor. Best of references as to character and ability. Address "No. 572," care of Electric Railway Review, Chicago.

Position as chief clerk or auditor by young single man with seven years' experience in electric railway work. Good knowledge of operating departments; exceptional references. Address "No. 558," care of Electric Railway Review, Chicago.

Wanted—To correspond with company needing the services of high-class general manager or general superintendent. Electrical and civil engineer; 17 years' experience with large properties and in construction and operation. Address "No. 568," care of Electric Railway Review, Chicago.

An experienced supply salesman, who also has had thirteen years' operating experience on city lines, desires to form co-house handling either electric or steam supplies or both. Would consider proposition to open sales agency. Address "No. 566," care of Electric Railway Review, Chicago.

Young man familiar with overhead construction of all kinds (including catenary), installation of transformers, lighting, telephones and substation work; also some experience on car and switchboard work, desires position with city or interurban road. Employed but desires change. Best of references. Address "No. 576," care of Electric Railway Review, Chicago.

## POSITIONS WANTED.

Position wanted as auditor and accountant. Sixteen years of steam, electric and general experience; good working knowledge of details of general contracting business; clever buyer; possess ability to organize. Can furnish first-class reference as to character and ability and work accomplished in past; leaving present work because closed; at liberty to accept position any time. Address "No. 575," care of Electric Railway Review, Chicago.

## POSITIONS OPEN.

Park superintendent wanted. State experience and salary wanted; also give references. Address "No. 561," care of Electric Railway Review, Chicago.

Salesmen with technical knowledge, machinery and electrical installation, also auditors and accountants. Salaries \$1,200 to \$6,000. Ambitious men write us, I.A.P.G.O.O.S., 305 Broadway New York, or 1010 Hartford Bldg., Chicago.

A thoroughly competent superintendent wanted to take charge of 163 miles of electric railway track and overhead work. Must be fully conversant with latest developments in track and overhead work. Send full particulars regarding experience, age and salary required. B. C. Electric Railway Co., Ltd., Vancouver.

## BUSINESS OPPORTUNITIES.

Wanted—Man with some capital and a knowledge of railway track supplies to join the advertiser—a salesman handling locomotive and car supplies—in a general railway supply business. Address "No. 558," care of Electric Railway Review, Chicago.

Recharging Dry Batteries, the only book ever published giving complete directions of how to prepare chemicals for renewing dry batteries. If you are not more than pleased with this book your dime back. Large electric catalogue and book postpaid, 10 cents. Adams Electric Co., Dept. E. R., Kewanee, Ill.

## MISCELLANEOUS WANTS.

Want to buy second-hand equipment, machinery or material? A card inserted in the Electric Railway Review, stating just what you want, will bring immediate response. The cost is small—only \$1.20 an inch (measuring 1 inch deep by 1½ inches wide) per insertion. Send orders to Electric Railway Review, 160 Harrison St., Chicago.

What have you to sell in the way of second-hand equipment, machinery or material? Buyers read the "For Sale" cards on the following page and there is the place to tell your story. "For Sale" cards are inexpensive—only \$1.20 an inch (measuring 1 inch deep by 1½ inches wide) per insertion. State rates on contracts for 100 inches or more to be used within one year. Now is the time to send your order to Electric Railway Review, 160 Harrison St., Chicago.

## BOOKS AND PUBLICATIONS.

Wanted—Copies of the Street Railway Review of July 20, 1904, and June, 1906. State condition and price. Address "No. 567," care of Electric Railway Review, Chicago.

Wanted—Copies of the Street Railway Review of April, 1903, May, 1901, and August, 1903. State price and condition. Address "No. 553," care of Electric Railway Review, Chicago.

Interstate commerce national legislation to July 1, 1906, is fully covered in our reference pamphlet. It contains the full text of the act to regulate commerce as amended, including the Elkins and Hepburn acts, and of the supplementary act relating to the testimony of witnesses before the interstate commerce commission. It also contains the texts of the expedition act, the anti-trust act of 1890, the interstate liability act and the safety equipment laws. Difference in type shows the parts expunged from, and the parts added to, the interstate commerce and Elkins acts by the Hepburn act. This pamphlet is of special value to railway men and lawyers. Mailed prepaid for 25 cents in stamps or coin. Special prices for quantities. The Wilson Company, 160 Harrison St., Chicago.

**W. MARSHALL & CO.**  
95 and 97 Liberty St., New York  
Second-Hand Machinery and Equipment  
**ELECTRIC RAILWAY MATERIALS**

Rare Bargains in  
**RAILS and  
EQUIPMENT**  
WALTER **ZELNICKER** SUPPLY  
A. CO.  
In ST. LOUIS  
DO YOU RECEIVE OUR STOCK LISTS?

**NO SNOW TO DELAY CARS**  
The Russell Snow-Plow is used by more than 50 roads to maintain schedules and prevent blockades.  
Russell Car & Snow-Plow Co., Ridgway, Pa.  
Wendell & MacDuffie, Cortlandt St., New York; C. A. Ralston, Fisher Bldg., Chicago; Robinson & Cary Co., Saint Paul.  
**IF YOU HAVE A RUSSELL**

**FOR SALE: Three Car Bodies  
and Three Pairs of Double Trucks**  
with or without electric equipment and air brakes; all new and never used. Compelled to sell, as these cars will not operate over a leased line by reason of their width and length.  
**R. W. MARSHALL & CO., 97 Liberty St., New York, N. Y.**

**Send Us Your Book List**  
We publish a number of standard works on railway and allied subjects, both electric and steam. We sell all that are in print. Write us.  
**The Wilson Company** 160 Harrison Street  
CHICAGO



**CAR ADVERTISING**  
*Barron & Collier*  
**ALMOST EVERYWHERE**  
*Flat Iron Building, New York.*

**Poles and Ties**  
 A Selected Stock in Chicago for Rush Shipment  
 A Number of Large Yards in the North  
**NAUGLE POLE & TIE CO.**  
 CHICAGO OFFICE: 226 LA SALLE STREET

**VALVES—FITTINGS—STEAM SPECIALTIES**  
**CRANE CO.**  
 CHICAGO  
 ESTABLISHED 1855

We are Producers and Wholesale Dealers in Western  
**CEDAR POLES**  
 Yards in Washington, Idaho, Montana  
 and British Columbia  
 WRITE US FOR DELIVERED PRICES  
**CHURCHILL CEDAR CO.,** Box 1409, Spokane, Wash.

If you want **POLES** Michigan or  
 good Western Cedar  
 at the right prices and prompt delivery, write us.  
**NATIONAL POLE COMPANY**  
 EVERETT, WASH. ESCANABA, MICH.

**Idaho Cedar Poles**  
 PACIFIC COAST POLE CO. SPOKANE, WASH.

**C. H. WORCESTER CO.**  
**CEDAR POLES**  
 PRODUCERS AND WHOLESALERS  
 Suite 1718 Tribune Building CHICAGO

**For Sale** Cards produce results in the  
 Electric Railway Review

**G. H. BARNES HARDWOOD LUMBER CO.**  
 Office and Yard: Main and Watson Sts., ST. LOUIS, MO.  
 Ties, Car Oak, Poplar, Ash, Cherry, Plain and Quartered Oak

**POLES and PILING** 20,000 35s and 40s, Ready to Ship at Once  
 S.-E. MISSOURI CYPRESS CO., CAMPBELL, MO.

**The Lindsley Brothers Company**  
 Producers and Shippers of **WESTERN CEDAR POLES** and Manufacturers of **RED FIR CROSS ARMS**  
 Eastern Sales Office, Monadnock Bldg., CHICAGO SPOKANE, WASHINGTON

**“For Sale” and “Wanted” Cards**  
 especially for the marketing of second-hand equipment, machinery, material, etc., are carried on this page at a uniform rate of **\$1.20 an inch** (measuring 1 inch deep by 1 1/2 inches wide) **per insertion.** Send orders to  
**Electric Railway Review**  
 160 Harrison Street - - - CHICAGO

Special rates made on contracts covering 100 inches or more.

# ROLLING DOORS

In Steel, Wood or Bronze

FOR CAR BARNS, FREIGHT SHEDS, ETC.

Made by the

## JAS. G. WILSON MFG. CO.

New York Office: 3 W. 29th Street

ESTABLISHED 1876

Incorporated 1903

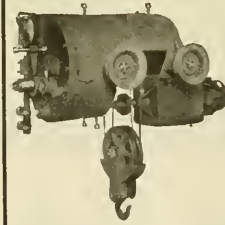

# NORTHERN CRANES

AND ELECTRIC HOISTS

for your Power Plant,  
Car Shop or Barns. Air  
Hoists and Air Jacks.

CATALOGS FREE

NORTHERN ENGINEERING WORKS. DETROIT, MICH.

OVERHEAD TRACK AND TROLLEY SYSTEMS



Established 1877.



## ALBERT & J. M. ANDERSON MFG. CO.,

Makers of

**ELECTRICAL APPLIANCES:**  
SWITCHES, SWITCHBOARDS,  
TIME SWITCHES, LINE MATERIAL,  
COPPER CASTINGS (75% CONDUCTIVITY).  
289-293 A ST., BOSTON, MASS., U. S. A.

Branches:

New York, 135 Broadway. Chicago, 175 Dearborn Street.

Agencies:

Boston, Pettingell-Andrews Co. San Francisco, Eccles & Smith Co.  
New York, R. W. Marshall & Co. Atlanta, Newcomer-Manly Co.  
St. Louis, J. C. White. Denver, E. M. Messiter.

Toronto, Ont., H. J. Surtees.



## Black Air-Drying Varnish

—for quick repairs to dynamos and motors, air-cooled transformer coils, magnet coils, underframe work of cars, etc. Invaluable in the shop where baking facilities are not available. It forms a tough, elastic, odorless coating, is easily applied with a brush, and withstands overheating, water, snow and sleet.

We have an interesting booklet for you.

**The Standard Paint Co.** 100 William Street  
Chicago St. Louis Kansas City Boston Philadelphia New Orleans

# Independent Investigation

of the modern bonding and rebonding methods

## Electric Brazing and Copper Welding

will prove the truth of our claim

→that they are the only methods of reasonable cost producing perfect mechanical and electrical union of bond and rail, and possessing long life.

We will gladly send the names of users upon your request. Then ask what they think.

### THE ELECTRIC RAILWAY IMPROVEMENT COMPANY

6005 Carnegie Avenue

CLEVELAND, OHIO



# Electric Railway Review

PUBLISHED EVERY SATURDAY BY THE WILSON COMPANY, CHICAGO

Entered as second-class matter January 5, 1907, at the postoffice at Chicago, Ill., under the act of March 3, 1879.

160 Harrison Street, Chicago  
150 Nassau Street, New York  
1529 Williamson Bldg., Cleveland

VOL. XIX  
No. 15

CHICAGO, APRIL 11, 1908

Whole No.  
259

Subscription: Domestic . . . \$2  
Foreign . . . \$5  
Canada . . . \$3.50

The location of a repair shop largely dictates the arrangement of tracks that can be used to serve the shop. The track layouts of nearly all of the larger shops recently built confirm the idea that it is an especially good plan to have as many tracks as possible extend through a shop from end to end. In this issue is described a new shop recently equipped for the York Railways Company in Pennsylvania. The general arrangement of this shop probably is as simple as could be desired and combined with this simplicity the builders have wisely extended all of the tracks through the entire length of the shop building and out at the rear, where they join a loop track extending around the shop yards. The possibilities for blocking the shop tracks are thus reduced to a minimum.

## Through Shop Tracks.

At two recent hearings regarding fare increases on the cross country electric lines serving Natick, Ashland and the Taunton-Pawtucket territory in Massachusetts before the railroad commission, very little opposition has developed when the earnings and expenses of the companies have been appreciated by the public. At a hearing on the Natick increase from five to six cents on March 31 only one objector appeared, and at a hearing held on April 1 the opposition almost entirely disappeared when the deficit of the Taunton & Pawtucket Street Railway was exhibited. At the latter hearing a large opposition was expected on account of the increase in fare from Taunton to Attleboro. Testimony showed that the company was giving a low rate between Attleboro and Pawtucket because of the existence of a competing line, while charging a high rate between Attleboro and Taunton in the absence of competition, and it was also maintained that the increase was contrary to the franchise agreement. When W. P. Hall, chairman of the commission, read from the company's returns, showing that a deficit of \$3,000 a year ago was increased to \$8,000 by the operations of the last year, City Solicitor Hathaway stated that this was a sufficient answer to the question whether the fares ought to be raised. The commission will consider the matter, but intimated that some increased revenue in all probability would have to be allowed.

The threatened destruction by fire of the Sullivan square terminal in Boston last week emphasizes again the value of preventive measures in all kinds of electric railway property. It ought to be needless at this time to review in detail the precautions which experience has shown to be wise under the varying conditions of service which characterize power plants, car houses, shops and stations. To a large degree the protection of each piece of property is a special problem. The money loss at Boston was so slight and the element of personal damage so entirely absent that there would be no object in this reference if it were not for the fact that in many parts of the country electric roads are far less careful to anticipate the occurrence of a fire and the conditions are such as to simply invite disaster.

## Electric Railway Fire Hazards.

We do not propose at this time to reprint the numerous precautions which have been laid down from time to time by expert fire protection engineers for the special guidance of electric railway men, but in congratulating the Boston Elevated upon its good fortune we take the opportunity to urge the most careful study of the fire hazard by all roads that have not paid any special attention to the subject within the last few months.

Handling and adjusting claims is mysterious work. We see the claim agent go here and there apparently fulfilling his allotted duties, and not until a release can be exhibited is there any certainty that his work will result for the best. The qualities which it is desirable that a claim agent should possess have been defined before, but his methods of work are seldom published. One who has been benefited by training in the school of experience may place before the young man in claim work certain precepts which, if followed, will assist him greatly in his chosen field. Frederick W. Johnson, assistant general claim agent of the Philadelphia Rapid Transit Company, is so qualified. Beginning with this issue he presents in the Electric Railway Review the first instalment of a series of four articles addressed to the young man in claim work. To those electric railway employes aspiring to advancement, no matter whether it be in the claim department or elsewhere in the organization, we heartily recommend a careful reading of these "Short Talks with the Claim Investigator." The arguments follow lines somewhat different from any that heretofore have appeared in connection with claim work and departmental harmony in general. They touch on phases which should prove of vital interest to any young man who is ambitious to make a success in his branch of electric railroading. Lastly, probably the most important factor is, that these talks are the result of several years' careful thought upon the subject by their author.

Talks with the Claim Investigator.

In connection with the announcement of the New York City Railway of its intention to install automatic fare collectors on its new pay-as-you-enter cars as soon as the public has become reasonably familiar with the principal innovation—the cars themselves—some remarkable figures have been given out by officers of the company regarding the practice of "knocking down" fares. In 1904, it is stated, 3,017 conductors were discharged for alleged failure to account for fares; in 1905 2,448; in 1906 3,924; and in not quite the entire year 1907 5,584. The average number of conductors in the employ of the company is 3,000. The figures for 1907 indicate, therefore, that nearly twice as many men were discharged for this reason as the total number required for the service. By way of exposing a more serious feature of the situation the additional information was given that a large number of men who, the company believes, are not turning in all fares are retained because of the uncertainty of obtaining others in their places who would do any better. It is not claimed that all of this leakage in receipts is due to dishonesty on the part of conductors; yet

Collecting All the Nickels.

it is impossible to determine how much is due to other causes. As a matter of fact, the question is one which larger cars with good facilities for entrance and exit and operated under a headway established under a knowledge of the fairly regular fluctuations of traffic, should remedy. This is already apparent from observation of the new large cars on Madison avenue. It is fair to presume that the results in receipts reaching the company will increase in a ratio commensurate with the improvement in equipment and service. With adequate facilities for the seating of passengers the automatic fare collector will undoubtedly go far toward securing the nickels and making the service even at its present rate of remuneration attractive to the right class of men. That the importance to the company of establishing such a condition of affairs is great is indicated by the estimate that the loss amounts to 10 per cent on gross earnings, or \$2,000,000 a year.

#### JOINT RATES WITH STEAM ROADS.

The conviction has been general with officials of electric railways that in any case involving both a steam and an electric road the interstate commerce commission would decide in favor of the steam line. This impression was strengthened by the decision of the commission denying the petition filed by the Chicago & Milwaukee Electric Railroad for joint rates and through routes with the Illinois Central Railroad.

The commission now, however, has rendered a decision which gives approval to the petition of the Cedar Rapids & Iowa City Railway & Light Company for a joint traffic arrangement with the Chicago & Northwestern Railway, a steam road. Under the decision of the commission the latter railway is directed to establish joint rates with the Cedar Rapids & Iowa City line on or before April 25 and to maintain them for at least two years.

The decision of the commission, rendered by Commissioner Harlan, is not inconsistent with its position as outlined in the case concerning the Chicago & Milwaukee Electric road. The circumstances governing the two cases are different. The Chicago & Milwaukee Electric road parallels steam lines which testified that the service they afforded to shippers of cabbages was adequate. The commission accepted the evidence of the steam railways upon this point and concluded that congress did not intend "to aid carriers to acquire strategic advantages in their contests with one another." Counsel for the electric road in that case contended that the intent of the law was that the commission might prescribe through routes and joint rates provided that no reasonable and satisfactory through route existed for the carrier which complained, but the commission held that the law intended to refer to a reasonable and satisfactory through route for the neighborhood in which the carrier was located.

The Cedar Rapids & Iowa City road went into the suit with the distinct advantage that it served a territory which was not reached by any other existing roads, steam or electric. It owns a right of way between the two cities the names of which are included in its title. The two cities are 27 miles apart. The defendant steam company admitted that the roadbed of the electric line conformed to the standard usual with the smaller steam railways in that section of the country, and that the bridges and culverts were constructed on plans practically identical with those used by the steam railway in similar structures on its line.

The commission concluded that the position of the Cedar Rapids & Iowa City road, serving several communities which desired the benefits of through routes and joint rates and had no other transportation facilities to depend upon, was very different from that of the Chicago & Milwaukee Electric road, which desired to secure joint arrangements for the benefit of several shippers who had only small loading platforms.

In parts of the country where the electric railway mileage

is extensive and connections between different companies using the same motive power can be arranged easily it will be desirable to negotiate for such interchange of business as can be demonstrated will be profitable, rather than to attempt to force recognition by steam railways, which are usually parallel lines or connections of parallel steam lines. Where electric lines, however, are in need of joint arrangements which can be secured only through connecting steam railways the decision opens a way of which they should not fail to take advantage.

#### AN ALL-DAY RIDE FOR FIVE CENTS.

"I can neither pay wages nor buy supplies with transfer tickets. They are of no use whatever to the Third Avenue Railroad," ironically wrote F. W. Whitridge, the receiver, in his petition to Judge Lacombe of the United States circuit court, New York, for permission to discontinue transfers with the New York City Railway.

Mr. Whitridge sent with his petition a letter he had received from a friend whom he had asked to see how far and how long he could ride for a single fare. The friend started on a Third avenue car at Sixty-sixth street and Third avenue at 10:35 a. m. The condition which he describes is a severe indictment of the transfer system which has prevailed in New York. This man rode until nearly midnight on two fares and when he stopped he still had a transfer good for transportation. During the day and evening he purchased theater tickets, chatted with friends, did some shopping, attended to other business, bought lunch and dinner and went to the theater.

The letter to Mr. Whitridge concludes with the statement "that it is entirely possible to ride east and west on one line all day long for a single fare"; that "by getting a southbound transfer one can ride east, west and south practically without limit"; and that "by paying another fare and getting a northbound transfer and using that in conjunction with the southbound transfer one can go north and south, east and west all over town all day long without paying any further fare, and when he gets through still have the transfers to give to a friend to continue the operation."

The transfer system is designed to give a passenger an opportunity to change, without the payment of a second fare, to a cross or diverging line or extension. The use of transfers for other purposes should be prohibited except in case of accident, when it is fair to permit passengers to ride on parallel lines. If passengers can travel in a circle by the use of transfers the system is faulty and no time should be lost in correcting it. The extent to which the system had developed in New York is shown by the following figures relating to the New York City Railway lines:

Year ended	Revenue passengers.	Transfer passengers.	Percentage of transfer fare to revenue fare, passengers. cents.
Sept. 30.			
1888.....	193,935,484	1,996,871	1.10
1890.....	215,235,832	2,578,701	1.12
1895.....	252,496,016	12,769,810	5.06
1900.....	360,002,672	173,089,442	48.08
1905.....	374,258,395	168,957,760	45.14
1906.....	391,354,577	178,639,866	45.65
1907.....	376,629,571	194,765,342	51.71
*1907.....	189,205,244	104,304,715	55.13

\*Six months ended December 31.

In four of the years from the fiscal year 1888 to 1907, inclusive, the total revenue passenger traffic decreased as compared with the previous year, and in two years the transfer traffic decreased. The rapid loss in the average rate of fare is an indication of a situation which might eventually have placed the surface systems of New York in receivership if other causes had not brought them to that end.

The disclosures have led J. F. Calderwood, vice-president and general manager of the Brooklyn Rapid Transit Com-

pany, to publish statistics showing a similar unjust condition of affairs on the lines of that company. In his interview, republished in another part of this issue, Mr. Calderwood states that transfers have increased in an alarming degree in the various cities of the country, especially in the larger places, and more especially in greater New York.

The extension of transfer systems is a subtle and dangerous invitation to lower average fares. No extensions of transfer privileges should be made without the same analytical study that would be given to the question of fares. The public unthinkingly accepts transfers without much thought as to the expense which they impose upon the railways. The New York Times states that "the conviction is forcing itself upon the minds of unprejudiced students of the situation that if the people of Manhattan require and demand a satisfactory street surface railway service they must either consent to a lightning of the taxes now imposed upon the roads or be content to accept a transfer system within much narrower limits." The unfortunate feature of the situation is that it should have required the receivership of the New York surface lines to bring to light a situation which had become dangerous. The court can remedy the situation, as it has in this instance, but it should have been in the power of the officials of the roads, and they should have used their power to prevent the development of the system to the full growth which it reached.

ANNUAL REPORTS.

International Traction System, Buffalo.

Passenger earnings of the International Traction System of Buffalo in 1907 increased \$413,585 over 1906, but freight earnings showed a decrease. The detailed earnings and the expenses as reported follow:

Earnings—	1907.	1906.	Increase.
Passenger .....	\$5,272,111.64	\$4,858,526.50	\$413,584.84
Freight .....	103,755.56	110,157.14	*6,401.58
Mail .....	1,938.11	1,799.06	139.05
Express .....	2,606.29	2,143.39	462.90
Advertising privilege ..	35,166.66	24,064.17	11,102.49
Income from securities owned .....	600.00	600.00	.....
Miscellaneous .....	28,892.01	27,008.18	1,883.83
<b>Gross earnings .....</b>	<b>\$5,445,070.27</b>	<b>\$5,024,298.74</b>	<b>\$420,771.53</b>
<b>Expenses—</b>			
Operating expenses .....	\$3,099,439.36	\$2,656,661.66	\$442,777.70
Depreciation .....	269,021.82	234,791.88	34,229.94
Taxes .....	284,140.74	254,819.55	29,321.19
<b>Total expenses .....</b>	<b>\$3,652,601.92</b>	<b>\$3,146,273.09</b>	<b>\$506,328.83</b>
<b>Total income .....</b>	<b>\$1,792,468.55</b>	<b>\$1,878,025.65</b>	<b>*\$85,557.30</b>
<b>Fixed charges .....</b>	<b>1,480,207.78</b>	<b>1,413,171.76</b>	<b>67,036.02</b>
<b>Net income .....</b>	<b>\$ 312,260.57</b>	<b>\$ 464,853.89</b>	<b>*\$152,593.32</b>

\*Decrease.

In his statement to stockholders Henry J. Pierce, the president, states:

Notwithstanding the financial panic which so seriously affected general business during the last quarter of the year, the gross earnings of the system for 1907 increased \$420,771.53 over 1906. The surplus was less than for the previous year, on account of higher operating expenses, taxes and interest.

The service afforded to the public was considerably improved over that of the previous year. The car mileage was increased 1,779,790 miles, equivalent to 9 per cent.

During the year \$525,327.82 was expended for repaving, relaying tracks with heavy rails, etc., and \$865,578.51 for additions to equipment, track and buildings. These expenditures were charged, respectively, to the fund for depreciation and to capital account.

The construction of the Fillmore avenue line of 11.2 miles was completed and the line put in operation, thus increasing the total mileage to 369.55 miles of single track.

A new car house and storage yard, having a capacity of 200 cars, was completed at a cost of \$225,000.

Mr. Pierce praises the operation of the 50 pay-as-you-enter

cars which were purchased and placed in service in Buffalo on January 5 (Electric Railway Review of January 11, 1908, page 37). The cars, Mr. Pierce says, "have proved a marked success, the municipal authorities, the public and the newspapers joining in praise of the new system of car operation."

The work of the installing the pay-as-you-enter feature upon 150 of the standard cars has been begun, and before the end of this year 200 pay-as-you-enter cars will be in operation in Buffalo out of a total of 600 operated.

COMMUNICATIONS.

MICHIGAN RAILROAD COMMISSION WILL NOT FOLLOW INTERSTATE ACCOUNTING SYSTEM.

To the Editors:

We have given Accounting Series Circular No. 29 of the interstate commerce commission considerable study, but have determined to continue using the blank form of report prepared by a committee of the Street Railway Accountants' Association and adopted by the National Association of Railway Commissioners in 1903.

We do not favor any system which is so finely subdivided as to become needlessly oppressive to the companies and to the commissions receiving reports. In Michigan our electric lines, with two exceptions, are small local affairs and we readily recognize the impracticability of asking them to furnish any more minute data than we are already asking. However, we are not posing as critics of any other commission.

MICHIGAN RAILROAD COMMISSION,

By James Scully, Commissioner.

Lansing, Mich., April 9, 1908.

DUPLEX TICKET ON MASSACHUSETTS LINES.

An explanation of the through ticket system which is now used on a number of the through lines of associated Massachusetts railways has been received from C. W. Wood, general freight and passenger agent of the lines, Boston, Mass. The lines are the Worcester Consolidated Street Railway, the Springfield Street Railway, the Berkshire Street Railway, the Milford Attleboro & Woonsocket Street Railway and the Interstate Consolidated Street Railway.

The accompanying illustration shows the duplex ticket used between Worcester and Springfield, Mass. Each conductor is supplied every morning with a sufficient number of the tickets to meet his requirements during the day. A passenger pays a through fare and the conductor punches on the ticket the date, the points of departure and destination and the amount of fare collected. One portion of the duplex ticket is retained by the conductor and given to the auditor with the daily report, while the other portion is held by the passenger but must be surrendered at destination, when that portion is also forwarded to the auditor.

On cars supplied with Ohmer fare registers the conductor registers the total fare as collected. On other cars supplied with separate ticket registers the conductor registers each fare at every zone. Under the old system passengers were required to pay five cents as each fare zone limit was reached, and the advantages and desirability of the new arrangement are obvious. Mr. Wood states that so far the new system has proved satisfactory from the standpoint of the company and that its convenience is appreciated by the traveling public.

Worcester Consolidated St. Ry. Co.		TO		FROM		Jan.	Feb.	Mar.	Apr.	May	June	July	Aug.	Sept.
Fare		04		Worcester										
Fare		5		Pinehurst										
Fare		10		Oxford Hills										
Fare		15		Richardson's										
Fare		20		Charlton City										
Fare		25		Brookside		1								
Fare		30		Southbridge		2								
Fare		35		Fairview Park		3								
Fare		40		Fiskdale		4								
Fare		45		E Brimfield		5								
Fare		50		Brimfield		6								
Fare		55		Bakers		7								
Fare		60		Mons'n T. Line		8								
Fare		65		Palmer		9								
Fare		70		No. Wilbraham		10								
Fare		75		Ludlow		11								
Fare		80		Springfield		12								
Fare						13								
Fare						14								
Fare						15								
Fare						16								
Fare						17								
Fare						18								
Fare						19								
Fare						20								
Fare						21								
Fare						22								
Fare						23								
Fare						24								
Fare						25								
Fare						26								
Fare						27								
Fare						28								
Fare						29								
Fare						30								
Fare						31								

Duplex Ticket.

**NEW REPAIR SHOPS OF THE YORK RAILWAYS COMPANY.**

Within the past year the York Railways Company, York, Pa., has erected and fully equipped a repair shop with ample facilities to care for both its city and interurban cars. The general arrangement of the repair shop and its adjacent storage buildings is shown in an accompanying plan. The re-

pair shop building is 265 feet long by 75 feet wide, including one bay 50 feet wide, through which extend three tracks. This bay is subdivided into a paint shop 60 feet long, shut off from a general repair shop by three Kinnear rolling steel doors. A parallel bay 25 feet wide is subdivided into smaller shops, each of which faces the general repair bay. The-

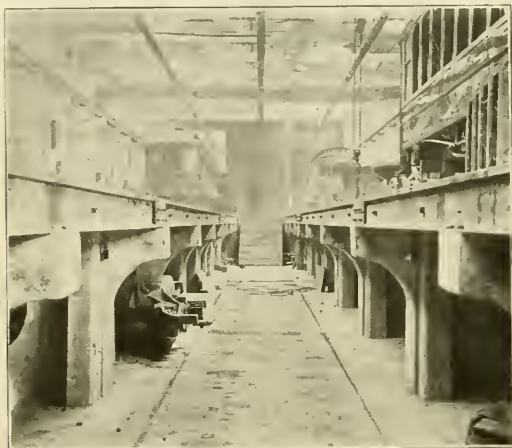

York Shops—Special Design of Pit Construction.



York Shops—Interior of Repair Bay.

pair shop building is 265 feet long by 75 feet wide, including one bay 50 feet wide, through which extend three tracks. This bay is subdivided into a paint shop 60 feet long, shut off from a general repair shop by three Kinnear rolling steel doors. A parallel bay 25 feet wide is subdivided into smaller shops, each of which faces the general repair bay. The-

floor the distance between piers is 7 feet 3 inches, thus allowing ample room for working and handling large material below the repair shop floor.

Along the bottom of the pits extends a standard-gauge track comprised of T-rails buried in concrete. As there is ample space under the repair shop floor for storing motors,

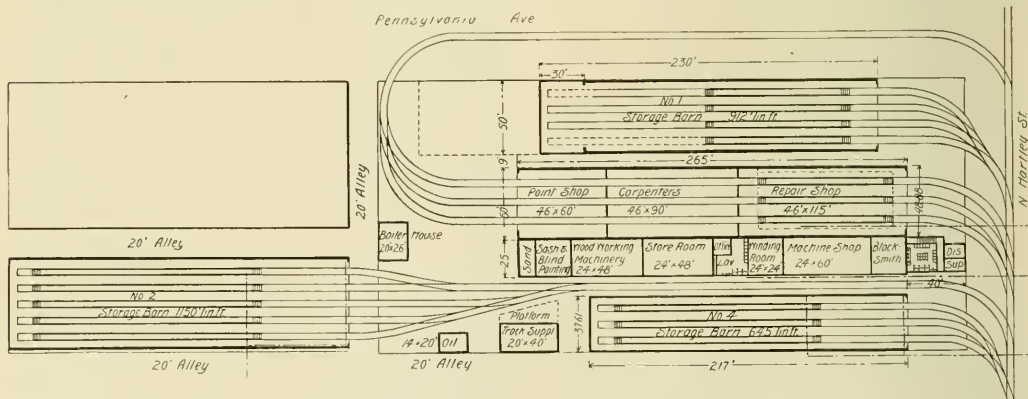

York Shops—General Ground Plan, Showing Track Arrangement.

building has concrete floors and foundations, brick walls and a timber truss roof.

**General Repair Shop.**

The general repair shop, an interior view of which is presented, is served throughout its length by two 6-ton hand-operated Maris Brothers cranes. Each of the tracks extending through this bay has a pit of special design about 75 feet long. Accompanying illustrations show the detail construction of these pits. They are light, roomy and of such design

wheels, trucks, etc., this track becomes useful in handling such material. Concrete steps at each end of each pit lead to the general floor level. The pits are wired in conduit, which is provided at 10-foot intervals with Crouse-Hinds "Condulet" terminal outlet sockets with incandescent lamps. At equal intervals are similar outlets for portable extension lights.

At the end of each pit near the center of the building is a hydraulic hoist of 4,000 pounds lifting capacity installed under a section of the track, which is embedded in the pit

floor. Reference to an accompanying engraving showing the design of one of these pit hoists will illustrate its simplicity and ruggedness. Essentially the hoist comprises a buried casing with a stuffing box at the top through which moves a section of wrought-iron pipe 10 inches in diameter, serving as a plunger. Either air or water pressure may be used in these hoists. On top of the plunger is a cast-iron table carrying two 3-foot sections of rail mating with the rails of the track in the floor of the pit. In its up-and-down movement the platform of the hoist is guided by brackets which fit over vertical sections of T-rail in the concrete piers supporting the floor above.

The entire shop is piped for compressed air, which is supplied by a 135-foot compressor, built by the Bury Compressor Company and driven by a Westinghouse 25-horsepower type S motor. The building is heated by hot water fed from a 50-horsepower Bigelow boiler and circulated through a closed circuit system of piping by a Worthington 4-inch centrifugal pump. All the light and power wiring is encased in conduit, the circuits being controlled from a single board. There are 22 incandescent arc lamps used for lighting. In handling motors on the repair shop floor there are

independently driven by a 35-horsepower motor; Putnam 42-inch wheel borer; American 20-inch by 12-foot lathe with quick-change gearing; American 2½-foot radial drill; American 16-inch back geared shaper; Standard 1½-inch bolt cutter; Yankee drill grinder; Prentice drill press; and a Robinson power hack saw.

A Coburn overhead track and trolley with a chain hoist serves the various tools in the machine shop.

Adjacent to the machine shop is the armature room. 24

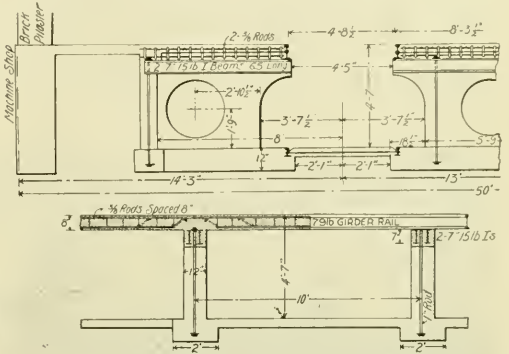

York Shops—Details of Floor and Pit Construction.

feet square. The facilities in this room include a Peerless armature truck; Peerless combination banding and coil winding machine (both built by the Device Improvement Com-



York Shops—Stock Racks in Storeroom.

used two O. M. Sargent balanced hoists, which are hung on the lifting hooks of the traveling cranes, thus materially lessening the work of hand operation. A pipe fitter's bench, mounted on substantial wheels, is found to be of especial use because it can be moved to various parts of the shops.

Miscellaneous Shops.

Several departmental shops are arranged in a row opening off the general repair bay. A brick fire wall separates the two sections of the building.

The blacksmith shop, 24 by 24 feet, is at the front end of the building. In this shop are a 44-inch Buffalo down-draft forge with a combination motor-driven blast and exhaust fan set; a home-made forge for melting babbitt; a hand-operated Niagara punch and shear and a specially designed home-made rack for storing iron.

The machine shop, next in order, is 24 by 60 feet, and directly faces that part of the repair shop floor in which the pits are built. All the tools in the machine shop, with one exception, are group driven by a Westinghouse 15-horsepower type S motor supported from the ceiling. The list of tools includes a 200-ton 42-inch wheel press built by the Hydro Press Company, Rochester; Norton wheel grinding machine

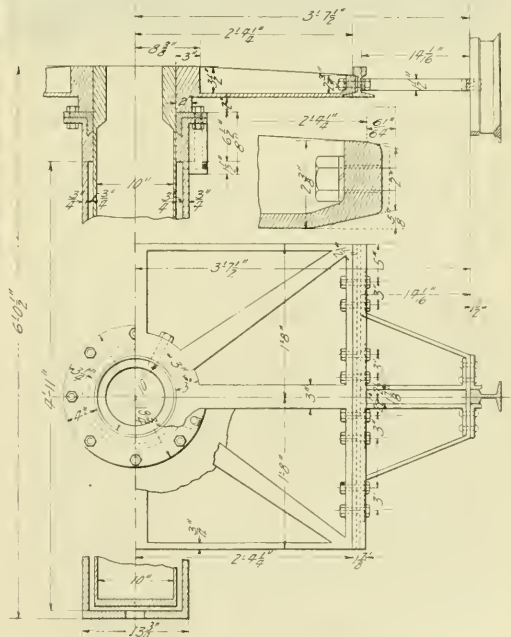

York Shops—Details of Hydraulic Pit Hoist.

pany, Hanover, Pa.); 18-inch Wright lathe; and a continuation of the Coburn overhead track and trolley with its chain hoist. A unique method is used for storing armatures and protecting them from damage. The rack and portable boxes

used for this purpose are so simple that the accompanying illustration serves better than a description.

At the center of the row of smaller shops are the lavatory, which contains expanded metal lockers and self-flushing closets, and a brick inclosed office for the master mechanic. Next in the line of the smaller shops is a storeroom, 24 by 48 feet, of which an illustration is presented herewith.

Adjacent to one end of the storeroom is the wood shop, 48 by 24 feet, which adjoins at its opposite end the varnishing room, 24 feet square. All the machinery in the wood shop is driven from a line shaft operated by a 15-horsepower type S Westinghouse motor. The woodworking machinery, a large part of which was supplied by the H. B. Smith Machine Company, includes the following tools: Eight-inch 4-side molder; 26-inch planer (single surfacer with sectional rollers); 24-inch jointer; 42-inch hand saw; tenoner; 2-spindle shaper;

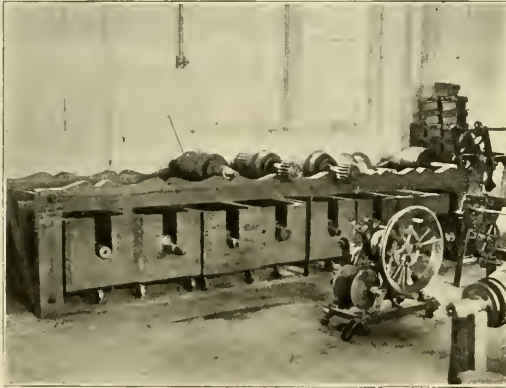

York Shops—Armature Rack and Portable Boxes.

mortiser; wood lathes; swing saw; and tilting table rip and cross cut saw.

At the extreme rear end of the row of smaller shops is a sandhouse, 12 by 24 feet, with an entrance from the outside only. We acknowledge our indebtedness to F. R. Newman, master mechanic, for his assistance in preparing this article.

#### CURTIS TURBINE SALES.

The following statement of sales of Curtis steam turbines is of special interest, as showing the rapid development of this type of prime mover.

Orders to December 31, 1907, include: 261 central station and traction power plants with a total capacity of 986,020 kilowatts; of these 71 are less and 190 are greater than 1,000 kilowatts, the average capacity being 3,778 kilowatts. 298 industrial and miscellaneous power plants with a total capacity of 87,675 kilowatts; of these 243 are less and 45 are greater than 1,000 kilowatts, the average capacity being 305 kilowatts.

Installations to December 31, 1907, include 943 machines averaging 857 kilowatts each in capacity, and orders on hand at that date include 153 machines averaging 1,739 kilowatts each in capacity, the total sales being 1,096 machines, aggregating 1,073,695 kilowatts in capacity.

Orders for Curtis turbines taken by the General Electric Company in the fiscal year ending January 31, 1908, were for 325 machines aggregating 286,320 kilowatts in capacity.

The Washington Baltimore & Annapolis Electric Railway, Washington, D. C., on April 2 began operating on its regular schedule over the new line between Washington and Baltimore and the branch to Annapolis. This road was described in the Electric Railway Review of February 15, page 200.

#### REPLY TO INTERSTATE COMMERCE COMMISSION'S ACCOUNTING CIRCULAR.

BY H. E. WEEKS, SECRETARY AND TREASURER TRI CITY RAILWAY,  
DAVENPORT, IA.

Circular No. 20 of the interstate commerce commission, dated January 10, 1908, was not received until March 1. The time allotted, 28 days, to consider a matter of such grave importance as the entire change of the accounting system in use by the street and interurban railway companies of the United States was much too brief.

It would seem that before changing the uniform system of accounts, which has been developed after nine years of painstaking labor by those fitted by their intimate acquaintance with the business to work out its special requirements, the commission should study carefully the requirements of the street and interurban railway interests.

The only branch of the industry which can adopt steam road methods is the interurban branch, which has come into prominence in the last five years; and it is probably the desire of the commission to adopt a system of accounts which will be uniform and will enable the steam road when electrified to continue its comparisons that has led to the error of supposing that because the interests were similar in that particular branch the system of accounts as prescribed for steam roads could be modified to meet the needs of urban properties.

It will undoubtedly be possible to so classify the revenues and expenses that the general accounts can be the same, but beyond that point each industry will have to be given the individual consideration which it merits.

Even in the case of interurban properties the method of operation differs so radically on account of the difference between the method of propulsion that the comparison has to be qualified; whereas in urban business the unit of comparison is entirely different.

Judging from an experience covering the operation of street and interurban properties with a gross income of from \$30,000 to \$90,000, I should say that two classifications are not sufficient. A road should be considered as a small road until the gross earnings are at least \$300,000, as any attempt to present any great amount of detail will only result in estimates and inaccuracy, which will render statistics worthless. The primary accounts could be amplified to meet the requirements of the road with a gross income of less than \$1,000,000 and further amplified to cover gross receipts of over \$1,000,000.

The question of the amount of detail to require is one of grave importance; a few accounts accurately kept are worth far more than a larger number based on estimates, the reliability of which cannot be vouched for.

The courtesy of submitting the proposed classification should be appreciated and every effort possible should be put forth to give as much help as possible along the line of perfecting a classification which will give the public and the industry the information desired. The feeling has prevailed that the commission has not given the suggestions offered by the representatives of the street railway industry of the country the consideration that they merited. The tentative classification upon which much time and labor were spent by the American Street and Interurban Railway Accountants' Association represents the views of the street railway industry as to how the accounts should be kept.

In order to bring out the inapplicability of the steam road classification, as it has been modified for electric railway use, to the needs of the industry, detail criticisms of the accounts will be made.

Account No. 7, "paving," is not definite. It should specify that the first cost of paving, even if the track is only reconstructed when the paving is done, should be charged to "road and equipment," No. 10.

Account No. 10, "bridges, trestles and curverts." Provision should be made for bridges not owned by the operating



companies, as bridges over which urban properties operate are more often owned by municipalities than otherwise.

In account No. 13 the "note" is not definite. No account is provided for other track material.

Account No. 14, "telegraph and telephone lines." Inasmuch as the telegraph and telephone lines used by an electric road are carried by the same poles that carry the power transmission and conductor wires, it would be impracticable to charge separate maintenance of crossarms, poles, guy wires, etc., as it would necessitate a large amount of estimating.

#### Unsatisfactory Departmental Accounting.

Account No. 15, "other maintenance of way expenses." This account necessitates an amount of departmental accounting which on most electric roads will involve so much estimating that the results derived will be unsatisfactory. The same tools may be used by several departments. "Superintendence" could not be detailed with any degree of accuracy. The same can be said of both "printing and stationery" and "injuries to persons." In the case of "printing and stationery" the same typewriters, adding machines and other office appliances are used by all departments.

Account No. 17, "high-tension transmission lines." It will be impossible to separate this expense with any degree of accuracy, as high-tension, low-tension, trolley, telephone and signal wires are often carried on one pole line. The same condition applies to account No. 18, "overhead feeders," and to account No. 21, "overhead trolley lines."

Account No. 34, "electric equipment." Electric equipment is used on service cars, work cars and snow equipment, depending on the season. It would be difficult to determine where to charge maintenance.

Account No. 40, "removal of snow, sand and ice." It would be impossible to determine an accurate charge for current used, for even if meters were placed on cars the conditions under which cars operate are such as to preclude accuracy; furthermore, much current is consumed by small track scrapers on service equipment.

Accounts Nos. 45 and 46. The application of joint facilities accounts to electric roads is not practicable, as they would necessitate so much estimating that the results would be worthless. It would be necessary in many cases to divide a fraction of five cents between accounts Nos. 45 and 46 and between Nos. 104, 105, 115 and 116. The subdivision for charge of current, taking into consideration line loss, would be impossible with present measuring facilities, as they are not to be depended upon. Where freight and express cars of varying weights, depending on the load, are used, the estimate of wear and tear on track would be a mere guess.

Account No. 48, "combination cars—repairs—note A." Electric roads carry express on combination cars or separate cars. Freight and express are often carried in the same cars. Express and mail are nearly always carried in combination cars.

Account No. 50, "mail cars—repairs," is unnecessary in the electric road classification except for very large companies.

Account No. 53, "electric equipment of passenger cars—repairs." The motors used under a passenger car do not remain permanently in passenger service. It would be a guess as to which account should be charged with the repairs, as the motors may be used on any class of equipment. The same criticism applies to accounts Nos. 54, 55, 56, 57 and 58.

Account No. 71, "advertising and attractions." Provision should be made for music parks, park properties and resorts after deducting all income from admission fees, sale of privileges, etc.

#### Traffic Expenses.

Account No. 72, "traffic supplies and expenses." It would be necessary to estimate the charges to the first heading, "traffic associations." There will probably be an opportunity for electric roads to charge expenses of "industrial and immi-

gration bureaus" several years hence, but it would seem unnecessary to provide for the contingency at present. Regarding "stationery and printing," see remarks concerning account No. 15.

Accounts Nos. 73, 74, 75, 76 and 77. It seems ill-advised to make the heading of an account any longer than necessary. The headings used by the Accountants' association are far better.

Accounts Nos. 79, 80 and 81. A great amount of labor and expense would be required to keep these accounts as they are outlined. It does not seem that the results would be commensurate. If a great number of meters were not installed the results would be unsatisfactory. If the meters were installed the expense would be an unwarranted one.

Accounts Nos. 82, 83, 84, 85, 86 and 87. The street and interurban railway tentative classification accounts from Nos. 19 to 22, inclusive, should be substituted. Express motormen and other employes are provided for in account No. 98.

Account No. 95, "car supplies and expenses," should be rewritten to apply to electric practice; much more detail is used than will be necessary for years. It is altogether impracticable to segregate the cost of lighting cars when cars are lighted and heated by the same current.

Account No. 102, "damage to property." Provision should be made for collision with vehicles in streets, an expense which constitutes a very large proportion of the cost of damages to property by electric roads.

Account No. 106. Why is not the freight claim agent charged to the account affected?

Clearing account "work equipment operation." It is not possible to charge electric current used by work equipment, as no accurate computation can be made.

Clearing account "insurance." Should the total amount charged be divided at an average rate?

Clearing account "injuries to persons." The number of roads that employ an attorney to look after what claims are not adjusted by the officials is so large that the results obtained by trying to distribute the expense over so many accounts would be worthless. Even with roads that employ claim agents an attempt to detail their work would be impracticable.

#### Criticism of Expenditures for Road and Equipment Accounts.

Account No. 9, "frogs, switches and special work." When a guard rail on a curve is part of a piece of special work is it proper to charge it to this account or should an estimated amount be charged to No. 8? Provision should be made for special work peculiar to the electric railway business.

Account No. 10, "paving." Some provision should be made for paving track already in use.

Account No. 22, "track bonding." Where rails are drilled when purchased, as they usually are, should a portion of their cost be charged to this account?

Accounts Nos. 43, 44, 45, 46, 47 and 48. It would be difficult to make these accounts show correctly, as it would be necessary to make an entry each time a motor was changed from one class of equipment to another, which happens very often on most roads.

Account No. 60, "injuries to persons." Where should damage to property be charged? On an electric road in street construction this is an important item.

Account No. 61, "interest and commissions—note." How should such discounts be treated?

#### Chicago Lake Shore & South Bend Railway.

Officials of the Chicago Lake Shore & South Bend Railway have announced that the line from South Bend to Michigan City and Kensington, Ill., will be in operation by July 1. At Kensington the road connects with the Illinois Central Railroad for Chicago. Only 11 miles of construction and a bridge remain to be completed.

REPLY TO INTERSTATE COMMERCE COMMISSION'S  
ACCOUNTING CIRCULAR.

BY R. N. WALLIS, TREASURER FITCHBURG & LEOMINSTER STREET RAILWAY, FITCHBURG, MASS.

Your circular No. 20 has been received and given careful consideration, and we inclose herewith a copy with answers to the specific questions, and such marginal comments as a study, necessarily hurried by the shortness of time, has disclosed.

You invite any "criticisms and suggestions pointing to the improvement of the classification." Frankly, I do not regard the classification of operating expenses as adaptable to the street railway industry. The accounting of any business must follow along natural lines which the customs and usage of the industry have built up, and this classification so far as street railways are concerned does not follow natural lines. It is evidently the work of some one who is unfamiliar with the industry. There are many instances of this in the classification which might be cited, but we will mention but one, which is typical, the motive power of an electric railway. The electric equipment is interchangeable between cars of various types and uses, and electric equipment may be used in December, January and February on snow plows, in March and April on a work car, from April during the summer on a revenue open car, and before the completion of the year on a revenue closed car. To attempt to divide its maintenance among a variety of accounts is unnatural. It would be impossible to tell what part of the wear and tear was due to any one of its uses. Maintenance of electric equipment, therefore, should stand as one account, and not be divided as it is in this classification.

A fundamental error in the classification is the unnatural conformity to steam railroad practice, greatly forced at some points. The two businesses are dissimilar, a fact which it seems difficult to impress upon any one who has not come in contact with both industries or had a chance to study the practices of one with relation to their adaptability to the other. In my opinion reasonable conformity can be attained without radically upsetting natural electric railway practice.

Another error so far as roads under \$500,000 or even more annual income are concerned is the great detail of accounts. It must be remembered that there is a limit in percentage of income beyond which the expense of accounting cannot be forced. Beyond that point guesswork and estimate are availed of. This classification on any road under the above income will certainly mean largely guesswork as to many of the minutely divided accounts with resultant inaccuracy. And it must be remembered that railways under \$500,000 constitute fully 80 per cent of the operating companies. From the viewpoint of the small company, which cannot afford to do its accounting by departments, the 116 accounts of this classification should be consolidated to not to exceed 30 or 40 accounts.

Our company has been a successful company for 20 years. Its directors and officers have been always exacting in the matter of its statistics, demanding to know from careful accounting what the company was doing financially, and yet the number of all our accounts (of income, expense, capital and special accounts) is at present 65. If this is sufficient for the exacting needs of those who are directing its affairs, it seems to me fully sufficient for the legitimate purposes of the public. I do not agree with those who believe that the larger the detail in accounting the greater the information obtained. As a matter of fact, beyond a certain number of accounts reasonably necessary, additional detail only leads to misinformation.

In my opinion, with anything like a reasonable expenditure for accounting, no road with annual gross receipts of under \$500,000 could divide its expenses in any such extent of detail with anything like accuracy. The result would be guesswork and estimate, which defeat the purpose of publicity.

While some accounts as they stand are important, in many cases the division is so minute as to be unnecessary. Such, for instance, are the accounts under "A maintenance of way," Nos. 1 to 15, which could be reduced to two accounts in roads of our size, and still not run into large figures.

Another fundamental error occurs in the subdivision of many relatively unimportant general expenses (such as insurance, stationery and supplies, stable expenses, etc.) among a number of accounts, while other general expenses are not so subdivided. This is inconsistent. These items individually or in the aggregate are very small, and their further subdivision on a road of this size brings them to a ridiculous proportion at a very considerable expense of time and labor. "Stationery and supplies" on this road (gross earnings, \$280,000) would not total \$500, and the labor of dividing each charge among several accounts would be out of all proportion.

Another feature which makes it apparent that some one unacquainted with the needs of the business is responsible for this classification is the fact that many things important in the street railway business have no place at all in the classification. For instance, practically nothing is said about streets, which constitute the entire roadway of a great quantity of companies. Also no mention is made of parks, which are so commonly adjuncts to electric railways.

It seems to us hardly short of ridiculous to include in the classification such lists as stationery, etc., which appear on pages 20 and 21 and other pages, while no list appears in anything like detail of supplies typical to the art (as for instance line materials, electrical supplies, etc.).

I firmly believe that if this classification goes into effect practically as it stands, the needs of the business will require its change within a short time, destroying again year by year comparisons which will already have been destroyed once by this classification. It seems to me it would be better to forestall this by calling in some person or persons thoroughly familiar with the business, whether now connected with it or not, to make up a classification along lines which are adapted to the needs of the business. Such person or persons need not be those employed by corporations at interest, but by being employed by the commission might come under its direct control while doing the work.

Comparative Lamp Tests.

Bulletin No. 19 of the University of Illinois, recently issued, is a report of comparative tests of carbon, metallized carbon and tantalum filament lamps, compiled by T. H. Amrine of the university's engineering experiment station. The report is contained in a 44-page pamphlet illustrated with 32 figures and five tables. From the study of these lamps it appears that the carbon filament and the tantalum filament lamps can cover adequately all the phases of incandescent lighting that are now covered by the three types. For low power costs and for rough or unusual uses and for small candlepower units the carbon lamp was found to be best and often the only one that can be used. For higher costs of power upon poorly regulated circuits and for lightening the load upon overloaded stations, the tantalum lamp was found to be best. It is not recommended by its manufacturers for use upon alternating current, yet the results obtained show that although it does not do so well upon alternating-current as it does upon direct-current circuits, it still gives better economy for the higher power costs than the carbon lamp. The principal fault of the metallized lamp was found to be that of mechanical weakness. In the larger sizes, however, where a heavier filament is used, this fault probably does not exist; so that for units of from 40 to 60 candlepower or above this type of lamp would be very satisfactory. The results of tests from the tungsten lamps are not included in the report because at the time they were started these lamps could not be purchased on the market.

### CAR BUILDING WORK OF THE LOS ANGELES & REDONDO RAILWAY.

BY W. F. GOBLE, GENERAL FOREMAN.

The Los Angeles & Redondo Railway Company has, within recent months, built and rebuilt a comparatively large number of rolling stock equipments. An enumeration of



Los Angeles & Redondo Car Building—Passenger Car with Open and Closed Sections.

the general features of this work may be of interest. The statement which follows includes many of the specialties used in our car construction work.

#### Passenger Cars.

One combination open and closed passenger car 47 feet 6 inches long by 8 feet 2 inches wide has been built. The closed portion of this car is 25 feet long and is fitted with eighteen 34-inch crimson plush Hale & Kilburn seats. The open portion has eight Wheeler wood slat seats. Both open and closed sections are provided with "oakette" curtains with Keeler fixtures. The ceilings are sheathed with No. 18 black iron, painted a dark royal green, which, in contrast with the woodwork, stained cherry, gives a very cheerful appearance to the inside of the car. The woods used for the inside finish of the car are white cedar, ash and poplar, with cherry sashes and doors. All windows are glazed with  $\frac{3}{8}$ -inch plate glass and the transoms with 16-ounce sanded plate.

The electrical equipment comprises four Westinghouse 38-B motors, with a gear ratio of 24-58, mounted on M. C. B. type trucks with equalizer bars and swinging beam bolsters built of 6-inch channel iron capped with  $\frac{3}{8}$  by 7 inch plates. The motors are provided with K-14 controllers and the brake equipment comprises the Westinghouse S M E schedule with D-1 compressor. The car is equipped with adjustable illuminated transparent signs for announcing the various routes over which it may be operated.

A combination express and freight car has been built on the same general lines as the straight passenger car just described. The combination car has a 15-foot express compartment. The running gear and the electrical equipment are the same as for the straight passenger car, both cars having the lighting circuits wired in series-multiple with the headlight. Twenty-four 16-candlepower incandescent lamps are used and a No. 14 Mosher headlight. When the headlight is not required a 3-way switch serves to place the interior car lighting circuits in series with the resistance coil.

On account of the sagging of the platforms ten 44-foot combination open and closed passenger cars were rebuilt. In reconstructing these cars the wooden bolsters were removed and by rounding the edges of 4 by 6 inch Oregon pine center sills a reinforcement was made with 6-inch 12 $\frac{1}{4}$ -pound I-beams 18 feet long, placed adjacent to each center sill on both ends. Four such I-beams were used to each car. The unfilled sides of the I-beams were filled with 2 by 6 inch timbers securely bolted. This construction makes a cheap and very substantial reinforcement. The bolsters for these cars were built of 1 by 8 inch iron trussed with  $\frac{1}{2}$ -inch iron plate and filled with Oregon pine. The cars were repainted and varnished similar to the passenger car earlier described.

Illustrations of both passenger and combination types of cars are presented.

#### Freight Cars.

Twenty 40-foot flat cars of 80,000-pound capacity have been built for freight service. These cars were constructed of clear yellow Oregon pine for side, intermediate and end sills. The side sills are 5 by 12 inches; intermediate sills, 4 by 9 inches; end sills, 10 by 10 inches. The sills are trussed with six 1 $\frac{1}{4}$ -inch iron rods with 1 $\frac{3}{8}$ -inch turnbuckles. The queen posts, 14 inches long, are of cast iron. The cars were built to handle lumber and therefore have detachable brake staffs. These staffs are made in two pieces and coupled with a square socket just above the ratchet wheel. The bodies are fitted with Simplex body bolsters and provided with Miner draft rigging and Tower couplers.

The cars are mounted on M. C. B. standard freight trucks, with Simplex bolsters and McCord journal boxes, metal brake-beams and malleable shoe heads, using standard shoes. The wheels are fitted to 6 $\frac{1}{2}$ -inch axles with 5 by 9 inch journals.



Los Angeles & Redondo Car Building—Combination Passenger and Baggage Car.

The trucks were built for standard-gauge service, but the axles are turned and the wheels pressed in to suit our 3-foot 6-inch gauge. However, by moving the shoe heads on the brake-beam and pressing the wheels out to fit a 4-foot 8 $\frac{1}{2}$ -inch gauge the cars could be used on broad-gauge lines. This change of the running gear from that suitable for narrow to that for broad gauge would cost about \$15 per car.

#### Reconstruction Work.

The following list includes a large part of the cars that have been rebuilt:

One express car, lengthened three feet.

One combination express and freight car, changed to

a straight passenger car of the form described herewith.

One parlor car, reconstructed by removing toilet room from closed section, inclosing open section with windows and installing 18 high back plush-covered seats and 12 revolving cane seat chairs of the Wheeler type.

Ten 80,000-pound flat cars, 36 by 9 feet, converted to box cars.

Twenty-one box cars, strengthened by new truss rods,

interior finish and fittings will be the same as those of the straight passenger cars earlier described. The electrical equipment will comprise Westinghouse multiple control with four 101-H motors mounted on M. C. B. type trucks with 5-foot 10-inch wheel base. Westinghouse schedule A M M air brake equipment will be used.

We also have just completed one combination switch and freight motor 30 feet long by 8 feet 6 inches wide, with

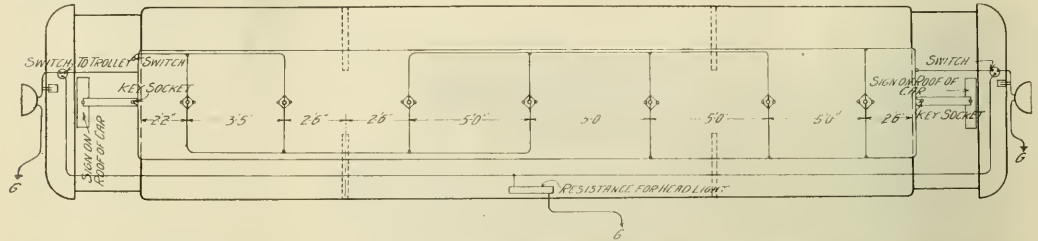

Los Angeles & Redondo Car Building—Plan of Light Wiring for 47-Foot Passenger Cars.

beams raised to standard height, Tower couplers, 30-inch double-plate wheels and metal brakebeams applied.

Fifteen flat cars raised to standard height, Tower couplers and 30-inch double-plate wheels applied.

Two freight motor cars raised and vestibule cabs with sliding doors built on each.

Two work motor cars raised to M. C. B. standard height, Tower couplers applied and both cars ballasted with old rails and concrete between side and intermediate sills.

One line tower car raised to standard height, Janney coupler applied and cab rebuilt.

One 4-driver Baldwin locomotive completely overhauled. One pivot pile driver rebuilt and 20-horsepower boiler installed.

New Construction.

There are in process of construction six passenger cars 47 feet 6 inches long by 8 feet 6 inches wide. These cars will be of the combination type with open and closed sections. The center sill construction consists of four 6-inch 14 3/4-pound



Los Angeles & Redondo Car Building—Combination Freight and Switching Locomotive.

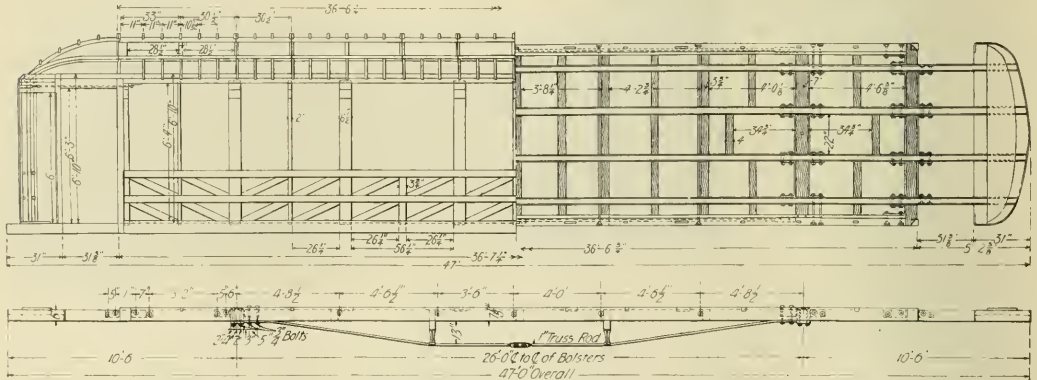

Los Angeles & Redondo Car Building—Framing Details of 47-Foot Open and Closed Passenger Car.

I-beams with Oregon pine fillers. The side sills are of clear Oregon pine, 6 by 7 inches. The interior finish will be of Spanish cedar and all trimmings will be of brass, nickel-plated. The closed sections will have 18 plush-upholstered Wheeler seats and the open sections will have eight Wheeler slat seats. The cars will be painted a dark olive green with gold stripes, numbers and initials. The windows will be of the Pullman style with opalescent glass in each sash. The

a center cab 8 feet 6 inches square. The approaches at each end of the cab are 43 inches high at the cab and slope to 12 inches high above the floor line 5 feet back from the buffer. These approaches are 5 feet wide. The cab has four 20-inch sliding doors, one in each corner, opening to the 20-inch passageway between the hand rail along the side of the car and the covered approaches. The air pump and receivers are inclosed inside of these approaches. This car has 6 by 12 inch

side and 6 by 10 inch intermediate sills ballasted with old steel rails and concrete. Wooden draft rigging is used with Tower couplers. The electrical equipment is the Westinghouse multiple-unit control with four 101-H motors, having a gear ratio of 15-69, mounted on M. C. B. type trucks with 5-foot 10-inch wheel base. Westinghouse schedule ET air equipment is used. An accompanying halftone engraving shows the general appearance of this switching locomotive.

The many attractive features of the six new passenger cars and the switching motor are due to C. H. Burnett, manager Los Angeles & Redondo Railway, who has given a great deal of attention to the appearance as well as the convenience of the rolling stock operated by his company.

#### THERMIT WELDING BY THE CHICAGO CITY RAILWAY.

The Chicago City Railway Company has recently purchased from the Goldschmidt Thermit Company a thermit welding outfit which is now doing excellent service at the



Chicago City Railway—Motor Shell with Thermit Repair.

railway company's shops at Seventy-seventh street and Vincennes road. Repairs have been made during the past week to a number of broken motor shells. These repairs comprise the welding in of broken lugs and housings, as well as repairing cracks in the main part of the shells.

When a damaged shell is to be repaired a line of ½-inch holes is drilled on about 1-inch centers closely following the crack, so that the new metal may have ample contact with the old. Next a brace of bar iron is bolted to the shell so that it will hold closely to their proper positions the axle-bearing lugs and the armature-bearing housing. After the shell has thus been drilled and securely bolted it is sent to the foundry for welding.

The first step in the work after a damaged case is received at the foundry is to burn off all the grease that may cover the iron near the parts to be welded. This burning is done with a large compressed air blow torch. Next the foundryman shapes along the crack a core of beeswax of the exact shape which it is desired to cast the patch of thermit steel. Such beeswax cores are placed on both the inside and the outside of the shell, directly over the row of holes bored through the line of fracture. With the beeswax patches carefully placed the foundryman next covers them with a mass of fire clay, making molds about three inches thick—one for the inside of the shell and one for the outside. As soon as these clay molds which cover the beeswax cores have set they are baked in the foundry core oven; meanwhile the beeswax core is removed. When the fire clay

molds have been thoroughly baked they are set against the steel shell in the exact position at which the impression was made and are held there by being banked with sand. To facilitate this holding of the molds in the sand a box is put around the case as it stands on the foundry floor and the space between the box and the case, as well as the interior of the case, is rammed to a striking level with moist sand.

The molds for the patch proper are now ready for a riser and gate, which must be placed so that the hot thermit steel will properly flow in at one end of the opening through the clay mold and out at the other. Next an ordinary foundry flask is set on top of the motor case and its packing of sand. Parting sand is sprinkled about the joint and the flask is rammed full, holding a 2-inch riser and a 1½-inch sprue. The riser is so tapered that at the top of the flask it is about four inches in diameter; and the sprue is so placed that the hot metal will flow freely into one side of the clay mold and continue its course around the fracture and up into the riser on the opposite side.

Next, the cope is lifted and the sand thoroughly dried around the riser and gate openings. A blow torch serves for this purpose and also is used to heat the top of the mold. The metal to be patched is brought to a red heat, so that the thermit steel will not be chilled until it has had opportunity to flow freely around the fracture. When the heating process is completed the cope is replaced, the crucible is set over the gate opening, the thermit charge in the crucible is fired and at the proper time a pouring is made. The result is a patch of thermit steel on either side of the fracture with risers attached, as shown in the accompanying engraving.

After the metal has cooled the case is taken to the machine shop, where the patch is dressed to the desired shape.

#### THERMIT WELDING AT INDIANA UNION TRACTION COMPANY SHOPS.

Through the courtesy of R. C. Taylor, superintendent of motive power Indiana Union Traction Company, we present the accompanying engraving showing a group of motor cases



Indiana Union Traction—Group of Thermit Welds.

with repair welds made by the Thermit process in the company's shops at Anderson, Ind.

The Indiana Union Traction Company has recently purchased a Goldschmidt Thermit welding outfit and will use this process where it may do so advantageously in the ordinary course of its maintenance work.

The motormen and conductors employed by the Pensacola (Fla.) Electric Company have declared a strike and on Monday a United States mail car was the only one operated in the city. The reason for the strike is said to be a disagreement in regard to working conditions.

## SHORT TALKS WITH THE CLAIM INVESTIGATOR—I.

BY F. W. JOHNSON, ASSISTANT GENERAL CLAIM AGENT PHILADELPHIA  
RAPID TRANSIT COMPANY.

Ample opportunities for advancement to positions of trust and responsibility are today distinctly within the reach of the young man in claim and accident work, provided he is able to demonstrate the fact that he is built of the right material and along the right lines.

Given a man of average intelligence, ambitious, energetic and loyal to the interests of his employer, his success in this work should be assured from the very start. Should he prove lazy, however, or careless, vicious or untrustworthy, it becomes merely a question of time before he will strike his proper rating and be relegated to the scrap heap.

Many young men enter upon claim work with good prospects and the best of intentions, only to fall by the wayside after a brief year or two in the department. The percentage of failures of this sort is higher than might reasonably be expected. Particularly is this true with respect to departments located in the larger cities.

The explanation of this is comparatively simple. Claim work is a business distinctly different in many respects from the ordinary lines of employment to which young men turn in seeking openings in the business world. The work is of a character which demands absolutely certain fundamental qualifications in a man. Provided that he possess these essentials to success in claim work, he speedily becomes a fixture in the business, his progress from that point on depending solely upon his own individual efforts.

If, on the other hand, he is deficient in this direction, the fact quickly becomes apparent and he soon realizes that in following claim work he not only is wasting his own time, but is as well materially lessening the effectiveness of the department as a whole. Hence the necessity for seeking quick returns upon the investment in judging of a man's value to the department in part accounts for many of the failures among those who enter upon the work.

This should not act as a deterring factor, however, in judging of the possibilities for success in the calling—by those already engaged in the work or by those who contemplate entering it. Young men of good character, willing to work and ambitious to succeed, are now and always will be at a premium in claim work. It is a noticeable fact that the standard of efficiency of the average railway claim department has been steadily advancing of late years. Men of greater breadth of view and of higher ideals are being attracted to the work, with a consequent improvement in all directions as a natural result, which fact of itself augurs well for the young man in search of a field of employment which will present unlimited opportunities for advancement.

Conditions governing this branch of electric railroading are, unfortunately, becoming more and more trying each year. Without diverging into an extended discussion of the whys and wherefores of this state of affairs, it may briefly be observed that the attitude of a very considerable portion of the traveling public toward transportation companies, with respect to the matter of claims for personal injuries, is of such a character as to place the said railway companies constantly on the defensive. Such being the fact, it follows with logical sequence that railway companies must necessarily bend every effort toward equipping their claim departments with as capable men as may be obtainable.

In selecting men for vacancies in the claim department the average street railway management considers as eligible only men who possess clean records for faithful, intelligent service in the past—men who not only may be trusted implicitly, but who also give promise of future development. A distinct compliment is thus paid by a company to the young man whom it admits to employment in this important branch of its work. In thus placing their stamp of approval

upon him, the officials of the company certify to their entire confidence in him by entrusting to his care work of a decidedly confidential nature, requiring no other assurance of his trustworthiness than their own belief in his absolute loyalty.

Here it is, then, that the young man encounters the first real test of his value to the company, as well as of his future success in claim work. Possessing a sturdy spirit of loyalty to his employers, his shortcomings in other directions may oftentimes be overlooked. Lacking this essential, however, other qualifications will avail him naught. It is but natural that the average man should, with becoming modesty, credit himself with the possession of this sterling quality, generally to a marked degree. And the average worker in the ranks of the claim department is no exception to this general rule.

Let it be said to the claim man's credit that instances of deliberate disloyalty upon the part of railway investigators, inspectors and adjusters are indeed rare. As in all other lines of employment, there occasionally crops up a man who will voluntarily wreck his business career by branding himself as a fraud. Comment upon such weaklings is unnecessary. Their pitiful careers in the business world eloquently tell their own story.

In the main, however, experience has proven the railway claim investigator a sturdy type of manhood, faithful to his duty, ambitious to succeed in life and ever alert to protect the interests of his employer.

Loyalty to an employer need not necessarily be demonstrated through the medium of some unusual or heroic achievement. Opportunities for brilliant, spectacular work are comparatively few and far between, even in the larger departments the element of chance playing a leading role in distributing these "short cuts to promotion."

To every man, however, is afforded the opportunity of proving his loyalty by giving to his employers his best efforts toward the faithful execution of such tasks as may be assigned to him—not occasionally—not now and then at spasmodic intervals—but day after day, week after week and month after month. The harder the assignment the greater his determination to carry it through to a successful termination, in other words, to do his level best all the time.

Gradually the fact becomes apparent that So-and-So is rounding into a valuable man for the department. His development is watched with close interest by his superior officers, for they begin to recognize in him indications of the material from which lieutenants are constructed.

Simultaneously it begins to dawn upon the investigator that his assignments are becoming more and more difficult. He is finding it harder and harder to secure his statements and releases, because of the increasing seriousness in the character of the cases assigned to him. If it is his nature to act first and think afterwards he very probably enters a vigorous protest against the other men being favored with the easier assignments, while he himself is receiving more than his fair share of the tough ones. In this event he proves himself painfully short-sighted.

If, on the other hand, his heart is in the business and his eye is on the future, he welcomes work of just this character, for well does he know that in selecting him for critical assignments the company is systematically training him with a view to future promotion.

But behind all of this lies a fact of even greater significance. Before ever he was assigned to work of this nature the officials of his company had satisfied themselves of his absolute loyalty to the interests of the department.

Loyalty in business does not consist solely of a general observance of the principles of honesty and truthfulness—not by many leagues. While these qualities are absolute necessities to success in claim work, as in fact in all other lines of employment, they of themselves alone leave much to be desired.

In claim work much necessarily is left to a man's honor.

If he so elects it is a comparatively simple matter for him to deceive his chief, for a limited time. It is, of course, possible for him to obey instructions in a sense, while at the same time disregarding utterly the spirit in which they were given. No better test of this is possible than for an investigator to ask himself, "Am I doing my level best for the company?" Let him disregard for a moment the avalanche of "ifs" and "buts" which invariably spring into activity at a time such as this. Meet the issue squarely and decide the question upon its merits.

A man may voluntarily choose to deceive others for a time, but when his own future success in life hangs in the balance and he is sufficiently in earnest to weigh cold, hard facts in the light in which they actually exist, there is at least one man whom he cannot fool. That one man is himself.

Consider for a moment the case of the young investigator who telephones into headquarters at the close of the day to the effect that he "has been busy the entire afternoon, but has been unable to see witness Frank Maxwell."

In a sense it was true that he had been "busy" the entire afternoon and likewise that he had been unable to "see" witness Maxwell, which facts in themselves were nothing alarming, since his "busy" afternoon had been spent in rooting hard for a victory for the home team out at the American League grounds. These latter facts, however, he neglected to mention in his report to the chief.

In thus taking valuable time off duty without permission the investigator doubtless gave the matter but little serious consideration aside from the framing up of a suitable excuse to shield him from detection. That he was voluntarily placing an obstacle in his own path to success probably never occurred to him. Not that this single incident of itself alone was of such vital importance, but because it established beyond contradiction the fact that loyalty to his employers was lacking in his make-up.

Again, take the problem presented by the investigator who devotes more time to studying his own ease and comfort than he does to the securing of results in his work. We will say, for example, that he has been given the address of a claimant as 3337 Washington avenue. He calls at this address and finds it to be a Chinese laundry with no such party residing there. He lets it go at that, reports to headquarters that the address is fictitious and makes no further effort of his own volition to run the claimant down.

Yet no one knows any better than does he himself that some error doubtless has been made in writing down the number. Instead of canvassing the vicinity and of then working numbers 337, 333 and 37, he prefers to lie down on the assignment, with the chances thereby strengthened for a miscue in the company's wishes regarding that particular case. Loyalty to his company is at a low ebb with him. Otherwise he would have done his level best to have located that claimant.

While men of the character cited in the foregoing illustrations may have redeeming features in other directions, nevertheless the absence of loyalty, from a business point of view, constitutes a fatal defect in their equipment for successful work in the claim and accident field.

Absolute loyalty to an employer counts heavily in judging men for promotion in the claim department. It is a matter well worth careful thought upon the part of every young man engaged in the work.

[The second "Talk" with claim investigators will appear in an early issue of the Electric Railway Review.—Eds.]

It is announced that a syndicate has been formed in Rome to build a power plant at Treni, in Apulia, to produce current for the operation of three railways, from Treni to Corato, from Treni to Andria and from Fernandino to Trinitapole. The station will also supply current to surrounding towns.

## EMPLOYMENT OF TRAINMEN ON METROPOLITAN ELEVATED RAILWAY.

The Metropolitan West Side Elevated Railway of Chicago operates several branches covering a large district in the west side of Chicago. The present management of the company has made changes in the system of hiring and instructing trainmen, which now follows in many respects the practice of some steam railways. Owing to the large number of applications at present the standard to which applicants must conform is higher than during times when requests for employment are fewer. To be considered favorably applicants now must be at least 23 years of age, 5 feet 10 inches in height or over and must have had previous railway experience.

### Sight, Color Sense and Hearing.

An applicant for a position in the train service is required to fill out an application blank. When satisfactory responses have been received by the company to letters of inquiry sent to former employers and to those to whom references as to character are given, the applicant is obliged to take an examination to determine whether his eyesight, ability to distinguish colors and hearing are of the standard required. During this examination the applicant is first required to read various sizes of small type and also standard test type, which is displayed under electric light. He is obliged then to test the correctness of his color sight. Rapid changes in colored lights are made by the examiner with a test lantern manufactured by Peter Gray & Sons, Inc. of Boston. This lantern contains six colors, the relative position of which can be transposed in order that the correctness of the sight of the applicant may be thoroughly tested. If the result of this test is not satisfactory another test with skeins of wool is insisted upon.

A regular form is provided for the "record of examination of sight, color sense and hearing." This form provides for a record of the tests as to the acuteness of vision without glasses, showing the distance in feet at which the standard test type is read and the smallest line of standard test type is read correctly with the right eye, the left eye and with both eyes. The examiner notes on the form whether the selection of skeins is made promptly or hesitatingly. The form provides space for stating the number of feet at which the applicant can hear and repeat correctly numbers or words spoken in a conversational tone. Both the right and the left ear are submitted to this test. Space is also provided on the form for any remarks in relation to the sight or hearing of the applicant, who is asked to sign the report.

After passing this test satisfactorily an applicant is then interviewed by B. I. Budd, the general manager, and if his general appearance and the references make it evident that he would be a desirable employe he is provisionally employed and given an order for a uniform cap, but not for a uniform. The applicant is then directed to report to M. J. Feron, superintendent of train and station service, who gives him an outline of the duties of a guard, dwelling particularly on the necessity of exercising care in giving signals, closing gates, etc.

The next step is to send the applicant to an instructing conductor, who teaches him the duties of a trainman, taking three days or as much longer as may be necessary. The conductor reports to the superintendent on a blank form regarding the progress made by the applicant. The applicant is also instructed by the dispatcher. After these instructions have been given the dispatcher notifies the superintendent that he has instructed the student regarding schedules, bulletins, orders, assignment list and reporting time as posted at the terminal to which the man is assigned. The dispatcher also teaches the man how to couple and uncouple air and power hose and cables and to turn the lights and heat on and off in cars, and warns him regarding the danger of the third rail in the yard and on the structure. Hose are fastened to the walls of the different terminal houses in order that instruction

as to their use may be given. At the end of this period of instruction the applicant reports to the superintendent for examination and if it is then believed that he will make a good employe he is assigned to the position of an extra guard and is directed to purchase a uniform. During the first two months of service a new employe is subject to the supervision of service inspectors in order that his familiarity with his duties may be proved.

**Credits Determine Standing.**

When an applicant is employed he is given 100 per cent credit. A record of each employe is kept by a card system; for each month after entering the service, if no offense requiring discipline has been given, an additional credit of 2 per cent is added to the initial 100 per cent. For committing an offense an employe is fined a certain percentage. This has the effect of causing him to lose standing. The chances for promotion, choice of run, etc., are determined by the standing shown in the percentage cards. When an employe passes from one class of position to another, as from guard to conductor or conductor to motorman, he begins in that service with a similar credit of 100 per cent. Some of the oldest conductors and motormen in the service, whose standing is good, arrange their runs so that after 10 hours' work each day

on curves, etc. The employe is then sent to the surgeon of the company, and if his physical condition is found satisfactory he is given a permit to ride with an instructing motorman.

The instructing motorman first gives the student an outline of the equipment and the operation of the apparatus without entering upon any details which would confuse him. The student then is allowed to make several trips in the cab with the instructing motorman, but is not permitted at once to operate the car or to handle the air brakes. The notice of the superintendent regarding the assignment of the student states that the instructing motorman will be in general charge of the train and responsible for its safe operation. A student is permitted to operate a train only when, in the judgment of the instructing motorman, it is safe for him to do so.

**Studying Duties of Motorman.**

The instructing motorman directs the student as to signals, train operation and troubles with which he may meet in the apparatus, as indicated on an instruction blank provided by the transportation department. The introduction to this instruction blank states that the questions are intended "to assist motormen in giving proper and uniform instructions to students. All motormen 'breaking in' men must see that

- |  |   |
|--|---|
| <p>12. What form of air brake do we use?.....</p> <p>13. Why is it called an automatic brake?.....</p> <p>14. What are the parts of an automatic brake on a motor car? .....</p> <p>15. Where are the motorman's brake valves and gauges located? .....</p> <p>16. How is air compressed for use in the brake system?...</p> <p>17. How does the air apply the brakes?.....</p> <p>18. How is the brake released?.....</p> | <p>12. Westinghouse automatic with graduated release.</p> <p>13. Because if anything causes a reduction of pressure in the train pipe the brake will apply automatically.</p> <p>14. See Rules Nos. 189 to 199.</p> <p>15. In cabs.</p> <p>16. By air compressors or pumps placed under the cars.</p> <p>17. By being admitted to a brake cylinder and forcing out a piston which by means of its connecting rods and levers forces brakeshoes against the wheels.</p> <p>18. By allowing the air in the brake cylinder to escape to the atmosphere. A spring in the brake cylinder then shoves the piston back and the brakeshoes, assisted by truck release springs, will leave the wheels.</p> |
|--|---|

**Employment of Trainmen on Metropolitan Elevated Railway—Sample Questions and Answers from Motormen's Instruction Blank.**

they are given employment as platform men for an hour and a half during the evening rush hours.

In the course of time a man who enters as an extra guard, provided his record is good, is promoted to the position of regular guard with a regular run. The position of conductor is secured by promotion from the list of regular guards. A regular motorman obtains his position through promotion from the list of conductors after he has had experience and has qualified as extra motorman. After an employe has been in the train service a certain length of time he may make application to learn the duties of motorman. The application must be approved by the dispatcher on the branch on which the man is working and must be sent to the superintendent. No regular limit is fixed as to the time an employe must be in the service before the application will be approved by the superintendent. The length of time depends upon the former experience of the employe, his age and general qualifications. A man who has had previous experience as a switchman or brakeman on a steam railway will be approved as a student for instruction in the duties of motorman as soon as he is familiar with the elevated railway. After the application is sent to the superintendent the employe is notified to appear before the superintendent. If on this occasion he passes favorably a general examination as to his knowledge of the road and the duties of a trainman and the superintendent feels that the man may be able to become a good motorman, the application is approved. The superintendent cautions the employe regarding the importance of his duties and warns him as to the necessity of always being alert and attentive to his work and of being careful to observe the condition of the rails, speed

students thoroughly understand the operation of trains in accordance with the rules and regulations of this company and that they are fully acquainted with all conditions a knowledge of which is necessary for safe operation." This blank contains 84 questions and answers. The accompanying illustration shows some of the questions and answers.

**Precautions Observed.**

The instructing motorman is required to sign a statement that he has directed the student concerning "the safe operation of a train in service" and has "fully acquainted him with all signals, speed limits, station stops and general conditions existing on . . . . . branch." The instruction must be completed and the student ready for examination at the end of 60 days. When the student reports to the superintendent for further examination he is expected to be able to answer any or all of the questions on the motorman's instruction blank. The student must sign a statement that he has received instructions from the instructing motorman and an examiner is required to certify that the student is competent to operate a train with safety and according to the rules and regulations of the company.

The superintendent sends a personal letter to the instructing motorman regarding the student, which says that the student must not be reported until the instructor is "satisfied that he understands thoroughly the apparatus of our motor cars and is perfectly familiar with all signals, speed limits, station stops and the general conditions existing on our road. You will also advise me of the number of trips he made with you, his general ability to handle trains and also



his weak points as noticed while he was with you. This information will be considered strictly confidential and is to be returned to me in an envelope marked personal."

The superintendent examines the student on every detail of the duties of a motorman. After this examination has been passed satisfactorily the student reports to the general manager and, if then accepted, is placed upon the acting motormen's list and is given extra work as the opportunity may occur.

Switchmen, towermen and switch tenders are selected from the extra guard list, preference being given to men who have had former railway experience. A student switchman is obliged to pass the same examination as a student motorman before he is accepted as a competent switchman.

The foregoing information was furnished by Calvin E. Patten, secretary to the president, Metropolitan West Side Elevated Railway.

**CUTTING NEW PINIONS FROM OLD PINIONS—INDIANA UNION TRACTION COMPANY.**

The Indiana Union Traction Company has just put into practice in its new shops at Anderson, Ind., a "shop kink" which is interesting and shows a decided economy. The company has 11 different varieties of motor equipments and it has been found possible to take the worn-out pinions of the larger sizes, turn off the worn-out teeth and recut new teeth in the blank, making a new pinion from an old one.

As there was no gear cutter or milling machine in the shops an attachment was made to do the work on one of the lathes. A casting was fitted on the cross slide of the lathe, as shown in the illustrations. On top of this lower casting was

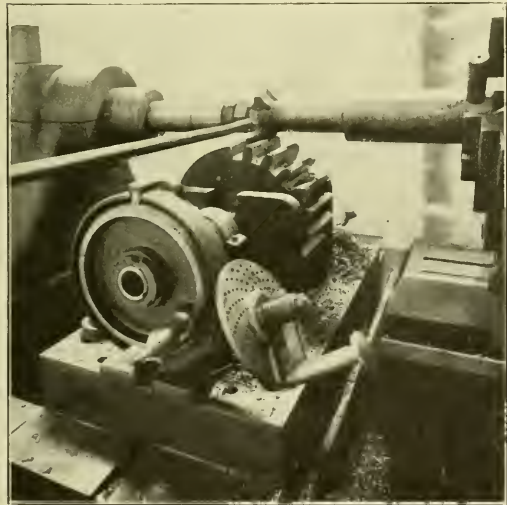

Indiana Union Traction—Recutting Pinions—Rear View, Showing Index Centers.

fitted another which carries the index centers and the pinion. In order to get the proper adjustment for depth of tooth these two castings are joined by inclined surfaces, the upper one arranged to slide along the lower inclined surface until the blank is set at the proper height for the depth of tooth to be cut. The teeth are spaced by an index head. The cutter is carried on a mandrel, but the smaller end, instead of being supported on the tail center, has a sleeve surrounding it close up to the cutter.

This device was designed sufficiently strong so that it

would be possible to do rapid and accurate work. The teeth of a 2½-pitch steel pinion are cut to the full depth at one cut. The cutter is speeded to 52 feet per minute and the blank fed against it at a speed of 1 inch per minute. Lubricating fluid is forced against the cutting edges with compressed air.

With this device a 20-tooth 2½-pitch Westinghouse 50-C pinion was made from an old Westinghouse 85-27 tooth pinion at the following cost:

Turning blank, one hour's time at 17½ cents per hour	\$.175
Cutting teeth, three hours' time at 15 cents per hour	.45
Scrap value of worn-out pinion, 110 pounds at ½ cent per pound	.55

Total cost of recut pinion .....\$1.175

Besides the economical value of this practice there is the additional advantage that instead of having to carry 11

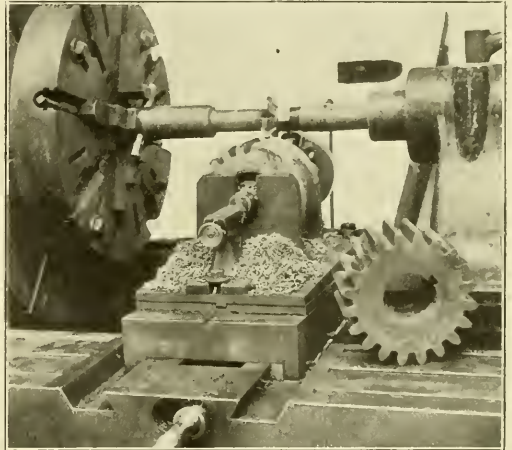

Indiana Union Traction—Front View, Showing Attachment to Cross Slide for Holding Blank.

different varieties of pinions in stock only four kinds are now required. This apparatus was designed and made at the company's shops at Anderson, Ind., which were described and illustrated in the Electric Railway Review for January 18, 1908, page 67, in an article written by R. C. Taylor, superintendent of motive power.

**Accidents Discussed in Baltimore Bulletin.**

Part II of Bulletin No. 7 in the series published by the United Railways & Electric Company of Baltimore is entitled "More About Accidents and Their By-Product, the Ambulance Chaser." The company states its policy as follows:

"All cases are settled out of court except where, after careful investigation, we believe: (1) That the claim is a manufactured one; (2) or that the injury was due to gross carelessness on the side of the claimant; (3) or that the claimant is demanding excessive damages. Statistics show that in more than half the cases tried the plaintiff gets nothing from the jury; and that in a large proportion of verdicts for the plaintiff the amount recovered (which the plaintiff must divide with his lawyer and the latter's 'runner' and 'medical expert') does not exceed the sum which could have been secured without litigation."

The bulletin concludes by pointing out ways in which people interested in securing a "square deal for good service" can help the company.

The Philadelphia Rapid Transit Company is said to be considering the adoption of pay-as-you-enter cars.

## THE RELATION BETWEEN BANKER AND ENGINEER.\*

BY J. C. KELSEY.

In all public utility financing you will find the bankers. They are as necessary as doctors and nurses in a plague. They furnish the respectability and responsibility, and take their allotments of the issue.

President Roosevelt has apparently caused some trouble in the financial world, but he is only taking up the people's cry for investment protection. He has aimed no blows at the honest banker or the honest security dealer. He has paved the way for the glaring exposure of the security faker.

Most of us have a childhood recollection of the mortgage on the farm. It was a gloomy substance and it cast sinister shadows over our youthful pastimes. It filled our hearts with dread. At Christmas time, even traditionally kind Santa Claus passed us by, because he, too, dreaded the mortgage; so the whole family struggled with sickening fear clutching at our hearts. And why? Because a first mortgage upon that home was and is a safe investment—a real security for the holder. It holds the property at a sacrificial figure. The value of the farm exceeds considerably the face value of the loan. The terms of that mortgage are such that the family will not think of giving up the property, but will manfully struggle to meet payments when due. At no time is the holder of that mortgage uneasy; but in the general security market the shoe is on the other foot. The word no longer signifies the slavery and bondage of the property, but mostly signals the folly of the holder.

We all know of properties that are bonded for more than their value and earning power and each day we hear of companies defaulting on interest. The widow who once looked hopefully forward to coupon clipping time and the return of the check now has reason to dread a notice coming through the mail, accompanying her coupons, informing her that a receiver is in control of the property and that her investment is hopelessly tied up; or, more futile still, that a committee has been appointed to investigate what caused the wreck. It is the old story of locking the barn door after the horse is gone.

The banker, whether conscious or not, has been and is a security faker. Not in all cases, of course. There are savings banks in Chicago which, in paying 3 per cent to frugal depositors, try to make us think they are public benefactors. Scattered about on their counters one will find prospectuses of bonds, telling alluringly of good things. The banker does not care to have the depositor's funds withdrawn, but if he can sell a bond at \$100, netting the frugal depositor 5 per cent, instead of 3, and netting the banker \$35 or \$45, of course, he willingly advises the depositor to buy it. If this banker would carefully investigate the property he might not find it desirable. He might find that there was no contract regarding its management. He might learn that there was no provision for an honest renewal reserve. The worst of it is, judging from security prospectuses seen lying around, he does not care. He simply sells bonds at a profit, washes his hands of the deal and denies that he is his brother's keeper.

We have a feeling of indignation when we read of the abandonment of a helpless infant upon a front door step, and the persons involved take no more precaution than to ring the bell. Yet the man who sells a security and runs away after collecting the money deserves our indignation. He is an unnatural father and deserves punishment. According to the "square deal" the banker who sells securities should father them. He should be responsible for them, and should be willing to buy them back at any time there is a hitch in interest payment, or any entanglement thereupon. There is a banking house in New York which handles immense issues of securities. At one period of its successful existence, through misrepresentation on the part of an adviser, the house got hold of a disappointing property. After selling thousands of dollars' worth of securities the erratic features of the deal were discovered. Did these people make the usual whine that they "didn't know" and thereby and forthwith abandon the luckless buyers to their fate? No, this house, situated in that alleged to be heartless and soulless Wall street, promptly notified the buyers of the deception and paid them back dollar for dollar. In other words, this firm fathers the bonds it sells. And this brings out the relation of the banker to the engineer.

If the banker does not wish to be deceived as to the worth of the property he must have competent advice. Not only must the auditor go over the books, but the engineer must go over the physical property. He must understand the needs of the property, not only now, but 10 or 20 years

hence. He must thoroughly understand depreciation. He must be thoroughly familiar with the best operating methods and able to judge exactly as to the competency of the management.

The engineer must be a business man. Engineering is a business and not a profession, as some are determined to have it. The successful engineer may stand for ideals, but he bears in mind the natural demands of the banker and public, that the property receive sufficient money, pay out money, and, like the individual, save money for a rainy day. This homely expression signifies the necessity of what is called the renewal reserve. In all properties owned by security-holders there is a sacred necessity which lies in the saving of enough money out of the daily or yearly income to take care of all changes in the art, all destruction due to the elements, and to hold the value of a \$100 security at \$100 or over for all time.

As the property wears out it decreases in value. Assume that, in a certain time, it decreases to a value of 90 cents on the dollar. Then the security owner is entitled to be assured that the necessary 10 cents is in the reserve treasury and available for the purpose of holding the value at 100 cents on the dollar; in other words, to be sure that there will be no assessments, or cessation of dividends, to take care of depreciation.

The renewal reserve charges should come ahead of the bond interest. If a property cannot pay renewal reserve charges and bond interest simultaneously there should be a default. A property that is not protected by a cash renewal reserve is not a real conservative investment. Book reserves are of no value, and reserves invested in the property itself do not carry out the idea of security. Railroads could invest reserve funds in the property or coal lands and carry out the idea nicely, and electric light, trolley and telephone systems could safely invest reserve funds in the municipal bonds of their immediate localities and carry out the idea of absolute security; but this idea is rarely fulfilled.

The engineer takes the following part in a contract between the banker and the property management, after the questions of reserve and other details are settled. The contract should contain the following thoughts at least:

"The engineer of the bankers shall be furnished every facility to inspect the plans proposed for construction of extensions and improvements, the contracts and prices paid for labor, material and incidentals connected therewith; and the work during its progress, in order that he may certify that the plans adopted are the most economical to produce the best results, that the prices paid are the lowest consistent with first-class work, and that the work has been executed within the terms of the mortgage. He shall have access to all operating departments, and shall be furnished with all desired information. He shall have power to make tests, and to criticize operating methods. He shall report directly to the bankers, and said report shall not necessarily be accessible to the active management of the property."

It is understood that the contract gives the banker power to act upon the recommendations, but that is another story. With such a clause as this the banker has direct means of knowing accurately every vital point concerning the property he has so nicely described to the public. If the management of the property is niggardly with maintenance and repair, thereby rendering the contracted renewal reserve fund insufficient, the banker can call a halt. If the management is extravagant in operation and conduct of the business, thereby endangering bond interest, the banker knows it before it is too late.

The day is coming when all public utilities will have to take a defined position. Through the medium of broad-minded state commissions, properties will be conducted differently in the future. They will have to meet public demands promptly. They will not dodge taxes. They will be responsible for their employees' safety. They will have to co-operate with municipalities in beautifying cities. They will have to maintain renewal reserves and shall be ordered to invest them by law. Under the new order, securities will be guaranteed because the property has conformed to the commission's orders. There will be many things required of the companies that would give the present directors and legal advisers apoplexy. This tendency means simply a closer study of reserves. The state commissions are studying the matter with us, and as engineers we shall help them to arrive at good conclusions.

The panic of October and the subsequent decline in business activity was not caused by President Roosevelt or the New York stock exchange. The recklessly run trust companies temporarily furnished the germ of overprosperity, and later their own game of imbecile finance paid the penalty. Any security was snapped up by these concerns, and for a time they made fabulous profits; but the old saying, "Truth is

\*Abstract of address delivered before the Western Society of Engineers, Chicago, April 10, 1908.

mighty and will prevail" proved itself once more. Then followed a panic of distrust, ruin and suicide.

But a new day is dawning. All things commercial will have to be satisfied with less profit, because lessened risks will be demanded. The sober-minded public which does the investing will demand reasonable profit, and absolute safety. The public will always have money to invest. There will always be a chance to invest. The public will always invest through the banker. The banker will have to practically guarantee his investment advice if he expects to survive. To do this he will seek the engineer.

The investments of the public will be guaranteed in their fullest sense only when there is a wedded relation between the ideals of the banker and engineer.

**NEW CARS FOR THE BUFFALO LOCKPORT & ROCHESTER RAILWAY.**

The Buffalo Lockport & Rochester Railway of Buffalo, N. Y., which expects to complete before July 1 its line from Buffalo to Rochester, N. Y., will soon receive from the Niles Car & Manufacturing Company 15 combination passenger smoking and baggage cars, as illustrated in the accompanying engraving, and two express and baggage cars. The dimensions of the passenger cars are as follows:

Length over buffers.....	51 ft. 8 in.
Length over vestibules.....	50 ft. 4 in.
Width over side panels.....	8 ft. 4 in.
Length of smoking compartment.....	11 ft. ½ in.
Length of main passenger compartment.....	26 ft.
Height from rail to top of trolley bridge.....	12 ft. 3 in.
Width over all.....	8 ft. 6 ½ in.

The side sills are of yellow pine, 4 ½ by 7 ¾ and 2 by 6 inches, with a ½ by 6 inch steel channel bolted between. The four intermediate and center sills are 6-inch steel I-beams. The platforms at each end are flush with the car floor, the center sills extending from buffer to buffer under the vestibules. The floors are laid double with heavy building felt placed between the two sections.

The interior is finished in first quality mahogany. The ceiling is semi-empire style, painted and decorated in green and gold. Polished American plate glass is used in all main sashes and cathedral art glass in the upper sashes. Panta-

on Baldwin heavy interurban trucks, with Standard solid forged and rolled steel wheels. The wheels are 36 inches in diameter, with 3-inch tread and ¾-inch flange, and are mounted on Standard hammered steel axles 5 ½ inches in diameter at the center, with 5 by 9 inch journals. Symington journal boxes are used.

Each car is equipped with General Electric No. 73 75-horsepower motors and Westinghouse automatic air brakes. The special equipment includes Peacock "C" drum brakes, with Dayton No. 11 bronze ratchet brake handles, two Nichols-Lintern air sanders on the front of each car, Consolidated Car-Heating Company's No. 24 electric heaters fastened to the truss plates and Kalamazoo snow scrapers.

**ARC LAMPS FOR ILLUMINATING CAR INTERIORS—METHOD OF WIRING.**

In the Electric Railway Review for March 14, 1907, page 318, we discussed the value of arc lamps for illuminating car interiors, mentioning several companies which favor this prac-

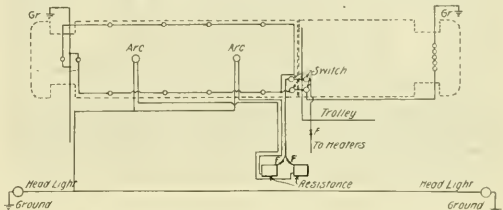

Pacific Electric Railway—Light Wiring for Arc Lamps.

tice. The accompanying sketch presents the main car wiring circuits for the large high-speed cars of the Pacific Electric Railway at Los Angeles, Cal. It will be noted that these cars are lighted with both incandescent and arc lamps. The two interior arc lights are connected in parallel and the pair is connected in series with the headlight, as shown in the sketch.



Combination Passenger Smoking and Baggage Car for the Buffalo Lockport & Rochester Railway.

sote curtains with Burroughs roller tip fixtures are fitted to all windows. The seats are of the Heywood Brothers & Wakefield Company's manufacture, 36 inches long, with an aisle arm rest, the aisle being 19 inches wide. The seats are of the head roll style, with backs 24 inches high, and are fitted with bronze grab handles. The upholstery in the passenger compartment is Nile green plush and in the smoking compartment first quality leather. Each car has a toilet room with cement floor and Metile lining.

As shown in the engravings, the cars have double buffers. The upper one, which is fastened directly to the car sills, is for interurban service; the lower one is of a height corresponding to that of the city cars of Buffalo and Rochester.

Both the passenger and the express cars are mounted

Cars illuminated with arc lights present a more brilliant effect than when incandescent lamps are used. Those roads which employ arc lights for illuminating the interiors of their cars consider this method as a vast improvement over incandescent lighting, especially on interurban lines where the voltage regulation is not usually any too exact.

The pay-as-you-enter cars which were placed in operation on January 5 by the International Railway of Buffalo on its Niagara avenue line have proved so successful that it has been decided to use this type of cars on the Grant street line also. The cars formerly used on Niagara avenue are now being remodeled into pay-as-you-enter cars at the company's Cold Spring shops.

### THE STRANG GAS-ELECTRIC MOTOR CAR.

The gas-electric motor car as used for transportation purposes has reached a stage of development where considerable attention is being given to the particular service requirements which it is capable of filling. This type of car is designed for use on roads where the traffic is not sufficiently dense to warrant the operation of steam trains or electric cars on short headway. A new car of this type has just been built



Strang Gas-Electric Motor Car—Interior View.

for the Strang Gas-Electric Car Company, 15 Wall street, New York, by The J. G. Brill Company, Philadelphia. A number of new and interesting features, both of construction and operation, are included in its design.

The Strang system consists of a gas engine with a direct-connected generator, electric transmission and control, direct

The one serious objection to a type of car employing a combination gas engine and electric generator has been the vibration, which in some instances has been noticeable to a marked degree. In the construction of the new car the sills and framing have been designed with a view to preventing this vibration. The two steel center sills extend from bumper to bumper. At that end of the car where they pass directly under the engine these sills are much heavier than at the trailing end of the car. This weight provides the strength necessary to support the engine and generator and by the tapering to a smaller size at the rear affords a strong under-frame of comparatively low weight. The arrangement of the side framing does not differ materially from that used in steel car construction.

The car measures 66 feet over all, is 9 feet 6 inches wide and 14 feet high. The weight complete is 114,000 pounds. The engine is of the vertical 4-cylinder type, having six cylinders 10½ by 9 inches, with a continuous rating of 150 horsepower at 425 revolutions per minute. The generator is of 85-kilowatt capacity at 250 volts. It is a direct-connected shunt-wound interpole machine. There are two interpole motors of 100 horsepower each, series-wound for 250 volts. The battery comprises 112 Planté type cells, having a capacity of 300 ampere-hours; General Electric type M control with bus connections for supplying current to a second car, and Westinghouse automatic air brakes. The cooling and heating system consists of an electrically driven centrifugal pump which circulates the jacket cooling water through either the radiators on the roof or through the heating pipes in the passenger compartment. The engine end trucks are the Brill 27 E-3 type to carry 73,000 pounds, and the trailer trucks are the Brill 27 E-2 type to carry 42,000 pounds loading. The special equipment includes Janney automatic couplers, Nichols-Lintern sanders and Adams & Westlake baggage racks.

The interior of the body is divided into an engine room, 13 feet long, and two compartments, smoker and parlor. An observation platform at the rear will conveniently seat five passengers. The total seating capacity is 75. There are



Strang Gas-Electric Motor Car—Exterior of New 66-Foot Car.

electrical connection between the generator and truck motors and a storage battery. The operation of the car is practically the same as an interurban trolley car, but, unlike the trolley car, it produces its own current and is therefore independent of trolley wire and power house. The generator and engine have a capacity sufficient for normal requirements, but when starting or when ascending a grade the storage battery takes care of the "peak" of the load. The storage battery is charged while the car is coasting down grades, coming to a stop or standing still; the gasoline engine running until it is automatically throttled as the batteries attain the full capacity.

eight double windows in each side of the car and over every other side post is a small semi-circular window for ventilation. The interior finish is in vermilion wood with ventilating windows of art glass and an art glass panel above each double window.

In starting the engine power is fed from the storage battery to the generator, which, acting as a motor, drives the engine up to speed. The car carries sufficient gasoline to run it 200 miles and consumes about six-tenths of a gallon per mile. The engine cooling system consists of radiators placed on the roof of the car and a circulation secured by a motor-

driven turbine pump. The passenger compartments are heated by pipes connected with the water system. This car will maintain a speed of 55 miles an hour. It can be made the motor car of a train, being capable of hauling three trailers carrying 75 passengers each. In the event of mishap the double system of power allows its batteries to carry it, for 15 miles if necessary, to a roundhouse or station.

The car body was designed by W. B. Strang, president, and L. G. Nilson, chief engineer of the Strang Gas-Electric Car Company. The engine and accessories were designed by Mr. Nilson and the generator and motors were designed and built at the Strang company's shops under the personal supervision of Messrs. Strang and Nilson.

#### POWER PLANT OF THE CENTRAL PENNSYLVANIA TRACTION COMPANY.

BY L. G. MORRIS.

The Central Pennsylvania Traction Company of Harrisburg, Pa., operates about 64 miles of track in Harrisburg, Steelton, Highspire, Middletown, Penbrook, Progress, Oberlin, Paxtang and Hummelstown. The power plant of the company, a preliminary description of which was presented in the

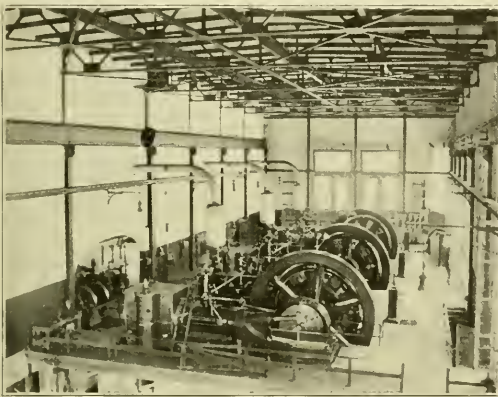

Central Pennsylvania Traction Company—Interior of Power House.

Street Railway Review for May, 1906, page 296, is located about 1¼ miles from the electrical distribution center of the system. The building is 40 feet high and occupies a ground space 175 by 103 feet. It is constructed entirely of concrete and steel, the roof also being of concrete reinforced with ¾-inch rods and covered with tar paper and slag roofing. The building is divided longitudinally into two rooms. In the front section are the main engines and switchboard; in the rear is the boiler equipment. Only about one-half of the floor space is occupied by the present equipment.

The center bay of the rear section or boiler room is used as a pump room and in it is installed the pump apparatus, comprising the boiler feed water, circulating water and air pumps, and the feed water heater. The floor of the second story of this section is constructed of steel beams and carries the economizers and the main smoke flue. On this floor and extending the full length of the space corresponding to that occupied by the boilers on the first floor is a coal bin having a capacity of 600 tons, from which coal is delivered by means of a traveling hopper to the boiler room below. Near the center of the building and under the track of the siding is a hopper which receives the coal as it is dumped from the cars. The coal first passes to a crusher and then to the boot of a vertical chain-and-bucket elevator. This elevator delivers the

coal to a screw conveyor in the roof of the building, by which it is distributed to the coal bin. The ashes drop from hand-fired Regan shaking grates to pits, from which they are removed in a steel dump car to the elevator boot, which carries them to the bin. From the bin they are delivered by means of a chute to a waiting car on the siding for final disposition. A reinforced concrete stack 215 feet high from the ground, with an inside diameter of 10 feet and resting on a solid rock foundation 20 feet below the surface, serves the boiler plant.

The present steaming equipment consists of five 327-horsepower water tube boilers, operated at a pressure of 175 pounds. These boilers were built by E. Keeler & Co. of Williamsport, Pa. Additional equipment, consisting of two Babcock & Wilcox boilers of 600-horsepower capacity each, has been ordered for installation in the near future.

A 30-inch jet type barometric condenser, built by the All-berger Condenser Company, is used. The water is delivered from the Susquehanna river to the condenser by means of vertical-shaft centrifugal pumps, installed in duplicate. The pumps and the horizontal engines which drive them were built by the Morris Machine Works. The boiler feed water pumps are of Worthington manufacture.

The main engines were built by the Allis-Chalmers Company, all of the three engines being alike in construction and of the horizontal cross-compound rolling mill type, with cylinders 22 and 48 by 42 inches. Each engine weighs 220,000 pounds and has a clearance of 5 per cent. Garlock metallic packing is used throughout. Richardson sight-feed oiling sets are fitted on the cylinders and the balance of the oiling is done by gravity system. The main shaft carries a 50,000-pound flywheel and the armature of the generator. The generators are of the Allis-Chalmers-Bullock railway type, having a rating of 600 volts and 1,084 amperes and will carry 50 per cent overload for hours without heating more than 40 degrees above normal. The armature weighs 38,500 pounds. The dimensions of the commutators are 80 by 12½ inches.

The switchboard was built by Westinghouse Electric & Manufacturing Company and comprises 26 panels equipped with all the latest improved instruments for direct-current work made by that company. The storage battery has 288 cells of the 21-G type, manufactured by the Electric Storage Battery Company, Philadelphia, Pa. The cost of the station was \$250,000.

The station at the present time is operated by 15 men, excluding the chief engineer. All men work by the hour on a 12-hour basis, each receiving pay in accordance with his position. On each shift of either night or day there are five men—one engineer, one oiler and three firemen. The other five, to make the 15, work all day work, making 10 hours each, on repairs to boilers, loading ashes, handling coal and general labor. The engineer on duty has full charge of the running of the plant and takes orders from no one but the chief engineer. All men change turns, working nights one week and days one week, except the 10-hour men, who work but six days a week, except when called out to do extra work.

The main engines run about 21 hours a day, from 4:15 a. m. to 1:15 a. m., all cars stopping at that time. At other times the power for lighting and similar uses is taken from the storage battery, which is cut on to the main busbar after the last engine stops. By this means we have power on all lines of the system at all times.

The new stock yards branch of the South Side Elevated Railroad, Chicago, was opened for traffic on Wednesday of this week and approximately 25,000 passengers were carried the first day. The line connects with the main line at Fortieth street and Indiana avenue, and extends to Forty-fourth street and Packer's avenue in the Union Stock Yards, forming a loop almost in the center of the yards. Transfers are issued to the main line. A special car made a special trip over the line on Monday.

NEW OFFICE BUILDING OF THE DULUTH STREET RAILWAY.

The Duluth Street Railway Company of Duluth, Minn., has recently completed a new 2-story office building, 40 by 80



Duluth Office Building—Exterior View.

feet in size. A photograph of the new structure is reproduced herewith. The general offices were moved to the new building last month from the power house, where they have been lo-

As will be noted from the engraving the exterior is of an attractive though simple design. The building is constructed of light-colored pressed brick, with stone foundations and trimmings and a sanded galvanized iron cornice. The arrangement of the first and second floors is shown in the accompanying plans.

The basement contains the coal room, ash bin and a storeroom. On the main floor are located the offices of the roadmaster, purchasing agent, superintendent and superintendent's clerk, also a fireproof room, toilet room, two extra rooms and rooms for purchasing agent's supplies and for lost articles. The second floor contains the offices of the general manager, auditor and chief engineer, also toilet rooms and a fireproof room containing a vault.

The building was designed by German & Lignell, architects, of Duluth.

PASSENGER DUPLEX HAT CHECKS.

Through the courtesy of G. C. Pierce, general superintendent East St. Louis & Suburban Railway Company, East St. Louis, Ill., we present an illustration and description of a new duplex hat check and fare receipt designed by him.

The check, each half of which is  $1\frac{1}{2}$  by  $3\frac{5}{16}$  inches in size, has been found very satisfactory when used with the Ohmer register. Its use also enables the accounting department to segregate the earnings between the different stations and assists the conductor in convincing passengers what the rate of fare is between the different points. In case of a complaint a passenger is provided with a receipt that he can present to the general office to establish the fact that he was a passenger on a certain car at a certain time and had paid for transportation between points named on the duplicate half of his check. The check also prevents passengers from riding beyond the point to which they had paid, and it assists the conductor in detecting passengers that have boarded the car when it is crowded.

Ten minutes before the Alton car leaves East St. Louis the conductor collects his fares and issues hat checks. Therefore he is able to leave East St. Louis with his fares all registered and he also is able to give his undivided attention to rules and regulations pertaining to the operation of an interurban line, and, moreover, he can then assist passengers in leaving and boarding the car. Each conductor is provided with a different colored hat check, and as their hat checks are printed in numerical order a passenger cannot leave one car and return on another, claiming a right to ride on his hat check, which he might have retained from the first conductor.

Mr. Pierce advises that there has been no copyright issued, therefore any company is at liberty to use this check. The copyright was applied for, but later on the request was made to cancel the application.

61612		A
FROM	TO	
55	ALTON	0
50	FEDERAL	06
45	EAST ALTON	10
40	HARTFORD	18
35	LAKEVIEW	120
30	MITCHELL	128
25	NAMEOKI	30
20	NIEDHAUS AV.	38
15	2D & McCAM.	40
10	E. ST. LOUIS CITY LIMITS	45
0	E. ST. LOUIS	150
0	ST. LOUIS	155
Half Fare	Transfer	Transfer

Duplex Hat Check.

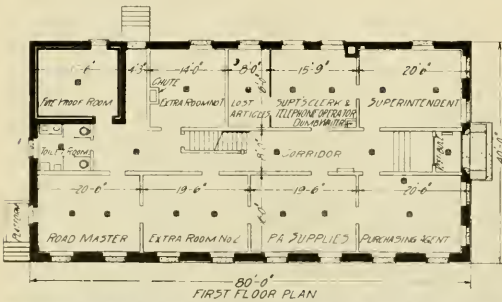

FIRST FLOOR PLAN

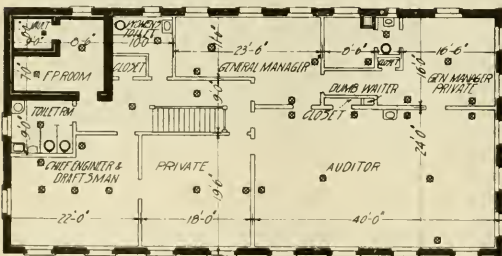

SECOND FLOOR PLAN

Duluth Office Building—First and Second Floor Plans.

came over since the company began using electricity as a motive power. The new building is located at the northeast corner of the block containing the company's car house and shops, at the intersection of Twenty-seventh avenue and Superior street.

Proposed Electrification at Boston.

Vice-President T. E. Byrnes of the New York New Haven & Hartford Railroad stated in an address before the Boston Produce Exchange on April 7 that if the proposed merger of the New Haven road and the Boston & Maine Railroad becomes effective, there is no doubt that inside the next five years the entire suburban train service of the two companies within 20 miles of Boston will be electrified. The electric service at the New York terminal has been successful and the next logical development is in connection with the Boston service.

AIR LIFT JIB CRANES AT OAKLAND.

In the Emeryville shops of the Key Route and the Oakland Traction Company considerable use is made of jib cranes of the type illustrated by the accompanying engravings. These cranes are installed at the ends of pits in the shops and also near the larger machine tools. Each crane comprises a vertical post of structural shapes supported at the top and bottom by trunnions which assure easy radial movement. The vertical posts carry two channel irons, on which rolls a 2-wheel carriage, supporting an air piston with a stroke of



Emeryville Shops—View of Crane as Installed.

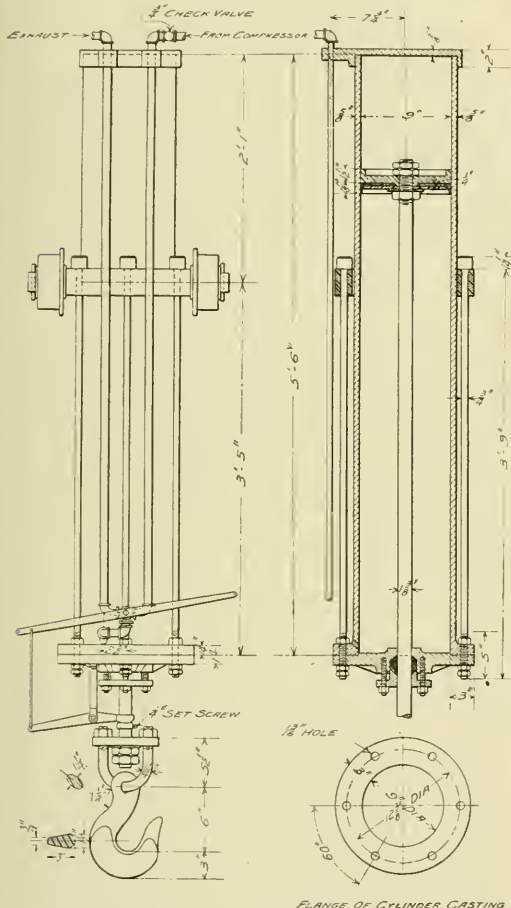

FLANGE OF CYLINDER CASTING

Emeryville Shops—Details of Air Cylinders.

about five feet. The lifting movement of the air piston is controlled by handles hung at a convenient height above the floor.

One of the accompanying illustrations shows the general dimensions of a complete crane and the other shows the detail construction of the air holst as it is supported in its carriage. These cranes have a lifting capacity of 4,500 pounds each.

The Massachusetts legislature has adopted a resolution asking the state railroad commission to state whether it would be feasible to equip all of the steam railroads entering Boston with electric locomotives within the city limits.

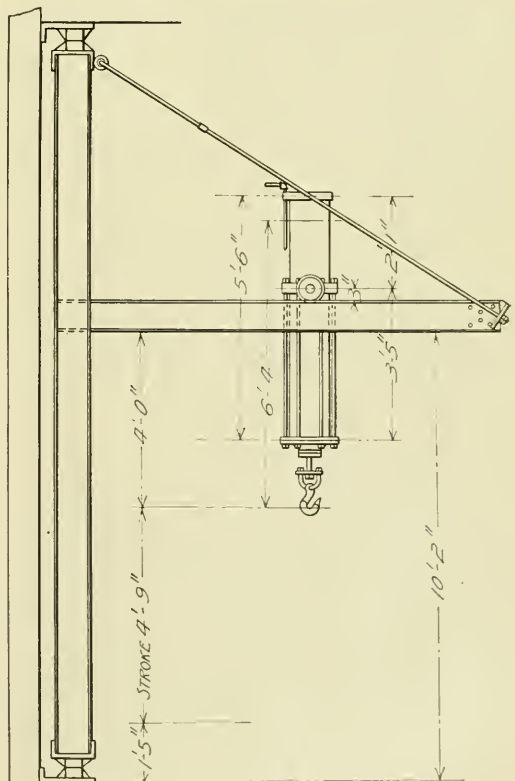

Emeryville Shops—General Dimensions of Crane.

### RECENT ELECTRIC RAILWAY LEGAL DECISIONS.

BY J. L. ROSENBERGER, LL. B., OF THE CHICAGO BAR.

#### Passenger May Testify as to Speed.

*Goodes v. Lansing & Suburban Traction Company*, 114 Northwestern Reporter, 338.—The supreme court of Michigan says that it was contended in this case that it was not competent to receive the opinion of a witness who was a passenger in an electric car as to speed, but the court holds that the testimony was properly received.

#### Use of Work Car Without Step—Alighting from Moving Car Where Snow is Banked.

*Flynn v. Connecticut Valley Street Railway Company*, 82 Northeastern Reporter, 1085.—The supreme judicial court of Massachusetts says that an assistant superintendent, while in the act of alighting, fell from a work car from which a step had been removed. It was this which caused the accident. There was evidence tending to show that he had called the attention of the superintendent to the absence of the step, and that the superintendent had promised to have it repaired immediately. How far he was justified in relying on the promise of the superintendent to have the step repaired, and how far, taking all the circumstances into account, the risk was to be regarded as an obvious one, and as having been assumed by him were questions especially within the province of the jury, as was also the question whether, in the exercise of due care, he should have looked, if he did not, before attempting to alight, and whether, if he had looked, he could have failed to see there was no step there.

Moreover, the court holds that it could not be ruled as matter of law, as the defendant in effect asked the court to rule, that the plaintiff was negligent not only in attempting to get off the car while in motion but also in attempting to alight while the car was in motion at a place where the road was banked with snow. It was not, as matter of law, necessarily negligent for him to attempt to alight while the car was in motion. Whether he was negligent in attempting to alight as he did at the place where he did was a question for the jury.

#### Transfers Cannot be Limited to One Direction When Statute Authorizes Trip Between Any Two Points.

*Wells v. New York City Railway Company*, 107 New York Supplement, 430.—The supreme court of New York, appellate division, second department, says that this action was for the statute penalty of \$50 prescribed by Section 104 of the New York railroad law, for refusing a transfer to a passenger. The plaintiff was at the corner of Lexington avenue and One Hundred and Second street, Manhattan borough, and wanted to go to the corner of Columbus avenue and Ninety-third street. These two points are on opposite sides of Central park, the one on the east and the other on the west side. He took a car on Lexington avenue going north, and on paying his fare asked for a transfer ticket that would take him to the said point he was going to. The conductor said he could not give it to him, but gave him a transfer ticket to go west on the cars on One Hundred and Sixteenth street to Columbus avenue. The plaintiff took a car west on that street, and on giving the conductor the transfer ticket for his fare asked him for a transfer ticket south on a Columbus avenue car to his said place of destination, viz., the corner of the said avenue and Ninety-third street, but it was refused him. He took a Columbus avenue car south, and was obliged to pay another fare. The defendant claimed that, as the plaintiff started north at the beginning, he was not entitled to a transfer ticket to go south at any stage of his journey—that the transfers must all be in the same general direction as the start—and that, while he could have had a transfer north on Columbus avenue, he was not entitled to one south. There is

no such limitation in the statute. The plaintiff could not get from his starting point to his destination except by going as he did north, then west, then south by Columbus avenue, unless he first went south, then west by Fifty-ninth street, then north by Columbus avenue. Either of these was his direct way to get from the one point to the other. The statute requires a village or city street railroad company to carry a passenger on a continuous trip "between any two points" on its road, or any connecting roads or lines operated or controlled by it, for one fare, and to give a transfer to the passenger entitling him to make the trip. That means across town as well as through town.

#### Line of Danger—Duty of Motorman Begins When Child Leaves Sidewalk and Starts for Track.

*Cornovski v. St. Louis Transit Company*, 106 Southwestern Reporter, 51.—The supreme court of Missouri, division No. 1, says that an instruction predicated liability on the fact that the motorman saw, or by keeping a vigilant watch would have seen, the plaintiff's child, Esther, crossing the street, and in position of danger of being struck by said car, etc., was claimed to be erroneous because it assumed the child was in a position of danger the moment she started across the street, instead of leaving that question to the jury to determine as a fact.

If Esther had been an adult in the possession of mature judgment, or had passed the years of infancy, and was arriving at years of judgment and sense, then, unless the motorman saw she was bent on crossing the track and was oblivious to her danger, it would have been error to have assumed that she was in danger from the very time she left the curb until she reached the track. Where the danger line would lie (with reference to the running of street cars) for an adult, or for one possessed of some years and some discretion, in crossing the street might very well be a matter of difference between good average men, and therefore a question for the jury.

However, in the case of a 4-year-old child, it is axiomatic that as soon as she left the sidewalk and headed across the crowded street she was in danger. The finding of a jury on that question would not instruct any court or subserve any purpose of the law and the assumption that the child was in danger the moment she left the curb was correct.

#### Care Required of Passenger Given Right to Ride on Inner Running Board.

*Simonton v. St. Louis Transit Company*, 106 Southwestern Reporter, 46.—The supreme court of Missouri, division No. 2, says that the plaintiff alleged that, the car being crowded, he was invited to ride, and did ride, on the running board, and that while he was thus riding he was struck and knocked from the car. An instruction was given the jury that it was the duty of the plaintiff, in going upon the inner foot board of the car upon which he entered, to exercise such degree of care as the position he was in rendered reasonably necessary to prevent his being struck by passengers on the car or by the car passing on the other track; and that if the jury believed from the evidence that the plaintiff, while upon such running or foot board, could, by standing upright thereon, and not leaning outwardly toward the cars on the other track, have avoided being struck by a passenger on or by the passing car, and that he failed to maintain such upright position and in consequence of such failure was struck and injured, then the plaintiff was not entitled to recover, and the verdict must be for the defendant. There was no error in this. While it might be said, upon the facts disclosed by the record, that the plaintiff had the right to ride upon the inner board of the defendant's car, yet it was equally clear that his position in so riding was attended with danger of being hurt. Therefore, in the court's opinion, it was very appropriate under the circumstances to direct the attention of the jury to the necessity of the plaintiff exercising due care and caution to avoid injury.



# News of the Week

## Detroit 3-Cent Fare Ordinance Enjoined.

Judge Swan of the United States district court on April 6 made permanent an injunction restraining the city of Detroit from enforcing the trolley ordinance, which would have compelled the Detroit United Railway to operate its cars on streets on which franchise rights have expired under regulations which provide for the sale of five tickets for 15 cents, universal transfers and the payment of taxes on an ad valorem basis. The injunction was obtained by the Fidelity & Guaranty Company of New York.

## Accident on the Aurora Elgin & Chicago Railroad.

A westbound car of the Aurora Elgin & Chicago Railroad struck a carriage at a crossing near Maywood, Ill., on Wednesday afternoon, killing the four women occupants of the carriage and injuring the driver so that he died a few hours later. The carriage was completely demolished and the bodies of its occupants were ground beneath the wheels of the car and carried for a considerable distance. The motorman was seriously injured. The crossing is near a sharp curve of the tracks, but is so located that the view was unobstructed. The car was moving about 50 miles an hour and was about 500 feet from the crossing when the motorman saw the carriage. He slowed down and sounded the whistle. The driver stopped, but evidently changed his mind, as he started again to cross in front of the car. It was then too late to stop the car and it ran for 200 feet beyond the crossing before it could be brought to a standstill.

## Work of the New York Public Service Commission.

The New York public service commission of the first district has issued a review of its work up to the present time. In addition to perfecting the plans of the Fourth avenue subway and laying out the route of the Broadway-Lexington avenue route, it has modified the plans for the Manhattan end of the Brooklyn subway loop, which is to connect the Brooklyn, Williamsburg and Manhattan bridges by a 4-track subway, so that trains coming from Brooklyn may pass through this loop and back over another bridge without switching on the Manhattan side. In the plans for all future subways provision has been made so that ordinary railroad coaches may be operated through them by increasing the height one foot. In regard to the Interborough-Metropolitan investigation which was conducted last fall the commission says: "The heavy load of overcapitalization under which the surface car system labored was discovered and defined. It is the belief of those competent to judge that the final result will be a general reorganization of these lines and the placing of many of them upon a solid financial basis, whereby it will be possible to operate them at a profit and give the public adequate service. Since the investigation was suspended last fall the commission has energetically gone into the work of inspecting the car lines and their equipment, with the result that orders have been issued for the practical overhauling and thorough repair of all surface cars operated in Manhattan, Brooklyn and the Bronx. The companies have accepted these orders and the work of repair has been under way for several months. The consequence will be that when open cars are put into service on the first of May, or thereabouts, the citizens of New York for the first time in many years will have the privilege of riding upon cars as good as new." The commission has also issued a report entitled "The History of State Regulation in New York," which reviews the history of the various railroad and rapid transit commissions in the state since 1855 and of the legislation leading up to the present development of the transportation facilities of New York City.

## Transit Affairs in New York.

The New York public service commission, at its meeting on April 2, passed a resolution instructing the chief engineer, Henry W. Seaman, to prepare detailed plans and specifications for the Broadway-Lexington avenue subway route, a map and description of which were published in the Electric Railway Review of January 4, page 19. The route has already been approved by the board of estimate and it is expected to have the plans ready for final approval by July 1. At that time the city's borrowing capacity will be increased by about \$50,000,000 and it is hoped that contracts may be awarded this year for the first sections of the work at least.

On the following day Commissioner Bassett presented a resolution advocating the construction of the Broadway portion of the Brooklyn subway loop before taking up the Broadway-Lexington route, in order to hasten the relief of the con-

gestion at the Brooklyn bridge by developing the transportation facilities of the Williamsburg bridge. The plan did not meet with favor and was referred to a committee of the whole.

On April 3 the board of estimate passed a resolution calling upon the public service commission to submit detailed plans for the Broadway-Lexington route within 60 days. The mayor and the comptroller opposed any action which might tend to commit the city to a plan for which money was available, but the board decided to put itself on record as favoring the proposed route. The present plan is to secure final approval of the subway plans and secure bids as soon as possible in order that the question of the city's ability to build the subways may be definitely determined when the contracts are submitted to Comptroller Metz for approval.

At a hearing before the commission on April 2 in regard to complaints that the Westchester electric railway companies impose a hardship on their employes through failure to provide closed vestibules on their cars, L. F. Crumb, counsel to the receiver of the Yonkers Railroad, stated that his company was financially unable to obey an order to equip its cars with vestibules. He said that the receipts at the present time were hardly more than the operating expenses.

The public service commission on Monday of this week began advertising for bids for the construction of the Brooklyn Fourth avenue subway, for which the forms of contract were approved by the board of estimate on March 26. Bids are to be received by May 8 and awards will probably be made within 20 days from that date. The route extends from the Brooklyn terminal of the Manhattan bridge to Fourth avenue and Forty-third street, Brooklyn, and is divided into six sections. Bids are to be received by sections. The estimated cost of the six sections is \$15,000,000 and it is probable that the city will not be able to undertake more than one or two sections this year.

## Fail to Reach Settlement in Cleveland.

The negotiations between the Cleveland Electric Railway and the city authorities of Cleveland looking to a settlement of the 7-year controversy under a plan which included a lease of the Cleveland Electric Railway and the Forest City Railway were broken off, temporarily at least, on Tuesday of this week. The arbitrators failed to agree on the value of the stock of the Cleveland Electric Railway. P. H. Goff, representing this company, refused the offer of Mayor Tom L. Johnson of \$50 a share for the stock and submitted a claim for \$61.75 a share, which did not include any allowance for good will. The mayor's offer was based on a valuation of approximately \$15,000,000 for the physical property, \$4,000,000 for franchise value and \$2,000,000 for good will. From this amount a little over \$9,000,000 was to be deducted for the payment of indebtedness. There are 234,000 shares outstanding. Mr. Goff's total was over \$23,000,000, and included a larger estimate than the mayor was willing to allow for overhead charges, financing and value of outside franchises.

Mr. Goff's decision to reject the offer was submitted to the directors of the Cleveland Electric Railway at a meeting on Wednesday and his action was unanimously approved.

Before discussion of the final valuation nearly all of the other details of the settlement were agreed upon. It had been decided that the Cleveland Electric Railway should increase its capital stock \$1,805,000 for the purpose of acquiring the Forest City Railway, and the form of the lease of the two properties under the name of the Cleveland Railway Company to the Municipal Traction Company, and the security grant to the Cleveland Railway Company had been agreed upon.

The drafts of the security franchise and the lease were made last week and the security franchise was submitted to the city council on April 6. The ordinance renews for 25 years all existing franchises owned by the Cleveland Electric Railway in return for a surrender of the present franchises. The downtown section is to be made free territory and the city reserves the right to grant joint use of tracks to any other company. The cash fare is to be five cents and six tickets are to be sold for 25 cents. The city reserves the right to purchase the property at the end of the franchise period at a price to be agreed upon by the city and company or by a board of arbitration. This price shall represent the cost of reproduction of all the physical property, less a reasonable amount for depreciation. If, at the expiration of the grant, the city does not renew it or purchase the property the franchise may be granted on the same terms to another company. In case the company fails to comply with the conditions of the grant it shall forfeit all rights and privileges contained therein. The right to regulate the service is reserved to the city council.

The form of the proposed lease of the Cleveland Railway to the Municipal Traction Company provides for a lease for 50 years at a rental of 6 per cent. The holding company

binds itself to pay the just obligations of the Cleveland Railway, to carry out the contracts of that company, and to maintain the property within 70 per cent of its reproduction value. For this purpose the company must lay aside the first year 5 cents per car-mile, the second year 5½ cents and for each succeeding year 5½ cents. The holding company agrees to take no lease of any other company without the consent of the Cleveland Railway and also agrees to seek franchises to keep up with the development of traffic. The Cleveland Railway is required to issue \$15,000,000 of stock for improvements at the request of the holding company.

The right is reserved to the city to purchase or lease the property at the expiration of the lease if it has the power at that time. The purchase price in such case is to be 10 per cent above the valuation of the property, less depreciation. Provisions for a forfeiture of the lease were purposely made loose. In case the Cleveland Railway fails to have the security franchise renewed every 10 years the lease is to be forfeited. The lease may also be forfeited in case the holding company fails to pay interest on bonds, or fails for eight months to pay the rental.

No fixed rate of fare is specified in the lease. The rate is to be as low as possible to provide for a return of 6 per cent on the value of the property. Mayor Johnson explained to the city council that it was proposed to lower the fare gradually and that a 3-cent fare would not be put into effect for 60 or 90 days. The plan was to charge a 3-cent cash fare for the first 30 days and charge one cent for transfers; then to charge 3½ cents fare with free transfers. In this way statistics might be obtained on the relation of fares and transfer privileges to traffic.

#### Legislation Affecting Electric Railways.

**Ohio.**—The house on April 7 passed the Schmidt bill, which had already passed the senate. The bill provides that franchises on streets occupied by street railways may be granted to new companies or renewed upon the expiration of the original franchises without the necessity of securing new consents of property owners. As amended by the house the bill provides that the action of city councils on franchises shall be referred to a referendum vote upon application of 15 per cent of the qualified voters, and must be approved by a majority of the voters to become effective. Another amendment requires the consents of property owners for an extension of tracks.—The Stockwell bill, which authorized municipalities to build street railways to be leased to operating companies, has been defeated by the house.—The house and senate have both passed a bill introduced by Mr. Lamb, which permits interurban railroads to appropriate the use of city tracks to reach a terminal. In the event of a dispute as to the amount of compensation the courts may be asked to settle the question.

**New York.**—The senate cities committee has reported the Travis-Robinson subway franchise bill with an amendment increasing from 25 to 50 years the period in which a company may operate a subway under an indeterminate franchise before the city may have the right to purchase the property. Another amendment increases the term for which a subway built by the city may be leased by an operating company from 25 to 35 years.

#### Accident on the South Side Elevated Railroad.

A peculiar accident occurred on Tuesday morning of this week on the South Side Elevated Railroad, Chicago, when the first car of a 3-car train was derailed and fell from the elevated structure to the ground. The car contained about 17 men, including the crew, all of whom were more or less injured, but no one appears to have been permanently injured and there were no fatalities. The accident was caused by the motor, which dropped under the front truck of the first car and lifted it from the track.

The train was a Jackson Park local, southbound, consisting of three cars. The accident occurred about 7:30 in the morning and most of the passengers were laborers on their way to work in the southern part of the city, 15 of them riding in the first car, the smoker. About 300 feet south of the Forty-third street station the motor on the front axle of the smoker fell to the track in such a position as to lift the car from the rails with the wheels clear of the guard timbers. The motorman felt his car being raised and immediately applied the air brakes and shut off the current. The train was moving rapidly, however, and the car toppled over to the ground, landing almost perpendicularly. The rear end remained on the structure, which is about 20 feet high. The connections with the second car were broken, but as the first car swung around it pushed the end of the second car over and derailed the front wheels of the leading truck. The end of the second car was only slightly damaged. The front truck of the first car remained attached to the car and fell

with it to the ground; the rear truck became detached and struck the ground at some distance away. The passengers were hurled into the forward end of the car as it struck the ground and those who were not injured by the fall were cut and bruised by glass and wreckage. The motorman fell half way through the window but escaped serious injury.

Charles V. Weston, president of the company, said that there was no defect in the rails or the guard timbers and that the accident was entirely due to the falling of a motor. It is probable that a bolt in an axle bearing cap broke and allowed the motor to fall. The car had been thoroughly overhauled within a month and had been inspected three times since, the last time only two days before the accident.

It seems especially unfortunate that so serious an accident should have occurred on the day set for the opening of the stock yards extension, which marks the completion of an extensive series of improvements extending over five years. During this period the Englewood, Kenwood and stock yards extensions have been built. The structure has been largely rebuilt and a third track for express service has been added between Twelfth and Forty-third streets. During all this work, which was carried on without interruption of traffic, no serious accidents of any kind have occurred.

**Boston Transit Commission Reports.**—The Boston transit commission has issued in one volume its twelfth and thirteenth annual reports, covering, respectively, the fiscal years ending June 30, 1906, and June 30, 1907.

**Time for Replies to Accounting Circular Extended.**—Prof. Henry C. Adams, in charge of statistics and accounts of the interstate commerce commission, has extended until May 5 the time for replies to Accounting Series Circular No. 20. The original date fixed was March 28.

**Michigan Electric Association.**—The annual meeting of the Michigan Electric Association will be held in Grand Rapids, Mich., on August 18, 19, 20 and 21. Announcement as to headquarters, programme, etc., will be made at an early date. H. W. Hillman of Grand Rapids is president of the association and A. C. Marshall of Port Huron is secretary.

**American Street and Interurban Railway Association Circular.**—The American Street and Interurban Railway Association has issued a circular giving statistical information regarding the rates of wages paid to miscellaneous classes of employes by street and interurban roads. Information of this character will be sent annually hereafter to member companies. The circular supplements the previous circular, which gave statistical information in relation to the wages of trainmen.

**New York State Convention.**—Attention is being called by J. H. Pardee, secretary of the Street Railway Association of the State of New York, 611 West One Hundred and Thirty-seventh street, New York, to the twenty-sixth annual convention, which will be held at the Clifton hotel, Niagara Falls, Ont., on June 30 and July 1, 1908. The detailed programme has not yet been announced. The Clifton hotel has been reserved for convention guests and reservations can be made at any time by applying to T. W. Wilson, manager International Traction Company, Buffalo, president of the association.

**Fire at the Sullivan Square Terminal of the Boston Elevated.**—A fire which damaged the offices of the Boston Elevated Railway Company's elevated division to the extent of about \$5,000 occurred at the Sullivan square terminal station at 1:30 a. m., April 3. The general office of the superintendent of the elevated division suffered most from the flames. After the fire it was necessary to move the telephone switchboard and train dispatcher's office into the trainmen's school room. Rapid work was done in the temporary wiring of the telephone and telegraph services. When the train service began about 5:30 a. m. no delay was experienced in the handling of traffic.

**Wage Controversy in Pittsburg.**—The controversy between the Pittsburg Railways Company and its conductors and motormen in regard to the question of wages has been submitted to an arbitration committee. A proposal of the company to reduce the wage scale three cents an hour on April 1 met with a threat to strike, but after several conferences it was agreed to continue the old scale until April 8. On Saturday, April 4, it was decided to appoint an arbitration committee, consisting of one member selected by the men, another selected by the company and a third chosen by the first two. George W. Guthrie, mayor of Pittsburg, has been selected to represent the men. The decision of the committee, which is to be binding for one year, is to be reported before April 20 if possible. The present scale is 25, 26 and 27 cents per hour, according to length of service. It is stated that the company's earnings have been greatly reduced during the past few months.

# Traffic and Transportation

## Costly Transfer System in Brooklyn.

In an interview published in the New York Times on April 6 J. F. Calderwood, vice-president and general manager of the Brooklyn Rapid Transit Company, discussed the abuse of the transfer system on the surface lines of that company, saying in part:

"The number of transfers issued by the various companies, especially the traction companies of the larger cities, and more especially in Greater New York, where the issuance of transfers is governed by laws which were enacted when those controlling the companies did not realize the effect of transfers as they have since developed in reducing the gross revenue per passenger to a dangerous limitation, has increased to an alarming degree.

"The constant increase per passenger in the cost of operation, due not only to the cost of operating, labor and material, but to great outlays required for modifications in construction, due to changing conditions of operation and the replacement of apparatus, the expense of which cannot be capitalized, but must be paid out of earnings, is bringing each day our gross earnings per passenger nearer to the cost per passenger, reducing the margin applicable to fixed charges, interest and taxes, without any consideration of dividends for stockholders. The question of capital stock or dividends is not a factor in any of these computations.

"With a constant decrease in the gross revenue per passenger and an increase in the cost of operation, with the increasing burden of taxation, and let me say right here that it takes the gross earnings each day of 150,000 passengers to pay the taxes of this company alone, it is a grave question with the corporations where they are going to secure the necessary capital to develop and increase the traction facilities.

"Answering your inquiry as to how our figures on transfers, passengers carried, and gross revenue per passenger compare with the memorandum submitted by General Manager Root under the receivers of the New York City Railway to Judge Lacombe, I submit the following interesting comparisons:

### New York City (Surface System).

	1906.	1907.
Revenue passengers .....	391,354,877	376,629,571
Transfer passengers .....	178,639,866	194,765,342
Per cent transfer passengers to revenue passengers .....	45.6	51.7
Gross average fare in cents.....	3.43	3.29

### Brooklyn Rapid Transit (Surface System).

	1906.	1907.
Revenue passengers .....	230,228,994	228,524,961
Transfer passengers .....	91,621,479	127,032,395
Per cent transfer passengers to revenue passengers .....	39.8	55.6
Gross average fare in cents.....	3.56	3.17

"I have not the cost per passenger including taxes and interest, separated for our surface system, but for our entire system (including elevated) it averages for the fiscal year 1906 3.13 cents, and for 1907 3.30 cents per passenger carried. As it costs less to carry passengers on our elevated system, it follows that if we separated the cost of our elevated from the surface the cost per passenger for our surface alone would be an increase on the above figures.

"Taking these figures of gross earnings and cost per passenger it shows that we lost money on every passenger carried on our surface cars for the fiscal years 1906 and 1907, and that the little surplus shown by our annual report was due to our elevated operation, where the transfers are limited."

## Indiana Union Traction Magazine.

The Indiana Union Traction Company of Anderson, Ind., has started the publication of a monthly magazine. In the April number, just issued, E. C. Van Valkenburgh, the editor and manager, states that the purpose is to tell about the attractive features of the service on the lines of the company and its connections and of the many beautiful places and points of interest that are easily accessible in Indiana and the adjoining states. The magazine is "for those who use, or who should use, the interurban lines for business or pleasure purposes." The issue contains articles descriptive of the semaphore control system of the Telegraph Signal Company of Rochester, N. Y., which is used on the Indiana Union Traction lines; of the new shops of the company at Anderson, and of Ft. Benjamin Harrison. There are also a short story, a synopsis of "events of the month" at the principal places

reached by the road, including the theatrical attractions, and numerous short articles of interest. A map shows the territory covered by the company and its principal connections, and there are given with the timetables the points of connection with other electric railways and with steam roads.

**Express Company Arrangement.**—The United States Express Company will handle express over the line of the Cleveland Southwestern & Columbus Railway of Cleveland, O., between Bucyrus and Mansfield.

**Time Limit on Transfers Reduced.**—Instead of allowing, as heretofore, the use of transfers for 30 minutes after the time punched the Utah Light & Railway Company of Salt Lake City has reduced the time limit to 15 minutes.

**Fruit Growers' Special Run by Inland Empire System.**—What is said to be the first fruit growers' special demonstration train ever run by a steam or electric railroad was operated over the suburban lines of the Inland Empire System, Spokane, Wash., on March 26, 27 and 28. The object in sending out the train was to interest residents on the lines in fruit growing, in fighting the Codlin moth and San Jose scale and to instruct them in pruning and cultivating their orchards in order to achieve the highest efficiency in bearing. The train consisted of a private buffet car and a parlor car. On the observation platform of the latter car pumping and spraying apparatus was installed for the practical demonstrations at each stop. Lectures were given on the following subjects: "How to Make the Orchard Bear," "How to Save the Orchard," "How to Make the Orchard Pay," "How to Ship the Best," "How to Can the Rest," "Fighting Plant Diseases." The schedule included 22 stops of 20 minutes to one hour and a half, according to the size of the town.

## FAILURES OF REINFORCED CONCRETE.

H. F. Porter discusses "Failures of Reinforced Concrete" in the Cornell Civil Engineer for December, 1907, with especial reference to the failure of a building of the Eastman Kodak Company at Rochester, N. Y., in 1906. He draws the following conclusions:

(1) The designs for reinforced concrete construction should be carefully prepared by competent, experienced engineers and preferably by engineers whose sole interest is to design a stable structure at as reasonable expenditure as good judgment dictates—in other words, to avoid the pitfalls that have evidenced themselves in the designs of structures that have failed, the engineering and commercial elements should be separated.

(2) Patent trussed bars, while they may be very efficient reinforcing for beams and floor slabs, as certainly attested by the multitude of excellent installations throughout the land, are only so when used by men with a full knowledge of conditions and their installation made by experts, "exercising care in handling the details and giving proper attention to the requirements of the design."

(3) The so-called hollow tile floor system is safe only under the most careful supervision of experienced men, as brought out in a preceding paragraph.

(4) The utmost care must be given to the inspection of materials, and in mixing the preponderance of the fallible human element should be diminished by the universal adoption of machine mixers that automatically and unfailingly mingle just the proper amount of ingredients.

(5) As to the centers—a daily record should be kept of every section of concrete poured, and, as is done abroad, test pieces should be molded to one side to correspond with each section. Accurate knowledge could then be had at any time as to the exact condition of the concrete and the centers removed at exactly the proper time.

(6) Finally, governmental action should be taken to secure the universal adoption of the foregoing recommendations or such other and additional ones as may be found necessary. Uniformity of stress limits and principles of design and suitable attention to the requirements of the disrupting forces existent over the supports should also be included. The building codes are all offenders of the last requirement, many ignoring completely the negative bending moment that must occur with a monolithic construction. Both the Hotel Bixby and the Kodak building failures showed plainly the result of not providing for these strains.

If these suggestions are heeded with ordinary sincerity, there is no reason why the particular system indited, or any other on a scientific basis, should not give entire satisfaction. Beyond cavil reinforced concrete construction if properly executed is the safest, strongest, most resisting and enduring, and at the same time all factors considered the most economical structural material at the command of modern builders.

# Construction News

## FRANCHISES.

**Corpus Christi, Tex.**—A franchise for an electric railway in Corpus Christi has been applied for by George H. Paul and F. B. Bannister, representing a company which proposes to build and have in operation five miles of street railway in the city within two years.

**Dallas Tex.**—An order has been filed with the clerk of the county commissioner's court which provides for the granting of a franchise to A. F. Slater of West Dallas, W. L. Spence, Frank Ford and others to build and operate an electric railway between Dallas and West Dallas, beginning at the foot of the Commerce street bridge and the limits of Dallas and continuing over the West Dallas Pike to West Dallas. It is stated that citizens of West Dallas will be asked to subscribe \$50,000 of stock.

**Harrisburg, Pa.**—The Central Pennsylvania Traction Company, Harrisburg, Pa., has secured a franchise to build extensions in East and West Harrisburg.

**Logansport, Ind.**—John H. Keller, representing the Indianapolis & South Bend Traction Company, has applied for a franchise. It is stated that construction work will be started south of the city as soon as the franchise is granted.

**Monongahela, Pa.**—A franchise has been granted to the Monongahela & Carroll Street Railway for the operation of its line in Park avenue and to the city limits of Monongahela. Work is to be started in six months. The road will be extended later to Washington, Pa. George Hosack, president, Pittsburg, Pa.

**Nashville, Tenn.**—The Nashville Railway & Light Company, which expects to build a 5-mile extension to the national cemetery, will apply to the county court at its April meeting for right of way on the Gallatin turnpike.

**Newburg, Ind.**—The Evansville Terminal Railway Company, Evansville, Ind., has applied for a franchise to enter Newburg with its new interurban line. M. S. Sonntag, Evansville, Ind., is interested. (Noted April 4.)

**New Iberia, La.**—The Bayou Teche Railway & Light Company, which was organized to build an electric railway in New Iberia and from New Iberia to Jeannette, La., will apply to the city council for an extension of time in which to start work on the line.

**Richmond, Cal.**—A franchise for the operation of a street railway in Richmond has been granted to John H. Nicoll.

**Salt Lake City, Utah.**—The Utah Light & Railway Company has been granted a franchise to double-track its Ashton avenue, the penitentiary and Wandamere lines after the city limits are passed. It is stated that work will be started at once on the Wandamere line in order to care for the summer travel to this resort.

**Weston, Ore.**—The Idaho Oregon & Washington Traction Company is said to be securing right of way up Pine Creek to Weston, Ore. Application for a franchise to operate its proposed line in that city will be made to the city council on April 15.

## RECENT INCORPORATIONS.

**Elgin Woodstock & Lake Geneva Railroad.**—Incorporated in Illinois to build a railroad from Elgin to a point at the center of the north line of Richmond township, McHenry county, Illinois, with principal offices at Elgin. Capital stock, \$25,000. Incorporators: G. W. Young, Algoma, Wis.; Frank R. Spear, George H. Bryant, William C. Hascall, Chicago; John A. Kirkland, Elgin, Ill.

**Hudson & Long Island Traction Company.**—Incorporated in New York to operate a street railway from Twelfth avenue and West Forty-second street, New York City, across the Blackwell's island bridge, to Long Island City and Jamaica on Long Island.—Incorporators: Frederick H. Morris, 2027 Seventh avenue, New York City; William B. Spencer, Montclair, N. J.; Anthony Stumpf, 22 Pine street; Arthur C. Hume, 34 East Thirty-third street; Harold B. Weaver, 18 Gramercy park; Cassius M. Wicker, 35 Nassau street; Henry A. Belden, 3810 Broadway; William V. Lomax, 540 West One Hundred and Forty-third street; John J. Clancy, 353 West Fifty-seventh street, New York City.

**Interlake Railroad, Chicago, Ill.**—Incorporated in Illinois to build an electric railway from a point on Lake Michigan to Fox lake in Lake county, Illinois. Capital stock, \$5,000. In-

corporators: A. F. Struckman of the Colonial Trust & Savings Bank, Chicago, Otto Hopper, S. N. Conway, Martin D. Smith and S. S. Welcher.

**Oklahoma City & Shawnee Interurban Railway.**—Incorporated in Oklahoma to construct an electric line between Oklahoma City and Shawnee, Okla. Capital stock, \$3,000,000. Incorporators: A. M. Spencer, Stephen Brown, Joseph Brown and J. A. Stevenson, all of Oklahoma City.

**Potomac Valley Railway.**—Incorporated in Maryland to build a railroad from Keyser to Bloomington, Md., passing through Mineral and Garrett counties. Principal office, Piedmont, Md. Capital stock, \$150,000. Incorporators: Louis P. Traube, Joseph J. Benton, Charles A. Geiger, C. M. Burkett and Anton Korn, all of Wheeling, W. Va.

**Washington Patuxent & Drum Point Railroad.**—A bill has been introduced in the Maryland legislature incorporating this company to build a railway, either steam or electric, from a point on the Chesapeake Beach Railway to Solomon's island at the mouth of the Patuxent river, passing through Calvert, Prince George and Arundel counties. Capital stock, \$250,000. Incorporators: Ira J. Baker and Charles C. Mayer of Washington; C. A. M. Wells, Joseph R. Owens, Rexford M. Smith, Wallace A. Bartlett and Charles A. Wells.

## TRACK AND ROADWAY.

**Boston Elevated Railway.**—The committee on street railways of the Massachusetts legislature has voted to report favorably the bill to allow the Boston Elevated Railway to extend its structure from Sullivan square, Charlestown, to Medford square, Medford.

**Calgary, Alberta.**—Plans are being considered for the construction of an electric railway between Calgary and Shepard, Alberta, with a pleasure park on the borders of Shepard lake. A charter will be applied for shortly, and it is stated that construction work may be begun during the summer.

**Chicago City Railway.**—Work has been started on the reconstruction with 129-pound rails of the tracks on Twenty-second street, between Cottage Grove and Wabash avenues, and on Wallace street, between Twenty-ninth and Root streets. Plans are also being prepared for an extension on Western avenue, from Thirty-eighth street to the Chicago river.

**Chicago Lake Shore & South Bend Railway, South Bend, Ind.**—The line between Michigan City and South Bend, Ind., is now completed except for two miles west of Hudson Lake, and it is planned to begin operating over this section early in May. The remainder of the line to Kensington, Ill., is expected to be completed by July 1. J. B. Hanna, president. (Noted February 1.)

**Chicago Railways Company.**—The Chicago board of supervising engineers has issued a schedule of the construction work to be undertaken during the spring and summer under the company's franchise extension ordinance, showing that 59.55 miles of new track are to be built with 129-pound grooved rails. Of this amount 7.11 miles will be extensions of existing lines and the remainder will be reconstruction.

**Cleveland & Indianapolis Interurban Railway, Norwalk, O.**—C. F. Jackson states that arrangements have been made to secure 80 per cent of the money to build the road from Norwalk, O., to Bluffton, Ind., provided the remaining 20 per cent can be subscribed in the towns along the line.

**Conestoga Traction Company, Lancaster, Pa.**—It is reported that the Columbia-Donegal division is to be extended from Marietta to Maytown, Pa. H. W. Crawford, chief engineer.

**Dallas, Tex.**—A. F. Slater and Frank Ford of West Dallas, Tex., are interested in the construction of a street railway in West Dallas and vicinity. The road will connect West Dallas with the new town of Cement and will parallel the West Dallas pike, crossing the river at the foot of Commerce street. The citizens are asked to subscribe \$50,000, a large portion of which is said to have been pledged.

**Davenport & Manchester Railway, Davenport, Ia.**—At a recent meeting of the directors W. H. Kimball submitted plans and estimates for the proposed line from Davenport to Manchester, Ia., 93 miles. It is expected that arrangements for financing the project will be made shortly.

**Denver & Interurban Railway, Denver, Colo.**—Construction has been started on the city line in Boulder, Colo., which will be operated in connection with the line from Denver to Boulder. H. W. Cowan, chief engineer. (Noted March 21.)

**Diamond State Rapid Transit Company, Smyrna, Del.**—It is stated that this company will start construction work on its

proposed 98-mile electric railway within 60 days. The overhead trolley system will be used. The following cities and towns will be served: Wilmington, Newcastle, Delaware City, St. Georges, Odessa, Smyrna, Dover, Camden, Magnolia, Fredrica, Milford, Milton, Lewes and Rehoboth. The power station will be located at St. Georges. The National Construction Company, recently incorporated, will build the road. Capital stock, \$3,000,000, of which \$50,000 has been issued. M. V. Ford, president; S. Derrickson, vice-president; H. Hartman, secretary and treasurer; J. W. Endean, general manager and chief engineer; all of Smyrna, Del.

**Ft. Worth Springtown & Mineral Wells Electric Railway, Mineral Wells, Tex.**—C. N. Wilson, president of the American Engineering Company, Indianapolis, is quoted as saying that financial arrangements have been made for the construction of the proposed line between Ft. Worth and Mineral Wells, Tex., and that contracts will be let in a few days for the grading. About six miles of grading has already been completed.

**Gardiner, Me.**—Amos F. Gerald of Fairfield, Me., is interested in a project to build an electric railway from Topsham to Gardiner, Me., 27 miles.

**Grand Valley Railway, Brantford, Ont.**—It is reported that construction is to begin this spring on the lines from Brantford to Port Dover, Ont., 35 miles, and from Brantford to Woodstock, Ont., 25 miles. W. P. Kellett, chief engineer.

**Hazlehurst, Miss.**—It is reported that J. W. Abernathy contemplates building an electric railway about 40 miles long, connecting Hazlehurst, Brown's Wells, Barlow and Dentville, Miss.

**Interstate Railway.**—Smith H. Bracey, 1606 Tribune building, Chicago, president, states that it is proposed to build a double-track electric railroad by the most direct route from St. Joseph to Kansas City, Mo., via Halleck, Dearborn, Platte City and Hampton, 48½ miles. Surveys have been made and a large part of the right of way has been secured. Negotiations are now under way for financing the project and it is hoped to be able to begin preliminary work in the near future. A. T. Russell, Chicago, is chief engineer, and G. R. Collins, Kansas City, is secretary.

**Johnstown, Pa.**—It is reported that the Cambria Land & Improvement Company is receiving bids for the construction of an electric line from Johnstown to Southmont, a new suburb.

**Joplin & Pittsburg Railway, Joplin, Mo.**—Construction has been resumed on the line between Joplin, Mo., and Pittsburg, Kan., 30 miles. All of the material has been delivered and four steel bridges are being erected. P. P. Crafts, general manager. (Noted October 12, 1907.)

**Joliet & Southern Traction Company, Joliet, Ill.**—This company has made financial arrangements for completing from 15 to 20 miles of the extension from New Lenox to Blue Island, Ill., this year, and will do its own construction work. H. A. Fisher, president. (Noted February 29.)

**Kansas Traction Company.**—This company, which was incorporated a year ago to build an interurban system of electric lines in Kansas, comprising about 160 miles, has started surveys. The road will connect Kansas City, Kan., with Independence, Coffeyville and Lawrence, with branches to Topeka and other points. F. B. Shirley of Coffeyville is president. Paul Julian is the engineer in charge of surveys. (Noted September 21, 1907.)

**Kokomo Frankfort & Terre Haute Traction Company, Frankfort, Ind.**—D. W. Bolen, second vice-president, advises that work on this proposed line will be started during the summer. The road will extend from Kokomo to Terre Haute, 104 miles, and will serve the towns of Frankfort, Crawfordsville, Rockville, Rosedale and others. It will parallel the Chicago Cincinnati & Louisville Railroad from Kokomo to Frankfort and from Frankfort to Terre Haute will parallel the Vandalia Railroad. Contracts will be let this spring. Dr. Oliver Gard, president, Frankfort, Ind.; J. C. Dewese, first vice-president, Kokomo; D. W. Bolen, second vice-president, Indianapolis; E. B. Swift, secretary; and M. W. Eikenberry, treasurer, Kokomo; Judge J. V. Kent, general counsel, Frankfort. (Noted February 15.)

**Los Angeles & San Francisco Short Line Electric Railroad, Los Angeles, Cal.**—This company, recently incorporated, proposes to build an electric railway from Los Angeles to San Francisco, via Bakersfield, Cal. The officers are: President and general manager, John Cross; vice-president, W. F. Haas; treasurer, Charles Wier; secretary, Charles S. Burnell; chief engineer, M. K. Miller.

**Louisville & Eastern Railroad, Louisville, Ky.**—This company is reported to have let a contract for ballasting its extension from Beechwood to Shelbyville, Ky., to M. J. McClusky. About one-half mile of grading remains to be completed. Percival Moore is vice-president and general manager.

**Louisiana Light Power & Traction Company, Louisiana, Mo.**—This company proposes to build an electric railway from Louisiana to Bowling Green, Mo., 11 miles. The power station and repair shops are to be located at Louisiana. It is proposed to begin construction this summer. D. Turnbull, president and general manager, and F. E. Murray, secretary.

**Mexico Santa Fe & Perry Traction Company, Mexico, Mo.**—This company, which was organized some time ago to build an electric railway from Perry to Mexico, Mo., 27 miles, has filed a mortgage in the Audrain county court for \$850,000 to secure gold bonds which will be issued and sold to raise the necessary funds for completing the work. S. L. Robinson, Mexico, Mo., president. (Noted March 14.)

**Milner & Northside Electric Railway, Milner, Idaho.**—It is reported that this company has let a contract to Grant & Son of Faribault, Minn., for the construction of its proposed line from Milner to Gooding, Idaho. D. C. McWatters, president.

**Mt. Hood Railway & Power Company, Portland, Ore.**—It is reported that construction will be resumed at once on the line from Portland to Bull Run, Ore., 25 miles. The Mason Construction Company has the contract. Eleven miles of grading were completed last fall. Equipment is now being received for the power plant at Bull Run. F. C. Finkle is chief engineer. (Noted December 14, 1907.)

**Mt. McKay & Kakabeka Falls Railway, Ft. William, Ont.**—This company, which was recently granted an extension of time in which to complete its proposed line from Ft. William to Kakabeka Falls, Ont., via Neebing, Paiponge and Oliver, has completed about 2½ miles of track. The officers are: President, W. F. Hogarth; vice-president, J. Dyke; treasurer, C. H. Jackson; secretary, C. W. Jarvis; all of Ft. William, Ont. (Noted January 11.)

**Muskogee, Okla.**—A company has been organized to build an electric railway from Muskogee to Clarksville, Coweta, Broken Arrow and Tulsa, 54 miles.

**Nashville (Tenn.) Railway & Light Company.**—It is reported that this company is planning to build an extension about five miles long on the Gallatin turnpike to the national cemetery. Surveys have been started for an extension of the St. Cecilia line to the White City.

**Okanogan Electric Railway, Spokane, Wash.**—A. M. Dewey, president, states that construction work will be started by June 1 on the proposed line from Nighthawk to Brewster, Wash., via Omak and Okanogan, with the intention of completing 20 miles of the line this year. Water power rights on Sinalahakin and Salmon creeks have been filed, which are capable of development to furnish 5,600 horsepower. M. D. Winder is chief engineer. (Noted November 9, 1907.)

**Oregon Electric Railway, Portland, Ore.**—Surveyors are at work on three separate routes for the extension of this line from Salem to Albany, Ore., 27 miles, and it is announced that construction will be started in about six months. The 21-mile extension to Forest Grove probably will be started within 30 days. With the completion of these extensions by the end of the year the company will have 100 miles of main line in operation. W. S. Barstow & Co., New York City and Portland, Ore., have the contracts for building both extensions. G. W. Talbot, vice-president and general manager. (Noted March 21.)

**Oregon Rapid Transit & Power Company, Jacksonville, Ore.**—Officers for this company, which was incorporated a few weeks ago, have been elected as follows. F. C. Page, president; F. E. Merrick, treasurer; S. E. Nye, secretary; Capt. F. L. Adams, general manager. The company will build a system of interurban lines serving the entire Rogue river valley from Grant's Pass to Ashland and Jacksonville, Ore. It is stated that power will be obtained from the Condor Water & Power Company, although the company later may secure water rights for the development of 30,000 horsepower. (Noted March 21.)

**Ottawa, Ont.**—Plans have been prepared for an electric railway from Ottawa in a southerly direction through Carleton, Russell and Dundas counties to Morrisburg, Ont., thence along the river front to Brockville, Iroquois, Cardinal and Prescott. From Prescott it will proceed northerly through Leeds, Lyn and Athens, thence through Perth, Lanark and Renfrew and back to Ottawa, making altogether a complete belt line of about 200 miles. This company is said to be

entirely separate from the two other proposed lines of electric railways between Brockville and Prescott and the Morrisburg Electric Railway.

**Pottsville (Pa.) Union Traction Company.**—It is reported that this company has decided to build a new bridge over the Philadelphia & Reading tracks in Pottsville to replace the present one, which has been found unsafe.

**Prosser (Wash.) Traction Company.**—Frederick Finn, president, writes that it is proposed to build an electric railway south from Prosser, with branches to Bickleton and Patterson, Wash., 40 miles. Surveys are now being made from Prosser to Bickleton, 26 miles, and grading is to be started some time this summer. A contract is to be let soon for a dam and a power house. Frank O. Kelsey of Portland, Ore., is chief engineer. (Noted January 25.)

**Redlands Central Railway, Redlands, Cal.**—John H. Fisher, vice-president and general manager, writes that this company's line will extend from Redlands to Riverside, Cal., 12 miles. Surveys have been completed for three miles and grading is to be started in 60 days. The Ohio Brass Company's overhead construction will be used. A. G. Hubbard, president. (Noted February 8.)

**Roanoke (Va.) Railway & Electric Company.**—It is reported that this company will build an extension to West Salem.

**Rochester Corning & Elmira Traction Company, Rochester, N. Y.**—The New York public service commission of the second district has authorized this company to issue its outstanding capital stock to the amount of \$3,880,000 and to issue \$4,210,000 of 35-year 5 per cent bonds for the purpose of building its proposed line from Rochester to Elmira, a distance of 138 miles. The total capital stock is \$4,000,000. It is announced that construction is to be resumed about May 1. The Rochester & Southern Construction Company, Rochester, N. Y., has the general contract for building the line and several miles of grading between Scottsburg and Conesus Lake were completed last fall. The entire route has been surveyed and subcontracts for a part of the grading have been let. It is proposed to adopt the single-phase system. W. C. Gray, chief engineer. (Noted November 30, 1907.)

**Salem, Ore.**—The Salem board of trade has appointed a committee to ascertain the cost and investigate the feasibility of constructing an electric railway from Salem to Stayton, Ore., 15 miles.

**South Memphis Traction & Electric Company, Memphis, Tenn.**—This company is being organized to build an electric railway from Memphis to South Memphis.

**Taylor, Tex.**—A number of business men of this city, including J. A. Thompson and Howard Bland, are interested in a plan to build an electric railway from Taylor to Austin, Tex., via Pflugerville, with a belt line in Taylor. At a meeting held on April 1 C. P. Scrivener, representing the Texas Interurban Company, presented estimates and made a proposition to build the line for a cash bonus or for donations of land for right of way, terminals, etc.

**United Railways, Portland, Ore.**—Considerable progress is reported on the construction work now under way by this company. Two surveys have been made on its proposed Hillsboro extension as far as Mt. Calvary, about four miles from the city limits of Portland, and it is stated that work will be started with the expectation of having the Hillsboro line completed to Mt. Calvary during the summer. Right of way has been secured for most of the distance. The company also expects to start work on the double-tracking of Stark street for a distance of 3,000 feet, the track to be laid with 114-pound girder rails on concrete foundations. E. E. Lytle, Portland, Ore., president.

**Vallejo & Northern Railway, Vallejo, Cal.**—T. T. C. Gregory of Suisun, Cal., has been elected president of this company, to succeed Melville Dozier, Jr., resigned. It is proposed to begin construction this spring on the line from Vallejo to Sacramento, Cal., 58 miles. (Noted November 23, 1907.)

**Warren-Bisbee Railway, Bisbee, Ariz.**—This company will soon begin the construction of an extension from Bisbee to the country club, 1½ miles.

**West Chester & Wilmington Electric Railway, West Chester, Pa.**—Surveys have been started on this proposed line from West Chester, Pa., to Wilmington, Del. At a recent meeting of the directors it was decided to increase the capital stock to \$500,000. Thomas E. O'Connell, president. The Eastern Railway Construction Company, of which J. Frank Ball, Wilmington, is president, has been organized to build the line. (Noted April 4.)

**Western New York & Pennsylvania Traction Company, Olean, N. Y.**—M. Silverman, electrical engineer, writes that work on this company's 9-mile extension from Carrollton, N. Y., to Bradford, Pa., is progressing satisfactorily. The entire distance has been graded and the overhead work completed from Clarkdale to Limestone, four miles. Work is being pushed on the remaining 5-mile section from Limestone to Seneca Junction. The bracket type of overhead construction is used, with provision for high-tension transmission lines. Rotary converter substations will be located at East Bradford and at Seneca Junction. The line will serve the following towns: Clarkdale, State Line, Pa., and Limestone, Irwin's Mills, Riverside and Seneca Junction, N. Y. (Noted September 28, 1907.)

**Winona Interurban Railway, Winona Lake, Ind.**—We are advised by R. M. Murray, chief engineer, that grading on this company's proposed 43-mile extension has been completed from Peru to Akron, Ind., 22 miles, and that work is in progress on the 21-mile section from Akron to Warsaw. The overhead and track work has been finished from Peru to Chili, 10 miles, this section now being in operation, and work on the 12-mile section from Chili to Akron is being pushed. The bracket type of overhead construction is used. Power will be obtained from the company's power house at Winona Lake, Ind. Three substations of 300-kilowatt capacity each are under construction. The track is to be laid with 70-pound rails. Maximum curvature outside of towns, 3 degrees; maximum gradient, 2 per cent. All bridge work on the 22-mile section from Peru to Akron has been completed. S. C. Dickey, general manager, Winona Lake. (Noted April 4.)

**York, Pa.**—It is stated that plans are being perfected for the construction of an electric railway from York, Pa., to Turnpike, Pa., and subscriptions are being received. D. B. Goodling, Logansville; J. H. Keller, Shrewsbury; J. Myers, Glen Rock; J. N. Bailey, E. J. Beck, James Blouse, C. J. Smith, W. G. Allen and Benjamin Seitz, all of Pennsylvania, are interested.

#### POWER HOUSES AND SUBSTATIONS.

**Guadalajara Railway Light & Power Company, Guadalajara, Mexico.**—This company, which operates not only the entire lighting system, but also the railway system of Guadalajara, has recently placed a large order for additional electrical machinery with Messrs. G. & O. Braniff & Co. of Mexico City. The order includes a 750 kilowatt three-phase belted type Westinghouse generator. Three other generators will be installed as needed. The latter station was one of the first electric power plants in the country, the original installation consisting of single-phase machines, which were added to from time to time by other machines of the same type as growth necessitated.

**New York New Haven & Hartford Railroad, New Haven, Conn.**—We are officially advised that the reports that this company proposes to erect a large power house at Milford, Conn., are incorrect.

**Norfolk & Portsmouth Traction Company, Norfolk, Va.**—A year ago this company put into service a 10,500-kilowatt generating station. It is reported that it will now erect a substation for its Portsmouth division, to be fed with current from the new power station.

**Pittsburg & Butler Street Railway, Pittsburg, Pa.**—We are advised by Charles Gibson, Jr., vice-president, that this company is now installing a new Westinghouse 1,500-kilowatt single-phase turbo-generator in its power plant. With this installation there is also a complementary installation of Babcock & Wilcox boilers and an Abergger condenser. The increase in generating capacity is made in anticipation of a heavy traffic to and from the company's pleasure park at Butler, Pa.

**Scranton Railway, Scranton, Pa.**—It is reported that this company will erect a new power station for which plans are nearing completion. The Scranton Railway Company is controlled by the American Railways Company. A. S. Kibbe, chief engineer, Witherspoon building, Philadelphia, Pa.

**Washington Water Power Company, Spokane, Wash.**—It has been officially announced that \$1,000,000 of the \$3,000,000 recently realized by the sale of an issue of 5 per cent notes will be used in extending this company's power transmission lines and in increasing the capacity of its reserve steam station at Ross park, Spokane. This station now has a capacity of 4,000 horsepower, which will be increased to 16,000 horsepower. Its water power at Post Falls, Idaho, with a capacity of 12,000 horsepower, will be increased to 15,000 horsepower. The company operates two high-tension transmission lines from Spokane to the Coeur d'Alene mining district and another line south to Colfax, Palouse and Oakesdale.

## Personal Mention

Mr. J. F. Scott, general superintendent of construction of the Chicago & Milwaukee Electric Railroad at Highwood, Ill., has resigned.

Mr. J. W. McDonald, Lincoln, Neb., has been elected to succeed Mr. M. L. Scudder as president of the Lincoln (Neb.) Traction Company.

Mr. J. M. Yount has resigned as master mechanic of the Lehigh Valley Transit Company, Allentown, Pa., to accept a similar position with the Union Railway Company of New York City.

Mr. J. B. Lukes, heretofore general superintendent of the Seattle (Wash.) Electric Company, has been appointed district superintendent of power for the Stone & Webster properties in that territory.

Mr. Charles Hallam Keep, who was appointed by Governor Hughes last June as a member of the public service commission of New York, second district, has resigned to become president of the Knickerbocker Trust Company of New York City.

Mr. H. C. Osborne of Toronto, Can., has been elected vice-president of the Chicago & Milwaukee Electric Railroad, Chicago, Ill., succeeding Mr. Gordon Ramsay, resigned. Mr. W. O. Kilman, heretofore treasurer of the company at Highwood, Ill., has resigned.

Mr. Walter H. Horton, superintendent of the Rutland (Vt.) Railway Light & Power Company, has resigned to become assistant superintendent of the Atlantic Gulf & Pacific Construction Company of New York City. Mr. Horton has been connected with the Rutland property since 1902.

Mr. Melville Dozier, Jr., of Oakland, Cal., has been appointed assistant general manager of the Northern Electric Railway at Chico, Cal. Mr. Dozier formerly was president of the Vallejo & Northern Railway Company, which is building an electric line from Sacramento to Vallejo, Cal.

Mr. J. M. Enright, assistant superintendent of the Toledo (O.) Railways & Light Company, has been appointed acting manager of railroads, to succeed Mr. J. F. Collins, who has resigned as manager of railroads to become general manager of the Saginaw-Bay City Railway & Light Company at Saginaw, Mich.

Mr. William Criley, who has been acting superintendent of the Hartford-Rockville division of the Connecticut Company, with headquarters at Rockville, Conn., has been transferred to Hartford, the management of the Rockville line hereafter being under the direction of Division Superintendent Nettleton of Hartford.

Mr. T. M. Childs of Schenectady, N. Y., has been appointed master mechanic of the Washington Baltimore & Annapolis Electric Railway, Baltimore, Md., succeeding Mr. Henry Donovan, resigned. Mr. Childs has been connected with the motor department of the General Electric Company and during the construction of this line had charge of the installation of the single-phase motor equipment of the cars.

Mr. E. P. Wetmore has resigned as general manager of the Augusta (Ga.) Railway & Electric Company. Mr. Wetmore was appointed to this position about a year ago when the offices of general superintendent and general manager were combined. He is a native of Michigan and has been associated with many of the large street railway systems of the United States and Europe, including the electric railway properties of Liverpool, England.

Mr. J. F. Collins, manager of railroads of the Toledo Railways & Light Company at Toledo, O., has resigned to become general manager of the Saginaw-Bay City Railway & Light Company, with headquarters at Bay City, Mich., succeeding Mr. S. E. Wolff, resigned. Mr. Collins has been connected with the Toledo traction lines since 1890, rising through successive promotions to the position of superintendent of railroads and later manager of railroads, having held the latter position since July of last year.

Mr. Howard F. Grant, for the past five years manager of the Seattle Electric Company at Seattle, Wash., has been appointed district manager of the Stone & Webster properties in the northwest; effective on March 31. He will be succeeded by Mr. E. E. Potter, heretofore assistant manager of the Seattle Electric Company. Mr. Potter formerly was general superintendent of the Union Street Railway at New Bedford, Mass., resigning that position last fall to go to Seattle as assistant manager under Mr. Grant.

Mr. L. H. Palmer has been appointed assistant to the general manager of the New York City Railway; effective on April 5, 1908. With the resignation of Mr. W. L. Derr, effective at once, the position of general superintendent will be abolished and the superintendent of transportation, superintendent of equipment, master mechanic in charge of shops and the head of the appointment department will report to the assistant general manager. The engineer of maintenance of way will report to the general manager.

Mr. William L. Derr, general superintendent of the New York City Railway, has resigned; effective on April 1. Mr. Derr entered railway service in 1876 and since that time has been connected with the engineering and operating departments of various steam railways throughout the country, including the New York & New England, New York Lake Erie & Western, Erie, New York New Haven & Hartford and the Chicago & Alton railroads. He resigned as superintendent of the latter road in July, 1907, to become general superintendent of the New York City Railway, where he has remained until the present time.

Mr. T. Garrett, superintendent of the Washington Arlington & Falls Church Railway, Ballston, Va., will, in addition to his present duties, take over those of manager and purchasing agent, which were formerly discharged by Mr. Fred B. Hubbell, vice-president of the company, until the appointment of Mr. Charles Hine as receiver last October. Mr. Jacob Gerke, chief electrician and master mechanic, and Mr. C. A. S. Sinclair, civil engineer, have had their titles changed to assistant superintendent, with offices at Ballston, Va., where the general offices of the company are now located, the Washington office of the company having been discontinued.

Mr. W. G. Meloon, whose retirement as general manager of the Atlantic Shore Line Railway at Portsmouth, N. H., was announced in the Electric Railway Review for February 29, was presented on March 31 with a handsome gold watch, a gift from the employes of the railway of which Mr. Meloon had been general manager for 11 years. Mr. and Mrs. Meloon also were presented with a purse containing a considerable sum in gold, this being a gift from personal friends in Portsmouth and vicinity. As earlier announced, Mr. Meloon expects to leave shortly to take a position with one of the southern or western properties of A. H. Bickmore & Co., the owners of the road which he is leaving.

Mr. S. E. Wolff, vice-president and general manager of the Saginaw-Bay City Railway & Light Company at Saginaw, Mich., which controls the various street railway and lighting companies in Saginaw and Bay City, has resigned to accept a more responsible position with Hodenpyl, Walbridge & Co. of New York City, owners of these properties. Mr. Walbridge formerly was manager of the Jackson (Mich.) Gas Company, resigning in December, 1905, to become assistant general manager of the Saginaw-Bay City companies. Early in 1906 he was elected vice-president and general manager of the combined companies, where he since has remained. He will be succeeded by Mr. J. F. Collins of Toledo, O.

Mr. Arthur B. Smith, heretofore traffic manager of the Connecticut Company, New Haven, Conn., which controls the electric railroads operated by the New York New Haven & Hartford Railroad, has been appointed general passenger agent of the New Haven company, with headquarters at Boston, Mass.; effective on April 1. He will have jurisdiction over the passenger service of all the lines of the company. Mr. Smith had 12 years' experience in the traffic department of the Chicago Burlington & Quincy Railroad at Omaha, Neb., and was for nine years employed in its engineering and maintenance of way department. In 1904 he was appointed assistant general passenger agent of the Northern Pacific Railroad at St. Paul, resigning in January, 1907, to become traffic manager of the Consolidated Railway Company, now the Connecticut Company, where he has remained until his present appointment.

### OBITUARY.

Albert K. Hiscock, treasurer of the Auburn & Syracuse Electric Railroad, Rochester Syracuse & Eastern Railroad, Syracuse Lake Shore & Northern Railroad and the Syracuse & South Bay Electric Railroad, died at his home in Syracuse, N. Y., on April 7, 1908, after a short illness, aged 47 years. Mr. Hiscock graduated from Cornell University in 1882 and was admitted to the bar in 1884, but soon after became interested in commercial enterprises, in which he was actively engaged until a few weeks before his death. In addition to his position as treasurer of the Syracuse electric railway companies he was vice-president of the Trust & Deposit Company of Onondaga and managing director in the Auburn & Northern Electric Railroad, Oswego Traction Company, Monroe County Belt Line and the Skaneateles Lake Transportation Company. He also was a director in several construction companies engaged in building electric railroads.

# Financial News

**Anderson (S. C.) Traction Company.**—The International Trust Company of Baltimore, trustee under the deed to secure the first mortgage bonds, has petitioned the United States court at Charleston, S. C., for the appointment of a co-receiver.

**Chicago & Milwaukee Electric Railroad.**—The \$1,000,000 of receivers' certificates, the issue of which has been authorized, will bear interest at 6 per cent per annum and will mature in three years. Judge Grosscup of the United States circuit court, Chicago, has authorized the directors of the Chicago & Milwaukee Electric Railroad of Illinois to pay the semi-annual interest on the bonds of the subsidiary Wisconsin company.

**Chicago Railways Company.**—The following statement for the year ended January 31, 1908, has been issued:

Income—		
Passenger .....	\$10,367,551.57	
Chartered cars .....	4,228.50	
Mail cars .....	31,536.36	
Advertising .....	34,999.99	
Rent of land and buildings .....	3,305.00	
Rent of equipment .....	28,038.00	
Sale of power .....	28,419.80	
Interest on deposits (net) .....	27,586.58	
Miscellaneous .....	34,606.18	
Gross income from all sources .....		\$10,560,571.98
Expenses—		
Maintenance way and structures .....	\$ 647,699.82	
Maintenance equipment .....	835,803.19	
Transportation .....	4,228,762.05	
General .....	1,480,829.80	
Taxes .....	199,305.53	
Total expenses .....	7,392,400.39	
Balance .....		\$ 3,168,171.59
Deduction, interest at 5 per cent on valuation .....	1,566,158.96	
Net income .....		\$ 1,602,012.63
Divisible thus:		
Chicago Railways Company, 45 per cent .....	\$720,995.68	
City of Chicago, 55 per cent .....	881,106.95	
		\$ 1,602,012.63
Proportion due city of Chicago .....		\$ 881,106.95
Less payments during year .....		17,757.20
Net payment .....		\$ 863,349.75

**Interborough Rapid Transit Company, New York.**—At the hearing before the New York public service commission, first district, on April 7, regarding the proposed issue of \$55,000,000 bonds E. F. J. Gaynor, auditor of the company, submitted the following estimate of earnings for 1908: Gross earnings, \$24,959,728; operating expenses, \$10,903,996; net earnings, \$14,055,732; other income, \$1,070,772; gross income, \$15,126,504; interest and rentals, \$5,296,822; taxes, \$1,600,000; total interest, rentals and taxes, \$6,896,822; balance, \$8,229,672; 7 per cent dividends on Manhattan Railway stock, \$4,200,000; net income, \$4,029,672; 9 per cent dividends, \$3,150,000; surplus, \$879,672. T. P. Shouts, president Interborough-Metropolitan Company, said he believed that the maintenance charges of the Interborough Rapid Transit Company were high enough.

**Metropolitan Street Railway, New York.**—Kuhn, Loeb & Co. have announced that they would buy at their face value the coupons due on April 1 on the 4 per cent refunding bonds of this company, provided that the bonds are deposited with the protective committee, of which E. S. Marston is chairman, on or before May 15.

**Mt. Vernon (O.) Railway & Light Company.**—F. V. Owen was appointed receiver for this company on April 4 by Judge Charles W. Seward of Newark, O. The appointment was made on the application of P. B. Chase of Washington, D. C. The company expended \$60,000 for improvements last year, the greater part of which is represented now by floating debt, as the company has been unable, on account of financial conditions, to dispose of bonds which had been authorized.

**New York City Railway.**—Judge Lacombe of the United States circuit court, New York, has granted the petition of the receivers of this company and the Metropolitan Street Railway for authority to issue \$3,500,000 of 6 per cent 1-year receivers' certificates. The certificates will be superior in lien to the general and collateral trust and the refunding mortgage bonds. The receivers are to keep a separate account of the proceeds of these certificates and no part is to be used except in the improvement, acquisition, preservation or maintenance of property which is covered by both of the mortgages.

**Norfolk & Portsmouth Traction Company, Norfolk, Va.**—At the annual meeting of the shareholders W. W. Moss was elected a director to take the place of E. L. Bemis.

**Schenectady (N. Y.) Railway.**—Gross earnings in the quarter ended December 31, 1907, were \$246,272, as compared with \$241,998 in the corresponding quarter of the previous year. Expenses were \$167,054, as compared with \$161,319. Net earnings were \$79,218, as compared with \$80,679. After crediting other income and providing for charges the final surplus was \$56,436, as compared with \$49,495.

## Dividends Declared.

Brooklyn City Railroad, quarterly, 2½ per cent.  
 Capital Traction Company, Washington, D. C., quarterly, 1½ per cent.  
 Cincinnati Newport & Covington Light & Traction Company, Covington, Ky., common, quarterly, three-fourths of 1 per cent; preferred, quarterly, 1½ per cent.  
 City Railway, Dayton, O., common, quarterly, 1¾ per cent; preferred, quarterly, 1½ per cent.  
 Columbus (O.) Railway & Light Company, one-half of 1 per cent.  
 Duluth-Superior Traction Company, Duluth, Minn., preferred, quarterly, 1 per cent.  
 Knoxville (Tenn.) Railway & Light Company, common, quarterly, 1 per cent; preferred, quarterly, 1½ per cent.  
 Louisville & Northern Railway & Lighting Company, New Albany, Ind., class A, quarterly, 1½ per cent; class B, quarterly, 1 per cent.  
 Manchester (N. H.) Traction Light & Power Company, quarterly, 2 per cent.  
 Memphis (Tenn.) Street Railway, preferred, quarterly, 1¼ per cent.  
 Omaha & Council Bluffs Street Railway, preferred, quarterly, 1¼ per cent.  
 Philadelphia Company, Pittsburg, common, quarterly, 1½ per cent.  
 Scioto Valley Traction Company, Columbus, O., preferred, quarterly, 1¼ per cent.  
 Syracuse (N. Y.) Rapid Transit Company, preferred, quarterly, 1½ per cent.  
 Toronto Railway, quarterly, 1½ per cent.  
 Tri-City Railway & Light Company, Davenport, Ia., preferred, quarterly, 1½ per cent.

## ELECTRIC RAILWAY EARNINGS.

	Gross earnings.	Operating expenses.	Net earnings.	Total charges.	Surplus.
Ft. Wayne (Ind.) & Wabash Valley Trac. Co., January, 1908..	\$ 103,019.96	\$ 57,496.94	\$ 45,523.02		
Ft. Wayne (Ind.) & Wabash Valley Trac. Co., January, 1907..	91,178.15	54,795.43	36,382.72		
Norfolk (Va.) & Portsmouth Traction Co., January, 1908....	145,360.93	98,621.06	46,739.87		
Norfolk (Va.) & Portsmouth Traction Co., January, 1907.....	152,019.83	96,787.49	55,232.34		
Lexington (Ky.) & Interurban Railways, January, 1908.....	43,043.57	28,923.16	14,120.41		
Lexington (Ky.) & Interurban Railways, January, 1907.....	39,713.67	28,080.99	11,632.68		
American Railways Company, Philadelphia, subsidiary companies, February, 1908.....	192,592.06				
American Railways Company, Philadelphia, subsidiary companies, February, 1907.....	192,967.52				
Montreal Street Railway Company, February, 1908.....	270,224.43	201,449.05	68,775.38	\$ 46,206.58	\$ 22,566.80
Montreal Street Railway Company, February, 1907.....	243,467.94	182,275.08	61,192.86	36,493.42	24,699.44



# Manufactures and Supplies

## ROLLING STOCK.

**Oklahoma Railway**, Oklahoma City, Okla., is reported to be in the market for two cars.

**Lehigh Valley Transit Company**, Allentown, Pa., is in the market for four interurban cars.

**Sandusky Norwalk & Mansfield Electric Railway**, Norwalk, O., is in the market for two cars.

**Rutland Railway Light & Power Company**, Rutland, Vt., will place an order for a 44-foot express car body.

**Mississippi Valley Interurban Railway**, J. E. Melick, president, Springfield, Ill., has placed an order with the St. Louis Car Company for two double-truck interurban cars, 40 feet long over all. Delivery is to be made in May.

## SHOPS AND BUILDINGS.

**Connecticut Valley Street Railway**, Greenfield, Mass.—The local car houses of this company were destroyed by fire on April 8. The loss is reported to be \$25,000.

## TRADE NOTES.

**A. E. Mitchell**, formerly manager of purchases and supplies of the New York New Haven & Hartford Railroad, has resigned to accept a position with the Wyckoff Pipe & Creosoting Company, Stamford, Conn.

**William A. Kreidler**, president of the Electrician Publishing Company, Chicago, died at Augusta, Ga., on March 26. Mr. Kreidler was the founder and principal owner of the Western Electrician, published by the company of which he was the head.

**Charles N. Wood Company**, 79 Milk street, Boston, Mass., announces that it has arranged with the estate of the late Louis Pfingst to continue the manufacture and sale of the Pfingst fenders, brake handles, car couplers and other electric railway specialties.

**Iwan Brothers**, Streator, Ill., report that the demand for Iwan post hole augers is greater this year than it ever has been before. In March the orders received exceeded those for March, 1907. Several good-sized orders for augers have recently been received from railways.

**Ford, Bacon & Davis**, New York, have been appointed consulting engineers to the receivers of the New York City Railway, with regard to certain improvements now being made in this property. The representative of Ford, Bacon & Davis, acting in the capacity of chief engineer, will make his headquarters at the offices of the railway company, 621 Broadway, and will report to the general manager for the receivers.

**Frank MacGovern** announces that he has associated himself with J. Warren Archer in the organization of a new firm, to be known as MacGovern, Archer & Co., with headquarters at 114 Liberty street, New York. Mr. MacGovern was formerly vice-president and general manager and Mr. Archer was manager of the sales department of Rossiter, MacGovern & Co. The new organization will handle electrical and steam machinery.

**Atha Steel Casting Company**, Newark, N. J., now has installed in its plant a complete equipment of machinery for making motor gears and pinions of manganese steel. The sales department is already placing these products on the market. The results of comparative experiments are said to substantiate the claim that a gear or pinion made of manganese steel will outlast, under equal service conditions, four or five gears or pinions manufactured from ordinary cast steel.

**H. G. Perring**, secretary of the Engineers' Club, Philadelphia, and formerly engineer with the Keystone Fireproofing Company, has become associated with the General Fireproofing Company, Youngstown, O., as engineer, with office in Philadelphia. Mr. Perring is widely known among railway engineers, having at different times been associated with the engineering departments of the Philadelphia & Reading, Choctaw Oklahoma & Gulf and the Philadelphia Rapid Transit Company.

**Westinghouse Machine Company**, through its president, George Westinghouse, has made formal announcement of the discharge of the company's receivers, which was reported in the Electric Railway Review for April 4. Mr. Westinghouse states that all matters have been satisfactory arranged, and that the company's position is greatly strengthened from every

standpoint. Announcement is also made of the election of William H. Donner as vice-president of the company, in direct charge of all its activities.

**James Graham**, an electrical and mechanical engineer who has been identified with the electric trade in Europe, has become mechanical and electrical engineer of the Milloy Electric Company, Bucyrus, O., and has already entered upon his duties. Mr. Graham comes to the Milloy company with the highest recommendation of leading electric corporations of Europe. His early knowledge in mechanics was learned in the Fairchild shipbuilding yards, Glasgow, Scotland. After completing a course in mechanical and electrical engineering in Glasgow University, Mr. Graham was employed for some time with Scott & Mountain, electrical engineers, New Castle on Tyne. He next became superintendent of the winding and testing department of the General Electric Company of Manchester and London. Mr. Graham was next with George F. Milns & Co., electric car builders, at Hadley, Shropshire, England, as chief mechanical and electrical engineer. He was then made superintendent of the electrical manufacturing department of Armstrong & Whitworth, New Castle on Tyne, and upon severing this connection was made works manager of the car shops of the Glasgow municipal tramway system, where he also held the office of superintending erection engineer. He resigned this position to go with the Brush Electric Engineering Company, Loughboro and London, being the chief erecting engineer of the street railway car department. Under this engagement Mr. Graham installed street cars in over a hundred cities in Europe and gained an extensive knowledge, not only in the building but in the equipment and operation of street cars and street railway systems. During his experience in Europe Mr. Graham was engaged in every department connected with electric railways, studying both the manufacturing and the operating ends. He came to the United States the latter part of last year and has been engaged as superintendent of a large electrical manufacturing concern, resigning this position to become affiliated with the Milloy company.

## ADVERTISING LITERATURE.

(Mention of the Electric Railway Review will assure prompt attention to requests for publications listed here.)

**National Audit & Appraisal Company**, Indianapolis, Ind.—Two leaflets outline the various services rendered electric railway companies.

**R. Morrison Snyder**, Consulting Architect and Structural Engineer, Ft. Wayne, Ind.—A post card giving the approximate weight per cubic foot of building materials.

**Aberthaw Construction Company**, 8 Beacon Street, Boston, Mass.—A 32-page circular illustrates and describes a large amount of important reinforced concrete construction handled by this company.

**American Engineering Company**, Indianapolis, Ind.—Among recent publications are attractive booklets entitled "Evolution of Transportation" and "The Promoter and the Financial Problem."

**Chicago Mica Company**, Valparaiso, Ind.—A series of blotters describes the good properties of "Micabond" in an interesting way. This company's mica and mica products have obtained eminent positions as electrical insulators in the electric railway field.

**Garvin Machine Company**, Spring and Varick Streets, New York.—Edition C of this company's catalogue, called the international edition, because it is printed in English, French and German, is descriptive of standard milling machines and is well illustrated and printed.

**Universal Portland Cement Company**, Commercial Bank Building, Chicago, Ill.—Bulletin No. 47 shows 11 half-tone views of interesting concrete construction, in which Universal Portland cement was used. Included in the number is a view of a Vandalia Railway concrete viaduct.

**Brown Hoisting Machinery Company**, Cleveland, O.—"Ferroinclave" is the subject of an excellent catalogue of 36 pages and cover, just issued. Ferroinclave is a corrugated sheet steel of special shape used in reinforced concrete construction and its advantages are set forth by both lucid text and fine illustrations.

**Inland Empire System**, Spokane, Wash.—"Profitable Farming in the Spokane Country" is the title of a large folder containing much information of value to all interested in the subject. A number of excellent half-tone illustrations afford evidence of profitable farming and a map shows the farming districts served by the company's electric lines.

**Allis-Chalmers Company**, Milwaukee, Wis.—Bulletin No. 1062 is devoted to an interesting description of the Milwaukee

Northern Railway. A number of illustrations are used, including several of the producer gas power plant, which is equipped with Allis-Chalmers 4-cycle double-acting twin-tandem gas engines, each of 2,000-horsepower capacity, driving Allis-Chalmers alternating-current generators.

**Goldschmidt Thermit Company, 90 West Street, New York, N. Y.**—"Reactions," the quarterly publication of this company, for the first quarter of 1908 is a booklet 8 by 11 inches, containing 22 pages of reading matter. The principal articles are on recent improvements in the thermit welding process and on important repairs made by the thermit process in 1907. Illustrations showing repairs made on engine crankshafts, water wheels, propeller shafts and propeller blades and locomotive frames are given.

#### THE CLARK LIGHTNING ARRESTER.

Very broad claims are made for a lightning arrester now being built by the Clark Rapids, Mich. Manufacturing Company, Grand Rapids, Mich. A sketch of the essential parts of one of these arresters is reproduced herewith. The principles governing the operation of this arrester are simple. It has a low resistance, free discharge and a powerful magnetic blowout capable of caring for static discharges at high frequency. It is also said to require but little or practically no attention. As furnished for pole line or car use the arrester is inclosed in a wooden box 13 $\frac{1}{2}$  by 6 $\frac{1}{2}$  by 7 inches in size.

The essential parts of the device as shown in the sketch comprise a spark gap, one side of which is connected to ground, a kicking coil and a magnetic blowout. The line current passes into the one-gap electrode and to follow its path to the apparatus it must next turn an acute angle. This abrupt change in direction assists materially in forcing the troublesome currents to jump the air gap to ground. Taking its current from the grounded side of the gap is a magnetic blowout coil, which serves to disrupt the arc in the spark gap whenever the dynamic current begins to maintain an arc.

A powerful kicking coil, in addition to the blowout coil and the spark gap, concludes the list of essential parts. This kicking coil is wound in multiple. It has a very high reactance which effectively retards the passage of lightning through the arrester by forcing the static discharge across the air gap to the grounded terminal. One feature in which the Clark arrester differs most from the average arrester is in the composition and arrangement of the electrodes or brushes, the brushes being all metallic, with the exception of the 14-inch carbon tips, with a  $\frac{1}{16}$ -inch air gap.

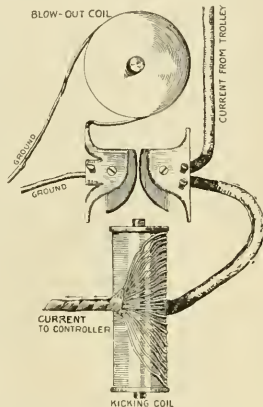

Sketch of the Clark Lightning Arrester.

#### VACUUM APPARATUS FOR CAR CLEANING—OPERATED BY BRAKE RESERVOIR PRESSURE.

The use of vacuum apparatus for cleaning purposes is growing very rapidly. A number of railways find compressed and vacuum processes to be of especial value in renovating and regularly cleaning passenger cars. The National Vacuum Cleaning Company, Dayton, O., manufactures a special car cleaning outfit which is designed to operate with air pressure taken from the regular brake supply piping system of an electric car.

This vacuum car cleaner includes a dust-collecting tank, the interior being so arranged as to separate the dust from the air; an air jet vacuum producer mounted on top of the tank; special vacuum hose for conveying the dirt from the car to the vacuum tank, and the cleaning tools.

The vacuum producer is connected to the compressed air supply (either to the pipe line or the air brake reservoir on the car) by means of a compressed air hose. One end of the vacuum hose is connected to the side of the tank and the other end, to which the tools are attached, is taken into the car. The compressed air is turned on and regulated by

the valve on the vacuum producer until the proper vacuum is obtained. The cleaning tools are passed over the seats and other articles to be cleaned until all the dirt is removed. The machine is not complicated and there is nothing to get out of order. It requires neither care nor attention other than that necessary to empty the tank daily of the accumulated dirt.

Probably the most important point to the railway man interested in car cleaning is that this vacuum cleaner not only removes all the dirt from the seats and cushions by suction, but carries it outside of the car and deposits it in a specially designed receiving tank, thus doing away with dust and dirt about the car house.

#### MERCHANDISE CREDITORS' PLAN FOR WESTINGHOUSE ADJUSTMENT.

The Westinghouse Electric & Manufacturing Company's "Merchandise Creditors'" committee has submitted a plan for readjustment of the debt and early restoration of the business to the company. The plan is substantially as follows: (a) Holders of the merchandise debt to take new fully paid assenting stock at par in settlement of claims. (b) Such of the bank debt as is not converted into "assenting stock" to be provided for, partly by convertible bonds of the existing authorized issue at par and partly by 5 per cent notes running at least five years or for an average period of at least five years. (c) Existing issues of convertible bonds, debenture certificates and collateral notes not to be disturbed. (d) The stockholders to subscribe at par for \$6,000,000 of new "assenting stock" to increase the working capital. In recommending the acceptance of its plan the committee has issued a circular, of which an abstract follows: "At a recent conference of a number of the merchandise creditors, representing a majority in amount of the merchandise debt of the company, Joseph W. Marsh, vice-president the Standard Underground Cable Company, Pittsburg, Pa.; F. W. Roebeling, president John A. Roebing Sons Company, Trenton, N. J.; Charles R. Remington, secretary the American Electrical Works, Phillipsdale, R. I.; A. Bournonville of Alfred F. Moore, Philadelphia, Pa.; and George M. Verity, president the American Rolling Mill Company, Middletown, O., were appointed to ascertain (in conference with the committee acting under the agreement dated January 20, 1908) whether some plan could be devised for the prompt termination of the receivership.

"If the plan which has been formulated by the 'Merchandise Creditors'" committee meets—as it is confidently expected it will—with the general approval of the creditors, the company will be practically freed from floating debt and provision will have been made for all cash requirements for a period of five years. The following are some of the reasons in support of the plan suggested by the committee: It prevents a mortgage bond issue. It prevents an unduly large issue of bonds of any kind. Under the mortgage bond plan we are convinced that the stockholders will be unwilling or unable to raise much new cash capital. The confidence in the future of the company which the merchandise creditors express by taking stock in full for their claims should certainly be an added incentive to the stockholders to make this plan effective. It enhances the company's credit, so that suppliers of material may feel free to extend the necessary current credit for future transactions, as they would not be disposed to do if there were a large mortgage bonded indebtedness and no material increase in cash capital. Because there is every reason to believe that the merchandise creditors' plan can be made effective in a much shorter time than any other, it being necessary to deal only with stockholders and the floating indebtedness; and because a speedy rehabilitation of the company is essential to the preservation of its good will and its working organization, which are costly and valuable assets. Because we believe that it is not only better for the creditors, but better for business interests generally, that this concern be put on its feet at the earliest possible moment. An immediate rehabilitation of the company will certainly have a very favorable effect on general business conditions, while continued delay or announcement of further trouble of any kind in the settlement of its affairs would have a very depressing effect upon conditions that are already sufficiently critical. A sale of the property would certainly have international adverse effect upon values of industrial securities. Because under normal conditions the country needs this company to be in strong active operation, not only as a large employer of skilled and unskilled labor, and as a large consumer of materials and supplies, but also as one of the large producers of apparatus that is absolutely essential in the development of the country."

The committee presents figures to show the smaller fixed charges under its plan than under the scheme for issuing mortgage bonds with a sinking fund provision and to show

that under its plan holders of claims aggregating but \$12,275.042.68 would have to consent to the arrangement for rehabilitation, while under the other scheme owners of claims and securities amounting to \$41,446,745.38 would have to consent. The quick assets with this plan operative are computed at \$33,434,399.20, of which \$6,000,000 would be the new cash from stockholders, \$12,832,728.56 cash accounts and bills receivable and \$14,601,670.64 working assets (inventory), the latter two items being computed as of February 29, 1908. The committee states that a careful estimate shows that under reasonably favorable conditions the company should, during the next five years, earn sufficient to pay all its fixed charges, 7 per cent per annum on the preferred stock, 6 per cent per annum on its entire issue of assenting stock (amounting to about \$34,000,000 when this plan is effective), and create an annual surplus of at least \$1,000,000. From figures submitted by the accountants, this estimate, the committee adds, would seem to be conservative. The company, through President George Westinghouse, signifies its approval of the plan. The "Readjustment" committee announces that the "Merchandise Creditors'" committee and representatives of the company have expressed confidence that by June 1, 1908, they will be able to furnish subscriptions at par to \$10,000,000 of new assenting stock, payable, as to \$4,000,000, in floating debt (chiefly merchandise claims), and as to \$6,000,000 in cash, in instalments extending over a period of 10 months. The "Readjustment" committee deemed it wise to afford the merchandise creditors an opportunity to accomplish this result.

#### MEDICAL AIR LOCK.

On March 20 the workmen and staff of S. Pearson & Son, Inc., who have just completed the excavation of the East river tunnels for the Pennsylvania Railroad, presented to



Medical Air Lock.

E. W. Moir, vice-president of the company, an interesting model of a medical air lock bearing the inscription: "Presented to Mr. E. W. Moir, the maker of the first medical air lock on the Old Hudson Tunnel, 1890, by grateful 'Sand Hogs' on the Pennsylvania East River Tunnels, New York, 1908." The presentation was made in the yards of S. Pearson & Son in Long Island City, Henry Japp, local manager, tendering the salutation.

The model is made of brass, oxidized to look like steel, is mounted on a mahogany base and has a silver name plate. It was built by H. E. Boucher of New York to a scale of 1½ inches to the foot, measuring about 2 feet 6 inches long by 9 inches in diameter. It is complete in every respect, being lighted with electric lights and supplied with compressed air by an air pump. The hospital beds for the men to lie on and the compressing and decompressing valves along with thermometers and pressure gauges are shown in full detail.

The importance of the medical air lock in tunnel con-

struction where compressed air is a factor is little understood. Workmen, especially those who have been working back of the shield in an atmosphere considerably compressed, upon leaving the tunnel are occasionally seized with a contraction of the muscles which is commonly termed "bends" and which if not treated properly and at once usually ends in death. In the building of the East river tunnels there have been at least three cases of men who to all intents and purposes were dead but after being recompressed in the medical air lock have fully recovered. Similarly there have been cases of paralysis which were thoroughly restored in the medical air lock. There are six medical locks installed in the East river tunnels for the use of engineers and workmen, these being all fitted with a double chamber so that the medical officer can pass in and out to his patient without interfering with the decompression.

Mr. Moir built the first air lock ever constructed in 1890, and this model is the work of appreciation and gratitude of the compressed air workers to the man who has done so much to relieve them of the dangers of their calling.

#### THE ROOKE AUTOMATIC REGISTER AND FARE COLLECTOR ADOPTED IN DES MOINES.

The Des Moines City Railway Company on Thursday of this week began using the Rooke automatic register and fare collector on its University avenue line. This register, which was described and illustrated in the Electric Railway Review of July 20, 1907, page 88, is manufactured by the Rooke Automatic Register Company of Providence, R. I., and has been in use for over a year on the lines of The Rhode Island Company in Providence and in other eastern cities.

The device is simple, consisting only of a compact registering apparatus which fits comfortably into the hand. The lower end of a chute running through from top to bottom rests in the palm of the hand. The passenger deposits his fare in the opening at the top. When the fare has entered the releasing mechanism is operated by the coin, and at the same time the entrance of the coin closes the passage. By the same action the lower end of the chute is opened to allow the coin to pass into the hand in which the register is held. During the same operation the fare is recorded and a bell is rung. When the coin has once entered the slot it cannot be removed but must pass through the chute to the conductor's hand, while the closing of the entrance to the coin passage or chute after the receipt of the coin prevents another coin entering until the mechanism is reset by the conductor. This act of resetting is done by the conductor pressing a trigger with his index finger, and this act puts the register in position for recording the succeeding fare.

The totalizing register is fastened directly to the mechanism, the figures showing through openings on the side of the case, which openings are covered by a heavy crystal. The mechanism is interlocked in such a way that the device cannot be used without turning the counters, and the connections are positive in action, not depending upon springs or ratchets. The totalizer numbers consecutively up to 100,000 and sets back automatically when that figure is reached. The totalizing counter is therefore never interfered with, the securing of the trip record being accomplished by merely recording the last number.

The chief advantage claimed for this register is that it insures a complete accounting for all fares collected, independent of the conductor, while providing perfect freedom in making collections, and that it guarantees the turning in of all fares while completely absolving the conductor from any suspicion of dishonesty.

One of the objects of the system is to encourage the use of nickels or metal fare tickets in paying fares, thus relieving the conductor to a large extent of the necessity for making change, although it is possible for him to do so without difficulty. The register is retained in the hand by means of a ring through which the conductor passes his middle finger, and when the use of both hands is required the register may be allowed to turn upon the finger and drop, in the same manner as the ordinary conductor's punch.

The Des Moines City Railway has adopted an aluminum fare check and in order to popularize their use it is planned to issue neat holders for these checks in a convenient form to slip in the pocket. Conductors will not be allowed to deposit fares for passengers, but, if required to furnish change, will hand the full amount to the passenger, who will himself deposit a nickel or a fare check. Transfers will not be registered.

Some of the most important advantages claimed for this system are as follows: The conductor is relieved of the inconvenience and physical effort involved in ringing up fares and the time thus consumed is saved. There is no possibility

of a mistake in registration. The opportunities for disputes with passengers in regard to the denomination of a coin offered are eliminated. A large saving of labor in the auditor's office will be effected, as a register will be assigned to a conductor for an entire day, to be turned in with his collections and trip reports, and the record of one register will not have to be checked up with the reports of various conductors.

The Des Moines City Railway has been conducting a campaign of education in the newspapers in order to familiarize the public and the conductors with the advantages of the new system.

The total weight of the register is only 21 ounces. When not in use it is suspended from a leather bracket carried upon the conductor's breast, thus allowing him free use of both hands.

**TRUCK WITH NEW MOTOR SUSPENSION.**

A new method of motor suspension has recently been patented by B. R. Van Kirk, mechanical engineer of the truck department of the Baldwin Locomotive Works. In the new type of truck the motor weight upon the suspension is fulcrumed over the driving box and applied to the frame in an upward direction at a point near the center of the truck. This relieves the end frame of the motor weight and decreases the tilting effect of the motor reactions. Heretofore outside hung motors have been suspended from the truck frame in such a way that their weights and torque reactions were applied with a large leverage, thus bringing severe bending moments on the truck frames and requiring heavy structures. The intermittent nature of the motor torque reactions disturb the equilibrium of the frame and produce a tilting or rocking effect.

The objects of the new style of suspension are: (1) To entirely relieve the overhanging ends of truck frame from the weights and shocks of motor support. The weight by fulcruming over the journal box as shown in the illustrations is actually transformed into a supporting reaction near center of frame. (2) To transfer the motor torque reactions to points relatively near the center of the frame, thus reducing their tendency to produce a rocking effect and consequent fluctuation in weight and available adhesion.

Trucks of this design, with inside hung brakes, are now in successful operation on the lines of the Orange County Traction Company, Newburgh, N. Y.

As the new truck is constructed of commercial sizes of iron and steel, with castings almost entirely eliminated, the

mits them to be made so sensitive as to result in an easy riding truck.

In short wheel base trucks the space available for bolster and transom is so limited that a narrow bolster is necessary. To permit the use of inside hung brakes many builders find it necessary to locate the bolster springs at the extreme ends of the bolster, parallel to and under the side frames. When so placed the space is so limited as to necessitate the use of a short half elliptic spring. With the Baldwin construction not only a swing bolster of ample width, but a full elliptic

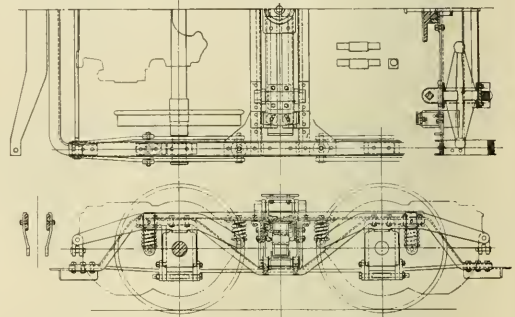

**New Baldwin Truck—Method of Suspension.**

spring, can be provided at each end of the bolster and not interfere with the inside hung brakes. The spring seated on the inside and at the top of the bolster makes a very compact and stable construction.

To keep the car at the same height and offset the wear of tires and journal brasses, a novel adjustment is provided at the lower end of the swing link. This adjustment is simply an eccentric pin placed in a guide as shown in the illustration.

Special care has been given to the design of brake work,

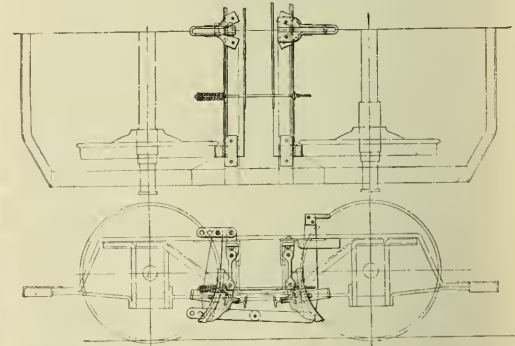

**New Baldwin Truck—Arrangement of Brake Rigging.**

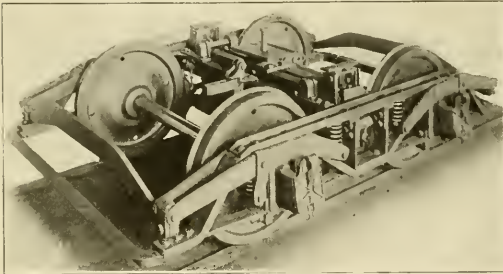

**New Baldwin Truck—Showing New Method of Suspension for Outside Hung Motors.**

weight is reduced to approximately 2,600 pounds, exclusive of wheels, axles and boxes, for center pin loads up to 18,000 pounds. Simplicity of detail and of construction make it an easy matter to replace parts injured by accident or wear, and this can be done in any shop of ordinary facilities.

One of the leading features of the new light truck is the method of motor suspension. The manner in which the suspension beams fulcrum on the driving boxes is clearly shown in an illustration. The motor weight and reaction together with the center pin load are applied to the truck frame at the same point. In this arrangement each motor is supported independently, thus decreasing the tilting movement of the frame. As the weight of the motors comes directly over the driving boxes the adhesion of the wheels is increased.

On trucks where the motors are supported on the end frames it is necessary to make the carrying springs of sufficient stiffness to carry the weight of the motors in addition to the center pin loads and weight of truck frame. The new suspension relieves the springs of the motor weight and per-

which, as illustrated, is simple, strong and light. Ample clearance is provided, while all parts are easily accessible, thus simplifying inspection and the replacing of brakeshoes. A removable brakeshoe is provided which fits into a standard M. C. B. head. Provision is made for readily adjusting brake work to take up the wear of shoes and tires. Journal boxes are of standard M. C. B. design, with ample space for lubrication. Journal centers are also M. C. B. standard. On account of its strength, lightness and durability and the use of M. C. B. standards for all wearing parts, this truck should prove popular for city and suburban service.

# Dearborn Water Purifying Reagents

Increase the efficiency and the years of service of steam boilers by keeping them in good condition internally. Gallon sample of the water required for analysis before preparing treatment.

## Dearborn Drug & Chemical Works

ROBT. F. CARR, PRESIDENT

299 BROADWAY, NEW YORK. POSTAL TELEGRAPH BLDG., CHICAGO

# Collecting and Registering Fares

—by the Rooke  
Automatic  
Collector System:

PASSENGER  
COMPANY  
CONDUCTOR

—by all  
old-fashioned  
register systems:

PASSENGER  
CONDUCTOR  
Company (?)

Under old-fashioned systems nickels are often collected without being registered—and unregistered nickels never reach the treasury.

Under the Rooke System every nickel is registered before it reaches the conductor's hand.

There is no chance for the nickel to go astray.

Rooke Automatic Register Co. : Providence, R. I.

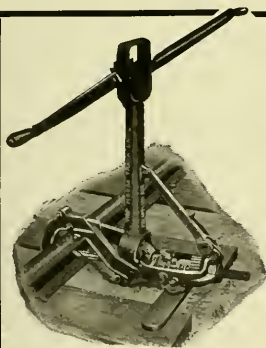
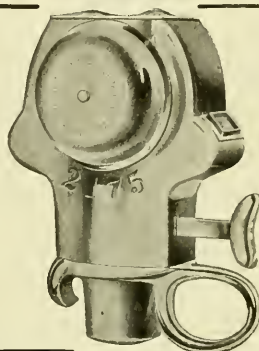

# The Moore Track Drill

does not interfere with traffic!

The shifting of one lever and a few seconds' time takes down the drill—the operation reversed makes it ready for work again.

This is only one of the many strong points about the Moore Track Drill that make it worth buying.

Ask for descriptive catalogue.



Kalamazoo Railway Supply Co. Kalamazoo Michigan

THE MAIN FEATURE of this coupler is its great strength and simplicity. In fact, it makes a coupling joint that is as strong as, if not stronger than, the cars themselves. It will be noted that the head has heavy coupling faces, and, with the great width of the link and heavy reinforcing ribs on the outside of the head, lateral breakage due to curvature strains is impossible. The heavy lock and its bearing both at the top and bottom give the strongest kind of a locking device.

Ask for new catalogue of traction devices.

Washburn Steel Castings & Coupler Co.  
MINNEAPOLIS, MINN.

# Washburn "K" Type Traction Coupler



Western Agents:  
TWEEDY, HOOD & FINLEN, 204 Fisher Bldg., Chicago  
Canadian Agent: JOHN TAYLOR, Montreal

## THE J. G. BRILL COMPANY, PHILADELPHIA, PA.

AMERICAN CAR COMPANY, ST. LOUIS, MO.

G. C. KUHLMAN CAR COMPANY, CLEVELAND, OHIO

JOHN STEPHENSON COMPANY, ELIZABETH, N. J.

WASON MANUFACTURING CO. SPRINGFIELD, MASS.

MAIN OFFICE: PHILADELPHIA, PA.  
LONDON OFFICE: 110 CANNON ST. E.C.  
PACIFIC COAST AGENTS: PIERSON  
ROEDING & CO., SAN FRANCISCO.  
AUSTRALIAN AGENTS: NOYES  
BROTHERS, SYDNEY. CABLES:  
"BRILL," PHILA., "AXLES" LONDON.

*CARS TRUCKS SEATS RATTAN SPRINGS SPECIALTIES SUPPLIES*

## FOR HIGH EFFICIENCY

The centrifugal pump is used in fire engines because it is the simplest and most effective means of producing pressure. It is used in the Brill power sprinkler for the same reason. The centrifugal pump is operated by a direct-connected motor (both located on the platform at one end of the car) and supplies pressure for distributing the water uniformly over fifty feet of roadway on each side of the track. The pump shaft has the only wearing surface in the entire mechanism, so no trouble is caused by heated parts. The amount and direction of the water is always under perfect control by the patented type of sprinkling head employed. Write for catalog.

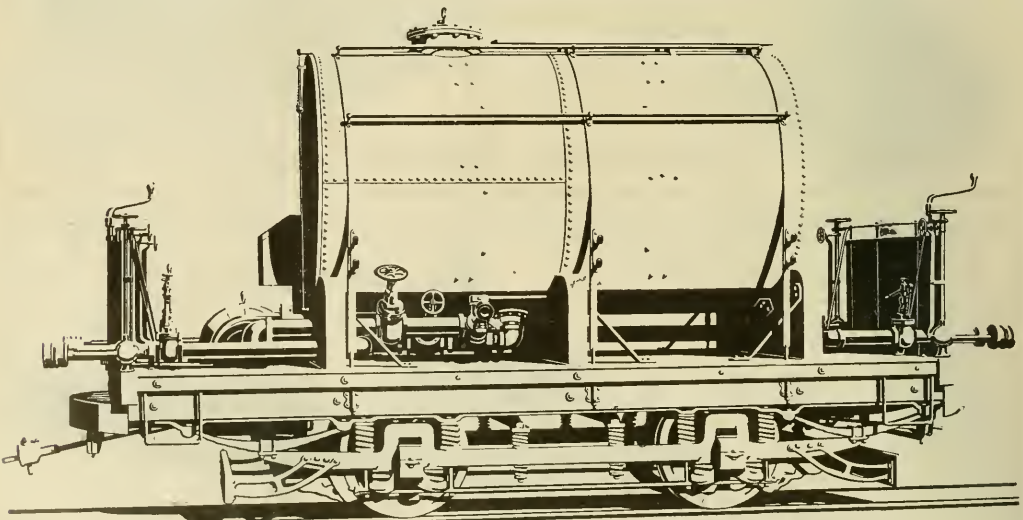

*THE BRILL CENTRIFUGAL SPRINKLER (PATENTED)*

# General Electric Company



## Grade "D"

Railway Motor

## Pinions



**"Original Equipment Quality"**

Heavier equipments and higher speeds in electric railway practice have rapidly increased the stresses in the teeth of railway motor gearing. The limited space available has now brought the stress per tooth and the conditions inducing wear on same to a point greater than exists in almost any other class of tooth gearing.



### Grade "D" Pinions

have been designed to effect the utmost possible strength, toughness and resistance to wear from friction. Tensile strength and elastic limit twice as high as in any other pinion on the market.

Prices warranted by longer life in all classes of service.

**Recently increased production facilities  
enable us to make prompt shipments.**

Chicago Office  
Monadnock Bldg.

**Principal Office: Schenectady, N. Y.**

Sales Offices in  
All Large Cities



Practical, comparative tests prove "Phono-Electric" Trolley Wire superior to hard drawn copper wire. Our "Red Booklet" is a book of facts—mailed free.

BRIDGEPORT BRASS COMPANY  
253 Broadway, New York  
Mills: Bridgeport, Conn.



There are other steel measuring tapes—but none so reliable and absolutely accurate as those made by

**THE LUFKIN RULE CO.** New York  
London, England  
Windsor, Canada

SAGINAW, MICH., U. S. A.

## HOPE TAPES AND WEBBINGS

ARE THE BEST

WRITE FOR SAMPLES AND PRICES

HOPE WEBBING CO., Providence, R. I.

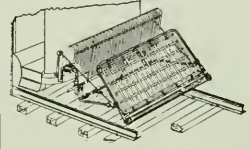

## ECLIPSE Life Guard

Manufactured by the  
ECLIPSE RAILWAY SUPPLY CO.  
Cleveland, Ohio

## BRAKE SHOES

- ☐ High speed and heavy equipment demand high-class BRAKE SHOES.
- ☐ Our shoes are of that one particular class that will answer your requirements in a perfectly satisfactory manner throughout.
- ☐ May we have an opportunity of proving our claim?

Special Mixture Shoes with "Re-enforced" Back and Lug

**STANDARD BRAKE SHOE CO.**

General Office and Works, Aurora, Ill.

Chicago Office, 315 Railway Exchange

# THE SYMINGTON JOURNAL BOX

IS NOW STANDARD

ON 95 PER CENT OF ALL MODERN ELECTRIC TRUCKS

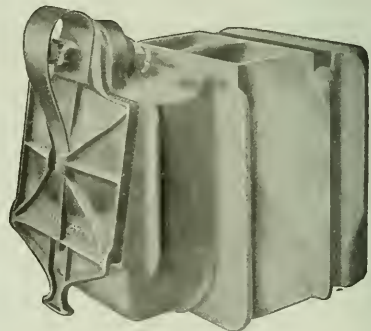
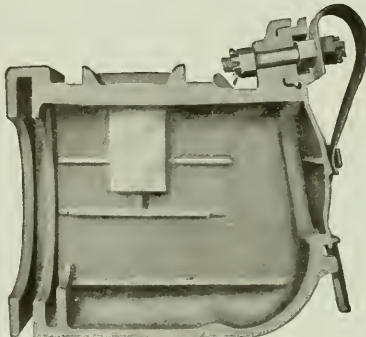

**Special Notice!**

WE ARE PREPARED TO FURNISH AT ONCE

**REPAIR BOXES**

FOR ANY MAKE OF TRUCK IN SERVICE

BALTIMORE  
MD.

**THE T. H. SYMINGTON CO.**

CHICAGO  
ILL.



# Electric Railway Review

PUBLISHED EVERY SATURDAY.

FORMERLY THE STREET RAILWAY REVIEW.

THE WILSON COMPANY, CHICAGO.

160 Harrison Street, Chicago  
150 Nassau Street, New York  
1529 Williamson Bldg., Cleveland

VOL. XIX  
No. 16

CHICAGO, APRIL 18, 1908

Whole No. 260      Subscription: Domestic . . . \$2  
Foreign . . . \$5  
Canada . . . \$3.50

## The Kind of Advertising You Have Done in the Past

*may not have paid, but there is a kind—a particular  
kind for your particular business—that will pay*

IT is wholly unfair to conclude that advertising doesn't pay, just because a certain kind of advertising not adapted to your business, or not suited to the electric railway field, did not produce results worth paying for. We repeat—there is a kind of *real* advertising for your particular business that will pay.

The facts in the case are these:

Advertising rightly used is a most efficient aid in securing new business and in holding old business.

Real advertising will help any sales force do a bigger business.

It will sell or help sell goods direct and it will aid greatly in selling goods through the jobbing trade—and all at a cost far below any other method.

But advertising, to be productive of most satisfactory results, should be done **sensibly**, which means telling the facts back of your goods in a manner to interest the buyer.

**attractively**, which means correct use of illustrations and display lines and the selection of proper spaces and positions.

**persistently**, which means "keeping everlastingly at it"—and this, coupled with the foregoing, surely brings success.

The co-operation of our Advertisers' Copy Service will produce the kind of advertising you will be glad to pay for, because it will help sell your goods. Just write today to—

## Electric Railway Review

160 Harrison Street

CHICAGO

# Present Day Economy

demands the

## Protection of all Apparatus

¶ A little time carefully spent in the inspection of your Lightning Arresters will no doubt save a good many repair bills in the coming six months.

¶ Lightning or static discharges on unprotected lines means the loss of generators or motors and the loss of income due to interrupted service.



suggests

## Garton-Daniels Arresters

¶ The latest model, Type E. G., for direct current railway circuits, shown herewith, has made an unexcelled record for efficiency and durability.

¶ It has been thoroughly tried out in four years of service tests.

¶ Let us suggest the least outlay which will give proper protection. Bulletin No. 21, showing the latest types, is ready for distribution.

## ELECTRIC SERVICE SUPPLIES CO.

Railway Material & Electrical Supplies

MAYER & ENGLUND DEPT.  
PHILADELPHIA

GARTON-DANIELS DEPT.  
KEOKUK

PORTER & BERG DEPT.  
CHICAGO

NEW YORK

PITTSBURG

SAINT LOUIS

ATLANTA

# National Air Compressors

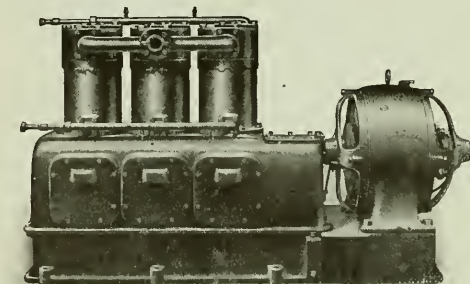

100 cu. ft. Type "3VS" Air Compressor.

These Compressors are especially adapted for service in car shops and barns, where compressed air is used, for various industrial operations, as well as for blowing dust and other accumulations out of car motors, controllers and seats.

Either direct or alternating current motors can be furnished for operating same.

Automatic starters which start and stop the Compressors and keep the air supply within the desired range of pressures are furnished with each Compressor.

Type "3VS" Compressors are built in capacities of 50, 100, 150 and 225 cu. ft. of free air per minute.

Write for Bulletin 84-F

## National Brake & Electric Company

MILWAUKEE, WIS., U. S. A.

NEW YORK: 111 Broadway  
SAN FRANCISCO, CAL.: W. F. McKenny, 69-71 First St.

PHILADELPHIA: W. H. Goble, 1722 Westmoreland St.  
BOSTON: F. E. Huntress, 131 State St.

LONDON: 14 Great Smith St., Westminster

General Sales Office: 519 First National Bank Building, Chicago

# Westinghouse

## Electrolytic Arresters

Act the same as safety valves on boilers

The film is the important detail. When the pressure reaches a certain voltage, this film breaks into myriads of minute punctures, making almost a short circuit for the higher voltages. As soon as the voltage is reduced to normal, these punctures seal up at once, and the original resistance reasserts itself.

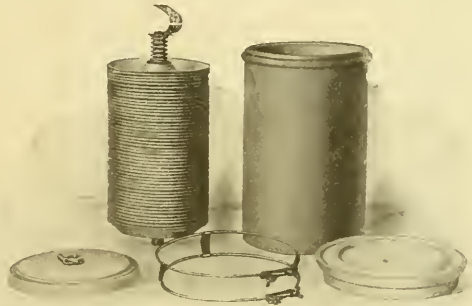

Parts of Westinghouse Type "E" Electrolytic Lightning Arrester.

Read all about it in Circular 1146.

### Westinghouse Electric & Mfg. Co.

Atlanta  
Baltimore  
Boston

Buffalo  
Chicago  
Cincinnati

Cleveland  
Dallas  
Denver

Detroit  
Kansas City  
Los Angeles  
Minneapolis

New Orleans  
New York  
Philadelphia

Pittsburg  
St. Louis  
Salt Lake City

San Francisco  
Seattle  
Syracuse

Canada: Canadian Westinghouse Co., Ltd., Hamilton, Ontario Mexico: G. & O. Braniff & Co., City of Mexico

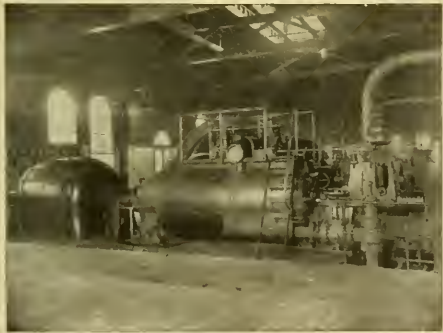

### Performance Tests

Every Westinghouse Turbine is subjected to a rigorous shop test before shipment. No attempt is made in these tests to produce ideal conditions, such as are not found in an ordinary power plant. The records are simply results obtained under usual operating conditions.

Catalogue 7002 for full particulars.

The Westinghouse Machine Co.  
Pittsburg, Pa.

### Type "J" Electric Pump Governor

Automatically regulates the operation of either alternating or direct current air compressors.

The arrangement of the air cylinder and cut-out details gives a pneumatic blow-out of unusual efficiency, so that the coils necessary for a magnetic blow-out are not required. This allows the governor to be placed on either the positive or negative side of the circuit.



Instruction Pamphlet No. T5042 describes the "J" Governor in detail.

Westinghouse Traction Brake Co.  
Pittsburg, Pa.

ALPHABETICAL INDEX TO ADVERTISEMENTS.

Advance Lumber Co. ....21  
 Allis-Chalmers Co. ....11  
 Aluminum Co. of America, I  
 American Brake Shoe & Fdry.  
 Co. ....13  
 American Electrical Works....  
 American Frog & Switch Co....  
 Anderson, Albert & J. M.,  
 Mfg. Co. ....26  
 Armstrong Oiler Co. ....26  
 Arnold Company ....14  
 Atlas Steel Casting Co. ....22  
 Automatic Trolley Guard Co. ....14  
 Babcock & Wilcox Co. ....12  
 Baker, Wm. C., Heating &  
 Supply Co. ....17  
 Baldwin Locomotive Works. ....18  
 Barbour-Stockwell Co. ....18  
 Barnes, G. H., Hardwood  
 Lumber Co. ....21  
 Beider, Francis, & Co. ....21  
 Bellamy Vestlette Mfg. Co. ....  
 Berthold & Jennings. ....21  
 Bridgeport Brass Co. ....15  
 Brill, J. G., Co. ....24  
 Brown, Harold P. ....24  
 Brown Hoisting Machy. Co. ....14  
 Buckeye Engine Co. ....16  
 Burnham, Williams & Co. ....18  
 Bylesby, H. M., & Co. ....14  
 Central Inspection Bureau. ....14  
 Chase-Shawmut Co. ....15  
 Chicago Mica Co. ....26  
 Churchill Cedar Co. ....21  
 Cincinnati Car Co. ....17  
 Cleveland Frog & Cross. Co. ....16  
 Collier, Barron G. ....24  
 Columbia Construction Co. ....  
 Consolidated Car Fender Co. ....23  
 Consolidated Car-Heating Co. ....14  
 Contractors' Supply & Equip-  
 ment Co. ....24  
 Crane Co. ....26  
 Craghead Engineering Co. ....14  
 Curtain Supply Co. ....14  
 Davis, John, Co. ....16  
 Dearborn Drug & Chemical  
 Works .....23  
 Dessert & Co. ....12  
 Drouvé, G., Co. ....12  
 Eclipse Railway Supply Co. ....26  
 Electric Railway Equipment  
 Co. ....12  
 Electric Ry. Improvement Co. ....26  
 Electric Service Supplies Co. ....2  
 Engineers and Contractors. ....14  
 Fairbanks, Morse & Co. ....15  
 Ford, Bacon & Davis. ....15  
 Galena-Signal Oil Co. ....15  
 Garford Co. ....21  
 General Electric Co. ....25  
 Green Engineering Co. ....25  
 Green Fuel Economizer Co. ....11  
 Griffin Wheel Co. ....14  
 Hagy, J. Milton, Waste Wks. ....11  
 Hale & Kilburn Mfg. Co. ....16  
 Harthorn, Stewart, Co. ....14  
 Heine Safety Boiler Co. ....14  
 Hewwood Bros. & Wakefield  
 Co. ....23  
 Holman, D. F., Ry. Tracklayer  
 Co. ....23  
 Hope Webbing Co. ....14  
 Humbird Lumber Co., Ltd. ....  
 Jewett Car Co. ....17  
 Johns-Manville, H. W., Co. ....5  
 Kalamazoo Ry. Supply Co. ....23  
 Lindsley Bros. Co. ....21  
 Lord & Burnham Co. ....13  
 Lufkin Balle Co. ....26  
 Lumen Bearing Co. ....14  
 Macallen Co. ....16  
 McGuire-Cummings Mfg. Co. ....16  
 Marshall, R. W., & Co. ....26  
 Meyers, Fred J., Mfg. Co. ....16  
 Miller Anchor Co. ....16  
 Milloy Electric Co. ....13  
 Model Stoker Co. ....13  
 Mordien Frog & Crossing Wks. ....13  
 National Brake & Electric Co. ....2  
 National Lock Washer Co. ....19  
 National Pole Co. ....21  
 Nauge Pole & Tie Co. ....21  
 New York Switch & Crossing  
 Co. ....12  
 Nilex Car & Mfg. Co. ....17  
 Northern Engineering Works....  
 Nuttall, R. D., Co. ....15  
 Ohio Brass Co. ....5  
 Okonite Co., Ltd. ....25  
 Pacific Coast Pole Co. ....21  
 Pantasote Co. ....21  
 Patten, Paul B. ....9  
 Pay-As-You-Enter Car Co. ....9  
 Power Specialty Co. ....15  
 Pressed Steel Car Co. ....15  
 Queen & Co. ....13  
 Rail Joint Co. ....18  
 Railway Specialty & Supply  
 Co. ....13  
 Railway Steel-Spring Co. ....14  
 Register, A. L., & Co. ....14  
 Robertson, Wm., & Co. ....19  
 Rodger Ballast Car Co. ....14  
 Rooke Automatic Register Co. ....15  
 Russell Car & Snow-Plow Co. ....20  
 S-E. Missouri Cypress Co. ....21  
 St. Louis Car Co. ....13  
 St. Louis Car Wheel Co. ....13  
 Sanderson & Porter. ....14  
 Saxton, E. ....14  
 Shimer & Chase Co. ....14  
 Sheaff & Jastaad. ....14  
 Simmons, John, Co. ....18  
 Smith, Peter, Heater Co. ....14  
 Speer & Carbon Co. ....14  
 Standard Brake Shoe Co. ....14  
 Standard Motor Truck Co. ....11  
 Standard Paint Co. ....14  
 Standard Steel Works. ....18  
 Standard Underground Cable  
 Co. ....11  
 Star Brass Works. ....18  
 Stone & Webster Engineering  
 Corporation .....22  
 Stuart-Howland Co. ....22  
 Symington, T. H., Co. ....22  
 Telegraph Signal Co. ....22  
 Trolley Supply Co. ....19  
 Under-Peet Stoker Co. ....18  
 U. S. Metal & Mfg. Co. ....18  
 Van Dorn & Dutton Co. ....14  
 Van Dorn, W. J., Co. ....11  
 Van Valkenburgh, E. C. ....26  
 Wanted and For Sale Cards. ....20  
 Washburn Steel Castings &  
 Foundry Co. ....23  
 Watson-Stillman Co. ....19  
 Western Electric Co. ....5  
 Westinghouse Elec. & Mfg.  
 Co. ....3  
 Westinghouse Machine Co. ....3  
 Westinghouse Traction Brake  
 Co. ....3  
 Weston Electrical Instrument  
 Co. ....13  
 Wharton, Wm., Jr., & Co. ....13  
 Wheeler Condenser & Eng'g  
 Co. ....20  
 Wheel Truing Brake Shoe  
 Co. ....14  
 White, J. G., & Co. ....14  
 Whitmore Mfg. Co. ....19  
 Wilson, J. G., Mfg. Co. ....19  
 Woodbury Carlton Co. ....19  
 Woodman, R., Mfg. & Supply  
 Co. ....20  
 Worcester, C. H., Co. ....21  
 Zelnicker, Walter A., Supply  
 Co. ....20

CLASSIFIED LIST OF ADVERTISERS.

Advertising Designs and Plates.  
 Woodbury-Carlton Co., Wor-  
 cester, Mass.  
 Advertising Service.  
 Van Valkenburgh, E. C., 2117  
 West One Hundred and Sec-  
 ond St., Chicago.  
 Advertising, Street Car.  
 Collier, Barron G., Flat Iron  
 Bldg., New York.  
 Air Brakes—(See Brakes and  
 Brake Parts).  
 Air Compressors—(See Com-  
 pressors, Air).  
 Alloys and Bearing Metals.  
 Brown, H. P., 120 Liberty St.,  
 New York.  
 General Electric Co., Schene-  
 cady, N. Y.  
 Lumen Bearing Co., Buffalo,  
 N. Y.  
 Ohio Brass Co., Mansfield, O.  
 St. Louis Car Co., St. Louis,  
 Mo.  
 Aluminum Wire, Etc.  
 Aluminum Co. of America,  
 Pittsburg.  
 Anchors.  
 Electric Service Supplies Co.,  
 200 Plymouth Bldg., Chicago.  
 Miller Anchor Co., Norwalk, O.  
 Ohio Brass Co., Mansfield, O.  
 Armatures and Colls, Winding  
 and Repairing.  
 Electric Service Supplies Co.,  
 200 Plymouth Bldg., Chicago.  
 General Electric Co., Schene-  
 cady, N. Y.  
 Marshall, R. W., & Co., 95  
 Liberty St., New York.  
 Stuart-Howland Co., Boston.  
 Armature Lifts.  
 Electric Service Supplies Co.,  
 200 Plymouth Bldg., Chicago.  
 Asbestos Materials.  
 Johns-Manville, H. W., Co.,  
 New York.  
 Axles—(See Wheels and Axles).  
 Babbitt Metals—(See Alloys and  
 Bearing Metals).  
 Badges and Buttons.  
 Electric Service Supplies Co.,  
 200 Plymouth Bldg., Chicago.  
 Ballast Cars—(See Cars, Bal-  
 last).  
 Ball Bearings.  
 Symington, T. H., Co., Balti-  
 more, Md.  
 Bases—(See Trolley Poles and  
 Fittings).  
 Bearings.  
 Electric Service Supplies Co.,  
 200 Plymouth Bldg., Chicago.  
 General Electric Co., Schene-  
 cady, N. Y.  
 Lumen Bearing Co., Buffalo,  
 N. Y.  
 McGuire-Cummings Mfg. Co.,  
 Chicago.  
 Marshall, R. W., & Co., 95  
 Liberty St., New York.  
 Nuttall, R. D., Co., Pittsburg.  
 Ohio Brass Co., Mansfield, O.  
 Symington, T. H., Co., Balti-  
 more, Md.  
 Van Dorn & Dutton Co.,  
 Cleveland, O.  
 Bells and Gongs.  
 American Car Co., St. Louis.  
 Brill, The J. G., Co., Phila-  
 delphia.  
 Electric Service Supplies Co.,  
 200 Plymouth Bldg., Chicago.  
 Kuhlman, The G. C., Car Co.,  
 Cleveland.  
 McGuire-Cummings Mfg. Co.,  
 Chicago.  
 Ohio Brass Co., Mansfield, O.  
 St. Louis Car Co., St. Louis,  
 Mo.  
 Stephenson, John, Co., Elliza-  
 beth, N. J.  
 Wason Mfg. Co., Springfield,  
 Mass.  
 Western Electric Co., Chicago.  
 Block System—(See Signals).  
 Blowers—(See Mechanical Draft)  
 Blue Printing Machines.  
 Buckeye Engine Co., Salem, O.  
 Boilers.  
 Babcock & Wilcox Co., N. Y.  
 Fairbanks, Morse & Co., Chi-  
 cago.  
 Green Fuel Economizer Co.,  
 Matteawan, N. Y.  
 Heine Safety Boiler Co., 421  
 Olive St., St. Louis.  
 Lord & Burnham, Irvington-  
 on-Hudson, New York.  
 Boiler Cleaning Compounds.  
 Dearborn Drug & Chemical  
 Works, Chicago.  
 Johns-Manville, H. W., Co.,  
 New York.  
 Bonds, Rail.  
 Brown, H. P., 120 Liberty St.,  
 New York.  
 Chase-Shawmut Co., New-  
 buryport, Mass.  
 Electric Railway Improvement  
 Co., Cleveland, O.  
 Electric Service Supplies Co.,  
 200 Plymouth Bldg., Chicago.  
 General Electric Co., Schene-  
 cady, N. Y.  
 Johns-Manville, H. W., Co.,  
 New York.  
 Ohio Brass Co., Mansfield, O.  
 Brackets and Cross Arms.  
 Anderson, Albert & J. M.,  
 Mfg. Co., Boston.  
 Craghead Engineering Co.,  
 Cincinnati, O.  
 Electric Service Supplies Co.,  
 200 Plymouth Bldg., Chicago.  
 Johns-Manville, H. W., Co.,  
 New York, N. Y.  
 Lindsley Bros. Co., Spokane,  
 Wash.  
 Ohio Brass Co., Mansfield, O.  
 Stuart-Howland Co., Boston.  
 Western Electric Co., Chicago.  
 Brakes and Brake Parts—Con-  
 tinued.  
 Brill, The J. G., Co., Phila-  
 delphia.  
 Electric Service Supplies Co.,  
 200 Plymouth Bldg., Chicago.  
 General Electric Co., Schene-  
 cady, N. Y.  
 Kuhlman, The G. C., Car Co.,  
 Cleveland.  
 McGuire-Cummings Mfg. Co.,  
 Chicago.  
 National Brake & Electric Co.,  
 St. Louis, Mo.  
 Stephenson, John, Co., Elliza-  
 beth, N. J.  
 Wason Mfg. Co., Springfield,  
 Mass.  
 Westinghouse Traction Brake  
 Co., Pittsburg, Pa.  
 Brakeshoes.  
 American Brake Shoe & Fdry.  
 Co., Mahwah, N. J.  
 American Car Co., St. Louis.  
 Barbour-Stockwell Co., Cam-  
 bridgeport, Mass.  
 Brill, The J. G., Co., Phila-  
 delphia.  
 Kuhlman, The G. C., Car Co.,  
 Cleveland.  
 McGuire-Cummings Mfg. Co.,  
 Chicago.  
 Marshall, R. W., & Co., 95  
 Liberty St., New York.  
 St. Louis Car Co., St. Louis,  
 Mo.  
 Standard Brake Shoe Co., Au-  
 rora, Ill.  
 Stephenson, John, Co., Elliza-  
 beth, N. J.  
 Wason Mfg. Co., Springfield,  
 Mass.  
 Wharton, Wm., Jr., & Co.,  
 Philadelphia.  
 Wheel Truing Brake Shoe Co.,  
 Detroit.  
 Bridge Timbers.  
 Beider, Francis, & Co., Chgo.  
 Brushes, Motor and Dynamo.  
 Electric Service Supplies Co.,  
 200 Plymouth Bldg., Chicago.  
 General Electric Co., Schene-  
 cady, N. Y.  
 Speer Carbon Co., St. Marys,  
 Pa.

# WESTERN ELECTRIC COMPANY

CHICAGO DENVER SAINT PAUL NEW YORK  
 SAINT LOUIS PITTSBURG CINCINNATI ATLANTA  
 SAN FRANCISCO SEATTLE SALT LAKE CITY LOS ANGELES KANSAS CITY PHILADELPHIA

## W. E. Alternating Current Generators

will give you the highest average or

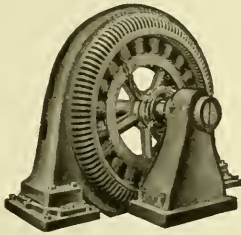

all-day efficiency. We do make prompt deliveries. Write for bulletin No. 5210-C

**TODAY**



## Indestructible Sockets For Park Lighting

J-M MOULDED MICA SOCKETS are of the indestructible sort—the kind that will last practically forever. Cheaper to use than porcelain, because they last longer, are not liable to breakage and there is no danger from short circuits, due to dampness and rain.

**J-M Moulded Mica Sockets** are absolutely weatherproof and possess the highest insulating qualities.

*Approved and listed by the Underwriters' National Electric Association.*

Write nearest Branch for booklet.

## H. W. JOHNS-MANVILLE CO.



NEW YORK MILWAUKEE CHICAGO BOSTON PHILADELPHIA ST. LOUIS PITTSBURG CLEVELAND BUFFALO

BALTIMORE NEW ORLEANS KANSAS CITY MINNEAPOLIS SAN FRANCISCO LOS ANGELES SEATTLE DALLAS

781



## When Overhauling Summer Cars

REMEMBER THIS: The right way to reduce maintenance expense is to buy the best equipment throughout. O. B. Co. Operating Specialties will prove it.



ARMSTRONG JOURNAL OILER

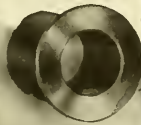

GENUINE BELL METAL BEARINGS

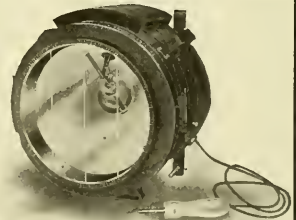

IMPERIAL ARC HEADLIGHT



Tomlinson Automatic Coupler and Spring Drawbar Carrier

See catalogue No. 7, pages 245-306, for O. B. Co. Car Equipment Specialties.



IMPROVED TRAILER CONNECTOR

## The Ohio Brass Company, Mansfield, O., U. S. A.

43-49 Exchange Place, NEW YORK  
 Burt Gellatly, PITTSBURG

10 North Fourth Street, ST. LOUIS  
 Pierson, Roeding & Co., SAN FRANCISCO

321 Dearborn Street, CHICAGO  
 LOS ANGELES, SEATTLE

## CLASSIFIED LIST OF ADVERTISERS—Continued.

- Bumpers, Car.**  
American Car Co., St. Louis.  
Brill, The J. G., Co., Philadelphia.  
Kuhlman, The G. C., Car Co., Cleveland.  
St. Louis Car Co., St. Louis, Mo.  
Stephenson, John, Co., Elizabeth, N. J.  
Wason Mfg. Co., Springfield, Mass.
- Car House Doors.**  
Wilson, J. G., Mfg. Co., New York.
- Car Replacers.**  
Electric Service Supplies Co., 200 Plymouth Bldg., Chicago.  
Fairbanks, Morse & Co., Chgo. Kalamazoo Railway Supply Co., Kalamazoo, Mich.  
Ohio Brass Co., Mansfield, O.  
U. S. Metal & Mfg. Co., 25 Broad St., New York.
- Car Seats.**  
American Car Co., St. Louis.  
Brill, The J. G., Co., Philadelphia.  
Hale & Kilburn Mfg. Co., Philadelphia.  
Heywood Bros. & Wakefield Co., Wakefield, Mass.  
Kuhlman, The G. C., Car Co., Cleveland.  
St. Louis Car Co., St. Louis, Mo.  
Stephenson, John, Co., Elizabeth, N. J.  
Wason Mfg. Co., Springfield, Mass.
- Car Signs—(See Signs, Cars and Track).**
- Car Steps.**  
Electric Service Supplies Co., 200 Plymouth Bldg., Chicago.
- Car Trimmings, Car—(See Trimmings, Car).**
- Cars, Ballast.**  
Rodger Ballast Car Co., Chgo. St. Louis Car Co., St. Louis, Mo.
- Cars, Dump.**  
Fairbanks, Morse & Co., Chgo. Rodger Ballast Car Co., Chgo. Russell Car & Snow-Plow Co., Ridgway, Pa.  
St. Louis Car Co., St. Louis, Mo.
- Cars, Passenger and Freight.**  
American Car Co., St. Louis.  
Brill, The J. G., Co., Philadelphia.  
Cincinnati Car Co., Cincinnati.  
Detroit Carbuilding & Equipment Co., Detroit, Mich.  
Electric Railway Improvement Co., Cleveland, O.  
Fairbanks, Morse & Co., Chgo. Jewett Car Co., Newark, O.  
Kuhlman, The G. C., Car Co., Cleveland.  
McQuire-Cummings Mfg. Co., Chicago.  
Niles Car & Mfg. Co., Niles, O.  
Pressed Steel Car Co., Pittsburg.  
Rodger Ballast Car Co., Chgo. Russell Car & Snow-Plow Co., Ridgway, Pa.  
St. Louis Car Co., St. Louis, Mo.  
Standard Motor Truck Co., Pittsburg.  
Stephenson, John, Co., Elizabeth, N. J.  
Wason Mfg. Co., Springfield, Mass.
- Cars, Pay-As-You-Enter.**  
Pay-As-You-Enter Car Co., 26 Cortlandt St., New York.
- Cars, Rebuilt.**  
Detroit Carbuilding & Equipment Co., Detroit, Mich.
- Cars, Second-Hand.**  
Detroit Carbuilding & Equipment Co., Detroit, Mich.  
Marshall, R. W., & Co., 95 Liberty St., New York.  
Zelnicke, Walter A., Supply Co., St. Louis.
- Cars, Steel.**  
Pressed Steel Car Co., Pittsburg.  
St. Louis Car Co., St. Louis, Mo.  
Standard Motor Truck Co., Pittsburg.
- Castings, Brass.**  
Star Brass Works, Kalamazoo, Mich.
- Castings, Iron and Steel.**  
American Brake Shoe & Foundry Co., Mahwah, N. J.  
Green Engineering Co., Com'l Nat. Bk. Bldg., Chicago.  
National Brake & Electric Co., Milwaukee.  
Standard Steel Works Co., Philadelphia, Pa.  
Washburn Steel Castings & Coupler Co., Minneapolis.
- Catchers—(See Trolley Retrievers and Catchers).**
- Cattle Guards.**  
Fairbanks, Morse & Co., Chgo.
- Circuit-Breakers.**  
Electric Service Supplies Co., 200 Plymouth Bldg., Chicago.  
General Electric Co., Schenectady, N. Y.  
Western Electric Co., Chicago.
- Coal Handling Machinery—(See Conveyors).**
- Coils—(See Armatures and Coils).**
- Commutators and Parts.**  
Electric Service Supplies Co., 1020-24 Filbert St., Phila.  
General Electric Co., Schenectady, N. Y.  
Marshall, R. W., & Co., 95 Liberty St., New York.  
Ohio Brass Co., Mansfield, O.  
Stuart-Howland Co., Boston.
- Compressors, Air.**  
Fairbanks, Morse & Co., Chgo. General Electric Co., Schenectady, N. Y.  
National Brake & Electric Co., Milwaukee.  
Westinghouse Traction Brake Co., Pittsburg.
- Concrete Mixers.**  
Contractors' Supply & Equip. Co., Chicago.
- Condensers.**  
Wheeler Condenser & Engineering Co., Carteret, N. J.
- Conduits.**  
Electric Service Supplies Co., 200 Plymouth Bldg., Chicago.  
Western Electric Co., Chicago.
- Connectors, Solderless.**  
Dossier & Co., 242 W. Forty-first St., New York.
- Contractors.**  
Arnold Company, 131 La Salle St., Chicago.  
Bylesby, H. M., Co., Am. Trust Bldg., Chicago.  
Columbia Construction Co., Milwaukee, Wis.  
Creaghead Engineering Co., Cincinnati, O.  
Green Engineering Co., Com'l Nat. Bk. Bldg., Chicago.  
Register, A. L., & Co., 112 N. Broad St., Philadelphia.  
Sanderson & Porter, 52 William St., New York.  
Saxton, E., 841 Bladensburg R., Washington, D. C.  
Sheaff & Jaastad, 88 Broad St., Boston.  
Stone & Webster Engineering Corporation, Boston.  
Wharton, Wm., Jr., & Co., Philadelphia.  
White, J. G., & Co., 49 Exchange Pl., New York.
- Controllers and Attachments.**  
Electric Service Supplies Co., 200 Plymouth Bldg., Chicago.  
General Electric Co., Schenectady, N. Y.  
Johns-Manville, H. W., Co., New York.  
Marshall, R. W., & Co., 95 Liberty St., New York.  
Western Electric Co., Chicago.  
Westinghouse Electric & Mfg. Co., Pittsburg.
- Conveyors and Coal Handling Machinery.**  
Green Engineering Co., Com'l Nat. Bk. Bldg., Chicago.  
Northern Engineering Works, Detroit, Mich.
- Cord, Bell and Trolley.**  
American Car Co., St. Louis.  
Brill, The J. G., Co., Philadelphia.
- Cord, Bell and Trolley—Continued.**  
Electric Service Supplies Co., 1020-24 Filbert St., Phila.  
Kuhlman, The G. C., Car Co., Cleveland.  
St. Louis Car Co., St. Louis, Mo.  
Stephenson, John, Co., Elizabeth, N. J.  
Stuart-Howland Co., Boston.  
Wason Mfg. Co., Springfield, Mass.
- Couplers, Car.**  
American Car Co., St. Louis.  
Brill, The J. G., Co., Philadelphia.  
Kuhlman, The G. C., Car Co., Cleveland.  
McQuire-Cummings Mfg. Co., Chicago.  
Ohio Brass Co., Mansfield, O.  
St. Louis Car Co., St. Louis, Mo.  
Stephenson, John, Co., Elizabeth, N. J.  
Van Dorn, W. T., Co., Paulina St., Chicago.  
Washburn Steel Castings & Coupler Co., Minneapolis.  
Wason Mfg. Co., Springfield, Mass.
- Coverings, Pipe and Boiler.**  
Johns-Manville, H. W., Co., New York.
- Cranes, Hoists and Lifts.**  
American Car Co., St. Louis.  
Brill, The J. G., Co., Philadelphia.  
Brown Hoisting Machinery Co., Cleveland, O.  
Kuhlman, The G. C., Car Co., Cleveland.  
Northern Engineering Works, Detroit, Mich.  
Railway Specialty & Supply Co., Chicago.  
Stephenson, John, Co., Elizabeth, N. J.  
Van Dorn & Dutton Co., Cleveland, O.  
Wason Mfg. Co., Springfield, Mass.
- Cross Arms—(See Brackets and Cross Arms).**
- Crossing Gates—(See Gates and Guards).**
- Crossings, Track—(See Switches, Frogs and Crossings).**
- Curtains, Fixtures and Materials.**  
American Car Co., St. Louis.  
Brill, The J. G., Co., Philadelphia.  
Curtain Supply Co., 93 Ohio St., Chicago.  
Electric Service Supplies Co., 200 Plymouth Bldg., Chicago.  
Hartshorn, Stewart, Co., East Newark, N. J.  
Kuhlman, The G. C., Car Co., Cleveland.  
Marshall, R. W., & Co., 95 Liberty St., New York.  
National Lock Washer Co., Newark, N. J.  
Pantaso, Co., 11 Broadway, New York.  
St. Louis Car Co., St. Louis, Mo.  
Stephenson, John, Co., Elizabeth, N. J.  
Wason Mfg. Co., Springfield, Mass.
- Cylinder Oil.**  
Power Specialty Co., 111 Broadway, N. Y.
- Derailing Devices.**  
American Frog & Switch Co., Hamilton, O.  
Cleveland Frog & Crossing Co., Cleveland, O.
- Doors and Fixtures.**  
American Car Co., St. Louis.  
Brill, The J. G., Co., Philadelphia.  
Kuhlman, The G. C., Car Co., Cleveland.  
St. Louis Car Co., St. Louis, Mo.  
Stephenson, John, Co., Elizabeth, N. J.  
Wason Mfg. Co., Springfield, Mass.
- Doors, Steel Rolling.**  
Wilson, J. G., Mfg. Co., New York.
- Draft, Mechanical—(See Mechanical Draft).**
- Draft Rigging.**  
Van Dorn, W. T., Co., Chgo. Washburn Steel Castings & Coupler Co., Minneapolis.
- Drills, Track.**  
Brown, H. P., 120 Liberty St., New York.  
Electric Service Supplies Co., 200 Plymouth Bldg., Chicago.  
Fairbanks, Morse & Co., Chgo. Kalamazoo Railway Supply Co., Kalamazoo, Mich.  
Marshall, R. W., & Co., 95 Liberty St., New York.
- Drying Appliances.**  
Green Fuel Economizer Co., Matteawan, N. Y.
- Dynamos and Generators.**  
Fairbanks, Morse & Co., Chgo. General Electric Co., Schenectady, N. Y.  
National Brake & Electric Co., Milwaukee, Wis.  
Western Electric Co., Chicago.  
Westinghouse Electric & Mfg. Co., Pittsburg, Pa.
- Economizers, Fuel.**  
Green Fuel Economizer Co., Matteawan, N. Y.
- Electrical Instruments.**  
Electric Service Supplies Co., 200 Plymouth Bldg., Chicago.  
General Electric Co., Schenectady, N. Y.  
Johns-Manville, H. W., Co., New York.  
Queen & Co., Philadelphia.  
Western Electric Co., Chicago.  
Westinghouse Electric & Mfg. Co., Pittsburg, Pa.  
Weston Electrical Instrument Co., Newark, N. J.
- Electric Railway Supplies, General.**  
Creaghead Engineering Co., Cincinnati, O.  
Electric Service Supplies Co., 200 Plymouth Bldg., Chicago.  
Fairbanks, Morse & Co., Chgo. General Electric Co., Schenectady, N. Y.  
Johns-Manville, H. W., Co., New York.  
Marshall, R. W., & Co., 95 Liberty St., New York.  
Ohio Brass Co., Mansfield, O.  
Stuart-Howland Co., Boston.  
Western Electric Co., Chicago.
- Engine Apparatus.**  
Green Fuel Economizer Co., Matteawan, N. Y.
- Engineers and Contractors.**  
Arnold Company, Chicago.  
Bylesby, H. M., & Co., Chgo. Columbia Construction Co., Milwaukee, Wis.  
Ford, Bacon & Davis, New York.  
Register, A. L., & Co., Philadelphia.  
Sanderson & Porter, New York.  
Saxton, E., Washington, D. C.  
Sheaff & Jaastad, Boston.  
Stone & Webster Engineering Corporation, Boston.  
White, J. G., & Co., New York.
- Engines, Gas and Oil.**  
Buckeye Engine Co., Salem, O.  
Fairbanks, Morse & Co., Chgo. Westinghouse Machine Co., Pittsburg.
- Engines, Hoisting.**  
Fairbanks, Morse & Co., Chgo.
- Engines, Steam.**  
Buckeye Engine Co., Salem, O.  
Westinghouse Machine Co., Pittsburg.
- Fans, Exhaust and Ventilating.**  
General Electric Co., Schenectady, N. Y.  
Green Fuel Economizer Co., Matteawan, N. Y.  
Western Electric Co., Chicago.  
Westinghouse Elec. & Mfg. Co., Pittsburg.
- Fare Boxes—(See Electric Railway Supplies).**
- Fare Registers and Register Fitters.**  
Electric Service Supplies Co., 200 Plymouth Bldg., Chicago.  
Rooke Automatic Register Co., Providence, R. I.

# ST. LOUIS CAR CO. ST. LOUIS-MO.



## St. Louis Car Company's Semi-Convertible Type

The illustration represents one of the cars recently shipped by us to the Houston Electric Company, Houston, Texas.

These cars are of our own design—a practically perfect Semi-Convertible type. Both lower and upper sashes raise into the roof. They move easily and when in the roof pockets are securely fastened, with no possible danger of falling and injuring passengers.

### Our construction of the Semi-Convertible Car is the very best that has yet been devised

These Houston cars are 28' over corner posts and 31' 6" over all. Width over arm rail, 8' 6". They are finished with very handsomely figured mahogany, provided with curtains at each window and each door opening and have the St. Louis Car Company's latest improved "Walkover" seat.

The cars are mounted on St. Louis Car Company's No. 47 Short Wheel Base Truck, which has been adopted as standard in a great many of the larger cities. The channel-iron and steel construction of the "Robertson type" permits the arm rail of the car to be placed very low and adds much to the appearance.

*Photographs, Blue Prints and Specifications will be mailed upon request.*

## CLASSIFIED LIST OF ADVERTISERS—Continued.

- Feedwater Apparatus.**  
Green Fuel Economizer Co.,  
Mattawan, N. Y.  
Wheeler Condenser & Engi-  
neering Co., Carteret, N. J.
- Feed Wire—(See Wire and  
Cables).**
- Fenders and Guards.**  
Consolidated Car Fender Co.,  
Providence, R. I.  
Eclipse Railway Supply Co.,  
Cleveland, O.  
Electric Service Supplies Co.,  
1020-24 Filbert St., Phila.  
McGuire-Cummings Mfg. Co.,  
Chicago  
Marshall, R. W., & Co., 95  
Liberty St., New York.
- Flangers, Snow.**  
Kalamazoo Railway Supply  
Co., Kalamazoo, Mich.  
McGuire-Cummings Mfg. Co.,  
Chicago.  
Ohio Brass Co., Mansfield, O.  
Van Dorn & Dutton Co.,  
Cleveland, O.
- Frogs—(See Switches, Frogs and  
Crossings).**
- Fuel Economizers—(See Econo-  
mizers, Fuel).**
- Fuses and Fuse Devices.**  
Chase-Shawmut Co., New-  
buryport, Mass.  
Electric Service Supplies Co.,  
200 Plymouth Bldg., Chicago.  
General Electric Co., Schene-  
ctady, N. Y.  
Johns-Manville, H. W., Co.,  
New York.  
Western Electric Co., Chicago.  
Westinghouse Elec. & Manu-  
facturing Co., Pittsburg.
- Gaskets, Bronze.**  
Power Specialty Co., 111  
Broadway, New York.
- Gates and Guards.**  
Kalamazoo Railway Supply  
Co., Kalamazoo, Mich.
- Gear Cases.**  
Electric Service Supplies Co.,  
200 Plymouth Bldg., Chicago.  
General Electric Co., Schene-  
ctady, N. Y.  
Marshall, R. W., & Co., 95  
Liberty St., New York.
- Gears and Pinions.**  
Electric Service Supplies Co.,  
200 Plymouth Bldg., Chicago.  
General Electric Co., Schene-  
ctady, N. Y.  
Marshall, R. W., & Co., 95  
Liberty St., New York.  
Nuttall, R. D., Co., Pittsburg.  
Van Dorn & Dutton Co.,  
Cleveland, O.
- Generators—(See Dynamos).**
- Gongs—(See Bells and Gongs).**
- Graphite Paint—(See Paint).**
- Grates, Chain.**  
Green Engineering Co., Com'l  
Nat. Bk. Bldg., Chicago.
- Grease—(See Lubricants).**
- Grinders.**  
Brown, Harold P., 120 Liberty  
St., New York.
- Ground Connection Clamps.**  
Chase-Shawmut Co., New-  
buryport, Mass.
- Guy Anchors—(See Anchors).**
- Hangs, Trolley—(See Trolley  
Poles and Fittings).**
- Headlights.**  
Electric Service Supplies Co.,  
200 Plymouth Bldg., Chicago.  
Fairbanks, Morse & Co., Chgo.  
General Electric Co., Schene-  
ctady, N. Y.  
St. Louis Car Co., St. Louis,  
Mo.  
Stuart-Howland Co., Boston.  
Trolley Supply Co., Canton, O.
- Heaters, Car, Electric.**  
Consolidated Car-Heating Co.,  
Albany, N. Y.  
Johns-Manville, H. W., Co.,  
New York.
- Heaters, Car, Hot Water, and  
Stoves.**  
Baker, The Wm. C., Heating  
& Sup. Co., New York.  
McGuire-Cummings Mfg. Co.,  
Chicago.  
Smith, Peter, Heater Co., Det-  
roit, Mich.
- Heating and Ventilating Appa-  
ratus—(See Mech. Draft).**
- Holsts—(See Cranes, Holsts and  
Lifts).**
- Hose Bridges.**  
Ohio Brass Co., Mansfield, O.
- Hydraulic Machinery.**  
Watson-Stillman Co., 26 Cort-  
landt St., New York.
- Inspection.**  
Central Inspection Bureau.  
Inspection Cars, Gasoline.  
Stover Motor Car Co., Free-  
port, Ill.
- Instruments, Measuring and  
Testing—(See Electrical In-  
struments).**
- Insulating Tapes.**  
General Electric Co., Schene-  
ctady, N. Y.  
Johns-Manville, H. W., Co.,  
New York, N. Y.  
Okonite Co. Ltd., 253 Broad-  
way, New York.  
Western Electric Co., Chicago.
- Insulations and Insulating Ma-  
terial.**  
Anderson, A. & J. M., Mfg.  
Co., Boston.  
Creaghead Engineering Co.,  
Cincinnati, O.  
Electric Railway Equipment  
Co., Cincinnati, O.  
Electric Service Supplies Co.,  
200 Plymouth Bldg., Chicago.  
General Electric Co., Schene-  
ctady, N. Y.  
Johns-Manville, H. W., Co.,  
New York.  
Macallen, The, Co., Boston.  
Ohio Brass Co., Mansfield, O.  
Okonite Co., Ltd., 253 Broad-  
way, New York.  
Standard Paint Co., 100 Will-  
iam St., New York.  
Stuart-Howland Co., Boston.  
Western Electric Co., Chicago.
- Jacks.**  
American Car Co., St. Louis.  
Brill, The J. G. Co., Phila-  
delphia.  
Electric Service Supplies Co.,  
200 Plymouth Bldg., Chicago.  
Fairbanks, Morse & Co., Chgo.  
Kalamazoo Railway Supply  
Co., Kalamazoo, Mich.  
Kuhlman, The G. C., Car Co.,  
Cleveland.  
Marshall, R. W., & Co., 95  
Liberty St., New York.  
Morden, Frog & Crossing Co.,  
Chicago.  
Stephenson, John, Co., Ellza-  
beth, N. J.  
Wason Mfg. Co., Springfield,  
Mass.  
Watson-Stillman Co., 26 Cort-  
landt St., New York.
- Joists, Expansion—(See Steam  
Fittings).**
- Joists, Rail.**  
Rail Joint Co., 29 W. 34th St.,  
New York.
- Joists, Welded—(See Rail Joists,  
Welded).**
- Journal Boxes.**  
American Car Co., St. Louis.  
Brill, The J. G. Co., Phila-  
delphia.  
Kuhlman, The G. C., Car Co.,  
Cleveland.  
McGuire-Cummings Mfg. Co.,  
Chicago.  
St. Louis Car Co., St. Louis,  
Mo.  
Stephenson, John, Co., Ellza-  
beth, N. J.  
Symington, T. H. Co., Balti-  
more, Md.  
Wason Mfg. Co., Springfield,  
Mass.
- Journal Lubricators—(See Lu-  
bricants).**
- Journal Packing, Steel Wool.**  
Robertson, Wm., & Co., Fifth  
Floor Great Northern Bldg.,  
Chicago.
- Lamps, Arc and Incandescent.**  
Anderson, A. & J. M., Mfg.  
Co., Boston.  
Electric Service Supplies Co.,  
200 Plymouth Bldg., Chicago.  
General Electric Co., Schene-  
ctady, N. Y.  
Stuart-Howland Co., Boston.  
Western Electric Co., Chicago.  
Westinghouse Electric & Mfg.  
Co., Pittsburg, Pa.
- Lamp Sockets.**  
Electric Service Supplies Co.,  
200 Plymouth Bldg., Chicago.  
General Electric Co., Schene-  
ctady, N. Y.  
Johns-Manville, H. W., Co.,  
New York, N. Y.
- Lantern Globes.**  
Railway Specialty & Supply  
Co., Chicago.
- Lifts—(See Cranes, Hoist and  
Lift).**
- Lightning Arresters.**  
Electric Service Supplies Co.,  
200 Plymouth Bldg., Chicago.  
General Electric Co., Schene-  
ctady, N. Y.  
Stuart-Howland Co., Boston.  
Western Electric Co., Chicago.  
Westinghouse Elec. & Manu-  
facturing Co., Pittsburg.
- Line Material.**  
Anderson, A. & J. M., Mfg.  
Co., Boston.  
Creaghead Engineering Co.,  
Cincinnati, O.  
Johns-Manville, H. W., Co.,  
New York.  
Electric Ry. Equipment Co.,  
Cincinnati, O.  
Electric Service Supplies Co.,  
200 Plymouth Bldg., Chicago.  
General Electric Co., Schene-  
ctady, N. Y.  
Macallen, The, Co., Boston.  
Marshall, R. W., & Co., 95  
Liberty St., New York.  
Stuart-Howland Co., Boston.  
Western Electric Co., Chicago.
- Lock and Nut Washers.**  
National Lock Washer Co.,  
Newark, N. J.
- Locks, Metal.**  
Electric Service Supplies Co.,  
200 Plymouth Bldg., Chicago.
- Locomotives.**  
Baldwin Locomotive Works,  
Philadelphia.  
Locomotives, Electric.  
American Car Co., St. Louis.  
Baldwin Locomotive Works,  
Philadelphia.  
Brill, The J. G. Co., Phila-  
delphia.  
General Electric Co., Schene-  
ctady, N. Y.  
Kuhlman, The G. C., Car Co.,  
Cleveland.  
McGuire-Cummings Mfg. Co.,  
Chicago.  
Stephenson, John, Co., Ellza-  
beth, N. J.  
Wason Mfg. Co., Springfield,  
Mass.  
Westinghouse Elec. & Manu-  
facturing Co., Pittsburg.
- Locomotives, Gasoline.**  
Fairbanks, Morse & Co., Chgo.  
Stover Motor Car Co., Free-  
port, Ill.
- Lubricants.**  
Dearborn Drug & Chemical  
Works, Chicago.  
Galena-Signal Oil Co., Frank-  
lin, Pa.  
Whitmore Mfg. Co., Clevel-  
and, O.
- Lumber.**  
Advance Lumber Co., Clevel-  
and, O.  
Barnes, G. H., Hardwood  
Lumber Co., St. Louis, Mo.  
Beldier, Francis, & Co., Chgo.  
Berthold & Jennings, St.  
Louis.  
Lindsay Bros. Co., Spokane,  
Wash.  
S-E. Missouri Cypress Co.,  
Campbell, Mo.
- Malleable Iron.**  
St. Louis Car Co., St. Louis,  
Mo.
- Measuring Tapes.**  
Lufkin Rule Co., Saginaw,  
Mich.
- Mechanical Draft.**  
Green Fuel Economizer Co.,  
Mattawan, N. Y.
- Meters.**  
Johns-Manville, H. W., Co.,  
New York.  
Queen & Co., Philadelphia.  
Western Electrical Instrument  
Co., Newark, N. J.
- Mica, Raw and Manufactured.**  
Chicago Mica Co., Valparaiso,  
Ind.
- Motor Cars, Gasoline.**  
Stover Motor Car Co., Free-  
port, Ill.
- Motors, Electric.**  
Fairbanks, Morse & Co., Chgo.  
General Electric Co., Schene-  
ctady, N. Y.  
National Brake & Electric Co.,  
Milwaukee.  
Western Electric Co., Chicago.  
Westinghouse Elec. & Manu-  
facturing Co., Pittsburg.
- Nut Locks.**  
Chase-Shawmut Co., New-  
buryport, Mass.  
National Lock Washer Co.,  
Newark, N. J.  
Railway Specialty & Supply  
Co., Chicago.  
St. Louis Car Co., St. Louis,  
Mo.  
U. S. Metal & Mfg. Co., 25  
Broad St., New York.
- Nuts and Bolts.**  
National Lock Washer Co.,  
Newark, N. J.  
Railway Specialty & Supply  
Co., Chicago.
- Oilers.**  
Armstrong Oiler Co., 31st and  
Chestnut St., Philadelphia.
- Oils—(See Lubricants).**
- Overhead Equipment—(See Elec-  
trical Railway Supplies).**
- Packings.**  
Electric Service Supplies Co.,  
200 Plymouth Bldg., Chicago.  
Johns-Manville, H. W., Co.,  
New York.  
Power Specialty Co., 111  
Broadway, New York.
- Packing, Steel Wool Journal.**  
Robertson, Wm., & Co., Fifth  
Floor Great Northern Bldg.,  
Chicago.
- Paints.**  
Standard Paint Co., 100 Will-  
iam St., New York.
- Pay-As-You-Enter Cars.**  
Pay-As-You-Enter Car Co., 26  
Cortlandt St., New York.
- Pipe Bends and Fittings—(See  
Steam Fittings).**
- Poles, Metal.**  
Creaghead Engineering Co.,  
Cincinnati, O.  
Electric Railway Equipment  
Co., Cincinnati, O.  
Electric Service Supplies Co.,  
200 Plymouth Bldg., Chicago.
- Poles and Ties, Wood.**  
Advance Lumber Co., Clevel-  
and, O.  
Barnes, G. H., Hardwood  
Lumber Co., St. Louis, Mo.  
Beldier, Francis, & Co., Chgo.  
Berthold & Jennings, St. Louis.  
Churchill Cedar Co., Spokane,  
Wash.  
Humbird Lumber Co., Sand  
Point, Idaho.  
Lindsay Bros. Co., Spokane,  
Wash.  
National Pole Co., Escanaba,  
Mich.  
Naugle Pole & Tie Co., 226  
La Salle St., Chicago.  
Pacific Coast Pole Co., Spoka-  
ne, Wash.  
S-E. Missouri Cypress Co.,  
Campbell, Mo.  
Worcester, C. H., Co., Tribune  
Bldg., Chicago.
- Promoters of Railway Projects.**  
Shlmer & Chase Co., Omaha,  
Nebr.
- Punches—(See Ticket Punches).**
- Rail Benders.**  
Electric Service Supplies Co.,  
200 Plymouth Bldg., Chicago.  
Fairbanks, Morse & Co., Chgo.



## Continued Successful Operation of

# Pay-As-You-Enter Cars

in America's largest centers of population has demonstrated that it is far better and more satisfactory

- to run more cars during rush hours
- to furnish a seat to practically every passenger
- and to get a fare from every passenger before entering the car

than to follow the old plan of running a smaller number of crowded cars, filled with dissatisfied passengers, a large percentage of whom have escaped the payment of fares.

Add to these advantages the greatly increased safety of operation (because of the constant presence of the conductor on the rear platform) and the increased speed (because of the improved method of loading and unloading passengers) and you have the principal reasons why the



## Pay-As-You-Enter Car

is the greatest fare-collection improvement in the history of street railways.

We license manufacturers and railways to build and use the Pay-As-You-Enter Car, the patents on which are owned by

## The Pay-As-You-Enter Car Company

DUNCAN McDONALD,  
President

26 Cortlandt Street, New York

THOS. W. CASEY,  
Manager

## CLASSIFIED LIST OF ADVERTISERS—Continued.

- Rail Bonds—(See Bonds, Rail).
- Rail Bonds, Flexible.  
Chase-Shawmut Co., Newburyport, Mass.
- Rail Drills—(See Drills, Track).
- Rail Feed Wire—(See Wire and Cables).
- Rail Joints and Chairs—(See Joints, Rail).
- Rails, New.  
New York Switch & Crossing Co., Hoboken, N. J.  
Wharton, Wm., Jr., & Co., Philadelphia.
- Rails, Relaying.  
Zelnicke, Walter A., Supply Co., St. Louis.
- Railway Velocipedes.  
Fairbanks Morse & Co., Chgo.  
Kalamazoo Railway Supply Co., Kalamazoo, Mich.
- Registers and Fittings—(See Fare Registers).
- Relays.  
Weston Electrical Instrument Co., Newark, N. J.
- Roofing.  
Johns-Manville, H. W., Co., New York.
- Sand Apparatus.  
American Car Co., St. Louis.  
Brill, The J. G., Co., Philadelphia.  
Electric Service Supplies Co., 200 Plymouth Bldg., Chicago.  
Kuhlman, The G. C., Car Co., Cleveland.  
Marshall, R. W., & Co., 95 Liberty St., New York.  
Ohio Brass Co., Mansfield, O.  
St. Louis Car Co., St. Louis, Mo.  
Stephenson, John, Co., Elizabeth, N. J.  
Wason Mfg. Co., Springfield, Mass.
- Sash Balances and Fixtures.  
National Lock Washer Co., Newark, N. J.
- Sash Operating Devices.  
Drouvé, The G. Co., Bridgeport, Conn.  
Lord & Burnham, Irvington-on-Hudson, New York.
- Seats, Car—(See Car Seats).
- Shade Rollers—(See Curtains, Fixtures and Materials).
- Signals.  
Telegraph Signal Co., Rochester, N. Y.
- Signal Supplies.  
Railway Specialty & Supply Co., Chicago.
- Skylights.  
Drouvé, The G. Co., Bridgeport, Conn.  
Lord & Burnham, Irvington-on-Hudson, New York.
- Snow Plows, Sweepers and Scrapers.  
American Car Co., St. Louis.  
Brill, The J. G., Co., Philadelphia.  
Kalamazoo Railway Supply Co., Kalamazoo, Mich.  
Kuhlman, The G. C., Car Co., Cleveland.  
McGuire-Cummings Mfg. Co., Chicago.  
Russell Car & Snow-Plow Co., Ridgway, Pa.  
Stephenson, John, Co., Elizabeth, N. J.  
Wason Mfg. Co., Springfield, Mass.
- Sockets, Waterproof.  
Johns-Manville, H. W., Co., New York.
- Solder Paste.  
Chase-Shawmut Co., Newburyport, Mass.
- Springs.  
American Car Co., St. Louis.  
Brill, The J. G., Co., Philadelphia.  
Kuhlman, The G. C., Car Co., Cleveland.  
McGuire-Cummings Mfg. Co., Chicago.
- Spring—Continued.  
Marshall, R. W., & Co., 95 Liberty St., New York.  
Railway Steel Spring Co., 71 Broadway, New York.  
St. Louis Car Co., St. Louis, Mo.  
Standard Steel Works Co., Philadelphia, Pa.  
Stephenson, John, Co., Elizabeth, N. J.  
Wason Mfg. Co., Springfield, Mass.
- Sprinkling Cars.  
American Car Co., St. Louis.  
Brill, The J. G., Co., Philadelphia.  
Kuhlman, The G. C., Car Co., Cleveland.  
McGuire-Cummings Mfg. Co., Chicago.  
Stephenson, John, Co., Elizabeth, N. J.  
Wason Mfg. Co., Springfield, Mass.
- Stage Pockets and Plugs.  
Chase-Shawmut Co., Newburyport, Mass.
- Steam Apparatus.  
Green Fuel Economizer Co., Mattawan, N. Y.
- Steam Fittings, Etc.  
Crane Co., Chicago.  
Davis, The John, Co., Chgo.  
Simmons, John, Co., 110 Centre St., New York.  
Powe Specialty Co., 111 Broadway, New York.
- Steel Cars.  
American Car Co., St. Louis.  
Brill, The J. G., Co., Philadelphia.  
Kuhlman, The G. C., Car Co., Cleveland.  
St. Louis Car Co., St. Louis, Mo.  
Stephenson, John, Co., Elizabeth, N. J.  
Wason Mfg. Co., Springfield, Mass.
- Steel Tapes.  
Lufkin Rule Co., Saginaw, Mich.
- Stokers.  
Babcock & Wilcox Co., 85 Liberty St., New York.  
Green Engineering Co., Com'l Nat. Bk. Bldg., Chicago.  
Model Stoker Co., Dayton, O.  
Under-Feed Stoker Company of America, Chicago.  
Westinghouse Machine Co., Pittsburg.
- Storage Batteries—(See Batteries).
- Superheaters.  
Powe Specialty Co., 111 Broadway, New York.
- Switches, Frogs and Crossings.  
American Frog & Switch Co., Hamilton, O.  
Barbour-Stockwell Co., Cambridgeport, Mass.  
Cleveland Frog & Crossing Co., Cleveland, O.  
Fairbanks Morse & Co., Chgo.  
Morden Frog & Crossing Co., Rookery, Chicago.  
New York Switch & Crossing Co., Newark, N. J.  
Railway Specialty & Supply Co., Chicago.  
Wharton, Wm., Jr., & Co., Philadelphia.
- Switchboards and Switchboard Instruments.  
Anderson, A. & J. M., Mfg. Co., Boston.  
Chase-Shawmut Co., Newburyport, Mass.  
General Electric Co., Schenectady, N. Y.  
Western Electric Co., Chicago.  
Westinghouse Electric & Mfg. Co., Pittsburg.  
Weston Electrical Instrument Co., Newark, N. J.
- Tapes and Webbing.  
Hope Webbing Co., Providence, R. I.  
Johns-Manville, H. W., Co., New York.  
Okonite Co., Ltd., 253 Broadway, New York.
- Testing Instruments.  
Queen & Co., Philadelphia.  
Weston Electrical Instrument Co., Newark, N. J.
- Test Lamps, Pocket.  
Chase-Shawmut Co., Newburyport, Mass.
- Ticket Choppers and Destroyers.  
Patten, Paul B., Salem, Mass.
- Ticket Punches.  
Meyers, Fred J., Mfg. Co., Hamilton, O.  
Woodman Mfg. & Sup. Co., Boston.
- Ties and Poles, Wood—(See Poles and Ties).
- Timber.  
Beidler, Francis, & Co., Chgo.  
Lindsay Bros. Co., Spokane, Wash.  
S-E Missouri Cypress Co., Campbell, Mo.
- Tools, Pneumatic—(See Pneumatic Tools).
- Track Cleaners and Scrapers.  
American Car Co., St. Louis.  
Brill, The J. G., Co., Philadelphia.  
Kalamazoo Railway Supply Co., Kalamazoo, Mich.  
Kuhlman, The G. C., Car Co., Cleveland.  
McGuire-Cummings Mfg. Co., Chicago.  
Marshall, R. W., & Co., 95 Liberty St., New York.  
Ohio Brass Co., Mansfield, O.  
Stephenson, John, Co., Elizabeth, N. J.  
Van Dorn & Dutton Co., Cleveland, O.  
Wason Mfg. Co., Springfield, Mass.
- Track Drills—(See Drills, Track).
- Tracklaying Machinery.  
Holman, D. F., Ry. Tracklayer Co., 102 E. Ellsworth Bldg., Chicago.
- Track Tools.  
Electric Service Supplies Co., 200 Plymouth Bldg., Chicago.  
Kalamazoo Railway Supply Co., Kalamazoo, Mich.
- Trimmings, Car.  
American Car Co., St. Louis.  
Brill, The J. G., Co., Philadelphia.  
Curtain Supply Co., Park Row Bldg., New York.  
Kuhlman, The G. C., Car Co., Cleveland.  
National Lock Washer Co., Newark, N. J.  
St. Louis Car Co., St. Louis, Mo.  
Stephenson, John, Co., Elizabeth, N. J.  
Wason Mfg. Co., Springfield, Mass.
- Trolley Guards.  
Automatic Trolley Guard Co., 391 Ellicott St., Buffalo, N. Y.  
Electric Service Supplies Co., 200 Plymouth Bldg., Chicago.
- Trolley Poles and Fittings.  
Garford Company, Elyria, O.  
General Electric Co., Schenectady, N. Y.  
Johns-Manville, H. W., Co., New York.  
Marshall, R. W., & Co., 95 Liberty St., New York.  
Miloy Electric Co., Bucyrus, O.  
Nuttall, R. D., Co., Pittsburg.  
Star Brass Works, Kalamazoo, Mich.  
Trolley Supply Co., Canton, O.  
Westinghouse Electric & Mfg. Co., Pittsburg, Pa.
- Trolley Retrievers and Catchers.  
Electric Service Supplies Co., 1020-24 Filbert St., Phila.  
Miloy Electric Co., Bucyrus, O.  
Trolley Supply Co., Canton, O.
- Trolley Wagons.  
Kalamazoo Railway Supply Co., Kalamazoo, Mich.
- Trolley Wheels—(See Trolley Poles and Fittings).
- Trolley Wire—(See Wire and Cables).
- Trucks, Car—Continued.  
Brill, The J. G., Co., Philadelphia.  
Kuhlman, The G. C., Car Co., Cleveland.  
McGuire-Cummings Mfg. Co., Chicago.  
St. Louis Car Co., St. Louis, Mo.  
Standard Motor Truck Co., Pittsburg, Pa.  
Stephenson, John, Co., Elizabeth, N. J.  
Van Dorn & Dutton Co., Cleveland, O.  
Wason Mfg. Co., Springfield, Mass.
- Turbines.  
General Electric Co., Schenectady, N. Y.  
Westinghouse Machine Co., Pittsburg, Pa.
- Valves—(See Steam Fittings).
- Varnish.  
Electric Service Supplies Co., 200 Plymouth Bldg., Chicago.  
Standard Paint Co., 100 William St., New York.
- Ventilators.  
Drouvé, The G. Co., Bridgeport, Conn.  
Lord & Burnham, Irvington-on-Hudson, New York.
- Vestibules.  
Bellamy Vestibule Mfg. Co., Cleveland, O.
- Waste, Cotton and Wool.  
Hagy, J. Milton, Waste Wks., Philadelphia, Pa.  
Railway Specialty & Supply Co., Chicago.
- Water Softening Compounds.  
Dearborn Drug & Chemical Works, Chicago.
- Wheels and Axles.  
American Car Co., St. Louis.  
Brill, The J. G., Co., Philadelphia.  
Griffin Wheel Co., Chicago.  
Kuhlman, The G. C., Car Co., Cleveland.  
McGuire-Cummings Mfg. Co., Chicago.  
Marshall, R. W., & Co., 95 Liberty St., New York.  
Railway Steel-Spring Co., New York.  
St. Louis Car Co., St. Louis, Mo.  
St. Louis Car Wheel Co., St. Louis, Mo.  
Standard Steel Works Co., Philadelphia, Pa.  
Stephenson, John, Co., Elizabeth, N. J.  
Wason Mfg. Co., Springfield, Mass.
- Wheel Grinders.  
Wheel Truing Brake Shoe Co., Detroit, Mich.
- Window Fixtures.  
Drouvé, The G. Co., Bridgeport, Conn.
- Wiping Rags.  
Hagy, J. Milton, Waste Wks., Philadelphia, Pa.
- Wire, Aluminum.  
Aluminum Co. of America, Pittsburg, Pa.
- Wire, Insulated.  
Aluminum Co. of America, Pittsburg, Pa.  
American Electrical Works, Providence, R. I.  
General Electric Co., Schenectady, N. Y.  
Okonite Co., Ltd., 253 Broadway, New York.  
Standard Underground Cable Co., Pittsburg, Pa.  
Stuart-Howland Co., Boston.
- Wire and Cables.  
Aluminum Co. of America, Pittsburg, Pa.  
American Electrical Works, Providence, R. I.  
Bridgeport Brass Co., Bridgeport, Conn.  
General Electric Co., Schenectady, N. Y.  
Okonite Co., Ltd., 253 Broadway, New York.  
Standard Underground Cable Co., Pittsburg, Pa.

## STANDARD HIGH-SPEED "INTERBOROUGH" DOUBLE TRUCK

TYPE C-60

"Solid Forged"

WITHOUT WELDS

FRAMES ARE MADE FROM ROLLED OPEN-HEARTH STEEL WITHOUT WELDS. ALL WEARING BOLTS ARE TURNED AND CASE HARDENED, AND WEARING HOLES STEEL THIMBLED. M. C. B. STANDARD PRINCIPLES ARE FOLLOWED. WE ARE PREPARED TO BUILD TRUCKS IN ACCORDANCE WITH PURCHASER'S DESIGNS AND SPECIFICATIONS.

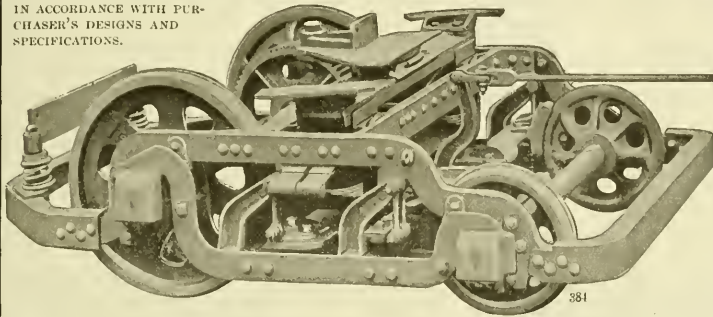
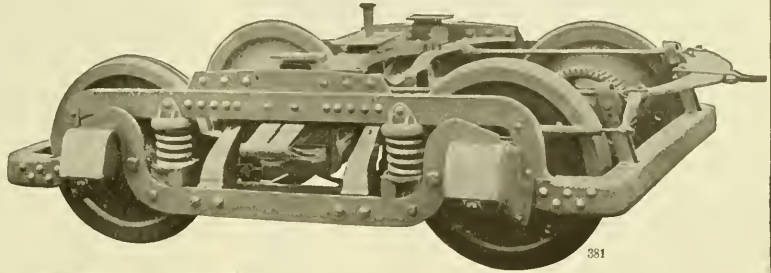

## STANDARD "MAXIMUM TRACTION" DOUBLE TRUCK

CITY AND SUBURBAN  
TYPE O-45

OVER TWO HUNDRED OF THESE "MAXIMUM TRACTION" TRUCKS ARE IN SERVICE IN BROOKLYN, NEW YORK, AND ARE PRONOUNCED "HIGHLY SATISFACTORY."

STANDARD MOTOR TRUCK COMPANY, FRICK BUILDING, PITTSBURGH, PENNSYLVANIA  
NEW YORK OFFICE: 170 BROADWAY WORKS: NEW CASTLE, PA. CHICAGO OFFICE: FISHER BUILDING

For CABLE, ELECTRIC and ELEVATED CARS

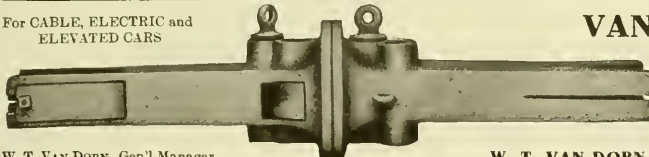

W. T. VAN DORN, Gen'l Manager.

No. 5

## VAN DORN AUTOMATIC COUPLERS

The records go farther than talk. Look up the records. Send for booklet of information on Couplings.

W. T. VAN DORN COMPANY, 1076 S. Paulina Street, CHICAGO

## TROLLEY WIRE, BARE COPPER CABLES WEATHERPROOF WIRE AND CABLES

RUBBER COVERED CABLES AND LEAD COVERED UNDERGROUND CABLES FOR ANY SERVICE. WRITE US FOR SPECIAL PRICES AT THIS TIME STANDARD UNDERGROUND CABLE CO. Pittsburg New York Boston St. Louis San Francisco Chicago Philadelphia Los Angeles Atlanta

## The Green Fuel Economizer Co. MATTEAWAN, N. Y.

New York, Boston, Chicago, Atlanta, San Francisco, Los Angeles, Seattle, Salt Lake City, Montreal.

Engineers: Builders of Green's Fuel Economizers, Fans, Blowers and Exhaustors, Steam Air Heater Coils, Waste Heat Air Heaters, Mechanical Draft, Heating and Ventilating and Drying Apparatus, Draft Dampers and Engines.

WRITE FOR CATALOGS.

Waste for Electric Railway Service

## Motor Packing Waste

Free from dirt and grit. Easy to pack. All long strands. Good absorber. One packing of the journal box will last longer than with the ordinary waste.

WIPING WASTE

White and colored sanitary cleaned wiping rags.

Samples submitted.

The J. Milton Hagy Waste Works

433 Spruce St.

INCORPORATED

Philadelphia

## ALUMINUM

Railway Feeders

And all kinds of Electrical Conductors

Aluminum Feeders are less than one-half the weight of copper feeders and are of equal conductivity and strength. If insulated wire or cable is required, high grade insulation is guaranteed.

Write for prices and full information.

Aluminum Company of America

PITTSBURGH, PA.

Formerly The Pittsburgh Reduction Company

# TUBULAR POLES

## IRON OR STEEL



FOR

**ELECTRIC RAILWAYS**

**ELECTRIC LIGHTING CO'S**

**SIGNAL** } **SER**  
**TELEPHONE** } **VICE**  
**TELEGRAPH** }

**TRANSMISSION LINE**

**AND**

**CATENARY SUSPENSION LINE**

**ELECTRIC RAILWAY EQUIPMENT CO.**  
*General Office: CINCINNATI-O-U-S-A*  
*Shops: READING PA - WHEELING WVA*

# Anti-Pluvius Skylights

are best for all electric railway buildings requiring an abundance of light, because they let in all the light and keep out all the rain and dust.

They are easily erected, because of their simple unit form of construction.

The bridge feature permits skylight being cleaned or repaired.

Strong and durable, too, with glass breakage reduced to a minimum through the use of felt as a cushion rest.

Write today for all the facts about **Anti-Pluvius Skylights**—made only by

## THE G. DROUVÉ CO.

Bridgeport, Conn., U. S. A.  
 Western Office: 40 Dearborn Street, Chicago

# THE BABCOCK & WILCOX COMPANY

85 Liberty Street, New York

Babcock & Wilcox — Stirling — A & T Horizontal — Cahall Vertical

## WATER TUBE STEAM BOILERS

STEAM SUPERHEATERS

Works: Bayonne, N. J. Barberton, Ohio.

BRANCH OFFICES:

BOSTON, Delta Bldg.  
 PHILADELPHIA, 1110-1112 North American Bldg.  
 SAN FRANCISCO, 63 First Street  
 PITTSBURGH, Farmers Deposit Nat. Bank Bldg.  
 NEW ORLEANS, 343 Baronne St.

DENVER, 410 Seventeenth St.  
 SALT LAKE CITY, 315 Atlas Block  
 WASHINGTON, Colorado Building  
 CHICAGO, Marquette Bldg.  
 ATLANTA, GA., 1132 Candler Bldg.

MECHANICAL STOKERS

CLEVELAND, 706 New England Bldg.  
 MEXICO CITY, 7 Avenida, Juarez  
 HAYANA, CUBA, 116½ Calle de la Habana  
 LOS ANGELES, 321 Trust Bldg.  
 CINCINNATI, O., Traction Bldg.

**Avoid Accidents**

By Using This Switch

SPECIAL TRACK WORK OF EVERY DESCRIPTION

**New York Switch & Crossing Co.**

HOBOKEN, N. J.



## Anti-Straddling or Anti-Kicking Tongue Switch

It will not drive down at the heel, because it is held to either side with a spring tension and firmly down on its bed. A car can not straddle this tongue.

WRITE FOR SPECIAL CIRCULAR

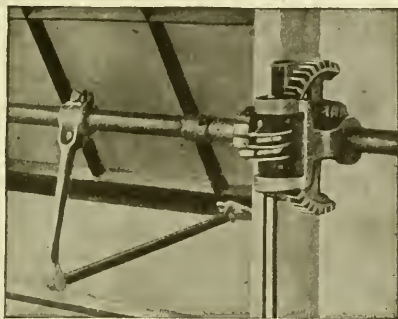

### The Ventilation

of your Shops, Foundries and Car Barns is made especially effective by a speedy, positive and easily manipulated **Sash Operating Apparatus** which automatically locks the sash at any position.

*Let us send you our catalogue.*

**Lord & Burnham Company**  
Irvington-on-Hudson, N. Y.

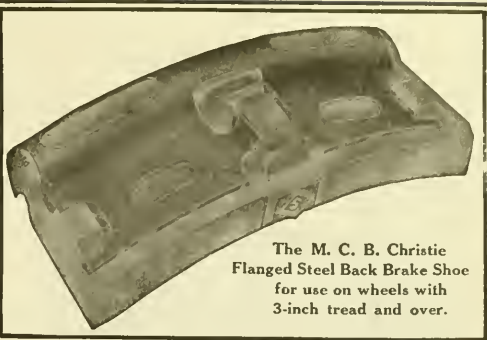

The M. C. B. Christie Flanged Steel Back Brake Shoe for use on wheels with 3-inch tread and over.

# Modern Brake Shoe Practice

What does this mean?

Standardizing your brake heads so that all of them take M. C. B. Christie shoes. Then any shoe fits any head, and shoes are both interchangeable and reversible.

It means one brake shoe pattern instead of many.

It means buying, handling and scrapping much less brake shoe material. In fact, enough less to pay for standardizing the brake heads—the only change necessary.

If you'd like to stop wasting brake shoe money, ask our nearest office to show you how it can be done.

## American Brake Shoe & Foundry Company

Mahwah, N. J.

170 Broadway  
New York

Western Union Bldg.  
Chicago

## Queen Testing Sets

"The Recognized Standard"

- Voltmeters
- Ammeters
- Switchboard and Portable
- Alternating and Direct Current



Queen Acme Testing Set

- U. S. Standard Testing Sets
- Rail Bond Testers
- Galvanometers, etc., etc.
- Electrical Instruments for All Purposes

**QUEEN & CO., Inc., Philadelphia, Pa.**

## WESTON Standard Portable Direct-Reading



- Voltmeters
- Millivoltmeters
- Voltammeters
- Ammeters
- Milliammeters
- Ohmmeters
- Ground Detectors and Circuit Testers

Our **STATION VOLTMETERS** and **AMMETERS** are unsurpassed in point of extreme accuracy and lowest consumption of energy.

### WESTON ELECTRICAL INSTRUMENT CO.

Main Office and Works: Waverly Park, Newark, N. J.

London Branch: Andrey House, Ely Place, Holborn. Paris, France: E. H. Cadot, 12 Rue St. Georges. New York Office: 74 Cortlandt St. Berlin: European Weston Electrical Instrument Co., Ritterstrasse, No. 88.

WRITE TO **MODEL STOKER COMPANY** DAYTON OHIO  
for detailed information about the best  
**AUTOMATIC SMOKELESS FURNACE**

## RE-ENFORCED SPOKE WHEELS

For City and Suburban Cars  
**ST. LOUIS CAR WHEEL CO., St. Louis, Mo.**

**THE ARNOLD COMPANY**  
 ENGINEERS-CONSTRUCTORS  
 ELECTRICAL - CIVIL - MECHANICAL  
 181 LA SALLE STREET  
 CHICAGO

**H. M. Bylesby & Company**  
 Incorporated  
 ENGINEERS  
 American Trust Bldg., Chicago

Design, Construct and Operate  
 Railway, Light, Power and  
 Hydraulic Plants

EXAMINATIONS AND  
 REPORTS

**J. G. WHITE & COMPANY**  
 INCORPORATED

**Engineers, Contractors**

43-49 Exchange Place,  
 41-43 Wall Street

**New York, N. Y.**

Principal Philippine Office: Manila, P. I.

**Complete Plants for the Rapid  
 Handling of Material**

Every Sort of Hoisting Apparatus

**BROWN HOISTING MACHINERY CO.** Cleveland, Ohio

INSULATING  
 VARNISHES  
 (BAKING; AIR-DRYING)  
 COMPOUNDS  
 TAPE



Possess the  
 Highest Insula-  
 tive Efficiency.

**The Standard Paint Co.**  
 100 William St.  
 New York.

The soft steel flanges of the

**Ideal Trolley Wheel**

have an absolutely uniform thickness that insures *perfect balance*. And perfect balance means high mileage.

Buffalo **LUMEN BEARING CO.** Toronto

**E. SAXTON**  
**CONTRACTOR**

SPECIALTIES:

**CONDUIT ELECTRIC RAILWAYS**

**TROLLEY LINES**

CITY AND SUBURBAN

**CONDUIT SYSTEMS, ETC.**

OFFICE, 841 BLADENSBURG ROAD, WASHINGTON, D. C.  
 Long Distance Telephone, East 887

**A. L. REGISTER & CO.**

Engineers and General Contractors—Electric Railways  
 112 North Broad St. PHILADELPHIA, PA. Established 1889

**SHIMER & CHASE CO.**

**Experienced Promoters of Electrical Railway Projects**  
 Correspondence Solicited OMAHA, NEB.

**CENTRAL INSPECTION BUREAU**

Inspection of Rails, Ties, Cars, Motors, Bridges, Buildings, Etc.  
 17 STATE STREET - - - NEW YORK CITY

**LINE MATERIAL**

ELECTRIC SUPPLIES FOR RAILWAYS, POWER PLANTS, ETC.  
 THE CREGHEAD ENGINEERING CO., 348 Main Street, Cincinnati, Ohio

**THE CURTAIN SUPPLY CO.**

CAR CURTAINS  
 CHICAGO, 85-93 Ohio Street 1819 Park Row Bldg., NEW YORK

**HOT WATER HEATERS FOR CARS**

THE PETER SMITH HEATER COMPANY, Detroit, Mich.

**AUTOMATIC TROLLEY GUARD CO.**

391-393 Ellicott Square, Buffalo, N. Y. 3  
 "IT PUTS THE WHEEL ON THE WIRE"

**GEARS AND PINIONS**

FOR ALL TYPES OF MOTORS  
 THE VAN DORN & DUTTON CO., CLEVELAND, OHIO

**ELECTRIC HEATERS** For All Classes  
 of Cars

New York **Consolidated Car-Heating Co.** Chicago

**WHEEL TRUING BRAKE SHOES**

Repair Crippled Wheels While Running  
 THE WHEEL TRUING BRAKE SHOE CO., Detroit, Mich.

SPRINGS—TIRES—STEEL-TIRED WHEELS  
**RAILWAY STEEL-SPRING CO.**

General Offices: 71 Broadway, New York

**HART CONVERTIBLE CAR**

RODGER BALLAST CAR CO., Railway Exchange, CHICAGO

**GRIFFIN WHEEL CO.**

CHILLED IRON CAR WHEELS CHICAGO IRON OR STEEL AXLES

**BRAKESHOES**  
 STANDARD  
 BRAKESHOE COMPANY  
 GEN'L OFFICES & WORKS—AURORA, ILL.—CHICAGO OFFICE 315 IVY EXCH.

**HEINE SAFETY BOILER CO.**

421 OLIVE STREET, ST. LOUIS, MO.  
 Manufacturers of WATER TUBE BOILERS

**SMITH CONCRETE MIXER**

Does the work better, quicker, cheaper and lasts longer.  
**CONTRACTORS' SUPPLY & EQUIPMENT COMPANY**  
 Old Colony Building, Chicago 170 Broadway, New York 9

# Electric Railway Lubrication

THE same skillful expert supervision given in this service as in steam railway service has produced most satisfactory results. Lower cost of lubrication with better service.

Including both  
Rolling Stock  
and Power House  
Equipment

We are under contract with many of the largest Street and Interurban railways in the country.

We guarantee cost per thousand miles in Street and Electric Railway Service when conditions warrant it.

Write for further particulars.

**Galena-Signal Oil Company**  
FRANKLIN, PENNSYLVANIA

# Shawmut Soldered Bond Cap

to make over your  
**PLUG BONDS**

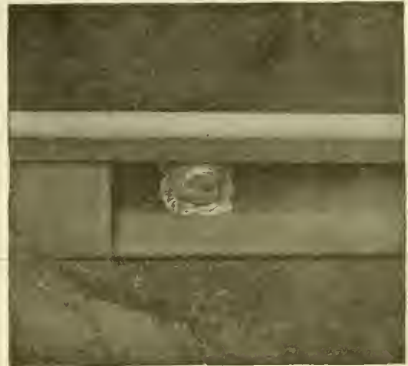

Why not look this up

**CHASE-SHAWMUT CO.**  
Newburyport, Mass.



## Nuttall Catalog No. 10

illustrates the most complete line of trolley wheels, bases and harps, gears and pinions ever offered. If you have not a copy send for one.

*If in a hurry, wire us.*

**R. D. Nuttall Company**  
Pittsburg, Pa.

NOTE—We have transferred our Southern Agency from the Southern States Electric Co. to the Electric Service Supplies Co., Atlanta, Ga.



Street Railways using the

# Rooke Automatic Fare Collector

get every nickel collected because every nickel is registered before it reaches the conductor's hand. No chance to go astray!

**Rooke Automatic Register Co.**  
Providence, Rhode Island

# TRADE **WALKOVER** MARK Car Seat

Gives more room, more comfort, and more money value than any other seat made.

No. 99A  
In Rattan



Notice its superior construction and substantial appearance. Specify and insist on our seats for your new Electric Cars; they cost less, in the end, than the worthless imitations sometimes offered instead.

**The Hale & Kilburn Mfg. Co.**  
PHILADELPHIA

NEW YORK

CHICAGO

WASHINGTON

This 14-inch Hochfeldt Eclipse Combination Back Pressure and Relief Valve was installed three years ago in the boiler plant of the Chicago City Railway, located at 77th and Vincennes Road, and is operating with best results.

**THE JOHN DAVIS COMPANY**  
HALSTED 22<sup>ND</sup> AND UNION STS - CHICAGO

# McGUIRE-CUMMINGS MFG. CO. CHICAGO



SPRINKLERS, CARS, TRUCKS AND RAILWAY EQUIPMENT

# The Cleveland Frog & Crossing Co.

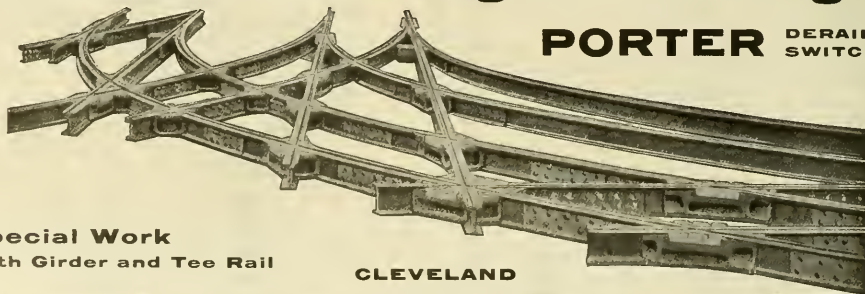

**PORTER DERAILING SWITCHES**

**Special Work**  
Both Girder and Tee Rail

**CLEVELAND**



# FOR SALE. FOR QUICK DELIVERY

## 6 55-ft. Passenger, Baggage and Smoking Car Bodies

Main Compartment	26' 0"
Smoking	" 10' 6"
Baggage	" 10' 0"
Seating Capacity, 54	

## 8 60-ft. Passenger, Baggage and Smoking Car Bodies

Main Compartment	28' 6"
Smoking	" 11' 0"
Baggage	" 8' 0"
Seating Capacity, 58	

## 5 52-ft. Passenger and Smoking Car Bodies — Double End

Seating Capacity, 60

## 3 52-ft. Passenger and Baggage Car Bodies — Double End

Seating Capacity, 56

## 2 50-ft. Express Car Bodies

*Write or wire us for further information.*

# The Jewett Car Co. Newark Ohio

## THE MIGHTY MIDGET HOT WATER CAR HEATER

Adapted for Large Electric Cars and Long Distance Lines. Exclusively used on Largest Electric Systems. Ask for Catalog

THE WILLIAM C. BAKER HEATING & SUPPLY CO., 143 LIBERTY STREET NEW YORK

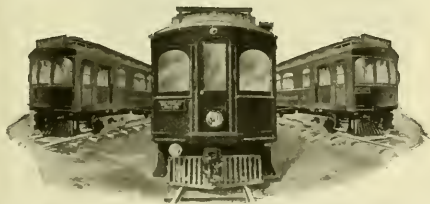

## NILES CARS — THE ELECTRIC PULLMANS

LARGE, FAST INTERURBANS  
OUR SPECIALTY

## NILES CAR & MFG. COMPANY

WORKS: NILES, OHIO

Sales Office:  
J. A. HANNA Co., 312 Electric Bldg., Cleveland, O.

## CAR BODIES

Of All Types

## TRUCKS

To Suit

## CINCINNATI CAR COMPANY

CINCINNATI, OHIO

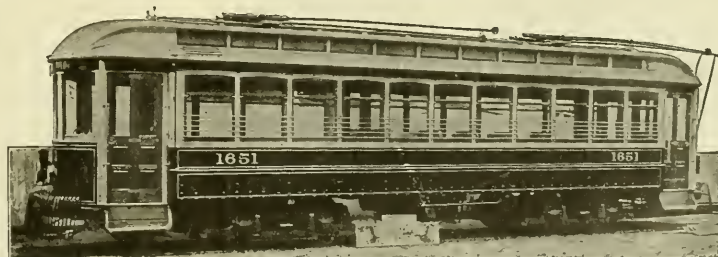

STANDARD SEMI-CONVERTIBLE—For Use All the Year

## Baldwin Locomotive Works

BURNHAM, WILLIAMS & CO., PHILADELPHIA, PA., U. S. A.

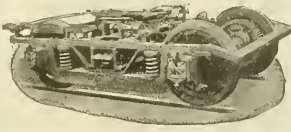

Builders of  
**LOCOMOTIVES**  
of every description  
including  
**ELECTRIC  
LOCOMOTIVES**

**ELECTRIC TRUCKS**

## Standard Steel Works Co.

HARRISON BLDG., PHILA., PA., U. S. A.

New York, N. Y. Cleveland, O. St. Louis, Mo. Denver, Colo.  
Portland, Ore. Richmond, Va. Chicago, Ill. St. Paul, Minn.  
San Francisco, Cal. Seattle, Wash. Winnipeg, Can.

**Solid Forged  
Rolled and Steel Tired Wheels**

Mounted on axles fitted with Motor Gears  
for Electric Railway Service.

**LOCOMOTIVE TIRES RAILWAY SPRINGS  
FORGINGS CASTINGS**



## MORDEN FROG AND CROSSING WORKS

MANUFACTURERS OF

618 The Rookery, Chicago

**Street Railway Special Track Work**

Works: SOUTH CHICAGO and CHICAGO HEIGHTS

"UNION" Track Jacks, Switches, Frogs, Crossings, Rail Braces, Etc.



CONTINUOUS JOINT

Over  
25,000  
miles  
in use



WEBER JOINT

Rolled  
from  
Best Quality  
Steel



WOLHAUPTER JOINT

Catalogs at Agencies

Baltimore, Md. Portland, Ore.  
Boston, Mass. Seattle, Wash.  
Chicago, Ill. St. Paul, Minn.  
Denver, Colo. St. Louis, Mo.  
Pittsburg, Pa. Troy, N. Y.

London, Eng. Montreal, Can.

HIGHEST AWARDS—Paris, 1900;  
Buffalo, 1901; St. Louis, 1904

Additional safety and economy in **Track Maintenance** has been proved by the use of Continuous, Weber and Wolhaupter base-supported rail joints—after ten (10) years' service, having a record of over **25,000 miles** in use—the extent of which is evidence of their excellence.

## THE RAIL JOINT COMPANY

General Offices: 29 West 34th Street, New York City  
Makers of Rail Joints for Standard and Special Rail Sections, also Girders, Step or Compromise, and Insulating Rail Joints, protected by patents in United States and Foreign Countries.

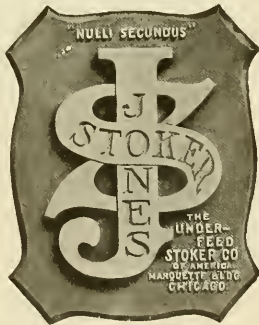

## PIPE FITTINGS AND VALVES

FOR THE HEATING AND PLUMBING TRADE

TRADE  MARK

**JOHN SIMMONS CO.**

104-110 Centre Street, NEW YORK

IF YOU wish to keep posted on all steam railway matters you must read **THE RAILWAY AGE**, for it is the leading railway journal of the world and the only one that covers all phases of the industry.

Sample copies sent on request.

**THE RAILWAY AGE**

160 HARRISON STREET - - CHICAGO

Of all the good things we can say about the

# Knutson Trolley Retriever

the best is this—it is in successful use on a majority of the high-speed electric railways of America.

What more need we say?

Only this—send for a lot and make a thorough test on your road at our expense. Write to



**The Trolley Supply Co., Canton, Ohio**

8

## Crank Pin Presses

We illustrate in our Railroad Catalogue No. 69 five different types of these machines, ranging in tonnages from 60 to 250, either hand power or motor driven. These machines are very handy around a machine shop, as they are portable and may be used for any forcing work where a horizontal pressure is required. The machines have a vertical adjustment and twelve-inch stroke. Every tool guaranteed.

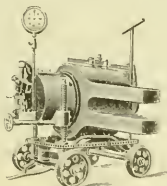

*Send for Railroad Catalogue No. 69.*

**THE WATSON-STILLMAN CO.**

26 Cortlandt Street, New York City  
Branch Office: 453 The Rookery, Chicago, Ill.



Factory of The Milloy Electric Company  
Bucyrus, Ohio

## The Milloy Trolley Base

built in our new and specially equipped factory, insures a quality which will give excellent service under ordinary and extraordinary conditions.

The Milloy Base is unusually low, has even tension on high or low wire. Has no fulcrum, no friction, no oil, no center post. Always efficient. Particulars on request.

**THE MILLOY ELECTRIC COMPANY**  
Bucyrus, Ohio

## THE NATIONAL LOCK WASHER CO., NEWARK, N. J.

Curtains - Curtain Fixtures - Sash Locks - Sash Balances - Nut Locks

CHICAGO OFFICE: 419 MONADNOCK BLOCK

One road reports gear cases packed with

## Whitmore's Gear Protective Composition

car in continuous operation one year and one week, no further applications made, absolutely no wear on either gears or pinions. These results are what cause our competitors to make false statements about the use of our goods. Try it and be convinced.

**The Whitmore Manufacturing Company**  
LUBRICATING ENGINEERS  
Cleveland, Ohio, U. S. A.

Why not cut your packing bill in half?

## STEEL WOOL JOURNAL PACKING

will do this for your road, as it has for many others. It will also save one-third in oil consumption and an appreciable amount of labor and wear. And it prevents hot boxes positively.

*If you are open to conviction, send for free sample and test it thoroughly*

**WM. ROBERTSON & COMPANY**

General Office: Great Northern Bldg., CHICAGO  
Factory: 75 S. Jeffersou St., BATTLE CREEK, MICH.

12

# CLASSIFIED ADVERTISEMENTS

Undisplayed advertisements are inserted under this heading at the uniform rate of one cent a word; minimum charge twenty-five cents. Replies directed to this office will be forwarded when required to any address in the United States, Canada or Mexico without extra charge. Advertisements received at the Chicago office by 9 a. m. Thursday will appear in the issue for the same week.

## POSITIONS WANTED.

Expert street car electrician, city or interurban lines, desires a change. Fifteen years' experience; capable handling men; also railway agent manager. Now with a large railway. Address "No. 578," care of Electric Railway Review, Chicago.

An experienced supply salesman, who also has had thirteen years' operating experience on city lines, desires to form connection with a railway supply house handling either electric or steam supplies or both. Would consider proposition to open sales agency. Address "No. 566," care of Electric Railway Review, Chicago.

Transportation man of seventeen years' experience, young, reliable and thoroughly familiar with organization, dispatching and timetable work, desires a position as superintendent or one of equal responsibility. Highest references regarding character, ability and past service. Address replies to "No. 577," care Electric Railway Review, Chicago.

Position as superintendent or assistant to general manager wanted. Eighteen years' experience in railway work. For the last six years have been superintendent of an electric railway company. Can get best of references from present employers. Can also give good reason for wishing to make change. Address "No. 575," care of Electric Railway Review, Chicago.

Young man familiar with overhead construction of all kinds (including catenary), installation of transformers, lighting, telephones and substation work; also some experience on car and switchboard work, desires position with city or interurban road. Employed but desires change. Best of references. Address "No. 576," care of Electric Railway Review, Chicago.

## POSITIONS WANTED.

Wanted—A young man experienced in street railway and electric light accounting desires position as auditor. Best of references as to character and ability. Address "No. 573," care of Electric Railway Review, Chicago.

Management of street railway amusement park wanted; experienced, up-to-date, sober and reliable. Park playing vaudeville and hands preferred. Experienced in park designing and construction. Best of references. Don't put it off, write me today. Address E. E. Wilmarth, Massillon, Ia.

Wanted—To correspond with company needing the services of high-class general manager or general superintendent. Electrical and civil engineer; 17 years' experience with large properties and in construction and operation. Address "No. 568," care of Electric Railway Review, Chicago.

Experienced electrical engineer wants position with manufacturing concern or with company operating electric railways. Graduate Purdue University, 1905. Will go anywhere for permanent position. Age 26; married; A No. 1 references as to habits and ability. Address "No. 570," care of Electric Railway Review, Chicago.

Position wanted as auditor and accountant. Sixteen years of steam, electric and general experience; good working knowledge of details of general contracting business; clever buyer; possess ability to organize. Can furnish first-class reference as to character and ability and work accomplished in past; leaving present work because closed; at liberty to accept position any time. Address "No. 575," care of Electric Railway Review, Chicago.

## POSITIONS OPEN.

Twelve offices, covering the entire street railway and manufacturing world. Positions open everywhere; office, sales and technical. Write today, FAF-GOODS, 305 Broadway, New York, or 1010 Hartford Bldg., Chicago.

Best general manager obtainable to construct and operate a new interurban system. Initial line only the beginning of a system. Give experience and reference. Address "No. 579," care of Electric Railway Review, Chicago.

## BUSINESS OPPORTUNITIES.

Wanted—Man with some capital and a knowledge of railway track supplies to join the advertiser—a salesman handling locomotive and car supplies—in a general railway supply business. Address "No. 558," care of Electric Railway Review, Chicago.

Recharging Dry Batteries, the only book ever published giving complete directions of how to prepare chemicals for renewing dry batteries. If you are not more than pleased with this book your dime back. Large electrical catalogue and book postpaid, 10 cents. Adams Electric Co., Dept. E. R., Kewanee, Ill.

## MISCELLANEOUS WANTS.

Want to buy second-hand equipment, machinery or material? A card inserted in the Electric Railway Review, stating just what you want, will bring immediate response. The cost is small—only \$1.20 an inch (measuring 1 inch deep by 1 1/2 inches wide) per insertion. Send orders to Electric Railway Review, 160 Harrison St., Chicago.

## MISCELLANEOUS WANTS.

What have you to sell in the way of second-hand equipment, machinery or material? Buyers read the "For Sale" cards on the following page and there is the place to tell your story. "For Sale" cards are inexpensive—only \$1.20 an inch (measuring 1 inch deep by 1 1/2 inches wide) per insertion. Special rates on contracts for 100 inches or more to be used within one year. Now is the time to send your order to Electric Railway Review, 160 Harrison St., Chicago.

## BOOKS AND PUBLICATIONS.

Wanted—Copies of the Street Railway Review of July 20, 1904, and June, 1906. State condition and price. Address "No. 567," care of Electric Railway Review, Chicago.

Wanted—Copies of the Street Railway Review of April, 1900, May, 1901, and August, 1903. State price and condition. Address "No. 563," care of Electric Railway Review, Chicago.

Interstate commerce national legislation to July 1, 1906, is fully covered in our reference pamphlet. It contains the full text of the act to regulate commerce as amended, including the Elkins and Hepburn acts, and of the supplementary act relating to the testimony of witnesses before the Interstate commerce commission. It also contains the texts of the expedition act, the anti-trust act of 1890, the employers' liability act and the safety equipment laws. Difference in type shows the parts expunged from, and the parts added to, the Interstate commerce and Elkins acts by the Hepburn act. This pamphlet is of special value to railway men and lawyers. Mailed prepaid for 25 cents in stamps or coin. Special prices for quantities. The Wilson Company, 160 Harrison St., Chicago.

**P. W. MARSHALL & CO.**  
95 and 97 Liberty St., NEW YORK  
Second-Hand Machinery and Equipment  
**ELECTRIC RAILWAY MATERIALS**

Rare Bargains in  
**RAILS AND EQUIPMENT**  
WALTER A. ZELNICKER SUPPLY CO.  
In ST. LOUIS  
DO YOU RECEIVE OUR STOCK LISTS?

**NO SNOW TO DELAY CARS**  
The Russell Snow-Flow is used by more than 50 roads to maintain schedules and prevent blockades. Russell Car & Snow-Flow Co., Ridgway, Pa. Wendell & MacIntire, Cortlandt St., New York; C. A. Ralston, Fishet Bldg., Chicago; Robinson & Cary Co. Saint Paul.  
**IF YOU HAVE A RUSSELL**

**FOR SALE: Three Car Bodies and Three Pairs of Double Trucks**  
with or without electric equipment and air brakes; all new and never used. Compelled to sell, as they will operate over a leased line by reason of their width and length.  
**R. W. MARSHALL & CO., 97 Liberty St., New York, N. Y.**



## Replies to Want Ads

may come in care of the ELECTRIC RAILWAY REVIEW and are forwarded without charge. The cost of want ads is only one cent a word per insertion.

# The Lindsley Brothers Company

Producers and Shippers of

and Manufacturers of

## WESTERN CEDAR POLES

## RED FIR CROSS ARMS

Eastern Sales Office, Monadnock Bldg., CHICAGO

SPOKANE, WASHINGTON

## Poles and Ties

A Selected Stock in Chicago for Rush Shipment

A Number of Large Yards in the North

### NAUGLE POLE & TIE CO.

CHICAGO OFFICE: 226 LA SALLE STREET

## Shelby Trolley Poles

Made from Cold Drawn Seamless Steel Tubing.

Immediate delivery all sizes from stock.

The Garford Company : Elyria, O.

We are Producers and Wholesale Dealers in Western

## CEDAR POLES

Yards in Washington, Idaho, Montana and British Columbia

WRITE US FOR DELIVERED PRICES

CHURCHILL CEDAR CO., Box 1409, Spokane, Wash.

## Red Cedar Poles White

Prompt deliveries at right prices.

NATIONAL POLE COMPANY  
EVERETT, WASH. ESCANABA, MICH.

## Idaho Cedar Poles

PACIFIC COAST POLE CO.

SPOKANE, WASH.

## C. H. WORCESTER CO. CEDAR POLES

PRODUCERS AND WHOLESALEERS

Suite 1716 Tribune Building

CHICAGO

## For Sale

Cards produce results in the Electric Railway Review

## G. H. BARNES HARDWOOD LUMBER CO.

Office and Yard: Main and Warren Sts., ST. LOUIS, MO.

Ties, Car Oak, Poplar, Ash, Cherry, Plain and Quartered Oak

## POLES and PILING

20,000 35s and 40s, Ready to Ship at Once  
S-E. MISSOURI CYPRESS CO., CAMPBELL, MO.

### WHITE CEDAR

# P O L E S

Large Stock 14 to 65 ft.

Prompt Shipment

# P O L E S

YARDS:

Menominee, Mich.  
Escanaba, Mich.  
Superior, Wis.  
Deer River, Minn.

FRANCIS BEIDLER & CO.  
Chicago, Ill.

## BERTHOLD & JENNINGS

LUMBERMEN'S BLDG. SAINT LOUIS, MO.

### TIMBERS

L. L. Pine, Oak

### POLES

Cedar, Cypress, Chestnut

### TIES

Oak, Cypress, Chestnut

## POLES and TIES

We have a nice selected stock of  
**Chestnut Poles**  
White and Common  
OAK and CHESTNUT TIES

The Advance Lumber Co.  
1313 Rockefeller Building  
CLEVELAND  
OHIO

**The Dispatcher Knows** that his stop order has been executed by  
**The Telegraph Signal System!**

—because, after the order has been completed, the number of the station to which it was sent is automatically recorded on the dispatcher's tape register.

That's a mighty important point. You know a system that does not provide positive evidence of the execution of a stop order is fatally defective!  
*OUR SYSTEM HAS PROVED ITS WORTH IN ACTUAL USE. WRITE US.*

**Telegraph Signal Company,** <sup>282</sup> State Street, **Rochester, N. Y.**



WE ARE NOW PREPARED TO FURNISH

**Manganese**  
**STEEL PINIONS**

**FOR USE WITH "TITAN" GEARS**

**ATHA STEEL CASTING COMPANY, Newark, N. J.**

**Baltimore Center and Side Bearings**

**FOR ELECTRIC TRUCKS**

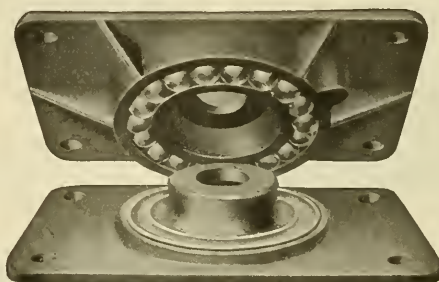

**Impossible  
to Clog  
Balls**

**No  
Lubrication  
Necessary**

**SAVES:** { FLANGE WEAR  
RAIL WEAR  
TRUCK REPAIRS

**DURABILITY:** { PROVEN  
UNDER  
HEAVIEST  
LOADS

**BALTIMORE**  
MD.

**THE T. H. SYMINGTON CO.**

**CHICAGO**  
ILL.

# Electric Railway Review

PUBLISHED EVERY SATURDAY BY THE WILSON COMPANY, CHICAGO

Entered as second-class matter January 5, 1907, at the postoffice at Chicago, Ill., under the act of March 3, 1879.

160 Harrison Street, Chicago  
150 Nassau Street, New York  
1529 Williamson Bldg., Cleveland

VOL. XIX  
No. 16

CHICAGO, APRIL 18, 1908

Whole No.  
260

Subscription: Domestic . . . \$2  
Foreign . . . \$5  
Canada . . . \$3.50

The tentative classifications of accounts suggested for electrical and gas corporations by the New York public service commission, second district, provide for a much wiser grading of companies with regard to the magnitude and financial importance of their operations than the interstate commerce commission tentative classifications for electric railways. The public service commission has tentatively fixed four grades of corporations as follows, and corresponding classifications: Companies with annual gross revenue of less than \$10,000; of \$10,000 and below \$100,000; of \$100,000 and below \$1,000,000; of \$1,000,000 or over. The interstate classifications suggest but two classes, and this feature of its proposed system has been subject to more nearly unanimous criticism than any other. If gross annual revenue is to be adopted as the basis for classifying electric railway companies, a much more liberal division should be made than has been indicated in Circular No. 20 of the interstate commission. C. N. Duffy suggests (Electric Railway Review, April 4, 1908, page 419) that three classifications be provided for electric railways instead of two. All evidence which has been submitted tends to show that economic waste would result if small companies were required to attempt to keep amplified classifications which would be used ordinarily by large companies only.

The New York public service commission is making active progress with its plans for much-needed additional subway construction in New York and it now seems entirely probable that construction may be started on at least one route during the present year. The plans for the Broadway-Lexington route in Manhattan and the

Fourth avenue route in Brooklyn have been approved by the board of estimate and bids for the construction of the latter are now being solicited. In its present plans for increasing the city's transportation facilities the commission has made general departures from former practice which were dictated by the experience of the old rapid transit commission. It will be remembered that the latter, after having spent nearly four years in the preparation of plans for the Lexington avenue route, failed to secure a bid for its construction and operation, the Interborough-Metropolitan Company, the only logical bidder, declining because the term of lease for operation was restricted by the Elsberg law to 20 years. In the case of the new subways bids will be asked only for construction. It is believed that a profitable arrangement for the operation of the subways can be made later, as the legislature is expected to pass an amendment to the present law increasing the length of the term for which contracts may be made. Doubt as to the city's ability to issue bonds for subway construction without exceeding the constitutional debt limit has led to another change in the method of procedure. Instead of asking for bids for the entire subway the commission has divided the Fourth avenue route into six sections. The legislature is expected to pass at this session a constitutional amendment exempting bonds for subway construction or other self-sustaining enterprises from consideration in calculating the debt

limit. This plan, however, could not become operative within two years. The commission anticipates that even if the city is unable to finance an entire route funds may be secured for one or two sections so that some tangible results may be obtained this year.

"A clock without hands, be it running ever so regularly, is not more useless than a worker without expression." We agree so heartily with the amplification of this adage as put forth by the Journal of Electricity, Power and Gas, that we can do no better than repeat it, word for word:

**Tip  
Over the  
Bushel.**

"There is no function of history that is more important than that of preventing the reduplication of effort, and from it the wise man learns by the mistakes of others. If we 'hide our light under a bushel' we not only blind ourselves with its little importance, but also compel others to work without its aid, whereas the two combined might soon make clear the way of attack. 'My light is none the less for having lit that of my neighbors.' The interchange of technical knowledge makes all richer and none poorer, and as a cold business proposition is a good paying investment, as is amply testified in the record of all scientific advance. The petty craving for credit has often overreached itself by prematurely causing the demise of the silent worker, whose efforts are thus lost to the world. The loss is the more regrettable because it is the more easily avoidable. Personal gain can or should be insured by patent. This publicity will provoke suggestions of improvement from others, which may again be turned to personal advantage."

As electric railway shops increase in size it becomes a more and more difficult problem to satisfactorily arrange the various shop tools and machines so that the work may be carried on progressively and with the lowest cost for labor and power. The advent of the direct-driven machine tool affords the master mechanic far wider latitude in laying out his shop than he has before enjoyed. It is stated by Dexter S. Kimball in a recent issue of the Sibley Journal of Engineering that a plant must be very small and compact when electric distribution cannot be used to advantage. The debatable point is just how far individual drive should be used as against group driving. While there has been some hesitancy on the part of machine tool builders in changing their patterns so that motors could best be used, this difficulty is now being rapidly overcome. Machine tool builders and electrical manufacturers are now united in solving the problem and it is suggested by Mr. Kimball that it will not be long until by reason of growth or consolidation machine companies will make a specialty of building complete motor-driven tools. This unity of interest is quite necessary for the highest development that may be desired from individual drive. The final answer to the question of whether individual or group drive is preferable can be made when accurate production costs are announced. Electric railway men whose shops always have current available should have

no hesitancy in thoughtfully considering the installation of individually driven tools where it is found that the system of shop arrangement can be benefited thereby.

---

### THE BANKER AND THE ENGINEER.

---

The paper read before the electrical section of the Western Society of Engineers, Chicago, on April 10, by J. C. Kelsey, on "The Relation Between Banker and Engineer," should help to bring about a clearer understanding of the relative position of these two important factors in corporation financing, management and operation. That the members who were present at the meeting appreciate the responsibility of the position which engineers should occupy toward the banker on one hand and the investing public on the other is shown by the expressions of opinion in favor of further discussion of this subject. There are two classes of bankers, private and incorporated. Formerly most of the financing was done by private bankers, but with the growth of trust companies in the principal centers of population and their entry into the field of promotion, the financing of corporations has become a business in which many large banks, both state and national, have engaged. The banker fills a useful function in furnishing large amounts of capital with which important financial operations are conducted. This capital is, of course, the property of the public. The banker, if incorporated, enjoys the management of the capital because a great many individuals and corporations or business firms have confidence in his integrity. The banker, if not incorporated, has usually a relatively small amount of capital, which is entirely insufficient for his needs. He conducts his operations almost wholly on borrowed money. That is, when he negotiates the purchase of an issue of bonds, he borrows from the incorporated banks with which he does business, say, 90 to 98 per cent of the estimated market value of the bonds. The remainder of the investment he furnishes with his own capital. The banker may form a syndicate or make an arrangement for joint purchase with others who can command more capital than he has or cares to risk, thus distributing the chance of loss. In the event of such an arrangement the banker who initiated the transaction may be the manager of the syndicate and receive a commission as such.

The essential fact, however, is that one banker usually becomes identified with a public utility property as its dominating power. The nature of the relationship thus assumed should mean that thereafter the banker will seek to preserve the integrity of the property. He should strive to conserve its earnings and protect the investment of the security-holders. In practice there is a wide departure from this ideal. In his paper, published in last week's issue of the Electric Railway Review, Mr. Kelsey indicated what duty the engineer should fulfill. By means of the information obtained through frequent examination the engineer should post the banker accurately concerning every vital point of operation and management. Mr. Kelsey said: "If the management of the property is niggardly with maintenance and repair, thereby rendering the contracted renewal reserve fund insufficient, the banker can call a halt. If the management is extravagant in operation and conduct of the business, thereby endangering bond interest, the banker knows it before it is too late."

It is plain that in the past either the engineer has not advised the banker concerning the true state of affairs, or that the advice and superior knowledge of the engineer have been ignored. The wreckage of corporations and the attendant distress in certain large cities are proof of this fact. The controlling banker has assented year after year to the practice of charging renewals to capital account and has willingly sold and recommended the securities based on such operations. Sometimes a false notion of security has been added to deception in the statement of prospectuses that the bonds would be rebought from purchasers. When this statement is

made what is intended is merely to convey assurance that if the purchaser desires his money again the banker will repurchase the security, provided conditions are auspicious. No banker could afford to place himself in the position of readiness to purchase again at all hazards, in hard times or in prosperity, all of the securities he had sold. If business were conducted on that basis each bond sold would constitute a liability, and, with any large volume of business, a general desire on the part of purchasers to convert securities into cash would precipitate bankruptcy.

The banker should, however, feel a definite responsibility regarding the safety of the investments, usually of savings, which he has invited. There is no legal means whereby the banker can be made to safeguard the investment, but there is every moral reason why he should do so. An untarnished reputation in this respect may reduce his profits, but should perpetuate his institution.

If there is to be reform in the banking attitude of merely buying to sell, it must be preceded by a desire in the banker to sell only good securities and to retain the merit of such securities throughout their life, with payment at maturity. To those who understand clearly the position of many banking interests in public utility corporations, it is plain that evils exist with the tacit support of bankers. Before a property has demonstrated its earning power it is necessary to give some prospects of large gain in order to interest those who control capital in the enterprise, but when a property is of assured permanent earning power there is no necessity or reason for high commissions. When there is certain earning power and definite increase in business the corporation is in a position to solicit bids from competing banking interests for all the securities of which it disposes. It is best for the corporation to take all precautions to avoid a combination of the banking bidders, for a combination of this character, such as is sometimes formed, will do away with all but the semblance of competition.

---

### DEPRECIATION CHARGES OF THE INTERNATIONAL TRACTION COMPANY.

---

It appears from a comparison of the annual reports of the International Traction system of Buffalo for the years 1906 and 1907, as abstracted in the Electric Railway Review for March 23, 1907, and April 11, 1908, that this company has adopted a definite policy regarding accounting currently for depreciation. In the report for the year 1907 there is shown a charge of \$269,022 on account of depreciation, which is 5 per cent of gross earnings. In the 1906 report no charge for depreciation was shown separately, but maintenance charges for that year, which were included in operating expenses, were relatively much greater than in preceding years. In the report for last year the 1906 accounts are stated in a different manner, depreciation being segregated to permit of comparison.

The report does not disclose the basis on which the amount charged for depreciation in 1906, \$234,792, was determined. This sum is almost 4½ per cent of the gross earnings from operation in 1906. Nor does it bear the same ratio to the total operating expense of that year that the depreciation charge for 1907 bears to operating expenses in 1907, although in both years the depreciation charges are very close to 8 per cent of the total of operating expenses and depreciation.

The table of earnings and operating expenses (operating expenses are for International Railway and Crosstown Railway only, but are virtually the totals for the whole system) shown in American Street Railway Investments for the years 1903 to 1906, inclusive, show charges to operating expenses on account of maintenance which in percentage of gross receipts are as follows:

1903.	1904.	1905.	1906.
7.52	10.00	9.48	14.17

The last report of the company does not show mainte-



nance separately from operating expenses, but assuming that maintenance in 1907 bears the same proportion to maintenance in 1906 that depreciation allowed for 1907 bears to depreciation charges of 1906, the total of maintenance and depreciation for the year 1907 is 15.03 per cent of gross receipts.

The 5 per cent allowed is the same proportion of gross as charged currently by the United Railways of St. Louis, but is low compared with the provision made by the Twin City Rapid Transit Company of Minneapolis, which has charged an average of 8 per cent of gross earnings for depreciation for the last three years, and with The Milwaukee Electric Railway & Light Company, which has charged 10 per cent of gross earnings for 11 years.

ANNUAL REPORTS.

United Railways of St. Louis.

Passenger revenue of the United Railways of St. Louis amounted to \$10,659,037 in 1907, an increase of 18.5 per cent over 1906, when no allowance is made in the 1906 accounts for the operations of the St. Louis & Suburban Railway, the results of which are included in the totals for 1907. Including the figures of the St. Louis & Suburban Railway for comparison, gross earnings and other income increased 5.25 per cent and operating expenses, taxes, reserve fund appropriations and depreciation charges increased 10.04 per cent. The Suburban system was merged into the United Railways system on January 1, 1907. Omitting the St. Louis & Suburban figures for 1906 the operations of the United Railways for two years, slightly rearranged, with a comparison, follow:

	1907.	1906.	Increase.
Gross earnings .....	\$10,771,164	\$9,093,740	\$1,677,424
Operating expenses and taxes .....	6,503,700	5,111,731	1,391,969
Net earnings .....	\$ 4,267,464	\$3,982,009	\$ 285,455
Other income .....	57,573	52,608	4,965
Total net income.....	\$ 4,325,037	\$4,034,617	\$ 290,420
Interest .....	2,778,023	2,377,477	400,546
Net divisible income...\$	1,547,014	\$1,657,140	*\$ 110,126
Depreciation .....	540,182	455,681	\$ 84,501
Balance .....	\$ 1,006,832	\$1,201,459	*\$ 194,627
Preferred dividends .....	649,160	649,160	.....
Surplus .....	\$ 357,672	\$ 552,299	*\$ 194,627

\*Decrease.

The charge for depreciation is on the same basis as in the previous year, amounting to 5 per cent of the gross revenue, carried each month to a reserve fund. All but \$5,564 of the amount credited to the account was expended during the year. The remaining sum was added to the amount on hand in this fund, making a total balance of \$183,619. The injuries and damages reserve fund amounted at the close of the year to \$571,035. The treasury holds as an investment for this fund 5,000 shares of preferred stock of the company. A small percentage in excess of the actual fire insurance premiums paid was charged against the operating expenses during the year, increasing the fire insurance reserve fund at the end of 1907 to \$113,638. The treasury held 1,000 shares of the preferred stock of the company for investment for this fund.

John I. Beggs, the president, states that the gross earnings and other income for the year show a very gratifying and satisfactory increase over the preceding year, and that the net earnings are very good when consideration is given to the following facts:

1. On January 1, 1907, the St. Louis & Suburban Railway became a part of this company's system, hence, in order to get a fairly accurate comparison for 1907 with the year 1906 it was necessary to incorporate the results of operation of the St. Louis & Suburban system in the figures for 1906.

2. The physical property of the St. Louis & Suburban system was in very bad condition, requiring large expenditures to place it in reasonably good operating condition; further

extraordinary outlays will be necessary during the year.

3. No provision had been made in the Suburban company's accounts for depreciation, whereas this year 5 per cent of the gross earnings have been charged, making a difference of about \$57,000.

4. Adequate reserves were never set up in the Suburban's accounts for fire insurance, injuries and damages and other contingent liabilities.

5. A decided increase in the cost of labor and material has substantially increased the operating and maintenance costs for the year 1907.

6. The general financial stringency and depression in business during the latter months of the year somewhat reduced our gross earnings, and whatever reduction of gross earnings we suffer must all come out of net earnings, as the cost of operation remains practically the same.

The company sold at par \$1,200,000 of 5½ per cent 2-year collateral trust notes, secured by a deposit of \$1,500,000 of general first mortgage 4 per cent bonds and \$500,000 of preferred stock of the United Railways Company. The proceeds of these notes, with \$300,000 raised on other notes, retired \$1,500,000 underlying Citizens' Railway Company 6 per cent bonds, which matured on July 1, 1907. The \$1,500,000 of 4 per cent bonds used as collateral security for the notes were reserved under the mortgage for retirement of the underlying bonds, but the issue of notes was made because it was "impossible to sell the 4 per cent bonds at any reasonable figure, owing to the financial conditions prevailing during the year." The funded debt outstanding was \$59,180,000 on December 31, 1907, a reduction of \$300,000. The stock issues were unchanged at \$19,983,200 preferred and \$24,913,500 common. The balance sheet as of December 31, 1907, shows \$1,244,500 bills payable.

The company owned at the end of the year 457 miles of single track, of which 350 miles were in the city and 107 in the county of St. Louis. Of the total 448 miles were in operation. The woodworking and paint shop is now in full operation and finished 27 new cars during the year. Nine additional cars are in process of construction and others will be added during 1908. Mr. Beggs makes the following reference to wages:

In order to encourage our old conductors and motormen to continue in the service, the following rates of pay have been established, effective January 1, 1908: Those who have been continuously in the service of the company for a period of four years will be paid at the rate of 24 cents per hour; for five years or more continuous service, 25 cents per hour. All others will continue to receive 23 cents per hour, the rate which they had been receiving, until the completion of their fourth and fifth years' continuous service, when the higher rates will apply. It is also intended to establish a graded rate of pay for motormen and conductors entering the service on and after January 1, 1908, which we believe will be more equitable than placing new and inexperienced men on the same footing as our trained men.

Statistics of traffic follow:

	1907.	1906.	Increase.
Revenue passengers .....	216,779,638	206,409,101	10,370,537
Transfers and passes.....	97,165,511	85,113,685	12,051,826
Total passengers .....	313,945,149	291,522,786	22,422,363
Percentage using transfers.....	42.34	38.83	3.51
Average fare per passenger, cents .....	3.39	3.47	*0.08

\*Decrease.

Central Electric Accounting Conference Meeting Called.

M. W. Glover, chairman of the Central Electric Accounting Conference, has called a meeting to be held at the Lima house, Lima, O., on April 23. The meeting is called at the request of F. D. Carpenter, president of the Central Electric Railway Association, and it is desired to have present the accounting officers and other officials of companies in both the conference and the association who are interested in the proposed accounting system of the interstate commerce commission. Representatives of electric railways in the central territory that are not members of the conference or the association, but are interested in the tentative classifications of accounts, are also invited to be present.

# Communications

## INDETERMINATE FRANCHISES FOR PUBLIC SERVICE CORPORATIONS.

To the Editors:

Speaking only for myself, in purely a personal way, I favor the idea of indeterminate franchises for public service corporations. It seems to me that the idea embodied in the public service commissions law of this state, preventing the capitalization of any franchise at a sum greater than the amount actually paid to the state, or minor governmental body granting the franchise, is thoroughly sound and that the condition underlying the continuance of the grant of any franchise should be the furnishing of adequate and satisfactory service for a reasonable remuneration. Whenever the state or municipality finds that such service is not being rendered, it ought to be in position to revoke the franchise. With this must go, of course, provision for recompensing the corporation for its actual investment in case the franchise is canceled.

WILLIAM J. MEYERS,

Statistician New York Public Service Commission, Second District.

Albany, N. Y., April 11, 1908.

## CLASSIFICATION—CHANGES IN ACCOUNTING AND OPERATING METHODS NOT JUSTIFIED.

To the Editors:

The business of this company is that of a general electric business, comprising power for mills in factories, municipal and commercial lighting, and a street railway, in addition to which the company owns and operates an ice plant. The conditions existing here are not similar to those in other places, and naturally our business has been organized and is operated in such a manner as will best meet local conditions and prove most economical. The form of monthly report which we are now using meets our own requirements very well, but the classification does not at all conform with that which is proposed by the interstate commerce commission for the use of all companies, and the latter classification would not suit our conditions.

To compel us to follow the proposed classification would mean a complete reorganization of our system of accounting and necessitate an increase and change in our office force. It would likewise entail some changes in our operating forces and methods, which are at present consolidated for reasons of economy. We think that from our point of view such changes are not justifiable.

We find already that to endeavor to comply with all the details required by national and state governments adds a very considerable amount of work to the regular requirements of business.

In this matter of classification the line of demarcation between large and small companies is a very broad and vital question, which should call forth a very thorough investigation of the business of individual companies, and we seriously doubt the wisdom or the ability to base this line of demarcation upon the gross revenues of the companies concerned. We do not think that the distinction between large and small companies can be, or should be, based altogether upon the amount of gross revenue.

Conditions of operation between local systems in towns and large cities and interurban roads are not, and cannot be said to be, entirely the same. In our case the railway is but a part of our electric business, the greater portion of which—power, light, etc.—is not included in the proposed classification, because it is distinct from the railway operation. The construction of our lines is such that we cannot separate the railway from lighting and power service, because the transmission wires are carried upon the same lines and poles:

this same joint method of service prevails throughout the entire conduct of our business wherever it is practicable from the standpoint of economy in the matter of construction or operation. We think this is true of other towns and smaller cities.

It is not our purpose to oppose any system that will work out for the best interest of this business, but thus far we do not see where any great benefit is to come from the change. We do think we can see much additional work and expenditure in our office without a corresponding return, and possibly the reorganization of operating conditions to meet the proposed requirements.

THE FRIES MANUFACTURING & POWER COMPANY,

By B. J. Pfohl, Secretary and Treasurer.

Winston-Salem, N. C., April 8, 1908.

## CLASSIFICATION—NEW HAMPSHIRE RAILROAD COMMISSION AND INTERSTATE ACCOUNTING SCHEME.

To the Editors:

The system of accounting and the form of reports we have been using for electric railways are satisfactory to us, and while they may be modified somewhat to make them uniform with those of states contiguous to New Hampshire, we see no need of material change. Furthermore, as all our roads are intrastate we do not feel that we need the assistance of the interstate commerce commission in ascertaining and reporting the condition and the results of operation of the roads.

H. M. PUTNEY,

Chairman New Hampshire Railroad Commission.

Manchester, N. H., April 14, 1908.

## WHITENING SHOP FLOORS WITH LIME.

The accompanying halftone engraving is made from an unmanipulated photograph, showing one repair bay of the Aurora Elgin & Chicago Railroad Company's shops at

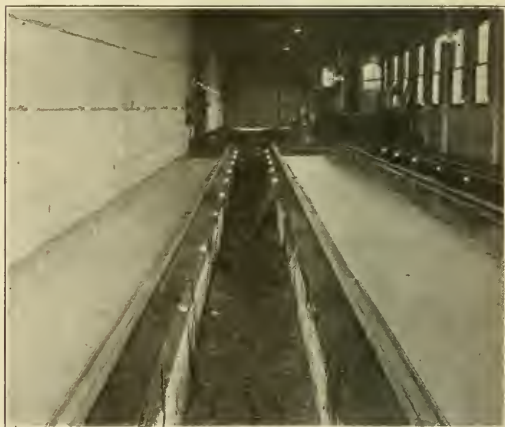

Aurora Elgin & Chicago—Shop Floors Whited with Lime.

Wheaton, Ill. This view is reproduced to show the very satisfactory method for increasing the illumination under car bodies by keeping the floors white. To maintain the floors in this clean, white condition, so that the greatest amount of light will be reflected under the car bodies, they are swept with slacked lime. Before applying the lime the cement floor is thoroughly cleaned and then a quantity of the lime is sprinkled over the surface and swept off with a broom. By first cleaning the floors one coating will serve for a dozen sweepings. We are indebted to E. P. Doyle, master mechanic, for this interesting shop practice.

## SHORT TALKS WITH THE CLAIM INVESTIGATOR—II.

BY F. W. JOHNSON, ASSISTANT GENERAL CLAIM AGENT PHILADELPHIA RAPID TRANSIT COMPANY.

It may be accepted as an established fact that opportunities to go wrong greet the claim man with greater frequency and in a greater variety of form than is ordinarily encountered by young men engaged in other branches of commercial life.

To one who has been associated with claim work for any considerable period of time it is not a difficult matter to readily call to mind numerous instances in which investigators and inspectors who gave every promise of bright futures in the work, from one cause or another, have "blown up" just when success seemed within their grasp.

Of the many pitfalls which fate seems to strew with a lavish hand along the paths traveled by young men in claim work none probably has proved more uniformly unfortunate in its results or more far-reaching in its effects than has the use of intoxicating liquors.

Far too often has indifferent and generally unsatisfactory service followed hard upon the heels of this formidable obstacle to success. Again and again has it stamped "failure" across the careers of many otherwise successful claim investigators of the past. From a purely business point of view, stripped of all sentiment, the subject is a proper matter for careful thought upon the part of every young man engaged in claim work, whether it be as investigator, inspector or adjuster.

## Use of Liquor Detrimental in Claim Work.

Given a vacancy in the claim department of the average street railway company, with two men eligible for promotion, one known to be a drinking man, the other temperate, the prediction is a safe one that in nine times out of ten preference will be given to the latter man.

And it is right and proper that such should be the case. Railroadng and the use of intoxicating liquors never have successfully gone hand in hand, and never will. This applies with equal force to that branch of railroadng which comes within the scope of the claim department. The fact cannot be denied that in claim and accident work the temperate man has a distinct advantage over the intemperate one.

The theory is timidly advanced, occasionally, that a moderate amount of drinking is necessary in claim work in order to secure results. Such a claim is not justified by experience and is wholly without foundation in fact, arguments to the contrary notwithstanding.

It is upon this very point that some investigators entertain mistaken ideas regarding claim work. In their earnestness to show results from their labors they apparently see no harm in resorting to the use of liquor in order to pave the way to the securing of a statement, or of a release. Would they but devote a little careful thought to the matter they could not but realize that signatures obtained under circumstances such as these are of little practical value. More often than not they possess a "boomerang" attachment that reflects but little credit upon the principals, when the real facts are given publicity.

Taken in its best light, an advantage gained in this way has but a temporary, uncertain, doubtful value. Neither the company nor the investigator derives any permanent good from such work. It is indeed difficult to understand the foundation for such a theory as this. To one who has the best interests of claim work at heart rather the reverse would seem to be true.

Many a well-meaning investigator of the past has made strenuous efforts to be a "good fellow," imagining the while that he was acting in the best interests of the department, when as a matter of fact he really was playing the part of a bright and shining "mark" for the other side. The methods of 20 years ago in claim work have outlived their usefulness.

The investigator should bear ever in mind the fact that the success or failure of matters involving the possible expenditure of thousands of dollars depends directly upon the intelligence and faithfulness with which he performs his portion of the work. His is the task of laying the foundation for the proper investigation, and defense if necessary, of such matters as are entrusted to him. Upon the facts as gathered by him will depend the company's future course. If he fails, and his work proves defective, irreparable damage to his employer's interests, as well as to his own, follows as a natural result.

The question may be asked in all fairness: "Of what value to an aggressive, up-to-date claim department is an investigator who crawls into the office 30 minutes late in the morning, with a hand that is shaky, an eye that is shifty, a manner that is listless and a brain that is dulled?"

It is well for the investigator to recollect that the straight road to success in claim and accident work is only found and followed by the aid of a clear mind and a sound, healthy body, both of which enable their possessor to work under high tension without breaking down in some vital direction. Also, that the head of the average claim department doesn't knowingly entrust the investigation of the company's accidents to investigators who are erratic and unreliable through the use of liquor. The keenest, most successful investigators and inspectors invariably are temperate men. They possess that invaluable quality of reliability so much sought by the heads of departments. Hence it easily follows that the most important cases are assigned to men of this type.

An instance of just the reverse, witness the humiliating predicament in which an investigator found himself some years, ago, while engaged upon the investigation of a serious collision of cars.

At the close of the day's work he chanced to meet certain friends. Liquor was indulged in and, in the natural course of events, discretion was thrown to the four winds. With a cheap imitation of good-fellowship in possession of his befuddled brain, he proceeded to take the entire party into his confidence, entertaining them with a recital of the details of the accident which had been under his investigation.

Apparently his friends were deeply interested in his narrative, for they were observed to make frequent notes of his remarks. They furthermore availed themselves of his kind offer to examine his papers, in order to substantiate certain of his claims. As a natural result of his stupidity an avalanche of claims descended upon his company the following week, the clues to claimants having been secured as above described.

The instance is not cited in the light of a "horrible example," but rather as a typical illustration of the actual results obtained by more than one young man in claim work in the past, in his efforts to achieve results via "the down and out route." An unbridled tongue can hardly be reckoned as a valuable asset in claim and accident work.

Some years ago a young man was admitted to the claim department of a steam railroad system located in the middle west who gave promise of developing into valuable timber for the department. Upon the morning of his first day in the office he was directed to appear before the head of the department for further examination. The examination was brief, to say the least.

"Young man," said he, "do you drink?"

"I do not, sir."

"Very good. Just remember that I will attend to the drinking for this department."

Each proved true to his word. One traveled east, the other west. The investigator of several years ago is today assistant general manager of the entire system.

As a cold, hard, business proposition, the use of intoxicating liquor has proved detrimental in every way to the best interests of the young man in claim work, whether he be investigator, inspector or adjuster.

## THE BROADWAY CAR HOUSE OF THE INTERNATIONAL RAILWAY COMPANY.

BY THOMAS PUMFREY, ENGINEER.

Although the rolling stock of the International Railway Company of Buffalo, N. Y., has kept pace with its rapidly growing traffic, the company's car house facilities were inadequate until recently, despite the fact that a newly built car house at Cold Spring greatly increased the capacity for housing cars. A description of the Cold Spring structure was published in the Electric Railway Review of July, 1906. It is not surprising, therefore, that the International Railway Company has found it necessary to erect during the past year another car house which will hold 108 cars, each 46 feet long, with an open storage yard along the south side of the building which will accommodate 135 cars, each 46 feet long, over which an extension of the car house will be built at some future time. A total storage capacity of 243 cars will therefore be available at the new station.

As important division headquarters for the Buffalo lines are centered in this car house, it is provided with offices, and

built by the Pennsylvania Steel Company, and is paved with block stone. All the special work on the property is 60-pound T-rail, guarded, and paved with old common stone. The straight rail over the inspection pits is 9-inch girder Lorain Steel Company's section 94-313. The rail in the west section of the building is 60-pound A. S. C. E. and that in the storage yard is old 6-inch girder rail turned backward.

The track throughout the house is level and there is a uniform height of 18 feet to the bottom of the roof trusses. The track spacing over the pits is on 11-foot centers, that in the west half of the building 10-foot centers and the storage track in the yard has 10-foot 6-inch centers.

### Structural Features of the Car House.

All foundation walls are of concrete, projecting 6 inches above grade. Those in the storage half of the building are 4 feet deep and in the pit end they are 5 and 9 feet deep. The pit walls, floors and piers are all concrete; also all floors except in the office and the trainmen's room. The office floor is of 1½-inch maple and that of the trainmen's room is iron-spotted buff brick.

All roof trusses are spaced 17 feet 6 inches centers and



Broadway Car House, Buffalo—Front End of Car House.

a trainmen's room for the traffic department; also a heating plant, storerooms, oilrooms, etc.

### General Dimensions and Track Arrangement.

The property on which this car house is located has a total length of 698 feet 4 inches fronting on Broadway with a uniform width of 270 feet 8 inches extending back to Stone street. The car house is 561 feet long and has a total width of 148 feet. It is divided longitudinally into two equal bays, each 56 feet wide, with the offices and storerooms, 32 feet wide, running along the Broadway front. The car house is also divided transversely by steel rolling fire doors, thereby separating the building into four sections, so that a fire may be confined to any one section. A driveway from Broadway in the center of the building would allow the ready entrance of fire fighting apparatus to all sections of the building.

Cars enter the house at the east end, pass over the pits where they are inspected and cleaned and then pass to the storage tracks in the west end of the house ready for service.

The special track work from the street to the property line, also the crossover in Broadway, is 9-inch girder work,

are carried on brick piers 2 feet by 2 feet 8 inches in size. These piers all have cap stones and two binder blocks 12 inches thick. The brick wall between the piers is 8 inches thick and all dividing partitions are carried up as fire walls 3 feet above the roof and are capped with 8-inch glazed tile coping.

The roof is constructed of 6 by 12 inch and 4 by 12 inch yellow pine purlins and 2-inch matched hemlock roof plank with a roofing of 5-ply felt and ¼ inch of actinolite. The gable ends of the building and also the gables over the steel rolling doors in the center of the building are filled in with expanded metal and cement plaster 1 inch thick. The lantern skylights on the roof are all made with structural iron frames covered with No. 24 galvanized iron; the glass is ¼ inch, ribbed in sheets 18 inches wide by the full length of side pitch of skylight. All the side sashes in skylights are pivoted and operated in groups from the side walls near the floor.

Lighting and ventilating car houses by means of a lantern skylight has been found very satisfactory, the car house being well lighted, with practically no dark corners. The general lighting of the car house at night is provided for by six

50-candlepower incandescent lamps placed on the bottom of each truss and controlled from a switchbox on the side walls of the building. All lighting wires are run in metal conduit and the lamps are hung from condulets.

The building is inclosed at each end and divided in the

The drainage of the floor of the car house and of the large inspection pits is provided for by grading the floors to a concrete gutter 12 inches wide across the pits and car house floor. This gutter is connected at one end to the sewer by means of a 4-inch iron pipe projecting 4 inches above the

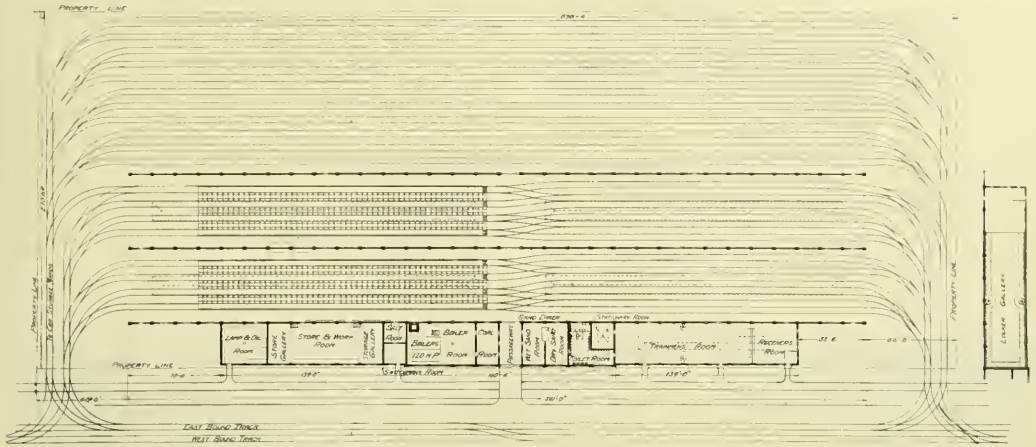

Broadway Car House, Buffalo—Plan Showing Arrangement of Rooms, Buildings and Yard Tracks.

center by steel rolling doors made by the Kinnear Manufacturing Company, Columbus, O. These doors vary in width from 14 feet to 28 feet and are 15 feet high. They are fitted

bottom of the gutter, thus allowing all dirt to settle so that only the water is carried into the drains.

The trench is covered with ½-inch perforated wrought-



Broadway Car House, Buffalo—Interior of One Bay Looking Toward Front.

at the top with trolley wire hangers, which allow the car to enter or leave the building without removing the pole from the wire. Each set of doors across the building at the ends and in the center is raised and lowered by a 3-horsepower motor, each door being raised by a friction clutch and a forged link chain.

iron plates in long sections. There are small concrete catch basins with wrought-iron covers in the oilroom, boiler room, pump pit and toilet rooms. All drains under the inspection pits or office and workrooms are standard cast iron. The toilet fixtures are more substantial and better ventilated than those usually found in a car house. All fixtures are J. L. Mott's

colonial earthenware. There are four separate wash basins, two blue enameled sinks and one earthenware slop sink. In the east end of the trainmen's room is a porcelain drinking fountain fitted with a crystal stream nozzle; with this nozzle it will not be necessary to use cups.

The city water main in Broadway is tapped twice—with a 2-inch pipe for general purposes and with a 4-inch pipe exclusively for fire purposes.

The stand pipes are of 2-inch wrought-iron pipe, galvanized and fitted with Chicago hose valves and 50 feet of unlined linen hose on an improved hose reel.

#### Pit Construction.

The pits are what is known as open construction, it being possible to pass from under one track to another. They vary in depth from 4 feet 9 inches to 5 feet below the top of the rail. The walls are of concrete 12 inches thick and the piers of concrete 12 by 16 inches in size with an extra width for footing of 6 inches all around. There are placed in these piers anchor bolts for holding the rail down, hooks for supporting the radiators,  $\frac{3}{4}$ -inch conduit for running the lighting wires

by placing five  $\frac{3}{4}$ -inch hose connections across each end of the pit and across the center, brought up alongside the piers to the top of the rail.

About the center of each pit will be placed 6-inch hinged rails in each track to allow the ready removal of wheels, armatures, etc., these being lowered by using telescopic hydraulic motor lifts. A  $1\frac{1}{2}$ -ton electric hoist, supported by a roof truss which has been reinforced for carrying the extra load, is located directly over these hinged sections of track. This hoist will be used to carry heavy material to any track on which cars are being repaired.

The details of the track pits and track construction are nearly identical to those in the Cold Spring car barns, which were described on page 404 of the Electric Railway Review for July, 1906. The exterior elevations of the new car barns are also similar to those of the Cold Spring barns, and reference to the article mentioned will also show the details of the Kinnear rolling steel doors and the hinged posts at either end of the structure.

Steam for heating the pits, offices and workrooms and for drying sand is supplied from a boiler plant consisting of two



Broadway Car House, Buffalo—Trainmen's Quarters.

and a  $\frac{1}{2}$ -inch twisted steel rod in each corner of each pier. The rail is supported directly on top of piers and the walk between tracks is made of  $\frac{3}{8}$ -inch checker plate 36 inches wide, supported on 4 by 4 by  $\frac{5}{8}$ -inch angles attached to the rail, the walk being 4 inches below the top of the rail. The pits are heated by colonial wall radiators of 7 square feet heating surface, placed on two sides of each pier. These are supplied by steam mains carried under the checker plate walk. The return pipes carrying condensation from the heaters are placed in 4 by 6 inch concrete trenches at the back of the piers. These trenches are covered with  $\frac{1}{4}$ -inch checker plates.

The pits are lighted by 16-candlepower lamps placed on two sides of the piers between the heaters and the rail base. All wires are lead covered, run in  $\frac{3}{4}$ -inch conduit, through piers to cast-iron junction boxes in the floor at various points, where they connect and then run to switch boxes on the brick wall of the car house above the main floor. Access to the pits is by steps at each end of each track, made of  $\frac{1}{2}$ -inch plate stringers and checker plate treads.

Water supply for car washing over the pits is provided for

120-horsepower boilers, which can be used separately or together, as the severity of the weather demands. All condensation is returned to the boilers by two pumps located in a pumproom 9 feet below the boiler room floor. Fresh water is also supplied to the boilers through these pumps.

#### Storeroom.

A storeroom 32 by 36 feet in size has been conveniently located to the inspection pits and is used for a workroom and storage for repair material.

There are also two galleries, one at each end of the room, used for storing sashes, stops and other materials which are used on the cars only in winter. These galleries are reached by an iron stairway. There are also placed near this room 48 metal lockers made by the Merritt Company of Philadelphia, which are used by the repair men. A small direct-driven lathe, placed in this room, serves for truing commutators, axles, etc.

The oilroom has been placed near the east end of the building on the Broadway front and is thoroughly fireproofed.

It is fitted with metal lamp racks and barrel stands; also apparatus for testing electric headlights.

Sand is delivered to the wet sandroom located near the center of the building and there dried by a steam coil drier made of about 2,000 feet of 1-inch pipe heated with steam at boiler pressure. This drier is taken care of by the fireman who tends the boilers.

**Offices and Trainmen's Quarters.**

As this car house will form important division headquarters, accommodations have been provided for a division superintendent, receivers and trainmen.

The trainmen's room is 31 by 105 feet in size. An illustration of this room is presented. The locker gallery around this room is of iron and concrete construction, reached by two spiral stairways, one on each side of the room. This gallery is provided with 215 metal lockers 12 by 12 feet square and 60 inches high. They are all numbered consecutively and have Yale & Towne key locks, all of which can be opened by one master key.

These rooms are heated by floor radiators, 26 inches high, placed under the windows, supplied from a steam main under the roof trusses, with return pipes under the brick floor in split tile. General lighting is effected by 50-candlepower lamps suspended from the bottom of the roof trusses and the under side of the locker gallery. There are pool tables, card tables, writing and reading tables, seats, etc., in this room. All windows, except in the division superintendent's office, are glazed with translucent glass and the windows of the office are protected by outside iron grilles.

The car house and offices as described were designed and built under the charge of the writer, reporting to T. W. Wilson, general manager of the International Railway Company.

**CALIFORNIA TYPE CARS BUILT AT OAKLAND.**

In the 12 months following the time of the earthquake at San Francisco the Oakland Traction Company built in its

sills of I-beam section extending from end to end, and four wooden sills, the outer of which are reinforced by 1/2 by 8 inch steel plate. The over-all length of the car is 48 feet 5 inches and the width 8 feet 9 1/2 inches. A car of this type seats 52 passengers.

For this type of car body in city service each of the two trucks is equipped with two GE-70 motors with a gear ratio of 64 to 22. Straight air brake equipments are used and K-6 platform control. The cars complete weigh 38,000 pounds each.

**DATES AHEAD.**

- New England Street Railway Club. Next meeting, Boston, Mass., April 22.
- Iowa Electrical Association. Next meeting, Des Moines, Ia., April 22 and 23.
- Iowa Street and Interurban Railway Association. Annual meeting, Des Moines, Ia., April 23 and 24.
- Missouri Electric Light, Gas and Street Railway Association. Annual meeting, St. Louis, Mo., April 23, 24 and 25.
- Fox River Valley Railway and Lighting Association. Next meeting, Fond du Lac, Wis., April 25.
- Nebraska Electrical Association. Next meeting, Omaha, Neb., May 4 to 9.
- Southwestern Electrical and Gas Association. Annual meeting, El Paso, Tex., May 7, 8 and 9.
- Ohio Society of Mechanical, Electrical and Steam Engineers. Next meeting, Columbus, O., May 15 and 16.
- Oklahoma Electric Light, Railway and Gas Association. Annual meeting, Guthrie, Okla., May 25, 26 and 27.
- Canadian Electrical Association. Next meeting, Toronto, Ont., June 10, 11 and 12.
- American Society of Mechanical Engineers. Spring meeting, Detroit, Mich., June 23, 24, 25 and 26.
- American Institute of Electrical Engineers. Annual meeting, Atlantic City, N. J., June 29 to July 2.
- Street Railway Association of the State of New York.

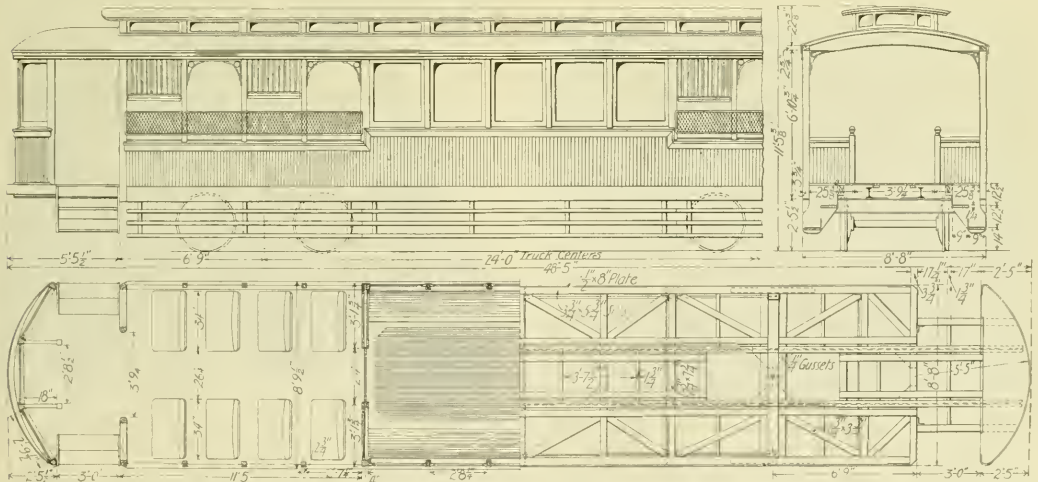

**Oakland Cars—Side, End and Plan Views of California Type Car for City Service.**

Emeryville shops 100 cars complete, with the exception of the motors and brake equipments. A type of city car, of which 20 with their trucks have been built in these shops, is illustrated by the accompanying side elevations, sections and plan views. This car is of the part open and part closed type which has been found especially satisfactory for operation in the California climate.

The underframing of the car comprises two steel center

Annual meeting, Niagara Falls, Ont., June 30 and July 1.

Michigan Electrical Association. Annual meeting, Grand Rapids, Mich., August 18 to 21.

The Chicago City Railway placed 40 new pay-as-you-enter cars in operation on the State street line on Sunday, April 12. The company now has 265 of this type of cars in service, 125 on the Cottage Grove avenue line and 100 on Indiana avenue.

## POWER GENERATING AND DISTRIBUTING SYSTEMS OF THE UNITED RAILWAYS COMPANY OF ST. LOUIS.\*

BY E. D. SMITH, SUPERINTENDENT.

The United Railways Company of St. Louis operates 456½ miles of track, of which 350 miles are in the city proper and 106½ miles in St. Louis county adjoining. Approximately 1,000 cars are operated on these lines during the period of heaviest traffic. Of these cars approximately 960 are operated on the city lines, the remainder on the different county lines. The current required to handle the maximum load is about 70,000 amperes at 600 volts, or 42,000 kilowatts. Of this power 13,000 kilowatts are purchased from the Union Electric Light

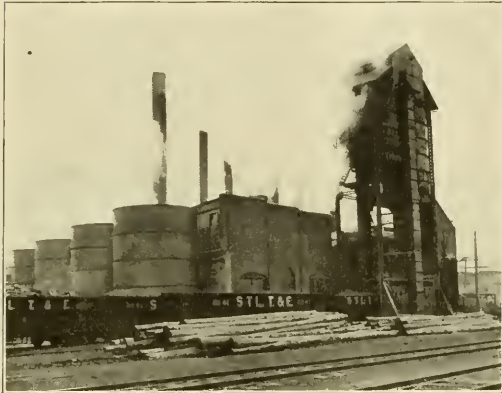

United Railways of St. Louis—De Hodiament Power Station.

& Power Company and transformed in our substations, the remainder being generated and transformed in our power and substations.

### Generating Equipment.

The power-generating equipment of the United Railways Company, exclusive of power purchased, consists of three stations containing direct-connected engine-driven generators, both alternating and direct current. A general description of these stations individually will perhaps be the most appropriate method of bringing out the different features of each. I shall consider them in the order of their capacities.

The "central" power station is located at Park and Vandeventer avenues. This station is entirely a direct-current station. It contains four 2,250-kilowatt 600-volt generators, direct connected to 36 and 70 by 60 inch cross-compound condensing engines; two 1,500-kilowatt 600-volt generators, direct connected to 32 and 62 by 60 inch cross-compound condensing engines; and one 600-kilowatt booster, direct connected to one 22 by 42 inch twin engine.

This station has two boiler rooms, one boiler room containing 16 (4,000 square feet) O'Brien water tube boilers, equipped with Green traveling chain grates; the other boiler room containing eight (3,000 square feet) and six (3,500 square feet) Stirling boilers, equipped with Hawley down-draft furnaces.

A cooling tower installation is found in connection with each station, inasmuch as it is necessary to take water from the city mains in each instance. This installation of cooling towers is one of the largest, if not the largest, in the country. It consists of 12 Worthington cooling towers, each 20 feet in diameter, 32 feet high, and having a capacity of 28,000 pounds of steam per hour, giving a total cooling tower capacity of 336,000 pounds of steam per hour. The system is guaranteed to handle this amount of steam and maintain a vacuum of from 22 to 26 inches. The condensing plant is equipped with one 45-inch and one 36-inch Worthington jet condenser, the two condensers and their hot wells being equalized. The water in the condensing plant is handled by six 16-inch centrifugal pumps, direct connected to slide valve engines, the exhaust steam from these engines being used in the heaters for heating the feed water.

The electrical equipment of this station is Westinghouse

throughout. The engines were built by the Fulton Iron Works of St. Louis.

Coal and ashes are handled by the McCaslin pivoted bucket conveyor, which has a capacity at normal speed of about 70 tons an hour. This conveyor is so installed that coal and ashes may be handled simultaneously, the handling of one not interfering in any way with the handling of the other, the coal being dumped into the bunkers before the conveyor descends into the basement to take up the cinders.

The switchboard in this station is located in a separate room above and to the north of the engine room, the operator being able, when at the machine board, to view the entire engine room.

The "Northern" power station is located at Second and Salisbury streets. This station contains two 2,250-kilowatt 600-volt direct-current generators, direct connected to 36 and 70 by 60 inch cross-compound condensing engines; two 1,200-kilowatt 6,600-volt three-phase 25-cycle alternators, direct connected to 28 and 54 by 60 cross-compound engines. Two 800-kilowatt direct-connected simple units are now being installed in this station.

The boiler equipment of this station consists of 16 (4,000 square feet) O'Brien water tube boilers, equipped with Green traveling chain grates.

This station is also equipped with a condenser and cooling tower installation, the cooling towers in this case, however, being located on the roof of the building. The condenser equipment consists of two (10,000 square feet) Wheeler surface condensers, the condensing water being handled by two compound single-acting Blake pumps, having steam cylinders (14 and 24 by 24 inches), with a 30 by 24 inch water cylinder. The cooling tower equipment in this installation is of the Barnard type. There are four towers, each 36 feet 3 inches high, 26 feet 4 inches long and 15 feet 3 inches wide, having an individual capacity of 27,000 pounds of steam per hour, making a total cooling capacity of 108,000 pounds of steam per hour, which quantity of steam the system is guaranteed to handle and maintain from 22 to 26 inches of vacuum.

The electrical equipment of this station is General Electric throughout. The engines are of Fulton Iron Works make. There are two separate exciter sets for the alternators, one being driven by a 600-volt direct-current motor; the other is induction motor driven.

The coal storage plant in this station is across the street from the power station proper, being connected by a bridge



United Railways of St. Louis—Spring Avenue Substation and Emergency Station.

some 60 feet above the sidewalk, through which the coal conveyor runs and delivers coal into the bunkers over boilers. The coal conveyor in this case is also of the McCaslin pivoted bucket type, being notable, however, for its length. Its total length is 1,320 feet.

The "De Hodiament" power station is located at Maple and Hodiament avenues. This station is the last power station acquired by the United Railways Company, being formerly the power station for the St. Louis & Suburban Railway system, which system was taken over by the United Railways Company, January 1, 1907. The station contains three 1,200-kilowatt 6,600-volt three-phase 25-cycle alternating-current generators, direct connected to 30 and 50 by 60 inch cross-

\*Abstract of paper read before the St. Louis section, American Institute of Electrical Engineers, April 8, 1908.



compound engines; four 800-kilowatt 600-volt direct-current generators, direct connected to 32 by 60 inch simple engines.

The boiler plant at this station consists of 15 (4,000 square feet) O'Brien water tube boilers, equipped with the Jones under-feed stokers.

When this plant was acquired it had been operating as a non-condensing plant. We at once began the necessary preparation and now have a cooling tower and condenser installation practically completed. This condenser plant consists of one Alberger centrifugal condenser, having a 54-inch exhaust steam connection, the water from which is handled by one 24-inch centrifugal pump, driven by two Westinghouse high-speed engines, operating at 250 revolutions per minute. The cooling tower installation consists of four Alberger cool-

enue and North Market street. This station contains four 1,000-kilowatt 600-volt six-phase rotaries, with room for two additional rotaries of the same capacity. It also has in connection a battery room, together with space for the necessary apparatus, such as a booster, etc.

This is the last station we have erected, having been in operation only about five months, and so far as our present experience is concerned, seems to give us the best layout for a combination rotary and battery station. The transformers are placed on a balcony. This enables us to transfer the air chamber and high-tension bus compartments from the basement to the first floor, leaving the basement to be used entirely for battery purposes. All the apparatus in this station is of General Electric make, the auxiliary apparatus being practically the same as before described. This station is built in connection with a trouble station, above which are living apartments for the station operators.

The "Delmar" substation is located at Delmar and DeBaliere avenues. This station contains four 600-kilowatt 600-volt three-phase rotaries and one 500-kilowatt 600-volt six-phase rotary, there being three single-phase transformers for each rotary. This was the first railway substation built in the city of St. Louis and was built entirely after General Electric methods. However, the layout of the station has been almost entirely changed since its installation, owing to changes in intercollecting alternating-current lines, and also to take advantage of improvements that have been made from time to time as regards apparatus and arrangement. The auxiliary apparatus in this station is also practically the same as has been previously described.

In St. Louis county we have three small substations, namely, Brentwood substation, containing two 600-kilowatt rotaries; Creve Coeur Lake substation, which is situated on the bank of the lake of this name, containing two 500-kilowatt rotaries; and Ramona substation, located near the lake of this name, containing two 300-kilowatt rotaries.

**Portable Substation.**

For several years we have found it inconvenient to handle the traffic on some of the long lines at infrequent intervals. This difficulty we formerly attempted to get around by boosting the direct current; but as this is a very inefficient method and is always attended with some difficulty, we concluded to build a portable substation, in order that it might be located at the center of these loads when needed, thereby enabling us to maintain a good voltage and operate the cars on schedule time.

This substation contains one 600-kilowatt 600-volt three-phase rotary, three single-phase transformers, together with



United Railways of St. Louis—Creve Coeur Substation.

ing towers, having a capacity of 50,000 pounds each, or a total capacity of 200,000 pounds of steam per hour. Handling this amount of steam a vacuum of 25 inches is guaranteed.

All electrical equipment in this station is of the General Electric type, the engines being of three different types, namely, Fulton Iron Works, Allis-Chalmers and Hamilton. The coal and ashes in this plant are handled by a Link Belt pivoted bucket conveyor in connection with a Link Belt gravity discharge elevator, it being arranged so that coal and ashes can be handled simultaneously.

**Substations.**

In the order of their capacity the different substations will next be described:

The "Central" substation is located at 1711 Locust street, near the heart of the downtown district. It contains eight 1,000-kilowatt 600-volt six-phase rotaries; also one 5,000-ampere-hour storage battery. The air-cooled transformers for the rotaries are three to six phase. The rotaries are all started from the alternating-current side, one-third and two-thirds voltage taps being made on the secondary side of the transformers, thus doing away with synchronizing and making the cutting in of machines a quick and simple task. The storage battery was built by the Electric Storage Battery Company and consists of 588 type G-77 cells. All other apparatus is of General Electric make.

The alternating-current feeders are all equipped with overload relays, which are set to trip the oil switches at about 5,000 kilowatts. The alternating-current rotary panels are also equipped with overload relays, set to trip at about 3,000 kilowatts. The overload breaker on the direct-current rotary panel is equipped with an auxiliary coil, which serves as a low-voltage release, and also, by means of an electrical connection with a speed limit device on the rotary shaft, serves to cut the rotary out on the direct-current side in case an excessive speed is reached. These speed limits are set to trip at about 10 per cent increase above normal speed.

The "South Broadway" substation is located at 4041 South Broadway. This station consists of four 1,000-kilowatt 600-volt six-phase rotaries and one 600-kilowatt 600-volt six-phase rotary. The auxiliary equipment is practically identical with that just described. All apparatus in this station is of General Electric make.

The "Spring Avenue" substation is located at Spring av-



United Railways of St. Louis—Spring Avenue Substation.

the necessary auxiliary apparatus. The voltmeters and ammeters are so mounted that they can be easily disconnected and packed in a box of waste, which is kept in the car for this purpose. This was done because it was found that in jolting the car over special work the instruments were very liable to get out of order.

This station consists of two cars, the car containing the rotary being equipped with four 50-horsepower motors, and the transformer car being hauled by this motor car as a trailer. Both cars are equipped with air brakes, and on account of the weight carried are built exceptionally strong and substantial, having steel framing throughout.

This station has given excellent results. For instance,

one section on which we have experienced considerable trouble is the section extending south from the city limits to Jefferson barracks, a United States military post. Only once each year is there a heavy load on this section, this occurring on Decoration day, when the G. A. R. and other kindred organizations of the city visit the National cemetery, which is located at the barracks. No matter what arrangement of direct-current boosting we have tried, we have always, before the day was over, gotten into some kind of trouble. The result was a pile-up of cars on this section, which we found ourselves unable to take care of. Last year, however, being the first time we used this portable station, cars were run at 1-minute intervals and were operated on schedule time throughout the entire day.

Another location at which this station is used is on the Meramec Highlands line, Meramec Highlands being a pleasure resort situated on the Meramec river, a considerable distance from any power station or substation, and hence its load was hard to handle properly. This load occurs only on Sunday afternoons during the summer season and it was not thought practicable to build a permanent station. The portable station is run out on this line every Sunday morning during the summer, started at about 1 p. m., and run throughout the afternoon and evening, and since this has been done absolutely no trouble has been experienced on account of weak power.

**Trolley Feeders for Alternating-Current Transmission.**

I might also add that the operation of this portable substation, contrary to what you would probably expect, requires no extra copper in the way of transmission line. The trolley



United Railways of St. Louis.—Portable Substation in Two Cars.

taps are taken off a part of the direct-current feeders, which are mounted on high-tension insulators. They are used as alternating-current feeders when the station is operating and by a system of switches in the originating station used on the direct-current bus when the portable station is not in service.

It might be mentioned also that we recently found a use for this portable station which we did not anticipate when building it. Some six weeks ago we had a bad short-circuit on a field in one of the direct-current generators at Hodiament station. The direct-current end of this station being heavily overloaded on the peak, it was almost imperative that some relief be obtained. The portable substation was stored in a car shed, some two miles from the power station, and had not been used for six months. However, it was ordered to the scene, and with the aid of the line department some taps were made on adjacent high-tension feeders, and in less than two hours the 600-kilowatt substation was standing in the street in front of the power house doing the work of an 800-kilowatt direct-current generator.

**Distributing System.**

The entire distributing system is divided into feeder sections, each station having a separate panel on the switchboard. A very careful record is kept of the sections, so that the operator in each station knows exactly what sections he is pulling and what section to pull out in case of fire or other trouble. These records are kept in blueprint form, so that any changes made by the wire department can be promptly noted and a corrected sheet inserted in the file.

The alternating-current distributing system, while perhaps not out of the ordinary, is somewhat unusually but advantageously arranged, to afford flexibility of operation between

generating and substations. It is possible, by the proper manipulation of switches and the proper sectionalizing of the alternating-current busbars in the different substations to supply power to any of our substations (with the exception of South Broadway) from any one of three generating stations. Also, owing to the construction of the alternating-current busbars in the different substations (sectionalizing switches being inserted in the bus between each rotary), it is possible to operate one substation from either one, two or three generating stations at the same time. This flexibility of operation has frequently proven itself very convenient, especially when it is taken into consideration that we purchase a considerable portion of our power from the Union Electric Light & Power Company, and under the terms of this contract cannot exceed a certain maximum demand of 1,139 amperes at 6,600 volts, or 13,000 kilowatts. Inasmuch as the peaks on the downtown stations do not occur at the same time as those in the outlying stations, we are enabled to materially ease off the peak that must be handled by our own generating stations and at the same time not exceed the critical peak on the Union Electric Light & Power Company's station.

All of our underground alternating-current feeders are triple conductor No. 0000 lead-covered cable, tested to 20,000 volts pressure. Cables are guaranteed to transmit 2,400 kilowatts continuously at unity power factor. On one occasion, however, when we had two cables out of commission on account of electrolysis, one of these cables carried 5,000 kilowatts during the evening peak. This feeder is known as No. 30, and I think the switchboard panel is still decorated with the blue ribbon which the boys put on after the cable had given this efficient service.

**Electrolysis.**

Although at one time we did have considerable trouble from electrolysis, since the proper precautions were taken we have not had any trouble at all. This electrolytic action is caused by some of the return current leaking from rails to cable along the line where cable run parallels or crosses a car line, and then leaking off the cables onto the rails near the substation. To prevent this latter leakage we have installed a negative or ground wire in a vacant duct in the cable run. This wire is connected to the negative bus at the station and to the lead sheath of cable at each manhole, and runs out far enough to carry the leakage current off the cables. In order to keep in touch with the situation an electrolytic survey is made about every six weeks or two months. Readings of the potential between cable sheath and rails are taken at each manhole, and the result of the survey is then plotted in the form of a curve.

**Performance of Equipment.**

The following data on performance may be found of particular interest:

**Coal.**—Screenings, which is usually nut, pea and slack, runs about 30 per cent fixed carbon—about 7,500 British thermal units per pound of coal. Mine run coal runs 40 to 42 per cent fixed carbon, and approximates 10,000 British thermal units per pound of coal.

Coal burned approximately as follows:

Central power station ..... 15,000 tons per month  
 Northern power station ..... 10,000 tons per month  
 Hodiament power station ..... 9,000 tons per month

Pounds of coal per kilowatt-hour are from 6½ to 9. Cost to put coal on Green chain grates approximately 15 cents per ton. Ratio of grate to heating surface, 90 to 4,000 = 44.

**Battery Boosters.**—No regulator used. Straight shunt field connected from station bus. Differential rheostat in series with field; permits field to be built up in either direction for charging or discharging.

**Advantage of Six-Phase Rotaries.**—Better distribution of winding, enabling size of rotary to be cut down. Voltage between phases on three-phase rotary, 380. Voltage between phases on six-phase rotary, 430.

**Batteries.**—Watt-hour efficiency of batteries alone: Battery "A," 69.9 per cent; battery "B," 65.8 per cent.

Watt-hour efficiency of batteries and boosters: Battery "A," 66.4 per cent; battery "B," 62.7 per cent.

Battery discharged about 20 points, running between 1,160 to 1,180 low reading; running between 1,180 to 1,200 high reading.

**Power.**—Used and generated, 3.66 kilowatt-hours per car-mile.

Total kilowatt-hours used in year..... 141,566,170  
 Total kilowatt-hours bought in year..... 42,552,088

Total kilowatt-hours generated in year..... 99,014,082  
**Substation.**—Rotary efficiency, full load, 95 per cent; transformer efficiency, full load, 97 per cent; efficiency of substation and battery, exclusive of transmission, 83 per cent.

ELECTRIC RAILWAYS OF THE DELAWARE & HUDSON COMPANY.

In the report for 1907 of the Delaware & Hudson Company maps and charts are published relating to the electric railway systems owned by the company. The accompanying map shows the electric and steam railroads of the company in Albany and vicinity and Plattsburg and vicinity. The following statement is made in the report regarding the electric lines:

The electric lines furnish a complement to the service provided by the steam railroads; and the full benefit of this is derived when the running schedules of the electric roads are made to conform to those of the steam roads so as to afford the best service possible for the patrons of the respective companies.

The construction of trolley lines, even where paralleling the steam railroads, may materially increase the traffic on the

Although the return to the United Traction Company is equivalent to 3 per cent on the total investment in the securities of the Hudson Valley Railway, it is believed that the results can be materially improved. A considerable amount of betterment work on this line is now under way—additions to the feeder system, additional units at substations, etc.

The Troy & New England Railway owns a valuable franchise in the event that it should, at any time, be deemed desirable to build a connecting line between the Delaware & Hudson tracks and the New York New Haven & Hartford Railroad.

The electric roads operate the following miles of track: United Traction Company, 86; Hudson Valley Railway, 149; Schenectady Railway, 122; Troy & New England Railway, 10; Plattsburg Traction Company, 8.

Other information in relation to individual companies follows:

United Traction Company, Albany, N. Y.—All the franchises are practically perpetual except that of the Capitol Railway, which is for 50 years and expires in 1951. As the tendency of present legislative enactments is to limit the life of franchises, those now owned by the United Traction Company ought to have a constantly increasing value proportionate with the increase in population and the extension of the municipal boundaries.

Hudson Valley Railway, Glens Falls, N. Y.—Each of the constituent companies has practically perpetual franchises, containing the usual clauses and differing only in details, such as paving of streets and local grants. The companies have the right to transport freight, express and mail. While some of the franchises do not state this right, the courts have held such right permissible when not specifically stated to the contrary.

Schenectady (N. Y.) Railway.—A contract was entered into on August 1, 1904, by the Delaware & Hudson Company, the New York Central & Hudson River Railroad and the General Electric Company, whereby the capital stock of the Schenectady Railway was sold and transferred in equal divisions to the two steam railroads, and the General Electric Company guaranteed to the Delaware & Hudson Company, the New York Central Company and the Schenectady Railway the performance of the condition of the agreement by the Schenectady Illuminating Company and the Mohawk Gas Company. The original routes of the Schenectady Railway Company were limited to certain streets in Schenectady. By amendments to its certificate of organization, additional routes were described from Schenectady to Albany, Troy, Saratoga Springs via Ballston Spa, and a route from Green Island bridge through Troy and to other points in Rensselaer county. Certificates of extension were filed by the railway in 1886 and in 1887 to include an extension across the old Mohawk river bridge to Scotia and to Reeseville. Since 1895 a number of certificates of extension have been filed. In 1890 and in 1891 approval was obtained for the use of electricity and all municipal consents obtained subsequent thereto approved and permitted the use of electric power.

Plattsburg (N. Y.) Traction Company.—The village franchise was passed on February 26, 1896, for a period of 50 years from November 20, 1895. The franchise grants rights in the principal streets and has the usual clauses regarding paving between tracks and two feet either side. There is a clause providing that when Plattsburg reaches 20,000 population a percentage of the gross receipts, not to exceed 3 per cent, shall be paid to the trustee of the town.

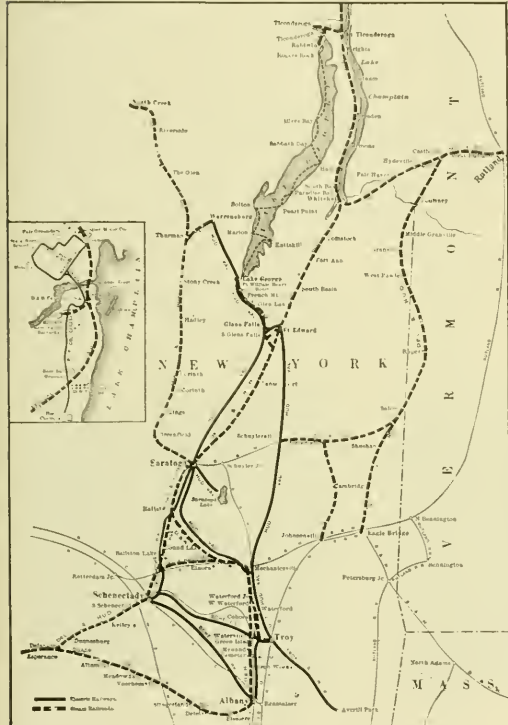

Delaware & Hudson—Railways in Albany and Vicinity.

Comparative Earnings in 1907.

latter. The steam railroads cannot afford to make the frequent stops which are made by the electric lines, and the traffic is mainly new business created by the increased transportation facilities afforded.

In acquiring electric railways this company has followed the example set by other railroad companies; the advantages accruing through the acquisition of the United Traction Company of Albany, the Hudson Valley Railway (owned by the United Traction Company), the Troy & New England Railway, the Plattsburg Traction Company, and a half interest in the Schenectady Railway [the other interest in which is owned by the Mohawk Valley Company on behalf of the New York Central & Hudson River], can best be understood by a study of the accompanying map, showing the relations between these electric lines and the steam railroads controlled by the Delaware & Hudson.

The net income of all of the electric companies controlled by the Delaware & Hudson is equivalent to a little over 4 per cent on their cost to the Delaware & Hudson. The properties may, therefore, be expected to carry themselves, and pay the interest on the investments.

The Commercial and Financial Chronicle of New York gives statistics of earnings for 194 electric railways during 1907. The aggregate gross earnings were \$235,718,432, as compared with \$212,442,906 for the twelve months of 1906. Aggregate net earnings were \$100,526,762, as compared with \$94,778,321. The increase in gross earnings was 10.95 per cent and in net earnings 6.06 per cent. The gross earnings of 31 additional roads are also given. The gross earnings of 225 roads were \$279,023,468 in 1907, as compared with \$254,725,954 in 1906, an increase of 9.54 per cent. There are added to the totals for the calendar year 1907 the results of railways reporting for the fiscal years ended June 30 or September 30, making the total gross earnings of 355 roads \$306,266,315, as compared with \$280,139,044 in the previous fiscal years, an increase of 9.33 per cent. The net earnings of these roads were \$126,002,304, as compared with \$121,150,703, an increase of 4.09 per cent.

### PAY-AS-YOU-ENTER CARS IN NEWARK—PRELIMINARY EDUCATIONAL CAMPAIGN.

The Public Service Railway Company of New Jersey on April 15 put into operation on its Clinton and Broad lines in Newark 50 pay-as-you-enter cars. Later 100 more similar cars will be put in service. Before installing this type of car a campaign of publicity was carried out with a view to affording the public knowledge of the new operating features. The general co-operation of the passengers in having exact fares ready upon the first day was a result.

A detailed description of these cars appeared in the Electric Railway Review for February 15, 1907. There are, however, some operating features that were not decided upon at that time. One of these is the "fare receiver" shown in the accompanying engraving. It is designed somewhat differently from any now in use. The device is made by The J. G. Brill Company and consists of a rectangular wooden box approximately 3 feet 6 inches in height, in the bottom of which is located a money drawer divided into four separate compart-



Pay-As-You-Enter Car in Newark—View of Rear Platform, Showing Position of Fare Box.

ments. On the side of the box nearest to the bulkhead is a semi-circular guide for deflecting the fares into any compartment desired. Before leaving the car at the end of a run the conductor sets the guide for the compartment next to the one he has filled. This arrangement permits of a separate and accurate account of the exact fares accepted by each conductor. The top of the box is of glass, not unlike the fare boxes used on the International Railway at Buffalo. It is designed so that before the coin or ticket is "chopped in" it rests in plain sight of the conductor, allowing an inspection to detect bogus coins or tickets.

Both cash and ticket fares will be received in the fare box, and to encourage the use of tickets the company has placed them for sale with a number of business houses along the lines of travel at a rate of 20 for \$1.00 or 106 for \$5.00. Transfers are to be handed unfolded to the conductor.

On the day before the cars were put into service an attractive folder, descriptive of the operation of the cars, was distributed to the passengers on the cars of the Broad and Clinton lines and to each residence along these lines. In addition to the circulars and advertisements in the papers,

Newton W. Bolen, superintendent of transportation, accompanied the press representatives on a trip of inspection on Tuesday afternoon, April 15, as a result of which several articles appeared in the morning and afternoon papers.

In connection with the operation of the new cars the motormen and conductors have been very thoroughly instructed. After one week of instruction and demonstration lists of 11 questions for the motormen and 34 for the conductors were asked. By pursuing this method of examination it was found just what details required further demonstration.

The following extracts from the lists of questions for the examination of motomen and conductors should be of considerable interest to officials who contemplate putting this type of equipment into service:

#### Questions for Conductors.

When it becomes necessary for the conductor to leave car how will he proceed?

What is the rule in regard to leaving car alone at any time?

Would you allow a transfer to be deposited in the fare receiver? How proceed?

In case a counterfeit coin or bogus ticket is deposited in the box how would you proceed?

Will the reporting of transfers be the same as at present?

In the event of a passenger boarding car without the correct change how proceed?

Is it necessary for a conductor to watch the money and tickets deposited closely?

Is it necessary to trip the box for every fare collected?

Are transfers issued the same as at present?

Passengers riding to end of line and wishing to return, how proceed?

Are passengers allowed to remain on the rear platforms? Is it necessary to examine car, especially push buttons and signal bells, before leaving car house?

How many bells give motorman to come to rear platform case conductor is compelled to leave car?

How proceed in case you run short of change?

How would you proceed relative to witnesses in case of accident?

Would you request passengers to have exact fare ready and transfer unfolded as they enter car?

If passenger should enter car without depositing fare how proceed?

How would you keep a record of 3-cent fares deposited?

If trolley should leave wire would you replace same while passengers were depositing fares?

Where would you deposit transfer envelopes?

Would it be necessary to signal motorman by a signal bell if passengers had already rung electric bell?

#### Questions for Motormen.

Would you open front exist door before car had come to a full stop?

Would you allow any person to enter car through exit door?

Under what conditions would it be necessary for you to call out "Front way out"?

Between what points are you allowed to use stools?

In case it becomes necessary for conductor to leave car how proceed?

When you receive four bells from conductor what does it mean?

#### Improved Frequency Converter.

A patent has been issued for a frequency converter consisting of two rotary converters mounted on the same spindle. The current to be converted is sent into the slip rings of one of the machines and the direct current produced is then sent into the commutator of the second machine (having a different number of poles), which finally delivers the alternating current of altered frequency. Both machines can be compounded by the direct current produced. Such a converter requires no separate exciter, as does the more ordinary arrangement consisting of a synchronous motor driving an ordinary alternator. Further, the armature reaction and heating are low in both machines, owing to the partial neutralization of the direct and alternating currents, as in the case of the ordinary rotary converter.—The Electrical Engineer, London.

**IMPROVED THIRD-RAIL SLEET BRUSH.**

BY F. J. STEVENS, MASTER MECHANIC.

The Lackawanna & Wyoming Valley Railroad Company is using a new sleet equipment which lately has given very satisfactory service. This road operates 20 miles of double track between Scranton and Wilkesbarre, Pa., using an unprotected top contact third rail. During the four years in which the road has been in operation several methods have been tried for keeping the third rail clear during snow and sleet storms. The sleet is the more difficult condition to overcome. It is well known that calcium chloride will overcome the sleet difficulty, but to deliver it at the proper time and place has been a knotty problem.

An essential part of the present device is a stiff steel brush  $2\frac{3}{4}$  by 6 by  $3\frac{1}{2}$  inches in size, with a wooden back  $\frac{7}{8}$  by  $3\frac{3}{8}$  by 8 inches in size is suspended diagonal to the third rail. This width of brush has been found sufficient to meet the requirements and its position with relation to the third rail allows for the lateral movement of the truck. The brush is bolted to a piece of iron  $\frac{3}{8}$  by 5 by 8 inches, which is riveted to the support or carrying iron. The iron back is drilled and tapped so that a  $\frac{1}{4}$ -inch pipe may carry the chloride solution to the brush. The brush support is made of 2 by  $\frac{1}{2}$  inch iron. One end extends up through the third rail beam and an adjusting handle; the other outward over the brush. The end extending through the beam is the one which is used to adjust and care for the wear of the brush. A row of holes is bored one inch apart near each edge of this iron, the holes on one edge being started  $\frac{1}{2}$  inch above the other edge. This allows for lowering the brush  $\frac{1}{2}$  inch at a time, which amount has been found sufficient to compensate for the wear. It is through one of these holes that the adjusting handle is bolted to the brush iron. The handle is arranged so that

is made to allow for a short nipple, which is securely bossed in place. A tee is put on this nipple with fittings for  $\frac{3}{8}$ -inch gate valves, the outside of the valves being bushed for  $\frac{1}{4}$ -inch pipe. Over this pipe is slipped a piece of  $\frac{1}{2}$ -inch rubber tubing. The tubing is then passed through a hole in the trap door and to a piece of  $\frac{1}{4}$ -inch pipe fastened by two hangers under and near the edge of the car. The use of pipe is necessary because a hose long enough to reach from the calcium chloride tank to the brush would be in danger of being torn off by the swinging of the truck. Another piece of tubing is used to carry the chloride from this pipe to the pipe leading through the wooden back of the brush. In this way the brush

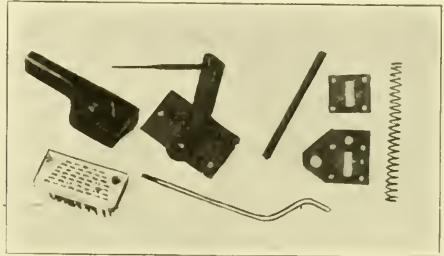

Sleet Brush—Parts.

serves two purposes: (1) That of scraping the rail and (2) preventing the chloride from being blown away, as would be likely with a car running at a high rate of speed.

A brush is carried on each beam, but the head ones only are piped for the chloride. All parts are made from templets and are interchangeable. The adjusting handle is made of



Sleet Brush—Chloride Cans.



Sleet Brush—Lowered.



Sleet Brush—Raised.

when the brush is raised the handle is in a perpendicular position, as may be noted in an illustration.

On the top and bottom of the shoe beam are secured two flat pieces of  $\frac{1}{4}$ -inch iron, in which holes  $1\frac{3}{8}$  by  $2\frac{1}{8}$  inches have been cut to allow the angle iron to pass through and to act as a guide. In the part of the angle iron extending over the brush a hole is drilled and tapped for a  $\frac{1}{2}$ -inch pipe. This pipe extends through the  $\frac{1}{4}$ -inch piece of iron secured to the top of the beam. Against this iron, where it extends past the face of the beam, is a coil spring serving to press the brush against the rail. When the brush is new it has a pressure on the third rail of 38 pounds and when worn down  $1\frac{1}{2}$  inches it has a pressure of 28 pounds. Care should be taken that the spring is not so strong that it will bend the brush.

Sixty-quart milk cans are utilized for the storage of the calcium chloride. These tanks are carried in the front vestibule of a car. On one side of the can near the bottom a hole

wood and with proper care can be used without danger of receiving shocks. A worn-out brush can be removed and replaced in less than five minutes. These brushes as now constructed wear remarkably well and seldom have to be replaced.

**Handling Ashes in Philadelphia.**

The Philadelphia Rapid Transit Company has made a contract for hauling ashes and street dirt at night from the central district of the city to the dumping grounds and has constructed eight special ash cars for the purpose. The city ash contractors have erected a large central dumping station, to which the ashes and dirt are brought by wagons. An inclined wagon road leads from the street level to a platform on the inside of the building, from which the wagon loads are emptied into the ash cars. The station is so constructed that four cars of 21 tons capacity each may be loaded in it at one time.

# News of the Week

## Iowa Street and Interurban Railway Association Programme.

The fifth annual convention of the Iowa Street and Interurban Railway Association will be held at the Savery hotel, Des Moines, Ia., Thursday and Friday, April 23 and 24. The following papers will be read:

"Reinforced Concrete in Electric Railway Construction," N. M. Stark, Des Moines.

"Depreciation," Daniel Royse, Chicago.

"Claims—Handling by Electric Railways," Arthur W. Gross, Omaha.

"Advertising by Electric Railways," general discussion.

"Handling Fares on Interurban Railways," P. P. Crafts, Clinton.

"Interstate Commerce Commission—Statistics and Accounts," C. L. Wight.

L. D. Mathes, general manager Union Electric Company, Dubuque, Ia., is secretary and treasurer of the association.

## Transit Affairs in New York.

The New York public service commission of the first district took action on April 10 which may result in a material change in the plans for the subway loop between the Williamsburg and Brooklyn bridges. The chief engineer was directed to report on the most desirable route for an extension of the Manhattan loop under the East river to Brooklyn, instead of connecting with the Brooklyn bridge at Park Row as at present planned. The chief engineer was also directed to prepare detailed plans for a continuation of the loop through Broadway in Brooklyn in order to connect the bridges on that side. The Manhattan loop connecting the Williamsburg and Brooklyn bridges via Delancey and Centre streets is now under construction, the idea being to run the Brooklyn Rapid Transit Company's elevated trains, which now cross the bridge, through the loop. It is recognized that this route could hardly be successfully operated by any other company, but the Brooklyn Rapid Transit Company has not as yet expressed any desire to bid for the route. By building the Brooklyn portion of the bridge loop it is believed that it could be made independent of the Brooklyn Rapid Transit Company and also divert a portion of the bridge traffic.

On the same day Comptroller Metz sent a communication to the board of estimate advocating the construction of the Brooklyn portion of the bridge loop before beginning work on the Broadway-Lafayette or Fourth avenue lines, in order to have a complete loop which might be operated by an independent bidder in case the Brooklyn Rapid Transit Company failed to submit a bid. Mr. Metz suggested that such a line could be successfully operated for short-haul traffic at a 3-cent fare.

Thomas F. Ryan was called as a witness on April 8 and 9 in a suit brought by two stockholders against the directors of the Metropolitan Street Railway to recover damages for losses alleged to have been sustained through misleading reports issued by the company for the years 1905 and 1906. Mr. Ryan occupied the stand for the greater part of the two days and testified in regard to many of the details of the financial history of the New York street railway companies.

The appellate division of the supreme court of New York on April 10 rendered a decision reversing the decision of a lower court and granting a new trial in the suit of the public service commission to restrain the Interborough Rapid Transit Company from selling electricity.

For some time the New York City Interborough Railway Company has obtained its current from the Interborough Rapid Transit Company through the subway ducts. The question came up as to whether the latter company, under its lease of the subway, could use the ducts for transmitting electricity to be sold to others. The old rapid transit commission, of which the public service commission is the successor, brought suit to restrain the interborough Rapid Transit Company from furnishing and the New York Interborough Railway Company from receiving and using electrical current transmitted through the ducts in question, and asked for an accounting for the reasonable value of such current previously furnished and used. A decision was rendered in favor of the plaintiff in May, 1907. The lower court held that the company's lease gave it the right to operate for traffic purposes only. It is stated that the commission will appeal to the court of appeals.

The Interborough Rapid Transit Company informed the commission on April 11 that a contract had been let to the Rapid Transit Subway Construction Company for the reconstruction of the tracks in the subway between Ninety-sixth

and One Hundred and Third streets, which will relieve much of the congestion caused at present by the crossing of the local and the express tracks. It is proposed to construct new tracks on each side of the present tracks and the Lenox avenue tracks will be carried directly under the Broadway tracks at One Hundredth street.

## Fail to Reach Agreement in Cleveland.

Negotiations between Mayor Johnson and F. H. Goff in the attempt to agree on the valuation of the Cleveland Electric Railway, which were broken off last Tuesday when Mr. Goff refused to accept the valuation of \$50 a share offered by the mayor, were resumed on Saturday, April 11. At the suggestion of Mr. Goff a meeting of the city council was held on Saturday morning, after the Cleveland Electric directors had extended temporarily his power to act for the company.

At the meeting the mayor stated that the only feature of the settlement remaining to be decided was the question of price, all details of the security franchise and the lease to the Municipal Traction Company having been settled. He then repeated his offer of \$50 a share for the Cleveland Electric stock. Mr. Goff then submitted a table showing the differences between his estimate and the mayor's, which amounted to \$22.12, making a total of \$72.12 per share, and offered to compromise at \$60 a share. Mayor Johnson declined to increase his offer and suggested that the matter be discussed by the council.

A public meeting was held on Monday and the councilmen and public were given an opportunity to discuss the subject. Many members of the council advocated a provision for seven tickets for 25 cents in the security franchise and opinion seemed about evenly divided as to whether the mayor should compromise on the valuation. Another meeting was held on Tuesday without changing the situation.

At the regular meeting of the city council on Monday night the Forest City Railway applied for franchises covering several of the most important streets now occupied by the Cleveland Electric Railway, whose franchises expired on that day, according to the city's claim. The application included the Woodland, Lorain, West Madison and Detroit avenue lines, with several feeder lines, comprising an important part of the system.

## Legislation Affecting Electric Railways.

**New York.**—The Robinson bill, which authorizes the public service commission to award indeterminate franchises for the construction and operation of rapid transit routes to private corporations, reserving the right of the city to purchase the property after 50 years, has been reported to the assembly with an amendment.—Senator Travis' constitutional amendment exempting bonds for self-sustaining enterprises from consideration in calculating the debt limit of the city of New York has been passed by the senate. A similar bill has been introduced in the assembly, urged by the Citizens' Union to meet the objection that the bill might allow a franchise to become permanent. This amendment provides that the city may sell the property to another company at the end of 50 years in case it does not desire to acquire the road itself. The bill also increases the term for which a subway built by the city may be leased to an operating company to 35 years.

**Ohio.**—Governor Harris on April 15 signed the Schmidt bill, which was passed by the house last week. The bill provides that franchises on streets occupied by street railways may be granted to new companies or renewed upon the expiration of the original franchises without the necessity of securing new consents of property owners. As amended by the house the bill provides that the action of city councils on franchises shall be referred to a referendum vote upon application of 15 per cent of the qualified voters, and must be approved by a majority of the voters to become effective. Another amendment requires the consents of property owners for an extension of tracks.—A bill introduced by Representative Stockwell, giving municipal councils authority to grant 2-year franchises for street railways without requiring competitive bids for the grants or the consents of property owners was tabled by the house on April 14, with the understanding that it will not be reconsidered.

**American Institute of Electrical Engineers.**—At the next meeting of the Cincinnati section, to be held at the University of Cincinnati, Sebastian Senstius, Triumph Electric Company, will present a lecture on "The Testing of Induction Motors."

**Strike in Pensacola.**—The street railway service of the Pensacola (Fla.) Electric Company has been tied up since April 6 by a strike of the motormen and conductors, caused by a controversy as to working conditions. The company has refused to deal with the union as a body and has imported strikebreakers to operate its cars. Several riots have occurred and on April 13 the state militia was called upon to

assist the police in enforcing order. On April 14 cars were operated over two of the company's lines with little disturbance from the strikers or their sympathizers. No attempt has been made to operate cars at night.

**Engineering Experiences.**—At a meeting of the Worcester branch of the American Institute of Electrical Engineers on April 17 K. C. Randall, engineer Westinghouse Electric & Manufacturing Company, presented an address entitled "Notes on Engineering Experiences."

**American Institute of Electrical Engineers, Pittsfield Section.**—At the tenth meeting of the season, held on April 10, W. S. Moody, chief engineer transformer department General Electric Company, presented a paper on "Feeder Regulations." He reviewed the subject exhaustively, both from the historical and engineering aspects.

**Bloomington Franchises Attacked.**—The city attorney of Bloomington, Ill., has filed a suit against the Bloomington & Normal Railway & Light Company to test the validity of its franchises. The city claims that practically all of the company's franchises in Bloomington have either expired or were illegally granted to the company's predecessor, the Bloomington & Normal Horse Railway, while the company claims that it has a perpetual franchise covering a large portion of its trackage.

**Plans for Chicago Subway to be Considered.**—Mayor Busse of Chicago has announced that he will send a special message to the city council on April 27 urging that preliminary work be taken up at once on the plans for a subway loop for the downtown district. It is proposed to make a thorough investigation before the method of construction or the route is decided upon, and the mayor will recommend that the entire subject be referred to the local transportation committee, which may engage the services of engineering experts as they are required. The franchise ordinances of the Chicago City Railway and the Chicago Railways companies require them to contribute an amount not to exceed \$5,000,000 toward the cost of a subway. Several members of the council have expressed themselves in favor of devoting the city's share of the companies' net receipts, which now amounts to about \$1,500,000 a year, to a subway construction fund. The ordinances provide that the plans for a subway shall be authorized by the city council and approved by the board of supervising engineers.

**Superintendent of Public Utilities for Seattle.**—The city of Seattle, Wash., has recently created the office of superintendent of public utilities and Alfred V. Bouillon has been appointed to the position. The superintendent of public utilities is appointed by the mayor, with the approval of the city council, and receives a salary of \$300 a month. His term of office expires December 31, 1909. He is to have supervision over all franchise public service companies in their relations with the city and is to act as the official adviser of the city in all matters pertaining to franchises. All applications for franchises will be referred to him and his recommendations will be presented to the city council. He is required to see that the provisions of all franchise ordinances are properly enforced and to present to the board of public works, of which he is an ex-officio member, recommendations from time to time as to such changes or betterments in the equipment of public service companies as may be required to insure the safety and comfort of the public. Mr. Bouillon has had an extended experience as a civil and mechanical engineer.

**Strike in Chester, Pa.**—The motormen and conductors of the Chester (Pa.) Traction Company declared a strike on April 12 because of a reduction of wages and working hours, which took effect on April 1. On that date the Interstate Railways Company of Philadelphia, which controls a large number of electric railways in Pennsylvania, reduced the wages of the carmen employed on its lines from 1½ to 16½ cents per hour. The service has also been reduced. A branch of the union was organized and on April 12 the men voted to strike. At a conference with President John A. Riggs and General Superintendent A. G. Jack on April 13 representatives of the strikers demanded a resumption of the former wage scale and recognition of the union. President Riggs said that the company had suffered greatly by the business depression and that while he hoped the reduction would be only temporary, the company could not afford to restore the old rate. An attempt to operate cars with strikebreakers on Monday led to a serious riot and a detachment of state militia was called. As the presence of the militia served only to increase the violence of the mob they were withdrawn from the city and the situation was left in the hands of the police. On Monday night several switches were torn up. On Tuesday 100 special deputies were sworn in to assist the police in restoring order. On Wednesday two employes of the company were shot in a conflict with the strikers.

## Traffic and Transportation

### Massachusetts Commission Upholds 6-Cent Fare.

Upon the petition of residents of Stoughton, Mass., protesting against the increase in fare from five to six cents by the Blue Hill Street Railway between Stoughton square and Canton crossing, the Massachusetts railroad commission has investigated the earnings of the company and concludes that the 6-cent fare is reasonable. The commission says:

"An analysis of the company's earnings for the last four years discloses an operating loss of between \$6,000 and \$7,000 in 1904, 1905 and 1907, respectively, and a gain of \$1,000 in 1906. These totals, respectively, added to and subtracted from the previous deficit of the company in connection with sundry entries of profit and loss, mainly damage claims covering the periods 1906-1907, show the total deficit for the year ending September 30, 1907, as \$55,622.07.

"These figures convince the board that the company is unable to profitably operate for a 5-cent fare over its established fare limits, and must of necessity advance the charge.

"The primary question presented is whether the advance to six cents as a unit of fare is unreasonable. The 6-cent fare went into effect January 5, 1908. The company, at the request of the commission, has furnished a statement of the comparative gross receipts to April 5, 1908, and for a corresponding period in 1907. The comparative statement is as follows: Gross receipts from January 5 to April 5, 1907, \$14,797.24; 1908, \$15,520.44; increase, 5 per cent.

"These returns have been carefully analyzed, and we find nothing in them that leads us to the opinion that the income of the company under this increased rate for service is unreasonable."

### Transfers Discontinued Between New York Systems.

Transfers between most of the connecting lines of the New York City Railway and the Third Avenue Railroad were abolished at midnight on April 11, in accordance with the order of Judge Lacombe of the United States circuit court. The companies had prepared passengers for the change in the system by notices in the cars, but many people did not understand the situation and considerable confusion resulted. Where passengers refused to pay second fares when their transfers were declined the police were frequently called upon for assistance and some arrests were made.

Edward A. Maher, general manager of the Third Avenue Railroad, said: "We have been coaching the conductors and inspectors for the last week, and we instructed the conductors not to eject persons from the cars if they refused to pay the extra fare for the first day or two. It takes some time for the public to get accustomed to the rule, and, of course, many persons failed to read the notices in the cars or in the newspapers."

In discussing the situation the New York Tribune said: "Every one knows what inconvenience and hardship the change will be to many people, but no one knows whether or not it will be any real advantage to stockholders. Only a few years ago it used to be the fashion to say that the transfers promoted traveling in various ways; for instance, by dispersing the people farther from their working places and causing family and social visits, which would be made infrequently at two fares, but frequently at one, and that the companies profited from it; but now all that is changed, and the system is held up as a prime cause of bankruptcy. \* \* \* Both the dishonest conductor and the dishonest passenger may be eliminated by the new pay-as-you-enter cars. But the companies clearly overreached themselves in their determination to give the public less than it could reasonably demand for its money. The high taxes of which they complain reflect, in part at least, the public irritation. Perhaps those taxes ought to be reduced. Perhaps wiser management will do away with some of the present losses through dishonesty and through damage suits. But it will be a matter of general regret if it be shown that to operate street cars profitably in New York transfers have to be abolished."

**Schenectady Railway Discontinues Sale of Tickets Through Conductors.**—The Schenectady (N. Y.) Railway has discontinued the sale of tickets through conductors.

**Smoking and Dogs Not Allowed.**—Under a new rule, which became effective on April 10, 1908, the Omaha & Council Bluffs Street Railway of Omaha, Neb., does not permit smoking on the front platforms of cars or allow dogs to be carried on the cars.

It is stated that the line of the Connecticut Company from Rockville to Stafford Springs, Conn., will be opened next week.

# Construction News

## FRANCHISES.

**Bowling Green, O.**—The county commissioners have granted a franchise to the Lake Erie Bowling Green & Napoleon Railway Company to lay its tracks from Bowling Green west to the county line at Grand Rapids, O., this being part of its proposed 7-mile extension from Bowling Green to Tontogany, O.

**Colfax, Ia.**—Col. James P. Donohue of Davenport, Ia., has asked the city council for a franchise to build a street railway from the Rock Island depot to the Colfax sanitarium in Colfax. The council may call a special election to vote on the application.

**Hummelstown, Pa.**—The Central Pennsylvania Traction Company, Harrisburg, and the Hummelstown & Campbells-town Street Railway Company, Hershey, Pa., have applied to the borough council for permission to connect their tracks at Rosanna street in Hummelstown.

**Los Angeles, Cal.**—The mayor has vetoed an ordinance recently passed by the city council granting the Los Angeles Railway a franchise for its line on South Park avenue from Thirtieth street to the city limits, a distance of about two miles. The reason given is that the compensation, \$500, is not sufficient. The company has been operating the line under a franchise that has been declared illegal.

**Mattoon, Ill.**—A franchise has been granted to the Mattoon Shelbyville Pana & Hillsboro Railroad of Charleston, Ill., for the operation of its interurban line in Mattoon.

**Oshkosh, Wis.**—The Winnebago Traction Company will apply to the city council for a franchise to extend its line from West Algoma street south on Sawyer avenue to connect with the Ninth street line.

**Oxnard, Cal.**—Application for a street railway franchise in Oxnard has been made by the Bakersfield & Ventura Street Railway Company of Oxnard, Cal. Thomas Blackburn, superintendent.

**Perry, N. Y.**—The Rochester Scottsville & Caledonia Electric Railroad Company, which is building a 52-mile interurban road from Rochester to Portage Falls, N. Y., has been granted a franchise in Perry, N. Y. D. C. Salyerds of Scottsville, N. Y., is president.

**Portland, Ore.**—The Portland Railway Light & Power Company will soon make application for a franchise to extend its tracks through the East Side district, where the population has recently greatly increased.

**Vancouver, Wash.**—The city council has declared forfeited the franchise of the Washington Railway & Power Company, which began the construction of a street railway in Vancouver last summer and suspended work in October.

**Walla Walla, Wash.**—The county commissioners have granted a franchise to the United Railways Company of Portland, Ore., for the operation of its interurban line along the east side of Walla Walla to the Washington cemetery. Work must be started by January 1, 1909, and the entire line in Oregon be completed by the end of that year.

## RECENT INCORPORATIONS.

**Canadian Valley Railway.**—Incorporated in Oklahoma with a capital stock of \$2,000,000 to build an electric railway from Mutual to Oklahoma City, Okla.

**Cincinnati Wilmington & Xenia Traction Company.**—Incorporated in Ohio with a capital stock of \$50,000. K. H. Grantham and others are the incorporators.

**Essex Valley Land Company, Hot Springs, Ark.**—Incorporated in Arkansas to do a general real estate business and to build an electric railway from Hot Springs to Essex Park and Potash Sulphur, Ark. It is stated that one of the surveyed routes of the proposed Little Rock & Hot Springs Interurban Railway will be used by the new line. Incorporators: J. A. Riggs and W. S. Kirkham.

**Exeter Railway & Lighting Company, Exeter, N. H.**—Incorporated in New Hampshire as one of two companies into which the Exeter Hampton & Amesbury Street Railway Company has been reorganized. Capital stock, \$340,000. The Exeter & Hampton Electric Company is the name of the other company. Capital stock, \$100,000.

**Indianapolis Cloverdale & Terre Haute Traction Company, Indianapolis, Ind.**—Incorporated in Indiana to build an

electric railway between Indianapolis and Terre Haute, through the counties of Marion, Morgan, Putnam, Clay and Vigo, and serving the following towns and cities: Indianapolis, West Newton, Mooresville, Gasburg, Monrovia, Hall, Eminence, Cloverdale, Polen, Ashville, Brazil and Terre Haute. Capital stock, \$10,000. Incorporators: E. M. Bowman, H. T. Butze and Dennis Rutherford; all of Indianapolis, Ind.

**Logansport & South Bend Traction Company.**—Incorporated in Indiana to build an electric railway 70 miles long from South Bend to Logansport, Ind. Capital stock, \$10,000. Alexander Coquillard of South Bend and others are interested.

**South San Joaquin Improvement Company.**—Incorporated in California to do a general development business and promote the construction of an interurban railway from Stockton to Manteca, Cal. Incorporators: D. O. Castle, J. A. MacAfee, E. J. Baker, French Camp; E. Powers, J. D. Maxey, Manteca; B. A. Goodwin, C. B. Matthews, Ripon, Cal.

**Woodstock & Sycamore Traction Company.**—Incorporated in Illinois to build an electric railway from Woodstock, McHenry county, to Sycamore, De Kalb county, Illinois, 38 miles. Capital stock, \$1,000,000. Incorporators: Clinton G. Lumley, E. C. Spinney, Irving W. Stephens, E. B. Harang, S. H. Rhodes, William L. Abbott, George W. Lyndon, George T. Goodrow, Henry P. Heiser, N. G. Schmitz and Charles A. Spenny.

## TRACK AND ROADWAY.

**Atlanta & Carolina Railway, Atlanta, Ga.**—Matthew Mason, vice-president, general manager and chief engineer, writes that contracts are to be let about May 15 for the construction of this proposed road from Atlanta to Augusta, Ga., 175 miles, via Lithonia, Conyers, Monroe, Athens, Lexington and Washington. Surveys have been completed and grading is to begin about June 1. Power is to be purchased. Construction has been started on a portion of the proposed city lines in Atlanta. The Georgia railroad commission has authorized a bond issue of \$6,000,000. J. W. English is president and M. T. Edgerton secretary.

**Biddeford Pool Electric Railway, Biddeford, Me.**—Charles W. Moses, president, writes that this company proposes to build an electric railway from Biddeford to Biddeford Pool, a summer resort, 14 miles. Surveys have been completed and construction work is to begin as soon as a contract can be arranged with responsible parties. The company's charter has recently been extended for three years. The route lies through a thickly settled territory whose resources require transportation facilities for their proper development. George E. Getchell, chief engineer, Augusta, Me.

**Calgary, Alberta.**—The city council desires to receive offers for the construction, equipment and operation of a street railway in the city of Calgary for a limited period of franchise. For particulars apply to H. E. Gillis, city clerk.

**Cassville & Western Railway, Cassville, Mo.**—L. B. Mitchell, assistant secretary, writes that this steam road, extending from Cassville to Exeter, Mo., five miles, is to be electrified and extended in the near future.

**Charleston & Summerville Electric Railway, Charleston, S. C.**—A meeting of the stockholders has been called for May 29 for the purpose of increasing the capital stock to \$400,000 to complete the interurban line from Charleston to Summerville, S. C., 27 miles. It is also proposed to build a city line in Charleston. A committee of Charleston citizens recently made an investigation and reported in favor of completing the road, on which most of the grading was completed last year. New York capitalists are said to have become interested in the road and it is expected that construction will be resumed at an early date. F. S. Wright of Brooklyn, N. Y., is vice-president, and George Tupper of Charleston is secretary and treasurer. (Noted March 14.)

**Columbia & Walla Walla Traction Company, Waitsburg, Wash.**—It is stated that this company proposes to begin construction this spring on a portion of its proposed line connecting Dayton, Walla Walla, Waitsburg, Milton and Wallula, Wash. The power house is to be located on the Tocannon river. M. C. Moore of Walla Walla is president and J. T. Bartlett of Waitsburg is chief engineer. (Noted August 24, 1907.)

**Coos Bay Gas & Electric Company, Marshfield, Ore.**—Seymour H. Bell, treasurer and manager, writes that this company proposes to build a short line of street railway this summer.

**Davenport & Manchester Interurban Railway, Davenport, Ia.**—George T. Baker, president, writes that surveys are being made for the proposed line from Davenport to Manchester, Ia., via Bennett and Monticello, 93 miles. Officers: A. J.



Voorhees, vice-president; J. F. Halligan, treasurer; F. W. Rank, secretary; W. H. Kimball, chief engineer. (Noted April 11.)

**Easton (Pa.) Transit Company.**—H. R. Fehr, president, writes that this company will build an extension of the Easton and South Bethlehem line through Washington Heights, 1.4 miles. A contract has been awarded for the construction of a bridge across the Philadelphia & Reading tracks.

**Fairmont & Clarksburg Traction Company, Fairmont, W. Va.**—This company is reported to have completed a survey for its proposed extension from Grassell to Bridgeport, W. Va. S. B. Miller, chief engineer.

**Fairmont & Mannington Electric Railroad, Fairmont, W. Va.**—It is reported that work is to be resumed at once on the construction of the line from Fairmont to Mannington, W. Va., 14 miles. About 3½ miles of track were laid last fall. The Blodgett Construction Company of Wheeling, W. Va., has the contract. F. H. Bailey, general manager. (Noted December 21.)

**Findlay-Marion Railway & Light Company, Columbus, O.**—G. W. Meeker, secretary and treasurer, states that it is proposed to begin active construction on the proposed line from Findlay to Marion, O., 46 miles, about May 1. The overhead trolley system will be of the usual type. R. P. Hankey, president, Detroit, Mich. (Noted March 7.)

**Ft. Wayne & Springfield Railway, Decatur, Ind.**—W. H. Fledderjohann, president, writes that grading is now in progress on the extension from Decatur to Berne, Ind., 12 miles. The work is being done by the company. The overhead construction will be of the catenary type. It is not proposed to build the extension to Springfield, O., this year. A. W. Fishbaugh, chief engineer, Celina, O. (Noted March 14.)

**Gainesville Whitesboro & Sherman Railway, Gainesville, Tex.**—It is reported that a contract has been let for the construction of this proposed road from Gainesville to Sherman, Tex., 39 miles, to the Tenney Construction Company of Silver City, N. M., and that work is to begin in a few days. John King, vice-president. (Noted March 7.)

**Grand Junction, Colo.**—It is stated that the Fruit Belt Power & Irrigation Company, recently organized, proposes to build an electric railway from Grand Junction to points in the Grand Valley.

**Hanover & McSherrystown Street Railway, Hanover, Pa.**—R. E. Mauley, general manager, writes that construction has been started on an extension from McSherrystown, Pa., 5½ miles. John Dobbiling of York, Pa., has the contract for grading. The overhead construction is being erected by the railway company. R. B. McKinnon, York, Pa., chief engineer. (Noted January 18.)

**Iowa Railroad, Eldora, Ia.**—George Welsby Scott, consulting engineer, of Chicago, has just completed an especially favorable report on the project of the Iowa Railroad to build an electric railway from Waterloo to Perry, Ia., via Cedar Falls, Normal, Lincoln, Grundy City, Eldora, Hubbard, Story City and Boone, with a branch from Story City to Ames, a total distance of 127 miles. The proposed line would pass through one of the richest sections of Iowa, capable of originating a large traffic in freight, passengers and express and including several county seats besides three state institutions, the agricultural college at Ames, the industrial school at Eldora and the normal school at Cedar Falls. The estimated tributary population is 375 per mile. Mr. Scott estimates the cost of construction and equipment for 127 miles of line at \$3,868,600. The power house is to be located at Eldora. At Ames the line connects with the Ft. Dodge Des Moines & Southern Railroad and it is proposed to secure trackage rights over this line into Des Moines. The Iowa Railroad was incorporated on March 31 under the laws of Iowa, with \$100,000 capital stock. The charter includes broad powers to extend the line into any part of the state and to operate other public utilities. It is proposed to build at first only the section from Eldora to Ames. The officers of the company are: President, Henry S. Osborne, Chicago; vice-president and general manager, Andrew Stevenson, Chicago; second vice-president and treasurer, James P. Hardin, Eldora; general counsel, Frederic P. Vose, Chicago; secretary, L. W. Harris, Eldora; assistant secretary and assistant treasurer, Louis A. Bowman, Chicago. The company is now seeking to interest the people along the proposed route in its proposition.

**Irwin, Pa.**—It is reported that a company has been organized to build an electric railway from Manor to Claridge, Pa., and that a survey of the proposed line is now being made. H. A. Lauffer is president.

**Joplin & Pittsburg Railway, Joplin, Mo.**—R. W. Harris, general manager, writes that grading has been completed on

the line from Joplin, Mo., to Pittsburg, Kan., 26 miles, via Asbury, Waco, Carl Junction and Chitwood. All contracts have been let. A. L. Register & Co. of Philadelphia has the general contract. Substations are under construction at Asbury and Turkey Creek, each of which will be equipped with two 300-kilowatt rotary converters. The overhead construction will be of the catenary type. J. J. Helm of Kansas City is president and Henry Rohwer of St. Louis is chief engineer. (Noted April 4.)

**Jersey Central Traction Company, Keyport, N. J.**—It is reported that this company expects to build about 4 miles of track, including about 1½ miles of trestle work. George I. Brown, general manager.

**Kalamazoo Elkhart & South Bend Traction Company, South Bend, Ind.**—It is reported that this company intends to begin construction next month on its proposed line from South Bend, Ind., to Kalamazoo, Mich., by way of Mishawaka, Elkhart and Three Rivers, 73 miles. A. D. Harris, president, and G. M. Morrison, chief engineer. (Noted January 25.)

**Kentucky & Ohio River Interurban Railway, Paducah, Ky.**—John J. Freundlich, general manager, writes that grading is to be started on May 15 on the proposed line from Paducah, Ky., to Cairo, Ill., 40 miles, via Cecil, Grahamsville, Ingleside, Bandana and Oscar. The Royal Investment Company of Minneapolis, Minn., has the general contract. C. F. Crump of Columbus, Ind., is president, and L. B. Whiteside of Franklin, Ind., is secretary. (Noted April 4.)

**Little Rock-Pine Bluff Transit Company, Pine Bluff, Ark.**—This company has been organized and will soon be incorporated to build an electric railway from Little Rock to Pine Bluff, Ark., 40 miles. Right of way is now being secured and it is stated that construction will be started at an early date. The officers are: President, W. F. Campbell, Redfield, Ark.; vice-president, B. F. Foreman, Texarkana; secretary and treasurer, Mrs. F. A. Gibson, Redfield, Ark.

**Mahoning & Shenango Railway & Light Company, New Castle, O.**—President E. N. Sanderson has announced that the Elm street line in Youngstown, O., will be double-tracked this year if permission can be secured from the city council.

**Marquette County Gas & Electric Company, Ishpeming, Mich.**—We are officially advised that surveys are being made for an extension from Negaunee to Marquette, Mich., 13 miles, but it has not yet been decided when contracts will be let. A. L. Drum & Co., Chicago, represent the company as consulting engineers. W. J. McCorkindall, general manager.

**Mattoon Shelbyville Pana & Hillsboro Railroad, Charleston, Ill.**—W. R. Patton, president, is quoted as saying that construction is to begin within the next few months on the proposed line from Mattoon to Hillsboro, Ill., 68 miles. As surveyed the line closely parallels the Cleveland Cincinnati Chicago & St. Louis Railway. All of the necessary franchises have been secured. (Noted December 21, 1907.)

**Michigan United Railways, Lansing, Mich.**—It is stated that construction will be resumed on the line between Lansing and Mason, Mich., within a few days. Four miles of grading were completed last fall. The Northern Construction Company, of which J. J. Martindale is chief engineer, is building the line. (Noted November 9, 1907.)

**Minneapolis St. Paul Rochester & Dubuque Electric Traction Company, Minneapolis, Minn.**—F. A. Martin, general superintendent, writes that specifications and profiles have been completed for the proposed road from Minneapolis and St. Paul, Minn., to Dubuque, Ia., and contracts are to be let shortly. F. G. L. Hunt, chief engineer. (Noted January 18.)

**Montgomery Electrical Company, Christiansburg, Va.**—A. A. Phlegar, secretary, states that it is hoped to make financial arrangements for building the proposed road from Christiansburg to Cambria, Va., 2¼ miles, this year. (Noted March 11.)

**Montreal & Southern Counties Electric Railway, Montreal, Que.**—This company, which proposes to build an electric railway from Montreal to Longueuil, St. Lambert, Chambly Basin, Chambly Canton and Meriville, Que., is stated to have awarded a contract for bridge work to the Dominion Bridge Company. Construction is to be started at once.

**Murphysboro Railway Light Heat & Power Company, Murphysboro, Ill.**—It is reported that this company proposes to build an extension about two miles long.

**Murray, Utah.**—The city council has appointed a committee to consider the feasibility of building an electric railway to Garfield.

**Ohio Electric Railway, Cincinnati, O.**—Morris Hacker, principal assistant engineer, Lima, O., writes that 27 miles

of tracklaying have been completed this year, from Lima to Huntsville, O., on the Lima-Bellefontaine line, which will be 34 miles long, via Waynesfield, New Hampshire, Lakeview and Huntsville. Grading has been completed and the overhead work is now being erected. Both bracket and span construction will be used. The transmission line will carry 33,000 volts. Three substations are under construction, the equipment having been ordered from the Westinghouse Electric & Manufacturing Company. J. T. Adams of Columbus, O., has the contract for tracklaying and D. H. Robinson of Indianapolis, Ind., has the contract for the overhead work. Gaylord Thompson of Cincinnati is chief engineer. It is reported that the Lima-Defiance line will not be electrified this summer as expected. (Noted March 14.)

**Omaha & Council Bluffs Street Railway, Omaha, Neb.**—This company has just completed an extension on South Tenth street to Riverview park.

**Oregon Electric Railway, Portland, Ore.**—G. W. Talbot, vice-president and general manager, writes that the Willamette Construction Company will begin about April 20 the construction of the branch line from Garden Home to Hillsboro, Ore., 12 miles. Work on the extension from Salem to Albany, 27 miles, will probably not be started until late summer. W. S. Barstow & Co., Portland, engineers. (Noted April 11.)

**Paducah Southern Electric Railroad, Paducah, Ky.**—H. H. Loving, secretary, writes that this company proposes to build an electric railway from Paducah to Mayfield, Fulton and Hickman, Ky., 70 miles, although the first section from Paducah to Mayfield, 25 miles, is the only one contemplated at present. The Southern Construction Company of Paducah has been organized to build the line. The line has been located by the American Engineering Company of Indianapolis. Franchises and a private right of way 100 feet wide have been obtained. Mr. Loving states that the company's bonds are now being subscribed for freely and it is expected that construction will be started in a short time. John C. Short & Son, 51 Liberty street, New York City, are making negotiations for the construction and equipment. (Noted January 11.)

**Saginaw Owosso & Lansing Railway, Detroit, Mich.**—It is reported that construction is to begin in a few months on the proposed line from Saginaw to Lansing, Mich., via Owosso and Laingsburg, 64½ miles. Surveys have been completed and the right of way secured. The officers are: President, C. W. Baird; secretary, Frank West; treasurer, George M. Black; general manager and chief engineer, J. A. Thick. (Noted March 16, 1907.)

**San Jacinto, Cal.**—It is reported that construction is to be started this summer on the proposed electric railway from Redlands to San Jacinto and Hemet, Cal. Preliminary surveys have been made. W. F. Whittier of San Francisco is interested.

**South Richmond Railway, Richmond, Va.**—It is reported that plans are being prepared by C. P. E. Burgwyn and others of Richmond, for the construction of an electric railway about five miles long in the vicinity of Richmond, from Fulton to Warwick Park, partly via the Osborne turnpike and partly on private right of way. Those interested in the line hold an old charter under the name of the South Richmond Railway, but it is proposed to secure a new charter. Work is to be started as soon as the right of way can be secured. Power is to be purchased from the Virginia Passenger & Power Company.

**Spokane & Inland Empire Railroad, Spokane, Wash.**—A. M. Luper, chief engineer, writes that eight miles of track have been laid this year on the extension from Palouse, Wash., to Moscow, Idaho, 15.5 miles. The bridge work and 95 per cent of the grading have been completed. Overhead construction will be started about May 1. (Noted March 21.)

**Stroudsburg & Water Gap Street Railway, Stroudsburg, Pa.**—This company is reported to have let a contract for a new bridge across McMichael's creek at Stroudsburg. A. A. Holbrook, general manager, Wilkesbarre, Pa.

**Texas Traction Company, Dallas, Tex.**—President J. F. Strickland has announced that regular operation on the line from Dallas to Sherman, Tex., 65 miles, will be in regular operation before July 1. A report made by the chief engineer, Fred A. Jones, states that grading is practically completed, 58 miles of track have been laid, 40 miles of poles have been erected and about 25 miles of overhead construction have been completed. The equipment for the power house at McKinney has been installed and has been operated and the substation installations will be completed within three weeks. (Noted March 28.)

**Thermopolis, Wyo.**—S. A. Broadwell states that his street railway line from Thermopolis to Thermopolis Hot Springs, 1½ miles, will be completed this spring.

**Vincennes West Baden & Louisville Railroad, Vincennes, Ind.**—It is reported that this company expects to begin construction during June or July on its proposed line connecting Vincennes, Monroe City, Petersburg, Algiers and Jasper, Ind., 42½ miles. The capital stock is \$1,500,000. President, Thomas H. Adams; secretary, Anthony M. Yelton.

**Wabash Valley Railroad.**—It is reported that construction is to begin at once on this proposed line from Danville, Ill., to Perysylvia, Ind. D. C. Johnson of Clinton, Ind., is president. (Noted February 29.)

**Washington Westminster & Gettysburg Railroad, Washington, D. C.**—James B. Colegrove, president, states that financial arrangements have been made for the construction of the proposed line from Washington, D. C., to Gettysburg, Pa., via Sandy Springs, Laytonsville and Westminster, Md., 80 miles. Right of way is now being secured. Walter Atlee is chief engineer. (Noted January 11.)

**Winnebago Traction Company, Oshkosh, Wis.**—J. P. Pulliam, superintendent, writes that an extension of the Oshkosh-Omro line to Berlin, Wis., is contemplated, but no definite plan has yet been decided upon. (Noted April 4.)

#### POWER HOUSES AND SUBSTATIONS.

**Black Hills Traction Company, Deadwood, S. D.**—We are advised by F. P. Wood, superintendent, that this company has recently acquired additional water rights and will this year increase its generating capacity. The company is engaged in the sale of power to milling, mining and lighting companies.

**Cincinnati (O.) Traction Company.**—This company is reported to have let contracts for the erection of a substation to be installed in its Brighton car house.

**Coquille Valley Power Company.**—J. S. N. Smith, Coos Bay, Ore., consulting engineer of this recently organized company, has announced that surveys for a pipe line, flumes and power house to be located midway between Marshport and Roseburg, Ore., have been completed. The immediate capacity of the plant will be 4,000 horsepower, which can be increased later to 12,000 horsepower. The distribution system will include a transmission line 33 miles long.

**Crookston, Minn.**—It is reported that Elias Steenerson and others have employed engineers to make preliminary surveys and estimates on the cost of a dam across the Red river of the North near Climax, Minn.

**Escanaba Electric Street Railway, Escanaba, Mich.**—We are advised that hereafter this company will purchase its power from the Escanaba Pulp & Power Company. This arrangement will take effect as soon as the power company's plant on the Escanaba river is completed. The power plant machinery is on the ground awaiting the completion of the dam across the river.

**Interurban Railway & Terminal Company, Cincinnati, O.**—This company has just purchased from the John A. Stewart Electric Company, Cincinnati, for installation in its main power house near Coney Island, O., two 300-kilowatt 25-cycle rotary converters complete with oil cooled transformers and switchboards.

**National Construction Company, Smyrna, Del.**—John D. Thompson, architect, Wilmington, Del., is said to be preparing plans and specifications for a power station to be built at St. Georges, Del. J. W. Endeau, chief engineer and general manager of the construction company, holds like offices in the Smyrna Kent County & Delaware Bay Traction Company.

**Norfolk & Portsmouth Traction Company, Norfolk, Va.**—We are advised by E. C. Hathaway, general manager, that this company has under construction in Portsmouth a substation which will receive current from Norfolk by means of submarine cable. (Noted April 11.)

**North Coast Water & Power Company, Lewiston, Idaho.**—This company has made application for the lease of land near the city pumping station to be used as a site for a temporary power plant.

**Portland Railway Light & Power Company.**—It has been announced in Portland, Ore., by B. S. Josselyn, president, that plans are being drawn for a new substation to be erected on Northern Hill.

**St. Joseph Railway Light Heat & Power Company, St. Joseph, Mo.**—This company is reported to be considering the expenditure of \$50,000 in increasing the capacity of its power station.

# Personal Mention

Mr. George P. Hilton has resigned as director of the United Traction Company, Albany, and the Hudson Valley Railway, Glens Falls, N. Y.

Mr. H. M. Lambert, who recently was appointed chief dispatcher of the Spokane & Inland Railroad, Spokane, Wash., has been appointed trainmaster; effective on April 1. Mr. A. S. Bimrose will succeed Mr. Lambert as chief dispatcher.

Mr. W. O. Woodward, division passenger and freight agent of the Ohio Electric Railway at Dayton, O., and Mr. J. O. Larson, division passenger and freight agent at Springfield, O., have resigned and the positions have been abolished. As previously noted, Mr. F. A. Burkhardt has been appointed assistant general passenger and freight agent, with headquarters at Lima and Dayton.

Mr. R. W. Harris, general superintendent of the Joplin & Pittsburg Railway, Pittsburg, Kan., has been appointed general manager of the road, succeeding Mr. P. P. Crafts, resigned. Mr. Harris formerly was general manager and purchasing agent of the Illinois Light & Traction Company at Streator, Ill., resigning last December to become general superintendent of the Joplin & Pittsburg road.

Mr. Frederick S. Berry, heretofore superintendent of the Orange County Traction Company at Newburgh, N. Y., has been appointed general manager of the company, succeeding

Mr. E. C. Boynton, resigned; effective on April 1. Mr. Berry was born at West New Brighton, Staten Island, N. Y., on December 31, 1872. He received a public school education and began railroad work in 1891, at the age of 19 years, starting as a conductor on the Port Richmond & Prohibition Park Electric Railroad. He operated the first electric car on Staten Island and for two years acted as conductor and motorman. He was then appointed assistant to the superintendent of the road and remained with the company through two reorganizations; the first in 1895, when W. B. Rockwell, manager



Frederick S. Berry.

of the Middletown-Goshen Electric Railway, assumed control, and the second in 1900, when the property was taken over by the Rockefeller interests. Mr. Berry remained with the company but a few months after the last change in ownership, resigning to go to Newburgh, N. Y., to reorganize the dispatching system of the Orange County Traction Company. He was chief dispatcher of the company for six years, receiving his appointment as superintendent about two years ago. Mr. E. J. Irwin, heretofore master mechanic, has been appointed superintendent of maintenance.

Mr. Martin Ackerman, heretofore superintendent of the Youngstown & Ohio River Railroad, at Salem, O., has been appointed general manager of the Springfield & Xenia Railway, Springfield, O., succeeding Mr. R. R. Strehlau, resigned. Mr. Ackerman formerly was trainmaster of the Lake Shore Electric Railway, resigning the first of the year to become superintendent of the Youngstown & Ohio River line.

Mr. E. C. Boynton, who has been general manager of the Orange County Traction Company, Newburgh, N. Y., since October, 1906, has resigned; effective on April 1. Mr. Boynton formerly was connected with the New York New Haven & Hartford Railroad, the National Brake & Electric and other well-known companies. He is joint author with Mr. Albert Herrick of "American Electric Railway Practice."

Mr. Edgar H. Hyman, who has been appointed general manager of the Electric Package Agency of Cleveland, O., effective on April 1, has been connected with the company since June, 1898, a few months after its formation to operate over the lines of the Lake Shore Electric Railway and other

properties of the Everett-Moore syndicate. Since that time Mr. Hyman has been in continuous service with the company, holding successively the positions of assistant auditor, auditor and treasurer and auditor. Since April 1, 1908, he has been general manager of the company, succeeding the late Charles A. Kenworthy, whose death was announced in the Electric Railway Review of April 4. Mr. Hyman still retains his position as treasurer and auditor.

Mr. Howard F. Grant, for the past five years manager of the Seattle (Wash.) Electric Company, one of the Stone & Webster properties, has been appointed district manager of the properties in the northwest. Mr. Grant began his railroad career with the Eastern Railroad at Portsmouth, N. H., where he was employed as watchman, later being placed in charge of the company's kyanizing plant at Portsmouth. A year later he was appointed to a clerkship in the maintenance of way department and was afterward made chief clerk of the department. With the consolidation of the Eastern Railroad and the Boston & Maine he was appointed chief clerk of the maintenance of way department of the combined system, in which capacity he served for 10 years. He then resigned to accept a position



Howard F. Grant.

with the West End Street Railway of Boston as secretary to the general manager, later being appointed secretary to the vice-president of the Boston Elevated Railway, the successor of the West End company. On January 10, 1903, he resigned to become associated with the Stone & Webster interests at Seattle, where he has since remained. Mr. E. E. Potter has been appointed acting manager of the Seattle Electric Company to succeed Mr. Grant.

Mr. Melville Dozier, Jr., whose portrait is presented herewith, has been appointed assistant general manager of the Northern Electric Railway at Chico, Cal., as announced in the Electric Railway Review of April 11, 1908. Mr. Dozier was born in California and is a graduate of the Los Angeles high school and the engineering department of the University of California. He finished his engineering course in 1899 and shortly afterward was appointed assistant engineer of the Southern Pacific Railway, where he remained until 1901, resigning to become assistant engineer of construction of the Pacific Electric Railway at Los Angeles. In 1904 he was appointed engineer of maintenance of way for this company and the Los Angeles Interurban Railway. He resigned in 1906 to become president and chief engineer of the Vallejo & Northern Railway Company, which was organized to build an electric railway 52 miles long from Sacramento to Vallejo, Cal. From 1906 until March, 1908, he was engaged in locating the main and branch lines of this proposed interurban road, as well as having in charge the acquiring of right of way and terminal sites, the negotiations for which were concluded before he accepted his present position. The Northern Electric Railway, of which he is now assistant general manager, comprises 116 miles of interurban and street railroads, including the Chico Electric Railway, the Marysville & Yuba City Street Railroad and the Shasta & Southern Railway.



Melville Dozier, Jr.

# Financial News

**Brooklyn Rapid Transit Company.**—The following statement has been issued for the six months ended December 31, 1907: Gross earnings—Passenger, \$9,919,366; freight, mail and express, \$191,251; advertising, \$77,553; American Railway Traffic Company, \$211,401; total earnings from operation, \$10,399,571. Operating expenses—Maintenance of way and structures, \$527,807; maintenance of equipment, \$945,104; operation of power plant, \$543,703; operation of cars, trainmen's wages, \$1,734,082; operation of cars, other expenses, \$786,047; damages and legal expenses, \$503,219; general expenses, \$318,131; freight, mail and express expenses, \$115,353; American Railway Traffic Company expenses, \$167,280; total operating expenses, \$5,940,726; earnings from operation, \$4,458,845. Income from other sources—Rent of land and buildings, \$40,809; rent of track and structures, \$48,794; miscellaneous, \$268,961; total income, \$4,817,409. Deductions—Taxes, \$464,902; interest and rentals, net, \$2,788,597; total deductions, \$3,253,499; net income, \$1,563,910; special appropriations, \$211,705; surplus, \$1,352,205.—The New York stock exchange has listed \$1,595,000 of first refunding mortgage convertible 4 per cent bonds, making the total amount listed \$30,652,000.

**Chicago City Railway.**—The following report for the fiscal year ended January 31, 1908, has been made to the city of Chicago:

Gross earnings .....	\$ 8,215,196
Operating expenses (70 per cent) .....	5,750,637
Net (30 per cent) .....	\$ 2,464,559
Interest at 5 per cent on capital investment .....	1,236,009
Net earnings .....	\$ 1,228,550
Net earnings divisible as follows:	
City of Chicago .....	\$675,703
Chicago City Railway .....	552,847
	\$ 1,228,550
Total valuation of property as of January 31 .....	\$29,052,145
The balance sheet as of January 31, 1908, follows:	
Assets.	
Value of property June 30, 1906 .....	\$21,000,000
Additions to property value since June 30, 1906 .....	8,052,145
Total value of property .....	\$29,052,145
Divisible profits .....	\$1,228,550
Less trolleyization taxes paid the city of Chicago .....	3,333
	1,225,217
Total assets .....	\$30,277,362
Liabilities.	
Investment .....	\$29,052,145
Profits .....	\$676,703
Less trolleyization taxes .....	3,333
Company profits .....	672,369
	552,848
	\$30,277,362

**Chicago Railways Company.**—Stockholders of the North Chicago Street Railroad and the West Chicago Street Railroad met on April 6 to protest against the assessment levied on account of claims aggregating \$245,000. These claims have been presented since the Chicago Railways Company acquired the properties of the Chicago Union Traction Company. The assessments on the stock of the North Chicago road and the

West Chicago road, \$1.98 and \$1.28 per share, respectively, were voted by a majority of the directors of those companies. The minority directors held that the assessments should not have been voted. The claimants are: Henry A. Blair, as receiver, \$150,000; Henry S. Robbins, counsel fees, \$30,000; W. J. Calhoun, counsel fees, \$40,000; Frederick H. Rawson, bank expenses, \$25,000; total, \$245,000. The principal protest was concerning the fee asked by Mr. Blair. It was stated that he was allowed \$81,000 by the United States court for his work as receiver and that this amount was ample compensation.

**Little Rock (Ark.) Railway & Electric Company.**—An issue of \$5,000,000 of refunding and extension mortgage bonds has been authorized. The Bank of Commerce & Trust Company of Memphis, Tenn., is trustee. The bonds are dated April 1, 1908, and are due on April 1, 1938. The interest is to be such rate, not exceeding 6 per cent, as may be fixed by the directors from time to time prior to issue, and designated in the bonds. The purpose of the issue is as follows: (1) \$2,000,000 bonds will be reserved to retire \$2,000,000 underlying first mortgage 5 per cent bonds. (2) \$500,000 bonds may be issued by the company from time to time. (3) The remaining \$2,500,000 bonds may be issued for subsequent additions, after proceeds of five instalments of \$500,000 each have been spent for improvements, on the following basis: (a) \$1,000 in bonds for each \$1,250 so expended; (b) provided that net earnings are at least twice the interest charges; and that (c) maintenance expenditures charged to operation are at least 10 per cent of gross earnings. The first \$500,000 bonds will be issued as 6 per cent bonds. There is a sinking fund provision under which annually, beginning with 1913, one-half of 1 per cent of the bonds outstanding will be taken up. The bonds are not subject to call, but may be purchased at prices not above a 4½ per cent interest basis.

**New Orleans (La.) Railway & Light Company.**—Gross earnings from all sources in 1907 were \$6,041,301, as compared with \$5,773,190 in 1906. Expenses were \$3,270,337, as compared with \$3,074,015. Net earnings were \$2,770,904, as compared with \$2,699,175. The net divisible income was \$745,267, as compared with \$798,274. The annual report will be reviewed at length in a later issue.

**New York City Railway.**—Judge Lacombe of the United States circuit court, New York, has filed a memorandum concerning the issue of \$3,500,000 certificates by the receivers of the New York City Railway and the Metropolitan Street Railway. Judge Lacombe says: "As has been noted many times the property was in a deplorable condition when receivers took possession and it became at once manifest that in order to secure a proper and efficient service it would be necessary to expend a large amount of money on improvements and equipment. It was foreseen then, as the event has shown, that the cost of such work would have to be borne by the property; its income is wholly insufficient." Judge Lacombe said that "it would seem that the lessor company (Metropolitan) might have a good cause of action against the lessee (New York City Railway) for waste in allowing the leased property to go to wreck."

**Underground Electric Railways, London.**—Sir George Gibb was appointed receiver on April 15 on application of Speyer & Co. of New York, acting on behalf of themselves and other holders of the profit-sharing notes of the company.

**United Railways & Electric Company, Baltimore.**—Gross earnings in 1907 were \$7,018,082, an increase of \$434,979, or 6.61 per cent, over the previous year. Operating expenses were \$3,470,087, an increase of \$249,145, or 7.74 per cent, over the previous year. The surplus after the payment of fixed charges and taxes was \$1,066,557, of which \$1,028,899 was used for extraordinary expenditures. The annual report will be reviewed at length in a later issue.

## ELECTRIC RAILWAY EARNINGS.

	Gross earnings.	Operating expenses.	Net earnings.	Total charges.	Surplus.
Ft. Wayne & Wabash Valley Trac. Company, February, 1908 ..	97,445.50	56,680.16	40,775.34		
Ft. Wayne & Wabash Valley Trac. Company, February, 1907 ..	83,340.09	52,270.00	31,070.09		
Ft. Wayne & Wabash Valley Traction Company, January 1, 1908, to February 29, 1908 .....	200,475.46	111,177.10	86,298.36		
Ft. Wayne & Wabash Valley Traction Company, January 1, 1907, to February 29, 1907 .....	174,518.24	107,065.43	67,452.81		
Norfolk & Portsmouth Traction Company, February, 1908 .....	131,799.39	88,279.39	43,520.00		
Norfolk & Portsmouth Traction Company, February, 1907 .....	128,557.74	91,153.65	37,404.09		
Norfolk & Portsmouth Traction Company, January 1, 1908, to February 29, 1908 .....	276,660.32	186,900.45	89,759.87		
Norfolk & Portsmouth Traction Company, January 1, 1907, to February 29, 1907 .....	280,577.57	187,941.14	92,636.43		

# Manufactures and Supplies

## ROLLING STOCK.

**Murphysboro Electric Railway Light Heat & Power Company**, Murphysboro, Ill., will buy a number of cars.

**Dayton Street Railway**, Dayton, O., is considering the purchase of a number of cars. C. H. Bosler, 816 Reibold building, is general manager and purchasing agent.

**Centralia & Central City Street Railway**, Centralia, Ill., is in the market for one 15-bench open motor car and one 15-bench trailer. The company is also ready to buy its year's supply of brakeshoes.

**Grand Central Traction Company**, Indianapolis, Ind., under construction, is reported to be in the market for a number of interurban cars. W. D. Whitney, Muncie, Ind., is president.

**Lehigh Valley Transit Company**, Allentown, Pa., which was reported in the Electric Railway Review for April 11 to be in the market for four interurban cars, has placed the order with The J. G. Brill Company.

**Choctaw Railway & Lighting Company**, McAlester, Okla., is in the market for two trail cars. A description of two new interurban motor cars built for this company appeared in the Electric Railway Review for April 4.

**Chicago Railways** has placed an order with the Pressed Steel Car Company for 50 all-steel pay-as-you-enter type cars. This is in addition to the 300 cars ordered from the Pullman Company, as reported in the Electric Railway Review for March 21. The all-steel cars will have the same controlling dimensions as the wooden cars. The railway company will equip all the new cars with International fare registers, National standard roofing and Schroyer friction curtain rollers.

## SHOPS AND BUILDINGS.

**Boston Elevated Railway**, Boston, Mass.—This company lost a car house, one car and seven snowplows in the recent fire at Chelsea, Mass.

**Louisville & Northern Railway & Lighting Company**, New Albany, Ind.—A contract for a new station building at Louisville, Ky., has been awarded by this company.

## TRADE NOTES.

**Railroad Supply Company**, Chicago, on May 1 will remove its New York offices to 540 Hudson Terminals, Cortlandt building.

**Grand Rapids Electrical Show Association**, Grand Rapids, Mich., will hold an electrical show in that city from May 11 to May 16.

**Pay-As-You-Enter Car Company**, New York, has removed its offices from 26 Cortlandt street to the Hudson terminals, Fulton building.

**Paul B. Patten**, Salem, Mass., manufacturer of the Patten ticket destroyer, died on April 6. The estate of Mr. Patten will continue the business.

**J. G. White & Co., Inc.**, New York, has declared the regular quarterly dividend of 1½ per cent on the preferred stock, payable April 2 to stock of record April 1.

**Chester Railway Supply Company**, Chester, Pa., has recently secured an order from the Philadelphia Rapid Transit Company for a large number of Dyer improved trolley cars for use on one of its lines.

**Northern Engineering Works**, Detroit, Mich., has shipped one 12-ton traveling crane to the Sodeman Light Heat & Power Company, Johnstown, Pa., and one 5-ton traveling crane to the Mineral Wells Electric Company.

**United Indurated Fibre Company**, Lockport, N. Y., has received a contract from the Philadelphia Rapid Transit Company for special insulating rail covering to be used in protecting the third rail on the Market Street Elevated Railroad.

**Robert C. Pruyn**, president of the Consolidated Car-Heating Company, New York and Chicago, and Francis C. Green, general manager, have declined re-election to their offices in the company. Their successors will be elected at the annual meeting in June.

**Bristol Company**, Bridgeport, Conn., has come under the control of William H. Bristol, whose inventions the company has been manufacturing since its organization. The business which Mr. Bristol has conducted in New York under the

name of William H. Bristol will be consolidated with the Bristol Company, and, as a result, it is said the company will handle the most complete line of recording instruments available.

**Dressel Railway Lamp Works**, 3866 Park avenue, New York, on account of greatly increased business throughout the west, has appointed Edward W. Hodgkins as western sales manager, effective May 1. Mr. Hodgkins, who is well known in railway circles, will have offices in the Western Union building, Chicago.

**Crocker-Wheeler Company**, New York, on April 24 will move to its new quarters in the Hudson Terminals, Cortlandt building. The company believes the new location will prove of special convenience to its customers and itself, as it will bring the New York office into closer touch with the works and main offices at Ampere, N. J.

**E. E. Keller**, for over 20 years connected with the Westinghouse interests and for 14 years vice-president of the Westinghouse Machine Company, having completed his duties as receiver and general manager, severed his connection with the management of that company on April 1. Mr. Keller will take a much needed rest and will then devote most of his time to several personal interests.

**Quincy, Manchester, Sargent Company** announces that in order to devote more attention to its metal sawing machines, cranes and hoists and car steps, it has decided to discontinue the manufacture of the line of pneumatic compression riveters acquired when the business of Pedrick & Ayer Company was purchased. The Quincy, Manchester, Sargent Company has disposed of the entire line to the Hanna Engineering Company, Chicago, and states that the latter company will make improvements on it and will be able to furnish repair parts for such riveters as have been sold in the past.

**Wheeler Condenser & Engineering Company**, Carteret, N. J., announces that Charles S. Lewis & Co., Granite building, St. Louis, Mo., will handle Wheeler apparatus in the state of Missouri. This includes the well-known Wheeler surface, jet and barometric condensers, feed water heaters, reheaters and receivers, vertical engines, centrifugal pumps, rotating dry vacuum pumps and vacuum pans and multiple effects. It also covers the Voltz combined condenser and feed water heater, Barnard-Wheeler water cooling towers and the Edwards air pump, which has the unique distinction of replacing wet vacuum pump, dry vacuum pump and precooler in condenser equipment. As the Edwards pump contains no suction valves, the pump is as effective in removing air as a dry vacuum pump having mechanically operated admission valves. This pump is widely applied for other vacuum work, as well as with condensers. It is built in various combinations, single, duplex and triplex, for steam and electric drive, etc.

**Westinghouse Electric & Manufacturing Company's** stockholders' committee, consisting of Charles F. Adams, Charles J. Canda, George W. Guthrie, Alvin W. Krech and George T. Oliver, has issued a circular approving the merchandise creditors' plan for the readjustment of the company's debt. This plan was described at length in last week's issue. The circular from the stockholders' committee says in part: "We are informed by the officers of the company that the company's outstanding capital stock of \$27,938,100 represents an actual cash investment considerably in excess of \$30,000,000 above the debt. For six years the company has been regularly paying dividends upon both its preferred and 'assenting' stock, the dividend rate for the three years prior to the receivership having been 10 per cent per annum. The statement (prepared by Haskins & Sells, the company's accountants) of gross sales and net income for the period of seven years and seven months ended on October 31, 1907, indicates that the receivership came at the height of the company's prosperity, so far as earnings are concerned. The chief difficulty with the company and the principal cause of the receivership are found in the fact that, as the result of the rapid expansion of its business, too large a proportion of its investment is represented by debt. If a substantial reduction can be made in the debt by the sale of additional stock, it is believed that the receivership can be promptly terminated, with every prospect of the company entering upon a career of renewed prosperity. The merchandise creditors' plan cannot be carried into effect unless the stockholders protect themselves by subscribing pro rata for their shares of this new stock. If these subscriptions are not forthcoming the inevitable result will be that the readjustment committee, which was organized for the protection of creditors, will be forced to reduce the debt of the company to judgment, bring about a forced sale of the property and its acquisition by a new corporation organized in the interest of creditors. Such a course would result in enormous loss, which would fall chiefly

upon the stockholders of the company. That loss can be avoided only by the co-operation of stockholders in promptly subscribing for a sufficient amount of new stock to insure an early termination of the receivership."

#### ADVERTISING LITERATURE.

(Mention of the Electric Railway Review will assure prompt attention to requests for publications listed here.)

**Rodger Ballast Car Company, Chicago, Ill.**—A series of neat blotters illustrating the Hart convertible car is being distributed.

**Refined Iron & Steel Company, Pittsburg, Pa.**—A leaflet entitled "Confirmation of Quality" contains copies of correspondence and reports which indicate the superior quality of the refined iron produced by this company.

**American Conduit Company, 140 Nassau Street, New York, N. Y.**—Bulletin No. 242 presents data regarding materials required for concrete and brick manholes in connection with the use of bituminized fiber conduit for underground construction.

**General Storage Battery Company, Boonton, N. J.**—Bulletin No. 9 sets forth the advantages of "Permanized" negative plates for high duty storage batteries. Charts are employed to show their superiority over various Planté type plates.

**National Brake & Electric Company, Milwaukee, Wis.**—Bulletin No. 38 describes the National type "3VS" air compressor, which is built for electrical operation, in capacities of 50, 100, 150 and 225 cubic feet of free air per minute. They are furnished for operation on direct-current or alternating-current circuits, either by direct connection, belt drive or water wheel drive.

**General Fireproofing Company, Youngstown, O.**—Recent publications include illustrated leaflets showing the application of plain and cold twisted lug bars and pin-connected girder frames in reinforced concrete construction. One is devoted to the filtration plant at McKeesport, Pa.; another to the Studebaker Brothers Manufacturing Company office building at South Bend, Ind.; and the third to the Central Pennsylvania Lumber Company plant.

**General Railway Supply Company, Marquette Building, Chicago, Ill.**—An attractive catalogue illustrates and describes the merits of a number of patented railway specialties, including metallic (steel) sheathing for passenger cars, the National steel trap door and lifting device, the Schroyer friction curtain roller, the Garland ventilator for both passenger and refrigerator cars, Flexolith composition flooring for passenger, express and baggage cars, National vestibule curtain catches, National standard roofing for all passenger equipment and the Ideal roller center plates.

**Crocker-Wheeler Company, Ampere, N. J.**—Recent publications include Bulletin No. 95, devoted to belt type alternating-current generators, especially designed to be used in adding electric units to plants which have spare engine capacity, and where quick installation is an important consideration.—Bulletin No. 97 illustrates and describes various types of direct-current switchboard panels.—Bulletin No. 98 (superseding No. 78) shows form L direct-current motors and generators, which are built to meet any condition requiring small power for either belt or gear drive or for direct connection.—Bulletin No. 99 is a reprint of a technical article describing Crocker-Wheeler motors in the rail and structural mills of the Bethlehem Steel Company.—Bulletin No. 100 has for its subject form I direct-current machines, which are built in motors from 5 to 45 horsepower and in generators from 4½ to 40 kilowatts. They are adapted for either belt, gear or direct drive and are especially applicable to machine tools.

**General Electric Company, Schenectady, N. Y.**—Bulletin No. 4573 describes the complete line of graded shunt resistance multigap lightning arresters designed by the General Electric engineers for 1908. It also contains detailed descriptions of low-voltage arresters, static dischargers, constant-current horn arresters, disconnecting switches, choke coils and the well-known type M D-2 direct-current arrester for voltages up to 6,000. Tables of general data regarding the apparatus, connection and dimension diagrams, etc., are included. The bulletin discusses briefly the theory upon which the arresters operate and their details of construction. It is bound in an artistic cover.—Bulletin No. 4570 describes and illustrates the General Electric tungsten lamp for 100 to 125 volt circuits. The lamp is made in 40, 60 and 100 watts, and has a life of approximately 800 hours when used on either alternating or direct current. Some of the illustrations show the tungsten incandescent units combined with standard halophanes, which can be used to excellent advantage in this manner.

#### VENTILATING NEW YORK CENTRAL POWER STATIONS.

The electrification of the New York Central and terminal at New York brought up an interesting problem in the heating and ventilation of the storage battery stations at Lexington, Yonkers, Kingsbridge and Bronx Park. The company which installed the storage batteries was willing to guarantee them for 10 years, provided the temperature was maintained at 70 degrees F., and this necessitated a heating plant for cold weather and a means of cooling in warm weather, as well as proper ventilation at all times.

The acid fumes from the batteries precluded heating by direct radiation, as the fumes would destroy the radiation and pipe lines, and hence the blower system was adopted. By



Ventilating New York Central Power Stations—Battery Room, Yonkers.

using this system the entire heating plant is centralized in a detached building, the air being delivered to the various portions of the building by ducts, protected in such a manner as to resist corrosive action.

So far five of these stations have been equipped. In the power house at Yonkers the battery rooms, busbar chambers,

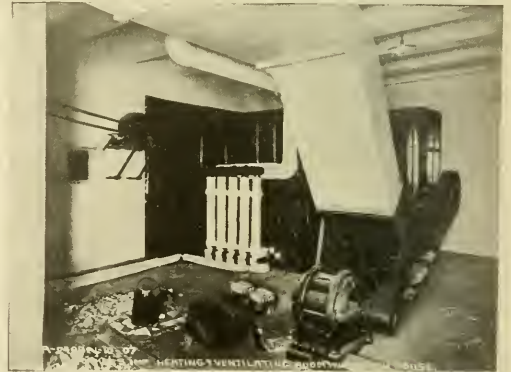

Ventilating New York Central Power Stations—Heating and Ventilating Room in Switchhouse.

corridors, stair halls, controller chambers, etc., are the portions heated and ventilated by the blower system.

The air is circulated through a sectional pipe heater by a steel plate fan, which is driven by a belted motor. Steam is supplied by a small low-pressure boiler, which is located in an adjacent room. The air discharged by the fan is distributed at the proper temperature, by suitable ducts, to the various apartments. Two methods of distribution have been used.

In the Yonkers power station carefully protected galvanized iron ducts are used as shown in one of the illustrations. In the other substation battery rooms there is no piping, the air being admitted at one end of these rooms

through tile conduits terminating at registers made of 95 per cent lead and 5 per cent antimony.

The results, blowing air in at one end of the battery rooms, have been as satisfactory as when the air is distributed throughout the room by ducts with branches therefrom at frequent intervals; the advantages of having no ducts are apparent. Ducts do not add to the appearance of the room and are costly to install and require frequent attention to keep them in a condition to resist the acid fumes.

This system is very compact, easily accessible and under perfect control at all times, while moderate in cost, easily installed and economical in operation and maintenance. Another feature of exceptional value is the absolute flexibility, it being possible to deliver the air at any temperature without diminishing the volume, so that thorough ventilation is provided for the battery rooms while the batteries are being charged.

These heating and ventilating systems were designed by the American Blower Company of Detroit, Mich., and its apparatus was installed by John Hankin & Bro., heating contractors, New York City.

**ROOKE REGISTERS GIVE SATISFACTION.**

In an interview relative to the use of the Rooke automatic fare collector, A. E. Potter, general manager of the Rhode Island Company, Providence, R. I., stated that the collectors were first used on his lines in April, 1907, when they were adopted as an experiment on a line running to one of the smaller car houses of the company. The results of this trial, Mr. Potter stated, were so gratifying that the use of these collectors has gradually been extended until at present, with the exception of three lines, they are used on the company's entire system.

The public in general took kindly to the new method of fare collection, the only real trouble having been experienced with those having imaginary grievances or from relatives of discharged employes. While at first a disposition was shown on the part of some of the younger conductors who did not intend to remain in the business, to attempt to make the new system a failure, the older conductors were quick to recognize its value and their co-operation is now assured. Mr. Potter said that from the first time his attention was directed to this method of fare collection he was impressed with its superiority as a means for the proper registration of all cash fares, and he believes that the successful results of the year's test fully bear out this impression and justify the adoption of the registers on the lines of his company.

**ELECTRIC LOCOMOTIVES FOR CHICAGO SUBWAYS.**

The accompanying illustrations represent one of 25 electric locomotives recently built by the Baldwin Locomotive

are built for underground haulage in the city of Chicago. The mine type is conveniently used for such service, and the example shown is arranged for single-end operation. It is built for a track gauge of two feet. The frames are placed outside the wheels and the bumpers are of channel iron filled with oak buffers. A radial drawbar with automatic coupler is provided at each end of the locomotive. The wheels are 28 inches in diameter, spaced 2 feet 7 inches between centers. The journals are 3 3/4 by 7 inches. The approximate weight of the locomotive is 11,000 pounds.

The electrical equipment includes two No. 155 motors, suitable for 250 volts pressure. They are tandem hung, that is, away from the controller end on their respective axles. As

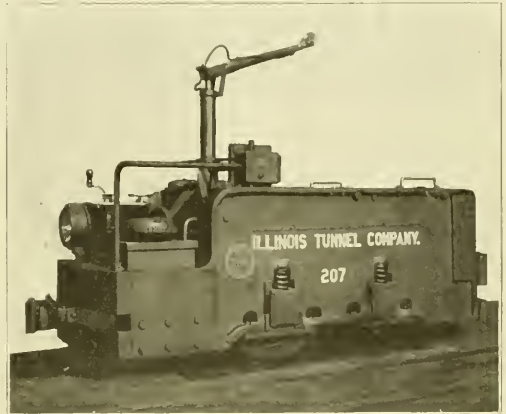

Illinois Tunnel Locomotive—Side View.

they are suspended in an angular position, a short wheel base can be used, enabling the locomotive to traverse sharp curves without difficulty.

The brakes are of the screw type, operated by hand. Four sand boxes are provided with spouts to all wheels. The trolley pole is placed on the center line, near the operating end.

The flexibility of any electric power system is one of its chief advantages, and in the case of the locomotive this is a feature of great importance. The example shown represents but one of many types of Baldwin-Westinghouse locomotives

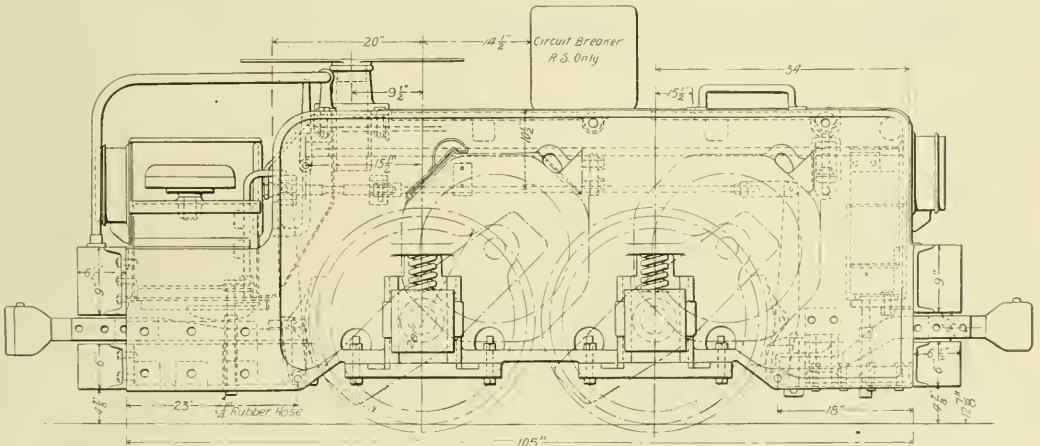

Illinois Tunnel Locomotive—Elevation Showing Arrangement of Motors and General Dimensions.

Works, and equipped with electrical apparatus supplied by the Westinghouse Electric & Manufacturing Company.

The locomotives are for the Illinois Tunnel Company and

recently built for industrial haulage. These motors can be designed to fulfill practically any conditions existing in work of this character.

## SOME IMPORTANT PAINT TESTS.

BY G. B. HECKEL, SECRETARY PAINT MANUFACTURERS' ASSOCIATION OF AMERICA.

Paint tests which promise to furnish valuable data have been undertaken in several parts of the country by the Paint Manufacturers' Association of the United States.

The first of these tests was begun nearly two years ago by the North Dakota Agricultural College at Fargo, at the request of the association, which contributed a sum of money for the purpose. The formulas representing the paint manufacturers' products were selected by Professor Ladd, in conference with the writer, and Professor Ladd invited white lead manufacturers and others to participate, which they did. The formulas furnished for the paint manufacturers numbered 16, representing all the popular and successful types of prepared paints on the market, ranging from a base of straight lead and zinc in varying proportions to a combination of zinc and barium sulphate. In these formulas all the reinforcing or inert pigments were represented, including silica, calcium carbonate, calcium sulphate, magnesium silicate, etc., the object being to provide formulas which, without duplicating existing paints, would each stand as typical of its class.

The paints were applied under Professor Ladd's supervision, the North Dakota Agricultural College being represented by Dr. C. D. Holley as official inspector and the Paint Manufacturers' association by its official inspector, J. B. Campbell.

The North Dakota tests have been so frequently described in the technical press that it will be more interesting to describe the methods pursued in two more recent tests of a similar character. The North Dakota test, being the first undertaken, was somewhat crude in its details, though much valuable information is expected to be obtained from it. But in the course of the work several facts impressed themselves on those interested, the first being the exceptionally favorable character of the North Dakota climate. The air is normally dry, the summers are not hot and the winters, even if cold, are equable and not subject to hygroscopic extremes. It was therefore decided that a series of similar tests should be undertaken on an enlarged scale at other points in the country, where climatic conditions are different.

To initiate this new series Atlantic City, N. J., and Pittsburg, Pa., were selected as typical of severe painting conditions. Committee E (the committee on "Protective Coatings") of the American Society for Testing Materials was requested to supervise the work at Atlantic City and the Carnegie Institute that at Pittsburg. Both accepted. From committee E a subcommittee consisting of Robert Job, chairman; A. H. Sabin, Percy H. Walker of the department of agriculture, W. A. Akin, Joseph F. Walker, S. S. Voorhees and G. B. Heckel was selected to supervise and inspect the work; while the Carnegie Institute selected for the purpose five heads of its technical departments, with Prof. J. H. James as chairman.

A board fence 178 feet long by 5½ feet high, running north and south, was erected in each case and primed with Prince's mineral paint. Panels of Dutch weatherboarding, 3 feet by 15½ inches, were prepared from yellow pine, poplar and cypress, each piece of lumber used in these panels being inspected by a professional lumber inspector, those accepted by him being branded and the rest rejected. It throws an interesting sidelight on modern painting conditions to know that about 50 per cent of the lumber received from the mills was rejected as unfit.

The paint formulas tested include those used in the original North Dakota tests, with the addition of a number of formulas representing the various pigments and combinations of pigments in common use for the painting of wood structures, including a dozen or more brands of white lead purchased in the open market, zinc oxides, sublimed white lead, zinc lead white, lithopone, etc. A series of greens is also being tested at Atlantic City by request of the Philadelphia Master Painters' Association, which finds great difficulty in obtaining a green that will not mildew in this locality.

Committee E selected for its official inspector James P. Partree from the Wilmington shops of the Pennsylvania Railroad, who was kindly given leave of absence for the purpose. The Pennsylvania Railroad also lent the ground at Ventnor for the erection of the fence, which faces the ocean on the one hand and Little Egg Harbor bay on the other.

The painting of the panels was done under cover in each case, so as to obtain, in so far as possible, initial uniformity of conditions. This precaution was not observed in the Fargo tests; indeed, in view of the equable climatic conditions, was not so essential. It is obvious, however, that comparison between two paints is impossible if one be applied in the open on a damp, foggy day and the other on a clear, dry day.

The formulas are prepared in three colors—white, light

yellow and light gray. Each of these colors in each formula is applied in duplicate to each class of wood. There are thus, for example, two panels each of cypress, yellow pine and poplar painted in white with the formula composed of equal parts each of hydrocarbonate white lead, zinc oxide and barium sulphate (the familiar old "one-third each" formula) and these are duplicated in yellow and gray prepared on the same white paint base.

The formulas were ground by various manufacturers, the preparation of each being confided to the manufacturer presumably most familiar with the technical procedure of that particular type of paint. To each formula an identifying number was given, and as completed they were shipped in gallon cans to the chairman of the supervising committee, bearing only the formula number and the name of the Paint Manufacturers' association. Analyses of the vehicles, including the dryers used, were also furnished, together with a sample of the dryer, for further analysis in case of necessity.

When the work was ready the paints were turned over, in the unbroken packages, to the two inspectors.

The Master Painters' associations of Pittsburg and Philadelphia named the official painters for the two tests, the gentleman selected by the former being A. P. Rapp and by the latter George Butler. These gentlemen in turn deputed each an expert painter to do the actual work under the inspectors.

The inspectors themselves have entire charge of the work and keep complete duplicate records thereof as it proceeds. They also remove and retain sealed samples from each package as it is opened, one of which goes to the supervising technical body and the other to the Paint Manufacturers' association.

Each panel is branded with the number of the paint formula applied to it and a letter designating the wood of which it is composed.

The paints as furnished are about suitable in consistency for a finishing coat. The required thinning in each case is done by the inspectors, accurate records of kind and quantity being kept. Weighing before and after application preserves a record of the paint consumed for each coat and also gives the necessary data for ascertaining the spreading rate.

After the priming coat has been applied and allowed to dry a black cross is stenciled on the center of each panel. The degree to which this cross is obscured by the second and the third coat, respectively, indicates the relative opacity of the paint.

About one week was allowed for drying between coats, the inspectors alternating between Atlantic City and Pittsburg, and thus keeping the two tests in progress at the same time.

After complete drying of the third or finishing coats the panels were fastened to the fence by means of brass screws. This will permit their removal for laboratory inspection at any time. At one corner of each panel a small plate of clear glass and a duplicate plate of orange glass in a wood frame have been securely attached and sealed so as to exclude atmospheric agencies while allowing the light to reach the painted surface below. By this means it is expected to ascertain what effect, if any, the actinic rays of the sun have upon the durability of a paint film. The duplicate panels bearing the same paint formulas are placed one on each side of the fence, so that each undergoes an eastern and a western exposure.

Before the application of the paint each panel was carefully photographed on a fixed scale, with the lens stopped at 1-64, so as to secure detail, and these photographs have been filed for future reference.

The fence will be inspected by the subcommittee at intervals of about six months and each member will be provided with blanks upon which to record his individual judgment, the entire set of blanks being filed with the chairman of committee E for his guidance in making his annual reports to the association.

Of course, it is not expected that the results of these tests will settle finally and conclusively the relative merits of competing pigments and types of paint, but it is expected that they will furnish much valuable information, and as they are extended to other sections of the country, may furnish cumulative evidence that will be at least valuable and suggestive. At any rate, public paint tests on so large a scale and under conditions so nearly approximating scientific accuracy have never before been attempted in this country, and the paint-consuming public cannot but be benefited by the information which they will eventually furnish.

The New York New Haven & Hartford Railroad is installing a fourth generating unit at its Cos Cob power station. Electric operation from Stamford, Conn., to New York has been extended to include some of the through express trains; in all 83 trains on week days and 33 on Sundays are now hauled over this section by electric locomotives.



## The Boilers Will be Out of Service a Much Shorter Time for Washing

thereby requiring very much less labor, to say nothing of the saving in fuel and the increased efficiency of the boilers, if the incrusting solids and other deleterious salts in the water are acted upon by **Dearborn Compounds** and their injurious properties destroyed. Send us gallon sample of your feed water for analysis.

# Dearborn Drug & Chemical Works

ROBT. F. CARR, PRESIDENT

299 BROADWAY, NEW YORK

POSTAL TELEGRAPH BLDG., CHICAGO

### WAKEFIELD CAR SEATS

We make everything necessary to seat a car of any description. Our line includes Reversible seats of both the Slideover and Turnover types for Steam and Electric service, as well as the only practical Double Revolving seat on the market.

Our Longitudinal Spring Seating is unexcelled for superiority of workmanship and durability.

We also carry a large variety of Rattan Chairs for Parlor and Observation Cars.

**Heywood Brothers & Wakefield Company**

New York, N. Y.

Wakefield, Mass.



### “Not an Experiment”

The **Providence Fender** is the **Children’s Fender**. It is equally as effective in saving a child, and the person who has stumbled, as it is in saving those who are on their feet.

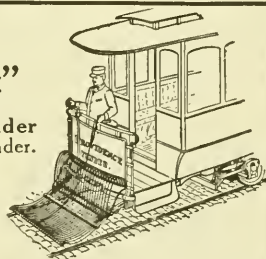

### CONSOLIDATED CAR FENDER COMPANY

Office and Factory: PROVIDENCE, R. I.

Branch Office: 110 E. Twenty-third St., New York

European Agents: Comptoir d’Electricite, 6, Rue Boudreau, Paris, France

## Washburn “K” Type Traction Coupler Complete with Draft Rigging

Simple  
Strong  
Durable



This device is composed of the “K” head—a heavy cast steel extension made in any length—and the “K” pivoted draft box spindle type. Made also in a heavier coupler and with the regulation 6¼ x 8 M. C. B. draft spring.

Ask for new catalogue of traction devices.

### Washburn Steel Castings & Coupler Co., Minneapolis, Minn.

Western Agents: Tweedy, Hood & Finlen, 2014 Fisher Bldg., Chicago

Canadian Agent: John Taylor, Montreal

## The Moore Track Drill

does not interfere with traffic!

The shifting of one lever and a few seconds' time takes down the drill—the operation reversed makes it ready for work again.

This is only one of the many strong points about the Moore Track Drill that make it worth buying.

Ask for descriptive catalogue.

**Kalamazoo Railway Supply Co.** Kalamazoo Michigan

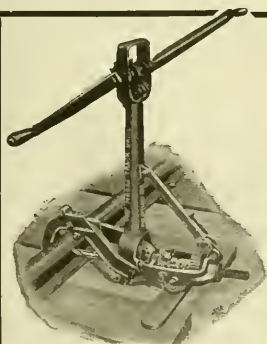

## THE J. G. BRILL COMPANY, PHILADELPHIA, PA.

AMERICAN CAR COMPANY, ST. LOUIS, MO.  
 G. C. KUHLMAN CAR COMPANY, CLEVELAND, OHIO  
 JOHN STEPHENSON COMPANY, ELIZABETH, N. J.  
 WASON MANUFACTURING CO. SPRINGFIELD, MASS.

MAIN OFFICE: PHILADELPHIA, PA.  
 LONDON OFFICE: 110 CANNON ST. E. C.  
 PACIFIC COAST AGENTS: PIERSON  
 ROEDING & CO., SAN FRANCISCO.  
 AUSTRALIAN AGENTS: NOYES  
 BROTHERS, SYDNEY. CABLES:  
 "BRILL," PHILA., "AXLES" LONDON.

*CARS TRUCKS SEATS RATTAN SPRINGS SPECIALTIES SUPPLIES*

## SAFE SUMMER SERVICE

The "Narragansett" is the right car for handling crowds safely in excursion service and is the only practical double-truck open car. The width over all is the same as a single-step open car as the upper step is on the flange of a Z-bar sill and within the line of the posts. The best possible arrangement of the running board of a single step car with the minimum height of floor is 19½ inches to board and 17 inches to floor. The same height in the "Narragansett" is divided into 16, 13 and 7½ inches. Companies which have used "Narragansett" cars for a number of years have recently reported that they have had no accidents. Women, children and elderly persons can get in and out easily and quickly. The Z-bar sills make it the strongest open car ever built. The arrangement does not reduce the length of the seats. Write for catalog.

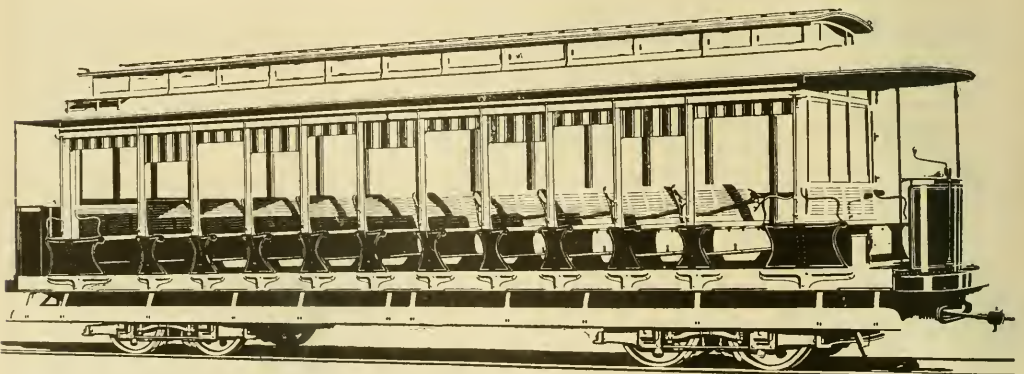

*THE BRILL "NARRAGANSETT" CAR (PATENTED)*

# General Electric Company

## Auxiliary Contactor Equipments for Cylinder Controllers

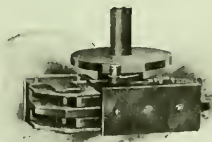

Auxiliary Attachment for K-28  
Controller.

**Controller Attachments:** The auxiliary contacts are connected in series with the contacts of the MU tripping Switch and the energizing coils of the contactors. When controller auxiliary contacts are broken by the cam projections, the power circuit of the contactors is opened.



Contactors Assembled in Iron Box.

**Contactors:** They are assembled in a substantial sheet-iron box which can be placed in any convenient position under the car. A very effective magnetic blowout is provided for extinguishing arcs between the contacts of the contactors, and currents far in excess of those usually encountered during short circuits can be satisfactorily broken.

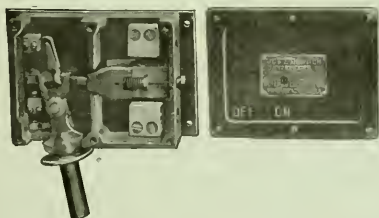

MU-3-A Tripping Switch.

**MU Tripping Switches:** As the current interrupted by the switch is only that required to energize the contactor coils its moving parts have little inertia, so that the auxiliary circuit is broken immediately the current in the tripping coil carrying the motor circuit reaches a predetermined value, which can be varied by the adjusting screw in the tripping switch.

Prevent controller blow-ups with attendant accidents—eliminate all serious arcing from car platform both in controller and circuit breakers—increase economy of operation and decrease maintenance cost. The contactors are normally operated by attachments in the controllers and are also automatically opened on overload.

Chicago Office:  
Monadnock Bldg.

Principal Office:  
Schenectady, N. Y.

Sales Offices in  
All Large Cities

**TELL THE PEOPLE**

**E. C. Van Valkenburgh**  
Promotional Advertising  
for Electric Railways

2117 West 102d Street : Chicago

*A well-laid plan and Van Valkenburgh Advertising Service will make your advertising successful.*

**When buying steel measuring tapes** 

for absolutely accurate work it's worth while seeing to it that they were made by

**THE LUFKIN RULE CO.** New York  
London, England  
Windsor, Canada

SAGINAW, MICH., U. S. A.

**VALVES—FITTINGS—STEAM SPECIALTIES**

**CRANE CO.**  
CHICAGO  
ESTABLISHED 1855

**ECLIPSE**  
**Life Guard**

Manufactured by the  
**ECLIPSE RAILWAY SUPPLY CO.**  
Cleveland, Ohio



**Mica Prices Reduced**

*Compare our prices on Raw Mica and Manufactured Mica with prices you have been paying our competitors.*

**WHY PAY FANCY PRICES?**

**CHICAGO MICA CO.**  
VALPARAISO : : : INDIANA

**ALBERT & J. M. ANDERSON MFG. CO.,**  
Makers of

**ELECTRICAL APPLIANCES:**  
SWITCHES, SWITCHBOARDS,  
TIME SWITCHES, LINE MATERIAL,  
COPPERCASTINGS (75%) CONDUCTIVITY.  
289-293 A ST., BOSTON, MASS., U. S. A.

Branches: Chicago, 175 Dearborn Street.  
New York, 135 Broadway.

Agencies:  
Boston, Pettigell-Andrews Co. San Francisco, Eccles & Smith Co.  
New York, R. W. Marshall & Co. Atlanta, Newcomer-Manly Co.  
St. Louis, J. C. White. Denver, E. M. Mesaiter.  
Toronto, Ont., H. J. Surtees.

**You can lease a**  
**Portable Bonding Car**

and do bonding and rebonding by the modern methods of

**Electric Brazing**  
and **Copper Welding**

at an approximate labor cost of installation of *12 cents per bond.*

No other method within reaching distance of this cost can produce results equal to or even approaching ours for perfect conductivity and long life.

*Proof is yours for the asking.*

**THE ELECTRIC RAILWAY IMPROVEMENT COMPANY**  
6005 Carnegie Avenue CLEVELAND, OHIO

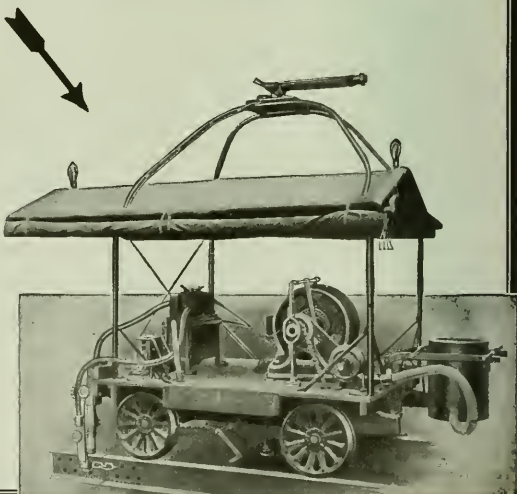

# Electric Railway Review

PUBLISHED EVERY SATURDAY.

FORMERLY THE STREET RAILWAY REVIEW.

THE WILSON COMPANY, CHICAGO.

160 Harrison Street, Chicago  
150 Nassau Street, New York  
1529 Williamson Bldg., Cleveland

VOL. XIX  
No. 17

CHICAGO, APRIL 25, 1908

Whole No. 261      Subscription: Domestic . . . \$2  
Foreign . . . \$5  
Canada . . . \$3.50

## The Time to Advertise

¶ You have heard about the old man living in a house with a leaky roof. Said when it rained he couldn't make repairs and when it didn't rain there was no need of making them.

¶ Some manufacturers are a good deal like the old man. When they are doing a good business they think they don't need to advertise, and when business is poor they think they can't afford to.

¶ But this is a mistaken idea, for the time to advertise is all the time you want to do business. You can't afford to drop out of sight at any time unless you are ready to quit doing business.

¶ *Advertising* means telling everybody who ought to do business with you what you can do for them and why they should patronize you.

¶ The time to do this is *now*—and tomorrow, next week, next month and next year—all the time you want to do business.

¶ And the place to advertise to reach traction buyers is in the

**Electric Railway Review**

# National Air Compressors

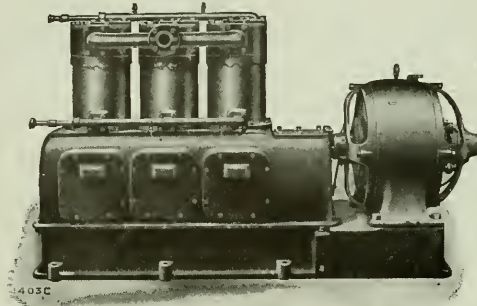

100 cu. ft. Type "3VS" Air Compressor.

These Compressors are especially adapted for service in car shops and barns, where compressed air is used, for various industrial operations, as well as for blowing dust and other accumulations out of car motors, controllers and seats.

Either direct or alternating current motors can be furnished for operating same.

Automatic starters which start and stop the Compressors and keep the air supply within the desired range of pressures are furnished with each Compressor.

Type "3VS" Compressors are built in capacities of 50, 100, 150 and 225 cu. ft. of free air per minute.

Write for Bulletin 84-F

## National Brake & Electric Company

MILWAUKEE, WIS., U. S. A.

NEW YORK: 111 Broadway

SAN FRANCISCO, CAL.: W. F. McKenny, 69-71 First St.

LONDON: 14 Great Smith St., Westminster

General Sales Office: 519 First National Bank Building, Chicago

PHILADELPHIA: W. H. Goble, 1722 Westmoreland St.

BOSTON: F. E. Huntress, 131 State St.

Roads that are using

### Whitmore's Gear Protective Composition

have reduced their gear and pinion cost one half what it previously cost with other lubricants. The proof of this the users will substantiate.

The Whitmore Manufacturing Company  
LUBRICATING ENGINEERS  
Cleveland, Ohio, U. S. A.

### The SIGNAL SYSTEM

that prevents accidents, facilitates traffic and promotes adherence to schedules

is made by the

Telegraph Signal Co.  
82 State St., Rochester, N. Y.



### "Not an Experiment"

The Providence Fender is the Children's Fender. It is equally as effective in saving a child, and the person who has stumbled, as it is in saving those who are on their feet.

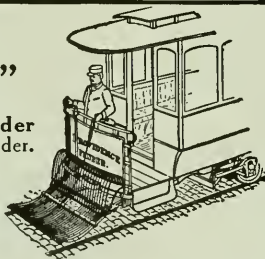

CONSOLIDATED CAR FENDER COMPANY

Office and Factory: PROVIDENCE, R. I.

Branch Office: 110 E. Twenty-third St., New York

European Agents: Comptoir d'Electricite, 6, Rue Boudreau, Paris, France

### STEEL WOOL JOURNAL PACKING

- saves one-half the packing
- saves one-third the oil
- saves labor and wear
- prevents hot boxes **positively**

No other packing you ever heard of can do these things!

Send today for free sample

WM. ROBERTSON & COMPANY

General Office: Great Northern Bldg., CHICAGO

Factory: 75 S. Jefferson St., BATTLE CREEK, MICH.

# Westinghouse

## Steam Turbines

The flexibility of the design of Westinghouse Steam Turbines is shown in their increasing application under special conditions and for special work. Our exhaust steam turbine gathers up the exhaust from non-condensing engines, pumps, compressors, etc., and in many cases makes the waste steam produce more power than it did in the primary engine. It will pay you to consider carefully whether you cannot profit by this extraordinary development of our steam turbine. It will also help out compound engines, even if they have been run condensing. Write our nearest office for special advice on this subject.

### The Westinghouse Machine Co.

Steam Turbines, Steam Engines, Gas Engines, Gas Producers, Storage Batteries and The Roney Stoker

New York, 10 Bridge Street  
 Boston, 131 State Street  
 Atlanta, Candler Building  
 St. Louis, Chemical Building

Pittsburg, Westinghouse Building  
 Cleveland, New England Building  
 Chicago, 171 La Salle Street  
 Cincinnati, Traction Building

Philadelphia, North American Building  
 Denver, McPhee Building  
 San Francisco, Hunt, Mirk & Co.



Motor Car and Trailer.

**A Good Time** to equip your cars with improved automatic air brakes is while they are in the shop being overhauled for the summer season. No part of the car equipment is so essential as the brake towards effective handling of heavy summer traffic. You can move large crowds safely, rapidly and on fast schedules when your cars are equipped with Westinghouse "AMM" Automatic Brakes that give graduated release, quick recharge, quick service and high pressure in emergency for one- to five-car train service.

**Westinghouse Traction Brake Co.**  
 Pittsburg, Pa.

## Westinghouse No. 101-B2 Railway Motor

A Modern Motor for Modern Traffic

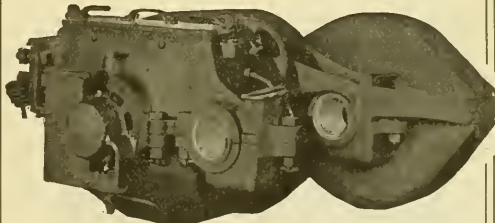

A double equipment is suitable, under usual conditions, for single- or double-truck cars weighing not over 18,000 lbs. without equipment. A quadruple equipment is best for double-truck cars weighing not to exceed 35,000 lbs. without equipment.

Full particulars in Circular 1089

### Westinghouse Electric & Mfg. Co.

Atlanta Cincinnati Kansas City New York Salt Lake City  
 Baltimore Cleveland Los Angeles Philadelphia San Francisco  
 Boston Dallas Minneapolis Pittsburg Seattle  
 Buffalo Denver New Orleans St. Louis Syracuse  
 Chicago Detroit Mexico: G. & O. Branch & Co., City of Mexico  
 Canada: Canadian Westinghouse Co., Ltd., Hamilton, Ont.

## ALPHABETICAL INDEX TO ADVERTISEMENTS.

Advance Lumber Co. ....	Dearborn Drug & Chemical Works .....23	Milloy Electric Co. ....13	Standard Paint Co. ....12
Allis-Chalmers Co. ....	Dessert & Co. ....	Model Stoker Co. ....14	Standard Steel Works. ....16
Aluminum Co. of America. ....11	Drouvé, G., Co. ....	Morden Frog & Crossing Wks. ....	Standard Underground Cable Co. ....
American Brake Shoe & Fdry. ....	Elipse Railway Supply Co. ....16	National Brake & Electric Co. 2	Star Brass Works .....19
American Electrical Works. ....25	Electric Railway Equipment Co. ....15	National Lock Washer Co. ....16	Stone & Webster Engineering Corporation .....11
American Frog & Switch Co. ....16	Electric Ry. Improvement Co. ....26	National Pole Co. ....21	Stuart-Howland Co. ....11
Anderson, Albert & J. M., Mfg. Co. ....26	Electric Service Supplies Co. ....14	Naugle Pole & Tie Co. ....21	Symington, T. H., Co. ....11
Armstrong Oiler Co. ....21	Engineers and Contractors. ....14	New York Switch & Crossing Co. ....	Telegraph Signal Co. ....2
Arnold Company .....14	Fairbanks, Morse & Co. ....	Niles Car & Mfg. Co. ....17	Trolley Supply Co. ....2
Atha Steel Casting Co. ....19	Ford, Bacon & Davis. ....14	Northern Engineering Works. ....	Under-Feed Stoker Co. ....19
Automatic Trolley Guard Co. ....14	Galena-Signal Oil Co. ....5	Nuttall, R. D., Co. ....	U. S. Metal & Mfg. Co. ....22
Babcock & Wilcox Co. ....11	Garford Co. ....21	Ohio Brass Co. ....	Van Dorn & Dutton Co. ....15
Baker, Wm. C., Heating & Supply Co. ....17	General Electric Co. ....25	Okonite Co., Ltd. ....12	Van Dorn, W. T., Co. ....
Baldwin Locomotive Works. ....16	Green Engineering Co. ....14	Pacific Coast Pole Co. ....21	Van Valkenburgh, E. C. ....13
Barbour-Stockwell Co. ....19	Green Fuel Economizer Co. ....	Pantatote Co. ....22	Wanted and For Sale Cards. ....
Barnes, G. H., Hardwood Lumber Co. ....21	Griffin Wheel Co. ....19	Patten, Paul .....22	20
Beidler, Francis, & Co. ....	Hagy, J. Milton, Waste Wks. ....11	Pay-As-You-Enter Car Co. ....9	20
Bellamy Vestlette Mfg. Co. ....	Hale & Kilburn Mfg. Co. ....	Power Specialty Co. ....16	20
Berthold & Jennings. ....	Hartshorn, Stewart, Co. ....12	Pressed Steel Car Co. ....17	20
Bridgeport Brass Co. ....	Heine Safety Boiler Co. ....14	Queen & Co. ....13	20
Brill, J. G., Co. ....24	Heywood Bros. & Wakefield Co. ....	Rail Joint Co. ....16	20
Brown, Harold P. ....15	Holman, D. F., Ry. Tracklayer Co. ....14	Railway Specialty & Supply Co. ....	20
Brown Hoisting Machy. Co. ....14	Humbird Lumber Co., Ltd. ....21	Railway Steel-Spring Co. ....12	20
Buckeye Engine Co. ....	Jewett Car Co. ....17	Register, A. L., & Co. ....14	20
Burnham, Williams & Co. ....16	Johns-Manville, H. W., Co. ....5	Robertson, Wm., & Co. ....2	20
Byllesby, H. M., & Co. ....14	Kalamazoo Ry. Supply Co. ....23	Rodger Ballast Car Co. ....14	20
Central Inspection Bureau. ....14	Lindsay Bros. Co. ....21	Rooke Automatic Register Co. ....23	20
Chase-Shawmut Co. ....5	Lord & Burnham Co. ....13	Russell Car & Snow-Flow Co. ....20	20
Chicago Mica Co. ....26	Lufkin Rule Co. ....26	S-E. Missouri Cypress Co. ....21	20
Churchill Cedar Co. ....21	Lumen Bearing Co. ....26	St. Louis Car Co. ....7	20
Cincinnati Car Co. ....	Macallen Co. ....	St. Louis Car Wheel Co. ....15	20
Cleveland Frog & Cross. Co. ....	McGuire-Cummings Mfg. Co. ....	Sanderson & Porter .....15	20
Collier, Barron G. ....12	Marshall, R. W., & Co. ....20	Saxton, J. C. ....	20
Columbia Construction Co. ....14	Meyers, Fred J., Mfg. Co. ....16	Shimer & Chase Co. ....14	20
Consolidated Car Fender Co. ....2	Miller Anchor Co. ....	Sheaff & Jastaad. ....	20
Consolidated Car-Heating Co. ....12	Moellon Co. ....	Simmons, John, Co. ....16	20
Contractors' Supply & Equipment Co. ....	Morgan, J. W., & Co. ....	Smith, Peter, Blower Co. ....14	20
Crane Co. ....20	Morris, J. W., & Co. ....	Speer Carbon Co. ....	20
Creechhead Engineering Co. ....14	Morris, J. W., & Co. ....	Standard Brake Shoe Co. ....14	20
Curtain Supply Co. ....14	Morris, J. W., & Co. ....	Standard Motor Truck Co. ....22	20
Davis, John, Co. ....	Morris, J. W., & Co. ....		20

## CLASSIFIED LIST OF ADVERTISERS.

Advertising Designs and Plates. Woodbury-Carlton Co., Worcester, Mass.	Axles—(See Wheels and Axles).	Blowers—(See Mechanical Draft)	Brakes and Brake Parts—Continued.
Advertising Service. Van Valkenburgh, E. C., 2117 West One Hundred and Second St., Chicago.	Babbitt Metals—(See Alloys and Bearing Metals).	Blue Printing Machines. Buckeye Engine Co., Salem, O.	Brill, The J. G., Co., Philadelphia.
Advertising, Street Car. Collier, Barron G., Flat Iron Bldg., New York.	Badges and Buttons. Electric Service Supplies Co., 200 Plymouth Bldg., Chicago.	Bollers. Babcock & Wilcox Co., N. Y. Fairbanks, Morse & Co., Chicago. Green Fuel Economizer Co., Mattawan, N. Y. Heine Safety Boiler Co., 421 Ohio St., St. Louis, Mo. Lord & Burnham, Irvington-on-Hudson, New York.	Electric Service Supplies Co., 200 Plymouth Bldg., Chicago. General Electric Co., Schenectady, N. Y. Kuhlman, The G. C., Car Co., Cleveland. McGuire-Cummings Mfg. Co., Chicago. National Brake & Electric Co., Milwaukee. Stephenson, John, Co., Elizabeth, N. J. Wason Mfg. Co., Springfield, Mass. Westinghouse Traction Brake Co., Pittsburg, Pa.
Air Brakes—(See Brakes and Brake Parts).	Ballast Cars—(See Cars, Ballast).	Boiler Cleaning Compounds. Dearborn Drug & Chemical Works, Chicago. Johns-Manville, H. W., Co., New York.	Brakeshoes. American Brake Shoe & Fdry. Co., Mahwah, N. J. American Car Co., St. Louis. Barbour-Stockwell Co., Cambridgeport, Mass. Brill, The J. G., Co., Philadelphia. Kuhlman, The G. C., Car Co., Cleveland. McGuire-Cummings Mfg. Co., Chicago. Marshall, R. W., & Co., 95 Liberty St., New York. St. Louis Car Co., St. Louis, Mo. Standard Brake Shoe Co., Aurora, Ill. Stephenson, John, Co., Elizabeth, N. J. Wason Mfg. Co., Springfield, Mass. Wharton, Wm., Jr., & Co., Philadelphia. Wheel Truing Brake Shoe Co., Detroit.
Air Compressors—(See Compressors, Air).	Balls Bearings. Symington, T. H., Co., Baltimore, Md.	Bonds, Rail. Brown, H. P., 120 Liberty St., New York. Chase-Shawmut Co., Newburyport, Mass. Electric Railway Improvement Co., Cleveland, O. Electric Service Supplies Co., 200 Plymouth Bldg., Chicago. General Electric Co., Schenectady, N. Y. Johns-Manville, H. W., Co., New York. Ohio Brass Co., Mansfield, O.	Bridge Timbers. Beidler, Francis, & Co., Chgo.
Alloys and Bearing Metals. Brown, H. P., 120 Liberty St., New York. General Electric Co., Schenectady, N. Y. Lumen Bearing Co., Buffalo, N. Y. Ohio Brass Co., Mansfield, O. St. Louis Car Co., St. Louis, Mo.	Bases—(See Trolley Poles and Fittings).	Brackets and Cross Arms. Anderson, Albert & J. M., Mfg. Co., Boston. Creaghead Engineering Co., Cincinnati, O. Electric Railway Equipment Co., Cincinnati, O. Electric Service Supplies Co., 200 Plymouth Bldg., Chicago. Johns-Manville, H. W., Co., New York. Lindsley Bros. Co., Spokane, Wash. Ohio Brass Co., Mansfield, O. Stuart-Howland Co., Boston. Western Electric Co., Chicago.	Brushes, Motor and Dynamo. Electric Service Supplies Co., 200 Plymouth Bldg., Chicago. General Electric Co., Schenectady, N. Y. Speer Carbon Co., St. Marye, Pa.
Aluminum Wire, Etc. Aluminum Co. of America, Pittsburg.	Bearings. Electric Service Supplies Co., 200 Plymouth Bldg., Chicago. General Electric Co., Schenectady, N. Y. Lumen Bearing Co., Buffalo, N. Y. McGuire-Cummings Mfg. Co., Chicago. Marshall, R. W., & Co., 95 Liberty St., New York. Nuttall, R. D., Co., Pittsburg. Ohio Brass Co., Mansfield, O. Symington, T. H., Co., Baltimore, Md. Van Dorn & Dutton Co., Cleveland, O.	Brushes, Motor and Dynamo. Electric Service Supplies Co., 200 Plymouth Bldg., Chicago. General Electric Co., Schenectady, N. Y. Speer Carbon Co., St. Marye, Pa.	
Anchor. Electric Service Supplies Co., 200 Plymouth Bldg., Chicago. Miller Anchor Co., Norwalk, O. Ohio Brass Co., Mansfield, O.	Bells and Gongs. American Car Co., St. Louis. Brill, The J. G., Co., Philadelphia.		
Armatures and Colls, Winding and Repairing. Electric Service Supplies Co., 200 Plymouth Bldg., Chicago. General Electric Co., Schenectady, N. Y. Marshall, R. W., & Co., 95 Liberty St., New York. Stuart-Howland Co., Boston.	Belt System—(See Signals).		



# WESTERN ELECTRIC

CHICAGO DENVER  
 SAINT LOUIS PITTSBURG  
 SAN FRANCISCO SEATTLE  
**COMPANY** SAINT PAUL NEW YORK  
 CINCINNATI ATLANTA  
 KANSAS CITY PHILADELPHIA  
 SALT LAKE CITY LOS ANGELES

DO YOU KNOW  
 that good insula-  
 tion is like good  
 insurance—it pays.



insulated electric rail-  
 way line material  
 will positively insure  
 your lines against in-  
 sulation troubles.

Write for our Bulletin  
**TODAY**

## An Absolutely Fireproof Wood

To demonstrate the fire-resisting properties of Asbestos Wood, the following test was made:

"A hut 9 by 9 feet was built of two thicknesses of  $\frac{3}{4}$  inch, with a lining of  $\frac{1}{2}$  inch, Asbestos Wood. A wood fire was made in this building which lasted one hour and fifteen minutes, during which time pyrometer readings showed that the heat reached 2100 degrees F.

"During test the side walls were cool enough to permit touching them with the hand, and practically no heat was radiated through the structure.

"After fire had burned one hour and fifteen minutes, a fifty-pound stream of water was turned against the hot inside walls of house.

"After test hut was in good condition, except that the  $\frac{1}{2}$ -inch lining was broken in several places. But little warping could be noticed. A double-walled box made of Asbestos Wood, containing money and papers, which was placed in hut before fire, was found intact and contents uninjured."

This test proved that Asbestos Wood will stand exposure to fire at extreme temperatures for a considerable period without burning, warping or weakening, and that the application of water, while hot, will not crack or disintegrate it.

If interested in fire-proof construction

Write nearest Branch for catalog

### H. W. JOHNS-MANVILLE CO.



Manufacturers of Asbestos and Magnesia Products, Asbestos Roofings, Packings, Electrical Supplies, Etc.

New York	Pittsburg	Minneapolis
Milwaukee	Cleveland	San Francisco
Chicago	Buffalo	Los Angeles
Boston	Baltimore	Seattle
Philadelphia	New Orleans	Dallas
St. Louis	Kansas City	London 744-A

## Electric Railway Lubrication

THE same skillful expert supervision given in this service as in steam railway service has produced most satisfactory results. Lower cost of lubrication with better service.

Including both  
 Rolling Stock  
 and Power House  
 Equipment

We are under contract with many of the largest Street and Interurban railways in the country.

We guarantee cost per thousand miles in Street and Electric Railway Service when conditions warrant it.

Write for further particulars.

Galena-Signal Oil Company  
 FRANKLIN, PENNSYLVANIA

## Shawmut Soldered Bond Cap

to make over your  
**PLUG BONDS**

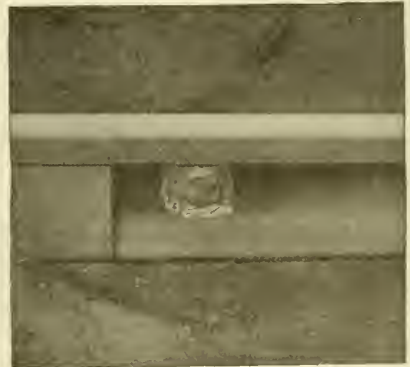

Why not look this up

### CHASE-SHAWMUT CO.

Newburyport, Mass.

## CLASSIFIED LIST OF ADVERTISERS—Continued.

- Bumpers, Car.**  
American Car Co., St. Louis.  
Brill, The J. G., Co., Philadelphia.  
Kuhlman, The G. C., Car Co., Cleveland.  
St. Louis Car Co., St. Louis, Mo.  
Stephenson, John, Co., Elizabeth, N. J.  
Wason Mfg. Co., Springfield, Mass.
- Car House Doors.**  
Wilson, J. G., Mfg. Co., New York.
- Car Replacers.**  
Electric Service Supplies Co., 200 Plymouth Bldg., Chicago.  
Fairbanks, Morse & Co., Chgo. Kalamazoo Railway Supply Co., Kalamazoo, Mich.  
Ohio Brass Co., Mansfield, O.  
U. S. Metal & Mfg. Co., 25 Broad St., New York.
- Car Seats.**  
American Car Co., St. Louis.  
Brill, The J. G., Co., Philadelphia.  
Hale & Kilburn Mfg. Co., Philadelphia.  
Heywood Bros. & Wakefield Co., Wakefield, Mass.  
Kuhlman, The G. C., Car Co., Cleveland.  
St. Louis Car Co., St. Louis, Mo.  
Stephenson, John, Co., Elizabeth, N. J.  
Wason Mfg. Co., Springfield, Mass.
- Car Signs—(See Signs, Cars and Track).**
- Car Steps.**  
Electric Service Supplies Co., 200 Plymouth Bldg., Chicago.
- Car Trimmings—(See Trimmings, Car).**
- Cars, Ballast.**  
Rodger Ballast Car Co., Chgo. St. Louis Car Co., St. Louis, Mo.
- Cars, Dump.**  
Fairbanks, Morse & Co., Chgo. Rodger Ballast Car Co., Chgo. Russell Car & Snow-Plow Co., Ridgway, Pa.  
St. Louis Car Co., St. Louis, Mo.
- Cars, Passenger and Freight.**  
American Car Co., St. Louis.  
Brill, The J. G., Co., Philadelphia.  
Cincinnati Car Co., Cincinnati.  
Detroit Carbuilding & Equipment Co., Detroit, Mich.  
Electric Railway Improvement Co., Cleveland, O.  
Fairbanks, Morse & Co., Chgo. Jewett Car Co., Newark, O.  
Kuhlman, The G. C., Car Co., Cleveland.  
McGuire-Cummings Mfg. Co., Chicago.  
Niles Car & Mfg. Co., Niles, O.  
Pressed Steel Car Co., Pittsburg.  
Rodger Ballast Car Co., Chgo. Russell Car & Snow-Plow Co., Ridgway, Pa.  
St. Louis Car Co., St. Louis, Mo.  
Standard Motor Truck Co., Pittsburg.  
Stephenson, John, Co., Elizabeth, N. J.  
Wason Mfg. Co., Springfield, Mass.
- Cars, Pay-As-You-Enter.**  
Pay-As-You-Enter Car Co., 26 Cortlandt St., New York.
- Cars, Rebuilt.**  
Detroit Carbuilding & Equipment Co., Detroit, Mich.
- Cars, Second-Hand.**  
Detroit Carbuilding & Equipment Co., Detroit, Mich.  
Marshall, R. W., & Co., 95 Liberty St., New York.  
Zelicker, Walter A., Supply Co., St. Louis.
- Cars, Steel.**  
Pressed Steel Car Co., Pittsburg.  
St. Louis Car Co., St. Louis, Mo.  
Standard Motor Truck Co., Pittsburg.
- Castings, Brass.**  
Star Brass Works, Kalamazoo, Mich.
- Castings, Iron and Steel.**  
American Brake Shoe & Foundry Co., Mahwah, N. J.  
Green Engineering Co., Com'l Nat. Bk. Bldg., Chicago.  
National Brake & Electric Co., Milwaukee.  
Standard Steel Works Co., Philadelphia, Pa.  
Washburn Steel Castings & Coupler Co., Minneapolis.
- Catchers—(See Trolley Retrievers and Catchers).**
- Cattle Guards.**  
Fairbanks, Morse & Co., Chgo.
- Circuit-Breakers.**  
Electric Service Supplies Co., 200 Plymouth Bldg., Chicago.  
General Electric Co., Schenectady, N. Y.  
Western Electric Co., Chicago.
- Coal Handling Machinery—(See Conveyors).**
- Coils—(See Armatures and Coils).**
- Commutators and Parts.**  
Electric Service Supplies Co., 1020-24 Filbert St., Phila.  
General Electric Co., Schenectady, N. Y.  
Marshall, R. W., & Co., 95 Liberty St., New York.  
Ohio Brass Co., Mansfield, O.  
Stuart-Howland Co., Boston.
- Compressors, Air.**  
Fairbanks, Morse & Co., Chgo. General Electric Co., Schenectady, N. Y.  
National Brake & Electric Co., Milwaukee.  
Westinghouse Traction Brake Co., Pittsburg.
- Concrete Mixers.**  
Contractors' Supply & Equip. Co., Chicago.
- Condensers.**  
Wheeler Condenser & Engineering Co., Carteret, N. J.
- Conduits.**  
Electric Service Supplies Co., 200 Plymouth Bldg., Chicago.  
Western Electric Co., Chicago.
- Connectors, Solderless.**  
Doehart & Co., 242 W. Forty-first St., New York.
- Contractors.**  
Arnold Company, 181 La Salle St., Chicago.  
Byllesby, H. M., Co., Am. Trust Bldg., Chicago.  
Columbia Construction Co., Milwaukee, Wis.  
Creshead Engineering Co., Cincinnati, O.  
Green Engineering Co., Com'l Nat. Bk. Bldg., Chicago.  
Register, A. L., & Co., 112 N. Broad St., Philadelphia.  
Sanderson & Porter, 52 William St., New York.  
Saxton, E., 341 Bladenburg R., Washington, D. C.  
Sheaf & Jaastad, 88 Broad St., Boston.  
Stone & Webster Engineering Corporation, Boston.  
Wharton, Wm., Jr., & Co., Philadelphia.  
White, J. G., & Co., 49 Exchange Pl., New York.
- Controllers and Attachments.**  
Electric Service Supplies Co., 200 Plymouth Bldg., Chicago.  
General Electric Co., Schenectady, N. Y.  
Johns-Manville, H. W., Co., New York.  
Marshall, R. W., & Co., 95 Liberty St., New York.  
Western Electric Co., Chicago.  
Westinghouse Electric & Mfg. Co., Pittsburg.
- Conveyors and Coal Handling Machinery.**  
Green Engineering Co., Com'l Nat. Bk. Bldg., Chicago.  
Northern Engineering Works, Detroit, Mich.
- Cord, Bell and Trolley.**  
American Car Co., St. Louis.  
Brill, The J. G., Co., Philadelphia.
- Cord, Bell and Trolley—Continued.**  
Electric Service Supplies Co., 1020-24 Filbert St., Phila.  
Kuhlman, The G. C., Car Co., Cleveland.  
St. Louis Car Co., St. Louis, Mo.  
Stephenson, John, Co., Elizabeth, N. J.  
Stuart-Howland Co., Boston.  
Wason Mfg. Co., Springfield, Mass.
- Couplers, Car.**  
American Car Co., St. Louis.  
Brill, The J. G., Co., Philadelphia.  
Kuhlman, The G. C., Car Co., Cleveland.  
McGuire-Cummings Mfg. Co., Chicago.  
Ohio Brass Co., Mansfield, O.  
St. Louis Car Co., St. Louis, Mo.  
Stephenson, John, Co., Elizabeth, N. J.  
Van Dorn, W. T., Co., Paulina St., Chicago.  
Washburn Steel Castings & Coupler Co., Minneapolis.  
Wason Mfg. Co., Springfield, Mass.
- Coverings, Pipe and Boiler.**  
Johns-Manville, H. W., Co., New York.
- Cranes, Hoists and Lifts.**  
American Car Co., St. Louis.  
Brill, The J. G., Co., Philadelphia.  
Brown Hoisting Machinery Co., Cleveland, O.  
Kuhlman, The G. C., Car Co., Cleveland.  
Northern Engineering Works, Detroit, Mich.  
Railway Specialty & Supply Co., Chicago.  
Stephenson, John, Co., Elizabeth, N. J.  
Van Dorn & Dutton Co., Cleveland, Ohio.  
Wason Mfg. Co., Springfield, Mass.
- Cross Arms—(See Brackets and Cross Arms).**
- Crossing Gates—(See Gates and Guards).**
- Crossings, Track—(See Switches, Frogs and Crossings).**
- Curtains, Fixtures and Materials.**  
American Car Co., St. Louis.  
Brill, The J. G., Co., Philadelphia.  
Curtain Supply Co., 93 Ohio St., Chicago.  
Electric Service Supplies Co., 200 Plymouth Bldg., Chicago.  
Hartshorn, Stewart, Co., East Newark, N. J.  
Kuhlman, The G. C., Car Co., Cleveland.  
Marshall, R. W., & Co., 95 Liberty St., New York.  
National Lock Washer Co., Newark, N. J.  
Pantatote Co., 11 Broadway, New York.  
St. Louis Car Co., St. Louis, Mo.  
Stephenson, John, Co., Elizabeth, N. J.  
Wason Mfg. Co., Springfield, Mass.
- Cylinder Oil.**  
Power Specialty Co., 111 Broadway, N. Y.
- Derailing Devices.**  
American Frog & Switch Co., Hamilton, O.  
Cleveland Frog & Crossing Co., Cleveland, O.
- Doors and Fixtures.**  
American Car Co., St. Louis.  
Brill, The J. G., Co., Philadelphia.  
Kuhlman, The G. C., Car Co., Cleveland.  
St. Louis Car Co., St. Louis, Mo.  
Stephenson, John, Co., Elizabeth, N. J.  
Wason Mfg. Co., Springfield, Mass.
- Doors, Steel Rolling.**  
Wilson, J. G., Mfg. Co., New York.
- Draft, Mechanical—(See Mechanical Draft).**
- Draft Rigging.**  
Van Dorn, W. T., Co., Chgo. Washburn Steel Castings & Coupler Co., Minneapolis.
- Drills, Track.**  
Brown, H. P., 120 Liberty St., New York.  
Electric Service Supplies Co., 200 Plymouth Bldg., Chicago.  
Fairbanks, Morse & Co., Chgo. Kalamazoo Railway Supply Co., Kalamazoo, Mich.  
Marshall, R. W., & Co., 95 Liberty St., New York.
- Drying Appliances.**  
Green Fuel Economizer Co., Matteawan, N. Y.
- Dynamos and Generators.**  
Fairbanks, Morse & Co., Chgo. General Electric Co., Schenectady, N. Y.  
National Brake & Electric Co., Milwaukee, Wis.  
Western Electric Co., Chicago.  
Westinghouse Electric & Mfg. Co., Pittsburg, Pa.
- Economizers, Fuel.**  
Green Fuel Economizer Co., Matteawan, N. Y.
- Electrical Instruments.**  
Electric Service Supplies Co., 200 Plymouth Bldg., Chicago.  
General Electric Co., Schenectady, N. Y.  
Johns-Manville, H. W., Co., New York.  
Queen & Co., Philadelphia.  
Western Electric Co., Chicago.  
Westinghouse Electric & Mfg. Co., Pittsburg, Pa.  
Weston Electrical Instrument Co., Newark, N. J.
- Electric Railway Supplies, General.**  
Creshead Engineering Co., Cincinnati, O.  
Electric Service Supplies Co., 200 Plymouth Bldg., Chicago.  
Fairbanks, Morse & Co., Chgo. General Electric Co., Schenectady, N. Y.  
Johns-Manville, H. W., Co., New York.  
Marshall, R. W., & Co., 95 Liberty St., New York.  
Ohio Brass Co., Mansfield, O.  
Stuart-Howland Co., Boston.  
Western Electric Co., Chicago.
- Engine Apparatus.**  
Green Fuel Economizer Co., Matteawan, N. Y.
- Engineers and Contractors.**  
Arnold Company, Chicago.  
Bacon, E. M., & Co., Chgo. Columbia Construction Co., Milwaukee, Wis.  
Ford, Bacon & Davis, New York.  
Register, A. L., & Co., Philadelphia.  
Sanderson & Porter, New York.  
Saxton, E., Washington, D. C.  
Sheaf & Jaastad, Boston.  
Stone & Webster Engineering Corporation, Boston.  
White, J. G., & Co., New York.
- Engines, Gas and Oil.**  
Buckeye Engine Co., Salem, O.  
Fairbanks, Morse & Co., Chgo. Westinghouse Machine Co., Pittsburg.
- Engines, Hoisting.**  
Fairbanks, Morse & Co., Chgo.
- Engines, Steam.**  
Buckeye Engine Co., Salem, O.  
Westinghouse Machine Co., Pittsburg.
- Fans, Exhaust and Ventilating.**  
General Electric Co., Schenectady, N. Y.  
Green Fuel Economizer Co., Matteawan, N. Y.  
Western Electric Co., Chicago.  
Westinghouse Elec. & Mfg. Co., Pittsburg.
- Fare Boxes—(See Electric Railway Supplies).**
- Fare Registers and Register Fittings.**  
Electric Service Supplies Co., 200 Plymouth Bldg., Chicago.  
Rooke Automatic Register Co., Providence, R. I.

# ST. LOUIS CAR CO. ST. LOUIS-MO.



## St. Louis Car Company's Semi-Convertible Type

The illustration represents one of the cars recently shipped by us to the Houston Electric Company, Houston, Texas.

These cars are of our own design—a practically perfect Semi-Convertible type. Both lower and upper sashes raise into the roof. They move easily and when in the roof pockets are securely fastened, with no possible danger of falling and injuring passengers.

### Our construction of the Semi-Convertible Car is the very best that has yet been devised

These Houston cars are 28' over corner posts and 31' 6" over all. Width over arm rail, 8' 6". They are finished with very handsomely figured mahogany, provided with curtains at each window and each door opening and have the St. Louis Car Company's latest improved "Walkover" seat.

The cars are mounted on St. Louis Car Company's No. 47 Short Wheel Base Truck, which has been adopted as standard in a great many of the larger cities. The channel-iron and steel construction of the "Robertson type" permits the arm rail of the car to be placed very low and adds much to the appearance.

*Photographs, Blue Prints and Specifications will be mailed upon request.*

## CLASSIFIED LIST OF ADVERTISERS—Continued.

- Feedwater Apparatus.**  
Green Fuel Economizer Co.,  
Matteawan, N. Y.  
Wheeler Condenser & Engineering Co., Carteret, N. J.
- Feed Wire—(See Wire and Cables).**
- Fenders and Guards.**  
Consolidated Car Fender Co.,  
Providence, R. I.  
Eclipse Railway Supply Co.,  
Cleveland, O.  
Electric Service Supplies Co.,  
1020-24 Filbert St., Phila.  
McGuire-Cummings Mfg. Co.,  
Chicago.
- Marshall, R. W. & Co., 95  
Liberty St., New York.
- Flangers, Snow.**  
Kalamazoo Railway Supply  
Co., Kalamazoo, Mich.  
McGuire-Cummings Mfg. Co.,  
Chicago.
- Ohio Brass Co., Mansfield, O.  
Van Dorn & Dutton Co.,  
Cleveland, O.
- Frogs—(See Switches, Frogs and Crossings).**
- Fuel Economizers—(See Economizers, Fuel).**
- Fuses and Fuse Devices.**  
Chase-Shawmut Co., New-  
buryport, Mass.  
Electric Service Supplies Co.,  
200 Plymouth Bldg., Chicago.  
General Electric Co., Schenec-  
tady, N. Y.  
Johns-Manville, H. W., Co.,  
New York.  
Western Electric Co., Chicago.  
Westinghouse Elec. & Manu-  
facturing Co., Pittsburg.
- Gasket, Bronze.**  
Power Specialty Co., 111  
Broadway, New York.
- Gates and Guards.**  
Kalamazoo Railway Supply  
Co., Kalamazoo, Mich.
- Gear Cases.**  
Electric Service Supplies Co.,  
200 Plymouth Bldg., Chicago.  
General Electric Co., Schenec-  
tady, N. Y.  
Marshall, R. W. & Co., 95  
Liberty St., New York.
- Gears and Pinions.**  
Electric Service Supplies Co.,  
200 Plymouth Bldg., Chicago.  
General Electric Co., Schenec-  
tady, N. Y.  
Marshall, R. W. & Co., 95  
Liberty St., New York.  
Nuttall, R. D. Co., Pittsburg.  
Van Dorn & Dutton Co.,  
Cleveland, O.
- Generators—(See Dynamos).**
- Gongs—(See Bells and Gongs).**
- Graphite Paint—(See Paint).**
- Grates, Chain.**  
Green Engineering Co., Com'l  
Nat. Bldg., Chicago.
- Grease—(See Lubricants).**
- Grinders.**  
Brown, Harold P., 120 Liberty  
St., New York.
- Ground Connection Clamps.**  
Chase-Shawmut Co., New-  
buryport, Mass.
- Guy Anchors—(See Anchors).**
- Harps, Trolley—(See Trolley Poles and Fittings).**
- Headlights.**  
Electric Service Supplies Co.,  
200 Plymouth Bldg., Chicago.  
Fairbanks, Morse & Co., Chgo.  
General Electric Co., Schenec-  
tady, N. Y.  
St. Louis Car Co., St. Louis,  
Mo.  
Stuart-Howland Co., Boston.  
Trolley Supply Co., Canton, O.
- Heaters, Car, Electric.**  
Consolidated Car-Heating Co.,  
Albany, N. Y.  
Johns-Manville, H. W., Co.,  
New York.
- Heaters, Car, Hot Water, and  
Stoves.  
Baker, The Wm. C., Heating  
& Sipp. Co., New York.  
McGuire-Cummings Mfg. Co.,  
Chicago.  
Smith, Peter, Heater Co., Des-  
toit, Mich.
- Heating and Ventilating Apparatus—(See Mech. Draft).**
- Hoists—(See Cranes, Hoists and Lifts).**
- Hose Bridges.**  
Ohio Brass Co., Mansfield, O.
- Hydraulic Machinery.**  
Watson-Stillman Co., 26 Cort-  
landt St., New York.
- Inspection.**  
Central Inspection Bureau.
- Inspection Cars, Gasoline.**  
Stover Motor Car Co., Free-  
port, Ill.
- Instruments, Measuring and Testing—(See Electrical Instruments).**
- Insulating Tapes.**  
General Electric Co., Schenec-  
tady, N. Y.  
Johns-Manville, H. W., Co.,  
New York, N. Y.  
Okonite Co., Ltd., 253 Broad-  
way, New York.  
Western Electric Co., Chicago.
- Insulations and Insulating Material.**  
Anderson, A. & J. M., Mfg.  
Co., Boston.  
Craghead Engineering Co.,  
Cincinnati, O.  
Electric Railway Equipment  
Co., Cincinnati, O.  
Electric Service Supplies Co.,  
200 Plymouth Bldg., Chicago.  
General Electric Co., Schenec-  
tady, N. Y.  
Johns-Manville, H. W., Co.,  
New York.  
Macallen, The Co., Boston.  
Ohio Brass Co., Mansfield, O.  
Okonite Co., Ltd., 253 Broad-  
way, New York.  
Standard Paint Co., 100 Will-  
iam St., New York.  
Stuart-Howland Co., Boston.  
Western Electric Co., Chicago.
- Jacks.**  
American Car Co., St. Louis.  
Brill, The J. G., Co., Phila-  
delphia.  
Electric Service Supplies Co.,  
200 Plymouth Bldg., Chicago.  
Fairbanks, Morse & Co., Chgo.  
Kalamazoo Railway Supply  
Co., Kalamazoo, Mich.  
Kuhlman, The G. C., Car Co.,  
Cleveland.  
Marshall, R. W. & Co., 95  
Liberty St., New York.  
Morden Frog & Crossing Co.,  
Chicago.  
Stephenson, John, Co., Eliza-  
beth, N. J.  
Wason Mfg. Co., Springfield,  
Mass.  
Watson-Stillman Co., 26 Cort-  
landt St., New York.
- Joints, Expansion—(See Steam Fittings).**
- Joints, Rail.**  
Rail Joint Co., 29 W. 34th St.,  
New York.
- Joints, Welded—(See Rail Joints, Welded).**
- Journal Boxes.**  
American Car Co., St. Louis.  
Brill, The J. G., Co., Phila-  
delphia.  
Kuhlman, The G. C., Car Co.,  
Cleveland.  
McGuire-Cummings Mfg. Co.,  
Chicago.  
St. Louis Car Co., St. Louis,  
Mo.  
Stephenson, John, Co., Eliza-  
beth, N. J.  
Symington, T. H., Co., Balti-  
more, Md.  
Wason Mfg. Co., Springfield,  
Mass.
- Journal Lubricators—(See Lubricants).**
- Journal Packing, Steel Wool.**  
Robertson, Wm., & Co., Fifth  
Floor Great Northern Bldg.,  
Chicago.
- Lamps, Arc and Incandescent.**  
Anderson, A. & J. M., Mfg.  
Co., Boston.  
Electric Service Supplies Co.,  
200 Plymouth Bldg., Chicago.  
General Electric Co., Schenec-  
tady, N. Y.  
Stuart-Howland Co., Boston.  
Western Electric Co., Chicago.  
Westinghouse Electric & Mfg.  
Co., Pittsburg, Pa.
- Lamp Sockets.**  
Electric Service Supplies Co.,  
200 Plymouth Bldg., Chicago.  
General Electric Co., Schenec-  
tady, N. Y.  
Johns-Manville, H. W., Co.,  
New York, N. Y.
- Lantern Globes.**  
Railway Specialty & Supply  
Co., Chicago.
- Lifts—(See Cranes, Hoist and Lift).**
- Lightning Arresters.**  
Electric Service Supplies Co.,  
200 Plymouth Bldg., Chicago.  
General Electric Co., Schenec-  
tady, N. Y.  
Stuart-Howland Co., Boston.  
Western Electric Co., Chicago.  
Westinghouse Elec. & Manu-  
facturing Co., Pittsburg.
- Line Material.**  
Anderson, A. & J. M., Mfg.  
Co., Boston.  
Craghead Engineering Co.,  
Cincinnati, O.  
Johns-Manville, H. W., Co.,  
New York.  
Electric Ry. Equipment Co.,  
Cincinnati, O.  
Electric Service Supplies Co.,  
200 Plymouth Bldg., Chicago.  
General Electric Co., Schenec-  
tady, N. Y.  
Macallen, The Co., Boston.  
Marshall, R. W. & Co., 95  
Liberty St., New York.  
Stuart-Howland Co., Boston.  
Western Electric Co., Chicago.
- Lock and Nut Washers.**  
National Lock Washer Co.,  
Newark, N. J.
- Lockers, Metal.**  
Electric Service Supplies Co.,  
200 Plymouth Bldg., Chicago.
- Locomotives.**  
Baldwin Locomotive Works,  
Philadelphia.
- Locomotives, Electric.**  
American Car Co., St. Louis.  
Baldwin Locomotive Works,  
Philadelphia.  
Brill, The J. G., Co., Phila-  
delphia.  
General Electric Co., Schenec-  
tady, N. Y.  
Kuhlman, The G. C., Car Co.,  
Cleveland.  
McGuire-Cummings Mfg. Co.,  
Chicago.  
Stephenson, John, Co., Eliza-  
beth, N. J.  
Wason Mfg. Co., Springfield,  
Mass.  
Westinghouse Elec. & Manu-  
facturing Co., Pittsburg.
- Locomotives, Gasoline.**  
Fairbanks, Morse & Co., Chgo.  
Stover Motor Car Co., Free-  
port, Ill.
- Lubricants.**  
Dearborn Drug & Chemical  
Works, Chicago.  
Galena-Signal Oil Co., Frank-  
lin, Wash.  
Whitmore Mfg. Co., Clevel-  
and, O.
- Lumber.**  
Advance Lumber Co., Clevel-  
and, O.  
Barnes, G. H., Hardwood  
Lumber Co., St. Louis, Mo.  
Beidler, Francis, & Co., Chgo.  
Berthold & Jennings, St.  
Louis.  
Lindsay Bros. Co., Spokane,  
Wash.  
S-E. Missouri Cypress Co.,  
Campbell, Mo.
- Malleable Iron.**  
St. Louis Car Co., St. Louis,  
Mo.
- Measuring Tapes.**  
Lufkin Rule Co., Saginaw,  
Mich.
- Mechanical Draft.**  
Green Fuel Economizer Co.,  
Matteawan, N. Y.
- Meters.**  
Johns-Manville, H. W., Co.,  
New York.  
Queen Co., Philadelphia.  
Weston Electrical Instrument  
Co., Newark, N. J.
- Mica, Raw and Manufactured.**  
Chicago Mica Co., Valparaiso,  
Ind.
- Motor Cars, Gasoline.**  
Stover Motor Car Co., Free-  
port, Ill.
- Motors, Electric.**  
Fairbanks, Morse & Co., Chgo.  
General Electric Co., Schenec-  
tady, N. Y.  
National Brake & Electric Co.,  
Milwaukee.  
Western Electric Co., Chicago.  
Westinghouse Elec. & Manu-  
facturing Co., Pittsburg.
- Nut Locks.**  
Chase-Shawmut Co., New-  
buryport, Mass.  
National Lock Washer Co.,  
Newark, N. J.  
Railway Specialty & Supply  
Co., Chicago.  
St. Louis Car Co., St. Louis,  
Mo.  
U. Metal & Mfg. Co., 25  
Broad St., New York.
- Nuts and Bolts.**  
National Lock Washer Co.,  
Newark, N. J.  
Railway Specialty & Supply  
Co., Chicago.
- Oilers.**  
Armstrong Oiler Co., 31st and  
Chestnut St., Philadelphia.
- Oils—(See Lubricants).**
- Overhead Equipment—(See Electric Railway Supplies).**
- Packings.**  
Electric Service Supplies Co.,  
200 Plymouth Bldg., Chicago.  
Johns-Manville, H. W., Co.,  
New York.  
Power Specialty Co., 111  
Broadway, New York.
- Packing, Steel Wool Journal.**  
Robertson, Wm., & Co., Fifth  
Floor Great Northern Bldg.,  
Chicago.
- Paints.**  
Standard Paint Co., 100 Will-  
iam St., New York.
- Pay-As-You-Enter Cars.**  
Pay-As-You-Enter Car Co., 26  
Cortlandt St., New York.
- Pipe Bands and Fittings—(See Steam Fittings).**
- Poles, Metal.**  
Craghead Engineering Co.,  
Cincinnati, O.  
Electric Railway Equipment  
Co., Cincinnati, O.  
Electric Service Supplies Co.,  
200 Plymouth Bldg., Chicago.
- Poles and Ties, Wood.**  
Advance Lumber Co., Clevel-  
and, O.  
Barnes, G. H., Hardwood  
Lumber Co., St. Louis, Mo.  
Beidler, Francis, & Co., Chgo.  
Berthold & Jennings, St. Louis.  
Churchill Cedar Co., Spokane,  
Wash.  
Humbird Lumber Co., Sand  
Point, Idaho.  
Lindsay Bros. Co., Spokane,  
Wash.  
National Pole Co., Escanaba,  
Mich.  
Naugle Pole & Tie Co., 226  
La Salle St., Chicago.  
Pacific Coast Pole Co., Spoka-  
ne, Wash.  
S-E. Missouri Cypress Co.,  
Campbell, Mo.  
Worcester, C. H., Co., Tribune  
Bldg., Chicago.
- Promoters of Railway Projects.**  
Shimer & Chase Co., Omaha,  
Neb.
- Punches—(See Ticket Punches).**
- Rail Benders.**  
Electric Service Supplies Co.,  
200 Plymouth Bldg., Chicago.  
Fairbanks, Morse & Co., Chgo.

The popularity of  
**Pay-As-You-Enter Cars**  
 increases with continued use

The more times passengers ride in them, the better they are pleased.

The more trips the car crews make in them, the better they are satisfied.

The more Pay-As-You-Enter Cars a company has in operation, the more nickels it collects and the fewer accidents it suffers.

These facts have been proven by successful operation in Chicago, New York, Buffalo, Newark and Montreal. And they will be proven again when you install Pay-As-You-Enter Cars upon your most congested lines - the ones from which you receive most complaint and upon which you have the most accidents and lose the most nickels.



We license manufacturers and railways to build and use the Pay-As-You-Enter Car, the patents on which are owned by

**The Pay-As-You-Enter Car Company**

DUNCAN McDONALD  
 President

50 Church Street, New York

THOS. W. CASEY  
 Manager

## CLASSIFIED LIST OF ADVERTISERS—Continued.

- Rail Bonds—(See Bonds, Rail).
- Rail Bonds, Flexible.  
Chase-Shawmut Co., Newburyport, Mass.
- Rail Drills—(See Drills, Track).
- Rail Feed Wire—(See Wire and Cables).
- Rail Joints and Chairs—(See Joints, Rail).
- Rails, New.  
New York Switch & Crossing Co., Hoboken, N. J.  
Wharton, Wm., Jr., & Co., Philadelphia.
- Rails, Relaying.  
Zelicker, Walter A., Supply Co., St. Louis.
- Railway Velocipedes.  
Fairbanks Morse & Co., Chgo.  
Kalamazoo Railway Supply Co., Kalamazoo, Mich.
- Registers and Fittings—(See Fare Registers).
- Relays.  
Weston Electrical Instrument Co., Newark, N. J.
- Roofing.  
Johna-Manville, H. W., Co., New York.
- Sand Apparatus.  
American Car Co., St. Louis.  
Brill, The J. G., Co., Philadelphia.  
Electric Service Supplies Co., 200 Plymouth Bldg., Chicago.  
Kuhlman, The G. C., Car Co., Cleveland.  
Marshall, R. W., & Co., 95 Liberty St., New York.  
Ohio Brass Co., Mansfield, O., St. Louis Car Co., St. Louis, Mo.  
Stephenson, John, Co., Elizabeth, N. J.  
Wason Mfg. Co., Springfield, Mass.
- Sash Balances and Fixtures.  
National Lock Washer Co., Newark, N. J.
- Sash Operating Devices.  
Drouv, The G. Co., Bridgeport, Conn.  
Lord & Burnham, Irvington-on-Hudson, New York.
- Seats, Car—(See Car Seats).
- Shade Rollers—(See Curtains, Fixtures and Materials).
- Signals.  
Telegraph Signal Co., Rochester, N. Y.
- Signal Supplies.  
Railway Specialty & Supply Co., Chicago.
- Skylights.  
Drouv, The G. Co., Bridgeport, Conn.  
Lord & Burnham, Irvington-on-Hudson, New York.
- Snow Plows, Sweepers and Scrapers.  
American Car Co., St. Louis.  
Brill, The J. G., Co., Philadelphia.  
Kalamazoo Railway Supply Co., Kalamazoo, Mich.  
Kuhlman, The G. C., Car Co., Cleveland.  
McGuire-Cummings Mfg. Co., Chicago.  
Russell Car & Snow-Plow Co., Ridgway, Pa.  
Stephenson, John, Co., Elizabeth, N. J.  
Wason Mfg. Co., Springfield, Mass.
- Sockets, Waterproof.  
Johns-Manville, H. W., Co., New York.
- Solder Paste.  
Chase-Shawmut Co., Newburyport, Mass.
- Springs.  
American Car Co., St. Louis.  
Brill, The J. G., Co., Philadelphia.  
Kuhlman, The G. C., Car Co., Cleveland.  
McGuire-Cummings Mfg. Co., Chicago.
- Springs—Continued.  
Marshall, R. W., & Co., 95 Liberty St., New York.  
Railway Steel Spring Co., 71 Broadway, New York.  
St. Louis Car Co., St. Louis, Mo.  
Standard Steel Works Co., Philadelphia, Pa.  
Stephenson, John, Co., Elizabeth, N. J.  
Wason Mfg. Co., Springfield, Mass.
- Sprinkling Cars.  
American Car Co., St. Louis.  
Brill, The J. G., Co., Philadelphia.  
Kuhlman, The G. C., Car Co., Cleveland.  
McGuire-Cummings Mfg. Co., Chicago.  
Stephenson, John, Co., Elizabeth, N. J.  
Wason Mfg. Co., Springfield, Mass.
- Stage Pockets and Plugs.  
Chase-Shawmut Co., Newburyport, Mass.
- Steam Apparatus.  
Green Fuel Economizer Co., Matteawan, N. Y.
- Steam Fittings, Etc.  
Crane Co., Chicago.  
Davis, The John, Co., Chgo.  
Simmons, John, Co., 110 Centre St., New York.  
Power Specialty Co., 111 Broadway, New York.
- Steel Cars.  
American Car Co., St. Louis.  
Brill, The J. G., Co., Philadelphia.  
Kuhlman, The G. C., Car Co., Cleveland.  
St. Louis Car Co., St. Louis, Mo.  
Stephenson, John, Co., Elizabeth, N. J.  
Wason Mfg. Co., Springfield, Mass.
- Steel Tapes.  
Luffkin Rule Co., Saginaw, Mich.
- Stokers.  
Babcock & Wilcox Co., 85 Liberty St., New York.  
Green Engineering Co., Com'l Nat. Bk. Bldg., Chicago.  
Model Stoker Co., Dayton, O.  
Under-Feed Stoker Company of America, Chicago.  
Westinghouse Machine Co., Pittsburg.
- Storage Batteries—(See Batteries).
- Superheaters.  
Power Specialty Co., 111 Broadway, New York.
- Switches, Frogs and Crossings.  
American Frog & Switch Co., Hamilton, O.  
Barbour-Stockwell Co., Cambridgeport, Mass.  
Cleveland Frog & Crossing Co., Cleveland, O.  
Fairbanks, Morse & Co., Chgo.  
Morden Frog & Crossing Co., Rookery, Chicago.  
New York Switch & Crossing Co., Hoboken, N. J.  
Railway Specialty & Supply Co., Chicago.  
Wharton, Wm., Jr., & Co., Philadelphia.
- Switchboards and Switchboard Instruments.  
Anderson, A. & J. M., Mfg. Co., Boston.  
Chase-Shawmut Co., Newburyport, Mass.  
General Electric Co., Schenectady, N. Y.  
Western Electric Co., Chicago.  
Westinghouse Electric & Mfg. Co., Pittsburg.  
Weston Electrical Instrument Co., Newark, N. J.
- Tapes and Webbing.  
Johns-Manville, H. W., Co., New York.  
Okonite Co., Ltd., 253 Broadway, New York.
- Testing Instruments.  
Queen & Co., Philadelphia.  
Weston Electrical Instrument Co., Newark, N. J.
- Test Lamps, Pocket.  
Chase-Shawmut Co., Newburyport, Mass.
- Ticket Choppers and Destroyers.  
Patten, Paul B., Salem, Mass.
- Ticket Punches.  
Mevers, Fred J., Mfg. Co., Hamilton, O.  
Woodman Mfg. & Sup. Co., Boston.
- Ties and Poles, Wood—(See Poles and Ties).
- Timber.  
Beldler, Francis, & Co., Chgo.  
Lindsay Bros. Co., Spokane, Wash.  
S-E. Missouri Cypress Co., Campbell, Mo.
- Tools, Pneumatic—(See Pneumatic Tools).
- Track Cleaners and Scrapers.  
American Car Co., St. Louis.  
Brill, The J. G., Co., Philadelphia.  
Kalamazoo Railway Supply Co., Kalamazoo, Mich.  
Kuhlman, The G. C., Car Co., Cleveland.  
McGuire-Cummings Mfg. Co., Chicago.  
Marshall, R. W., & Co., 95 Liberty St., New York.  
Ohio Brass Co., Mansfield, O.  
Stephenson, John, Co., Elizabeth, N. J.  
Van Dorn & Dutton Co., Cleveland, O.  
Wason Mfg. Co., Springfield, Mass.
- Track Drills—(See Drills, Track).
- Tracklaying Machinery.  
Holman, D. F., Ry., Tracklayer Co., 1102 Ellsworth Bldg., Chicago.
- Track Tools.  
Electric Service Supplies Co., 200 Plymouth Bldg., Chicago.  
Kalamazoo Railway Supply Co., Kalamazoo, Mich.
- Trimmings, Car.  
American Car Co., St. Louis.  
Brill, The J. G., Co., Philadelphia.  
Curtain Supply Co., Park Row Bldg., New York.  
Kuhlman, The G. C., Car Co., Cleveland.  
National Lock Washer Co., Newark, N. J.  
St. Louis Car Co., St. Louis, Mo.  
Stephenson, John, Co., Elizabeth, N. J.  
Wason Mfg. Co., Springfield, Mass.
- Trolley Guards.  
Automatic Trolley Guard Co., 391 Elliott Sq., Buffalo, N. Y.  
Electric Service Supplies Co., 200 Plymouth Bldg., Chicago.
- Trolley Poles and Fittings.  
Garford Company, Elyria, O.  
General Electric Co., Schenectady, N. Y.  
Johns-Manville, H. W., Co., New York.  
Marshall, R. W., & Co., 95 Liberty St., New York.  
Milroy Electric Co., Bucyrus, O.  
Nuttall, R. D., Co., Pittsburg.  
Star Brass Works, Kalamazoo, Mich.  
Trolley Supply Co., Canton, O.  
Westinghouse Electric & Mfg. Co., Pittsburg, Pa.
- Trolley Retrievers and Catchers.  
Electric Service Supplies Co., 1020-24 Filbert St., Phila.  
Milroy Electric Co., Bucyrus, O.  
Trolley Supply Co., Canton, O.
- Trolley Wagons.  
Kalamazoo Railway Supply Co., Kalamazoo, Mich.
- Trolley Wheels—(See Trolley Poles and Fittings).
- Trolley Wire—(See Wire and Cables).
- Trucks, Car.  
American Car Co., St. Louis.  
Baldwin Locomotive Works, Philadelphia.
- Trucks, Car—Continued.  
Brill, The J. G., Co., Philadelphia.  
Kuhlman, The G. C., Car Co., Cleveland.  
McGuire-Cummings Mfg. Co., Chicago.  
St. Louis Car Co., St. Louis, Mo.  
Standard Motor Truck Co., Pittsburg, Pa.  
Stephenson, John, Co., Elizabeth, N. J.  
Van Dorn & Dutton Co., Cleveland, O.  
Wason Mfg. Co., Springfield, Mass.
- Turbines.  
General Electric Co., Schenectady, N. Y.  
Westinghouse Machine Co., Pittsburg, Pa.
- Valves—(See Steam Fittings).
- Varnish.  
Electric Service Supplies Co., 200 Plymouth Bldg., Chicago.  
Standard Paint Co., 100 William St., New York.
- Ventilators.  
Drouv, The G. Co., Bridgeport, Conn.  
Lord & Burnham, Irvington-on-Hudson, New York.
- Vestiettes.  
Bellamy Vestiette Mfg. Co., Cleveland, O.
- Waste, Cotton and Wool.  
Hawley, Milton, Waste Wks., Philadelphia, Pa.  
Railway Specialty & Supply Co., Chicago.
- Water Softening Compounds.  
Dearborn Drug & Chemical Works, Chicago.
- Wheels and Axles.  
American Car Co., St. Louis.  
Brill, The J. G., Co., Philadelphia.  
Griffin Wheel Co., Chicago.  
Kuhlman, The G. C., Car Co., Cleveland.  
McGuire-Cummings Mfg. Co., Chicago.  
Marshall, R. W., & Co., 95 Liberty St., New York.  
Railway Steel-Spring Co., New York.  
St. Louis Car Co., St. Louis, Mo.  
St. Louis Car Wheel Co., St. Louis.  
Standard Steel Works Co., Philadelphia, Pa.  
Stephenson, John, Co., Elizabeth, N. J.  
Wason Mfg. Co., Springfield, Mass.
- Wheel Trinders.  
Wheel Grinding Brake Shoe Co., Detroit, Mich.
- Window Fixtures.  
Drouv, The G. Co., Bridgeport, Conn.
- Wiping Rags.  
Hagy, J. Milton, Waste Wks., Philadelphia, Pa.
- Wire, Aluminum.  
Aluminum Co. of America, Pittsburg, Pa.
- Wire, Insulated.  
Aluminum Co. of America, Pittsburg, Pa.  
American Electrical Works, Providence, R. I.  
General Electric Co., Schenectady, N. Y.  
Okonite Co., Ltd., 253 Broadway, New York.  
Standard Underground Cable Co., Pittsburg, Pa.  
Stuart-Howland Co., Boston.
- Wire and Cables.  
Aluminum Co. of America, Pittsburg, Pa.  
American Electrical Works, Providence, R. I.  
Bridgeport Brass Co., Bridgeport, Conn.  
General Electric Co., Schenectady, N. Y.  
Okonite Co., Ltd., 253 Broadway, New York.  
Standard Underground Cable Co., Pittsburg, Pa.

THE  
**SYMINGTON JOURNAL BOX**  
 IS NOW STANDARD  
 ON 95 PER CENT OF ALL MODERN ELECTRIC TRUCKS

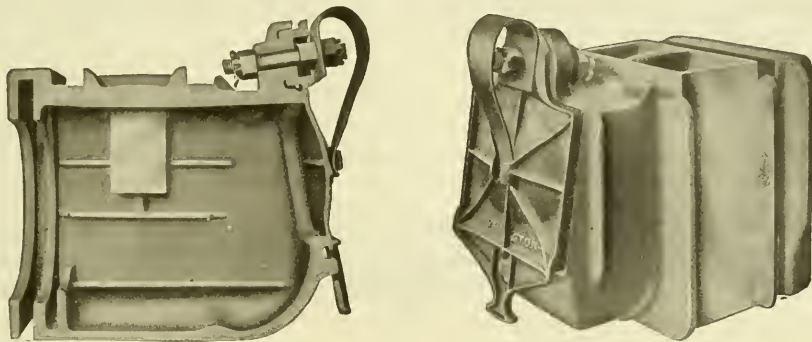

**Special Notice!**

WE ARE PREPARED TO FURNISH AT ONCE  
**REPAIR BOXES**

FOR ANY MAKE OF TRUCK IN SERVICE

BALTIMORE  
 MD.

**THE T. H. SYMINGTON CO.**

CHICAGO  
 ILL.

**THE BABCOCK & WILCOX COMPANY**

85 Liberty Street, New York

Babcock & Wilcox — Stirling — A & T Horizontal — Cahall Vertical

**WATER TUBE STEAM BOILERS**

STEAM SUPERHEATERS

Works: Bayonne, N. J. Barberton, Ohio.

MECHANICAL STOKERS

BRANCH OFFICES:

BOSTON, Delta Bldg.  
 PHILADELPHIA, 1110-1112 North American Bldg.  
 SAN FRANCISCO, 63 First Street  
 PITTSBURGH, Farmers Deposit Nat. Bank Bldg.  
 NEW ORLEANS, 345 Baronne St.

DENVER, 410 Seventeenth St.  
 SALT LAKE CITY, 313 Atlas Block  
 WASHINGTON, Colorado Building  
 CHICAGO, Marquette Bldg.  
 ATLANTA, GA., 1132 Candler Bldg.

CLEVELAND, 706 New England Bldg.  
 MEXICO CITY, 7 Avenida, Juarez  
 HAVANA, CUBA, 116 1/4 Calle de la Habana  
 LOS ANGELES, 321 Trust Bldg.  
 CINCINNATI, O., Traction Bldg.

**Motor Packing Waste**

It is free from dirt and grit, holds the oil better and is easier to pack than ordinary waste.

One packing of the journal box will last longer than with other waste. Used by leading traction companies and electric motor manufacturers.

All grades of white and colored wiping waste, also sanitary cleaned wiping rags. Samples submitted.

**The J. Milton Hagy Waste Works**  
 433 Spruce St. INCORPORATED Philadelphia

**ALUMINUM**

**Railway Feeders**

And all kinds of **Electrical Conductors**

Aluminum Feeders are less than one-half the weight of copper feeders and are of equal conductivity and strength. If insulated wire or cable is required, high grade insulation is guaranteed.

Write for prices and full information.

**Aluminum Company of America**  
 PITTSBURGH, PA.

Formerly The Pittsburgh Reduction Company

**CAR ADVERTISING**  
*Barron & Collier*  
**ALMOST EVERYWHERE**  
 Flat Iron Building, New York.

**OKONITE FEEDER WIRES FOR POWER TRANSMISSION.**

Whether overhead, underground or submarine, success-fully meet the most exacting conditions of modern traction systems. Used by the most prominent Street Railways in the country.

**The Standard for Rubber Insulation**  
 Samples and Estimates on application.

**THE OKONITE CO. Ltd.,** 253 Broadway, NEW YORK  
 WILLARD L. CANDEE, H. DURANT CHEEVER, Managers  
 GEORGE T. MANSON, Gen'l Supt.; W. R. HODGINS, Secretary.

Specify the Genuine Roller. It is that Element that makes a Car Curtain a Success. Every Genuine Roller has the Name of Manufacturer

**HARTSHORN'S**  
**TIN ROLLER**

**STEWART HARTSHORN**  
 IN SCRIPT ON LABEL

**STEWART HARTSHORN CO.**  
 Office and Factory, E. NEWARK, N. J.  
 NEW YORK, 382 Lafayette St. CHICAGO, 338-344 Wabash Ave.

Special Car Rollers are made. Brackets are made for all classes of fittings. Used all over the world wherever cars are run.

**CONSOLIDATED CAR-HEATING COMPANY**

NEW YORK CHICAGO

Office and Station Heaters **ELECTRIC HEATERS** Independent Vestibule Heaters

For All Classes of Cars

**P&B** **Black Baking Varnish**

—especially adapted for insulating street railway motors. Possesses the same high insulative efficiency as P. & B. Clear Baking Varnish. Repels water, oil and dirt, and is non-corrosive. Bakes to a smooth, tough, lustrous, flexible coat, possessing great strength.

*Write for interesting booklet.*

**The Standard Paint Co.** 100 William Street  
 CHICAGO St. Louis Kansas City Boston Philadelphia New Orleans  
 NEW YORK, N. Y. 2

**Railway Steel-Spring Co.**

GENERAL OFFICES: 71 Broadway, NEW YORK

---

Springs  
 Steel-tired Wheels  
 Latrobe Motor Wheel Tires

---

BRANCHES: Chicago, Detroit, Louisville, Mexico City, St. Louis, St. Paul, Washington

**THE WHEEL TRUING BRAKE SHOE**

quickly repairs the crippled wheel and does it while the wheel is running. No argument is needed. Practical railroad men take in the situation at a glance. That is why we sell so many. Best material. Best workmanship. Great experience in this line of work. Low prices.

**The Wheel Truing Brake Shoe Co.**  
 DETROIT, MICHIGAN



**Advertise in the Electric Railway Review**

To get an employe.  
 To secure a job.  
 To sell second-hand machinery, cars, etc.

Want Ads cost only one cent a word per insertion. Special rates on "For Sale" Cards—ask about them.



**W**HEN a salesman calls on you for the purpose of selling you material or supplies, you expect him to show you how and why it is to your advantage to use his goods.

Is there any reason why you should not use as much care in pointing out to your patrons, or those who should be your patrons, the attractions and advantages of your road and your service as does the successful salesman in presenting the strong points of his goods?

The Van Valkenburgh Advertising Service applies the methods of the successful salesman in calling the attention of the public to your commodity—transportation.

Let's get together.



**E. C. Van Valkenburgh**  
**Promotional Advertising**  
**for Electric Railways**  
 2117 West 102d Street, Chicago

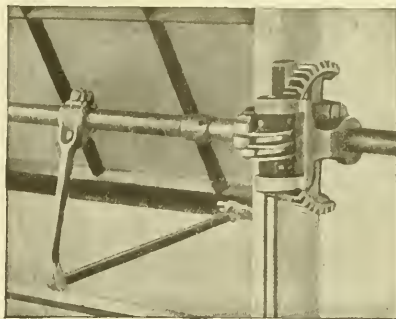

## The Ventilation

of your Shops, Foundries and Car Barns is made especially effective by a speedy, positive and easily manipulated **Sash Operating Apparatus** which automatically locks the sash at any position.

*Let us send you our catalogue.*

**Lord & Burnham Company**  
 Irvington-on-Hudson, N. Y.

## Shaft Straighteners

Our line of hydraulic shaft straighteners comprises portable types varying from the portable shaft straightener for 3½-inch shaft to the 300-ton power shaft straightener. We carry portable tools for bending shaft up to 6-inch diameter, also axle straighteners and stationary bar straighteners.

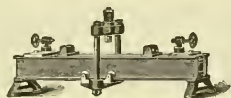

Every tool guaranteed.

**THE WATSON-STILLMAN CO.**

26 Cortlandt Street, New York City  
 Branch Office: 453 The Rookery, Chicago, Ill.



Factory of The Milloy Electric Company  
 Bucyrus, Ohio

## The Milloy Trolley Base

built in our new and specially equipped factory, insures a quality which will give excellent service under ordinary and extraordinary conditions.

The Milloy Base is unusually low, has even tension on high or low wire. Has no fulcrum, no friction, no oil, no center post. Always efficient. Particulars on request.

**THE MILLOY ELECTRIC COMPANY**  
 Bucyrus, Ohio

## WESTON Electrical Instrument Co.

Main Office and Works:  
 WAVERLY PARK, NEWARK, N. J.

**Illuminated**  
**Dial Station**  
**Instruments**

SEND FOR NEW CATALOGUE



Weston Standard Illuminated  
 Dial Station Voltmeter  
 Model 11

Berlin—European Weston Electrical Instrument Co., Ritterstrasse, No. 88  
 Paris, France—E. H. Cadot, 12 Rue St. Georges  
 London—Audrey House, Ely Place, Holborn  
 New York Office—74 Cortlandt St.

## Queen Testing Sets

"The Recognized Standard"

Voltmeters  
 Ammeters  
 Switchboard and Portable  
 Alternating and Direct  
 Current



Queen Aeme Testing Set

U. S. Standard Testing Sets  
 Rail Bond Testers  
 Galvanometers, etc., etc.  
 Electrical Instruments for All Purposes

**QUEEN & CO., Inc., Philadelphia, Pa.**

**THE ARNOLD COMPANY**  
 ENGINEERS-CONSTRUCTORS  
 ELECTRICAL - CIVIL - MECHANICAL  
 181 LA SALLE STREET  
 CHICAGO

**H. M. Byllesby & Company**  
 Incorporated  
 ENGINEERS  
 American Trust Bldg., Chicago

Design, Construct and Operate  
 Railway, Light, Power and  
 Hydraulic Plants

EXAMINATIONS AND  
 REPORTS

**J. G. WHITE & COMPANY**  
 INCORPORATED

**Engineers, Contractors**

43-49 Exchange Place,  
 41-43 Wall Street

**New York, N. Y.**

Principal Philippine Office: Manila, P. I.

**Complete Plants for the Rapid  
 Handling of Material**

Every Sort of Hoisting Apparatus

**BROWN HOISTING MACHINERY CO.** Cleveland, Ohio

**Ford, Bacon & Davis,**  
 Engineers,

115 BROADWAY,  
 NEW YORK.

**Surface, Jet and Barometric Condensers**  
**Edwards Air Pumps Centrifugal Pumps**  
**Water Cooling Towers**

Wheeler Condenser & Engineering Company  
 CARTERET, N. J.

90 West Street, NEW YORK Monadnock Block, CHICAGO, ILL.

**COLUMBIA CONSTRUCTION CO.**  
 BUILDERS OF

**Electric Railways**

Colby and Abbot Building : MILWAUKEE, WIS.

**HART CONVERTIBLE CAR**  
 RODGER BALLAST CAR CO., Railway Exchange, CHICAGO

**For Sale** Cards produce results in the  
 Electric Railway Review

**A. L. REGISTER & CO.**

Engineers and General Contractors--Electric Railways  
 112 North Broad St. PHILADELPHIA, PA. Established 1889

**SHIMER & CHASE CO.**

**Experienced Promoters of Electrical Railway Projects**  
 Correspondence Solicited OMAHA, NEB.

**CENTRAL INSPECTION BUREAU**

Inspection of Rails, Ties, Cars, Motors, Bridges, Buildings, Etc.  
 17 STATE STREET - - - NEW YORK CITY

**LINE MATERIAL**

ELECTRIC SUPPLIES FOR RAILWAYS, POWER PLANTS, ETC.  
 THE CREGHEAD ENGINEERING CO., 345 Main Street, Cincinnati, Ohio

**THE CURTAIN SUPPLY CO.**

CAR CURTAINS  
 CHICAGO, 85-93 Ohio Street Hudson Terminal, 50 Church St., NEW YORK

**HOT WATER HEATERS FOR  
 CARS**

THE PETER SMITH HEATER COMPANY, Detroit, Mich.

**AUTOMATIC TROLLEY GUARD CO.**

391-393 Ellicott Square, Buffalo, N. Y. 3  
 "IT PUTS THE WHEEL ON THE WIRE"

SPRINGS—TIRES—STEEL-TIRED WHEELS  
**RAILWAY STEEL-SPRING CO.**

General Offices: 71 Broadway, New York

**BRAKESHOOES**  
 STANDARD  
 BRAKESHOE COMPANY  
 GEN'L OFFICES & WORKS—AURORA, ILL.—CHICAGO OFFICE—319 IVY BLDG.

**TRACKLAYING BY MACHINERY**

SIMPLE, RAPID AND ECONOMICAL  
 D. F. HOLMAN RAILWAY TRACKLAYER CO., 1102 Ellsworth Bldg., Chicago

**HEINE SAFETY BOILER CO.**

421 OLIVE STREET, ST. LOUIS, MO.  
 Manufacturers of WATER TUBE BOILERS

WRITE TO **MODEL STOKER COMPANY** DAYTON OHIO  
 for detailed information about the best  
**AUTOMATIC SMOKELESS FURNACE**

**GREEN TRAVELING LINK GRATES**

Highest Capacity  
 Highest Efficiency  
 Automatic Smokeless  
 Labor Saving  
 Cheap Fuel

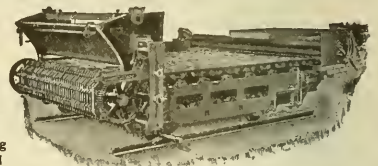

**GREEN ENGINEERING CO.**

Main Office: Commercial National Bank Bldg., Chicago, Ill.  
 BRANCH OFFICES: Pittsburgh : St. Louis : St. Paul : Louisville  
 General Foundry Work a Specialty

# TUBULAR POLES IRON OR STEEL



FOR  
ELECTRIC  
RAILWAYS  
ELECTRIC  
LIGHTING CO'S  
SIGNAL  
TELEPHONE (SER.)  
TELEGRAPH (VICE)  
TRANSMISSION  
LINE  
AND  
CATENARY  
SUSPENSION  
LINE

**ELECTRIC RAILWAY EQUIPMENT CO.**  
General Office: CINCINNATI, O. U.S.A.  
Shops: READING PA - WHEELING WVA

# RAIL BOND Maintenance.

The SEMI-PLASTIC PLUG RAIL BOND is applied on either Girder or T Rail without disturbing the pavement or removing the angle plates.

The condition of the Bond can be determined by a track walker from its appearance.

Its conductivity is 900,000 c. m., which can be maintained at a trifling expense without removing Bond.

Cheaper in first cost than No. 4/0 copper bond and more easily applied.

Write for details.

**HAROLD P. BROWN,**  
120 Liberty Street, New York, N. Y.

# RE-ENFORCED SPOKE WHEELS

For City and Suburban Cars

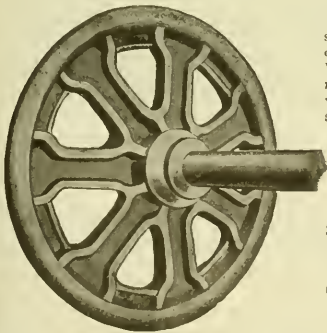

This wheel is being substituted in place of the Old Style Plate Wheel because it does not rumble and roar when on paved city streets.

The only spoke wheel for Heavy High Speed Service.

- Stronger Spokes
- Stronger Flange
- Deep, Even Chill
- Greater Mileage
- Absolute Safety

A Sample Order Will Prove Its Superiority Over the Old Style Spoke Wheel

WRITE FOR BOOKLET ON WHEELS

**ST. LOUIS CAR WHEEL CO.**  
ST. LOUIS, MO.

# THE Van Dorn & Dutton Co.

CLEVELAND, OHIO

MANUFACTURERS OF

# GEARS AND PINIONS

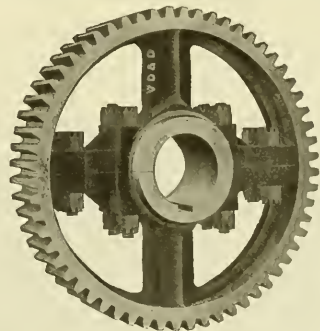

For All Types of Motors

HIGHEST QUALITY

### Baldwin Locomotive Works

BURNHAM, WILLIAMS & CO., PHILADELPHIA, PA., U. S. A.

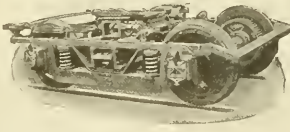

Builders of  
**LOCOMOTIVES**  
of every description  
including  
**ELECTRIC  
LOCOMOTIVES**

### ELECTRIC TRUCKS

### Standard Steel Works Co.

HARRISON BLDG., PHILA., PA., U. S. A.

New York, N. Y. Cleveland, O. St. Louis, Mo. Denver, Colo.  
Portland, Ore. Richmond, Va. Chicago, Ill. St. Paul, Minn.  
San Francisco, Cal. Seattle, Wash. Winnipeg, Can

### Solid Forged Rolled and Steel Tired Wheels

Mounted on axles fitted with Motor Gears  
for Electric Railway Service.

**LOCOMOTIVE TIRES RAILWAY SPRINGS**  
**FORGINGS CASTINGS**



THE RAILWAY SPECIALTY  
AND SUPPLY CO.

SMITH NUTS FOR TRUCKS

Great Northern Building  
CHICAGO

### THE NATIONAL LOCK WASHER CO., NEWARK, N. J.

Curtains - Curtain Fixtures - Sash Locks - Sash Balances - Nut Locks

CHICAGO OFFICE: 419 MONADNOCK BLOCK

### THE AMERICAN FROG & SWITCH CO., HAMILTON, OHIO

SPECIAL TRACK WORK FOR ELECTRIC RAILWAYS

### FOSTER SUPERHEATERS

GREATLY INCREASE EFFICIENCY AND POWER OF STEAM TURBINES

POWER SPECIALTY COMPANY  
111 Broadway, New York

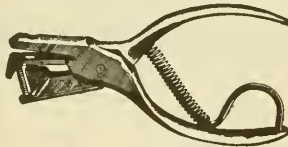

### The Fred. J. Meyers Mfg. Co. Hamilton, O.

Largest Manufacturers in the World of  
**TICKET AND CONDUCTORS'  
PUNCHES**

Send for catalog of 75 different styles of punches with 100 different dies.  
Write for special prices.

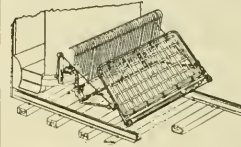

### ECLIPSE Life Guard

Manufactured by the  
**ECLIPSE RAILWAY SUPPLY CO.**  
Cleveland, Ohio



Over  
**25,000**  
miles  
in use

CONTINUOUS JOINT



WEBER JOINT

Rolled  
from  
**Best Quality  
Steel**



WOLHAUPTER JOINT

Catalogs at Agencies  
Baltimore, Md. Portland, Ore.  
Boston, Mass. Seattle, Wash.  
Chicago, Ill. St. Paul, Minn.  
Denver, Colo. St. Louis, Mo.  
Pittsburg, Pa. Troy, N. Y.  
London, Eng. Montreal, Can.

HIGHEST AWARDS—Paris, 1900;  
Buffalo, 1901; St. Louis, 1904

Additional safety and economy in Track Maintenance has been proved by the use of Continuous, Weber and Wolhaupter base-supported rail joints—after ten (10) years' service, having a record of over 25,000 miles in use—the extent of which is evidence of their excellence.

### THE RAIL JOINT COMPANY

General Offices: 29 West 34th Street, New York City  
Makers of Rail Joints for Standard and Special Rail Sections, also  
Gilder, Stop or Compromise, and Insulating Rail Joints, protected by  
patents in United States and Foreign Countries.

### PIPE FITTINGS AND VALVES

FOR THE  
HEATING AND PLUMBING TRADE

TRADE  MARK

**JOHN SIMMONS Co.**  
104-110 Centre Street, NEW YORK

IF YOU wish to keep posted on all steam railway matters you must read THE RAILWAY AGE, for it is the leading railway journal of the world and the only one that covers all phases of the industry.

Sample copies sent on request.

**THE RAILWAY AGE**  
160 HARRISON STREET - - CHICAGO

# FOR SALE. FOR QUICK DELIVERY

## 6 55-ft. Passenger, Baggage and Smoking Car Bodies

Main Compartment	26' 0"
Smoking	10' 6"
Baggage	10' 0"
Seating Capacity, 54	

## 8 60-ft. Passenger, Baggage and Smoking Car Bodies

Main Compartment	28' 6"
Smoking	11' 0"
Baggage	8' 0"
Seating Capacity, 58	

## 5 52-ft. Passenger and Smoking Car Bodies — <sup>Double</sup>End

Seating Capacity, 60

## 3 52-ft. Passenger and Baggage Car Bodies — <sup>Double</sup>End

Seating Capacity, 56

## 2 50-ft. Express Car Bodies

*Write or wire us for further information.*

# The Jewett Car Co. Newark Ohio

### THE MIGHTY MIDGET

## HOT WATER CAR HEATER

Adapted for Large Electric Cars and Long Distance Lines. Exclusively used on Largest Electric Systems. Ask for Catalog

THE WILLIAM C. BAKER HEATING & SUPPLY CO., 143 LIBERTY STREET NEW YORK



## NILES CARS — THE ELECTRIC PULLMANS

LARGE, FAST INTERURBANS  
OUR SPECIALTY

### NILES CAR & MFG. COMPANY

WORKS: NILES, OHIO

Sales Office: J. A. HANNA Co., 312 Electric Bldg., Cleveland, O.

# Steel Passenger Cars and Trucks

For Steam and Electric Railways

Steel and Composite Freight Cars for all Classes of Service

# Pressed Steel Car Co.

NEW YORK, PITTSBURGH, CHICAGO, ST. LOUIS, ATLANTA, MEXICO CITY, BUENOS AIRES, SYDNEY, N. S. W.

*Put into practice the principles  
laid down in this book*

# “The Motorman and His Duties”

*and the result will be better, safer  
and more economical operation.*

¶ Electric railway companies can well afford to place copies of this book in the hands of motormen and shopmen.

¶ Its purpose is to familiarize the reader with the operation of electric railway cars. It explains in simple language, devoid of mathematics and technicalities, many points not generally understood by the average employe who has to do with the operation or care of electric railway rolling stock. Such knowledge cannot fail to make his services more valuable to his company and more satisfactory to himself, and it will also better fit him for promotion.

The revised, enlarged and improved sixth edition is now ready. Two hundred pages; 138 illustrations; three folding sheets of multiple-unit car wiring diagrams; cloth binding.

Price, \$1.50 per copy, prepaid

Send for 16-page descriptive pamphlet

**The Wilson Company** 160 Harrison Street  
Chicago

YOU CAN SAVE REPAIR BILLS BY USE OF

# MANGANESE STEEL GEARS and PINIONS

MADE ONLY BY ATHA STEEL CASTING CO., NEWARK, N. J.

<p>FOUNDRIES          CHICAGO    DETROIT          DENVER    ST. PAUL          TACOMA    BOSTON          KANSAS CITY          GENERAL OFFICES          WESTERN UNION BLDG.          CHICAGO</p>	<p><b>GRIFFIN WHEEL COMPANY</b>          CHILLED IRON  <b>Car Wheels</b>          OF EVERY DESCRIPTION          FOR ALL CLASSES OF SERVICE          IRON OR STEEL AXLES. REFITTING A SPECIALTY</p>
--	--



## Special Work for Street Railways

Switches  
Mates  
Frogs



Cast Weld Compromise Rail

and Crossings  
with Hard  
Steel Centers

Barbour - Stockwell Co., 205 Broadway, Cambridgeport, Mass.

# CLASSIFIED ADVERTISEMENTS

Undisplayed advertisements are inserted under this heading at the uniform rate of one cent a word; minimum charge twenty-five cents. Replies directed to this office will be forwarded when required to any address in the United States, Canada or Mexico without extra charge. Advertisements received at the Chicago office by 9 a. m. Thursday will appear in the issue for the same week.

**POSITIONS WANTED.**

**Wanted**—A young man experienced in street railway and electric light accounting desires position as auditor. Best of references as to character and ability. Address "No. 573," care of Electric Railway Review, Chicago.

**Expert street car electrician**, city or interurban lines, desires a change. Fifteen years' experience; capable handling men also railway park manager. Now with a large railway. Address "No. 578," care of Electric Railway Review, Chicago.

**Wanted**—Middle-aged man with 26 years' experience in railway operation and supplies and equipment wants to represent good firm in the southwest with headquarters at Oklahoma City. (By permission refers to Electric Railway Review.) Address "No. 581," care of Electric Railway Review, Chicago.

**Wanted**—Position as superintendent of rolling stock or master mechanic on city or interurban railway. Have satisfactorily handled similar work on large metropolitan properties since horse car days. At liberty now; references exceptional. Address "No. 580," care of Electric Railway Review, Chicago.

**Experienced electrical engineer** wants position with manufacturing concern or with company operating electric railways. Graduate, Purdue University, 1905. Will go anywhere for permanent position. Age 26; married; A No. 1 references as to habits and ability. Address "No. 570," care of Electric Railway Review, Chicago.

**POSITIONS WANTED.**

**Position wanted** as superintendent and electrician of electric light and power station by man of 30, having 12 years' practical experience in construction and operation; thoroughly familiar with all systems adopted by modern plants for reducing expenses and adding to income; salary, \$125. Address W. N. Alexander, Sidney, Neb.

**An experienced supply salesman**, who also has had thirteen years' operating experience on city lines, desires to form connection with a railway supply house handling either electric or steam supplies or both. Would consider proposition to open sales agency. Address "No. 568," care of Electric Railway Review, Chicago.

**Transportation man** of seven-teen years' experience, young, reliable and thoroughly familiar with organization, dispatching and timetable work, desires a position as superintendent or one of equal responsibility. Highest references regarding character, ability and past service. Address replies to "No. 577," care of Electric Railway Review, Chicago.

**Position wanted as auditor and accountant**. Sixteen years of steam, electric and general experience; good working knowledge of details of general contracting business; clever buyer; possess ability to organize. Can furnish first-class reference as to character and ability and work accomplished in past; leaving present work because closed; at liberty to accept position any time. Address "No. 575," care of Electric Railway Review, Chicago.

**POSITIONS OPEN.**

**Technical men**. Positions open in all departments. Write today if you will consider better position, change of location. Twelve offices. Service confidential. HAPGOODS, 305 Broadway, New York, or 1010 Hartford Bldg., Chicago.

**Best general manager obtainable** to construct and operate a new interurban system. Initial line only the beginning of a system. Give experience and reference. Address "No. 579," care of Electric Railway Review, Chicago.

**BUSINESS OPPORTUNITIES.**

**Wanted**—Man with some capital and a knowledge of railway track supplies to join the advertiser—a salesman handling locomotive and car supplies—in a general railway supply business. Address "No. 553," care of Electric Railway Review, Chicago.

**Recharging Dry Batteries**, the only book ever published giving complete directions of how to prepare chemicals for renewing dry batteries. If you are not more than pleased with this book your dime back. Large electrical catalogue and book postpaid, 10 cents. Adams Electric Co., Dept. E. R., Kewanee, Ill.

**BOOKS AND PUBLICATIONS.**

**Wanted**—Copies of the Street Railway Review of April, 1900, May, 1901, and August, 1903. State price and condition. Address "No. 553," care of Electric Railway Review, Chicago.

**MISCELLANEOUS WANTS.**

**Want to buy second-hand equipment**, machinery or material? A card inserted in the Electric Railway Review, stating just what you want, will bring immediate response. The cost is small—only \$1.20 an inch (measuring 1 inch deep by 1 1/2 inches wide) per insertion. Send orders to Electric Railway Review, 160 Harrison St., Chicago.

**What have you to sell** in the way of second-hand equipment, machinery or material? Buyers read the "For Sale" cards on the following page and there is the place to tell your story. "For Sale" cards are inexpensive—only \$1.20 an inch (measuring 1 inch deep by 1 1/2 inches wide) per insertion. Special rates on contracts for 100 inches or more to be used within one year. Now is the time to send your order to Electric Railway Review, 160 Harrison St., Chicago.

**BOOKS AND PUBLICATIONS.**

**We want your friends** to read the Electric Railway Review. You will do them—and us a favor by sending their addresses. We will gladly mail free sample copies. Electric Railway Review, 160 Harrison Street, Chicago.

**Wanted**—Copies of Street Railway Review, January to June, 1906, inclusive, and one copy each January and February, 1906. Also Electric Railway Review for January 5, 1907. State condition and price. Address "No. 582," care of Electric Railway Review, Chicago.

**P. W. MARSHALL & CO.**  
50 Church St., New York  
Second-Hand Machinery and Equipment  
**ELECTRIC RAILWAY MATERIALS**

**VALVES—FITTINGS—STEAM SPECIALTIES**  
**CRANE CO.**  
CHICAGO  
ESTABLISHED 1855

**Rare Bargains in RAILS AND EQUIPMENT**  
**ZELNICKER** SUPPLY  
WALTER A. ZELNICKER  
In ST. LOUIS  
DO YOU RECEIVE OUR STOCK LISTS?

**NO SNOW TO DELAY CARS**  
The Russell Snow-Plow is used by more than 50 roads to maintain schedules and prevent blockades. Russell Car & Snow-Plow Co., Ridgway, Pa. Wendell & MacDuffie, Cortlandt St., New York; C. A. Ralston, Fisher Bldg., Chicago; Robinson & Cary Co., Saint Paul.  
**IF YOU HAVE A RUSSELL**

**FOR SALE: Three Car Bodies and Three Pairs of Double Trucks**  
with or without electric equipment and air brakes; all new and never used. Compelled to sell, as these cars will not operate over a leased line by reason of their width and length.  
**R. W. MARSHALL & CO., 50 Church St., New York, N. Y.**

**ANY** on Railway and Allied Subjects  
**BOOK** now in print sent prepaid upon receipt of price by  
**THE WILSON CO., 160 HARRISON STREET CHICAGO**



# The Lindsley Brothers Company

Producers and Shippers of

and Manufacturers of

## WESTERN CEDAR POLES

## RED FIR CROSS ARMS

Eastern Sales Office, Monadnock Bldg., CHICAGO

SPOKANE, WASHINGTON

For prompt deliveries of

### Cedar Poles Red or White

write either office today.

**NATIONAL POLE COMPANY**  
EVERETT, WASH.                      ESCANABA, MICH.

### Poles and Ties

A Selected Stock in Chicago for Rush Shipment  
A Number of Large Yards in the North

**NAUGLE POLE & TIE CO.**  
CHICAGO OFFICE: 226 LA SALLE STREET

We are Producers and Wholesale Dealers in Western

### CEDAR POLES

Yards in Washington, Idaho, Montana  
and British Columbia  
WRITE US FOR DELIVERED PRICES

**CHURCHILL CEDAR CO.,** Box 1409, Spokane, Wash.

### Idaho Cedar Poles

PACIFIC COAST POLE CO.

SPOKANE, WASH.

### HUMBERD LUMBER CO., LTD.

### Cedar Poles and Piling

SANDPOINT, IDAHO.

### POLES and PILING

20,000 35s and 40s  
Ready to Ship at Once

**S-E. Missouri Cypress Co.,** Campbell, Mo.

### Armstrong Journal Oiler

SAVES OIL                      SAVES MONEY  
PREVENTS HOT BOXES



**A Perfect Journal Lubricator**

Will last several seasons without renewal, like waste; and can not shake away from the journal. Catalogue and trial sample for the asking.

**Armstrong Oiler Co.**  
31st and Chestnut Streets                      PHILADELPHIA

**OHIO BRASS COMPANY**  
MANSFIELD, OHIO                      Agents West of Pennsylvania

### C. H. WORCESTER CO.

### CEDAR POLES

PRODUCERS AND WHOLESALERS

Suite 1716 Tribune Building

CHICAGO

### G. H. BARNES HARDWOOD LUMBER CO.

Office and Yard: Main and Water Sts., ST. LOUIS, MO.

Ties, Car Oak, Poplar, Ash, Cherry, Plain and Quartered Oak

### Shelby Trolley Poles

Made from Cold Drawn Seamless Steel Tubing.  
Immediate delivery all sizes from stock.

**The Garford Company : Elyria, O.**



DESIGNS  
for  
ADVERTISING

BIRDS  
EYE  
VIEWS

### HALF TONES

Photographing Machinery  
& Retouching ART PRINTING

**WOODBURY CARLTON & CO.**  
WORCESTER, MASS.

# ROLLING DOORS

In Steel, Wood or Bronze

FOR CAR BARNs, FREIGHT SHEDS, ETC.

Made by the

## JAS. G. WILSON MFG. CO.

New York Office: 3 W. 29th Street

ESTABLISHED 1876

Incorporated 1903

# Pantasote

The National Standard for Car Curtains and Car Upholstery.

## AGOSOTE HEADLINING

The only headlining made in one solid piece. Will not separate, warp or blister. Waterproof and homogeneous.

## THE PANTASOTE COMPANY

707 Fisher Building, Chicago, Ill.

11 Broadway, New York

# U. S. Metal & Mfg. Co.

City Investing Building, 165 Broadway, New York

Pittsburg, 1509 Arrott Bldg. Chicago, 414 Railway Exchange

## Victor Cast Steel Car Replacer

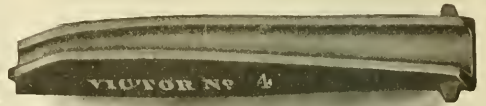

Victor No. 4

Weight, 136 pounds per set. For use on electric or standard steam roads using rails five inches high or under. Replacers are made of cast steel and annealed.

2

# STANDARD HIGH-SPEED "INTERBOROUGH" DOUBLE TRUCK

TYPE C-60

## "Solid Forged"

WITHOUT WELDS

FRAMES ARE MADE FROM ROLLED OPEN-HEARTH STEEL WITHOUT WELDS. ALL WEARING BOLTS ARE TURNED AND CASE HARDENED, AND WEARING HOLES STEEL THIMBLED. M. C. B. STANDARD PRINCIPLES ARE FOLLOWED. WE ARE PREPARED TO BUILD TRUCKS IN ACCORDANCE WITH PURCHASER'S DESIGNS AND SPECIFICATIONS.

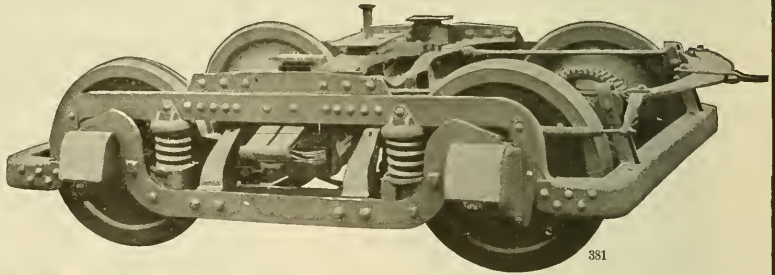

381

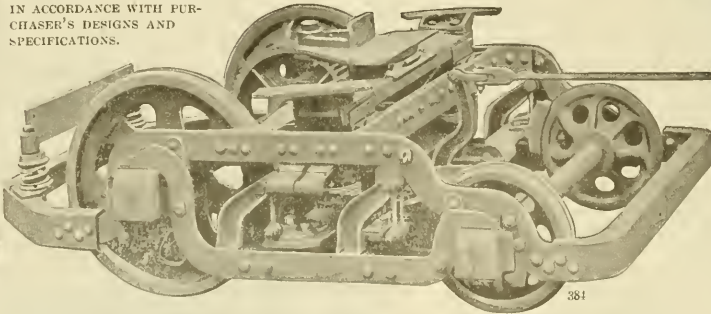

384

## STANDARD "MAXIMUM TRACTION" DOUBLE TRUCK

CITY AND SUBURBAN  
TYPE O-45

OVER TWO HUNDRED OF THESE "MAXIMUM TRACTION" TRUCKS ARE IN SERVICE IN BROOKLYN, NEW YORK, AND ARE PRONOUNCED "HIGHLY SATISFACTORY."

STANDARD MOTOR TRUCK COMPANY, FRICK BUILDING, PITTSBURGH, PENNSYLVANIA  
NEW YORK OFFICE: 170 BROADWAY WORKS: NEW CASTLE, PA. CHICAGO OFFICE: FISHER BUILDING

# Electric Railway Review

PUBLISHED EVERY SATURDAY BY THE WILSON COMPANY, CHICAGO

Entered as second-class matter January 5, 1907, at the postoffice at Chicago, Ill., under the act of March 3, 1879.

160 Harrison Street, Chicago  
150 Nassau Street, New York  
1529 Williamson Bldg., Cleveland

Vol. XIX  
No. 17

CHICAGO, APRIL 25, 1908

Whole No.  
261

Subscription: Domestic . . . \$2  
Foreign . . . \$5  
Canada . . . \$3.50

After a careful investigation of 6-cent fares charged by the Blue Hill Street Railway, the Massachusetts railroad commission has found that the fare is reasonable for the distance included, considering the present financial condition of the company.

## Six-Cent

**Fare Upheld in Massachusetts.**

The road runs from Mattapan, where it connects with the Boston Elevated Railway to Stoughton, Norwood and Hyde Park. The specific question involved was whether a 6-cent fare between Stoughton square and Canton crossing, a distance of 4.22 miles, was unreasonable, but the commission investigated the conditions on the road as a whole. In regard to the issuance of workmen's tickets at a reduced rate the commission states that it at present sees no reason for a reduction, but if subsequent returns indicate that the company may with justice be called upon to issue some form of ticket for less than the present rates, an appropriate order will be given. This decision is probably the first of a number in connection with the allowance of "living returns" for street railways in Massachusetts operating outside the populous centers.

Down in New York the public service commission has been endeavoring to adjust differences existing between the New York Edison Company and its customers

## Breakdown Service Charges.

and possible customers, who are anxious to have breakdown electric service connections. Heretofore the power supply company has had its rates for breakdown service connections so high that operators of isolated plants have considered the costs for such service prohibitive unless their distribution circuits must give positive assurance against interruption from lack of current. The commission, however, has taken a hand and as a result the supply company has modified its rates for this service so that the charge shall be based upon the maximum demand of the consumer and not, as heretofore, on the capacity of his installation. This agreement operates for one year, during which time the company will place recording meters on all its breakdown connections and take records under the supervision of the commission for the purpose of determining how frequently such service is required. Therefore at the end of the year it should be possible for the customer, commission and generating company to determine a fair charge for the service.

There are many lessons yet to be learned in ticket handling and accounting methods. Well-written articles on this subject

## Tickets and Their Accounting.

are always read with interest and therefore we are pleased to present in this issue a very complete discussion of the subject as written by P. P. Crafts, general manager of the Iowa & Illinois Railway, for presentation before the Iowa Street & Interurban Railway Association at Des Moines. The author tersely expresses the problem at hand when he says: "Too many of us look upon the money obtained from traffic as so much cash received and do not give sufficient thought to analyzing and preventing the small leaks which, taken individually, may be very small, but taken collectively amount to a good round sum each year. Such

money is earned, yet neither collected nor accounted for." Mr. Crafts discusses the methods found most satisfactory for handling fares on roads having two distinct classes of traffic. One of the roads handles through traffic largely; the other gains its earnings almost wholly from short haul. A study of the requirements of the two systems showed that fare handling methods for one were entirely unsuited for the other, and from Mr. Crafts' discussion and comments on the situation much can be learned.

We have had considerable to say in the past regarding the looping of tracks through yards, shops and car houses. Trans-

## More Loop Tracks.

fer tables, we believe, are a nuisance except in those special instances where real estate conditions will not permit a generous layout of special track work. Last week we presented an article by Thomas Pumfrey, engineer of the International Traction Company, describing the new Broadway car house in Buffalo. The ground plan of the structures and storage yards shows that there is a complete double-track loop around the buildings and that a car entering on any track at one end may run through the buildings or yards and pass out at the other end. This is an ideal arrangement and presents many valuable features. In a car house where at certain times during the day cars must be received on short headway for inspection and cleaning, the through tracks permit of the maintenance work being carried out progressively and, as is done on the Chicago City Railway, the cars being moved ahead from one class of work to another until when they reach the farther end of the car houses they are ready for service. Through tracks also double the number of cars that can quickly be run out of the buildings in time of fire. These desirable factors, when combined with the uncontroverted advantage on the score of flexibility, argue strongly for as complete consideration of the track layout at a railroad structure as usually is given the design of the building.

Many of the larger electric railways serving interurban and suburban districts have found the portable substation to be an

## Feeding Portable Substations.

important part of the power distribution system. With one exception we do not know of any road, however, which has fed these substations through any medium except the regular alternating-current high-tension feeders. It is a common practice to install such substations on stub-end sidings near the distribution center to be served and there to erect a pole so that temporary connections may be made with the high-tension wires already serving the permanent substations. This, of course, is the only method that can be pursued by an interurban railway, but where large city systems which operate suburban divisions find it advisable to use portable substations, another method of feeding current is possible. This method, which comprises the exception earlier referred to, is that of using the direct-current feeders as conductors to carry alternating current to the portable equipment. In last week's issue of the Electric Railway Review E. D. Smith, superintendent, described the portable substations of the United Railways Company of St. Louis in

an article which considers the entire power generating and distributing systems of that company. As implied, the use of direct-current feeders for carrying alternating current to a portable substation is, of course, made possible only by special conditions. The trolley taps must be taken off from a part of the direct-current feeders and these feeder cables must also be mounted on high-tension insulators. A special change-over switching and busbar arrangement is also required in the generating station. The principal advantage gained, other than those usually obtained from the use of portable substations, is that excessive localized loads may be handled on suburban divisions which are not paralleled with transmission lines.

Special interest attaches to the paint tests which are now being carried out by the Paint Manufacturers' Association of the United States. These tests comprise exhibiting to weather conditions a large number of sample boards located at Atlantic City and Pittsburg. Either of these locations will give the various paint samples a severe service test. Atlantic City weather conditions include those of salt air and fogs, while the paints on the sample boards at Pittsburg will be subjected to air usually contaminated with smoke. Suffice it to say, the sample boards at Atlantic City will get the more sunshine. Especial care has been taken in preparing the boards so that like conditions of application will exist in both cities and the personal equation will be balanced by having the same corps of men do the work on both sets of samples. It is not expected that the results of these tests will settle conclusively the relative merits of competing pigments and kinds of paints, but it is expected that they will furnish much valuable information. Later a series of tests may be extended to other parts of the country and then cumulative evidence will be had which must be both valuable and suggestive.

#### SEGREGATION OF THE THIRD AVENUE RAILROAD.

Disintegration of the surface system of railways in New York City began with the appointment of an individual receiver for the Third Avenue Railroad and the subsequent order of the United States circuit court permitting the abolition of transfers at the points of connection between most of the lines of that company and the lines of the New York City Railway. Under the authority conferred by that order the transfers between these lines were discontinued at midnight, April 11. The course which these events indicate is evidently at wide variance with the programme which the public service corporation regulating body of New York City had anticipated. William M. Ivins, special counsel for the commission, said in an address before the City Club of New York on "The Metropolitan Street Railway System" on March 9: "I do not discuss the problems of disintegration and abandonment which are proposed to reduce transfers and save losses on the poorer routes—first, because the community will not have it so, and second, because in view of the facts and the law I don't see how it is to be done."

That the first steps have been taken notwithstanding the attitude of the community or the interpretation placed upon the facts and the law, is due to the anomalous situation respecting transfers, which required treatment just as much as the excessive overcapitalization, the insufficient maintenance charges and the failure to provide for depreciation of the property, to which Mr. Ivins called attention.

That the community had received more from the surface lines in the way of transfers than was its just due is plain from the statement of the man who showed that under the old system it was possible to ride all day for a 5-cent fare. Other facts that should be calculated are: The rapid increase in transfer passengers on the surface lines until they reached

55.13 per cent of the revenue traffic during a period of six months, when the revenue traffic was declining; the correspondingly rapid decrease in the rate of fare until it averaged 3.16 cents per passenger carried; and the development of the system of connecting lines until a ride could be secured from the Battery to Kingsbridge, a distance of 37½ miles, for a 5-cent fare. In his decision, which enabled the receivers of the respective companies to withdraw most of the transfers, Judge Lacombe stated: "It is obvious that a curtailment of transfer privileges \* \* \* will increase the cash receipts of the properties affected, and since receivers are trustees for the creditors and owners their duty to operate the roads so as to increase earnings is equally obvious." With exceptions affecting several transfer points Judge Lacombe found no legal reason why transfers should not be discontinued.

If the companies had been solvent, going corporations they presumably would have had to secure the approval of the public service commission for any scheme for limiting the transfer privileges, but as bankrupt properties in the hands of the court, a truthful recital of the need of expenditures for neglected maintenance and of the state of earnings and obligations secured the desired end. The receivers of the New York City Railway stated to the court: "The condition of the entire operating property, except the power houses, when we took charge was deplorable. For a long time the operating company had confined its repairs to such temporary and makeshift work as would merely patch up worn-out parts, without any comprehensive and thorough reconstruction."

If the earnings are now conserved by curtailment of the transfer privileges and other sums which may be applied to reconstruction of the plants are obtained by default on interest and dividend obligations the properties will be rehabilitated in time and established, after financial readjustment, on a paying basis. The Third Avenue Railroad, as an independent company, will be more valuable to its owners and creditors than as an integral part of a great system. The expenditure of money upon improvements to track and new equipment will invite the return to all of the surface lines of some of the traffic which has been lost to competing subway and elevated lines. When it is possible to measure the extent of the increases in earnings from better service and changes in the transfer system, already made or planned, one of two steps will result—further segregation of individual properties or action looking toward final reorganization and restoration to security-holders.

Without considering the effect of partial disintegration and the consequent development of separate systems, Mr. Ivins, in the address referred to in the foregoing, estimated the replacement value of the surface system at \$106,500,000, divided between \$44,066,479 for 542 miles of track and \$15,000,000 for rolling stock. He recast the statement of earnings for 1907 to show what the earnings would be on this estimated replacement cost if proper provision were made for maintenance and depreciation. With gross earnings and income from all sources of \$21,919,692, of which \$21,355,013 was derived from operation, Mr. Ivins allowed \$13,172,571 for operating expenses, or 60.1 per cent. This he divided as follows: Transportation, \$9,453,657; maintenance and repairs, \$2,948,504; general and other expenses, \$770,410. From the balance Mr. Ivins would deduct, say, 2½ per cent of gross income, for "adequate annual current maintenance" and \$550,784 for an increase of, say, 10 per cent in wages. This deduction would leave a balance of \$7,649,345. Allowing \$3,000,000 for a depreciation reserve would leave a final balance for taxes, interest and dividends of \$4,649,345. Computing taxes, exclusive of the special franchise tax, at \$1,043,602 would leave for interest and dividends \$3,605,743.

Mr. Ivins, however, is of the opinion that if the plant were placed in first-rate condition \$1,500,000 would be ample for depreciation. With a saving in the cost of injuries and damages as a result of rehabilitated equipment, and possible increased earnings, Mr. Ivins figured an annual net divisible income of

\$6,923,243, without any allowance for special franchise taxes.

These figures are of importance because of the broad powers conferred upon the commission with respect to capital issues. It is evident, however, that the figures of earnings, with normal conditions in business and traffic, would be enlarged considerably, both in gross and net, by even partial abolition of a too liberal transfer system.

ANNUAL REPORTS.

New Orleans Railway & Light Company.

While the operating expenses of all the properties operated by the New Orleans Railway & Light Company amounted to 54.1 per cent of gross revenue in 1907, the proportion of total revenue required for the expense of operation of the railway was 60.5 per cent. The report does not give any statistics which permit of analysis of the extent of the use of operating expenses for maintenance. The form of the report, however, is an improvement over that of the previous year, as it contains a balance sheet, a statement of securities owned and additional information concerning equipment. Earnings for three years compare as follows:

Revenue—	1907.	1906.	1905.
Railroad earnings .....	\$3,987,733	\$3,724,272	\$3,291,967
Electric and gas earnings.....	1,893,686	1,875,400	1,705,801
Miscellaneous earnings .....	159,882	173,518	95,942
<b>Total earnings .....</b>	<b>\$6,041,301</b>	<b>\$5,773,190</b>	<b>\$5,093,710</b>
<b>Expenses—</b>			
Railroad operating .....	\$2,411,759	\$2,225,580	\$1,901,085
Electric and gas, operating..	858,638	848,435	770,376
<b>Total operating expenses.</b>	<b>\$3,270,397</b>	<b>\$3,074,015</b>	<b>\$2,671,460</b>
Net earnings from operation. 2,770,904	2,699,175	2,422,249	
Interest on funded debt, taxes and miscellaneous. 2,025,637	1,900,901	1,784,226	
<b>Net income .....</b>	<b>\$ 745,267</b>	<b>\$ 798,274</b>	<b>\$ 638,023</b>
Dividends on preferred stock. 312,500	500,000	125,000	
<b>Surplus .....</b>	<b>\$ 432,767</b>	<b>\$ 298,274</b>	<b>\$ 513,023</b>
Operating expenses—percentage of gross revenue.....	54.1	53.2	52.2

The increase in gross earnings amounted to 4.6 per cent, and in operating expenses to 6.4 per cent. E. C. Foster, the president, states that most of the additional operating expense is due to the increased volume of business in the railway and gas departments and to an increase of 0.5 per cent per hour in wages of employes from July 1.

Expenditures for construction, improvements, betterments and the acquisition of new property during the year amounted to \$1,009,833, of which \$598,498 was paid on account of power houses, which are now completed. The other expenditures, aggregating \$411,335, were divided between the different subsidiary properties.

On account of the installation of sewerage and water mains by the city of New Orleans, about 25 miles of track, have been undermined and thrown out of position by the building of parallel trenches close to the tracks, very much to their detriment. Mr. Foster states that it is the intention to expend, due partly to the installation of these sewerage and water pipes, about \$500,000 for resurfacing and rehabilitation of track, as soon as it can consistently be done with due consideration for the company's interest.

The balance sheet as of December 31, 1907, shows "plant, property, franchise and securities" as \$84,701,679. Gross revenue amounted to 7.1 per cent on this sum. The balance sheet also shows \$85,686 stock and bond investment and \$2,478,000 securities owned. Of the latter amount \$2,390,000 of 4½ per cent general mortgage bonds and \$5,000 of 6 per cent debenture notes are pledged as collateral for bills payable, which amounted to \$1,777,588. Reserves for litigation, bad debts, etc., amounted to \$73,243. The securities issued are as follows: Preferred stock, \$10,000,000; common, \$20,000,000;

preferred stock affiliated companies, \$7,100,000, of which \$7,051,300 is owned by the parent company; common stock affiliated companies, \$14,297,800, of which \$14,025,000 is owned by the parent company; general mortgage bonds, \$17,397,000; 6 per cent debenture notes, \$1,300,000; funded debt of underlying companies, \$12,902,000.

Traffic statistics compare as follows:

	1907.	1906.	1905.
Revenue passengers carried. 78,879,204	73,606,068	65,021,214	
Transfers redeemed .....	7,590,597	7,220,152	6,641,193
Revenue mileage .....	18,432,963	17,718,107	16,753,874
18-hour cars .....	113,648	108,637	102,156

The number of miles of single track is 194.68 and the total number of cars 578.

BOOK TABLE.

**Development and Electrical Distribution of Water Power.** By Lamar Lyndon. Published by John Wiley & Sons, New York, 1908. Book, 317 pp., 6 by 9 in., 158 figures. Price, \$3.00, net.

While there are many well-written books on hydro-electric work and on high-tension electrical distribution methods, we do not know that the essential facts of interest to one engaged in the engineering work, which includes both fields, have before been jointly purchased. The present book is authoritative. It considers thoroughly without deep mathematical calculations the essential facts with which the engineer must be conversant if he has in charge the construction of a hydraulic plant whose product is electricity, which in turn is to be transmitted over a considerable distance. The first section of the book is devoted to hydraulics. Then follow discussions of electrical generators, transformers and transmission details. The third part of the book includes more than 150 well-illustrated pages exhibiting illustrated descriptions of recently built hydro-electric stations.

**Telephone Construction, Installation, Wiring, Operation and Maintenance.** By W. H. Radcliffe, E. E., and H. C. Cushing, Jr., E. E. Published by the Norman W. Henley Company, New York, 1908. Book, 4 by 6¾ in., 171 pp., 125 illustrations. Price, \$1.00, net.

The authors in their preface to this book announce that it is intended for the amateur, the wireman or the engineer who desires to install a telephone for his own use, or for the contractor who desires to do this work for others. The reader need have no previous knowledge of the subject because all the steps are progressively described and no intricate mathematics are used in any computations. The book first describes the parts of a complete telephone equipment and then shows methods for installing the equipment so that it may best perform any particular service. Inspection and maintenance of instruments and lines, together with testing methods, are considered quite thoroughly for a book of this size.

Through Service Between Indianapolis and Louisville.

Through service between Indianapolis, Ind., and Louisville, Ky., will be started on May 1. The cars will operate over the lines of the Indianapolis Columbus & Southern Traction Company, the Indianapolis & Louisville Traction Company and the Louisville & Northern Railway & Lighting Company. Two trains will be run daily in each direction, leaving Louisville at 8:30 a. m. and 1:30 p. m., and reaching Indianapolis at 12:27 and 5:27 p. m., respectively, and leaving Indianapolis at 9 a. m. and 2 p. m., reaching Louisville at 1:04 and 6:04 p. m., respectively. Stops will be made at Jeffersonville, Watson Junction, Sellersburg, Scottsburg, Crothersville, Seymour, Columbus, Edinburg, Franklin and Greenwood, Ind. The distance between Indianapolis and Louisville is 117 miles and the fare will be \$2.00 for a single trip or \$3.65 for the round trip.

**NORTHWESTERN ELEVATED RAILROAD—NEW TRAILER CARS, WITH STEEL UNDERFRAMES AND SLIDING SIDE DOORS.**

To meet the rapidly increasing demands of its traffic the Northwestern Elevated Railroad, Chicago, has recently had built by the American Car & Foundry Company 40 trailer cars. The design of the new cars is such that they can readily be converted into motor cars. The structural steel underframes have been designed with that end in view. Accompanying illustrations reproduced from working drawings and photo-

nels, wood filled, extending the full length of the car and being continuous through the body bolsters with riveted connections to the end sill channels and plates. The cross members are 3-inch 4-pound channels secured by riveted connections. These cross channels are spaced about 48 inches apart. The end sills are formed of a bent 8-inch 11.25-pound channel iron with its edges turned in and mitered with the ends of the side sill channels. The sills are filled with yellow pine, except the end sills, which are filled with white oak.

The body bolsters are made of two 9 by 3/4 inch soft steel plates. The top plate is secured to the intermediate sills by



Northwestern Elevated Cars—Side View, Showing Large Air Operated Doors.

graphs serve to show the general appearance and some of the detail features of the new equipments.

The general dimensions of the new cars follow:

Distance between center of trucks.....	33 ft. 5 in.
Distance between centers of axles of trucks.....	6 ft.
Diameter of truck wheels.....	31 in.
Length of car body on center line over end plates.....	47 ft. 1 3/4 in.
Extreme width over eaves.....	8 ft. 8 1/2 in.

means of lugs and braces to avoid weakening the top flange of the longitudinal sills on which it rests. The ends of the top plate are turned down over side sills and riveted thereto. The bottom plate passes under the intermediate sills, which here perform the office of separators or posts and the ends of the plate are turned down on the inside face of the side sills, where they are secured to it by the same rivets that fasten the

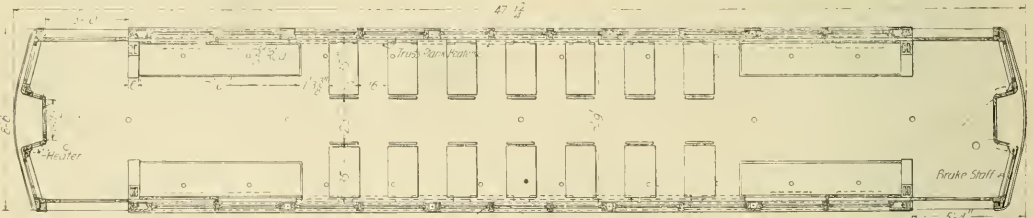

Northwestern Elevated Cars—Floor Plan, Showing Location of Walkover Seats.

Extreme width out to out sheathing at side sills.....	8 ft. 6 in.
Extreme width of dome over eaves.....	5 ft. 6 1/2 in.
Radius of dome, outside.....	12 ft.
Width of portal opening.....	6 ft. 2 in.
Height of car floor over top of rail (light).....	3 ft. 10 3/4 in.
Height of center of drawbar over top of rail (light).....	2 ft. 6 in.
Height of portal opening over inside floor.....	6 ft. 8 in.
Height of window sills over inside floor.....	2 ft. 7 in.
Width of sliding door opening.....	3 ft. 10 in.
Height of sliding door opening.....	6 ft. 5 3/8 in.
Width of end door opening.....	1 ft. 11 1/2 in.
Height of end door opening.....	6 ft. 5 in.

**Framing.**

The underframing includes two longitudinal side sills and four intermediate longitudinal sills of 8-inch 11.25-pound chan-

nel. A cast-steel filler or separator is used at the center between the two central longitudinal sills. There are two needle beams of construction similar to that of the body bolsters.

Two thicknesses of 1 by 4 inch tongued and grooved long-leaf yellow pine are used for flooring. The bottom floor is laid at an angle of 45 degrees to the longitudinal axis of the car. The second yellow pine finish is laid in two ways, longitudinally with car under the seats and at right angles in the aisles. Between the under floor and finish floor there is a layer of hair felt uniformly 1/4 inch thick squeezed down to 1/8 inch.

The end and portal posts are reinforced with angles bolted

to the underframing. On each side of the car between the corner posts there are four compound or panel posts and six single posts, the latter forming the mullions of the triple and double windows. The panel posts are made of two pieces of yellow pine finished  $1\frac{3}{4}$  by  $3\frac{5}{8}$  inches and tenoned to the lower sills. The bracing is of the usual form with  $\frac{5}{8}$ -inch tie rods. The outer sheathing is 2 by  $\frac{1}{2}$  inch white wood, tongued,

that two persons may pass in or out at one time. They recede into pockets provided in the ends of the cars on either side. Illustrations are presented showing the door operating mechanism which is used to operate these large doors. J. E. Osmer,

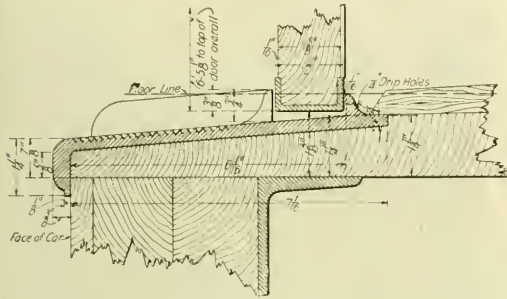

Northwestern Elevated Cars—Detail of Door Tread and Guide.

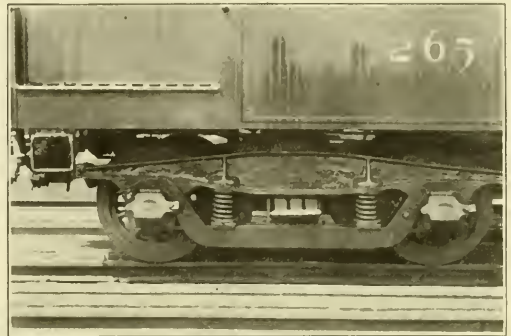

Northwestern Elevated Cars—M. C. B. Truck with Cast-Steel Wheel Piece.

grooved and chamfered. The main carlines are built of  $1\frac{1}{4}$  by  $\frac{3}{4}$  inch wrought-iron bar, forged to the shape of the roof. White ash is used for the intermediate carlines. Cotton duck and copper flashings cover the roof boards.

Detail Arrangements.

Each car has six doors, one at each end, to permit passage from car to car in a train, and two on each side. The end

master mechanic, is the inventor of this mechanism. Briefly, the device comprises two opposing cylinders with piston heads on either end of a single piston rod. This rod moves back and forth along its line of travel according to the air pressure in the cylinders, which pressure is governed by a slide valve controlled from a handle at the end of the car. On the piston rod are teeth engaging a pinion carrying a long arm. As the piston is moved by air being thrown into one of the cylinders it turns the pinion, which, with its extension arm, in turn moves a connecting rod fastened to the sliding door. The door operating mechanism is fitted with dashpots so that the last four inches of its travel in either direction are covered at a slow speed. Accompanying engravings illustrate the general appearance of the pneumatic door operating device as it is installed behind the seat cushions in the car. An important feature of this device is that it executes two movements of the door, that is, an opening and later a closing movement, with but one charge of air.

As shown in the illustration there are 11 windows along

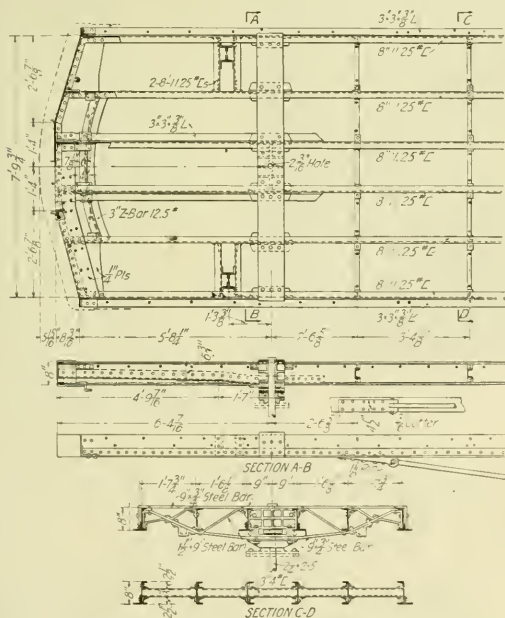

Northwestern Elevated Cars—Detail of Steel Underframing.

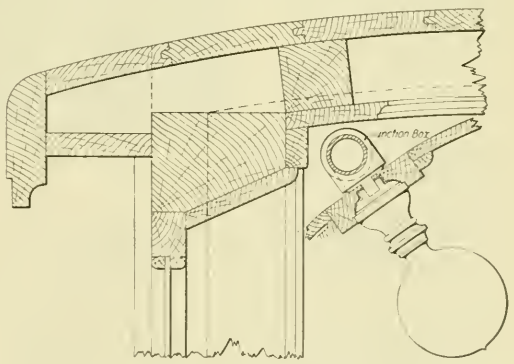

Northwestern Elevated Cars—Section Through Deck, Showing Lamp Fastenings.

doors are so placed back of the end framing that ample space is afforded for a trainman to stand between cars and operate simultaneously the controlling handles of the air operated side doors. The end doors have sliding top sashes.

The side doors are especially wide (3 feet 10 inches) so

each side of the car. The upper sashes raise into pockets and the bottom sashes lower and are covered. The deck sashes are glazed with wire glass and alternately are hinged to swing open. An operating arm and rod on the inside of the car is so connected that one set of deck sashes can be

opened and the other closed by one movement of the operating handle. The inside finish, where exposed to view, except the head linings, is selected mahogany. Below the windows the sheathing is mahogany, 1/2 inch thick, fastened with brass screws. The head linings are of 3-ply maple. The ceiling in the vestibule is covered with 2 by 2 1/2 inch white maple.

The seating arrangement is novel for elevated service. At the ends of the cars are longitudinal seats supported on

with the electrical train lines which are carried in loricated conduit, is brought out at the ends of the cars and by means of swivel joints is arranged to swing with the coupling heads, so that very short coupling hose and jumpers are required.

Each car is wired with five circuits of five lights each, four of these circuits being 16-candlepower 110-volt lamps with round frosted bulbs located in the molding over the

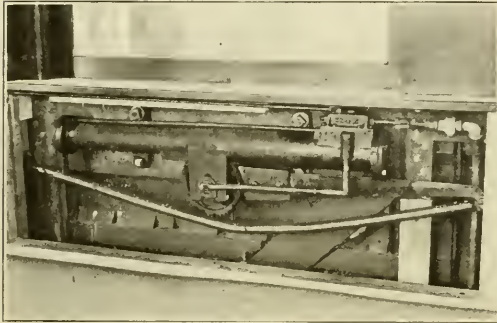

Northwestern Elevated Cars—Door Operating Device with Door Open.

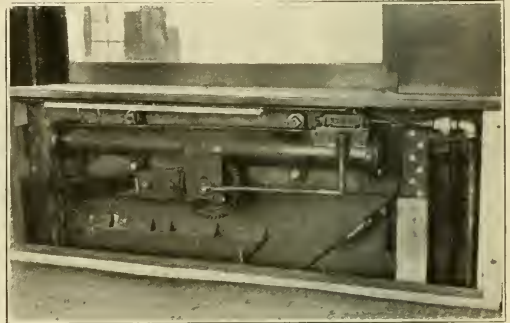

Northwestern Elevated Cars—Door Operating Device with Door Closed.

malleable iron brackets and in the center of the car body on each side are seven Hale & Kilburn walkover cross seats without arm rests. The steel frame of each cross seat is supported on a single pedestal. All seats are covered with rattan. Hunter destination signs in neat compartments are fitted to each car.

The new cars have drawbars and draft rigging conform-

ing to the standards of the Northwestern Elevated Company. The coupling heads are of the S. & W. type. An accompanying illustration shows the type of truck which has been developed in the company's shops and is being used for mounting the 40 new bodies. These trucks were built by the American Car & Foundry Company. The cars are equipped with Westinghouse automatic quick-action air brakes, schedule A M R, with type R-1 triple valves, 10 by 12 inch cylinders, 10 by 24 inch auxiliary reservoirs and American Brake Company's automatic slack adjusters. The air piping, together

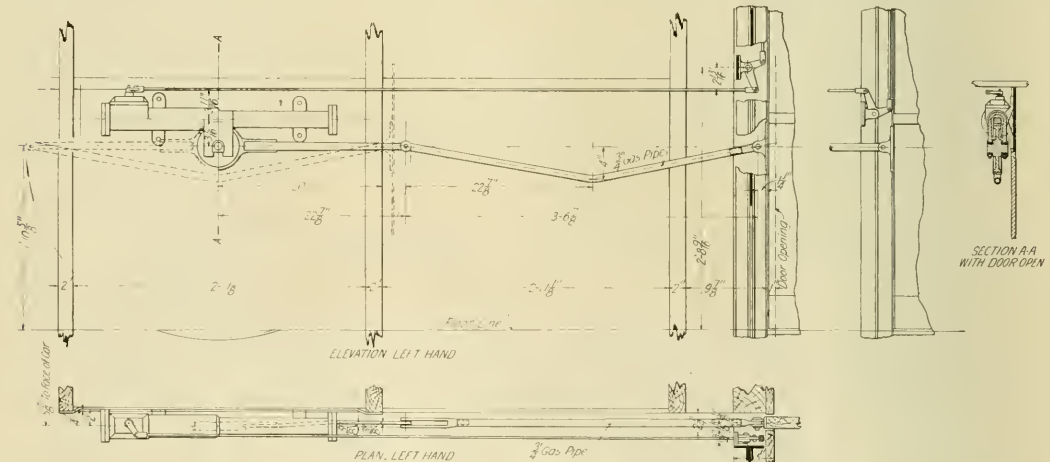

Northwestern Elevated Cars—Dimensions of Air Operated Door Mechanism.

ing to the standards of the Northwestern Elevated Company. The coupling heads are of the S. & W. type. An accompanying illustration shows the type of truck which has been developed in the company's shops and is being used for mounting the 40 new bodies. These trucks were built by the American Car & Foundry Company. The cars are equipped with Westinghouse automatic quick-action air brakes, schedule A M R, with type R-1 triple valves, 10 by 12 inch cylinders, 10 by 24 inch auxiliary reservoirs and American Brake Company's automatic slack adjusters. The air piping, together

Consolidated Car-Heating Company's heaters, 12 located on each side along the base board and two in each vestibule located on each side of the end door. All the heaters have double coils for three regulations of heat. The main switches for the lighting and heating circuits are inclosed in a neat fireproof panel box recessed in the side of the portal at the end of the car.

These new cars will be put into service on the new Evanston extension of the Northwestern Elevated, which is fast nearing completion.



### ANNUAL MEETING IOWA STREET AND INTERURBAN RAILWAY ASSOCIATION.

The fifth annual convention of the Iowa Street and Interurban Railway Association was held on Thursday and Friday of this week, April 23 and 24, at Des Moines, Ia. F. J. Hanlon, Mason City, president of the association, presided.

At the opening session the association was welcomed by the mayor of Des Moines, A. J. Mathes. C. E. Walters, Toledo, Ia., responded, complimenting the city of Des Moines on its being served by so excellent a system of street and interurban railways and paying a kindly tribute to the late J. S. Polk, through whose insight, ability and energy the railway systems at Des Moines were brought to their present state of excellence.

L. D. Mathes, general manager Union Electric Company, Dubuque, presented his annual reports as secretary and treasurer of the association.

A paper entitled "Reinforced Concrete in Electric Railway Construction" was read by N. M. Stark, consulting engineer, Des Moines. This paper will be found elsewhere in this issue.

In the discussion which followed the reading of the paper, Mr. Stark stated that the difference in cost between that for a steel bridge with concrete substructures and that for a structure of reinforced concrete alone was about 12 per cent. He highly favored the horse-shoe-shaped arch for small waterways through track embankments. These arches, as described in the paper, are built without wing walls. This feature of construction frequently makes it possible to erect such a culvert at a cost 15 per cent below that for the ordinary type of concrete culvert having wing walls.

W. A. Williamson demonstrated the merits and methods of using the Rooke automatic fare collector, which, as recently announced in the Electric Railway Review, is now being used on the lines of the Des Moines City Railway.

Resolutions were passed by the association favoring the choice of Denver by the American Street and Interurban Railway Association as the convention city for its next annual meeting.

#### Thursday Afternoon Session.

Daniel Royse, assistant editor-in-chief The Railway Age, Chicago, presented in abstract a paper entitled "Depreciation in Electric Railway Accounting," which will be found elsewhere in this issue.

The paper was discussed at considerable length, the sentiments expressed being in harmony with the conclusions of the author. Especial emphasis was laid on the desirability of providing for depreciation in order to protect the manager from the importunities of his stockholders, who too often think that any money remaining after the payment of operating

expenses and fixed charges should be distributed in dividends.

Messrs. Crafts, Polk and Mathes were appointed as a committee to draft a resolution expressing the sense of the association in regard to accounting for depreciation.

Arthur W. Gross, claim agent Omaha & Council Bluffs Street Railway Company, presented a paper on claims, which is published elsewhere in this issue.

In the discussion which followed the reading of his paper Mr. Gross told of the highly satisfactory results which are obtained at Omaha by the use of mirrors on cars. These enable the motormen to see what is going on along the sides of their cars without turning their heads. The use of the mirrors has assisted materially in the prevention of accidents. They are installed on all closed cars and also soon will be placed on the open cars so that the motormen can easily watch the running board. The best methods of utilizing the services of local and company physicians and surgeons were

discussed. Mr. Gross also suggested that it would undoubtedly be a very satisfactory accident report detail if a witness were requested to write in his own handwriting over his signature a statement somewhat as follows: "I have carefully read the foregoing statement and have found it to be true and complete."

At the close of the afternoon session the supply men's exhibits were inspected. There were present at the convention 125 representatives of manufacturers whose products are sold to electric railways. About 25 supply houses exhibited apparatus and material. The exhibits were very numerous for a state association meeting.

Through the courtesy of the local railway and lighting companies the railway and supply men attending the convention were entertained at a theater party Thursday evening.

#### Friday Morning Session.

At the meeting on Friday morning a general discussion was held on the sub-

ject of "Advertising by Electric Railways," in which many members participated.

P. P. Crafts, general manager of the Iowa & Illinois Railway, Clinton, then read a paper on "Handling Fares on Interurban Railways," which appears elsewhere. This paper was discussed at considerable length.

C. L. Wight, auditor Inter-Urban Railway, Des Moines, read a paper on "Interstate Commerce Commission—Statistics and Accounts," which appears elsewhere.

The following officers were elected for the ensuing year: President—P. P. Crafts, general manager Iowa & Illinois Railway, Clinton, Ia.

Vice-President—R. A. Leussler, secretary and assistant manager Omaha & Council Bluffs Street Railway, Omaha, Neb.

Secretary-Treasurer—L. D. Mathes, manager Union Electric Company, Dubuque, Ia.

P. P. Crafts, the new president of the association, is



P. P. Crafts, President-Elect.

general manager of the Iowa & Illinois Railway at Clinton, Ia., and for the past year has been vice-president of the Iowa Street and Interurban Railway Association. Mr. Crafts has been connected with the street and interurban railways in the middle west for the past seven years, having spent a part of that time with the Saginaw, Mich., properties and the remainder with the Iowa & Illinois Railway operating between Clinton and Davenport, Ia. Last September he was appointed general manager of the Joplin & Pittsburg Railway under construction from Pittsburg, Kan., to Joplin, Mo., retaining at the same time the management of the Iowa & Illinois lines. As announced in the Electric Railway Review of last week, however, he has relinquished these duties in favor of R. W. Harris and henceforth will confine his attention to the management of the Iowa & Illinois road alone. Before coming west Mr. Crafts was associated with Stone & Webster of Boston, Mass., in various positions connected with the engineering and management of their properties.

The next annual meeting will be held the third Thursday in April, 1909, at Cedar Rapids, Ia.

#### IOWA ELECTRICAL ASSOCIATION.

The eighth annual meeting of the Iowa Electrical Association was held at the Savery hotel, Des Moines, Ia., on April 22 and 23, President George S. Carson of Iowa City presiding.

The programme included the following:

"Popularizing the Use of Electricity," E. L. Callahan, Chicago.

"Fraternalism," Gus Lundgren, Cherokee, Ia.

"Tact and System," J. W. Ferguson, Commonwealth Edison Company, Chicago.

"Economic Operation of a 200-Kilowatt Station (Features of Indicating Devices)," Austin Burt, Waterloo, Ia.

"Grounded Secondaries," Thomas Sloss, Cedar Rapids, Ia. Short talks on "Best Ways to Meet Gas and Gasoline Competition," Gus Lundgren, Cherokee, Ia., and M. A. Harrison, Nevada, Ia.

"Incandescent Lamp Development," F. W. Wilcox, Harrison, N. J.

"Electric Motor Characteristics," Prof. A. H. Ford, State University of Iowa.

"The Freight Question," E. G. Wylie, Des Moines, Ia.

Short talks on "New Business Methods" by L. D. Mathes, Dubuque; J. F. Porter, Davenport; E. L. Kirk, Sioux City; A. L. Dodd, Charles City; J. P. Walters, Toledo; C. O. Ingersoll, Marion.

#### Fitchburg & Leominster Street Railway Relief Association.

The Fitchburg & Leominster Street Railway Relief Association was organized on September 1, 1895, by the employes of the Fitchburg & Leominster Street Railway, Fitchburg, Mass. The idea originated with Robert N. Wallis, who was then and is now the treasurer of the railway, and Martin F. Farrell, one of the oldest employes of the company. F. P. Greene was the first president of the society and Mr. Wallis has been the treasurer since the office was created. The organization is governed by employes and the company never has had to assist it financially, although individual members of the board of directors make annual contributions to the treasury. The dues were fixed in the beginning at 50 cents per month and have remained at that figure, with the option that a second monthly assessment could be levied at any time the funds on hand amounted to \$100 or less. It has been necessary to make a second assessment in but one month. Ten dollars per week benefit is paid for a period not exceeding five weeks for the same sickness or injury, with the exception that only \$5.00 is paid for a single week's disability. At the present time the membership comprises two-thirds of the employes and there is a surplus of about \$1,300. About \$6,000 has been disbursed since the association was organized.

Edward N. Bassett of the New York public service commission recently stated that more tunnels were needed under the East river between New York and Brooklyn and that more rapid transit lines should lead to the suburbs.

#### HANDLING FARES ON INTERURBAN RAILWAYS.\*

BY P. P. CRAFTS, GENERAL MANAGER IOWA & ILLINOIS RAILWAY COMPANY.

Probably the question of proper collection, registration and auditing of interurban fares has received more attention from interurban managers than any other individual item in connection with their work.

It is fully as important to safeguard the receipts against loss through careless and inefficient methods of handling and accounting and the peculations of the dishonest employe and passenger as to properly account for the operating expenses, if not more so.

Too many of us look upon the money obtained from traffic as so much cash received, and do not give sufficient thought to analyzing and preventing the small leaks, which, taken individually, may be very small, but taken collectively amount to a good round sum each year. Such money is earned, yet neither collected nor accounted for.

For instance, a 3-car road, operating 12 trips per car per day of 18 hours, and losing only 10 cents per trip, will in one year be short \$1,314. One-half this amount expended in clerk hire or in proper ticket forms might

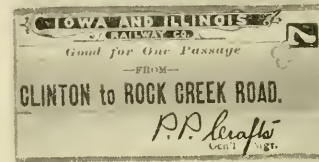

Iowa & Illinois Railway—Single-Trip Regular Rate Office Ticket (Full Size).

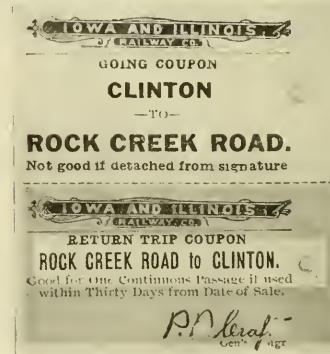

Iowa & Illinois Railway—Round-Trip Regular Rate Office Ticket (Full Size).

be the means of saving such a loss. On the other hand, some managers surround the handling and accounting of fares with so many safeguards that their expenses are enormous in proportion to the benefits derived.

#### The Important Question.

The question, therefore, resolves itself down to "What is the simplest system of accounting and tickets which, with the least expense, will transfer the greatest percentage of money due from traffic to the treasury of the company?"

The answer is not nearly so simple as perhaps it may seem, because local conditions of traffic, number of stops, terminal arrangements, etc., must govern the system finally adopted.

A road whose stops are far apart and which carries mostly through traffic, i. e., from one terminal to the other, may successfully adopt a system of collection and registration which would utterly fail of its purpose on a road whose stops were frequent and the local or short riding heavy. In other words, the fares lost from not being collected, on the latter line, because of a very accurate but cumbersome system of fare collection and registration, would be greater than the losses which might be sustained by the use of a somewhat less accurate system permitting quicker work on the part of the conductor.

This assertion, it must be admitted, is a very strong one, but the writer has, for several months past, operated two interurban lines, one of which presents the former condition, and one the latter. The opportunity to study both conditions has therefore been an excellent one and the experience gained of sufficient value to make the above statement.

\*A paper presented at the meeting of the Iowa Street and Interurban Railway Association, Des Moines, Ia., April 22 and 24, 1908.

A number of so-called standard systems have been devised from time to time, some of which have been guaranteed by the originators to cure all evils in the line of fare collection, etc., but local conditions were not given sufficient consideration, with the result that some of these systems have been adopted by some roads and some by others, but none of them has been sufficiently universal to be applied to all conditions.

**Systems of Fare Collection.**

The most universally used systems at present are as follows:

1. The duplex check used in various forms and in various manners.
  2. A combination of the duplex check, sold only on cars, and tickets sold only in stations.
  3. The use of registers upon which can be recorded the various classes of fares collected.
  4. The zone system of fare collection by which fares are collected every few miles and recorded on ordinary registers.
- Various other systems are in use, but the above described will be found on the greater majority of the electric lines in this country.
- Probably all the different forms of the duplex check, under that and other names, have been called to the attention of all interurban managers, therefore I will not take the time to describe them in this paper, but the variety of combinations of their use are worthy of description and discussion. The general combinations are:
- A. One form of duplex check for 1-way fares, with and without registers.
  - B. One form of duplex check for both single and round trip fares, with and without registers.
  - C. Two forms of duplex check, one for single and one for round trip fares, in either direction, with and without registers.
  - D. Four forms of duplex check, one for single and one for round trip fares in one direction; one for single and one for round trip fares in the opposite direction.
  - E. In addition to any of the above combinations forms

and for reasons only too obvious to all managers, it is desirable to have trip sheets made up and handed in at the end of each round trip. Tickets collected should also be handed in with the trip sheets upon which they have been recorded.

**Descriptions of Methods Used.**

To illustrate the point brought out earlier in this paper, the writer will describe the system of fare collection and accounting in use upon each of the roads which he has managed for some time past, namely the Iowa & Illinois Railway and the Joplin & Pittsburg Railway, the former illustrating the first and the latter the second class mentioned.

On the Iowa & Illinois Railway a combination system is used consisting of duplex checks sold only on cars, card tickets and mileage books sold at the terminal offices, together with special rate duplex checks sold on cars and special rate tickets sold in offices mentioned, the latter only for special rate days and for special car parties.

Of the regular rate tickets issued there are four forms of duplex checks, sold only on cars, one single-trip and one round-trip form for each direction. Four forms of terminal office tickets are also sold, one single-trip and one round-trip form for each terminal.

In addition a color scheme is also carried out, all tickets having colored panels printed upon them. Tickets which can be collected on southbound cars bear blue panels and those collected on northbound bear red panels.

It is therefore necessary for conductors to change their pads of tickets at the end of each half trip, and in order that they may have a sufficient supply on hand for all emergencies each conductor is provided with a small tin box having a proper lock, in which he can keep all tickets not actually in use.

Round-trip tickets are so arranged that the return coupon bears the proper color of panel for the return trip. The conductor of a southbound car sells a round-trip ticket having a red panel on the return coupon, retaining the plain going coupon. The same color scheme applies to office tickets sold at terminals.

Regular rate tickets are never sold at a reduced rate, a special form being provided for that purpose. These special rate tickets are easily distinguished from the regular rate tickets both by form and color. Therefore, if conductors receive orders to sell at reduced rate between any two points they must use the special rate form of check. Inasmuch as the terminal offices only sell reduced rate tickets between terminals, or between either terminal and the Iowa & Illinois park, only two forms of special rate tickets are sold at each of the offices mentioned. Special rates are never made for a ride in one direction only.

In addition to a fairly comprehensive system of tickets conductors must close trip sheets and turn them in, together with all tickets collected, at the end of each round trip. This, of course, materially increases the work of adding tickets, but it decreases the possibility of the double use of ticket stubs, against which the company is again partially protected by the consecutive numbering of each form of ticket, which also includes a letter designating whether the ticket is southbound or northbound.

We also make use of a register, but its purpose is not to register the amounts of fare paid by passengers nor to check the number of passengers on the car at any one time, except when going into or going out of the city of Davenport. This is done to comply with the terms of a terminal contract with the Tri-City Railway Company.

A daily check is kept of all tickets of different classes sold by each conductor and by each terminal office. When a conductor receives a pad of tickets he is charged with it by the beginning number. After checking through his trip sheets from the beginning to the end of his run, to ascertain whether or not the numbers of all tickets sold check with the closing number as reported at the end of the day, the closing number is entered on the ticket ledger and this number is, of course, the opening number for the following day. This same method is carried out in accounting for tickets sold by the terminal offices. When transferring tickets from the stock room to the distribution drawer care is taken that consecutive numbers are transferred and in no case are pads of tickets bearing anything but the proper numbers allowed to be issued to the conductors or to the offices.

We find it is a very easy matter to check irregularities or losses on the part of conductors or agents and to trace out any tickets presented for redemption. It is very surprising to some person demanding a return of his fare on some excuse, when, after asking a few questions, we ascertain that perhaps the party had picked up a receipt in a car leaving Clinton at 5:30 p. m., which receipt was left in the same car by some party riding on its 2:30 p. m. trip.

When the road was first started we had a large number

IOWA & ILLINOIS RAILWAY CO.		RETURN TRIP TICKET	FROM	TO
Return	to be Randed	IN	00019	
<small>IN CONSIDERATION OF THE REDUCED RATES WHICH ARE OFFERED ON THE IOWA &amp; ILLINOIS RAILWAY COMPANY, THE PASSENGERS ARE ADVISED TO TAKE CARE ON THE FACE OF THIS TICKET THAT THE STATIONS AND FARE PAID ARE CORRECT. IF THERE IS ANY ERROR IN THE TICKET, THE PASSENGER MUST RETURN IT TO THE OFFICE OF THE CONDUCTOR, WHO WILL BE RESPONSIBLE FOR THE CORRECTION. IF THE PASSENGER DOES NOT RETURN IT TO THE OFFICE OF THE CONDUCTOR, HE WILL BE RESPONSIBLE FOR THE CORRECTION.</small>				
CLINTON	**	**	CLINTON	**
19TH STREET	**	**	19TH STREET	**
CAMARON	**	**	CAMARON	**
ROCK CREEK RD.	**	**	ROCK CREEK RD.	**
SHAFTON	**	**	SHAFTON	**
WAPSI RIVER	**	**	WAPSI RIVER	**
PRINCETON	**	**	PRINCETON	**
QUARLES	**	**	QUARLES	**
LECLAIR	**	**	LECLAIR	**
TILE WORKS	**	**	TILE WORKS	**
PLEAS VALLEY	**	**	PLEAS VALLEY	**
NUTTINGS	**	**	NUTTINGS	**
BETTENDORF	**	**	BETTENDORF	**
DAVENPORT	**	**	DAVENPORT	**
DAVENPORT	**	**	DAVENPORT	**
FARE	15	20	25	30
PAID	25	30	35	40
DATE	1	2	3	4
TIME	1	2	3	4
NO.	1	2	3	4
INITIALS	1	2	3	4

IOWA & ILLINOIS RAILWAY CO.		RETURN TRIP TICKET	FROM	TO
Return	to be Randed	IN	00019	
<small>IN CONSIDERATION OF THE REDUCED RATES WHICH ARE OFFERED ON THE IOWA &amp; ILLINOIS RAILWAY COMPANY, THE PASSENGERS ARE ADVISED TO TAKE CARE ON THE FACE OF THIS TICKET THAT THE STATIONS AND FARE PAID ARE CORRECT. IF THERE IS ANY ERROR IN THE TICKET, THE PASSENGER MUST RETURN IT TO THE OFFICE OF THE CONDUCTOR, WHO WILL BE RESPONSIBLE FOR THE CORRECTION. IF THE PASSENGER DOES NOT RETURN IT TO THE OFFICE OF THE CONDUCTOR, HE WILL BE RESPONSIBLE FOR THE CORRECTION.</small>				
CLINTON	**	**	CLINTON	**
19TH STREET	**	**	19TH STREET	**
CAMARON	**	**	CAMARON	**
ROCK CREEK RD.	**	**	ROCK CREEK RD.	**
SHAFTON	**	**	SHAFTON	**
WAPSI RIVER	**	**	WAPSI RIVER	**
PRINCETON	**	**	PRINCETON	**
QUARLES	**	**	QUARLES	**
LECLAIR	**	**	LECLAIR	**
TILE WORKS	**	**	TILE WORKS	**
PLEAS VALLEY	**	**	PLEAS VALLEY	**
NUTTINGS	**	**	NUTTINGS	**
BETTENDORF	**	**	BETTENDORF	**
DAVENPORT	**	**	DAVENPORT	**
DAVENPORT	**	**	DAVENPORT	**
FARE	15	20	25	30
PAID	25	30	35	40
DATE	1	2	3	4
TIME	1	2	3	4
NO.	1	2	3	4
INITIALS	1	2	3	4

Iowa & Illinois Railway—Northbound Round-Trip Regular Rate Duplex Check Sold on Southbound Cars (Original 4 7/8 by 4 1/2 Inches, Unfolded).

for special reduced rates, generally used on certain days only. With any form of the duplex check a very careful record must be maintained of the checks issued to the conductors, and the number reported daily by them as used, and the checks turned in by all conductors, whether issued by the man turning in or by some other man.

One of the most valuable assistants in checking the issuing and collecting of checks is a comprehensive trip sheet which will not require that the conductor be a bookkeeper, but upon which he can properly classify the fares collected in an intelligent manner. In this connection some roads allow each conductor to use one trip sheet for the entire day, while others require a trip sheet to be turned in at the end of each swing or at the end of each trip. The necessity of either of the latter arrangements varies with conditions, but in general,



between the various towns and the morning and night traffic between the homes of the miners and their work is extremely heavy. To better illustrate the amount of local riding, I will state that the average fare per revenue passenger on this road is approximately 7½ cents in a maximum fare of 35 cents, without round trips or special rates, whereas on the Iowa & Illinois Railway the average fare per revenue passenger is 32 cents in a maximum fare of 70 cents, besides round trips, mileages and special rates, the latter being frequently given.

The situation on the Joplin & Pittsburg Railway was studied very carefully and it was soon ascertained that the use of a very comprehensive ticket system would defeat its purpose, because so many fares would be missed owing to the extremely large number of local passengers handled.

A system of registration by which all classes of fares could be rung up and recorded was finally adopted, hat checks being issued to designate passengers traveling between the principal stations. This system, however, has its disadvantages, because the conductor is comparatively free to ring up any amount of fare, regardless of what he collects.

This may seem like a very bold statement, but the writer has made a special study to ascertain whether or not passengers pay any particular attention to the registration of fares, and he is satisfied that a great majority pay no attention to it whatever. Even should they notice the ringing of the bell, it is very unlikely that they would pay any attention to the actual amount indicated on the face of the register. The average conductor also realizes this inattention on the part

come the objection to it by collecting full fare and requiring the conductor to ring up for each passenger carried in each zone. Assuming a car carrying over 200 people in a trip of 22 miles, the passengers would not be able to carry on much conversation and would hear very little else than the ringing of the fare register. This system, unless used in combination with duplex checks, also prevents an accurate accounting of passengers carried. The accounting for fares collected on the Joplin & Pittsburg Railway is naturally a simple matter, as, there being no round-trip or special rates, fares between any two points on the road remain the same. It is only necessary to check trip sheets with the registers and with cash turned in by the conductors. From the trip sheets also is obtained the number of passengers carried and the car mileage.

**Conclusions.**

In conclusion I believe it is conceded that the use of the duplex checks on roads whose short riding traffic is normal is practically a success, but a satisfactory system has not been discovered for roads carrying a large proportion of local traffic. There is great room for improvement in the latter instance.

One of the most important features in connection with any system of fare collection and accounting is to keep a careful record of tickets issued to conductors and offices, to have the conductors turn in frequently enough to prevent the double use of duplex checks and to carefully audit the returns of conductors and offices. It is extremely important, of course, that the latter item shall be followed up efficiently, otherwise mis-

**IOWA & ILLINOIS RAILWAY COMPANY,  
MONTHLY REPORT OF PASSENGERS CARRIED.**

MONTH OF ..... 190

DATE	REVENUE				TRANSFER				FREE		TOTAL				
	SOOTH ROUND	HEBIN ROUND	TOTAL	INCREASE OR DECREASE	TOTAL FROM JANUARY 1	INCREASE OR DECREASE	TOTAL	INCREASE OR DECREASE	TOTAL FROM JANUARY 1	INCREASE OR DECREASE	TOTAL	CARRIED	INCREASE OR DECREASE	TOTAL FROM JANUARY 1	INCREASE OR DECREASE
1															
2															
3															
...															
30															
31															
TOTAL															
AVER															
MAX															
MIN															

Iowa & Illinois Railway—Monthly Report of Passengers Carried (Original 12¼ by 11¼ Inches).

of the passengers, and it is, therefore, an easy matter for one so inclined to pick up enough daily, as I have heard it whispered around street corners, for lunches, cigars and drinks.

It is also very hard, when using this system, to check conductors who are inclined to be dishonest, for unless the checker can actually see the amount paid it is difficult for him to state positively that the conductor had "rung short."

The peculation of the dishonest conductor is, of course, limited to a certain extent, because he must keep a very accurate account of the number and amount of fares rung short, or his check with the register will be incorrect to such an extent that he lays himself open to suspicion at the office. He can determine in advance just how much he will take up on each trip and unless he becomes greedy enough to take a large amount or is caught by an inspector, he can make some pocket money.

The system of hat checks recently designed by Mr. Pierce of the East St. Louis & Suburban obviates this trouble to a certain extent, but it again introduces a considerable loss of time in the collection of fares.

One method which would partially overcome the difficulty referred to would be to use an ordinary fare register, registering by 5-cent fares. If a passenger paid 25 cents the register would be rung five times. This method, however, destroys the means of keeping account of passengers carried.

Another partial cure is the zone system, but the writer's experience with that system has been very unsatisfactory. The zone system as a general proposition causes the passengers too much annoyance and the earnings of the road must suffer in consequence. Some managers claim to have over-

takes will occur in the auditing department in connection with the correcting of conductors' mistakes, which will not only be embarrassing, but will destroy the efficiency of the auditing system. Under no condition should the handling of fares and tickets be allowed to drag in any department, because upon the efficiency of the system of accounting for receipts depends the efficiency of other departments, whose standard is set by the former.

The new line of the Connecticut Company, New Haven, Conn., between Rockville and Stafford Springs, Conn., was opened for traffic on Monday of this week. The line is 12.9 miles long and affords through service from Hartford to Stafford Springs. The running time from Rockville to Stafford Springs will be 45 minutes and from Hartford to Stafford Springs 1 hour and 45 minutes. Cars will run every hour. Power for the operation of the extension is secured from the Hartford Electric Light Company through a transformer substation in Rockville.

A 4-car elevated train of the Brooklyn Rapid Transit Company collided with a surface car at Eighteenth avenue and Eighty-sixth street, Bath Beach, on April 20, at a point where the elevated cars run on the surface and cross the tracks of the Coney Island and Thirty-ninth street line. Thirteen passengers were injured and traffic was delayed for several hours. Both cars were running slowly. It is stated that the cause of the accident was a misunderstanding of signals by a new motorman on the surface car.

## DEPRECIATION IN ELECTRIC RAILWAY ACCOUNTING.\*

BY DANIEL ROYSE, ASSISTANT EDITOR IN CHIEF, THE RAILWAY AGE.

Electric railways comprise an important part of the transportation industry of the country and are founded upon an enduring need. Therefore their securities should be among the most desirable of investments, considering both safety and income, but even in the largest centers of population, where the need of transportation is greatest and large earnings most certain, electric railway securities have in the past proved to be most precarious—not only as to earnings, but as to safety of capital—to illustrate which it is only necessary to refer to recent history in Chicago and New York.

This anomalous condition exists because for years the electric railway was on a promotion basis and was made to yield big returns to a few—it being made to appear that these returns came out of the earnings, when really they were in large part improper diversions of the capital of many innocent investors in both stocks and bonds. The practice of dissipating capital in the guise of dividends was possible because the matter of providing for the renewal of the physical property was ignored until the need of renewal was imminent, and then the simple device of a reorganization or a sale or lease to a new company afforded opportunity for charging the cost of rebuilding to capital account. In some cases corporation was thus piled upon corporation until the outstanding capital obligations amounted to ten or more times the annual gross earnings—in practice, apparently, the only limit was the capacity of the bond market to assimilate securities.

The fact that "Depreciation" is one of the subjects on the programme for this meeting of the Iowa Street and Interurban Railway Association is an indication not only that the members of the association recognize that depreciation of the physical property of electric railways does occur, but also that they wish to consider the extent to which it is desirable to make present provision for the demand which the future will bring.

## Neglecting Depreciation.

Heretofore recognition of depreciation and of the accrued liability resulting from it seldom has been given except when trying to convince the tax assessor that the property was not nearly as valuable as the reports of net earnings seemed to indicate, or when endeavoring to demonstrate that the books of some plant owned or operated by a municipality were not properly kept. Now, however, principally because of the activity of the interstate commerce commission and of the state railway commissions, which promise to co-operate with the national body, conditions are changed, and it is the part of wisdom, and of expediency as well, to meet the new conditions squarely and work in harmony with these regulating bodies.

The most serious effect of the mistaken theory heretofore so generally followed by electric railways is not the deceiving of investors, though in some cases the result to them has been sufficiently disastrous, but the misinforming of the public. Taught to believe that electric railways are cheap to operate and yield large returns to the owners, the public naturally has demanded that fares be reduced, that compensation for franchise grants be paid, that more extended transfer privileges be given, that the streets be paved, cleaned and lighted by the railways operating in them, etc. Moreover, it is believed that the growth of the idea that franchise grants should be strictly limited to a short term is for the most part due to this same misapprehension on the part of the public for which the railways are directly responsible.

In considering what present provision for future demands it is desirable or necessary to make railways should be classified according to the length of time their franchise grants run. Depreciation applies to all railways, but plans for the amortization or retirement of the capital need be made only by those companies having short-term franchises.

## Extent of Deterioration.

Depreciation is that deterioration of the physical property which is not made good by current repairs. For example, a car, though kept in the best of repair, eventually will have to be taken out of service and replaced. If the term of service be 20 years it is evident that the car each year has depreciated in value to the extent of 5 per cent of the difference between its original cost and its value as scrap. Assuming a scrap value of 20 per cent of the original cost, there will be a depreciation of 4 per cent per annum on the car. If no provision has been made for this current depreciation, when the time comes for replacing the car it will be necessary to

charge the 80 per cent of the cost of the old car to operating expenses if the capital is to remain unimpaired.

This in general has for many years been the practice of the steam railways, and is that prescribed in the "Standard Classification of Operating Expenses" adopted in 1898 by the Street Railway Accountants' Association. There is, however, much reason to believe that electric railways have too often charged renewals to "Construction" or "Reconstruction," instead of to operating expenses under the head of "Maintenance," as the standard requires.

But even if the injunction to include in maintenance "all expenditures for repairs and renewals" be strictly observed, there will be a gradual reduction in the value of the physical property subject to depreciation that will finally amount to between 40 and 50 per cent of the original cost of that property. To illustrate: Railways develop gradually and their equipment is acquired from time to time as the need arises. Now, take 20 cars, purchased one each year, the oldest having been in service 19½ years, another 18½ years, and so on down to the newest, which is ½ year old. The life of cars being taken at 20 years, the total car-years of service yet before these 20 cars is 200, or an average of 10 years per car. With salvage at 20 per cent of the cost the average depreciation of the cars is  $\frac{1}{2}(100 - 20) = 40$  per cent of the cost.

The same reasoning applied to other classes of equipment will give similar results, varying a little according as the scrap value is greater or less than 20 per cent. When a group of units, such as the cars in the example cited, varying in age by equal increments is considered the life assumed does not affect the average depreciation, it being always one-half of the total life if the computation be made midway between the regular renewal dates. Hence the conclusion that when proper renewals are made the normal value for service of the physical property of a railway after a sufficient period of operation is only from 50 to 60 per cent of its original cost.

## Tentative Plan of Interstate Commerce Commission.

In Accounting Series Circular No. 20, dated January 10, 1908, Prof. Henry C. Adams, in charge of statistics and accounts for the interstate commerce commission, submitted tentative classifications for the operating expense accounts of electric railways engaged in interstate commerce, which classifications contain provisions for depreciation accounts as follows:

A. Under the head of "Depreciation Estimate—Revenue Equipment" in "Maintenance of Equipment," there are provided eight accounts for cars and locomotives, and under "Depreciation Estimate—Service Equipment," in "Maintenance of Way and Structures," three accounts. Each of these 11 accounts is designated "Depreciation Estimate" and is subdivided into two subaccounts designated as "Estimate" and "Renewals," respectively. The instructions as to what are included in the subaccounts, taking "Passenger Cars" as an example, read as follows:

"a-1. Passenger Cars—Estimate.

"This account includes a monthly charge of one-twelfth ( $\frac{1}{12}$ ) of . . . per cent per annum of the original cost (estimated, if not known) of passenger cars, to provide a fund for replacement when retired.

"Note.—Where, in the opinion of the carrier company, depreciation can be more accurately estimated by basing the estimate upon the service rendered by the property, such method of estimate may be permitted, in case the carrier company first files with the . . . . . commission a statement of the rule or principle upon which it will base its estimates of depreciation, subject to disapproval by the commission.

"a-2. Passenger Cars—Renewals.

"This account includes the original cost (estimated, if not known) of all passenger cars condemned, destroyed or sold, less:

"Amount previously charged for depreciation up to date of retirement; plus

"Scrap value of salvage or the amount received from sale of passenger cars retired.

"Note A.—Passenger cars permanently retired from service, but held, pending disposition, should be written out of service through this account, and carried in an appropriate material account at a nominal valuation or at actual scrap value, if determinable.

"Note B.—The appropriate charge to this account, in respect to equipment in service on (a fixed date, as, July 1, 1908), will be determined by deducting from its depreciated value on that date the amount charged for depreciation accruing subsequently to (June 30, 1908), up to the date of retirement, and the scrap value of salvage or the amount received from sale of such equipment retired. The depreciation accruing before (a fixed date, as, July 1, 1908) must not be

\*A paper presented at the meeting of the Iowa Street and Interurban Railway Association, Des Moines, Ia., April 23 and 24, 1908.

charged to the operating expenses of any part of the period subsequent to (June 30, 1908). The purpose of the instructions in this note is to prevent any charge against Renewals Account for depreciation accruing previously to the setting up of regular depreciation charges under this classification, and, inasmuch as such previously accrued depreciation is not an item of current operating expenses, it should be adjusted by appropriate entries in the general books."

B. Under the head of "Depreciation Estimate—Maintenance of Shop and Power Apparatus," in "Maintenance of Equipment," there are provided three accounts, each subdivided into two, with designations and instructions, taking "Shop Machinery and Tools" as an example, as follows:

"(a) Depreciation Estimate.—'Shop Machinery and Tools.'

"a-1. Shop Machinery and Tools—Estimate.

"This account includes a monthly charge of one-twelfth of . . . per cent per annum of the original cost (estimated, if not known) of shop machinery and tools in service to provide a fund for replacement when retired.

"a-2. Shop Machinery and Tools—Adjustment.

"This account includes the original cost (estimated, if not known) of all shop machinery and tools prematurely condemned, destroyed, sold or otherwise removed from service, less the amount previously charged for depreciation up to date of retirement and salvage recovered from final disposition."

C. Under the heads of "Depreciation Estimate, . . . . .," in "Maintenance of Way and Structures," there are provided 25 accounts, each subdivided into two, with designations and instructions, taking "Rails" as an example, as follows:

"b-1. Rails—Estimate.

"This account includes a monthly charge of one-twelfth of . . . per cent per annum of the original cost (estimated, if not known) of rails in service to provide a fund for replacement when retired.

"b-2. Rails—Adjustment.

"This account includes the original cost (estimated, if not known) of all rails prematurely condemned, destroyed, sold or otherwise removed from service, less the amount previously charged for depreciation up to date of retirement and salvage recovered from final disposition."

Of these three groups two, B and C, it is stated, have been included only for the convenience of those desiring to use them and are not at this time required, the explanatory note reading as follows:

"Note.—Depreciation charges on maintenance of way property are not required at this time by the interstate commerce commission. It is arranged, however, in this classification to introduce this account to provide rules for computing depreciation charges on maintenance of way property for the guidance of those carriers that desire to make such depreciation charges, and for the use of such commissions of the various states as may prescribe them."

In discussing depreciation Professor Adams further says:

"5. The monthly charges to operating expenses for 'depreciation' on the several classes of equipment will, of necessity, create or require corresponding liability accounts to which such depreciation may be credited. To that end carriers will be required, beginning . . . . ., to set up an appropriate liability depreciation account for each of the several classes of equipment upon which depreciation is charged. These accounts should be designated as follows:

"(a) Electric Locomotives—Replacement.

"(b) Passenger Train Cars—Replacement.

"(c) Freight Train Cars—Replacement.

"(d) Electric Equipment of Cars—Replacement.

"(e) Work Equipment—Replacement.

"To these replacement accounts should be credited monthly the amount of accrued depreciation on each class of equipment, respectively. Such credits should invariably equal the gross charges to maintenance for depreciation."

On analyzing these instructions it is seen that two objects are sought through the establishment of depreciation of equipment accounts:

(1) The charging to operating expenses monthly of a sum sufficient to cover the depreciation of equipment that is accruing currently over and above that loss in value which is made good through current repairs and maintenance.

(2) A means whereby there will be charged to surplus or profit and loss, in the course of a number of years, representing the average life of the property subject to depreciation, a sum equivalent to the total depreciation of equipment that had already accrued prior to some fixed date, as, for instance, July 1, 1908.

#### Two Objects Sought by Commission.

The fact that these two objects are coupled does not mean that both are equally desirable or undesirable—each proposition should be considered on its merits. Concerning the first object, accounting for current depreciation month by

month, the writer believes that since depreciation exists it should be accounted for as it accrues.

The depreciation of equipment which ultimately results in the need for renewals is an accrued liability and should have a place in the balance sheet. This being true, the corresponding debit should appear somewhere in the accounts.

Charging accrued depreciation to operating expenses or to income and crediting a reserve account cannot affect the liability of a company to its bondholders, nor will such entries in the books, since they involve the payment of no real money, curtail the ability of the company to pay fixed charges. Further, such entries need not curtail the payment of dividends, but if the dividends are paid these entries will perform the important function of showing the stockholder that his dividend has come out of capital and not out of profits, and of showing the bondholder that his security is being impaired, facts which the investors and, in the case of a permanent institution like a railroad, the public should fully appreciate.

Whether these charges should be made to operating expenses or to income is perhaps open to argument, but it is the opinion of the writer that they should be made to income, first for the reason that depreciation is not an "expense" because it may not involve the payment of money (per contra, appreciation if shown would not be credited to earnings) and, second, because depreciation goes on independent of operation; especially is this latter true of that class of depreciation caused by the advancement of the art, sometimes designated as that due to obsolescence or supersession.

In considering the second object of the commission—the charging of depreciation already accrued to surplus—it is necessary to distinguish between companies having short-term franchises and those not so limited. As regards the former the accrued depreciation must be made good before the franchise expires or the investors—stockholders or bondholders or both—will surely suffer. With railway companies owning their rights of way, terminals, etc., in fee, the case is different and they perhaps can claim credit for the appreciation of the portion of their assets that is not subject to depreciation. This phase of depreciation accounting is discussed by Frederic A. Delano, president of the Wabash Railroad, in a paper published in *The Railway Age* of March 27, 1908, page 471. In this connection Mr. Delano says:

#### III. Depreciation of the Railroad Plant as a Whole.

"(a) Steam railroads do not have to provide for any depreciation as against the expiration of a franchise, which, of course, is a serious item with public service corporations having limited franchises. Nor is there, in the case of steam railroads, a large share of the total investment in a central power plant which is becoming obsolete. In most cases the depreciation due to the diminished value of equipment, track, bridges, structures of all kinds, shops and shop tools already referred to, is limited, as has been explained, and is, furthermore, a good deal more than counterbalanced by the appreciation due to the fact that the age of the railroad has given it an established business. This amounts to a good deal more in the case of a railroad than what is called 'good will' in the case of a mercantile corporation. As a railroad is developed industries, mines, factories, etc., are established along its tracks, with switches and sidetrack facilities, towns grow up along it and a certain amount of business becomes assured to it—business which it takes years and a large expenditure of money and energy to develop—all of which is charged into current operating expenses and should be considered as an offset to any depreciation of the property.

"(b) Besides the appreciation due to this cause there is, of course, an actual physical enhancement of value due to the condition of the roadbed and embankments becoming better solidified, the water courses established and the original structures gradually replaced with others of a more permanent character, even without any addition to capital account; thus wooden trestles, bridges, culverts, etc., have been filled with earth or replaced by steel or iron, stone or concrete.

"(c) No account is taken and no estimate can be made of the enhanced value of the railroad property (right of way and terminals) due to the enhanced value of the land, even though the existence of the railroad may have contributed largely to the development of the country through which it runs. The railroad corporation suffers by reason of this enhanced value which it has so largely contributed to create if it is compelled to purchase any additional property, as well as in the increased amount of the taxes it is called upon to pay each year as its contribution to the needs of the growing communities; but it has not been usual to make any allowance for this. Those who have had the greatest experience with railways generally believe that the enhancement in value or appreciation of the property in the direction already referred to far more than balances the depreciation, especially when it is remembered that the total physical depreciation under

proper maintenance rules is, without doubt, limited to about half the first cost of the property subject to depreciation."

Strictly urban properties with limited franchises and those having tracks laid in the public highways cannot avail themselves of these arguments to the same extent.

**Charges for Maintenance and Depreciation.**

It may be desirable to cite some statistics to show how much those railways which undertake to care for current depreciation find it necessary to provide for this purpose. Here it is proper to say that expenditures for repairs, renewals and depreciation charges should all be grouped together, since any one of the three items taken separately means but little, because human nature is too apt to shift the dividing line between repairs and renewals according to the showing it is desired to make. Thus grouped it is found that the gross receipts per mile, the total of repairs, renewals and depreciation per mile, and the latter expressed as a percentage of the former are as follows for the properties which are making the largest provision for current depreciation:

1899.	1903.	1905.	1906.	1907.
7.89	8.09	14.44	16.25	15.98

The new ordinances of the Chicago City Railway Company and the Chicago Railways Company specify that after the 3-year period of rehabilitation at least 6 per cent of gross receipts shall be spent or reserved for repairs and that 8 per cent of gross receipts shall be spent or reserved for renewals. The reserves are to be carried in cash with approved depositaries. In the case of the Chicago City Railway the total maintenance reported for the first half of 1907 was 13.05 per cent of earnings.

The Union Electric Company of Dubuque, Ia., began January 1, 1906, to set aside 20 per cent of gross receipts for the purpose of maintenance and depreciation reserves. For the railway department in 1906 maintenance amounted to 11 per cent, leaving 9 per cent of the gross receipts to apply on account of depreciation; in 1907 maintenance required 7½ per cent, leaving 12½ per cent of the gross receipts for the depreciation reserve.

The British Columbia Electric Railway Company, Van-

**Depreciation in Electric Railway Accounting—Gross Receipts and Charges for Maintenance and Depreciation per Mile of Single Track.**

	Fiscal year	Total gross receipts per mile of single track	Total maintenance and depreciation per mile of single track	Maintenance and depreciation in per cent of gross receipts.
Steam railways of the United States as reported to the interstate commerce commission...	1899	\$ 5,308	\$1,313	24.74
Steam railways of the United States as reported to the interstate commerce commission...	1902	6,453	1,684	26.10
Steam railways of the United States as reported to the interstate commerce commission...	1904	6,815	1,779	26.10
Steam railways of the United States as reported to the interstate commerce commission...	1905	6,956	1,837	26.41
Steam railways of the United States as reported to the interstate commerce commission...	1906	7,536	2,019	26.83
Steam railways reporting to New York railroad commission.....	1905	10,548	2,674	25.35
West Chicago Street Railroad.....	1904	26,857	6,445	*24.00
North Chicago Street Railroad.....	1904	33,607	7,394	*22.00
Milwaukee Electric Railway & Light Company (railway department).....	1906	28,632	4,606	17.97

\*Percentage is the same in 1905 and 1906. †Gross earnings.

In addition to the electric railways given in the table roads making charges for depreciation include the following:

The United Railways Company of St. Louis began in January, 1905, to charge off 5 per cent of gross earnings, crediting it to a depreciation reserve. In 1906 the total charges for maintenance and depreciation amounted to 15.09 per cent of gross earnings. In 1907 the charge for depreciation was 5.08 per cent and the total of maintenance and depreciation was 18.69 per cent of gross earnings.

The Milwaukee Light Heat & Traction Company began in 1903 by charging 5 per cent of gross earnings for depreciation, increasing the proportion 1 per cent each year, so that the charge was 9 per cent of gross earnings in 1907, and presumably is 10 per cent for the current year. In 1907 the railway departments of the Milwaukee Electric Railway & Light Company and the Milwaukee Light Heat & Traction Company showed gross earnings of \$14,330 per mile of single track; maintenance was 10.28 per cent and depreciation 6.84 per cent of gross earnings.

The Wisconsin Traction Light Heat & Power Company of Appleton, Wis., in 1907 began to charge 5 per cent of gross earnings for depreciation, the intention being to increase the proportion gradually to 10 per cent. The rate this year is 6 per cent. In 1907 the total of maintenance and depreciation for the railway department was 19.21 per cent of gross earnings.

The foregoing three companies are all under the management of John I. Beggs, who, it is believed, was the pioneer in this country in the matter of accounting for depreciation, having begun with the Milwaukee Electric Railway & Light Company in 1897.

The International Traction System of Buffalo, in its report for 1907, shows a depreciation charge of 5 per cent of gross earnings. In the 1906 report no such charge was shown, but in the 1907 report the figures for 1906 were differently stated to permit of comparison and the depreciation charge for 1906 is shown at about 4¼ per cent of gross earnings, this being subtracted from the operating expenses as shown the year before. Figures published in American Street Railway Investments show the total of maintenance and depreciation charges (no depreciation shown prior to 1906) in per cent of gross receipts for this system to have been as follows:

1903.	1904.	1905.	1906.	1907.
7.52	10.00	9.48	14.17	15.03

This indicates that the proper interpretation was not placed upon maintenance until 1906. The maintenance for 1907 was assumed to bear the same ratio to depreciation as in 1906, in order to get the 15.03 per cent given.

The Twin City Rapid Transit Company (Electric Railway Review, September 14, 1907, page 301) began to establish renewal reserves in 1905, setting aside 7.14 per cent of gross earnings in 1905, 8.54 per cent in 1906 and 8.35 per cent in 1907. The totals of maintenance and renewal reserves in per cent of gross earnings have been:

couver and Victoria, B. C., has for some years charged depreciation at the rate of 5 per cent on steam, electrical and water machinery, 3.5 per cent on rolling stock, 10 per cent on poles, 3 per cent on lines, 2 per cent on track and 1 per cent on buildings.

The Kansas City Western Railway, operating between Kansas City and Leavenworth, and in Leavenworth, Kan., has adopted 7.5 per cent on steam and electrical machinery and rolling stock, 5 per cent on poles, 55 cents per ton on rails, 12.5 per cent on ties, 10 per cent on paving and 2.5 per cent on buildings, as the annual depreciation charges.

Referring to this table the following points should be noted:

1. The steam railways have long included renewals in operating expenses and it is fair to presume that the maintenance expenditures shown include ample provision for current depreciation.

2. The percentages of 22 and 24, respectively, for the North Chicago and the West Chicago lines were fixed after a careful survey of the property and examination of the books by the company's engineers and by Stone & Webster. An account of this work was published in the Electric Railway Review of February 23, 1907.

3. The allowance for depreciation of the Milwaukee Electric Railway & Light Company, which is 10 per cent of gross earnings, is not considered by the management to be as large as it should be. In replying to the inquiries in Accounting Series Circular No. 20 of the interstate commerce commission, C. N. Duffy, comptroller of the company, said (Electric Railway Review, April 4, 1908): "This company believes in the principle of depreciation and the practical application of the principle in providing for depreciation in its accounts; it has recognized and applied this principle in its accounts since January 1, 1897. The provision for depreciation has not been to the extent the company considered necessary, but to the extent it was consistently able to provide and give to capital some measure of fair return on its investment."

**Conclusion.**

From the foregoing arguments the conclusions are that current depreciation ought to be provided for and that when this is done the total charges for up-keep and replacement of the property of an electric railway will approximate one-quarter of the gross earnings. That is, one-fourth of the gross earnings should be sufficient if the road has a fair amount of traffic and a proper basis for fares.

An estimate of the amount of the charges for depreciation may be made in another way. The reports of the Chicago Union Traction Company and the Glasgow Tramways committee show that where charges for repairs and for depreciation are carefully divided the latter is about one-third greater than the former. Analysis of the reports of electric railways to the railroad commissioners of New York, Massachusetts and Connecticut indicate that these companies are expending for



"maintenance" about one-third more in proportion than the Chicago and Glasgow lines cited are expending for "repairs." From this it may be inferred that to provide for current depreciation would require an additional charge equal to 75 per cent of the usual charges for maintenance.

It is now in order to inquire what benefit may be expected from the assumption of a burden that must in many cases, for a time at least, prove to be very onerous, and the answer is that the policy must result in bringing about better relations between the public and the railways. With the facts honestly placed before the public it is not too much to hope that short-term franchises, unreasonable exactions as to compensation and inadequate fares will become things of the past. A beginning has already been made in Massachusetts, where within a few months fares on several roads have been increased from 5 cents to 6 cents, or the 5-cent zones correspondingly narrowed, and as this has the approval of the state railway commissioners the other improvements mentioned are not entirely utopian.

## REINFORCED CONCRETE IN ELECTRIC RAILWAY CONSTRUCTION.\*

BY N. M. STARK, CONSTRUCTING ENGINEER.

Bridges for street and interurban railways in the state of Iowa have, in the past, consisted mainly of wooden trestles or steel girders or trusses. Both steel and wooden bridges, however, are lacking in two important requisites—permanence and a continuous solid roadbed. Wood decays quickly and when used unprotected in open trestles can hardly be expected to endure for more than six or eight years. The wooden trestle may play an important part, however, in the construction of new lines desired to be put in operation quickly at low first cost, with the intention later of replacing the trestles with more permanent structures. But such a method of construction must be dictated by great necessities, as the waste due to the building with wood and later replacing with masonry far exceeds the usual return on investments in such properties.

When spans of greater length are required steel bridges have been used, but the life of a new steel bridge on masonry, even with careful inspection, can hardly be considered to be more than 20 to 25 years; and even then with continual outlay for repairs and painting in addition to the inspection. The erection of such a bridge requires first the building of the masonry substructure, then the purchasing of the metal from the mill, to be fabricated at a bridge shop and subsequently erected at the bridge site on the masonry substructure—all of which requires a considerable amount of time that may in some cases prove to be of the greatest value.

### Value of Concrete Bridges.

Reinforced concrete bridges avoid the objections named above and, in fact, possess nearly all the qualities that are desirable in a bridge for railway traffic. Reinforced concrete bridges are absolutely permanent. Concrete is more durable than stone itself and concrete is the best preservative that has ever been discovered for steel. A reinforced concrete bridge, therefore, built of concrete with all of its steel reinforcement thoroughly embedded, comes as near to being a permanent structure as it is possible to devise with materials at present known and used.

But in addition to this feature of lack of deterioration this type of structure has a still more important advantage over the other kinds of bridges. Steel and wooden bridges grow weaker from rust and decay from the very first day of erection. Traffic on our steam railways has increased in weight so rapidly and steadily that many bridges built not more than 10 years ago are now too light for the traffic. Electric railways are proving no exception to this rule and the prospects are that loadings for street and interurban railways will increase even more rapidly. The day must come very quickly, then, when the bridge of decreasing strength will be overloaded by the rapidly increasing traffic and will either collapse or require strengthening or replacing. The reinforced concrete bridge, on the other hand, grows stronger with age and in a more rapidly increasing ratio than the increase of traffic; so that a bridge of this type is not only free from deterioration, but actually provides for future contingencies of travel and is therefore permanent in the highest sense.

Concrete bridges are erected with great rapidity and subject to a minimum of delays. Cement and reinforcing bars are purchasable from stock; construction can be begun, there-

fore, as quickly as the tools and men can be shipped to the location. As an illustration, we erected a 40-foot span reinforced concrete arch in the fall of 1907 in 12 working days and opened it for travel immediately.

### Questions of Design.

If reinforced concrete bridges were built with open floor systems, similar to those of steel and wooden bridges, and which are quite as feasible in the concrete bridge, the cost of such a structure would be less than that of steel of the same carrying capacity. But to build such a permanent structure as a concrete bridge with an open floor system seems hardly consistent. The concrete bridge is so readily adapted to continuous solid roadbeds, and the advantage of such a roadbed is so great, that a concrete bridge is rarely built in any other way. Steel and wooden bridges are readily designed with solid continuous roadways, but their use so increases the cost of inspection and repairs, in addition to the increased weight of the bridge, that their adoption with such structures is impracticable. With concrete bridges, however, the continuous roadbed is the natural and preferable solution.

A bridge of this type, therefore, ought not to be compared with the more temporary structures as to first cost, because it is a much more satisfactory structure in every way and requires nothing for repairs or maintenance. In order to give some idea of cost it may be said that such concrete bridges do not ordinarily run more than 10 to 20 per cent higher than steel in first cost; a difference which is far more than offset by saving in maintenance, by the advantage of solid roadbed and by speed of erection.

Wooden trestles and steel bridges are rapidly being replaced on steam railways and on the older electric lines by concrete bridges. Such reconstruction is readily accomplished without interfering with train service, as the concrete bridge can be built around the old trestle, to be cut out later when the concrete bridge is filled and ballasted.

### Building Methods.

Concrete bridges have become so popular that their construction has been undertaken by almost every contractor that ever attempted to build a masonry substructure, although their experience in this line of work may have been extremely limited. Satisfactory bridges cannot be erected in concrete by such methods. There is, perhaps, no material that is more susceptible than concrete to the hand of a master workman, nor any that is more easily disfigured and defaced by the unskilled amateur. To become a skilled foreman in this line of work it is not alone sufficient that a man should learn by costly experience at the expense of bridge after bridge; he should learn by apprenticeship under a skilled foreman of wide experience. It is as much business for experts as any other type of bridge erection. To assume that an engineer who has never had experience in the design of such structures will be able to design a satisfactory structure by referring to text books written by men who have never had experience in such lines is to expect the impossible. And, even granting that a satisfactory design is secured, then to entrust the erection to a contractor who has no interest in the design save to execute it at the lowest cost, is to invite disaster. The design and erection should be entrusted to men experienced in such lines, who will do their work with the intention of backing it up and making right anything that may prove unsatisfactory.

In seven years past we have constructed some 75 to 100 reinforced concrete arches and culverts of various sizes, employing various forms of reinforcement to suit the purchaser; and after extended experience we have come to the conclusion that what is known as the "Luten" system of reinforced arches offers the greatest advantage to the purchaser in economy, rapidity of construction and rational design, with consequent safety. This system of construction consists of reinforcement of plain rods placed in the tensional regions of the arch. Coupled with this are numerous improvements in bridge construction, as, for example, the flood-proof pavement laid across the bed of the stream.

Another feature particularly adapted to small arches and culverts for railways, especially under heavy fills, is the horse-shoe arch, so called from the form of its end. This type of arch, instead of being provided with wings and spandrel walls, as has been the usual design of arches, has the barrel of the arch extended until it meets the plane of the side slope of earth filling. The barrel of the arch is cut to fit this slope and the sharp edge that would result is avoided by squaring the end of the arch ring, normal to the intrades or soffit of the arch. A shoulder is provided over the top of the ring to hold the toe of the earth slope. An arch of this type can be built for about 25 per cent less in first cost than the usual spandrel and wing type because of the saving in forms and materials. The centering for the arch is extended to the

\*A paper presented at the meeting of the Iowa Street and Interurban Railway Association, Des Moines, Ia., April 23 and 24, 1908.

ends of the excavation and the horseshoe end troweled to the desired surface without the expense of placing any more forms than those for the centering only. An arch of this kind represents the maximum of efficiency for locations where a cheap and very effective structure is desired and where considerations of appearance do not require a more attractive type.

From this type of culvert to the immense bridge built across the Maumee river near Toledo, O., last year, is a big step; yet it represents a structure which is quite as readily adapted to the Luten system. This Maumee bridge has 12 spans of 75 to 90 feet each, making a structure 1,200 feet long. The grade of roadbed is 45 feet above low water. The bridge is a single-track structure with 16 feet of roadbed between copings, and was built for the Lima & Toledo Traction Company of Cincinnati, O. It will be thrown open to traffic in May of this year.

These various bridges are typical of hundreds that have been erected the past seven years under this system and are now being used by electric railroads in Indiana and Ohio, where, by the way, electric railroads have had their greatest development. The Indianapolis & Northwestern Railway has over 50 arches of the horseshoe type in as many miles of track. This type of bridge has been adopted by these lines because it represents the most efficient bridge that can be procured for a permanent type of construction. Compared with the ordinary forms of plain concrete culverts or masonry arches, these bridges represent a saving of 25 to 50 per cent. Add to this the fact that they are flood-proof and practically indestructible, and little more can be asked in the way of the ideal railroad bridge.

#### CLAIMS—METHODS OF HANDLING BY ELECTRIC RAILWAYS.\*

BY ARTHUR W. GROSS, GENERAL CLAIM AGENT OMAHA & COUNCIL BLUFFS STREET RAILWAY.

Claim departments of electric railway companies are conducted along similar lines, each company, of course, having some peculiarity of its own. It is hard to say which shows the best results. At the close of the year the footings are observed to ascertain what has been accomplished—not alone to learn the amount of money expended and the number of claims disposed of, but how much, in the way of pending claims and suits, is left on our hands to contend with.

##### System at Omaha.

While I am not prepared to state that the method of handling claims by the Omaha & Council Bluffs Street Railway Company is better than others, I must, with your kind forbearance, necessarily confine myself to the workings of our claim department. I shall begin with the happening of an accident.

When the accident is of ordinary character reports are made by the trainmen during that day, upon blanks kept at the car house office and turned in to the foreman, who forwards them to the claim department. Vertical files are made for each set of reports, entered numerically in a record book and filed away to correspond in a cabinet holding the reports of four years' business, this being the period of our statute of limitations in Nebraska, so that complete records are before us at all times. Our superintendent of transportation immediately follows the accident from an operating standpoint, for the purpose of determining if it was caused through the carelessness of the conductor or motorman. If this is found to be the case the delinquent one is given a heart-to-heart talk, and it is explained to him just where he was negligent, what the result of his negligence was or might have been. Unless the accident is one of liability, or partially so, no investigation is carried on until a claim or demand is made. Then an investigator will interview the witnesses, obtain written signed statements from them and procure a detailed signed statement from the claimant whenever possible.

In cases of liability, such as collisions, derailments, etc., resulting in serious injury, the trainmen are required to report to the claim department. Our policy is to get in touch with the injured person or members of the family. If his condition is such as to permit of making a settlement we attempt to do so at once; always guarding against the fact, however, of taking a release which could be attacked and invalidated on the ground of incompetency. Where it is deemed inadvisable, or a settlement cannot be effected, our

efforts are directed toward keeping the lawyers out and bringing about an adjustment at the first opportune time.

One of the most successful pieces of work accomplished by us, although the most unfortunate accident the company has ever had, occurred when two cars came together in a head-on collision, the southbound car getting beyond control of the motorman while running down a steep grade, leaving the track and plowing through the northbound car on the parallel track. Three persons were killed and 48 others more or less seriously injured. It required considerable time and labor to effect settlements in all of these cases, yet only one got away into the hands of a lawyer, and that because the amount claimed was unreasonable and we were willing to risk a lawsuit.

We do not employ a regular company surgeon, but call upon various doctors when desiring examinations, thereby eliminating, to some extent, the feeling that the report or testimony is given with a view of unduly aiding or assisting the railway company. There is very little opposition to our obtaining written medical reports, upon blanks furnished by us, from attending physicians. We pay a fee of \$2.00 for such service.

The claims considered by all as most difficult to handle are those where reports have not been made by the trainmen and the claim department has no record nor knowledge of the accident except as received through the claimant or his attorney. This class of cases requires an endless amount of work before results (if any) are obtained.

We attempt to locate the crew, using for this purpose the time schedule of cars and such other facts as have come into our possession. In some instances we send a tracer to the car houses, setting forth the details of the accident and the crews working on certain lines. The men are required to answer "Yes" or "No" opposite their respective names. Occasionally we draft separate affidavits to be signed and sworn to individually. Every avenue of information is penetrated, commencing at the scene of the accident, following it to the injured person's home and throughout the neighborhood in which he lives, and the places frequented by him. Where the claim appears to have the ear marks of fraud we will fight it to the end.

##### Preventing Accidents.

Let me say a few words regarding the efforts we are making toward the prevention of accidents. It means so much, and the mutual benefit derived is so great, that I am firmly inclined to the belief of its being the only method through which the red ink entries, now so glaring upon the records of a claim department, can be made a nightmare of the past.

In explanation of that part of our anti-accident campaign which consists of talks made by the general manager or assistant general manager, superintendent of transportation, assistant superintendent of transportation and the claim agent to the conductors and motormen of the various divisions of our system, some of the matters touched upon follow:

That trainmen see and know but one side of an accident.

That they do not realize that accidents carry with them a world of sorrow, grief and hardship.

That the saving of life, limb and property should be uppermost in their minds.

That they would be staggered by the enormous outlay and expense made necessary in the settlement and handling of claims.

That it is the duty of a conductor or motorman to prevent, if possible, every accident, including those resulting from the carelessness of passengers and pedestrians.

In addition to the talks to our conductors and motormen we are also taking other steps looking toward the prevention of accidents. For instance, we have had published in the newspapers a series of talks to the public cautioning them to be careful on and about street cars; we also have placed in all of our cars a picture illustrating the right and wrong way of getting off a car, which we had made from photographs taken from life and on which we designated the right way as "safe and graceful" and the wrong way as "dangerous and awkward."

We have also enlisted the support of the principals and teachers of schools, and the probation officer and his staff, in keeping boys from jumping on cars and children from playing in the streets on which there are car tracks. The aid of the physical director of the Young Women's Christian Association also has been enlisted in educating the young women as to the proper way to get on and off cars.

Our men exhibit a very fine spirit in this educational campaign and have shown themselves just as eager to prevent accidents, when the matter is put before them in the proper light, as we are ourselves.

\*Abstract of paper read before the Iowa Street and Interurban Railway Association at Des Moines, Ia., April 24, 1908.

## INTERSTATE COMMERCE COMMISSION STATISTICS AND ACCOUNTS.\*

BY C. L. WIGHT, AUDITOR INTER-URBAN RAILWAY, DES MOINES, IA.

The present system of classification of accounts of electric railways is the result of over 11 years' study by the responsible heads of the accounting departments connected with the various street and interurban railways of this country. At each annual meeting of the Accountants' association revisions of the classification have been made after much debate, and, as the result of extended correspondence, the classification became the standard method of accounting and has been adopted by nearly all of the electric railways throughout this country and Canada. So thoroughly and comprehensively has this work been done that the various state railroad commissions have adopted our system of accounting for their annual reports.

At the last annual meeting of the American Street and Interurban Railway Accountants' Association, held at Atlantic City, N. J., in October, 1907, representatives of the interstate commerce commission were in attendance and participated in the discussion of each item of our classification, and a tentative classification was agreed upon, which was believed to be applicable to all city street railways and the passenger and freight departments of all interurban railways, and which it was confidently thought would be adopted by the interstate commission.

On February 26, 1908, we were treated to a surprise in a new tentative classification from the interstate commission, which raised the number of main accounts from the original 59 to 116, together with subaccounts and sundry clearing and adjusting accounts. This classification differs materially from what has been considered the standard, thus making comparative reports difficult, if not of doubtful value. As this new classification was doubtless intended to cover the accounts of steam railroads, as well as of city and interurban railways, express companies, etc., it follows that only such of the items as are applicable to each enterprise can be used.

The commission also makes a division between large and small companies, fixing gross receipts for the small roads at \$50,000.

The subject of "depreciation" is also under discussion—a subject of such importance that no reference is made to it in the tentative classification, although in the circular dated January 10, 1908, considerable attention is given to the matter. In this circular, Accounting Series No. 20, the commission makes it plain that its system of accounting is to be the only standard. The circular states: "In the first instance, it should be distinctly understood that the interstate commerce commission represents the interest of the states as well as its own interests. \* \* \* There are at the present time 30 states whose laws give to state railway commissions, or other legally constituted bodies, jurisdiction over electric railways, and this circular is issued after correspondence with and approval of the representatives of the state governments." In view of such a statement, what recourse can we have from any decision the commission may officially make regarding the classification of accounts?

The conditions attending the operation of electric railways are so varied that it has been found impossible to make a classification entirely suitable or satisfactory to every road, and in the attempt to arrive at even a fair degree of uniformity in accounting, many concessions were made, which resulted in our present classification.

The same conditions do not obtain among interurban railways: some do a purely passenger business; others add a package express; others carry large quantities of local freight; and very few, except the Inter-Urban Railway of Des Moines, enter into interline passenger and freight connections with steam railroads, which necessitate largely increased expenditures in all departments. This road is therefore obliged to conform to the established rules, methods and blanks of the steam roads, and must conduct the accounting department exactly as they do, inasmuch as we are doing the same kind of business. We sell passenger tickets to all parts of the country and ship carloads of merchandise or live stock to any point, making joint rates with connecting lines. We use their cars and they use ours, therefore items of "demurrage," "car service," "tariffs," "absorption of charges," and a multitude of other terms and accounts are added to the ordinary interurban system. While these are familiar to steam road accountants, let no one imagine that to the usual city or interurban accounting force it is an easy matter to absorb this sort of education.

In following the instructions of the interstate and state

\*Abstract of paper read before the Iowa Street and Interurban Railway Association at Des Moines, Ia., April 24, 1908.

commissions the accounting department must rely largely on the superintendents and foremen for accurate reports of the labor and material used under their supervision. It therefore follows that men of experience, good judgment and fair education must be employed for such positions, with salaries to correspond.

The text allotted the writer is one which may be productive of extended discussion. Some will believe that the proposed change in accounting methods will be sure to cause confusion and increased expenditures without corresponding benefit; others will consider that the impossibility of comparative statements with former years is a vital defect.

It appears to the writer that objections made by any road or association of roads will be overruled by the commission, and that we shall be compelled to follow its ideas and system of accounting.

## CENTRAL ELECTRIC ACCOUNTING CONFERENCE MEETING.

A special meeting of the Central Electric Accounting Conference, called to discuss the tentative interstate commerce commission classification of accounts, was called to order by the chairman, M. W. Glover, auditor Ohio Electric Railway, at the Lima House, Lima, O., on Thursday of this week at 12:45 p. m. Mr. Glover asked F. D. Carpenter, president of the Central Electric Railway Association, to act as chairman of the meeting. The object of the meeting was then explained by Mr. Glover, who discussed the importance of uniform and prompt action by the electric railways of Ohio and other states in the Central Electric territory in relation to Accounting Series Circular No. 20 of the interstate commission.

W. H. Forse, Jr., treasurer Indiana Union Traction Company, spoke of a meeting of representatives of Indiana companies at which replies to the circular of the commission were considered. The question had arisen whether the commission, in its request for data, desired information concerning the operating or the underlying companies, but it was decided that the intent was to secure facts relating to the operating companies. It was believed by the representatives of these companies that gross earnings of \$500,000 should be the limit of demarkation between a large and a small company. It was decided that the inquiry as to the present surplus or deficit meant the figures of the operating company, starting from the date of commencement of operation. It was thought that the entire surplus was meant, without relation to whether it resulted from railway or other operations, such as gas or electric lighting, but that in case the company operated more than one class of public utility it would be well to state that some part of the result was derived from operations other than railway.

Mr. Forse stated that he had made an effort to divide the 1907 operating expenses of the company with which he is connected into the 116 primary accounts provided in the classification of the interstate commission but that out of the total number of accounts he was able to use only 72. Of the total amount distributed between the 72 accounts, 89.2 per cent was charged to 26 accounts, 5.5 per cent to 9 accounts and 5.3 per cent to 37 accounts. Stating the result in another way, 94.7 per cent of the total was confined to 35 accounts. Charges to some accounts were as small as one ten-thousandth of 1 per cent. Explaining further the importance of the interstate circular, Mr. Glover said:

Statement by M. W. Glover.

Circular No. 20 states that it should be distinctly understood that the interstate commerce commission represents the interests of the states as well as its own interests in the effort to develop a uniform system of accounts for electric lines, and goes on to say that, at the present time, 30 states give jurisdiction over electric railways to their state railway commissions and intimates that the classification adopted by the interstate commission for electric railways will be adopted by the state commissions throughout the country. While a number of electric railways in this territory may not now be subject to the supervision of the interstate commission, if the

classification under discussion is adopted by the state railroad commissions of the central states, every line will become vitally interested in and will be required to use the classification.

The American Street and Interurban Railway Association, recognizing the importance of a full discussion of Circular No. 20, has issued several circulars urging electric railways to comply with the request of the commission to consider carefully the tentative classification submitted, making criticisms and suggestions which in their opinion might bring the classification into a more satisfactory form. It is, therefore, appropriate for the electric railways of the central states to criticize the proposed classification in the hope that by united action of the lines in this territory, which are more fully developed than the lines in any other portion of the United States, we may succeed in obtaining certain modifications which are most desirable, if not absolutely necessary, to secure a classification which can be used and which will be of service to the interstate commission, the state railway commissions and the owners of the properties.

With reference to the claim of certain lines lying wholly within a single state, concerning the jurisdiction of the interstate commission, I quote as follows from a communication of James S. Harlan, commissioner of the interstate commission:

"Regardless of the physical location of either electric or steam railroads and whether their lines begin and end in the same state or not, if either is engaged in the transportation of property from a point in one state to a point in another, wholly by rail or in connection with a water carrier under some arrangement for a continuous movement, the act (interstate commerce act) applies in all its phases."

Therefore, whether or not this classification is adopted by the various state commissions, a large number of electric railways will be subject to the supervision of the interstate commission and we should endeavor to have this supervision exercised in such a manner as to produce the best results for the owners of our properties, as well as for the interstate commission.

The Electric Railway Review of April 11 contains a communication from the Michigan railroad commission, declining to adopt the proposed classification, and the Electric Railway Review of April 18 contains a communication from the New Hampshire railroad commission stating that the assistance of the interstate commission is not needed in handling the accounts of electric railways in New Hampshire. Both of these commissions previously intimated to the interstate commission, in reply to a communication on the subject dated November 13, 1907, that they would co-operate with the interstate commission; the New Hampshire commission then stated that it would adopt the system of accounts used by adjoining states and the interstate commission; but evidently after examining the proposed classification both of these commissions have realized that the classification is entirely unsuited to the needs of electric railways and are not willing to adopt it in its present form. It therefore appears that if the proper objections are presented to the interstate commission it will be willing to modify the classification and it may be possible for us to obtain a classification which will be satisfactory to all electric railway lines.

In connection with the task undertaken by the interstate commission to supervise the accounts of railway properties, both steam and electric, Prof. H. C. Adams, discussing certain principles in formulating the system of accounts and indicating the results which are to be obtained and which are expected to show in sufficient detail the actual financial standing of the properties and furnish a true statement of their value, says:

"Such a general statement will show the significance and importance of this part of the accounting scheme, and will, I am sure, emphasize \* \* \* that control over accounting does in fact permit the government to exercise a certain degree of supervision over the management of railway property. Of course the accounts themselves would be of little use were it not for the fact that the law also provides for examiners whose duty it shall be to examine the accounts of the carriers and determine whether or not the prescribed rules of accounting are followed."

From this you will understand that the accounts of electric railways will be examined from time to time by representatives of the interstate commission and every requirement of the commission will have to be carried out regardless of the expense involved.

No criticism can be made of the general principles laid down by the interstate commission regarding the desirability of a uniform system of accounts for electric railway lines. The fact that the electric lines of the country have no classification of operating expenses now in use by all lines shows the desirability of obtaining such a classification as will meet the requirements of lines both large and small. While the

classification proposed by the American Street and Interurban Railway Accountants' Association has been adopted in part by a number of lines, my experience has proved that this classification is not adapted entirely to the needs of interurban lines and certain modifications have been made in the past to enable interurban lines to use, so far as possible, the classification proposed by the association and to bring into the classification certain other items which were not contained in it originally. The revised classification adopted by the Atlantic City convention in October, 1907, is more satisfactory than the original classification which has been in use since 1903 and, while there are certain objections to the classification adopted at Atlantic City, it must be admitted that it is far better and more satisfactory to the majority of electric railway lines than the classification proposed by the interstate commission; in fact, there are certain features of the proposed classification covered by Circular No. 20 which, in my opinion, are impossible to carry out, and I feel satisfied that the commission will listen to any criticisms of the classification which may be presented and will be found willing to meet the views of electric railway lines whenever possible to do so.

It is hoped that all present realize the importance of this matter and that some action will be taken by the lines represented to present objections to the interstate commission which will result in a simpler and more satisfactory classification of accounts than that proposed by Circular No. 20.

#### GRAND JURY REPORT AND STATEMENT OF THOMAS F. RYAN ON METROPOLITAN FINANCING.

The special grand jury at New York which has been engaged since January 6 in investigating the affairs of the Metropolitan Street Railway Company in relation to charges brought against the financiers who have been connected with the company by William M. Ivins, William N. Amory, William F. King and others, on April 20 submitted to Justice Dowling of the criminal branch of the supreme court a presentment in which it declared that it had not been able to find, in its investigation of the New York traction situation, evidence showing a commission of crime on which it could act. The jury also filed, as a part of the public record, the complete minutes of its investigation, containing the testimony of Thomas F. Ryan, H. H. Vreeland, Anthony N. Brady and others. The grand jury investigated each charge separately and the verdict on each was that it was unfounded or outlawed or that there was no evidence of criminality, although several cases of contributions for political purposes were declared worthy of condemnation. The minutes, which amount to over 1,000 pages, give a very complete review of the financial history of the Metropolitan company.

Coinciding with the grand jury's presentment Thomas F. Ryan made public a statement which he had previously presented to the grand jury when he appeared before it to testify as to his connection with New York traction matters. In this statement Mr. Ryan reviews the process of evolution of the Metropolitan system from 1855, when the Metropolitan Traction Company of New Jersey was formed, down to the years 1897, 1898 and 1899, when the Metropolitan Traction Company was dissolved and succeeded by the Metropolitan Street Railway. Mr. Ryan defends every step taken by the organizers, declaring that every purchase of subsidiary lines was legitimate, that there was no watered stock, that none of the so-called "insiders" ever had a dollar's interest in any of the system's contracts, and that all the stories of "millions in profits to insiders" are absolutely false, because such profits never existed.

In conclusion he says: "The failure of the surface lines was not due to any of the causes alleged, but to conditions which were mainly the results of state interference. Among these are:

"1. The extension of the free transfer obligation by legislative enactment and court decisions, so that the fare per passenger has been reduced from five cents to only a little more than three cents.

"2. Enormous increases in taxes, the special franchise tax alone having almost doubled the system's burden of taxation.

"3. The extraordinary congestion of street traffic, resulting in greatly increased cost of operation and maintenance, and also in an abnormal burden of accident claims, this item alone amounting to \$2,000,000 a year, or about 10 per cent of the gross receipts.

"4. The competition of subway lines, built with the aid of the city's credit.

"These causes have reduced the net earnings of the system fully \$6,000,000 a year, or more than 10 per cent upon the company's capital stock. The company was not 'looted'; it was throttled."

# News of the Week

## Strike in Chester, Pa.

The strike of the motormen and conductors of the Chester (Pa.) Traction Company, which was declared on April 13, because the company reduced the wage scale from 18½ to 16½ cents an hour, has developed into a very serious situation. The city has been under martial law since last Thursday, and, although several companies of the state militia have been stationed in the city, scenes of violence have been numerous and several persons have been shot. The first car was operated since the strike was declared on Wednesday of last week and since Sunday cars have been operated on all the lines during the daytime. There has been little traffic, however, because of the frequent disturbances and because of a boycott which has been declared against the company. Several unsuccessful attempts have been made to secure arbitration, but President Rigg has stated that the company's earnings have fallen off so much that it was forced to reduce wages and that he has no intention of yielding to the strikers. A large number of strikebreakers have been imported from New York to operate the cars and some of the strikers returned to work on Tuesday of this week, when an attempt was made to run cars on a regular schedule.

The city police have rendered little assistance to the company and the city council has favored the strikers. On Monday the council passed resolutions censuring the company and ordering it to make certain improvements at once.

## Report on Chicago Elevated Loop.

George Weston, who was recently engaged by the Chicago city council's committee on local transportation to investigate the subject of increasing the capacity of the union elevated loop, submitted a report on Thursday of this week. After a thorough investigation Mr. Weston makes the following recommendations: Through routing of the cars of the South Side Elevated Railroad and the Northwestern Elevated Railroad, extension of station platforms so that two 6-car trains can load and unload at the same time; universal transfers, with five transfer stations on the loop; and development of stub terminals. In connection with the through routing plan Mr. Weston recommends an alternating system by which half of the north and south trains would use the east side of the loop and the other half the west side of the loop. To offset the opposition which has been made by property owners on the loop streets to the proposed extension of station platforms Mr. Weston suggests that by the use of prismatic glass in the floors of the station platforms light may be deflected into the store windows.

By adopting these changes Mr. Weston says that the capacity of the loop may be increased 43 per cent, or from 680 cars an hour to 1,068, with 55,536 seats in place of 35,360 as at present. He points out, however, that the remedies suggested are but a temporary arrangement, which the constantly increasing traffic will ultimately render inadequate, and that "a complete and comprehensive plan must be devised to ultimately provide in a full and satisfactory manner for the traffic through the congested business district, and which shall tend to stretch out and enlarge this district."

## Employment of Trainmen in Baltimore.

Bulletin No. 8 in the series of newspaper advertisements published by the United Railways & Electric Company of Baltimore discusses the system of employment of motormen and conductors, and says in part:

"The company conducts a regular school for prospective motormen at the Pennsylvania avenue car house. They are kept at school until able to pass the required examination. Failure to pass this examination within a reasonable time results in rejection.

"Those who are successful are assigned to a particular line and placed in charge of an experienced motorman, who instructs the student on the car and gradually turns over the operation of it to him. While this training is in progress the superintendent of motormen frequently rides upon the cars, in many instances without knowledge of the students, and it is not until he, too, is satisfied that a certificate of competency is issued. The training, however, is not yet complete, as the students must go before the superintendent of transportation and receive final instructions, in addition to those contained in the book of rules.

"One of the most important requirements from the street railway point of view is that all employes shall be courteous to passengers and patient at all times. At times it becomes necessary to dismiss men. While men may otherwise be

competent, their manner may be discourteous to passengers, or they may not possess the requisite patience. Discourtesy, laziness, complaints of passengers, lack of interest and the many things which render men incompetent in other lines, make them undesirable for employment by the railway.

"After employment we endeavor to hold the best men in the company's service. Wages are adjusted according to term of service, and honor stripes are placed upon the sleeves of the men—a silver stripe for service of not less than three years and a gold stripe for every five years' service."

## Legislation Affecting Electric Railways.

**District of Columbia.**—The street railway bill, which provides for an extension of the Washington street railway lines to the new union station, was considered in the house on April 20 and was returned to the senate for further conference, after the house had insisted on its amendments providing for universal transfers and supervision of the street railway companies by the district commissioners. The senate conference committee proposed some changes in the route and has held out for a provision for a charge of two cents for transfers, with no amendment providing for supervision.

**New York.**—The senate on April 22 passed by a vote of 26 to 9 the 5-cent fare bill, which provides that no street railway company shall charge more than five cents fare for a continuous ride over lines leased or owned by it without first securing the consent of the public service commission. The bill is intended to prevent the Brooklyn Rapid Transit Company from charging a 10-cent fare from New York to Coney Island.—On April 21 the assembly passed the bill introduced by B. R. Robinson, which has had the support of the public service commission, amending the Elsberg rapid transit law so as to permit the construction of subways in New York City by private capital. The bill provides that franchises may be granted to private corporations for the construction and operation of new routes or extensions for a prescribed period not to exceed 50 years, at the expiration of which time the city may purchase the property at the cost of construction and resell it to another company. The bill also increases the term for which a municipally constructed road may be leased from 20 years, with a renewal of 20 years, to 35 years, with a renewal of 20 years.—The senate has concurred in the changes made by the assembly in the constitutional amendment exempting from consideration in the debt limit of New York City bonds for the construction of rapid transit lines or docks which will be self-supporting.

**Ohio.**—The McCord bill, now pending before the legislature, gives interurban roads the same right of condemnation of property for right of way as is now possessed by steam railroads.

## Near Settlement of Cleveland Controversy.

On Tuesday of this week F. H. Goff, representing the Cleveland Electric Railway Company, offered to lease the property to the Municipal Traction Company at a valuation equal to \$55 a share on the company's 234,000 shares of outstanding stock, after deducting indebtedness, with a security franchise providing for six tickets for 25 cents. Mr. Goff had originally asked for \$72 a share and later offered to settle for \$60 a share. Mayor Johnson, who has steadfastly refused to offer more than \$50 a share, expressed himself as satisfied with the offer of \$55 and urged the city council to accept it. It was finally decided to give the people an opportunity to be heard on the subject before final acceptance and arrangements were made for mass meetings to be held in every ward of the city until Saturday night. If the people express their approval, as it is believed they will, it is planned to have the agreement ratified by the council on Monday night and the security franchise passed, with a provision for six tickets for 25 cents.

In case a settlement is reached on Monday it is planned to make the lease operative at once and operate the line at a 3-cent fare, although President du Pont of the Municipal Traction Company has announced that a small charge will probably be made for transfers for a short time as an experiment. The Municipal Traction Company also is planning to make extensive improvements to the system. The lease provides that \$1,500,000 of capital stock of the Cleveland Railway Company may be issued from time to time at the request of the traction company for track extensions, betterments and improvements; \$1,350,000 for purchasing new rolling stock; \$2,150,000 for new power houses and car shops; and \$1,500,000 for the construction of a high-level bridge across the Cuyahoga river.

For several days previous to Mr. Goff's final offer of \$55 preparations had been made on both sides for a renewal of the competition between the Cleveland Electric Railway and the Forest City Railway. On Thursday, April 16, the city

council passed, under suspension of rules, an ordinance granting 15-year franchises to the Forest City Railway covering many of the Cleveland Electric lines whose grants the city claims have expired, including the important Woodland avenue and other west side lines. Like the other Forest City grants the ordinance provides for a 3-cent fare. The ordinance was passed under the provisions of the new Schmidt law, which gives councils the right to grant franchises without the consent of property owners two years prior to the expiration of an old grant or within one year after such expiration. Consequently, even if the Cleveland Electric Railway's claim that the franchises do not expire until 1910 is upheld, the franchises would be secured to the Forest City company. The ordinance does not become effective until April 27. If a settlement is reached by that time the franchises will be granted to the Cleveland Electric Railway under the security grant. Otherwise the Municipal Traction Company planned to purchase the Cleveland Electric's property in the streets.

At the same meeting the council granted a franchise to the Neutral Street Railway for the Central avenue and Quincy street lines.

The ordinances were passed in great haste, as the city officials were afraid that the legislature might take some further action that would nullify the effects of the Schmidt law. As soon as word was received that the governor had signed the bill the mayor called the council meeting and the ordinances were rushed to print. The Cleveland Electric attorneys have announced their intention of attacking the constitutionality of the law.

On Saturday, April 18, the stockholders of the Forest City Railway Company voted to increase the capital stock from \$2,000,000 to \$6,000,000. The sale and issue of the new stock is to be subject to action by the Municipal Traction Company and none is to be sold below par. It was stated that although a successful termination of the peace negotiations was expected the company desired to be prepared for any contingency and that the increase of stock was to provide for building new lines and equipment for the streets covered by the new franchises or for acquiring the property of the Cleveland Electric Railway in those streets.

**Central Electric Railway Association Meeting.**—The next meeting of the Central Electric Railway Association will be held at Toledo, O., on May 21.

**Missouri Electric Light Gas and Street Railway Association.**—The annual convention of the Missouri Electric Light Gas and Street Railway Association was called to order on Thursday morning of this week at the Marquette hotel, St. Louis, Mo.

**Indiana Electric Railways Ask Tax Reductions.**—Representatives of Indiana electric railway companies appeared before the Indiana state board of tax commissioners on April 21 and 22 to present arguments in regard to their assessments for the coming year. Nearly all asked for reductions on the ground that earnings had greatly decreased or that large expenditures had been made for extensions and improvements which had as yet rendered no return on the investment.

**Suit for Violation of Public Service Commission's Order.**—The New York public service commission of the first district has instructed its counsel to bring suit against the Brooklyn Elevated Railroad to recover the penalty of \$50 a day for failure to obey an order of the commission to install a wrecking car at the Brooklyn terminal of the Brooklyn bridge, so that time might be saved in making repairs to cars which might obstruct traffic on the bridge. The order was issued after a hearing on February 13 and was made effective on March 1.

**American Society of Mechanical Engineers.**—The semi-annual meeting of the American Society of Mechanical Engineers will be held in Detroit, Mich., on June 23 to 26 inclusive. Among the papers to be presented at this session are "A Method of Cleaning Gas Conduits," by W. D. Mount; "A Method of Checking Conical Pistons for Stress," by Prof. George H. Shepard; "Clutches," with special reference to automobile clutches, by H. Souther; "Horsepower, Friction Losses and Efficiencies of Gas and Oil Engines," by Prof. L. S. Marks; "Some Pitot Tube Studies," by Prof. W. D. Gregory; "The Thermal Properties of Superheated Steam," by Prof. R. C. H. Heck; "A Journal Friction Measuring Machine," by Henry Hess; "A By-Product Coke Oven," by W. H. Blauvelt; "Tests of Some High-Speed Steam Engines," by F. W. Dean. There will be a symposium upon machinery for conveying materials, with papers by several authorities. The Society for the Promotion of Engineering Education and the Society of Automobile Engineers will also hold their annual meeting in Detroit at this time, which will enable members of each society to participate in the sessions of the others.

# Traffic and Transportation

## Coney Island Fare Case.

A hearing regarding the 10-cent fare charged to Coney Island by the Coney Island & Brooklyn Railroad took place on April 10 before Commissioner Bassett of the New York public service commission, first district. John A. Thake, assistant secretary and treasurer of the company, showed that where the average amount of second fares a year for the last five years was \$97,000, it had been falling off steadily, and last year was only \$88,000. To wipe out this revenue would cause a large deficit, he declared.

Frank R. Ford testified that there would be an annual deficit now if the proper amount was laid aside each year as a reserve fund for renewals. Taking into consideration the distance from Park Row to Coney Island the receipts per passenger per mile at 10 cents fare were only 0.89 cent, which is below the average receipts throughout the country.

## Orders for More Seats in Non-Rush Hours in New York.

The New York public service commission, first district, has passed orders which are designed to require the receivers of the New York City Railway to provide a seat for every passenger, except in the rush hours, on the Twenty-third street crosstown line, the Lexington avenue lines and the Grand street line. The orders are to go into effect on April 27. In an opinion which accompanied one of the orders Commissioner M. R. Mattheis said: "The purpose of this order is to give every one a seat, and a 10 per cent excess of seats over passengers has been required because of the irregularity of traffic and of cars. Whether a 10 per cent excess is sufficient to accomplish this result cannot be determined without experimenting, and it is possible that after a trial has been had it will be necessary to either increase or decrease the percentage of excess suggested.

"The alternative proposition suggested, namely, that if a 10 per cent excess of seats over passengers is not provided a certain number of cars must be run, has been placed in the order because it is physically impossible, under the conditions which obtain in New York, to always provide a seat for every passenger. The traffic is so heavy at times that to attempt to provide every one with a seat would so interfere with the carrying capacity of the line that the time consumed in passing from one point to another would be so great, because of the low rate of speed due to great congestion, that the advantage of a seat would probably be more than offset by the increased time required."

**Increase in Rates.**—The Long Island Railroad has increased single-fare rates from Long Island City and Manhattan Beach from 23 to 30 cents and round-trip tickets from 40 to 50 cents.

**Transfer Law Violated in Birmingham, Ala.**—Officials of the Birmingham (Ala.) Railway Light & Power Company have complained to Sheriff Higdon regarding many violations of the transfer law.

**Abandonment of Transfers in New York.**—Under orders from the New York public service commission, first district, inspectors are engaged in studying the curtailment of transfers between the Third Avenue Railroad and the Metropolitan Street Railway Company, New York. The commission intends to investigate the subject from a legal and a practical standpoint, and the inspectors have been instructed to find out how many persons are affected and how the operation of the roads is affected. A map made by the commission shows that 57 transfer points heretofore in use have been maintained, while 48 have been abandoned.

**Use of Steam Cars by Michigan United Railways.**—The Michigan railroad commission is considering whether the Pere Marquette Railroad can be compelled to switch cars to the tracks of the Michigan United Railways so that the cars can be transported to De Witt, Mich. At present the freight from the Pere Marquette road is transferred to the cars of the Michigan United Railways and is distributed to various stations by the electric road. The agent of the Pere Marquette road states that his company is willing to switch cars to the Michigan United Railways if the latter will pay rental for the cars while they are being unloaded. The matter will be considered on June 24. Similar cases are pending between the Detroit United Railways and the Grand Trunk Railway at Flint and between the Michigan Central Railroad and the Detroit United road at Oxford. The latter cases will be decided on April 28.

# Construction News

## FRANCHISES.

**Chattanooga, Tenn.**—The Chattanooga Railways Company has secured a franchise to build a line in Rossville avenue. D. J. Duncan, general manager.

**Chesaning, Mich.**—The Saginaw Owosso & Lansing Railway Company of Detroit, which proposes to build an electric line from Saginaw to Lansing, Mich., has been granted a franchise in Chesaning. (Noted April 18.)

**Lincoln, Neb.**—A franchise has been granted to the Citizens' Railway Company, Lincoln, Neb., to extend its line to University place and Havelock, Neb., with a possible extension later to Ashland.

**Los Angeles, Cal.**—A franchise granting the Los Angeles Railway Company permission to operate its line in South Park avenue was passed by the council over the mayor's veto on April 13. The franchise is for 21 years and replaces a former franchise which was declared illegal. The company pays the city \$500 compensation.

**San Francisco, Cal.**—The United Railroads of San Francisco and the Sutter Street Railway companies have been granted a 52-day extension to their temporary permit to operate cars by overhead trolley on the outer tracks of lower Market street.—The Presidio & Ferries Railroad Company has been granted a temporary permit to operate overhead trolley service on seven blocks of Larkin, Vallejo and Franklin streets, pending the advertisement and award of a franchise over this route expiring on December 10, 1913. The purpose of the franchise is to enable the company to avoid the steep Union street hill between Franklin and Larkin streets.

**Terre Haute, Ind.**—J. W. Shanks, representing the Grand Central Traction Company, which proposes to build an electric line from Indianapolis to Evansville with a branch from Bloomington to Terre Haute, has applied to the board of public works for permission to enter Terre Haute. The company owns a private right of way and the franchise is for the privilege of crossing the streets from the southern city limits to Main street. It is stated that work will be started as soon as the franchise is granted.

## RECENT INCORPORATIONS.

**Alton St. Louis & Cairo Railroad, East St. Louis, Ill.**—Incorporated in Illinois to build an electric railway from Alton through Madison and St. Clair counties to East St. Louis, Ill., and from East St. Louis to Cairo through St. Clair, Monroe, Randolph, Jackson, Union and Alexander counties, with a branch to Columbia, Waterloo and Mammoth Cave in Monroe county. Capital stock, \$100,000. Incorporators: B. L. Renrow, Dr. C. H. Walters, William L. Ensol, George M. Switzer and C. B. Meredith, all of Springfield, Ill. Col. Thomas N. Chase of St. Louis, Mo., is promoting the road. It is stated that right of way from Alton to Cairo has been secured.

**Pittsburg (Pa.) Underground Railway.**—Representatives of the Pittsburg Subway Company, of which F. T. P. Lovejoy is president, have applied for an exclusive charter for a complete subway system in Pittsburg. The company failed to secure a franchise from the city council before April 11, when the exclusive rights under its former charter expired.

**Terre Haute Robinson Olney & Southwestern Railway, Robinson, Ill.**—Incorporated in Illinois to build an electric railway from a point on the Wabash river on the boundary line between Illinois and Indiana in a southwesterly direction through the counties of Crawford, Richland, Wayne and Jefferson, in Illinois, to Mt. Vernon. Capital stock, \$10,000. Incorporators: Horace C. Pugh, H. P. Taussig, Norman H. Moss, W. H. Cisne, S. C. Wilson, George E. Parker and F. W. Lewis.

## TRACK AND ROADWAY.

**Asheville & Hendersonville Railroad, Asheville, N. C.**—Surveys have been completed from Asheville to Hendersonville, N. C., 22 miles, on the line from Asheville to Greenville. Surveying was started last week between Hendersonville and Greenville and it is planned to begin construction this summer. The Carolina Construction Company of Asheville, of which J. S. Rowland is president, has the contract. (Noted March 21.)

**Auburn & Northern Electric Railroad, Auburn, N. Y.**—R. A. Dyer, Jr., assistant general manager, is reported to have announced that the line from Auburn to Port Byron, N. Y., will be opened for traffic by July 1. T. H. Mather of Syracuse is chief engineer. (Noted December 28, 1907.)

**Auburn & Turner Railroad, Turner, Me.**—H. B. Potter, general manager, writes that construction is to begin about May 1 on an extension from Turner Village to Turner Center, 2 miles. Contracts are to be let for 60-pound T-rails, cedar ties, trolley wire, bonds, etc.

**Bloomington Pontiac & Joliet Electric Railway, Pontiac, Ill.**—President H. A. Fisher has announced that grading on the extension from Pontiac south to Chenoa, Ill., 10 miles, will be started in a few days provided the \$25,000 bond subscription asked of the residents of the territory to be benefited is secured. It is reported that most of the amount has already been subscribed. (Noted February 29.)

**Buffalo & Lake Erie Traction Company, Buffalo, N. Y.**—We are advised that bids are being received by J. C. Calisch, general manager, for a reinforced concrete viaduct to be erected at Westfield, N. Y. Plans were previously prepared by Boler & Hodge, consulting engineers, 1 Nassau street, New York City, for a structural steel viaduct, but it was later decided to receive bids on a reinforced structure also for cost comparison. The viaduct is to be 800 feet long, having a height of approximately 30 feet. Alternate bids for concrete arches and piers with center span of structural steel are also being received.

**Chicago Kankakee & Champaign Electric Railway, Kankakee, Ill.**—F. B. Vennum writes that this line has been surveyed from Kankakee to Champaign, Ill., and that grading will begin as soon as the bonds are placed. The officers are: President, I. F. Palmer, Onarga, Ill.; vice-president, Upton Schaub; chief engineer, Robert W. Renton, Kankakee, Ill. (Noted March 21.)

**Chicago Ottumwa & Western Railway, Hamilton, Ia.**—A. A. McGarry, president, writes that this company, recently incorporated, proposes to begin construction at an early date on its proposed line from Hamilton to Dallas, Ia., 24 miles, via Marysville. The overhead trolley system will be used. Surveys have been made. John A. Nelson, chief engineer. (Noted April 4.)

**Chicago Railways Company.**—Work has been started on the reconstruction of the tracks on Blue Island avenue from Halsted to Fourteenth street with 129-pound grooved rails.

**Columbus Delaware & Marion Railway, Columbus, O.**—It is announced that the extension from Marion to Bucyrus, O., will be completed in about 60 days.

**Conestoga Traction Company, Lancaster Pa.**—C. Edgar Titzel, general manager, writes that the report that this company was contemplating an extension from Marietta to Maytown, Pa., is erroneous, and that the company has no such intention. (Noted April 11.)

**Diamond State Rapid Transit Company, Smyrna, Del.**—J. W. Endean, chief engineer, writes that it is proposed to begin grading in about 30 days on the line from Delaware City to Rehoboth, Del., via St. Georges, Odessa, Smyrna, Dover, Camden, Magnolia, Frederica, Milford, Milton and Lewes, 96 miles. It is proposed to carry both passengers and freight. Maximum grade, 3 per cent; maximum curvature, 3 degrees. No rock excavation will be required. Contracts are to be let in about 45 days for the entire construction. The power house will be located at St. Georges. The equipment will include turbo-generator units to deliver three-phase current. Contracts are to be let for 72-pound rails, double-truck 4-motor cars seating 40 passengers and two Scherzer rolling lift bridges of 65-foot span. M. V. Ford is president. (Noted April 11.)

**Fairmont & Clarksburg Traction Company, Fairmont, W. Va.**—S. B. Miller, chief engineer, writes that surveys are being made for an extension from Grassell to Bridgeport, two miles. Nothing definite has been decided yet as to the construction. (Noted April 18.)

**Grand Central Traction Company, Indianapolis, Ind.**—This company, which proposes to build an electric railway from Indianapolis to Evansville, Ind., with a branch from Bloomington to Terre Haute, has filed with the county recorder at Bloomington a mortgage for \$8,000,000 in favor of the Chicago Title & Trust Company. W. D. Whitney of Muncie, Ind., is president. (Noted February 15.)

**Illinois Central Electric Railway, Canton, Ill.**—It is stated that the electrification of the line from Canton to St. David, Ill., six miles, heretofore operated with two gasoline motor cars, will be completed by May 1. The overhead construction, the material for which was furnished by the Ohio Brass Company, has been practically completed. G. W. Chandler, general manager.

**Indianapolis Cloverdale & Terre Haute Traction Company, Indianapolis, Ind.**—E. M. Bowman, president, writes that this

company, recently incorporated, proposes to begin construction about August 1 on its proposed line from Indianapolis to Terre Haute, Ind., via Mooresville, Eminence, Cloverdale, Polen, Asheville and Brazil. The right of way has been secured between Mooresville and Cloverdale. H. E. Sandusky is chief engineer. (Noted April 18.)

**Jersey Central Traction Company, Keyport, N. J.**—George I. Brown, vice-president, writes that this company proposes to build an extension from South Amboy to Perth Amboy, N. J., four miles, including a large amount of trestle work. A contract is to be let for pile driving for the trestle work. G. E. Desler, chief engineer. (Noted April 18.)

**Joplin & Pittsburg Railway, Joplin, Mo.**—A. L. Register & Co. of Philadelphia expect to award contracts within the next week for the laying of 25 miles of 70-pound rail between Joplin, Mo., and Pittsburg, Kan., also for the complete construction of the catenary and overhead lines between those points. Bids for this work will be received at the Joplin office of A. L. Register & Co., in the Miners Bank building. (Noted April 18.)

**Kansas City & Olathe Electric Railway, Kansas City, Mo.**—This company is now working on an extension from Merriam to Shawnee, Kan., two miles, which it expects to have in operation by May 1. An amusement park is to be located between Merriam and Shawnee. A line from Rosedale to Merriam, three miles, is now in operation. F. P. Dickson, president. (Noted October 26, 1907.)

**Milwaukee Northern Railway, Cedarburg, Wis.**—Construction has been started on an extension from Sixth street and Green Bay avenue, in Milwaukee, to Lindwurm park, on the Port Washington road. Ernest Gonzenbach, general manager.

**Northwestern Pacific Railway, San Francisco, Cal.**—This company's third-rail electric system has been extended from San Anselmo to Fairfax, Cal.

**Pendleton, Ore.**—Dr. Henry W. Coe of Portland, Ore., is said to be interested in a project to build an electric railway from Pendleton to Irrigon, Ore., via Echo, Foster, Hermiston and Umatilla, about 52 miles.

**Shrewsbury, Pa.**—J. H. Keller, secretary of a company that proposes to build an electric railway from York to Shrewsbury, Pa., 14 miles, writes that negotiations are now being made for securing a charter and right of way. Surveys have been made. D. B. Goodling of Logansville, Pa., is president and J. L. Meyers of Glen Rock, Pa., is treasurer. (Noted April 11.)

**Springfield Clear Lake & Rochester Electric Railway, Springfield, Ill.**—It is stated that this line from Springfield to Rochester and Hillsboro, Ill., is now being rapidly completed and it is expected that it will be in operation by May 1. J. E. Melick, president.

**Stroudsburg & Water Gap Street Railway, Stroudsburg, Pa.**—Henry Sweeny, vice-president, writes that a bridge over Pocono creek from Stroudsburg to South Stroudsburg on the line from Stroudsburg to Delaware Water Gap is now under construction and will be completed by May 15. Fine & Harris of Philadelphia are the contractors. (Note April 18.)

**Texas Traction Company, Dallas, Tex.**—This company, which expects to begin operating its line between Dallas and Sherman, Tex., by July 1, has laid its track into Dallas. (Noted April 18.)

**Washington (D. C.) Railway & Electric Company.**—This company proposes to build an extension comprising about 3,100 feet of single track. (Noted March 28.)

#### POWER HOUSES AND SUBSTATIONS.

**Municipal Traction Company, Cleveland, O.**—A. B. du Pont, president, has announced that the company has purchased two new engines and generators to furnish current for its railway lines. The engines will be built by the Allis-Chalmers Company and the generators by the General Electric Company.

**New Jersey & Pennsylvania Traction Company, Trenton, N. J.**—This company has contracted with the Allis-Chalmers Company for a heavy duty cross compound engine with cylinders 24 and 48 by 42 inches, to drive an 800-kilowatt alternating-current generator. The order also includes a 35-kilowatt induction motor-driven exciting unit, which will be installed with the alternator in the power station at Yardley, Bucks county, Pennsylvania. (Noted February 8.)

**United Railways Company of St. Louis.**—In the president's annual report to this company it is stated that three 800-kilowatt generators, heretofore operated in the Cass avenue power station, will be reconstructed and later installed in the North Broadway and the De Hodiament power stations.

## Personal Mention

Mr. C. M. Crawford, heretofore chief engineer of the Cincinnati Northern Traction Company at Hamilton, O., has resigned.

Mr. A. C. Ogelby, chief engineer of the Grand Rapids (Mich.) Railway, has resigned to take a position with an electric railway system in the south.

Mr. R. W. Brown, heretofore superintendent of the Toledo & Western Railroad at Adrian, Mich., has resigned to accept a position in the train dispatching department of the Detroit United Railway.

Mr. Hugh McCloskey of New Orleans, La., heretofore chairman of the board of directors, was elected president of the New Orleans Railway & Light Company at a meeting of the directors held last week, succeeding Mr. E. C. Foster, who was elected first vice-president.

Mr. J. B. Lukes, whose appointment as district superintendent of power for the Stone & Webster properties in the Puget Sound district was announced in the Electric Railway



J. B. Lukes.

Review of April 11, was born in Racine, Wis. He graduated from the electrical engineering department of the Massachusetts Institute of Technology of Boston, Mass., in 1892, and was first employed in the inspection and later in the contract department of the Chicago Edison Company. While in Chicago he also was employed by the board of directors of the Chicago public library to take charge of the electrical installation in the public library building. After completing this work he accepted a position with the United States Electric Lighting Company of Washington, D. C., where he remained until August,

1900, when he resigned to become superintendent of light and power of the Seattle Electric Company at Seattle, Wash. In March, 1906, he was made general superintendent of the company and on April 1, 1908, received his present appointment as district superintendent of the Stone & Webster properties in the Puget Sound district.

Mr. Joseph E. Wayne, heretofore general superintendent of the York Railways at York, Pa., has resigned, effective on May 1, to become general manager of the Chambersburg Greencastle & Waynesboro Street Railway and the electric light plant operated by the company at Waynesboro, Pa.

Mr. J. Boyle Price, purchasing agent of the United Railways Company of St. Louis, has resigned to become vice-president of the J. O. Chenoweth Dyeing & Cleaning Company of St. Louis. Mr. Price had been connected with the St. Louis system for 14 years. No successor will be appointed.

Mr. George L. Collins has been appointed manager of the Ontario Light & Traction Company, Canandaigua, N. Y., succeeding Mr. R. M. Searle; effective on May 1. Mr. Collins formerly was general manager of the Consolidated Gas & Electric Company of Batavia, N. Y.

Mr. W. B. Atwood has been appointed assistant superintendent of the Ashtabula Rapid Transit Company, Ashtabula, O., with entire charge of the reconstruction work contemplated by the company. Mr. Atwood formerly was with the Keystone Construction Company and more recently with the construction department of the Ohio Electric Railway at Lima, O.

Mr. John B. Olmstead of Buffalo, N. Y., has been appointed a member of the public service commission of New York, second district, succeeding Mr. Charles Hallam Keep, resigned to become president of the Knickerbocker Trust Company of New York City, as announced in a previous issue. Mr. Olmstead was born in Leroy, N. Y., in 1854. He is a graduate of Harvard University and studied for two years



# Financial News

in Heidelberg University. He was admitted to the bar in 1879. He was formerly a member of the civil service commission of Buffalo and later became treasurer of the Buffalo Civil Service Reform Association, which office he now holds. His term of office will expire on February 1, 1912.

Mr. Samuel Anderson has succeeded Mr. Horatio Bigelow as superintendent of the Connecticut Company's lines in eastern Connecticut, with headquarters at Norwich. His jurisdiction will extend over the district between New London on the south and the state line on the north, comprising 105 miles of road.

Miss R. Boydland, for the past year general accountant of the Grand Rapids Grand Haven & Muskegon Railway, Grand Rapids, Mich., has been appointed auditor of the company. Miss Boydland entered the service of the company as stenographer about four years ago and succeeded Mr. S. L. Vaughan as general accountant last April when he was appointed traffic manager.

Mr. Bernard C. Cobb has been elected vice-president of the Saginaw-Bay City Railway & Light Company, Saginaw, Mich., succeeding Mr. S. E. Wolff, whose resignation as vice-president and general manager was announced in the Electric Railway Review of April 11. Mr. H. T. Wicks has been elected second vice-president. Mr. E. C. Folsom, heretofore superintendent of the company, has resigned, and Mr. J. F. Collins, who was recently appointed general manager to succeed Mr. Wolff, will combine the duties of superintendent and general manager.

Mr. A. H. Hayward, vice-president of the York Railways Company, York, Pa., has resigned; effective on May 1. He was appointed general manager of the York County Traction Company in January, 1905, and held that position until elected vice-president of that company and the York Street Railway, Mr. David Young, Jr., being appointed general manager to succeed him. Mr. Hayward formerly was general manager of the Lehigh Valley Transit Company at Allentown, Pa., and later was general superintendent of the Dayton Springfield & Urbana Electric Railway at Springfield, O. He also was at one time superintendent of the City Railway at Dayton, O.

Mr. Henry Donovan, whose resignation as master mechanic of the Washington Baltimore & Annapolis Electric Railway was announced in the Electric Railway Review of April 11, had been connected with the road during its construction. He began railway work in the mechanical departments of the Brooklyn Rapid Transit Company and the Manhattan Elevated Railroad, remaining with the latter company and the Interborough Rapid Transit Company for five years. He later was appointed master mechanic of the New Jersey & Hudson River Railway & Ferry Company of Edgewater, N. J., resigning after two years to accept a similar position with the Washington Baltimore & Annapolis Electric Railway. As earlier announced he will be succeeded by Mr. T. M. Childs, formerly of the General Electric Company.

### OBITUARY.

John M. Haldenwang, for 15 years superintendent of the southern district of the Brooklyn City Railroad, died recently at the age of 71 years.

Charles A. Murphey, one of the promoters of the Key West Electric Company, Key West, Fla., is dead. He was a well-known lawyer of New York City and a former president of the Brooklyn Heights Improvement Company.

**Chicago Railways Company.**—Organization has been completed by the election of the following directors: Henry A. Blair, chairman, John M. Roach, Frederick H. Rawson, W. M. Eisendrath, Hempstead Washburne, A. B. Jones, John W. Gary and Wallace Heckman.

**Coney Island & Brooklyn Railroad, New York.**—Application has been made to the New York public service commission, first district, for approval of an issue of \$462,000 of consolidated mortgage bonds. The proceeds are to be used to pay for reconstruction of the line from Prospect Park to Coney Island, the purchase of new cars and the construction of a new power plant.

**Forest City Railway, Cleveland, O.**—Stockholders have voted to increase the capital stock from \$2,000,000 to \$6,000,000.

**Illinois Traction Company, Champaign, Ill.**—It is rumored that the Canadian stockholders will sell control of this property to an English syndicate.

**Interborough-Metropolitan Company, New York.**—J. P. Morgan & Co. of New York are negotiating for the purchase of \$25,000,000 of 3-year notes.

**Paris (Ill.) Traction Company.**—Earnings from May 25, 1907, to February 1, 1908, were as follows: Earnings from passengers, \$14,871.26; earnings from other sources, \$500; gross income, \$15,371.26; operating expense, \$6,924.53; net income, \$8,446.73.

**Plymouth Carver & Wareham Street Railway.**—Stockholders have voted to wind up the affairs of the company. The company was organized in December, 1903, to build a railway from Plymouth through Carver to Tremont and Wareham, Mass., but construction was not started. Stockholders will receive 75 per cent of the cost of their stock.

**Rochester (N. Y.) Railway & Light Company.**—Application has been made to the New York public service commission, second district, for approval of an issue of \$1,474,000 of 5 per cent bonds to refund outstanding obligations.

**Toledo & Chicago Interurban Railway, Kendallville, Ind.**—James D. Mortimer, the receiver, has been authorized by Judge Heaton of the Allen county circuit court, Kendallville, to spend \$65,000 for improvements in track.

### Dividends Declared.

- East St. Louis & Suburban Company, East St. Louis, Ill., preferred, quarterly, 1½ per cent.
- Georgia Railway & Electric Company, Atlanta, Ga., preferred, quarterly, 1½ per cent.
- Grand Rapids (Mich.) Railway, preferred, quarterly, 1½ per cent.
- Twin City Rapid Transit Company, Minneapolis, Minn., common, quarterly, 1½ per cent.
- Lincoln (Neb.) Traction Company, common, 4 per cent.
- Milwaukee Electric Railway & Light Company, common and preferred, quarterly, 1½ per cent.
- Montreal Street Railway, quarterly, 2½ per cent.
- West Penn Railways, Pittsburg, preferred, quarterly, 1½ per cent.

### ELECTRIC RAILWAY EARNINGS.

	Gross earnings.	Operating expenses.	Net earnings.	Total charges.	Surplus.
Northern Ohio Trac. & Light Co., Akron, O., March, 1908.....	\$ 129,659.38	\$ 81,273.34	\$ 48,386.04	\$ 43,953.29	\$ 4,432.75
Northern Ohio Trac. & Light Co., Akron, O., March, 1907.....	133,832.87	83,215.23	50,618.64	41,290.03	9,328.61
American Railways Company, Philadelphia, subsidiary companies, March, 1908.....	207,774.29				
American Railways Company, Philadelphia, subsidiary companies, March, 1907.....	227,150.26				
United Railways Company of St. Louis, March, 1908.....	858,908.00	559,135.00	299,773.00	232,290.00	66,483.00
United Railways Company of St. Louis, March, 1907.....	903,145.00	596,247.00	306,898.00	230,868.00	76,030.00
United Railways Company of St. Louis, January 1, 1908, to March 31, 1908.....	2,461,761.00	1,633,034.00	828,727.00	700,163.00	128,564.00
United Railways Company of St. Louis, January 1, 1907, to March 31, 1907.....	2,494,162.00	1,722,595.00	771,567.00	693,734.00	77,833.00
Lexington & Interurban Railways, February, 1908.....	38,930.97	27,671.84	11,259.13		
Lexington & Interurban Railways, February, 1907.....	35,266.86	25,237.02	9,909.84		
Lexington & Interurban Railways, January 1, 1908, to February 29, 1908.....	81,974.54	56,595.00	25,379.54		
Lexington & Interurban Railways, January 1, 1907, to February 28, 1907.....	74,980.53	53,438.01	21,542.52		

# Manufactures and Supplies

## ROLLING STOCK.

**Washington Railway & Electric Company**, Washington, D. C., is in the market for one interurban car.

**Diamond State Rapid Transit Company**, Smyrna, Del., under construction, will buy a number of interurban cars.

**Union Traction Company**, Santa Cruz, Cal., is reported to have placed an order for four double-truck motor cars and two trailers.

**Grand Central Traction Company**, which was reported in the Electric Railway Review for April 18 to be in the market for a number of interurban cars, will place an order for 20.

**Chicago Railways** has placed an order with the Pullman Company for trucks for the 300 cars ordered recently from that company and for the 50 all-steel cars to be built by the Pressed Steel Car Company. The contract for the air brakes was awarded to the National Brake & Electric Company, Milwaukee.

**Des Moines City Railway**, Des Moines, Ia., has remodeled one of its cars so that the pay-as-you-enter system of fare collection may be used on it. It is stated that the company will adopt the type generally if the experiment proves successful.

**Chicago Lake Shore & South Bend Railway**, South Bend, Ind., which was reported in the Electric Railway Review for March 21 to be in the market for four double-truck cars, has placed an order with the G. C. Kuhlman Car Company for two interurban cars.

## TRADE NOTES.

**R. W. Marshall & Co.**, New York, have moved their offices from 93-97 Liberty street to the Hudson Terminals.

**American Locomotive Company**, New York, has moved its general offices to the Hudson Terminals, Cortlandt building.

**McGuire-Cummings Manufacturing Company**, Chicago, has moved its New York office from 42 Broadway to 32 Broadway.

**Lorain Steel Company's** sales office has been moved from 74 Broadway, New York, to the Hudson Terminals, 30 Church street.

**National Tube Company**, Pittsburg, has moved its New York office from Battery Park building to the Hudson Terminals.

**J. A. Venable** has been appointed general manager of the New York Car Wheel Company, Buffalo, N. Y., succeeding P. H. Griffin, resigned.

**Dielectric Manufacturing Company**, St. Louis, has increased its working capital to \$40,000. The company manufactures electrical insulating materials exclusively.

**Vulcan Iron Works Company**, Toledo, O., in order to make its corporate name more fully indicative of its principal business, has changed it to the Vulcan Steam Shovel Company.

**Nebraska Electrical Trades Exposition Company**, Omaha, Neb., is now making reservations of exhibit space for the first annual electrical show, to be held at the Omaha Auditorium, May 4 to 9. J. M. Gillan, manager.

**A. L. Whipple** has resigned as second vice-president of the Telharmonic Securities Company, New York, and will re-enter the railway supply business. Mr. Whipple was formerly eastern manager of the Curtain Supply Company, Chicago.

**J. S. Lehman**, formerly general lamp agent at St. Louis for the Westinghouse Electric & Manufacturing Company, has been appointed agent for the Moline Incandescent Lamp Company, Moline, Ill. Mr. Lehman's headquarters are in the Security Trust building, St. Louis.

**Westinghouse Electric & Manufacturing Company's** executive offices and New York sales and export offices were moved on April 20 from 11 Pine street to the City Investing building, 165 Broadway. The New York offices of the Westinghouse Air Brake Company were also moved to the same building.

**General Electric Company's** New York offices have been moved from the Edison building, 44 Broad street, to the Hudson Terminals, Cortlandt building, 30 Church street. Approximately 31,000 square feet, or the entire seventeenth floor of the Cortlandt building, will be occupied by the General Electric Company.

**John Lucas & Co.**, Philadelphia, have purchased a plant at Sixteenth and Morgan streets, Chicago, and are now installing machinery for the manufacture of paints. Harry C. Quest, formerly with the Heath & Milligan Manufacturing Company, is in charge of the railway sales department of John Lucas & Co., with offices at 708 Marquette building, Chicago.

**Barney & Smith Car Company**, Dayton, O., on April 10 gave a dinner to all its employees who had been in the company's service for 25 years or more. There were present 178 men who met this qualification. A. M. Kittredge, vice-president of the company, presided. Among the guests and speakers was George A. Post, president of the Standard Coupler Company, New York.

**Horatio A. Foster**, resident engineer in Baltimore for L. B. Stillwell, has been transferred to the New York office, 100 Broadway. He will still continue to look after the work in Baltimore, sharing this supervision with H. S. Putnam on electrical work and with Mr. Van Vleck on the steam end. Mr. Foster has been in charge of the work in Baltimore since it was started a year and a half ago, and has carried through to completion the many additions and changes made to the power plants of the United Railways & Electric Company, under the contract with Mr. Stillwell. These included the construction of a power station at Bay Shore, a new summer resort; a new substation in the central part of the city; an addition to one of the outlying substations; rearranging and reinforcing of three existing substations, and the construction and reconstruction of the Pratt street power station. During this period of building the operation of all power plants came under his supervision and the forces were all thoroughly reorganized.

**The J. G. Brill Company**, Philadelphia, on April 1 acquired the plant of the Danville Car Company, Danville, Ill., and is continuing the business without change of name. The Danville plant was completed early last year and is entirely modern in construction and equipment. A description of the plant was published in the Electric Railway Review of August 17, 1907. The company will build electric railway cars of all types, as well as trucks, steam coaches, freight cars and electric locomotives. It will also make a specialty of building and repairing steel cars. The following officers have been elected: Samuel Curwen, president; George H. Tontrup, vice-president and manager of the sales department; H. F. Vogel, general manager; and Edward P. Rawle, treasurer. Mr. Curwen was also recently elected a director and vice-president of The J. G. Brill Company, succeeding the late John A. Brill. The J. G. Brill Company now controls the following plants: American Car Company, St. Louis; G. C. Kuhlman Company, Cleveland; John Stephenson Company, Elizabeth, N. J.; Wason Manufacturing Company, Springfield, Mass.; Danville Car Company, Danville, Ill.

## ADVERTISING LITERATURE.

(Mention of the Electric Railway Review will assure prompt attention to requests for publications listed here.)

**Woolley Electric Company**, 811 North Second Street, St. Louis, Mo.—A neat illustrated price list of B-P inclosed fuses has been issued.

**H. W. Johns-Manville Company**, 103 William Street, New York, N. Y.—Recent circulars include No. 7661, descriptive of the J-M national steel boiler tube cleaner, and No. 7705, devoted to Vulcabeston packings.

**B. B. Hill Manufacturing Company**, 1016 New Market Street, Philadelphia, Pa.—A brief descriptive catalogue of railroad stamping devices has been issued which includes information regarding an improved model of the Centennial dater and a new model stub cutter and dater for the larger and union ticket offices.

**Alexander Milburn Company**, 507 West Lombard Street, Baltimore, Md.—Catalogue E describes in detail and illustrates the Milburn light for contractors, engineers and railways. Features of simplicity, economy, efficiency and mobility are considered and lights designed for particular services, such as railroad wrecking work, underground excavation, etc., are shown.

**Railroad Supply Company**, Chicago, Ill.—Section No. 4 of signal department catalogue No. 7 has just been issued. It shows various styles of lightning arresters, designed for both direct and alternating current. The catalogue also describes various methods of lightning arrester application, ground plates, ground rods and water and fire proof boxes for arresters.

**Expanded Metal & Corrugated Bar Company**, St. Louis, Mo.—A catalogue measuring 8½ by 10½ inches and contain-

ing 111 pages and cover is devoted to the subject of "Corrugated Bars for Reinforced Concrete Construction." It has a fund of valuable information and a great many interesting illustrations, those of railway construction being especially interesting.

**Coates Clipper Manufacturing Company, Worcester, Mass.**—A recently issued catalogue is devoted to the Coates system of unit-link flexible transmission. An important feature is the description of a new transmission head, which transmits power from a drill press, lathe or any other power driven tool, and utilizes it for drilling, buffing, grinding, etc. This does away with the expense of motor or other special drive and permits the use of portable tools in any portion of a shop where a power-driven tool is located. The catalogue is from the press of Mugford & Co., Hartford, Conn.

**More-Jones Brass & Metal Company, St. Louis, Mo.**—A new catalogue has just been issued descriptive of the More-Jones line of metals, babbit metals, brasses, bronzes, brass, bronze and aluminum castings, bearings and bearing specialties, crucibles, solders, etc. The book is fully illustrated, contains 244 pages and has a green cloth cover stamped in red and black.

**E. S. Jackman & Co., 164 West Lake Street, Chicago.**—An unusually handsome and well written booklet descriptive of the Firth-Sterling Steel Company's special tool steel and blue chip high-speed steel, comes from the steel company's Chicago agents. A brief sketch of the discovery, development, forms and uses of blue chip high-speed steel is given, together with instructions on hardening and tempering it.

**Standard Varnish Works, 29 Broadway, New York, N. Y.**—A folder attractive in appearance and text places this concern's various departments at the command of customers for any service it may be practical to render. Included most particularly is its architectural department, "in which are men competent to give technical information, to make tests and to prepare samples and exhibits of materials conceived for special or extraordinary purposes."

**Allis-Chalmers Company, Milwaukee, Wis.**—Bulletin No. 1502 describes the test of the steam engines comprising the power plant of the New York subway system. There are nine engines, each rated at 8,000 horsepower, but the actual capacity is 12,000 horsepower. The plant is equal to the power of six such vessels as the Connecticut, flagship of the new Pacific fleet, with 4,500 horsepower to spare. The combined engine power of three or four leviathans of the deep, like the Kaiser Wilhelm II, the Oceanic and the new turbine steamers built for the Cunard line, would be required to equal the power of the New York subways. Measured in electrical terms, the daily average output of the nine engines is about 800,000 kilowatt-hours. One thousand tons of coal and 1,800,000 gallons of water, or enough to supply the needs of a city of 30,000 to 40,000 inhabitants, are required daily. Naturally the outcome of a test of an installation of this magnitude is of unusual interest.

**GIBBS TRAIN-INDICATING DEVICE.**

We present in the accompanying illustrations views of a "train indicating" device which has been developed by W. A. Gibbs, district manager Ohio Electric Railway, Columbus, O., and for which manufacturing arrangements have been made. We quote Mr. Gibbs' own description and claims made for this device:

The train-indicating device provides a simple and easy means for carrying train numbers on cars. As we are operating at present and as most roads of like character are operating, we have no indication whatever to show crews of trains meeting at a designated passing point what the opposing train represents. We go to a great deal of pains and trouble to get out elaborate timetables and specify trains by numbers, making them pass at certain points at certain times. In issuing special orders we very often use car numbers, but if anything happens to the car it is likely to be displaced by another car instead of the one specified as put out on the run.

In case of an extra train we issue orders to the men and depend on their putting up proper classification signals. Should they fail to do this, however, and be met by an opposing train on a passing point shown by the timetable, the crew of the opposing train would be perfectly right in considering them to be the train to be passed.

In case of trains running in sections, should the proper signals not be displayed, or in either of these cases should the signal lights go out after dark, a misunderstanding would result which could be attributed to nothing but the fault of the method of operation.

Misunderstandings regarding trains also occur quite often

in yards where trains not shown on the timetables or against which special orders need not be given may be occupying certain tracks.

It seems, therefore, that in order to identify a certain train with the timetable it is necessary to carry train numbers. This can be done in various ways, but electric cars especially have so many different train numbers in a day that none of the methods that have been used seemed adaptable to the purpose because they were too cumbersome and because of the liability of a car not having the proper train numbers on it when it went into service. My object in designing the new

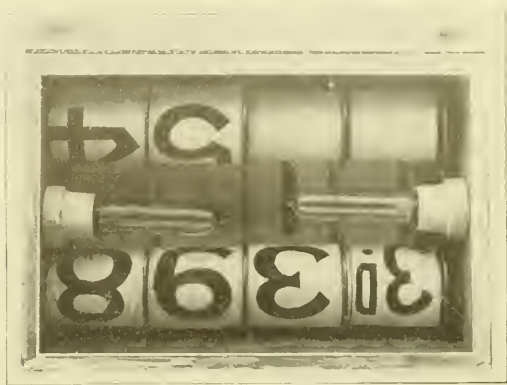

Gibbs Train-Indicating Device—Rear View with Cover Raised.

device was to provide a simple and easy means for showing train numbers on cars that would be complete in itself and a part of the car. I therefore developed the device which consists of separate ribbon rollers, as shown by the engravings.

Each ribbon has the numbers from 1 to 0 printed on it, as well as a blank space, so that no number need be shown



Gibbs Train-Indicating Device—View as Installed in Car.

if it is not desired. The four ribbons, when properly set, display the word "Extra," to be used on extra trains which do not have train numbers. Each ribbon is operated separately. Any combination of numbers up to 999 can be had with the three ribbons. The fourth one I have used to specify sections of trains that may consist of more than one section.

The superiority of this method obtains because if the train number is not right it is wrong; and consequently if it is not right the opposing train will not have the right to proceed. Thus it is impossible to have any misunderstanding

in connection with the device in case the trainmen neglect to set it properly.

With the cover raised and as viewed from the platform the numbers appear upside down. It is easy for the operator to see through the strips and adjust the numbers from the back of the box and also see what numbers he has up. The device is shown as installed in one of the Columbus-Zanesville limited cars on the Ohio Electric Railway Company's line.

Lights are provided in the box and, the strips being transparent, the numbers are as easily distinguished by night as by day.

#### NATIONAL AIR BRAKES FOR CHICAGO RAILWAYS COMPANY.

The Chicago Railways Company, which owns all of the north and west side street railways in the city of Chicago, has just awarded a contract to the National Brake & Electric Company, Milwaukee, Wis., to furnish all of the air brake apparatus for the 1,200 new cars which, in accordance with the traction ordinance, it will purchase and place in service within the next three years.

The Chicago Railways Company expects to put about 550 new cars into service this summer, orders for 400 cars having already been placed with the Pullman Company and the Pressed Steel Car Company. This contract covers a larger number of air brakes than has ever before been contracted for by any electric railway company and is significant of the merits and reputation of the product of the National Brake & Electric Company, which has already supplied a large number of its National air brakes to both the Chicago City Railway Company, operating the south side lines, and the Chicago Union Traction Company, now the Chicago Railways Company.

#### GEARS FOR ELECTRIC TRAVELING CRANES.

The experience of a large manufacturing establishment having heavy overhead traveling cranes has been rather unsatisfactory because of the breaking of the teeth of the gray iron gears and pinions with which the crane machinery was

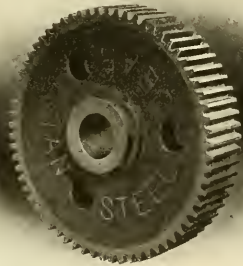

Gears for Electric Traveling Cranes.

fitted, the last breakage of gear teeth resulting in putting the crane out of service for some weeks until a portion of it could be rebuilt and steel gears applied.

Other crane users have found that the severe service causes even steel gears to wear rapidly, and that failures are frequent because of worn teeth. A material which has been found to be more durable for gears is manganese steel, and at the shops referred to all the cranes have been or are being equipped with manganese steel gears and pinions, for which a life fully five times as long as that of cut tooth gears and pinions made of another grade of steel is reported.

This longer life of gears means a great saving in locomotive, car and other shops having overhead electric traveling cranes, and also in steel mills, foundries and factories making heavy machinery of any kind where gears are used.

The manganese steel gears and pinions, besides being economical for this class of service, have shown in the last few years a great economy when used in electric railway motors.

On the score of economy it is claimed that a manganese steel gear running with a manganese steel pinion will outwear at least five of the cut tooth type of gear, and that in addi-

tion there are savings in the labor required for replacements and in keeping the equipment longer in service; the amount of noise is also reduced.

The Atha Steel Casting Company of Newark, N. J., is the exclusive maker of manganese steel gears and pinions, and will be pleased to furnish full information regarding methods of manufacture, sizes, service and cost of gears and pinions, on application to the general office, or any one of its branch offices, which are located in Boston, Mass., Board of Trade building; Richmond, Va., American National Bank building; Cleveland, O., Caxton building; Chicago, Railway Exchange.

Bulletin No. 3, published recently, gives full information concerning these gears.

#### IMPROVED MOTOR-DRIVEN CAR WHEEL BORING MILL.

The accompanying illustration shows a late type of motor-driven car wheel boring mill, with improved automatic chuck, friction feed discs and crane attachment. It is a 54-inch machine and its heavy construction and powerful gearing render it capable of taking the heaviest cuts required for this class of work.

The automatic chuck is self-closing, self-opening and self-centering. It has three adjustable abutments, each provided with an equalizing steel jaw with two bearing points. The work is thus held and centered by six points on the circumference, insuring accuracy in centering.

The first movement of the driving shaft causes the jaws to close upon the work, after which the motion is transmitted to the table to produce rotation. When the boring is completed, the chuck is released by disengaging the driving clutch and retarding the driving shaft by means of the friction brake provided for the purpose. The inertia of the table and work thus imparts the necessary force to open the jaws.

The work is secured in its correct position in the machine

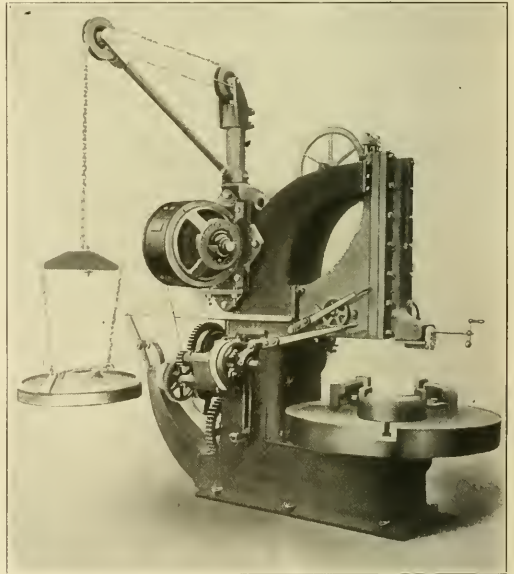

Improved Motor-Driven Car Wheel Boring Mill.

and released with no loss of time and without labor. Since the power of the clutch grip increases with the resistance of the cut, it is never necessary to stop the table to tighten the chuck.

The boring mill is especially arranged for electric drive and the motor is mounted on the vertical housing of the frame. The motor is a Westinghouse type S for a variation in speed of approximately two to one, and therefore eliminates the cone pulley required by line shaft drive. This increases the machine capacity because the variable speed motor gives the desired range of speed in much smaller steps, permitting the mill to be run at all times at its maximum. The boring mill is manufactured by William Sellers & Co., Inc., Philadelphia.

# Dearborn Water Purifying Reagents

Increase the efficiency and the years of service of steam boilers by keeping them in good condition internally. Gallon sample of the water required for analysis before preparing treatment.

## Dearborn Drug & Chemical Works

ROBT. F. CARR, PRESIDENT

299 BROADWAY, NEW YORK      POSTAL TELEGRAPH BLDG., CHICAGO

# Rooke Automatic Fare Collector

and make it a point to have their nickels ready.

They like the plan—all honest conductors like it—and its use puts every nickel collected into the company's treasury.

**Rooke Automatic Register Company**  
Providence, Rhode Island

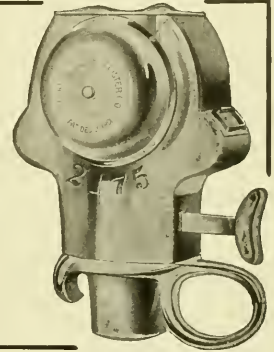

6

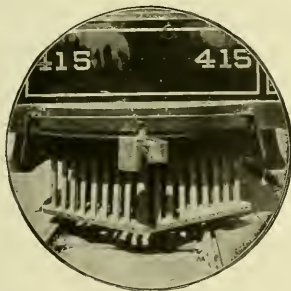

# Washburn Standard M. C. B. Coupler

Coupled or uncoupled from either side and on curved track as easily and safely as on straight track. The result is that

- trains may be operated in from two to six units each
- movement is safe around short curves of city streets
- freight cars are handled satisfactorily, and
- interchange is facilitated with steam roads.

*Our 112-page catalog of traction devices sent free for the asking.*

**Washburn Steel Castings & Coupler Co., Minneapolis, Minn.**

Western Agents: Tweedy, Hood & Finlen, 204 Fisher Bldg., Chicago  
Canadian Agent: John Taylor, Montreal

17

# The Moore Track Drill

does not interfere with traffic!

The shifting of one lever and a few seconds' time takes down the drill—the operation reversed makes it ready for work again.

This is only one of the many strong points about the Moore Track Drill that make it worth buying.

*Ask for descriptive catalogue.*



**Kalamazoo Railway Supply Co.** Kalamazoo Michigan

1

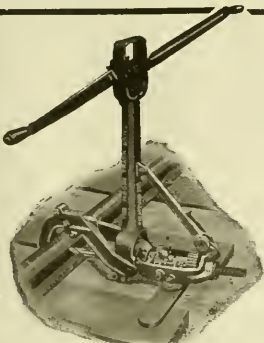

# THE J. G. BRILL COMPANY, PHILADELPHIA, PA.

AMERICAN CAR COMPANY, ST. LOUIS, MO.  
 G. C. KUHLMAN CAR COMPANY, CLEVELAND, OHIO  
 JOHN STEPHENSON COMPANY, ELIZABETH, N. J.  
 WASON MANUFACTURING CO. SPRINGFIELD, MASS.

MAIN OFFICE: PHILADELPHIA, PA.  
 LONDON OFFICE: 110 CANNON ST. E. C.  
 PACIFIC COAST AGENTS: PIERSON  
 ROEDING & CO., SAN FRANCISCO.  
 AUSTRALIAN AGENTS: NOYES  
 BROTHERS, SYDNEY. CABLES:  
 "BRILL," PHILA., "AXLES" LONDON.

*CARS TRUCKS SEATS RATTAN SPRINGS SPECIALTIES SUPPLIES*

## FOR HIGH EFFICIENCY

The centrifugal pump is used in fire engines because it is the simplest and most effective means of producing pressure. It is used in the Brill power sprinkler for the same reason. The centrifugal pump is operated by a direct-connected motor (both located on the platform at one end of the car) and supplies pressure for distributing the water uniformly over fifty feet of roadway on each side of the track. The pump shaft has the only wearing surface in the entire mechanism, so no trouble is caused by heated parts. The amount and direction of the water is always under perfect control by the patented type of sprinkling head employed. Write for catalog.

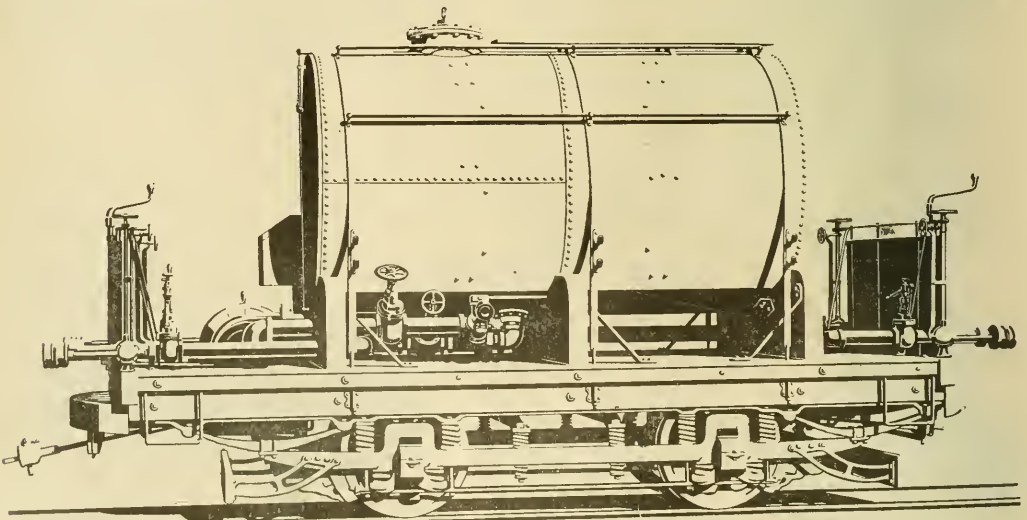

*THE BRILL CENTRIFUGAL SPRINKLER (PATENTED)*

# General Electric Company



MS 11-D Switch

## Circuit Breakers Type DB



MS 11-D Switch

Electrically Set and Tripped

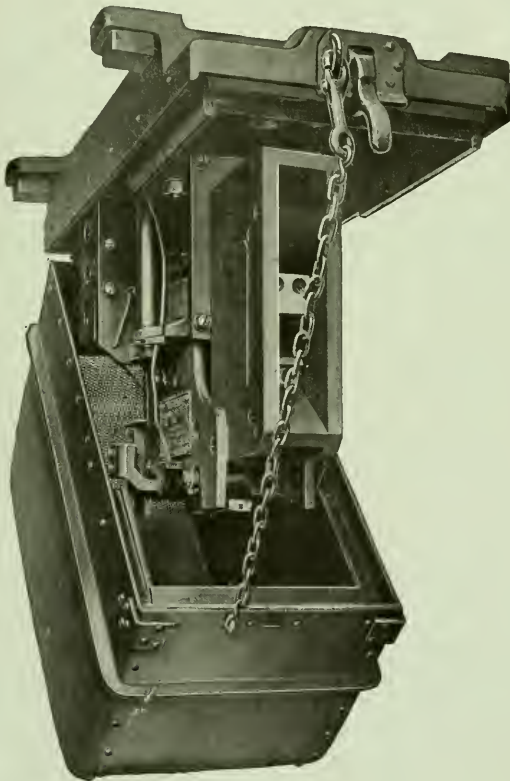

Absolute protection to equipment.

Require little attention or maintenance.

Are positive and reliable in action.

Eliminate accidents to passengers caused by circuit breakers on platforms.

They are arranged to be installed underneath the car floor and are set and tripped by small switch in motor-man's cab.

They are manufactured in sizes suitable for all types of car equipment.

1630

Chicago Office:  
Monadnock Bldg.

Principal Office:  
Schenectady, N. Y.

Sales Offices in  
all Large Cities

# AMERICAN ELECTRICAL WORKS

PROVIDENCE, R. I.

## BARE AND INSULATED ELECTRIC WIRE

New York Office, 26 Cortlandt St. Chicago Office, 135 Adams St.  
MONTREAL BRANCH: Eugène F. Phillips Electrical Works, Limited.



Wherever absolute accuracy is demanded the best steel measuring tapes to use are those made by

**THE LUFKIN RULE CO.**

SAGINAW, MICH., U. S. A.

New York  
London, England  
Windsor, Canada

## Of the strongest and lightest construction—that's the Ideal Trolley Wheel

Very different from the cast wheels you have used. May we tell you all about the *Ideal*?

Buffalo **LUMEN BEARING CO.** Toronto

# Mica Prices Reduced

Compare our prices on Raw Mica and Manufactured Mica with prices you have been paying our competitors

**WHY PAY FANCY PRICES?**

Chicago Mica Co.

Valparaiso, Ind.



Established 1877.



## ALBERT & J. M. ANDERSON MFG. CO.,

Makers of

**ELECTRICAL APPLIANCES:**  
SWITCHES, SWITCHBOARDS,  
TIME SWITCHES, LINE MATERIAL,  
COPPER CASTINGS (75% CONDUCTIVITY).  
289-293 A ST., BOSTON, MASS., U. S. A.

Branches: Chicago, 175 Dearborn Street.  
Agencies: Boston, Pettingell-Andrews Co. San Francisco, Eccles & Smith Co.  
New York, R. W. Marshall & Co. Atlanta, Newcomer-Manry Co.  
St. Louis, J. C. White. Denver, E. M. Messiter.  
Toronto, Ont., H. J. Surtees.



# Bonding Time will be at hand soon!

Before then—right now, in fact—you should investigate the modern bonding methods—

## Electric Brazing AND Copper Welding

—because, of course, you want the best bonding at economical cost. And best means perfect mechanical and electrical union, giving greatest conductivity and longest life. Ask us for the names of users—then investigate in your own way.

## The Electric Railway Improvement Company

6005 Carnegie Ave. - - Cleveland, Ohio

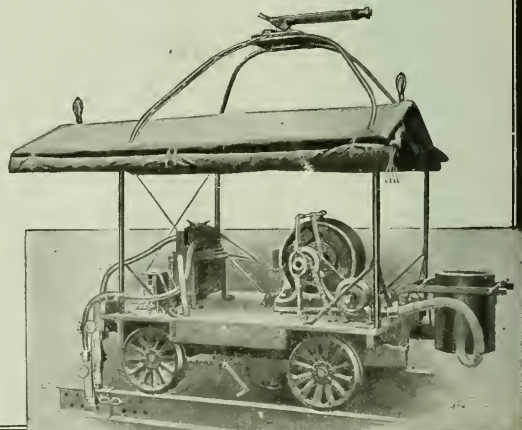



# Electric Railway Review

PUBLISHED EVERY SATURDAY.

FORMERLY THE STREET RAILWAY REVIEW.

THE WILSON COMPANY, CHICAGO.

CHICAGO: 160 Harrison Street  
NEW YORK: 50 Church Street  
CLEVELAND: 1529 Williamson Bldg.

Vol. XIX  
No. 18

CHICAGO, MAY 2, 1908

Whole No.  
262

Subscription: Domestic, \$2.00  
Foreign, 5.00  
Canada, 3.50

## Advertise

- to make your house and your goods well known among prospective customers.
- to give your concern strong prestige, and eventually pre-eminence, in your field.
- to make upon the minds of prospective customers those impressions that turn doubt into belief and belief into orders.
- to produce inquiries for your printed advertising matter from interested buyers.
- to smooth the way for your salesmen and cut down the time required to secure acquaintance.
- to help, in a dozen different ways, sell your goods, and at far less cost than by any other method.

Advertising is doing these things every day for others—perhaps for your competitors—and advertising will do them for you, too, if rightly handled.

All you have guessed about advertising may not be quite right, so don't infer that advertising won't help your business, for it will, and we'll gladly show you how.

Just ask us to have an advertising representative call. No obligation—no contract to sign unless you want to—just a straight business conference.

## Electric Railway Review

160 Harrison Street, CHICAGO

# Present Day Economy

demands the

## Protection of all Apparatus

☐ A little time carefully spent in the inspection of your **Lightning Arresters** will no doubt save a good many repair bills in the coming six months.

☐ Lightning or static discharges on unprotected lines means the loss of generators or motors and the loss of income due to interrupted service.

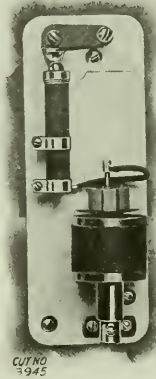

suggests

## Garton-Daniels Arresters

☐ The latest model, Type E. G., for direct current railway circuits, shown herewith, has made an unexcelled record for efficiency and durability.

☐ It has been thoroughly tried out in four years of service tests.

☐ Let us suggest the least outlay which will give proper protection. Bulletin No. 21, showing the latest types, is ready for distribution.

## ELECTRIC SERVICE SUPPLIES Co.

Railway Material & Electrical Supplies

MAYER & ENGLUND DEPT.  
PHILADELPHIA

GARTON-DANIELS DEPT.  
KEOKUK

PORTER & BERG DEPT.  
CHICAGO

NEW YORK

PITTSBURG

SAINT LOUIS

ATLANTA

## Straight-Way Check Valves with Regrinding Seats

THESE valves are designed for the most exacting service, on pressures up to 150 pounds. All parts are made of a superior bronze mixture. The distribution of metal gives ample strength without unnecessary weight.

Valves have full area and operate horizontally or vertically.

The seat is placed at such an angle that the force of impact of disc is reduced to the minimum, decreasing wear on disc as well as noise of hammering.

Side hub and disc-stop are made up with tapered joints to overcome the tendency to leak at these places.

Regrinding is a very simple operation and requires but a few minutes.

Made in sizes up to 3 inch, screwed or flanged.

**CRANE CO.**  
CHICAGO  
ESTABLISHED 1855

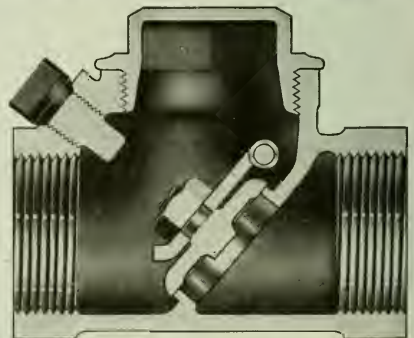
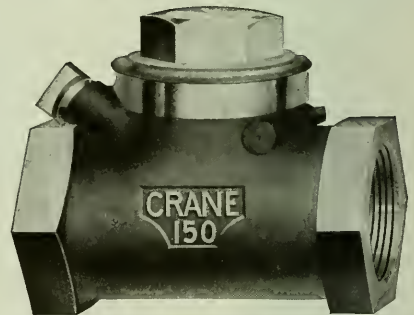

# Westinghouse

## Interpole Railway Motors

Reduce maintenance cost.  
Have perfect commutation.  
Greatly diminish brush-wear.  
Practically eliminate flashing.

Ask our nearest office  
for full particulars

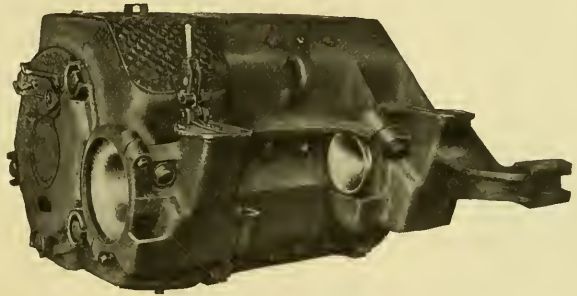

### Westinghouse Electric & Mfg. Co.

Atlanta  
Baltimore  
Boston

Buffalo  
Chicago  
Cincinnati

Cleveland  
Dallas  
Denver

Detroit  
Kansas City  
Los Angeles  
Minneapolis

New Orleans  
New York  
Philadelphia

Pittsburg  
St. Louis  
Salt Lake City

San Francisco  
Seattle  
Syracuse

Canada: Canadian Westinghouse Co., Ltd., Hamilton, Ontario Mexico: G. & O. Braniff & Co., City of Mexico

### Where cooling water is not available

the best kind of steam engine to install, one specially designed to meet just such a condition, is the

### Westinghouse Non-Condensing Turbine

There are many reasons favoring its use under such circumstances. Give our nearest sales office the details of your requirements; they will demonstrate the economies secured by installing this type of turbine.

The Westinghouse Machine Co.  
Pittsburg, Pa.

### It is permissible

to experiment with many new devices offered as part of electric car equipments.

### It is not permissible

to experiment with the air brakes: too much depends upon their unquestioned reliability.

You are not experimenting when you operate your cars with Westinghouse "AMM" automatic, quick-recharge, graduated-release, quick-service, high-pressure emergency air brakes, which are in successful service under the severest conditions on a large number of roads. They are adapted to one to five car train service, and present the best solution for a wide range of braking problems.

Westinghouse Traction Brake Co.  
Pittsburg, Pa.

## ALPHABETICAL INDEX TO ADVERTISEMENTS.

Advance Lumber Co. ....18	Dearborn Drug & Chemical Works .....21	Model Stoker Co. ....14	Standard Motor Truck Co. ....24
Allis-Chalmers Co. ....11	Dossert & Co. ....12	Morden Frog & Crossing Wks. ....25	Standard Paint Co. ....14
Aluminum Co. of America. ....11	Drouvé, G. ....12	National Brake & Electric Co. ....24	Standard Steel Works. ....16
American Brake Shoe & Fdry. Co. ....13	Eclipse Railway Supply Co. ....11	National Brake Co. ....25	Standard Underground Cable Co. ....11
American Electrical Works. ....13	Electric Railway Equipment Co. ....23	National Lock Washer Co. ....22	Star Brass Works. ....21
American Frog & Switch Co. ....13	Electric Ry. Improvement Co. ....11	National Pole Co. ....18	Stone & Webster Engineering Corporation. ....23
Anderson, Albert & J. M., Mfg. Co. ....28	Electric Service Supplies Co. ....2	Naugle Pole & Tie Co. ....18	Stuart-Howland Co. ....23
Armstrong Oil Co. ....14	Engineers and Contractors. ....14	New York Switch & Crossing Co. ....21	Symington, T. H., Co. ....28
Arnold Company. ....14	Fairbanks, Morse & Co. ....14	Niles Car & Mfg. Co. ....16	Telegraph Signal Co. ....19
Atlas Steel Casting Co. ....25	Ford, Bacon & Davis. ....14	Northern Engineering Works. ....16	Trolley Supply Co. ....13
Automatic Trolley Guard Co. ....16	Galena-Signal Oil Co. ....23	Nuttall, R. D., Co. ....16	U. S. Metal & Mfg. Co. ....14
Babcock & Wilcox Co. ....12	Garford Co. ....18	Ohio Brass Co. ....5	Van Dorn & Dutton Co. ....14
Baker, Wm. C., Heating & Supply Co. ....16	General Electric Co. ....27	Okonite Co., Ltd. ....14	Van Dorn, W. T., Co. ....28
Baldwin Locomotive Works. ....16	Green Engineering Co. ....14	Pacific Coast Pole Co. ....18	Van Valkenburg, E. C. ....14
Barbour-Stockwell Co. ....16	Griffin Wheel Co. ....14	Partridge, E. ....25	Wanted and For Sale Cards. ....20
Barbour-Stockwell Co. ....16	Hagy, J. Milton, Waste Wks. ....11	Patten, Paul B. ....9	Washington Steel Castings & Coupler Co. ....25
Barnes, G. H., Hardwood Lumber Co. ....18	Hale & Kilburn Mfg. Co. ....14	Pay-As-You-Enter Car Co. ....9	Watson-Stillman Co. ....22
Beidler, Francis, & Co. ....18	Harnstern Co., Stewart. ....12	Power Specialty Co. ....22	Western Electric Co. ....23
Bellamy Vestelite Mfg. Co. ....18	Heine Safety Boiler Co. ....12	Pressed Steel Car Co. ....23	Westinghouse Elec. & Mfg. Co. ....3
Berthold & Jennings. ....18	Heywood Bros. & Wakefield Co. ....12	Queen & Co. ....23	Westinghouse Machine Co. ....3
Bridgport Brass Co. ....18	Holman, D. F., Ry. Tracklayer Co. ....11	Rail Joint Co. ....16	Westinghouse Traction Brake Co. ....3
Brill, J. G., Co. ....26	Humbird Lumber Co., Ltd. ....11	Railway Specialty & Supply Co. ....23	Weston Electrical Instrument Co. ....23
Brown, Harold P. ....14	Jewett Car Co. ....17	Railway Steel-Spring Co. ....14	Wharton, Wm., Jr., & Co. ....23
Brown Hoisting Machy. Co. ....14	Johns-Manville, H. W., Co. ....5	Register, A. L., & Co. ....14	Wheeler Condenser & Eng'g Co. ....14
Buckeye Engine Co. ....13	Kalamazoo Ry. Supply Co. ....25	Robertson, Wm., & Co. ....17	Wheel Truing Brake Shoe Co. ....14
Burnham, Williams & Co. ....16	Lansley Bros. Co. ....18	Rodger Ballast Car Co. ....22	White, J. G., & Co. ....14
Bylesby, H. M., & Co. ....14	Larkin & Burnham Co. ....16	Roose Automatic Register Co. ....19	Whitmore Mfg. Co. ....28
Central Inspection Bureau. ....14	Lumden Bearing Co. ....11	Russell Car & Snow-Plow Co. ....20	Wilson, J. G., Mfg. Co. ....23
Chase-Shawmut Co. ....15	Macallen Co. ....22	S-E. Missouri Cypress Co. ....18	Woodbury Carlton Co. ....23
Chicago Mica Co. ....12	McGuire-Cummings Mfg. Co. ....17	St. Louis Car Co. ....7	Woodman, R., Mfg. & Supply Co. ....18
Churchill Cedar Co. ....18	Marshall, R. W., & Co. ....20	St. Louis Car Wheel Co. ....14	Worcester, C. H., Co. ....18
Cincinnati Car Co. ....18	Meyers, Fred J., Mfg. Co. ....20	Sanderson & Porter. ....14	Zelnicke, Walter A., Supply Co. ....20
Cleveland Frog & Cross. Co. ....18	Miller Anchor Co. ....22	Saxton, E. ....14	
Collier, Barron G. ....18	Milloy Electric Co. ....22	Shimer & Chase Co. ....14	
Columbia Construction Co. ....18		Shiff & Jastaad. ....14	
Consolidated Car Fender Co. ....17		Simmons, John. ....21	
Consolidated Car-Heating Co. ....14		Smith, Peter, Heater Co. ....14	
Contractors' Supply & Equipment Co. ....14		Speer Carbon Co. ....11	
Crane Co. ....2		Standard Brake Shoe Co. ....21	
Creakhead Engineering Co. ....14			
Curtain Supply Co. ....13			
Davis, John, Co. ....18			

## CLASSIFIED LIST OF ADVERTISERS.

Advertising Designa and Plates. Woodbury-Carlton Co., Worcester, Mass.	Axles—(See Wheels and Axles).	Blowers—(See Mechanical Draft)	Brakes and Brake Parts—Continued.
Advertising Service. Van Valkenburg, E. C., 2117 West One Hundred and Second St., Chicago.	Babbitt Metals—(See Alloys and Bearing Metals).	Blue Printing Machines. Buckeye Engine Co., Salem, O.	Brill, The J. G., Co., Philadelphia.
Advertising, Street Car. Collier, Barron G., Flat Iron Bldg., New York.	Badges and Buttons. Electric Service Supplies Co., 200 Plymouth Bldg., Chicago.	Boliers. Babcock & Wilcox Co., N. Y. Fairbanks, Morse & Co., Chicago. Heine Safety Boiler Co., 421 Olive St., St. Louis. Lord & Burnham, Irvington-on-Hudson, New York.	Electric Service Supplies Co., 200 Plymouth Bldg., Chicago. General Electric Co., Schenectady, N. Y. Kuhlman, The G. C., Car Co., Cleveland. McGuire-Cummings Mfg. Co., Chicago. National Brake & Electric Co., Milwaukee. Stephenson, John, Co., Elizabeth, N. J. Wason Mfg. Co., Springfield, Mass. Westinghouse Traction Brake Co., Pittsburg, Pa.
Air Brakes—(See Brakes and Brake Parts).	Ballast Cars—(See Cars, Ballast).	Boiler Cleaning Compounds. Dearborn Drug & Chemical Works, Chicago. Johns-Manville, H. W., Co., New York.	Brakeshoes. American Brake Shoe & Fdry. Co., Mahwah, N. J. American Car Co., St. Louis. Barbour-Stockwell Co., Cambridgeport, Mass. Brill, The J. G., Co., Philadelphia. Kuhlman, The G. C., Car Co., Cleveland. McGuire-Cummings Mfg. Co., Chicago. Mastling, R. W., & Co., 95 Liberty St., New York. St. Louis Car Co., St. Louis, Mo. Standard Brake Shoe Co., Aurora, Ill. Stephenson, John, Co., Elizabeth, N. J. Wason Mfg. Co., Springfield. Wharton, Wm., Jr., & Co., Philadelphia. Wheel Truing Brake Shoe Co., Detroit.
Air Compressors—(See Compressors, Air).	Ball Bearings. Symington, T. H., Co., Baltimore, Md.	Bonds, Rail. Brown, H. P., 120 Liberty St., New York. Chase-Shawmut Co., Newburyport, Mass. Electric Railway Improvement Co., Cleveland, O. Electric Service Supplies Co., 200 Plymouth Bldg., Chicago. General Electric Co., Schenectady, N. Y. Johns-Manville, H. W., Co., New York. Ohio Brass Co., Mansfield, O.	Bridge Timbers. Beidler, Francis, & Co., Chgo.
Alloys and Bearing Metals. Brown, H. P., 120 Liberty St., New York. General Electric Co., Schenectady, N. Y. Lumen Bearing Co., Buffalo, N. Y. Ohio Brass Co., Mansfield, O. St. Louis Car Co., St. Louis, Mo.	Bases—(See Trolley Poles and Fittings).	Brackets and Cross Arms. Anderson, Albert & J. M., Mfg. Co., Boston. Creaghead Engineering Co., Cincinnati, O. Electric Railway Equipment Co., Cincinnati, O. Electric Service Supplies Co., 200 Plymouth Bldg., Chicago. Johns-Manville, H. W., Co., New York, N. Y. Lindsey Bros. Co., Spokane, Wash. Ohio Brass Co., Mansfield, O. Stuart-Howland Co., Boston. Western Electric Co., Chicago.	Brushes, Motor and Dynamo. Electric Service Supplies Co., 200 Plymouth Bldg., Chicago. General Electric Co., Schenectady, N. Y. Speer Carbon Co., St. Marys, Pa.
Aluminum Wire, Etc. Aluminum Co. of America, Pittsburg.	Bearings. Electric Service Supplies Co., 200 Plymouth Bldg., Chicago. General Electric Co., Schenectady, N. Y. Lumen Bearing Co., Buffalo, N. Y. McGuire-Cummings Mfg. Co., Chicago. Marshall, R. W., & Co., 95 Liberty St., New York. Nuttall, R. D., Co., Pittsburg. Ohio Brass Co., Mansfield, O. Symington, T. H., Co., Baltimore, Md. Van Dorn & Dutton Co., Cleveland, O.	Bells and Gongs. American Car Co., St. Louis. Brill, The J. G., Co., Philadelphia. Electric Service Supplies Co., 1929-34 Filbert St., Phila. Kuhlman, The G. C., Car Co., Cleveland. McGuire-Cummings Mfg. Co., Chicago. Ohio Brass Co., Mansfield, O. St. Louis Car Co., St. Louis, Mo. Stephenson, John, Co., Elizabeth, N. J. Wason Mfg. Co., Springfield, Mass. Western Electric Co., Chicago.	
Anchor. Electric Service Supplies Co., 200 Plymouth Bldg., Chicago. Miller Anchor Co., Norwalk, O. Ohio Brass Co., Mansfield, O.	Bells and Gongs. American Car Co., St. Louis. Brill, The J. G., Co., Philadelphia. Electric Service Supplies Co., 1929-34 Filbert St., Phila. Kuhlman, The G. C., Car Co., Cleveland. McGuire-Cummings Mfg. Co., Chicago. Ohio Brass Co., Mansfield, O. St. Louis Car Co., St. Louis, Mo. Stephenson, John, Co., Elizabeth, N. J. Wason Mfg. Co., Springfield, Mass. Western Electric Co., Chicago.	Block System—(See Signals).	
Armatures and Colls, Winding and Reparing. Electric Service Supplies Co., 200 Plymouth Bldg., Chicago. General Electric Co., Schenectady, N. Y. Marshall, R. W., & Co., 95 Liberty St., New York. Stuart-Howland Co., Boston.	Armature Lifts. Electric Service Supplies Co., 200 Plymouth Bldg., Chicago.		
Asbestos Materials. Johns-Manville, H. W., Co., New York.			



Catalog No. 9940—Sectional View.

# STRAIN INSULATORS

## Great Mechanical Strength

is obtained by the cup and cone construction. The metal cup is compressed over the metal cone by hydraulic pressure of approximately 60 tons.

## High Insulation

is secured by a thick layer of mica, solidly compressed between the cup and cone.

## An Outer Casing of "Dirigo"

insulation protects the metal parts from the weather. This casing will not crack, as the cup and cone cannot move relatively to each other.

*Descriptive circular "J" mailed on request.*

Please mention this advertisement.

# THE OHIO BRASS CO.

MANSFIELD, OHIO, U. S. A.

NEW YORK	-	-	-	-	32 Cortlandt Street
CHICAGO	-	-	-	-	508 Fisher Building
ST. LOUIS	-	-	-	-	10 North Fourth Street

Burt Gellatly, 536 Fourth Ave., Pittsburg  
Pierson-Roedig & Co., San Francisco, Los Angeles, Seattle

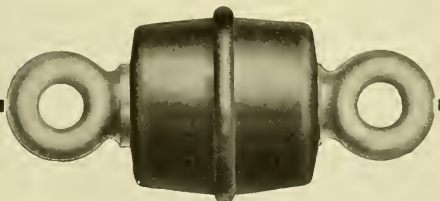

## Rain and Dampness Cannot Short Circuit Electric Lamps



when J-M MOULDED MICA WEATHER-PROOF LAMP SOCKETS are used. They are absolutely weather-proof. In fact, electric lamps will burn continuously and satisfactorily under water in

## J-M MOULDED MICA SOCKETS

They will stand rough handling without breaking or cracking. Are practically indestructible. They possess the highest insulating qualities.

Approved and listed by the Underwriters' National Electric Association.

Write Nearest Branch for Booklet.



## H. W. JOHNS-MANVILLE CO.



NEW YORK  
MILWAUKEE  
CHICAGO  
BOSTON  
PHILADELPHIA  
ST. LOUIS

PITTSBURG  
CLEVELAND  
BUFFALO  
BALTIMORE  
NEW ORLEANS  
KANSAS CITY  
DETROIT

MINNEAPOLIS  
SAN FRANCISCO  
LOS ANGELES  
SEATTLE  
DALLAS  
LONDON 806

## Shawmut Soldered Bond Cap

to make over your  
PLUG BONDS



Why not look this up

## CHASE-SHAWMUT CO.

Newburyport, Mass.

## CLASSIFIED LIST OF ADVERTISERS—Continued.

- Bumpers, Car.**  
American Car Co., St. Louis.  
Brill, The J. G., Co., Philadelphia.  
Kuhlman, The G. C., Car Co., Cleveland.  
St. Louis Car Co., St. Louis, Mo.  
Stephenson, John, Co., Elizabeth, N. J.  
Wason Mfg. Co., Springfield, Mass.
- Car House Doors.**  
Wilson, J. G., Mfg. Co., New York.
- Car Replacers.**  
Electric Service Supplies Co., 200 Plymouth Bldg., Chicago.  
Fairbanks, Morse & Co., Chgo. Kalamazoo Railway Supply Co., Kalamazoo, Mich.  
Ohio Brass Co., Mansfield, O.  
U. S. Metal & Mfg. Co., 25 Broad St., New York.
- Car Seats.**  
American Car Co., St. Louis.  
Brill, The J. G., Co., Philadelphia.  
Hale & Kilburn Mfg. Co., Philadelphia.  
Heywood Bros. & Wakefield Co., Wakefield, Mass.  
Kuhlman, The G. C., Car Co., Cleveland.  
St. Louis Car Co., St. Louis, Mo.  
Stephenson, John, Co., Elizabeth, N. J.  
Wason Mfg. Co., Springfield, Mass.
- Car Signs—(See Signs, Cars and Track).**
- Car Steps.**  
Electric Service Supplies Co., 200 Plymouth Bldg., Chicago.
- Car Trimmings—(See Trimmings, Car).**
- Cars, Ballast.**  
Rodger Ballast Car Co., Chgo. St. Louis Car Co., St. Louis, Mo.
- Cars, Dump.**  
Fairbanks, Morse & Co., Chgo. Rodger Ballast Car Co., Chgo. Russell Car & Snow-Plow Co., Ridgway, Pa.  
St. Louis Car Co., St. Louis, Mo.
- Cars, Passenger and Freight.**  
American Car Co., St. Louis.  
Brill, The J. G., Co., Philadelphia.  
Cincinnati Car Co., Cincinnati.  
Detroit Carbuilding & Equipment Co., Detroit, Mich.  
Electric Railway Improvement Co., Cleveland, O.  
Fairbanks, Morse & Co., Chgo. Lewett Car Co., Newark, O.  
Kuhlman, The G. C., Car Co., Cleveland.  
McGuire-Cummings Mfg. Co., Chicago.  
Niles Car & Mfg. Co., Niles, O.  
Pressed Steel Car Co., Pittsburg.  
Rodger Ballast Car Co., Chgo. Russell Car & Snow-Plow Co., Ridgway, Pa.  
St. Louis Car Co., St. Louis, Mo.  
Standard Motor Truck Co., Pittsburg.  
Stephenson, John, Co., Elizabeth, N. J.  
Wason Mfg. Co., Springfield, Mass.
- Cars, Pay-As-You-Enter.**  
Pay-As-You-Enter Car Co., 26 Cortland St., New York.
- Cars, Rebuilt.**  
Detroit Carbuilding & Equipment Co., Detroit, Mich.
- Cars, Second-Hand.**  
Detroit Carbuilding & Equipment Co., Detroit, Mich.  
Marshall, R. W., & Co., 95 Liberty St., New York.  
Zelnicker, Walter A., Supply Co., St. Louis.
- Cars, Steel.**  
Pressed Steel Car Co., Pittsburg.  
St. Louis Car Co., St. Louis, Mo.  
Standard Motor Truck Co., Pittsburg.
- Castings, Brass.**  
Star Brass Works, Kalamazoo, Mich.
- Castings, Iron and Steel.**  
American Brake Shoe & Foundry Co., Mahwah, N. J.  
Green Engineering Co., Com'l Nat. Bk. Bldg., Chicago.  
National Brake & Electric Co., Milwaukee.  
Standard Steel Works Co., Philadelphia, Pa.  
Washburn Steel Castings & Coupler Co., Minneapolis.
- Catchers—(See Trolley Retriever and Catchers).**
- Cattle Guards.**  
Fairbanks, Morse & Co., Chgo.
- Circuit-Breakers.**  
Electric Service Supplies Co., 200 Plymouth Bldg., Chicago.  
General Electric Co., Schenectady, N. Y.  
Western Electric Co., Chicago.
- Coal Handling Machinery—(See Conveyors).**
- Coils—(See Armatures and Coils).**
- Commutators and Parts.**  
Electric Service Supplies Co., 1020-24 Filbert St., Phila.  
General Electric Co., Schenectady, N. Y.  
Marshall, R. W., & Co., 95 Liberty St., New York.  
Ohio Brass Co., Mansfield, O.  
Stuart-Howland Co., Boston.
- Compressors, Air.**  
Fairbanks, Morse & Co., Chgo. General Electric Co., Schenectady, N. Y.  
National Brake & Electric Co., Milwaukee.  
Westinghouse Traction Brake Co., Pittsburg.
- Concrete Mixers.**  
Contractors' Supply & Equip. Co., Chicago.
- Condensers.**  
Wheeler Condenser & Engineering Co., Carteret, N. J.
- Conduits.**  
Electric Service Supplies Co., 200 Plymouth Bldg., Chicago.  
Western Electric Co., Chicago.
- Connectors, Solderless.**  
Dossert & Co., 242 W. Forty-first St., New York.
- Contractors.**  
Arnold Company, 181 La Salle St., Chicago.  
Bylesby, H. M., Co., Am. Trust Bldg., Chicago.  
Columbia Construction Co., Milwaukee, Wis.  
Creaghead Engineering Co., Cincinnati, O.  
Green Engineering Co., Com'l Nat. Bk. Bldg., Chicago.  
Register, A. L. & Co., 112 N. Broad St., Philadelphia.  
Sanderson & Porter, 52 William St., New York.  
Saxton, E., 841 Bladensburg R., Washington, D. C.  
Sheaff & Jaastad, 88 Broad St., Boston.  
Stone & Webster Engineering Corporation, Boston.  
Wharton, Wm., Jr., & Co., Philadelphia.  
White, J. G., & Co., 49 Exchange Pl., New York.
- Controllers and Attachments.**  
Electric Service Supplies Co., 200 Plymouth Bldg., Chicago.  
General Electric Co., Schenectady, N. Y.  
Johns-Manville, H. W., Co., New York.  
Marshall, R. W., & Co., 95 Liberty St., New York.  
Western Electric Co., Chicago.  
Westinghouse Electric & Mfg. Co., Pittsburg.
- Conveyors and Coal Handling Machinery.**  
Green Engineering Co., Com'l Nat. Bk. Bldg., Chicago.  
Northern Engineering Works, Detroit, Mich.
- Cord, Bell and Trolley.**  
American Car Co., St. Louis.  
Brill, The J. G., Co., Philadelphia.  
Electric Service Supplies Co., 1020-24 Filbert St., Phila.  
Kuhlman, The G. C., Car Co., Cleveland.  
St. Louis Car Co., St. Louis, Mo.  
Stephenson, John, Co., Elizabeth, N. J.  
Stuart-Howland Co., Boston.  
Wason Mfg. Co., Springfield, Mass.
- Couplers, Car.**  
American Car Co., St. Louis.  
Brill, The J. G., Co., Philadelphia.  
Kuhlman, The G. C., Car Co., Cleveland.  
McGuire-Cummings Mfg. Co., Chicago.  
Ohio Brass Co., Mansfield, O.  
St. Louis Car Co., St. Louis, Mo.  
Stephenson, John, Co., Elizabeth, N. J.  
Van Dorn, W. T. Co., Paulina St., Chicago.  
Washburn Steel Castings & Coupler Co., Minneapolis.  
Wason Mfg. Co., Springfield, Mass.
- Couplers, American Car Co., St. Louis.**  
Brill, The J. G., Co., Philadelphia.  
Kuhlman, The G. C., Car Co., Cleveland.  
McGuire-Cummings Mfg. Co., Chicago.  
Ohio Brass Co., Mansfield, O.  
St. Louis Car Co., St. Louis, Mo.  
Stephenson, John, Co., Elizabeth, N. J.  
Van Dorn, W. T. Co., Paulina St., Chicago.  
Washburn Steel Castings & Coupler Co., Minneapolis.  
Wason Mfg. Co., Springfield, Mass.
- Coverings, Pipe and Boiler.**  
Johns-Manville, H. W., Co., New York.
- Cranes, Hoists and Lifts.**  
American Car Co., St. Louis.  
Brill, The J. G., Co., Philadelphia.  
Brown Hoisting Machinery Co., Cleveland, O.  
Kuhlman, The G. C., Car Co., Cleveland.  
Northern Engineering Works, Detroit, Mich.  
Railway Specialty & Supply Co., Chicago.  
Stephenson, John, Co., Elizabeth, N. J.  
Van Dorn & Dutton Co., Cleveland, O.  
Wason Mfg. Co., Springfield, Mass.
- Cross Arms—(See Brackets and Cross Arms).**
- Crossing Gates—(See Gates and Guards).**
- Crossings, Track—(See Switches, Frogs and Crossings).**
- Curtaine, Fixtures and Materials.**  
American Car Co., St. Louis.  
Brill, The J. G., Co., Philadelphia.  
Curtain Supply Co., 93 Ohio St., Chicago.  
Electric Service Supplies Co., 200 Plymouth Bldg., Chicago.  
Hartshorn Co., Stewart, East Newark, N. J.  
Kuhlman, The G. C., Car Co., Cleveland.  
Marshall, R. W., & Co., 95 Liberty St., New York.  
National Lock Washer Co., Newark, N. J.  
Pantassote Co., 11 Broadway, New York.  
St. Louis Car Co., St. Louis, Mo.  
Stephenson, John, Co., Elizabeth, N. J.  
Wason Mfg. Co., Springfield, Mass.
- Cylinder Oil.**  
Power Specialty Co., 111 Broadway, N. Y.
- Derailing Devices.**  
American Frog & Switch Co., Hamilton, O.  
Cleveland Frog & Crossing Co., Cleveland, O.
- Doors and Fixtures.**  
American Car Co., St. Louis.  
Brill, The J. G., Co., Philadelphia.  
Kuhlman, The G. C., Car Co., Cleveland.  
St. Louis Car Co., St. Louis, Mo.  
Stephenson, John, Co., Elizabeth, N. J.  
Wason Mfg. Co., Springfield, Mass.
- Doors, Steel Rolling.**  
Wilson, J. G., Mfg. Co., New York.
- Draft, Mechanical—(See Mechanical Draft).**
- Draft Rigging.**  
Van Dorn, W. T. Co., Chgo. Washburn Steel Castings & Coupler Co., Minneapolis.
- Drills, Track.**  
Brown, H. P., 120 Liberty St., New York.  
Electric Service Supplies Co., 200 Plymouth Bldg., Chicago.  
Fairbanks, Morse & Co., Chgo. Kalamazoo Railway Supply Co., Kalamazoo, Mich.  
Marshall, R. W., & Co., 95 Liberty St., New York.
- Dynamos and Generators.**  
Fairbanks, Morse & Co., Chgo. General Electric Co., Schenectady, N. Y.  
National Brake & Electric Co., Milwaukee, Wis.  
Western Electric Co., Chicago.  
Westinghouse Electric & Mfg. Co., Pittsburg, Pa.
- Electrical Instruments.**  
Electric Service Supplies Co., 200 Plymouth Bldg., Chicago.  
General Electric Co., Schenectady, N. Y.  
Johns-Manville, H. W., Co., New York.  
Queen & Co., Philadelphia.  
Western Electric Co., Chicago.  
Westinghouse Electric & Mfg. Co., Pittsburg, Pa.  
Weston Electrical Instrument Co., Newark, N. J.
- Electric Railway Supplies, General.**  
Creaghead Engineering Co., Cincinnati, O.  
Electric Service Supplies Co., 200 Plymouth Bldg., Chicago.  
Fairbanks, Morse & Co., Chgo. General Electric Co., Schenectady, N. Y.  
Johns-Manville, H. W., Co., New York.  
Marshall, R. W., & Co., 95 Liberty St., New York.  
Ohio Brass Co., Mansfield, O.  
Stuart-Howland Co., Boston.  
Western Electric Co., Chicago.
- Engineers and Contractors.**  
Auld Company, Chicago.  
Bylesby, H. M., & Co., Chgo. Columbia Construction Co., Milwaukee, Wis.  
Ford, Bacon & Davis, New York.  
Register, A. L. & Co., Philadelphia.  
Sanderson & Porter, New York.  
Saxton, E., Washington, D. C.  
Sheaff & Jaastad, Boston.  
Stone & Webster Engineering Corporation, Boston.  
White, J. G., & Co., New York.
- Engines, Gas and Oil.**  
Buckeye Engine Co., Salem, O.  
Fairbanks, Morse & Co., Chgo. Westinghouse Machine Co., Pittsburg.
- Engines, Hoisting.**  
Fairbanks, Morse & Co., Chgo.
- Engines, Steam.**  
Buckeye Engine Co., Salem, O.  
Westinghouse Machine Co., Pittsburg.
- Fans, Exhaust and Ventilating.**  
General Electric Co., Schenectady, N. Y.  
Western Electric Co., Chicago.  
Westinghouse Elec. & Mfg. Co., Pittsburg.
- Fare Boxes—(See Electric Railway Supplies).**
- Fare Registers and Register Fixtures.**  
Electric Service Supplies Co., 200 Plymouth Bldg., Chicago.  
Rooke Automatic Register Co., Providence, R. I.
- Feedwater Apparatus.**  
Wheeler Condenser & Engineering Co., Carteret, N. J.
- Feed Wire—(See Wire and Cables).**

# ST. LOUIS CAR CO. ST. LOUIS-MO.



## St. Louis Car Company's Semi-Convertible Type

The illustration represents one of the cars recently shipped by us to the Houston Electric Company, Houston, Texas.

These cars are of our own design—a practically perfect Semi-Convertible type. Both lower and upper sashes raise into the roof. They move easily and when in the roof pockets are securely fastened, with no possible danger of falling and injuring passengers.

### Our construction of the Semi-Convertible Car is the very best that has yet been devised

These Houston cars are 28' over corner posts and 31' 6" over all. Width over arm rail, 8' 6". They are finished with very handsomely figured mahogany, provided with curtains at each window and each door opening and have the St. Louis Car Company's latest improved "Walkover" seat.

The cars are mounted on St. Louis Car Company's No. 47 Short Wheel Base Truck, which has been adopted as standard in a great many of the larger cities. The channel-iron and steel construction of the "Robertson type" permits the arm rail of the car to be placed very low and adds much to the appearance.

*Photographs, Blue Prints and Specifications will be mailed upon request.*

## CLASSIFIED LIST OF ADVERTISERS—Continued.

- Fenders and Guards.**  
Consolidated Car Fender Co., Providence, R. I.  
Eclipse Railway Supply Co., Cleveland, O.  
Electric Service Supplies Co., 1020-24 Filbert St., Phila.  
McGuire-Cummings Mfg. Co., Chicago.  
Marshall, R. W., & Co., 95 Liberty St., New York.
- Flangers, Snow.**  
Kalamazoo Railway Supply Co., Kalamazoo, Mich.  
McGuire-Cummings Mfg. Co., Chicago.  
Ohio Brass Co., Mansfield, O.  
Van Dorn & Dutton Co., Cleveland, O.
- Frogs—(See Switches, Frogs and Crossings).**
- Fuel Economizers—(See Economizers, Fuel).**
- Fuses and Fuse Devices.**  
Chase-Shawmut Co., Newburyport, Mass.  
Electric Service Supplies Co., 200 Plymouth Bldg., Chicago.  
General Electric Co., Schenectady, N. Y.  
Johns-Manville, H. W., Co., New York.  
Western Electric Co., Chicago.  
Westinghouse Elec. & Manufacturing Co., Pittsburg.
- Gaskets, Bronze.**  
Power Specialty Co., 111 Broadway, New York.
- Gates and Guards.**  
Kalamazoo Railway Supply Co., Kalamazoo, Mich.
- Gear Cases.**  
Electric Service Supplies Co., 200 Plymouth Bldg., Chicago.  
General Electric Co., Schenectady, N. Y.  
Marshall, R. W., & Co., 95 Liberty St., New York.
- Gears and Pinions.**  
Atha Steel Casting Co., Newark, N. J.  
Electric Service Supplies Co., 200 Plymouth Bldg., Chicago.  
General Electric Co., Schenectady, N. Y.  
Marshall, R. W., & Co., 95 Liberty St., New York.  
Nuttall, R. D., Co., Pittsburg.  
Van Dorn & Dutton Co., Cleveland, O.
- Generators—(See Dynamos).**
- Gongs—(See Bells and Gongs).**
- Graphite Paint—(See Paint).**
- Grates, Chain.**  
Green Engineering Co., Com'l Nat. Bk. Bldg., Chicago.
- Grease—(See Lubricants).**
- Grinders.**  
Brown, Harold P., 120 Liberty St., New York.
- Ground Connection Clamps.**  
Chase-Shawmut Co., Newburyport, Mass.
- Guy Anchors—(See Anchors).**
- Harps, Trolley—(See Trolley Poles and Fittings).**
- Headlights.**  
Electric Service Supplies Co., 200 Plymouth Bldg., Chicago.  
Fairbanks, Morse & Co., Chgo.  
General Electric Co., Schenectady, N. Y.  
St. Louis Car Co., St. Louis, Mo.  
Stuart-Howland Co., Boston.  
Trolley Supply Co., Canton, O.
- Heaters, Car, Electric.**  
Consolidated Car-Heating Co., Albany, N. Y.  
Johns-Manville, H. W., Co., New York.
- Heaters, Car, Hot Water, and Stoves.**  
Baker, The Wm. C., Heating & Sup. Co., New York.  
Chicago-Cummings Mfg. Co., Chicago.  
Smith, Peter, Heater Co., Detroit, Mich.
- Heating and Ventilating Apparatus—(See Mech. Draft).**
- Hoists—(See Cranes, Hoists and Lifts).**
- Hose Bridges.**  
Ohio Brass Co., Mansfield, O.
- Hydraulic Machinery.**  
Watson-Stillman Co., 26 Cortlandt St., New York.
- Inspection.**  
Central Inspection Bureau.
- Inspection Cars, Gasoline.**  
Stover Motor Car Co., Freeport, Ill.
- Instruments, Measuring and Testing—(See Electrical Instruments).**
- Insulating Tapes.**  
General Electric Co., Schenectady, N. Y.  
Johns-Manville, H. W., Co., New York, N. Y.  
Okonite Co., Ltd., 253 Broadway, New York.  
Western Electric Co., Chicago.
- Insulations and Insulating Material.**  
Anderson, A. & J. M., Mfg. Co., Boston.  
Creaghead Engineering Co., Cincinnati, O.  
Electric Railway Equipment Co., Cincinnati, O.  
Electric Service Supplies Co., 200 Plymouth Bldg., Chicago.  
General Electric Co., Schenectady, N. Y.  
Johns-Manville, H. W., Co., New York.  
Macallen, The Co., Boston.  
Ohio Brass Co., Mansfield, O.  
Okonite Co., Ltd., 253 Broadway, New York.  
Standard Paint Co., 100 William St., New York.  
Stuart-Howland Co., Boston.  
Western Electric Co., Chicago.
- Jacks.**  
American Car Co., St. Louis.  
Brill, The J. G., Co., Philadelphia.  
Electric Service Supplies Co., 200 Plymouth Bldg., Chicago.  
Fairbanks, Morse & Co., Chgo.  
Kalamazoo Railway Supply Co., Kalamazoo, Mich.  
Kuhlman, The G. C., Car Co., Cleveland.  
Marshall, R. W., & Co., 95 Liberty St., New York.  
Morden Frog & Crossing Co., Chicago.  
Stephenson, John, Co., Elizabeth, N. J.  
Wason Mfg. Co., Springfield, Mass.  
Watson-Stillman Co., 26 Cortlandt St., New York.
- Joints, Expansion—(See Steam Fittings).**
- Joints, Rail.**  
Rail Joint Co., 29 W. 34th St., New York.
- Joints, Welded—(See Rail Joints, Welded).**
- Journal Boxes.**  
American Car Co., St. Louis.  
Brill, The J. G., Co., Philadelphia.  
Kuhlman, The G. C., Car Co., Cleveland.  
McGuire-Cummings Mfg. Co., Chicago.  
St. Louis Car Co., St. Louis, Mo.  
Stephenson, John, Co., Elizabeth, N. J.  
Symington, T. H., Co., Baltimore, Md.  
Wason Mfg. Co., Springfield, Mass.
- Journal Lubricators—(See Lubricants).**
- Journal Packing, Steel Wool.**  
Robertson, Wm., & Co., Fifth Floor Great Northern Bldg., Chicago.
- Lamps, Arc and Incandescent.**  
Anderson, A. & J. M., Mfg. Co., Boston.  
Electric Service Supplies Co., 200 Plymouth Bldg., Chicago.  
General Electric Co., Schenectady, N. Y.  
Stuart-Howland Co., Boston.  
Western Electric Co., Chicago.  
Westinghouse Elec. & Mfg. Co., Pittsburg, Pa.
- Lamp Sockets.**  
Electric Service Supplies Co., 200 Plymouth Bldg., Chicago.  
General Electric Co., Schenectady, N. Y.  
Johns-Manville, H. W., Co., New York, N. Y.
- Lantern Globes.**  
Railway Specialty & Supply Co., Chicago.
- Lifts—(See Cranes, Hoist and Lift).**
- Lightning Arresters.**  
Electric Service Supplies Co., 200 Plymouth Bldg., Chicago.  
General Electric Co., Schenectady, N. Y.  
Stuart-Howland Co., Boston.  
Western Electric Co., Chicago.  
Westinghouse Elec. & Manufacturing Co., Pittsburg.
- Line Material.**  
Anderson, A. & J. M., Mfg. Co., Boston.  
Creaghead Engineering Co., Cincinnati, O.  
Johns-Manville, H. W., Co., New York.  
Electric Ry. Equipment Co., Cincinnati, O.  
Electric Service Supplies Co., 200 Plymouth Bldg., Chicago.  
General Electric Co., Schenectady, N. Y.  
Macallen, The Co., Boston.  
Marshall, R. W., & Co., 95 Liberty St., New York.  
Stuart-Howland Co., Boston.  
Western Electric Co., Chicago.
- Lock and Nut Washers.**  
National Lock Washer Co., Newark, N. J.
- Lockers, Metal.**  
Electric Service Supplies Co., 200 Plymouth Bldg., Chicago.
- Locomotives.**  
Baldwin Locomotive Works, Philadelphia.  
Locomotives, Electric.  
American Car Co., St. Louis.  
Baldwin Locomotive Works, Philadelphia.  
Brill, The J. G., Co., Philadelphia.  
General Electric Co., Schenectady, N. Y.  
Kuhlman, The G. C., Car Co., Cleveland.  
McGuire-Cummings Mfg. Co., Chicago.  
Stephenson, John, Co., Elizabeth, N. J.  
Wason Mfg. Co., Springfield, Mass.  
Westinghouse Elec. & Manufacturing Co., Pittsburg.
- Locomotives, Gasoline.**  
Fairbanks, Morse & Co., Chgo.  
Stover Motor Car Co., Freeport, Ill.
- Lubricants.**  
Dearborn Drug & Chemical Works, Chicago.  
Galena-Signal Oil Co., Franklin, Pa.  
Whitmore Mfg. Co., Cleveland, O.
- Lumber.**  
Advance Lumber Co., Cleveland, O.  
Barnes, G. H., Hardwood Lumber Co., St. Louis, Mo.  
Belder, Francis, & Co., Chgo.  
Berthold & Jennings, St. Louis.  
Lindley Bros. Co., Spokane, Wash.  
S-E. Missouri Cypress Co., Campbell, Mo.
- Malleable Iron.**  
St. Louis Car Co., St. Louis, Mo.
- Measuring Tapes.**  
Lufkin Rule Co., Saginaw, Mich.
- Meters.**  
Johns-Manville, H. W., Co., New York.  
Queen & Co., Philadelphia.  
Weston Electrical Instrument Co., Newark, N. J.
- Mica, Raw and Manufactured.**  
Chicago Mica Co., Valparaiso, Ind.
- Motor Cars, Gasoline.**  
Stover Motor Car Co., Freeport, Ill.
- Motors, Electric.**  
Fairbanks, Morse & Co., Chgo.  
General Electric Co., Schenectady, N. Y.  
National Brake & Electric Co., Milwaukee.  
Western Electric Co., Chicago.  
Westinghouse Elec. & Manufacturing Co., Pittsburg.
- Nut Locks.**  
Chase-Shawmut Co., Newburyport, Mass.  
National Lock Washer Co., Newark, N. J.  
Railway Specialty & Supply Co., Chicago.  
St. Louis Car Co., St. Louis, Mo.  
U. S. Metal & Mfg. Co., 25 Broad St., New York.
- Nuts and Bolts.**  
National Lock Washer Co., Newark, N. J.  
Railway Specialty & Supply Co., Chicago.
- Oilers.**  
Armstrong Oiler Co., 31st and Chestnut St., Philadelphia.
- Oils—(See Lubricants).**
- Overhead Equipment—(See Electric Railway Supplies).**
- Packings.**  
Electric Service Supplies Co., 200 Plymouth Bldg., Chicago.  
Johns-Manville, H. W., Co., New York.  
Power Specialty Co., 111 Broadway, New York.
- Packing, Steel Wool Journal.**  
Robertson, Wm., & Co., Fifth Floor Great Northern Bldg., Chicago.
- Paints.**  
Standard Paint Co., 100 William St., New York.
- Pay-As-You-Enter Cars.**  
Pay-As-You-Enter Car Co., 26 Cortlandt St., New York.
- Pipe Bands and Fittings—(See Steam Fittings).**
- Poles, Metal.**  
Creaghead Engineering Co., Cincinnati, O.  
Electric Railway Equipment Co., Cincinnati, O.  
Electric Service Supplies Co., 200 Plymouth Bldg., Chicago.
- Poles and Ties, Wood.**  
Advance Lumber Co., Cleveland, O.  
Barnes, G. H., Hardwood Lumber Co., St. Louis, Mo.  
Belder, Francis, & Co., Chgo.  
Berthold & Jennings, St. Louis.  
Churchill Cedar Co., Spokane, Wash.  
Humbird Lumber Co., Sand Point, Idaho.  
Lindley Bros. Co., Spokane, Wash.  
National Pole Co., Escanaba, Mich.  
Nauv Pole & Tie Co., 226 La Salle St., Chicago.  
Pacific Coast Pole Co., Spokane, Wash.  
S-E. Missouri Cypress Co., Campbell, Mo.  
Worcester, C. H., Co., Tribune Bldg., Chicago.
- Promoters of Railway Projects.**  
Shimer & Chase Co., Omaha, Neb.
- Punches—(See Ticket Punches).**
- Rail Benders.**  
Electric Service Supplies Co., 200 Plymouth Bldg., Chicago.  
Fairbanks, Morse & Co., Chgo.



Until the invention of the

# Pay-As-You-Enter Car

no important improvement had been made in handling street railway passengers since the first horse car jogged along down the street in the middle of the last century.

Think of it! In all these years improvement after improvement was made in power, in equipment, in track and roadway, but the same old collect-on-suspicion method of handling passengers prevailed.

And how easy and simple is this Pay-As-You-Enter plan! Merely a practical adaptation to street car limitations of the businesslike method followed for years by other kinds of transportation which require passengers to pay in advance.



The Pay-As-You-Enter plan means larger revenue, greater safety, better service. Montreal, Chicago, New York, Buffalo and Newark have fully demonstrated its value.



We license manufacturers and railways to build and use the Pay-As-You-Enter Car, the patents on which are owned by

## The Pay-As-You-Enter Car Company

DUNCAN McDONALD  
President

50 Church Street, New York

THOS. W. CASEY  
Manager

## CLASSIFIED LIST OF ADVERTISERS—Continued.

- Rail Bonds—(See Bonds, Rail).
- Rail Bonds, Flexible.  
Chase-Shawmut Co., Newburyport, Mass.
- Rail Drills—(See Drills, Track).
- Rail Feed Wire—(See Wire and Cables).
- Rail Joints and Chairs—(See Joints, Rail).
- Rails, New.  
New York Switch & Crossing Co., Hoboken, N. J.  
Wharton, Wm., Jr., & Co., Philadelphia.
- Rails, Relaying.  
Zelnicke, Walter A., Supply Co., St. Louis.
- Railway Velocipedes.  
Fairbanks Morse & Co., Chgo.  
Kalamazoo Railway Supply Co., Kalamazoo, Mich.
- Registers and Fittings—(See Fare Registers).
- Relays.  
Weston Electrical Instrument Co., Newark, N. J.
- Roofing.  
Johns-Manville, H. W., Co., New York.
- Sand Apparatus.  
American Car Co., St. Louis.  
Brill, The J. G., Co., Philadelphia.  
Electric Service Supplies Co., 200 Plymouth Bldg., Chicago.  
Kuhlman, The G. C., Car Co., Cleveland.  
Marshall, R. W., & Co., 95 Liberty St., New York.  
Ohio Brass Co., Mansfield, O.  
St. Louis Car Co., St. Louis, Mo.  
Stephenson, John, Co., Elizabeth, N. J.  
Wason Mfg. Co., Springfield, Mass.
- Sash Balances and Fixtures.  
National Lock Washer Co., Newark, N. J.
- Sash Operating Devices.  
Drouvé, The G., Co., Bridgeport, Conn.  
Lord & Burnham, Irvington-Hudson, New York.
- Seats, Car—(See Car Seats).
- Shade Rollers—(See Curtains, Fixtures and Materials).
- Signals.  
Telegraph Signal Co., Rochester, N. Y.
- Signal Supplies.  
Railway Specialty & Supply Co., Chicago.
- Skylights.  
Drouvé, The G., Co., Bridgeport, Conn.  
Lord & Burnham, Irvington-Hudson, New York.
- Snow Plows, Sweepers and Scrapers.  
American Car Co., St. Louis.  
Brill, The J. G., Co., Philadelphia.  
Kuhlman, The G. C., Car Co., Cleveland.  
McGuire-Cummings Mfg. Co., Chicago.  
Russell Car & Snow-Plow Co., Ridgway, Pa.  
Stephenson, John, Co., Elizabeth, N. J.  
Wason Mfg. Co., Springfield, Mass.
- Sockets, Waterproof.  
Johns-Manville, H. W., Co., New York.
- Solder Paste.  
Chase-Shawmut Co., Newburyport, Mass.
- Springs.  
American Car Co., St. Louis.  
Brill, The J. G., Co., Philadelphia.  
Kuhlman, The G. C., Car Co., Cleveland.  
McGuire-Cummings Mfg. Co., Chicago.
- Stokers.  
Babcock & Wilcox Co., 85 Liberty St., New York.  
Green Engineering Co., Com'l Nat. Bk. Bldg., Chicago.  
Model Stoker Co., Dayton, O.  
Westinghouse Machine Co., Pittsburg.
- Storage Batteries—(See Batteries).
- Superheaters.  
Power Specialty Co., 111 Broadway, New York.
- Switches, Frogs and Crossings.  
American Frog & Switch Co., Hamilton, O.  
Barbour-Stockwell Co., Cambridgeport, Mass.  
Cleveland Frog & Crossing Co., Cleveland, O.  
Fairbanks, Morse & Co., Chgo.  
Morden Frog & Crossing Co., Rookery, Chicago.  
New York Switch & Crossing Co., Hoboken, N. J.  
Railway Specialty & Supply Co., Chicago.  
Wharton, Wm., Jr., & Co., Philadelphia.
- Switchboards and Switchboard Instruments.  
Anderson, A. & J. M., Mfg. Co., Boston.  
Chase-Shawmut Co., Newburyport, Mass.  
General Electric Co., Schenectady, N. Y.  
Western Electric Co., Chicago.  
Westinghouse Electric & Mfg. Co., Pittsburg.  
Weston Electrical Instrument Co., Newark, N. J.
- Tapes and Webbing.  
Johns-Manville, H. W., Co., New York.  
Okonite Co., Ltd., 253 Broadway, New York.
- Testing Instruments.  
Queen & Co., Philadelphia.  
Weston Electrical Instrument Co., Newark, N. J.
- Test Lamps, Pocket.  
Chase-Shawmut Co., Newburyport, Mass.
- Ticket Choppers and Destroyers.  
Patten, Paul B., Salem, Mass.
- Ticket Punches.  
Meyers, Fred J., Mfg. Co., Hamilton, O.  
Woodman Mfg. & Sup. Co., Boston.
- Ties and Poles, Wood—(See Poles and Ties).
- Timber.  
Beidler, Francis, & Co., Chgo.  
Lindsay Bros. Co., Spokane, Wash.  
S-E. Missouri Cypress Co., Campbell, Mo.
- Tools, Pneumatic—(See Pneumatic Tools).
- Track Cleaners and Scrapers.  
American Car Co., St. Louis.  
Brill, The J. G., Co., Philadelphia.  
Kalamazoo Railway Supply Co., Kalamazoo, Mich.  
Kuhlman, The G. C., Car Co., Cleveland.  
McGuire-Cummings Mfg. Co., Chicago.  
Stephenson, John, Co., Elizabeth, N. J.  
Wason Mfg. Co., Springfield, Mass.
- Track Drills—(See Drills, Track).
- Tracklaying Machinery.  
Holman, D. F., Ry. Tracklayer Co., 1102 Ellsworth Bldg., Chicago.
- Track Tools.  
Electric Service Supplies Co., 200 Plymouth Bldg., Chicago.  
Kalamazoo Railway Supply Co., Kalamazoo, Mich.
- Trimmings, Car.  
American Car Co., St. Louis.  
Brill, The J. G., Co., Philadelphia.  
Curtain Supply Co., Park Row Bldg., New York.  
Kuhlman, The G. C., Car Co., Cleveland.  
National Lock Washer Co., Newark, N. J.  
St. Louis Car Co., St. Louis, Mo.  
Stephenson, John, Co., Elizabeth, N. J.  
Wason Mfg. Co., Springfield, Mass.
- Trolley Guards.  
Automatic Trolley Guard Co., 331 Elliott Sq., Buffalo, N. Y.  
Electric Service Supplies Co., 200 Plymouth Bldg., Chicago.
- Trolley Poles and Fittings.  
Garford Company, Elyria, O.  
General Electric Co., Schenectady, N. Y.  
Johns-Manville, H. W., Co., New York.  
Marshall, R. W., & Co., 95 Liberty St., New York.  
Milloy Electric Co., Bucyrus, O.  
Nuttall, R. D., Co., Pittsburg.  
Star Brass Works, Kalamazoo, Mich.  
Trolley Supply Co., Canton, O.  
Westinghouse Electric & Mfg. Co., Pittsburg, Pa.
- Trolley Retrievers and Catchers.  
Electric Service Supplies Co., 1020-24 Filbert St., Phila.  
Milloy Electric Co., Bucyrus, O.  
Trolley Supply Co., Canton, O.
- Trolley Wagons.  
Kalamazoo Railway Supply Co., Kalamazoo, Mich.
- Trolley Wheels—(See Trolley Poles and Fittings).
- Trolley Wire—(See Wire and Cables).
- Trucks, Car.  
American Car Co., St. Louis.  
Baldwin Locomotive Works, Philadelphia.  
Brill, The J. G., Co., Philadelphia.
- Trucks, Car—Continued.  
Kuhlman, The G. C., Car Co., Cleveland.  
McGuire-Cummings Mfg. Co., Chicago.  
St. Louis Car Co., St. Louis, Mo.  
Standard Motor Truck Co., Pittsburg, Pa.  
Stephenson, John, Co., Elizabeth, N. J.  
Van Dorn & Dutton Co., Cleveland, O.  
Wason Mfg. Co., Springfield, Mass.
- Turbines.  
General Electric Co., Schenectady, N. Y.  
Westinghouse Machine Co., Pittsburg, Pa.
- Valves—(See Steam Fittings).
- Varnish.  
Electric Service Supplies Co., 200 Plymouth Bldg., Chicago.  
Standard Paint Co., 100 William St., New York.
- Ventilators.  
Drouvé, The G., Co., Bridgeport, Conn.  
Lord & Burnham, Irvington-Hudson, New York.
- Vestiettes.  
Bellamy Vestiette Mfg. Co., Cleveland, O.
- Waste, Cotton and Wool.  
Hagy J. Milton, Waste Wks., Philadelphia, Pa.  
Railway Specialty & Supply Co., Chicago.
- Water Softening Compounds.  
Dearborn Drug & Chemical Works, Chicago.
- Wheels and Axles.  
American Car Co., St. Louis.  
Brill, The J. G., Co., Philadelphia.  
Griffin Wheel Co., Chicago.  
Kuhlman, The G. C., Car Co., Cleveland.  
McGuire-Cummings Mfg. Co., Chicago.  
Marshall, R. W., & Co., 95 Liberty St., New York.  
Railway Steel-Spring Co., New York.  
St. Louis Car Co., St. Louis, Mo.  
St. Louis Car Wheel Co., St. Louis, Mo.  
Standard Steel Works Co., Philadelphia, Pa.  
Stephenson, John, Co., Elizabeth, N. J.  
Wason Mfg. Co., Springfield, Mass.
- Wheel Grinders.  
Whiting Brake Shoe Co., Detroit, Mich.
- Window Fixtures.  
Drouvé, The G., Co., Bridgeport, Conn.
- Wiping Rags.  
Hagy J. Milton, Waste Wks., Philadelphia, Pa.
- Wire, Aluminum.  
Aluminum Co. of America, Pittsburg, Pa.
- Wire, Insulated.  
Aluminum Co. of America, Pittsburg, Pa.  
American Electrical Works, Providence, R. I.  
General Electric Co., Schenectady, N. Y.  
Okonite Co., Ltd., 253 Broadway, New York.  
Standard Underground Cable Co., Pittsburg, Pa.  
Stuart-Howland Co., Boston.
- Wire and Cables.  
Aluminum Co. of America, Pittsburg, Pa.  
American Electrical Works, Providence, R. I.  
Bridgeport Brass Co., Bridgeport, Conn.  
General Electric Co., Schenectady, N. Y.  
Okonite Co., Ltd., 253 Broadway, New York.  
Standard Underground Cable Co., Pittsburg, Pa.

# A Portable Bonding Car

that will save a sum equal to its cost in six months' work. It does perfect bonding and rebonding by modern methods—

## Electric Brazing AND Copper Welding





*Our definition of perfect bonding is:*

An amalgamation of rail and bond possessing greatest conductivity and longest life, produced at least cost.

*May we tell you more bonding facts?*

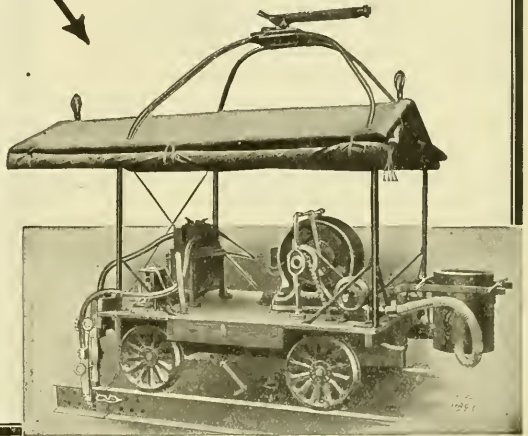
**THE ELECTRIC RAILWAY  
IMPROVEMENT COMPANY**  
6005 Carnegie Ave. - - - CLEVELAND, OHIO  
12

**SPEER  
HIGH GRADE  
BRUSH**  
ST. MARYS - PA.

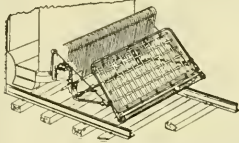

**ECLIPSE  
Life Guard**  
Manufactured by the  
ECLIPSE RAILWAY SUPPLY CO.  
Cleveland, Ohio



**TROLLEY WIRE, BARE COPPER CABLES  
WEATHERPROOF WIRE AND CABLES**  
RUBBER COVERED CABLES AND LEAD COVERED UNDERGROUND CABLES  
FOR ANY SERVICE. WRITE US FOR SPECIAL PRICES AT THIS TIME  
**STANDARD UNDERGROUND CABLE CO.**  
Pittsburg New York Boston St. Louis San Francisco Chicago  
Philadelphia Los Angeles Atlanta

In the **IDEAL TROLLEY WHEEL** we have reduced electrical resistance to a minimum and eliminated the steel flange as part of the circuit.  
Plenty of other superior points about the Ideal. Write us.  
Buffalo **LUMEN BEARING CO.** Toronto

**“The Oasis in the Desert of Waste”**  
**Motor Packing Waste**  
No dirt or grit  
All long strands and satisfaction  
**The J. Milton Hagy Waste Works**  
433 Spruce Street, Philadelphia  
3

**ALUMINUM**  
**Railway Feeders**  
**And all kinds of Electrical Conductors**  
Aluminum Feeders are less than one-half the weight of copper feeders and are of equal conductivity and strength. If insulated wire or cable is required, high grade insulation is guaranteed.  
*Write for prices and full information.*  
**Aluminum Company of America**  
PITTSBURGH, PA.  
Formerly The Pittsburgh Reduction Company

A skylight without cement  
or putty that keeps out all  
rain and dust permanently

—that's the

## Anti-Pluvius Skylight

—lets in all the light, too.

The unit form of construction makes erection economical. We will erect large or small skylights for any electric railway anywhere in America, or furnish the material ready for erection with complete instructions.

There's economy and good service in every square foot of **Anti-Pluvius Skylight**—made only by

**The G. Drouvé Co.**

Bridgeport, Conn., U. S. A.

Western Office: 40 Dearborn Street, Chicago

5

# HEINE<sup>WATER</sup><sub>TUBE</sub> BOILERS

deliver the greatest quantity of dry steam for each pound of fuel burned.

That means Heine Water Tube Boilers are most economical in the use of fuel.

Our book, "*Boiler Logic*," tells how and why this is true.

A complimentary copy is yours for the asking.

**HEINE SAFETY BOILER CO.**

421 Olive St., ST. LOUIS, MO.

3

## THE BABCOCK & WILCOX COMPANY

85 Liberty Street, New York

Babcock & Wilcox — Stirling — A & T Horizontal — Cahall Vertical

# WATER TUBE STEAM BOILERS

STEAM SUPERHEATERS

Works: Bayonne, N. J. Barberton, Ohio.

MECHANICAL STOKERS

BRANCH OFFICES:

BOSTON, Delta Bldg.  
PHILADELPHIA, 110-112 North American Bldg.  
SAN FRANCISCO, 63 First Street  
PITTSBURGH, Farmers Deposit Nat. Bank Bldg.  
NEW ORLEANS, 343 Baronne St.

DENVER, 410 Seventeenth St.  
SALT LAKE CITY, 313 Atlas Block  
WASHINGTON, Colorado Building  
CHICAGO, Marquette Bldg.  
ATLANTA, GA., 1132 Candler Bldg.

CLEVELAND, 706 New England Bldg.  
MEXICO CITY, 7 Avenida, Juarez  
HAVANA, CUBA, 116 1/2 Calle de la Habana  
LOS ANGELES, 321 Trust Bldg.  
CINCINNATI, O., Traction Bldg.

**Mica**  
**Prices**  
**Reduced**

Compare our prices on Raw Mica and Manufactured Mica with prices you have been paying our competitors

**WHY PAY FANCY PRICES?**

Chicago Mica Co.

Valparaiso, Ind.

## Dossert Solderless Connectors

The Standard for Splicing.  
THE ONLY Officially Approved Mechanical Joint!



2-Way, Type A. Showing Details.

Type A for all stranded and solid wires, indoors or underground.  
Type B for overhead line construction on stranded conductor only.

**DOSSERT & COMPANY**

242 W. 41ST STREET, NEW YORK

2

# The Knutson Trolley Retriever



—most successfully used by high-speed electric railways because it is a *real* retriever—not a mere catcher with a misleading name.

And there is a mighty big difference between the Knutson and all others! Better investigate fully *before* you spend your money.

Write us for facts or send for a sample lot to test on your road at our expense.

**The Trolley Supply Co.**  
Canton, Ohio

10

# Tell Us Your Brake Shoe Troubles

There isn't any kind of brake shoe problem we haven't solved satisfactorily thus far, and if you have a new or different kind of trouble we'd like first rate to know all about it.

Chances are that we can help you considerably. Of course we'll talk standardization—and not only talk it, but actually demonstrate to your own satisfaction that you can save a whole lot of good money by using our M. C. B. Christie type shoes.

You know how often you've wished that you didn't have so many brake shoe patterns, and you know how it hurts to see so heavy a percentage of brake shoe material find its way to the scrap heap.

It's easy enough to remedy both conditions.

*Just drop us a line and see.*

**BUCKEYE ENGINE CO.**  
SALEM, OHIO

Builders of High Class  
**STEAM AND GAS ENGINES**  
in powers from 25 to 10,000 H. P.

Correspond with us before placing orders.  
Catalogues on application.

**American Brake Shoe  
& Foundry Company**

Mahwah, N. J.

Hudson Terminal Western Union Bldg.  
Cortlandt Bldg., New York Chicago

7

**THE ARNOLD COMPANY**

ENGINEERS-CONSTRUCTORS  
ELECTRICAL - CIVIL - MECHANICAL  
191 LA SALLE STREET  
CHICAGO

**H. M. Bylesby & Company**

Incorporated  
ENGINEERS  
American Trust Bldg., Chicago  
Design, Construct and Operate  
Railway, Light, Power and  
Hydraulic Plants  
EXAMINATIONS AND  
REPORTS

**J. G. WHITE & COMPANY**  
INCORPORATED

Engineers, Contractors  
43-49 Exchange Place,  
41-43 Wall Street  
New York, N. Y.  
Principal Philippine Office: Manila, P. I.

**Complete Plants for the Rapid  
Handling of Material**

Every Sort of Hoisting Apparatus  
BROWN HOISTING MACHINERY CO. Cleveland, Ohio

**SANDERSON & PORTER**  
ENGINEERS AND CONTRACTORS

REPORTS • DESIGNS • CONSTRUCTION MANAGEMENT  
HYDRO-ELECTRIC DEVELOPMENTS  
RAILWAY, LIGHT AND POWER PROPERTIES  
NEW YORK SAN FRANCISCO



**E. C. Van Valkenburgh**

Promotional Advertising  
for Electric Railways

2117 West 102d Street : Chicago

A well-laid plan and Van Valkenburgh Advertising Service will  
make your advertising successful.

INSULATING  
VARNISHES  
(BAKING; AIR-DRYING)  
COMPOUNDS  
TAPE



Possess the  
Highest Insulative  
Efficiency.  
The Standard Paint Co.  
100 William St.  
New York.

WRITE TO **MODEL STOKER COMPANY** DAYTON OHIO  
for detailed information about the best  
**AUTOMATIC SMOKELESS FURNACE**

**SPRINGS-TIRES-STEEL-TIRED WHEELS**  
**RAILWAY STEEL-SPRING CO.**

General Offices: Cortlandt Bldg., 30 Church St., New York

**A. L. REGISTER & CO.**

Engineers and General Contractors—Electric Railways  
112 North Broad St. PHILADELPHIA, PA. Established 1889

**SHIMER & CHASE CO.**

Experienced Promoters of Electrical Railway Projects  
Correspondence Solicited OMAHA, NEB.

**CENTRAL INSPECTION BUREAU**

Inspection of Rails, Ties, Cars, Motors, Bridges, Buildings, Etc.  
17 STATE STREET - - - NEW YORK CITY

**LINE MATERIAL**

ELECTRIC SUPPLIES FOR RAILWAYS, POWER PLANTS, ETC.  
THE CREGHEAD ENGINEERING CO., 348 Main Street, Cincinnati, Ohio

A. U. Jaastad P. J. Harleman F. E. Greenwood  
**SHEAFF & JAASTAD**  
ENGINEERS

Broad Exchange Building, 88 Broad Street, BOSTON, MASS.

**HOT WATER HEATERS FOR CARS**

THE PETER SMITH HEATER COMPANY, Detroit, Mich.

**ELECTRIC HEATERS** For All Classes  
of Cars

New York Consolidated Car-Heating Co. Chicago

**GEARS AND PINIONS**

FOR ALL TYPES OF MOTORS  
THE VAN DORN & DUTTON CO., CLEVELAND, OHIO

**WHEEL TRUING BRAKE SHOES**

Repair Crippled Wheels While Running  
THE WHEEL TRUING BRAKE SHOE CO., Detroit, Mich.

**SMITH CONCRETE MIXER**

does the work better, quicker, cheaper and lasts longer.  
CONTRACTORS' SUPPLY & EQUIPMENT COMPANY  
Old Colony Building, Chicago 170 Broadway, New York 9

**GRIFFIN WHEEL CO.**

CHILLED IRON CAR WHEELS IRON OR STEEL AXLES  
CHICAGO

**RE-ENFORCED SPOKE WHEELS**

For City and Suburban Cars  
ST. LOUIS CAR WHEEL CO., St. Louis, Mo.

IF YOU wish to keep posted on  
all steam railway matters you  
must read THE RAILWAY AGE, for  
it is the leading railway journal of  
the world and the only one that  
covers all phases of the industry.

Sample copies sent on request.

**THE RAILWAY AGE**

160 HARRISON STREET - - CHICAGO

# National

Motor-Driven

# Air Compressors

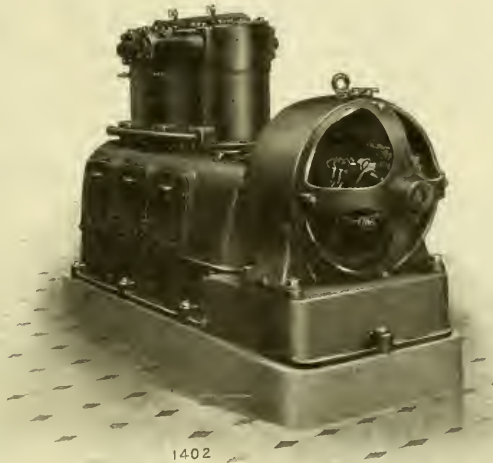

150 Cubic Foot "3VS" Type Air Compressor with Direct Current Motor

These compressors are especially adapted for service in car shops where compressed air is used for various purposes, such as drilling, chipping and riveting, for operating air hoists and air jacks, and for blowing dust and other matter out of car motors, controllers, seats, etc. They are of the single stage type, and are designed to stand hard service and usage. Either direct or alternating current motors can be furnished for operating same. Built in capacities of 50, 100, 150 and 225 cubic feet of free air per minute.

Write for Bulletin 84F.

**National Brake & Electric Co.**  
Milwaukee, U. S. A.

NEW YORK: 111 Broadway

PHILADELPHIA:

W. H. Goble, 1722 Westmoreland St.

General Sales Office

519 First National Bank Building

CHICAGO

BOSTON: F. E. Huntress, 131 State Street

SAN FRANCISCO, CAL.:

W. F. McKenny, 69-71 First Street

LONDON: 14 Great Smith St., Westminster

## Baldwin Locomotive Works

BURNHAM, WILLIAMS & CO., PHILADELPHIA, PA., U. S. A.

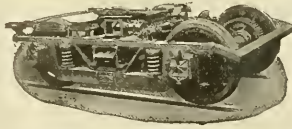

Builders of  
**LOCOMOTIVES**  
of every description  
including

**ELECTRIC  
LOCOMOTIVES**

**ELECTRIC TRUCKS**

## Standard Steel Works Co.

HARRISON BLDG., PHILA., PA., U. S. A.

New York, N. Y. Cleveland, O. St. Louis, Mo. Denver, Colo.  
Portland, Ore. Richmond, Va. Chicago, Ill. St. Paul, Minn.  
San Francisco, Cal. Seattle, Wash. Winnipeg, Can.

**Solid Forged  
Rolled and Steel Tired Wheels**

Mounted on axles fitted with Motor Gears  
for Electric Railway Service.

**LOCOMOTIVE TIRES**

**RAILWAY SPRINGS**

**FORGINGS**

**CASTINGS**



**THE MIGHTY  
MIDGET**

## HOT WATER CAR HEATER

Adapted for Large Electric Cars and Long Distance Lines. Exclusively used on Largest Electric Systems. Ask for Catalog

**THE WILLIAM C. BAKER HEATING & SUPPLY CO., 143 LIBERTY STREET  
NEW YORK**

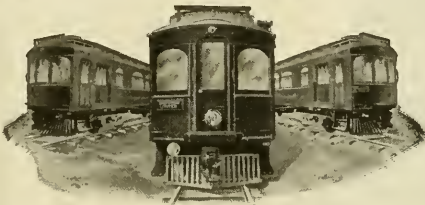

## NILES CARS — THE ELECTRIC PULLMANS

LARGE, FAST INTERURBANS  
OUR SPECIALTY

## NILES CAR & MFG. COMPANY

WORKS: NILES, OHIO

Sales Office:  
J. A. HANNA Co., 312 Electric Bldg., Cleveland, O.



CONTINUOUS JOINT

Over  
25,000  
miles  
in use



WEBER JOINT

Rolled  
from  
Best Quality  
Steel



WOLHAUPTER JOINT

### Catalogs of Agencies

Baltimore, Md. Portland, Ore.  
Boston, Mass. Seattle, Wash.  
Chicago, Ill. St. Paul, Minn.  
Denver, Colo. St. Louis, Mo.  
Pittsburg, Pa. Troy, N. Y.  
London, Eng. Montreal, Can.

HIGHEST AWARDS—Paris, 1900;  
Buffalo, 1901; St. Louis, 1904

Additional safety and economy in **Track Maintenance** has been proved by the use of Continuous, Weber and Wolhaupter base-supported rail joints—after ten (10) years' service, having a record of over 25,000 miles in use—the extent of which is evidence of their excellence.

## THE RAIL JOINT COMPANY

General Offices: 29 West 34th Street, New York City  
Makers of Rail Joints for Standard and Special Rail Sections, also Girder, Step or Compromise, and Insulating Rail Joints, protected by patents in United States and Foreign Countries.

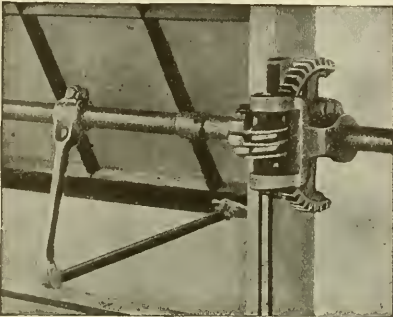

## The Ventilation

of your Shops, Foundries and Car Barns is made especially effective by a speedy, positive and easily manipulated **Sash Operating Apparatus** which automatically locks the sash at any position.

Let us send you our catalogue.

**Lord & Burnham Company**  
Irvington-on-Hudson, N. Y.

## AUTOMATIC TROLLEY GUARD

"It puts the  
wheel on  
the wire"

"It puts the  
wheel on  
the wire"

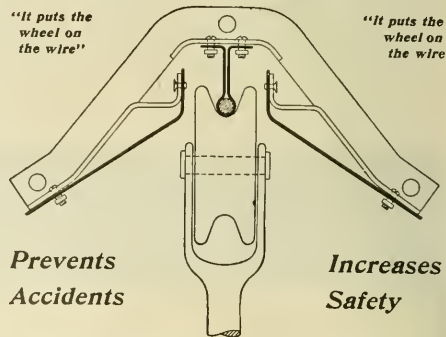

**Prevents  
Accidents**

**Increases  
Safety**

when installed at steam railway crossings, subways or under crossings, or on curves, bridges or other dangerous places. Not like other trolley guards with which you are familiar.

Send for detailed description, please.

**Automatic Trolley Guard Co. — 391-393 — Buffalo, N. Y.**  
Ellicott Square



# FOR SALE. FOR QUICK DELIVERY

## 6 55-ft. Passenger, Baggage and Smoking Car Bodies

Main Compartment 26' 0"  
 Smoking " 10' 6"  
 Baggage " 10' 0"  
 Seating Capacity, 54

## 8 60-ft. Passenger, Baggage and Smoking Car Bodies

Main Compartment 28' 6"  
 Smoking " 11' 0"  
 Baggage " 8' 0"  
 Seating Capacity, 58

## 5 52-ft. Passenger and Smoking Car Bodies — Double End

Seating Capacity, 60

## 3 52-ft. Passenger and Baggage Car Bodies — Double End

Seating Capacity, 56

## 2 50-ft. Express Car Bodies

*Write or wire us for further information.*

# The Jewett Car Co. Newark Ohio

## "Not an Experiment"

The Providence Fender is the Children's Fender. It is equally as effective in saving a child, and the person who has stumbled, as it is in saving those who are on their feet.

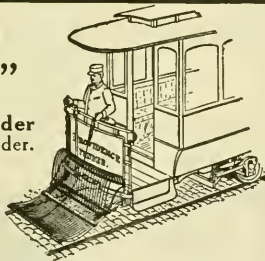

### CONSOLIDATED CAR FENDER COMPANY

Office and Factory: PROVIDENCE, R. I.  
 Branch Office: 110 E. Twenty-third St., New York  
 European Agents: Comploire d'Electricite, 6, Rue Boudreau, Paris, France

## Do away with the Hot Box Habit on your road

by using STEEL WOOL JOURNAL PACKING—the perfect packing that has accomplished this result on many roads

*Send now for a free sample and test it*

### WM. ROBERTSON & COMPANY

General Office: Great Northern Bldg., CHICAGO  
 Factory: 75 S. Jefferson St., BATTLE CREEK, MICH.

10

# McGUIRE-CUMMINGS MFG. Co. CHICAGO



## SPRINKLERS, CARS, TRUCKS AND RAILWAY EQUIPMENT

**The Lindsley Brothers Company**  
 Producers and Shippers of **WESTERN CEDAR POLES** and Manufacturers of **RED FIR CROSS ARMS**  
 Eastern Sales Office, Monadnock Bldg., CHICAGO SPOKANE, WASHINGTON

**POLES and PILING** 20,000 35s and 40s, Ready to Ship at Once  
 S-E, MISSOURI CYPRESS CO., CAMPBELL, MO.

**G. H. BARNES HARDWOOD LUMBER CO.**  
 Office and Yard: Main and Warren Sts., ST. LOUIS, MO.  
 Ties, Car Oak, Poplar, Ash, Cherry, Plain and Quartered Oak

**For Sale** Cards produce results in the  
 Electric Railway Review

If you want **POLES** Michigan or  
 good Western Cedar  
 at the right prices and prompt delivery, write us.  
**NATIONAL POLE COMPANY**  
 EVERETT, WASH. ESCANABA, MICH.

**Poles and Ties**  
 A Selected Stock in Chicago for Rush Shipment  
 A Number of Large Yards in the North  
**NAUGLE POLE & TIE CO.**  
 CHICAGO OFFICE: 226 LA SALLE STREET

**C. H. WORCESTER CO.**  
**CEDAR POLES**  
 PRODUCERS AND WHOLESALERS  
 Suite 1710 Tribune Building CHICAGO

**Idaho Cedar Poles**  
 PACIFIC COAST POLE CO. SPOKANE, WASH.

We are Producers and Wholesale Dealers in Western  
**CEDAR POLES**  
 Yards in Washington, Idaho, Montana  
 and British Columbia  
 WRITE US FOR DELIVERED PRICES  
**CHURCHILL CEDAR CO.,** Box 1409, Spokane, Wash.

**Shelby Trolley Poles**  
 Made from Cold Drawn Seamless Steel Tubing.  
 Immediate delivery all sizes from stock.  
**The Garford Company : Elyria, O.**

**BERTHOLD & JENNINGS**  
 LUMBERMENS BLDG. SAINT LOUIS, MO.

**TIMBERS**  
 L. L. Pine, Oak

**POLES**  
 Cedar, Cypress, Chestnut

**TIES**  
 Oak, Cypress, Chestnut

**WHITE CEDAR POLES** Large Stock 14 to 65 ft.  
 Prompt Shipment

**POLES**

**YARDS:**  
 Menominee, Mich.  
 Escanaba, Mich.  
 Superior, Wis.  
 Deer River, Minn.

**FRANCIS BEIDLER & CO.**  
 Chicago, Ill.

**POLES and TIES**

We have a nice selected stock of  
**Chestnut Poles**  
 White and Common  
**OAK and CHESTNUT TIES**

**The Advance Lumber Co.**  
 1313 Rockefeller Building  
 CLEVELAND OHIO

# CAR CURTAINS

Did you ever stop to think how much is added to the appearance of your cars by tasteful window curtains?

Let us give you an estimate upon new ones for those cars you are renovating.

## The Curtain Supply Company

Main Office and Works,  
85-93 Ohio Street, CHICAGO, ILL.  
530 Mission St. SAN FRANCISCO Hudson Terminal, 50 Church St. NEW YORK



Passenger  
Paying  
Fare  
to the

# Rooke Automatic Fare Collector

How it is done:

- Conductor presents collector to passenger, pressing lever to permit entrance of nickel
- passenger inserts nickel in collector
- automatically the nickel is registered, the bell rings and nickel is released to conductor's hand.

**Rooke Automatic Register Co.**  
Providence, Rhode Island

# Ten Seconds is Sufficient

for your dispatcher to set a stop signal against any car or train approaching a meeting point—

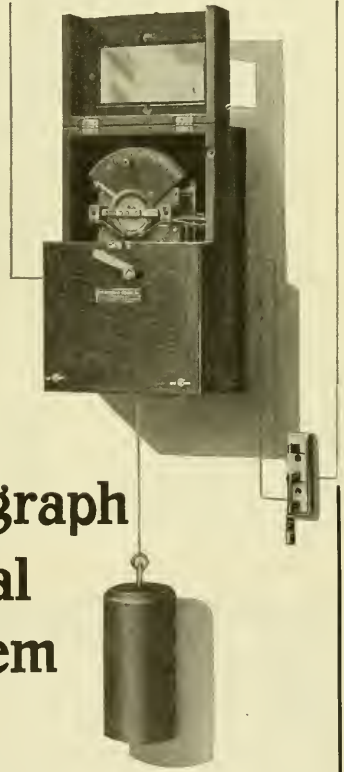

provided, of course, that your line is equipped with the

# Telegraph Signal System

Dispatcher merely inserts plug in the little machine illustrated above—the system does the rest—and does it every time

One Line Wire. Adoption Cost Extremely Low  
Write for Descriptive Literature

**Telegraph Signal Co.**  
282 State Street, Rochester, N. Y.

# CLASSIFIED ADVERTISEMENTS

Undisplayed advertisements are inserted under this heading at the uniform rate of one cent a word; minimum charge twenty-five cents. Replies directed to this office will be forwarded when required to any address in the United States, Canada or Mexico without extra charge. Advertisements received at the Chicago office by 9 a. m. Thursday will appear in the issue for the same week.

## POSITIONS WANTED.

Expert street car electrician, city or interurban lines, desires a change. Fifteen years' experience; capable handling men; also railway park manager. Now with a large railway. Address "No. 578," care of Electric Railway Review, Chicago.

Wanted—To correspond with company needing the services of high-class general manager or general superintendent. Electrical and civil engineer; 17 years' experience with large properties and in construction and operation. Address "No. 588," care of Electric Railway Review, Chicago.

Wanted—Position as superintendent of rolling stock or master mechanic on city or interurban railway. Have satisfactorily handled similar work on large metropolitan properties since horse car days. At liberty now; references exceptional. Address "No. 580," care of Electric Railway Review, Chicago.

Position wanted with a proposed interurban electric road by a man with eight years' experience in the preliminary work. Can take complete charge of the engineering work, procuring right of way, franchises, stock selling; and also knows the conditions which must exist before a road can be successfully financed. Address "No. 584," care of Electric Railway Review, Chicago.

Position wanted as auditor and accountant. Sixteen years of steam, electric and general experience; good working knowledge of details of general contracting business; clever buyer; possess ability to organize. Can furnish first-class reference as to character and ability and work accomplished in past; leaving present work because closed; at liberty to accept position any time. Address "No. 575," care of Electric Railway Review, Chicago.

## POSITIONS WANTED.

Wanted—Middle-aged man with 26 years' experience in railway operation and supplies and equipment wants to represent good firms in the south-west with headquarters at Oklahoma City. (By permission refers to Electric Railway Review.) Address "No. 581," care of Electric Railway Review, Chicago.

An experienced supply salesman, who also has had thirteen years' operating experience on city lines, desires to form connection with a railway supply house handling either electric or steam supplies of both. Would consider proposition to open sales agency. Address "No. 566," care of Electric Railway Review, Chicago.

Transportation man of seven-teen years' experience, young, reliable and thoroughly familiar with organization, dispatching and timetable work, desires a position as superintendent or one of equal responsibility. (Highly references regarding character, ability and past service. Address replies to "No. 577," care of Electric Railway Review, Chicago.

Experienced electrical engineer wants position with manufacturing concern or with company operating electric railways. Graduate Purdue University, 1905. Will go anywhere for permanent position. Age 26; married; A No. 1 references as to habits and ability. Address "No. 570," care of Electric Railway Review, Chicago.

Position wanted as superintendent and electrician of electric light and power station by man of 30, having 12 years' practical experience in construction and operation; thoroughly familiar with all systems adopted by modern plants for reducing expenses and adding to income; salary, \$125. Address W. N. Alexander, Sidney, Neb.

## POSITIONS WANTED.

Detective or claim agent—Three years' experience in the detective business. Used to rough, hard electrical and street railway work. Address "No. 555," care of Electric Railway Review, Chicago.

## POSITIONS OPEN.

Superintendents, engineers, draftsmen, street railway, electrical, mechanical. Positions open. Write for free list and information, HAPGOODS, 305 Broadway, New York, or 1010 Hartford Bldg., Chicago.

## MISCELLANEOUS WANTS.

Want to buy second-hand equipment, machinery or material? A card inserted in the Electric Railway Review, stating just what you want, will bring immediate response. The cost is small—only \$1.20 an inch (measuring 1 inch deep by 1½ inches wide) per insertion. Send orders to Electric Railway Review, 160 Harrison St., Chicago.

What have you to sell in the way of second-hand equipment, machinery or material? Buyers read the "For Sale" cards on the following page and there is the place to tell your story. "For Sale" cards are inexpensive—only \$1.20 an inch (measuring 1 inch deep by 1½ inches wide) per insertion. Special rates on contracts for 100 inches or more to be used within one year. Now is the time to send your order to Electric Railway Review, 160 Harrison St., Chicago.

## BOOKS AND PUBLICATIONS.

Wanted—Copies of the Street Railway Review of April, 1906, May, 1901, and August, 1903. State price and condition. Address "No. 553," care of Electric Railway Review, Chicago.

## BUSINESS OPPORTUNITIES.

Wanted—Man with some capital and a knowledge of railway track supplies to join the advertiser—a salesman handling locomotive and car supplies—in a general railway supply business. Address "No. 558," care of Electric Railway Review, Chicago.

Recharging Dry Batteries, the only book ever published giving complete directions of how to prepare chemicals for renewing dry batteries. If you are not more than pleased with this book your dime back. Large electrical catalogue and book postpaid, 10 cents. Adams Electric Co., Dept. E. R., Kewanee, Ill.

## BOOKS AND PUBLICATIONS.

Wanted—Copies of Street Railway Review, January to June, 1906, inclusive, and one copy each January and February, 1906. Also Electric Railway Review for January 5, 1907. State condition and price. Address "No. 582," care of Electric Railway Review, Chicago.

Interstate commerce national legislation to July 1, 1906, is fully covered in our reference pamphlet. It contains the full text of the act to regulate commerce as amended, including the Elkins and Hepburn acts, and of the supplementary act relating to the testimony of witnesses before the interstate commerce commission. It also contains the texts of the expedition act, the anti-trust act of 1906, the employers' liability act and the safety equipment laws. Difference in type shows the parts expunged from, and the parts added to, the interstate commerce and Elkins acts by the Hepburn act. This pamphlet is of special value to railway men and lawyers. Mailed prepaid for 25 cents in stamps or coin. Special prices for quantities. The Wilson Company, 160 Harrison St., Chicago.

**R. W. MARSHALL & CO.**  
50 Church St., New York  
Second-Hand Machinery and Equipment  
**ELECTRIC RAILWAY MATERIALS**

## FOR SALE: Three Car Bodies and Three Pairs of Double Trucks

with or without electric equipment and air brakes; all new and never used. Compelled to sell, as these cars will not operate over a leased line by reason of their width and length.

R. W. MARSHALL & CO., 50 Church St., New York, N. Y.

Rare Bargains in  
**RAILS AND EQUIPMENT**  
WALTER A. **ZELNICKER** SUPPLY CO.  
in ST. LOUIS  
DO YOU RECEIVE OUR STOCK LISTS?

**NO SNOW TO DELAY CARS**  
The Russell Snow-Plow is used by more than 60 roads to maintain schedules and prevent blockades.  
Russell Car & Snow-Plow Co., Ridgway, Pa.  
Wendell & MacDuffie, Corlandt St., New York; C. A. Balston, Fisher Bldg., Chicago; Robinson & Cary Co., Saint Paul.  
IF YOU HAVE A RUSSELL

**WANTED**  
A Second-hand Double-truck Combination Construction Car and Snow Plow, with all equipment, in first-class condition. Quote price with and without electrical equipment; western delivery; giving full description and condition. Address "No. 583," care of ELECTRIC RAILWAY REVIEW, Chicago, Ill.

One cent a word for want ads in the Electric Railway Review.

## Replies to Want Ads

may come in care of the ELECTRIC RAILWAY REVIEW and are forwarded without charge. The cost of want ads is only one cent a word per insertion.

## The Boilers Will be Out of Service a Much Shorter Time for Washing

thereby requiring very much less labor, to say nothing of the saving in fuel and the increased efficiency of the boilers, if the incrusting solids and other deleterious salts in the water are acted upon by **Dearborn Compounds** and their injurious properties destroyed. Send us gallon sample of your feed water for analysis.

### Dearborn Drug & Chemical Works

ROBT. F. CARR, PRESIDENT

299 BROADWAY, NEW YORK      POSTAL TELEGRAPH BLDG., CHICAGO

## PIPE FITTINGS AND VALVES

FOR THE  
HEATING AND PLUMBING TRADE

TRADE  MARK

**JOHN SIMMONS Co.**  
104-110 Centre Street, NEW YORK



## BRAKE SHOES

- ☞ High speed and heavy equipment demand high-class BRAKE SHOES.
- ☞ Our shoes are of that one particular class that will answer your requirements in a perfectly satisfactory manner throughout.
- ☞ May we have an opportunity of proving our claim?

Special Mixture Shoes with "Re-enforced" Back and Lug

### STANDARD BRAKE SHOE CO.

General Office and Works, Aurora, Ill.

Chicago Office, 315 Railway Exchange

Avoid  
Accidents

By Using  
This  
Switch

SPECIAL TRACK WORK OF  
EVERY DESCRIPTION

## New York Switch & Crossing Co.

HOBOKEN, N. J.

## Anti-Straddling or Anti-Kicking Tongue Switch

It will not drive down at the heel, because it is held to either side with a spring tension and firmly down on its bed. A car can not straddle this tongue.

WRITE FOR SPECIAL  
CIRCULAR



**THE NATIONAL LOCK WASHER CO., NEWARK, N. J.**  
 Curtains - Curtain Fixtures - Sash Locks - Sash Balances - Nut Locks  
 CHICAGO OFFICE: 419 MONADNOCK BLOCK

**Hart Convertible CONSTRUCTION BALLAST and GONDOLA CAR**



**A Center-Dump, Side-Dump and Flat-Bottom Gondola-All in One**

Diagonal shading shows position of ballast after being spread by the Rodger Distributing Car which follows the hoppercars

**Rodger Ballast Car Co. Railway Exchange, CHICAGO.**



Factory of The Milloy Electric Company  
Bucyrus, Ohio

**The Milloy Trolley Base**

built in our new and specially equipped factory, insures a quality which will give excellent service under ordinary and extraordinary conditions.

The Milloy Base is unusually low, has even tension on high or low wire. Has no fulcrum, no friction, no oil, no center post. Always efficient. Particulars on request.

**THE MILLOY ELECTRIC COMPANY**  
Bucyrus, Ohio

**Hydraulic Railroad Tools**

- 400 Types of Hydraulic Jacks.
- 50 Types of Hydraulic Punches.
- 10 Types of Hydraulic Rail Benders.
- 15 Types of Crank Pin Presses.
- 40 Types of Wheel Presses.

Dozens of other hydraulic tools you need. Every tool guaranteed.



*Send for Railroad Catalogue.*

**THE WATSON-STILLMAN CO.**  
 50 Church Street, New York City  
 Branch Office: 453 The Rookery, Chicago, Ill.

**The Macallen Company**  
 FORMERLY THE W. T. C. MACALLEN CO.

**Electric Railway Material**

**BRASS FOUNDERS**

**Foundry and Division Sts., Boston, Mass.**





ELECTRIC SERVICE SUPPLIES CO.	- - -	Philadelphia, Pa.
ELECTRIC SERVICE SUPPLIES CO.	- - -	Chicago, Ill.
OTTO NEISSER	- - -	Los Angeles, Cal.
FRANK RIDLON CO.	- - -	Boston, Mass.
F. BISSELL COMPANY	- - -	Toledo, Ohio
JAS. CLARK, Jr., & CO.	- - -	Louisville, Ky.
J. A. DAWSON & CO.	- - -	Montreal and Winnipeg, Canada

# WESTERN ELECTRIC

COMPANY  
 CHICAGO DENVER PITTSBURG SAINT PAUL NEW YORK  
 SAINT LOUIS PITTSBURG CHICAGO ALLANTOWN PHILADELPHIA  
 SAN FRANCISCO SEATTLE SALT LAKE CITY LOS ANGELES KANSAS CITY

## D. C. GENERATORS

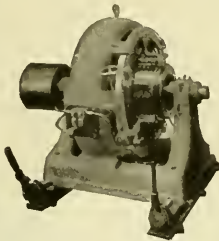
Any Size Any Capacity Prompt Deliveries



### A Few of Our Prominent Installations

INSTALLATION	K. W. VOLTS
Marquette Cement Mfg. Co., La Salle, Ill. (3)	800 250
Wichita Railway & Lt. Co., Wichita, Kan.	600 600
C. & E. I. Railway, Danville, Ill.	500 250
Lake Shore & R. I. Depot, Chicago, Ill.	500 250
Wichita Railway & Lt. Co., Wichita, Kan.	400 600
St. Regis Hotel, New York, N. Y. (2)	200 120

WRITE FOR BULLETINS 3085-C AND 3080-C

# TUBULAR POLES

## IRON OR STEEL



FOR  
 ELECTRIC RAILWAYS  
 ELECTRIC LIGHTING CO'S  
 SIGNAL TELEPHONE TELEGRAPH  
 TRANSMISSION LINES  
 AND  
 SUSPENSARY LINES

**ELECTRIC RAILWAY EQUIPMENT CO.**  
 General Office: CINCINNATI-O-U-S-A  
 Shops: READING PA - WHEELING WVA

## Electric Railway Lubrication

THE same skillful expert supervision given in this service as in steam railway service has produced most satisfactory results. Lower cost of lubrication with better service.

We are under contract with many of the largest Street and Interurban railways in the country.

We guarantee cost per thousand miles in Street and Electric Railway Service when conditions warrant it.

Including both Rolling Stock and Power House Equipment

Write for further particulars.

**Galena-Signal Oil Company**  
 FRANKLIN, PENNSYLVANIA

## Queen Testing Sets

"The Recognized Standard"

Voltmeters  
 Ammeters  
 Switchboard and Portable  
 Alternating and Direct Current

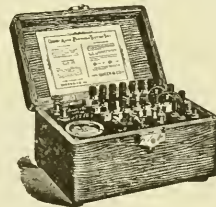

Queen Acme Testing Set

U. S. Standard Testing Sets  
 Rail Bond Testers  
 Galvanometers, etc., etc.  
 Electrical Instruments for All Purposes

**QUEEN & CO., Inc., Philadelphia, Pa.**

## WESTON Standard Portable Direct-Reading

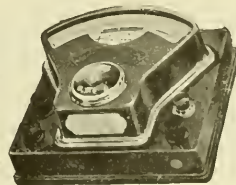

Voltmeters  
 Millivoltmeters  
 Voltmeters  
 Ammeters  
 Milliammeters  
 Ohmmeters  
 Ground Detectors  
 and Circuit Testers

Our STATION VOLTMETERS and AMMETERS are unsurpassed in point of extreme accuracy and lowest consumption of energy.

**WESTON ELECTRICAL INSTRUMENT CO.**

Main Office and Works: Waverly Park, Newark, N. J.

London Branch: Andrey House, Ely Place, Holborn, Paris, France: E. H. Cadot, 12, Rue St. Georges, New York Offices: 74 Cortlandt St., Berlin: European Weston Electrical Instrument Co., Ritterstrasse, No. 88.

# The Peacock Brake

*is built on absolutely  
sound principles.*

No sprockets to cut or wear the chain. No parts to get out of order or be replaced. The material is the very best quality of malleable iron and steel obtainable. No gun metal or cast iron used anywhere in its construction.

## National Brake Co.

888 Ellicott Square

BUFFALO

N. Y.

### STANDARD HIGH-SPEED "INTERBOROUGH" DOUBLE TRUCK

TYPE C-60

**"Solid Forged"**

WITHOUT WELDS

FRAMES ARE MADE FROM ROLLED OPEN-HEARTH STEEL WITHOUT WELDS. ALL WEARING BOLTS ARE TURNED AND CASE HARDENED, AND WEARING HOLES STEEL THIMBLED. M. C. B. STANDARD PRINCIPLES ARE FOLLOWED. WE ARE PREPARED TO BUILD TRUCKS IN ACCORDANCE WITH PURCHASER'S DESIGNS AND SPECIFICATIONS.

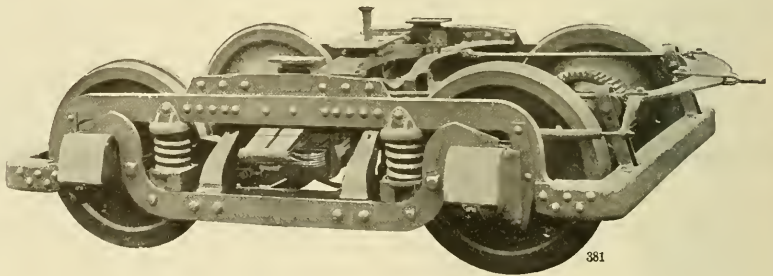

381

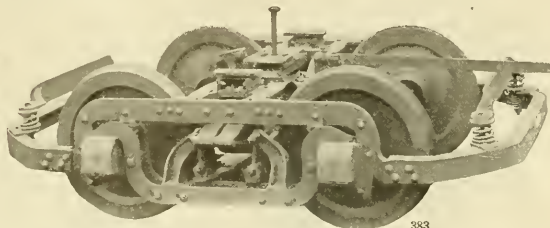

383

STANDARD  
"SHORT WHEEL BASE"

CITY AND SUBURBAN

DOUBLE TRUCK

TYPE O-50

STANDARD MOTOR TRUCK COMPANY, FRICK BUILDING, PITTSBURGH, PENNSYLVANIA

NEW YORK OFFICE: 170 BROADWAY

WORKS: NEW CASTLE, PA.

2

CHICAGO OFFICE: FISHER BUILDING



# Electric Railway Review

PUBLISHED EVERY SATURDAY BY THE WILSON COMPANY, CHICAGO

Entered as second-class matter January 5, 1907, at the postoffice at Chicago, Ill., under the act of March 3, 1879.

CHICAGO: 160 Harrison Street  
NEW YORK: 50 Church Street  
CLEVELAND: 1529 Williamson Bldg.

Vol. XIX  
No. 18

CHICAGO, MAY 2, 1908

Whole No.  
262

Subscription: Domestic, \$2.00  
Foreign, 5.00  
Canada, 3.50

Announcement is published in this issue of the Electric Railway Review that a revision will be made in the scheme of

## Revision of

## Line Fixing

## Small Railways.

issued by the commission, presenting for criticism classifications of operating expenses and construction expenditures, fixed \$50,000 gross annual revenue as the line of demarkation which should determine whether a company should use the amplified classification of operating expense accounts or an abbreviated classification containing the same principles. The naming of this small sum, even tentatively, has been generally criticized by all who are familiar with the abnormal accounting expenditure which a classification of operating expenses containing 116 primary accounts would impose upon a large number of railways. That the determination upon the revision of this feature of the tentative system has already been made is evidence that the division of statistics and accounts of the commission recognizes the justice of the complaints which have been received concerning the limit suggested.

The use of mirrors on the fronts of cars is not a new practice. Several city roads in the central west have used such mirrors

## Mirrors

## for the

## Motormen.

for years. Originally they were put on small single-truck cars which did not handle enough traffic to warrant the expense for crews of two men. With a mirror over his head the motorman could easily watch the passengers in his car and make sure which had paid fares. As the cars used became larger and full crews were required some of the roads found it advisable to use mirrors mounted on a vestibule post so that a motorman could watch the rear step and the cars following. So large a system as the Omaha & Council Bluffs Street Railway makes good use of mirrors on its cars. This company, profiting by the successful use of such mirrors in Des Moines, has installed them on its closed cars and will put them on the open cars for summer use. As stated by Arthur W. Gross, claim agent of the Omaha company, one of the most important reasons why mirrors are used is that they help in preventing a large number of accidents which otherwise would occur at the rear steps of a closed car or along the running board of an open car.

The general manager of a railway property in a moderate sized city has tasks to fulfill that are entirely without the

## Relations

## with the

## Public.

province of the manager of a metropolitan railway. He and the head of his transportation department must know when and where all public meetings are to be held and must be in close touch with the affairs of the entire city. This is too large a task for any one or two men on a very large property. No comparatively small railway can afford to be without a manager who is a good "mixer." The manager of a 20-mile street railway serving a city in the middle west which has a population of 45,000, recently stated that he followed a systematic plan of getting acquainted with a number of the more prominent men in the trade unions, professions and mercantile businesses in his

city, with a friend or two in the various fraternal and church organizations. Being on good terms with the leaders of these bodies serves him in good stead. One can readily appreciate the value of his policy whenever political moves are agitated which may not be in accord with the best interests of the railway. A most valuable asset for an electric railway is a friendly relation with its patrons.

At Des Moines last week the members of the Iowa Street and Interurban Railway Association discussed in a very thorough manner the subject of depreciation in

## Depreciation and Publicity in Iowa.

electric railway accounting. This discussion resulted in a far better understanding of the question than that previously had by many of the members. Doing things by halves is not a characteristic of the Iowa association; therefore the members put themselves on record with regard to the depreciation question by passing a resolution embodying the following statements: "Resolved, That the Iowa Street and Interurban Railway Association recognizes the correctness of the principle of providing out of earnings an adequate annual appropriation for a depreciation reserve; said depreciation reserve account to be separate and distinct from any maintenance account. The funds so appropriated to be used solely for the purpose of paying for renewals of equipment worn out in service or superseded by advances in the art." The committee which formulated this resolution also recommended that all member companies should make public their financial statements at least once each year. The recommendation is based on the following reasons: "1. To correct the erroneous idea on the part of the public that the business is productive of excessive profits. 2. A true exposition of the net returns to security holders will to a large extent still the clamor for short-term franchises and reductions in fares and rates. 3. The public is disposed to be fair-minded and if it has access to our reports and realizes the close margin of profit in the electric railway business much of the effectiveness of the doctrines of the demagogues will be lost." From our knowledge of the men who operate the Iowa properties we believe that they are serious in this matter and therefore will use their best efforts to carry out these resolutions.

Tom L. Johnson has finally won his long fight with the Cleveland Electric Railway and has caused the introduction of 3-cent fares in Cleveland. As yet the 3-cent

## Three-Cent

## Fares in

## Cleveland.

fare does not include transfers, but we are assured that they will be ready in a few days. A settlement of the long controversy, with its accompaniment of costly lawsuits, track ripping and consequent impairment of service, is of course entirely satisfactory to the people of Cleveland on almost any terms, and the inauguration of the new regime on Tuesday by giving free rides of course did a great deal to increase Mr. Johnson's popularity in Cleveland. At the same time the success of the holding company plan, which is outlined on another page of this issue, remains to be demonstrated. The Municipal Traction Company, composed of nine men supposed to represent the public and to operate the property without profit to themselves, is starting

out with some very ambitious plans, but we believe that conservative street railway managers will wish to observe its operations for some time before following its example. Mayor Johnson has apparently assumed control of a large street railway system without paying anything for it and we fail to find any guarantee as to how long the 3-cent fare system will last or any indication as to where the 2-cent saving is to be effected. We are told that the holding company is to operate without profit, but those who furnish the capital for improvements and extensions will expect dividends, fixed charges are not reduced and we know of no documentary limitation of the salaries to be paid to the officers. Possibly a directorate composed largely of politicians can manage a street railway more economically than experienced railway men, but 40 per cent is a big reduction and the experiment will be watched with great interest.

#### BALTIMORE BULLETINS AND OVERCAPITALIZATION.

During the past few months we have several times called attention to the very excellent publicity campaign which the United Railways & Electric Company of Baltimore is carrying on through the medium of the daily press in that city. The most recent bulletin discusses the subject of "capitalization." Former bulletins have presented to the railway patrons in Baltimore especially well-written discussions of such subjects as transfers, cleanliness, the street railway as a developing agent, taxation, power and accidents. We are informed that the results of this campaign are especially gratifying to the street railway management.

Each week one of the department heads prepares a clearly written discussion on the relations which do or should exist between his department and the patrons of the road. These discussions are entirely original and, not being in the nature of advertisements, become interesting reading for the subscribers to the large daily papers of Baltimore in which the articles appear. It is understood, of course, that the primary reason for conducting this publicity campaign is the good which eventually will accrue to the United Railways & Electric Company. Therefore a generous amount of advertising space for the presentation of the company's arguments is purchased from the daily press each week.

The latest bulletin on "capitalization" presents this broad subject in such a clear, concise way that the financial foundation of the railway can be better understood by those inhabitants of Baltimore who, unless so informed, might be persistent and vigorous in their denunciation of this public service corporation, because of their belief that it may be "overcapitalized."

The principle of comparison also serves as a powerful argument. With the purpose in view of showing that the capitalization of the United Railways & Electric Company is much lower than in other large cities, a table is presented showing that this company is capitalized (bonds and stock) for \$21,907 less per mile than Pittsburg, Pa.; \$41,466 less per mile than St. Louis, Mo.; \$86,568 less per mile than Chicago, Ill. (Chicago Union Traction); \$129,625 less per mile than Richmond, Va.; \$131,814 less per mile than Brooklyn, N. Y.; \$139,446 less per mile than Washington, D. C.; \$312,390 less per mile than New York (Manhattan). [Where there are two or more companies in a city the one having the greatest length of track is here given.]

In defining "overcapitalization" the man who uses the quoted expression means to convey the impression that if a railway property were destroyed it could be reproduced at less than the par value of its present capitalization. This statement is entirely correct as far as it goes, and while it sounds plausible to those unfamiliar with railway problems it is both illogical and unfair.

The Baltimore bulletin considers some of the many factors

other than those of present value, which must necessarily exist as a part of the present capitalization of street railways.

Ever since the introduction of electricity there has been no cessation in the onward march. Electric cars purchased 10 years ago, 16 feet long, have found their way to the scrap heap. To meet the rush-hour problem 31-foot cars have taken their places. With the heavier cars came the necessity for laying heavier rails, and with additional demand for power came the necessity for the immense modern power house. The progress of electrical improvement has been one of the wonders of the past decade, and machinery purchased with an estimated life of 20 years has been replaced by new inventions and has found its way in a brief period to the scrap heap."

A special report of the United States census office covering operations of electric railways for a period as long ago as 1902 emphasizes the fact, sometimes overlooked, that the existing equipment of the old-fashioned horse and cable railways practically all had to be scrapped when electric traction was introduced. In most of these rehabilitation undertakings the cost of the new system was nearly as great as it would have been had there been no existing property to be rebuilt. On this subject Bion J. Arnold, in his report to the transportation committee of the Chicago city council, said that it would cost nearly as much to convert the cable lines to underground trolley systems as to construct the latter at first hand.

Reconstruction of railways operated with out-of-date materials and methods is thus seen to form an important factor in the large capitalization so frequently criticized.

A second factor, and by no means an unimportant one, is the cost of consolidations. On this subject the bulletin of the United Railways & Electric Company has the following to say:

"For example, if a street railway company in the early days earned sufficient income to pay large dividends its stock would sell at much over par. When it was seen that economies could be introduced by combination, the companies could not be purchased for such a mythical thing as the 'cost of reproduction.' The market value of the stock at least had to be paid. Again, the cities granted competing franchises which eventually forced one company to buy out the other, paying a high nuisance value, which in no sense represented the mere 'cost of reproduction.' The bankers and syndicates who took the financial risk of purchasing securities, of guaranteeing security holders, underwriters, etc., frequently received their compensation in stock. No one will fairly deny that they were entitled to payment for their risk in supplying or guaranteeing capital, provided they were not overpaid."

This factor is the one most frequently emphasized, but, as a matter of fact, constitutes much the smallest element in the capitalization of the companies.

In extenuation of its arguments that an injury can be brought upon the company by overtaxation, which injury is retroactive and results in throttling the service offered, the United Railways & Electric Company states that it "has not only never paid a cent to its stockholders, but, since the great fire, even its income bondholders have received no cash, but have been obliged to accept their interest in deferred obligations. At the same time the company has paid to the city and state more taxes proportionately than any other street railway in the country."

After presenting these clear explanations of why the capitalization of an electric railway must be so much greater than the actual cost of reproduction there is fittingly given a summary of the benefits which the growth and improvement of a rapid transit system bring to the city in which it is located. We do not need to emphasize or list these benefits, because electric railway financiers and managers know them full well. However, we do desire to emphasize that when an electric railway company conducts such a campaign of publicity as that now being carried on by the United Railways

& Electric Company of Baltimore, the results cannot be other than good. In the first place the well prepared information which is placed before the public in such a form that it is interesting to read brings about an interest between the patron and the railway. This offsets a large number of the petty criticisms so frequently promulgated. In the second place a newspaper depends for its sustenance on the revenues from its advertising columns. Therefore it is no more than right to expect that if the electric railway purchases space (and it need not be so very large an amount) the daily press will undertake to care for the best interests of that railway. Combining these two factors, an electric railway which has for its friends both the traveling public and the daily press can feel most secure as to receiving its just deserts.

ANNUAL REPORTS.

United Railways & Electric Company of Baltimore.

The principal results of operation of the United Railways & Electric Company of Baltimore during 1907 showed the following increases as compared with 1906: Gross earnings, 6.61 per cent; operating expenses, 7.74 per cent; net earnings, 5.5 per cent. Figures for two years follow:

	1907.	1906.	Increase.
Miles of track .....	396.2	394.5	1.7
Gross earnings .....	\$7,018,081	\$6,583,102	\$434,979
Operating expenses .....	3,470,087	3,220,942	249,145
Net earnings .....	\$3,547,994	\$3,362,160	\$185,834
Other income .....	6,505	4,725	1,780
Total net income .....	\$3,554,499	\$3,366,885	\$187,614
Charges, taxes, etc.....	2,487,942	2,365,587	122,355
Net divisible income.....	\$1,066,557	\$1,001,298	\$ 65,259
Extraordinary expenditures.....	1,028,899	980,000	48,899
Surplus .....	\$ 37,658	\$ 21,298	\$ 16,360
Operating expenses—per cent of gross earnings.....	49.44	48.93	0.51

The policy of appropriating for "extraordinary expenditures" practically all of the revenue not required for expenses, taxes and charges was continued; the amount so applied in 1907 was \$1,028,899. The disbursements on this account are designated as "amounts required for rehabilitating the property other than ordinary maintenance and repair." The statement of the income account refers to the sum as "written off for extraordinary expenditures, subject, however, to final distribution by the board of directors," giving the inference that some other disposition may be made of the amount of these disbursements in the future. The "extraordinary expenditures" were equal to 14.7 per cent of gross revenue. The charges in operating expenses for maintenance were as follows: Maintenance of way, \$205,886; maintenance of cars, \$409,823; a total of \$615,709. The former amount is equal to \$520 per mile of track operated. The aggregate maintenance expenditures were 8.3 per cent of gross revenue. There was therefore expended on the property from revenue an amount equal to 23.5 per cent of gross earnings, or to 47.4 per cent of the entire sum charged to operating expenses. This represents actual outlay and does not include provision for a depreciation or renewals reserve.

William A. House, the president, states that the recession in business affected the revenues during November and December, but that the revenues in those months showed increases over the corresponding period of 1906. Eighty double-truck convertible cars were placed in service. The company sold 110 single-truck cars for \$54,282. A coal car, an overhead line car and a single-truck derrick car have been built at the shops of the company. Four new car houses have been built and sites obtained for two additional houses.

Concerning the new transfer system (described in the Electric Railway Review of March 7, 1908, page 299) Mr.

House states: "By this change the company was enabled to afford its patrons more liberal transfer privileges. It may be of interest to state that there is now an exchange of transfers between the lines of the system at 193 junctions with 1,614 direction privileges, thus enabling passengers to reach any section of the city for a single fare."

Statistics of traffic, with a comparison, follow:

	1907.	1906.	Increase.
Car-mile revenue, cents.....	26.06	25.30	0.76
Car-mile expenses, cents.....	12.87	12.37	0.5
Car-miles run .....	26,953,727	26,035,327	918,400
Revenue passengers .....	142,114,995	133,785,601	8,329,394
Transfers .....	55,165,581	53,413,492	1,752,089

The outstanding funded debt on December 31, 1907, was \$54,185,000, an increase of \$565,000 during the year. The common stock was unchanged at \$15,000,000, but there was a reduction of \$5,000 in the preferred stock, the amount outstanding being \$55,000. Mr. House speaks of the policy of the company to comply with all reasonable requests for improved service or give good reasons for non-compliance where suggestions are impracticable, and adds: "The company considers that it is entitled to the earnest and cordial support of every fair-minded citizen, and that the two interests—carrier and patron—are interdependent and should co-operate to secure the best results."

MODIFICATION OF PLAN OF DIVISION OF COMPANIES IN INTERSTATE ACCOUNTING SCHEME.

The plan of division between large and small electric railway companies, as set forth in Accounting Series Circular No. 20 of the interstate commerce commission, will be modified materially. It can be stated upon authority that the amended classifications will provide for separating companies into either three or four classes.

The basis of division will be the gross annual revenue, as in the circular containing the tentative classifications promulgated under date of January 10, 1908, but the separation will recognize the difference between the accounting requirements of large and small railways, respectively, more satisfactorily than the tentative scheme of Circular No. 20. A representative of the Electric Railway Review has been permitted to see in Washington this week the tentative plan which is at present under consideration, and, while no final decision has been reached concerning some features of the system, or will be reached for some time, it has been settled that a revision of the scheme of application as between the large and small companies will be made.

While some of the most important companies in the country have not yet submitted criticisms of the proposed system of accounting to the interstate commerce commission, enough information has been received by special investigation through representatives who have visited different parts of the country and by correspondence, to indicate the fairness and desirability of change in the proposed application of an amplified classification of operating expenses to companies with small gross revenue.

Cannot Haul Cars Free for Railways.

The Washington supreme court rendered a decision on April 10 holding that it is in violation of the interstate commerce law for one railway to agree to haul cars of another railway for nothing. The Union Pacific and Oregon Railroad & Navigation Company, having a traffic agreement with the Coeur d'Alene & Spokane, an electric line, agreed to transport 20 cars for it from the St. Louis Car Company to the tracks of the electric line free of charge. After the cars were en route the electric line entered into a traffic agreement with the Great Northern. The Harriman lines delivered the cars and sent a bill for \$90 per car freight. The electric line refusing to pay the bill, the Harriman roads sued the company for the amount.





various workmen on the different classes of shop work. The basis for this time distribution is a sheet 17 inches wide by 20 inches high, with headings as illustrated. Each day one of these sheets is mounted in a wooden frame, as shown in the accompanying halftone engraving. It will be noted that the frame is so designed that it exhibits to the foreman only those columns which it is his duty to fill in as the day's work progresses. On the left-hand side of the frame is mounted

column headings directly adjacent to the space opposite the employe's name whose time he may be recording for any of the various classes of repair work. The list of names affixed to the left-hand side of the frame holding the distribution sheet is dated with a dating stamp; and after the sheet has been filled in for one day this list is taken off the frame and fastened to it so that at any future time it is a simple matter to ascertain the names of all men working on any class of

Form D-58-5-5-1906-5,000

**THE UNITED RAILWAYS AND ELECTRIC CO.**  
ARMATURE TAG

Car No. .... Line..... Date.....190.....

Arm. No. out. .... Arm. No. in. ....

Repairs.....

Workman.....

Date sent out.....190..... Car No.....

CLEAN

KEEP

WRITE WITH RED INK

Baltimore Shop Records—Shop Tag for Armature.

each day a list of the shop men at work. The names of the various men are grouped according to the shop departments in which they are working. Across the frame and mounted

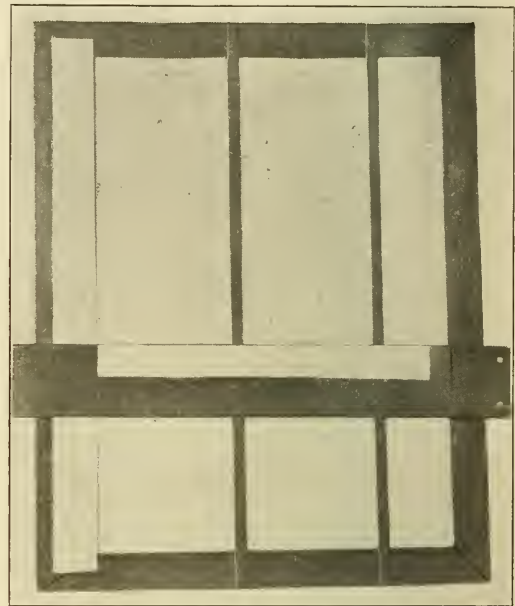

Baltimore Shop Records—Frame for Holding Labor Distribution Sheet.

Form D-72-11-1907-1000

**THE UNITED RAILWAYS AND ELECTRIC CO.**  
OF BALTIMORE

Car No. .... Arrived at Shop.....

Names of Motorman and Conductor .....

**REPORT OF REPAIRS.**

CAR BODY REPAIRS	NAMES OF WORKMEN
Overhauled.....	
Accident Repairs.....	
Paints Repaired.....	
Color Post Repaired.....	
S. S. Post Repaired.....	
Sub. Repaired.....	
Disks Repaired.....	
Ventilator Repaired.....	
H. A. Repaired.....	
S. H. Repaired.....	
Platform Repaired.....	
Seats Changed.....	
Oil Converted.....	
<b>PAINTING.</b>	
Burnt off.....	
Painted and Varnished outside.....	
Cleaned, Touched Up and Varnished.....	
Cleaned and Varnished inside.....	
Painted Roof.....	
Painted Floor.....	
Painted Truck.....	
Date Car left Shop.....	
Crew.....	

Form D-76-5-1-1907-5000

**The United Railways and Electric Co.**  
OF BALTIMORE

**ARMATURE REPORT.**

Date.....

Mr. H. H. Adams,  
Supt. of Shop

REPAIRS HAVE BEEN MADE AS NOTED BELOW

Armature No..... Date out.....

Car No.....

Retained.....

Cuts put in.....

Cuts Replaced.....

Open Circuit Repaired.....

Loos. Repaired.....

New Commutator.....

Commutator Repaired.....

Commutator Ground Repaired.....

New Misc Rings.....

New Flank Rings.....

New Heads.....

Bands.....

New Bearings.....

Commutator Turned.....

Shaft Straightened.....

New Shaft.....

New Pumps.....

New Way.....

NAMES OF WORKMEN

Car No..... Date in.....

FOREMAN.....

Baltimore Shop Records—Repair Reports for Armatures and for Bodies.

so that it will slide up and down is an arm rest on which is pasted a duplicate set of column rulings as exhibited by the large sheet contained in the frame. This movable column index insures accuracy and saves times when the foreman is distributing the time opposite the names up and down the large sheet. By the aid of this movable rest he has the

repairs on any former date. The totals are extended to a column on the right-hand side of the sheet and these are checked against the records of the shop time clock.

Chicago Convention National Electric Light Association.

The annual convention of the National Electric Light Association will be held at the Auditorium hotel, Chicago, Tuesday, May 19, to Friday, May 22. The programme, which has been tentatively announced, includes the following papers:

"Power-Load Development for Central Stations of Moderate Size," "Some Unappreciated Possibilities," J. R. Bibbins and Charles Robbins; "The Small Station and Its Economical Operation," J. T. Whittlesey and Paul Spencer; "Low-Pressure Steam Turbines," J. W. Kirkland; report of committee on gas engines, W. C. L. Egin, chairman; "Receiving Stations Operated from High-Tension Lines," S. Q. Hayes; report of insurance expert, W. H. Blood, Jr.; report of committee on protection from lightning and other static disturbances, Robert S. Stewart; "The Value of Care and Maintenance of Meters," H. D. King; "Some Experiments in Combustion," S. J. Lenher; "Specifications for Construction on Joint Poles," Paul Spencer.

In connection with the convention an interesting exhibition of electric lighting appliances and several entertainments have been arranged.

The interstate commerce commission on April 24 sent to the senate a report regarding the ownership of coal lands by railways. This report covers investigations in Colorado, Utah, Oklahoma and Wyoming.

### UNIFORM REPLY BY INDIANA AND OHIO LINES TO INTERSTATE ACCOUNTING CIRCULAR.

A number of electric railways in Indiana and Ohio have joined in a uniform reply to Accounting Series Circular No. 20, issued by the interstate commerce commission. In addition to the uniform answer, however, the individual roads will, if they desire, make further criticisms concerning the application of the tentative classifications to their operations. The following roads have presented the uniform response:

Chicago South Bend & Northern Indiana Railway.  
 Evansville & Southern Indiana Traction Company.  
 Ft. Wayne & Springfield Railway.  
 Ft. Wayne & Wabash Valley Traction Company.  
 Indiana Union Traction Company.  
 Indianapolis & Cincinnati Traction Company.  
 Indianapolis Columbus & Southern Railway.  
 Indianapolis Traction & Terminal Company.  
 Kokomo Marion & Western Traction Company.  
 Ohio Electric Railway.  
 Terre Haute Indianapolis & Eastern Traction Company.  
 Toledo & Chicago Interurban Railway.  
 Winona Interurban Railway.  
 Lebanon & Franklin Traction Company.  
 Toledo Urban & Interurban Railway.  
 Indianapolis & Louisville Traction Company.  
 Marion Bluffton & Eastern Traction Company.  
 Detroit United Railway.  
 Mahoning & Shenango Railway & Light Company.  
 Lake Shore Electric Railway.  
 Lorain Street Railroad.  
 Tiffin Fostoria & Eastern Electric Railway.  
 Western Ohio Railway.  
 Cleveland & Southwestern Traction Company.  
 Scioto Valley Traction Company.  
 Toledo & Chicago Interurban Railway.

The letter of criticism was prepared by a committee, as follows: William H. Forse, Jr., chairman, treasurer Indiana Union Traction Company; M. W. Glover, auditor Ohio Electric Railway; Joseph A. McGowan, treasurer Terre Haute Indianapolis & Eastern Traction Company. An abstract of the letter follows:

The five general accounts (of operating expenses), with the exception of "III—traffic expenses," are practically the same as have been used by the electric railways of the country for the past 15 or 20 years, and no criticisms can be made of these. It is in the subdivision of these five general accounts into 116 primary accounts, which are proposed for the larger electric railway lines as stated in the tentative classification found on pages 11, 12 and 13 of Circular No. 20, that we desire to respectfully submit our most serious and earnest objections.

While the tentative classification submitted for small railways names but 22 primary accounts, the circular states that the small lines are to follow the text descriptive of the primary accounts provided for the larger lines. The small line would therefore find little relief in the use of a restricted number of accounts, from the fact that the same departmental separation of charges and other objectionable features shown so clearly in the titles of the 116 accounts would be contained in the text of the 22 accounts.

In the first place, we doubt the wisdom or practicability of prescribing the same method of accounting for steam railways, electric railways, express companies, sleeping car companies, carriers by water and pipe lines. Outside the fact that all are transportation agencies, they differ in nearly every other respect. There can certainly be nothing in common between the fundamental accounts, for example, of electric railways and pipe lines or steamboat companies, and a general system of classification of accounts which attempts to include all of these classes of companies must necessarily be unsuitable and most unsatisfactory to all.

Those who are most directly concerned in securing accurate and comprehensive details of receipts and operating expenses have, for many years past, employed the best accounts procurable, whose experience embraces years of practical accounting, both with steam and electric railways, to so classify the operating expenses of electric railways as to clearly show all the necessary and important divisions of expenditures, and thus enable the owners, operators and investors—who certainly are most vitally interested—to gain a minute and comprehensive knowledge of their properties and at the same time be in a position to supply such information to the public or federal and state authorities.

For over 10 years past the electric railways of this country have been working with 38 accounts, which in the main

have served all purposes and have stood the test of time and actual needs. This classification has been adopted by a number of states as the standard form of accounts to be used by electric railways. To provide, however, for some new features of operation, such as the traffic department and the operation of interurban lines, the electric railways have used some additional accounts. These accounts are all embraced in the tentative classification of operating expenses which was prepared by the American Street and Interurban Railway Accountants' Association at the solicitation of the interstate commerce commission and adopted by the association at its convention held at Atlantic City, N. J., on October 15, 16 and 17, 1907. This classification comprises 50 accounts, which in our opinion ought to be the maximum number.

In all systems of scientific accounting there is recognized a final point of utility beyond which fine calculations, subtle distinctions and immaterial divisions are regarded as of no practical benefit, and as mere mathematical gymnastics. Such minutiae might be considered indifferently were it not that their compilation involves much extra time, labor and expense.

Applying this principle to many of the proposed accounts in Circular No. 20, we feel certain that our present force of clerks is wholly inadequate and would have to be greatly augmented in order to fulfill the requirements. To impose such a burden upon the electric railways would work a great hardship to which we feel they should not be subjected, unless the present system were inadequate or additional information could be secured thereby, which is not true in the present case; and if the proposed classification as given in Circular No. 20 were adopted, many of the accounts would represent at best a compilation of guesses.

To enumerate some of the many objectionable features in the classification printed in Circular No. 20, we might cite the joint facilities accounts, the separation of the cost of electric current used for various purposes; maintenance of electrical equipment of cars; the many subdivisions of damage to property, and injury to persons; the subdivision of insurance, printing and stationery, clearing accounts, etc. As a specific example of how one of the accounts proposed would work out in practice, which would also be true of a great many of the accounts proposed in Accounting Series Circular No. 20, the salary of a man whose authority would extend over maintenance of way, maintenance of equipment, power plant and car operation, such as division superintendent or division manager, in many instances would not exceed \$75 per month. Under the proposed classification, the salary of this man would be divided between accounts Nos. 14, 15, 24, 32, 63 and possibly 70 and 88, and perhaps some other accounts. The division of this would be merely guesswork, which is entirely unsatisfactory for statistical purposes. If a man were supposed to actually keep a record of how much time was to be charged each account, it would be necessary to furnish a timekeeper to go along with him and keep the record.

The objections referred to in this letter are more fully set out in the following:

#### Damages.

Accounts Nos. 15, "other maintenance of way expenses"; 24, "miscellaneous electric line expenses"; 32, "miscellaneous buildings and structures expenses"; 42, "injuries to persons (availability maintenance)"; 63, "other equipment expenditures"; 101, "loss and damage (to merchandise in transit)"; 102, "damages to property (transportation)"; 103, "injuries to persons (transportation)."

There is no objection to having one account for loss and damage to freight and other merchandise entrusted for transportation (account No. 101) and another account for injuries to persons and property. We do not think it practicable, however, to attempt a separation of damage to property and injuries to persons. For example, if a vehicle and driver were struck by a car, an arbitrary settlement might be made or one verdict be rendered covering the total amount to be paid for injuries to the driver and damages to the property. It would be impossible to state with accuracy the proportions of the total payment allotted for injuries to the person and damage to property, respectively.

Neither is it always possible to determine how the payments of claims should be classified. Two cases which occurred in Indiana will illustrate the point. A section man while engaged in track maintenance stood too close to a passing passenger car and was struck and injured. A section man while on a hand car was overtaken by a passenger car, a collision occurred and the section man and the motorman were injured.

The expense in connection with the settlement of all damage claims should be included in one account. Even if it were possible to class the actual payment of every claim, the expense bears no proper relation to the amount of the claim. It sometimes costs less to settle a very large claim than one

which is small and of doubtful legality. If an attempt were made to calculate the expense of every separate case, the result would be valueless and it could not possibly be accurate.

#### Stationery and Printing.

Accounts Nos. 15, "other maintenance of way expenses"; 24, "miscellaneous electric line expenses"; 32, "miscellaneous buildings and structures expenses"; 63, "other equipment expenditures"; 72, "traffic supplies and expenses"; 91, "stationery and printing (transportation)"; 113, "stationery and printing (general)."

A large percentage of the expense for printing and stationery is incurred in connection with car service, for tickets, transfers and station supplies, and the balance can rightly be put under general expenses. We therefore recommend two accounts, as follows: "Printing and stationery—transportation" and "printing and stationery—general."

To attempt to subdivide the expense for printing and stationery outside transportation, other than placing it in general expenses, would be wholly guesswork and of no practical good whatever.

#### Insurance.

Accounts Nos. 15, "other maintenance of way expenses"; 24, "miscellaneous electric line expenses"; 32, "miscellaneous buildings and structures expenses"; 63, "other equipment expenditures"; 100, "insurance (transportation)"; 110, "insurance (general)."

This is another item of expense that should not be departmentalized. Insurance is one of the general expenses of administration and as such should be contained in one primary account under general expenses. It is most essential, in the monthly reports to owners and operators of electric railways, that insurance be shown as one amount instead of being lost under the title of "miscellaneous."

#### Maintenance of Electric Lines.

Transmission lines—account No. 17, "high-tension transmission lines." Distribution system—accounts Nos. 18, "overhead feeders"; 19, "underground feeders"; 20, "track bonding." Conductors—accounts Nos. 21, "overhead trolley lines"; 22, "third-rail conductors"; 23, "underground conductor rails"; 24, "miscellaneous electric line expenses."

A separation of line maintenance expenses, if carried too far, would impair the value of the resulting statistics and we therefore recommend that but four primary accounts be used instead of the eight that are named. The accounts recommended, which would suffice for the largest lines, are as follows: "High-tension transmission," "low-tension transmission," "track bonding" and "miscellaneous electric line expenses."

#### Maintenance of Equipment.

Maintenance of service equipment—(maintenance of way and structures). Accounts Nos. 34, "snow equipment"; 35, "work cars"; 36, "electric locomotives (utility)"; 37, "miscellaneous service equipment." Maintenance of revenue equipment—(maintenance of equipment). Accounts Nos. 47, "passenger cars—repairs"; 48, "combination cars—repairs"; 49, "express cars—repairs"; 50, "mail cars—repairs"; 51, freight cars—repairs"; 52, "locomotives—repairs."

It is quite important to consider as one item of operation the cost of maintaining all classes of equipment. The accounts covering maintenance of service equipment should by all means be grouped under maintenance of equipment rather than maintenance of way and structures.

Work equipment is frequently converted into snow equipment by attaching a snow plow, and there is no need of separating these classes of (work and snow) equipment.

The classification provides separate accounts for the maintenance of passenger, combination, freight, mail and express cars. It is not stated, however, for electric railways, what distinction shall be made between express and freight cars, these terms being used synonymously in actual operation. A combination car is described as a passenger and baggage car. Some electric railways carry baggage in separate compartments, while others carry it in the smoker or other passenger compartment. The various classes of equipment should be divided into not more than three accounts, under the general account maintenance of equipment, viz.:

"Maintenance of passenger and combination cars"; "maintenance of freight, express and mail cars" and "maintenance of service equipment."

#### Maintenance of Electric Equipment of Revenue Equipment.

Accounts Nos. 53, "electric equipment of passenger cars—repairs"; 54, "electric equipment of combination cars—repairs"; 55, "electric equipment of express cars—repairs"; 56, "electric equipment of mail cars—repairs"; 57, "electric equip-

ment of freight cars—repairs"; 58, "electric equipment of locomotives—repairs."

Five accounts are provided for the maintenance of electric equipment of revenue cars (in addition to electric equipment of locomotives).

It has been found impracticable, in past years, to separate the cost of maintaining the electric equipment of the various types of cars, owing to the fact that the same motors are used alternately under different bodies. Electric railways do not usually have enough motors to equip all of the car bodies. Motors that are used under closed bodies and snow equipment in winter are quite frequently used under work and open passenger cars in summer and under freight cars when traffic demands it. These changes are made with considerable frequency and the identity of the individual motor is entirely lost. Accurate statistics would not be secured if this separation were made, and it is recommended that but one account be used, entitled "maintenance of electric equipment of cars."

#### Availability Maintenance Expenses.

(Group "E"—maintenance of way and structures). Accounts Nos. 39, "care of track"; 40, "removal of snow, sand and ice"; 41, "cleaning, sprinkling and oiling roadbed"; 42, "injuries to persons"; 43, "other miscellaneous maintenance expenses."

A new group of accounts that has not been applied to the steam railways is group "E"—availability maintenance expenses. It is probable that one idea which the commission had in mind in submitting this group of accounts, is to separate the amount expended for maintaining, and the amount expended for making the track available for operation. It would be quite a hardship to try to keep such expenses separately. The text contains many fine shadings. For example, if a section man inspects the track and tightens a bolt, which needs it, the cost of inspecting is to be charged to account No. 39, and of tightening bolts to account No. 8. In steam railway classification these are both contained in one primary account, namely, "roadway and track." Items that are so similar and so closely related should be included, for the purpose of securing accuracy, in one account. No good could possibly result in making a theoretical separation which cannot naturally be made, and we recommend that these accounts be merged into the other accounts grouped under "maintenance of way and structures," and elsewhere.

#### Joint Facilities.

Accounts Nos. 45, "maintaining joint tracks, yards and other facilities—Dr."; 46, "maintaining joint tracks, yards and other facilities—Cr."; 66, "maintaining joint equipment—Dr."; 67, "maintaining joint equipment—Cr."; 104, "operating joint tracks, yards and other facilities—Dr."; 105, "operating joint tracks, yards and other facilities—Cr."; 115, "general administration joint tracks, yards and other facilities—Dr."; 116, "general administration joint tracks, yards and other facilities—Cr."

The principle involved in the use of these accounts would cause much inaccuracy because of the conditions that are prevalent in actual operation. For example, we will say that a terminal owning carrier charges each of the companies using its terminal tracks and station a rental of two cents per passenger carried. The cost of maintaining the joint facilities will vary somewhat with the volume of traffic, but not entirely so, for if a few more or less passengers are carried, the greater or less amount of wear and tear (or power required) will hardly be noticeable. It will therefore be necessary to estimate the amount of additional expense incurred by reason of the use of terminal facilities by other carriers and these estimates will result in anything but scientific accounting. If the terminal owning carrier is not under the jurisdiction of the interstate commerce commission (or a state commission using this system of accounting) the interstate carriers using its tracks cannot compel the terminal owning carrier to give access to its books or aid in making estimates of the cost of maintaining, operating and administering the joint facilities in order to determine the amount that shall be charged in the lessee's operating expenses. These items will then be the result of guesses and thus be even less accurate than estimates.

As an example of the insurmountable obstacles that would be met in compiling this class of statistics, we will cite the conditions as they actually exist in the city of Indianapolis, Ind.

There are 12 interurban electric railway lines entering the city of Indianapolis, all over the tracks of the Indianapolis Traction & Terminal Company—a local street railway. The cars of these various interurban lines come from all directions, but use only certain streets or portions of streets of the local company. In some instances the cars of two or more companies run over the same street, although the cars of the dif-



ferent companies differ both as between companies and cars of the same company, in weight, types of motor, etc. and consume more or less power and cause a greater or less expense for cost of maintenance of track, electric line, etc. The city cars of the local company, which also differ as between themselves in the respects named, make use of the same tracks. At certain approaches to the terminal station in Indianapolis the cars may enter the station on different tracks from day to day. Each interurban line pays to the Traction & Terminal Company three cents per passenger for use of its tracks and one cent per passenger for use of terminal station. The question is, on what basis are the fixed charges and the different maintenance charges to be computed? No accurate figures could be obtained by taking the number of passengers hauled, as they vary continually, and, as the size and type of car differ, it could only be a mere guess to take the track-miles or car-miles as a basis. The giving of this information, even if estimated, by the Indianapolis Traction & Terminal Company to the interurban lines would be purely optional on its part and the interurban lines would have to accept its figures, if so given.

#### Power Transferred.

An account new to railway operation is No. 80, "power transferred." This provides that the cost of electric current or steam when used for other purposes than the propulsion, lighting and heating of cars operated for revenue shall be charged to the accounts benefited by the service and credited to this account. Thus, if stations are lighted by electric current, shops heated with steam, work and line cars lighted by electric current, or machinery driven by power house steam, this power must all be measured and the cost determined. Even if it were practicable to have meters to measure this current there would be wide variations in methods used in compiling statistics, caused by the fact that transmission losses and the drop of voltage vary to such an extent as to require a great deal of estimating.

Suppose, as is frequently the case, that lathes, planers, drills and other shop machines are belted to a line shaft which is rotated by a steam engine driven with power house steam. At various times during the day different machines are turning axles and wheels, finishing trolley wheels and bushings, and doing general repair work on track and line material and power house equipment. This is but one example of many that might be used to show the fallacy of using such an account as "power transferred." Statistics that were a compilation of guesses would be valueless, and these costs could not be secured except by using some theoretical bases from which to make guesses by the "rule of thumb."

#### Cost of Electric Current Used for Lighting.

The "cost of electric current used for lighting passenger and other cars" is provided for in account No. 95. Most of the text of this account, like others, is copied from the steam road classification which provides that the cost of lighting cars shall be included in account "car supplies and expenses." In the operation of street railway and interurban lines the usual method followed is to have one central power station from which power is transmitted over considerable distance—in many cases from 100 to 150 miles. This current is usually transformed, at substations located several miles apart, into direct current and is used primarily for supplying power to the motors for propelling the cars; but it is also used for furnishing current for the lighting of cars and likewise for operating the motor of the air compressor for furnishing air to the air brakes. The current is also used, in many instances, for heating the cars. It would be wholly impracticable to attempt to separate the power for lighting, for the propulsion of the cars, for operation of the air brakes, and for heating. To make such a division it would be necessary to have meters in the cars to measure the current consumed for lighting, heating, air brakes and the propelling motors. At the present time meters have not been so perfected as to stand in actual daily practice the jolts and jars which would be incident to the operation of the cars and the readings would thus be absolutely unreliable.

#### Cost of Electric Current Used for Power.

Accounts Nos. 8, "roadway and track"; 10, "bridges, trestles and culverts"; 14, "telegraph and telephone lines"; 40, "removal of snow, sand and ice"; 92, "clearing wrecks."

Accounts Nos. 8, 10, 14, 40 and 92 provide that the cost of power consumed by cars in maintaining track, roadway, trestles, culverts, telephone and telegraph lines, in the removal of snow and ice and clearing wrecks, shall be prorated among the various accounts. This is no doubt suggested by the fact that the steam road text for these accounts is copied almost verbatim, and the addition, "cost of power," inserted in each. Including such accounts in an electric railway classification is probably due to the fact that the fuel used in

operating steam locomotives for the various kinds of work is thus prorated. Conditions, however, on electric railways are entirely different, as recited in our objections under (cost of electric current used for lighting) account No. 95. It is evident that very slight consideration has been given to actual electric railway operation, for no mention is made in this way of current consumed by cars used in line maintenance, sprinkling and oiling.

#### Clearing Accounts.

These accounts illustrate quite forcibly the extent to which statistical tabulations may be carried, the very slight advantage to be gained by their use, and the vast amount of additional work required by any theoretical plan of accounting which departmentalizes and separates into minute portions the statements of results expressed in figures. A concrete example will illustrate. The joint expenses of purchasing and of operating storerooms on an electric line will ordinarily not exceed one-half of 1 per cent of the operating expenses. If clearing accounts were used this one-half of 1 per cent would be carried into the account "store expenses." At the end of each month or year the accountant must apportion to each account charged with material issued a percentage of the one-half of 1 per cent that is just and equitable in view of the services rendered by the storekeeper and his staff. But this is not all. The percentage of this one-half of 1 per cent that is represented by the purchasing agent's salary and expenses must be separated from the other portion of the expense, and each account that has received the benefit of the purchasing department's services must be allotted its portion of the expenses, with due regard, however, to the material that was not purchased by the purchasing department, but ordered in an emergency by some other department.

Such a system of accounting would involve a great amount of estimating and would be very expensive in its operation. The clearing accounts should all be eliminated, in our estimation.

#### Outside Operations.

Accounts Nos. 44, "other than railway operations—Cr." (maintenance way and structures); 65, "other than railway operations—Cr." (maintenance equipment); 81, "other than railway operations—Cr." (transportation).

This classification introduces a set of accounts new to railway operation, namely, credits for "outside operations." We are not provided with a classification of electric railway revenue and cannot predict what will be considered an "outside operation" for electric railways by the commission. The principle of the outside operations accounts is, that operating expenses shall be credited with the exact cost of products sold and the difference between that cost and the amount received shall be credited to income account. This system of accounting has not heretofore been closely followed by railroads, probably for the very good reason that it is so impracticable in operation, although theoretically a good arrangement. The scheme provides, for example, that if power is used for lighting a park, the outside operation (park) is to be charged with the cost of the current used. It is not stated whether cost is to include a portion of the expenses of railway administration as well as power plant expenses, but in a general way it is stated that the cost is "cost of production." This item will be quite important to those companies conducting a general lighting business, especially if it is decided that the sale of power for various purposes is to be considered an outside operation.

It is generally understood that it is impracticable to attempt a separation of some features of railway operation, between the part used in transportation and the part used for other purposes. Thus, in steam railway practice, it has not been found practicable to endeavor to separate the expenses of the electric telegraph used by the carrier for transmitting its own messages from the expenses of the same lines used in transmitting commercial messages for the public (see steam classification of operating revenue, first issue, page 15).

This principle applies with particular force to electric current as used in railway operation—when the difficulty of measuring and of accounting for the leaks and losses of current is considered it will readily be conceded that the separation cannot be made without guessing and estimating.

#### Express Service.

Account No. 98. This account includes the wages of motormen and messengers in express service. This seems to be a duplication, as accounts Nos. 85 and 87 include wages of motormen and other trainmen in express service. Another item that should not be included in this account is wages of warehouse men. In the majority of cases when express is handled by an electric railway, the stations where express matter is handled are the same as used for freight and passenger business, and it would hardly be possible to show sep-

arately the pay of "warehouse men," any more than other items of expense incurred in connection with the station as a whole.

#### Tentative Classification of Expenditures for Road and Equipment.

The general criticism of the classification of operating expenses applies with equal force to the tentative classification of expenditures for road and equipment, namely, the superabundance of accounts and the too minute separation of charges.

Account No. 61 is followed by a note stating that "discounts on securities issued for construction purposes or to raise funds for construction should not be charged to this account or considered as a proper charge against construction." This is such a departure from the practice of past years that it deserves special consideration. It has heretofore been considered that discount on securities issued for construction purposes or to raise funds for construction is a part of the cost of financing and constructing the property. Discount is somewhat analogous to the interest accruing on the securities during the construction period, this being an item of construction cost.

The classification of construction and equipment accounts adopted by the Street Railway Accountants' Association of America has been found practicable in operation and its further use is recommended. It is composed of 15 accounts.

#### NEW YORK PUBLIC SERVICE COMMISSION TENTATIVE ACCOUNTS FOR ELECTRICAL AND GAS CORPORATIONS.

The New York public service commission, second district, has promulgated a tentative scheme of accounts for electric lighting, heating or power and gas corporations. The classifications were prepared by W. J. Meyers, statistician of the commission, and criticisms by companies within the jurisdiction of the commission are invited. The circular grades corporations into four classes, as follows: With annual gross revenue of below \$10,000; with \$10,000 or less than \$100,000; \$100,000 or less than \$1,000,000; and \$1,000,000 or over. The gross revenue is the basis for determining the classifications to be used. An abstract of some of the important features of the system follows:

To the capital account "Franchises (Electric)" is to be charged, as provided by the public service commissions law, "the amount (exclusive of any tax or annual charge) actually paid to the state or to a political subdivision thereof as the consideration for the grant of such franchise or right" as is necessary to the conduct of the corporation's electric operations.

#### Suspense Accounts.

When any expenditure is made the appropriate disposition of which is not yet determinable, or when any loss occurs which under the rules of the public service commission may be spread over a period of time, or when any debit made for any other reason may be amortized, such expenditure, loss or other debit shall, except as otherwise directed, be charged to an appropriate account in this group of accounts.

The seven accounts provided in this group are entitled: "Unamortized Discount on Debt."—When funded debt securities and other evidences of indebtedness are disposed of for a consideration whose cash value is less than the par value of the securities or other evidence of indebtedness and the interest thereon accrued at the time the transfer takes place, the excess of such par value and accrued interest over the cash value of the consideration received shall be charged to this account. At or before the close of each fiscal period thereafter a proportion of such discount based upon the life of the security to maturity shall be credited to this account and charged to the account "amortization of discount on debt" in "income" account.

"Unamortized Discount on Stocks Outstanding."—If any stock was disposed of prior to July 1, 1907, for a consideration whose cash value was less than the par value of such stock, the excess of the par value of the stock over the cash value of such consideration shall be charged to this account. The conditions under which and the rate at which discount on stocks issued shall be amortized, if at all, are solely within the discretion of the corporation. Such amortization shall be effected, if at all, through the proper "appropriation" account.

"Supersession Suspense."—When any tangible capital is taken out of service because superseded by new capital more abreast of the progress of the art or better adapted to the cir-

cumstances and conditions of the enterprise, there shall be charged to this account the original cash cost of such superseded capital (estimated, if not known, and where estimated the facts upon which such estimate is based shall be shown in the entry) less the sum of: (i) Obsolescence and unrepaid wear and tear accrued prior to ..... [the date on which this accounting order will become effective] on such capital so superseded; (ii) amounts charged in respect of such capital to the account "amortization of tangible capital—estimate" (an operating expense account) since ..... [the said date]; and (iii) the proceeds of sale (if any) or the salvage or scrap value at time of retirement of such capital so superseded. To this account shall be credited in the month in which any charge is made as above directed and each month thereafter until the whole charge is amortized or wiped out not less than ... per cent of such charge, and the amounts credited to this account shall be concurrently charged to the account "supersession amortization" (an operating expense account).

"Extraordinary Casualties to Capital Suspense."—When any tangible capital is destroyed or irreparably damaged through any extraordinary casualty there shall be charged to this account the original cash cost of such capital (estimated, if not known, and where estimated the facts upon which such estimate is based shall be shown in the entry) less the sum of three matters similar to those provided in "supersession expense."

"Other Extraordinary Casualties Suspense."—When any extraordinary casualty occurs causing loss other than that of capital, the total amount of such loss other than capital, estimated if not known, shall immediately be charged to this account, and the same amount credited to an account called "reserve for other extraordinary casualties."

"Extraordinary Governmental Requirements Suspense."—When any extraordinary governmental requirement is made upon the corporation, the total expense caused thereby shall be charged to this account, and in the month when any such charge is made, and in each month thereafter until such charge is completely amortized or wiped out, there shall be credited to this account not less than ... per cent of such charge, and the amounts credited to this account shall be concurrently charged to the account "extraordinary governmental requirements amortization" (an operating expense account).

"Other Suspense."—To this account shall be made all debits not elsewhere provided for and the proper final disposition of which is uncertain.

"Questionable Debts."—When any debt owing to the corporation is so far overdue as to need special effort for collection, it shall be credited to the account in which theretofore charged, and charged to the account "questionable debts," and there held during the period of special attention. This account does not include so-called "uncollectible bills," for which see the account "uncollectible bills" among revenue accounts.

"Bad Debts."—When any questionable debt becomes in the opinion of the corporation practically worthless it shall be credited to the account "questionable debts," and charged at a nominal amount to the account "bad debts," the difference between the par value of the debt and such nominal amount being charged to the account "bad debts written off," which account shall be closed at the end of each fiscal period into the "surplus or deficit" account.

Reserves shall be classified as permanent and temporary. By permanent reserves are meant those that must be maintained intact during the life of the corporation. Permanent reserves shall be classified into the two classes, premiums on stocks outstanding and other permanent reserves. Premiums on stocks outstanding shall be subclassified with respect to the several classes of stocks. When a premium is realized upon an issue of any particular class of stock, such premium shall be credited to the subaccount above provided for such class of stock, and such credit shall remain in such account so long as such stock remains outstanding.

To the account "other permanent reserves" shall be credited all reserves not above provided for created to remain intact until the dissolution of the corporation. A separate subaccount shall be created for each particular purpose for which a reserve is raised, and the purpose of the reserve shall be designated in the title of the account thereof and shall be expressed in full in the first entry in such account.

By temporary reserves are meant those that are not intended to remain intact during the life of the corporation. Temporary reserves shall be classified as contractual reserves and non-contractual reserves.

A comparison of the balances in the foregoing accounts at any particular moment will, if the accounts have been properly kept, show the then existing condition of a corporation's affairs so far as such condition can be shown through the accounts.

**SOME USEFUL SHOP SCHEMES.**

BY H. M. ASLENFELTER, SUPERINTENDENT OF MOTIVE POWER CHICAGO SOUTH BEND & NORTHERN INDIANA RAILWAY.

The Chicago South Bend & Northern Indiana Railway Company operates both interurban and city service on its various lines in northern Indiana. In the South Bend shops of this company are a number of kinks for facilitating repair work, oiling and inspection that may be of general interest.

**Armature Bearing Oiler.**

Accompanying sketches show a constant feed oil cup designed with a view to keeping the armature bearings clean and well lubricated. Referring to the illustration it will be noted that the oiling device comprises a grease cup mounted on the top of the journal box casting and containing a block

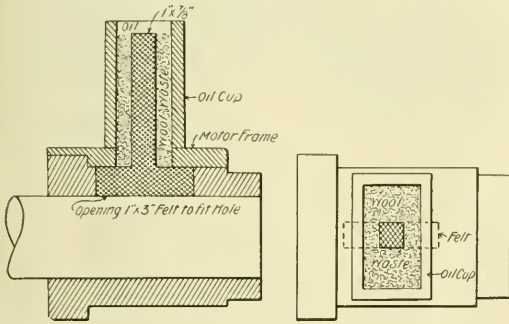

South Bend Shop Schemes—Armature Bearing Oiler.

of felt for distributing the oil. This piece of felt has the shape of an inverted letter "T." The lower part of the felt is 1 inch square in section and 3 inches long, resting directly

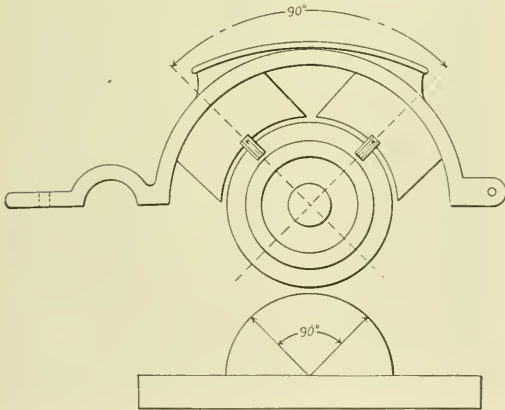

South Bend Shop Schemes—Templet for Setting Brush Holders.

on the revolving shaft. This felt block closely fits a 1 by 3 inch hole cut through the bearing and its shell. The upper part of the felt oil distributor is 1 by 3/8 inch in section, held in the center of the oil cup by a surrounding packing of waste. In the summer cotton waste is used for packing and in the winter wool waste is used, so that the oil may always flow freely.

Statements are presented herewith showing the cost of lubrication for the 57 cars operated in both city and inter-

urban service during the months of May and June, 1907, and January, 1908. These statements include the total lubrication of motors, car journals and air compressor motors. Of the 57 equipments operated 25 are 4-motor cars with air brakes.

**May, 1907.**

Mileage, 213,577; oil, 423 gallons; journal grease, 528 pounds.	
Cost of car oil per 100 car-miles.....	\$0.0416
Cost of journal grease per 100 car-miles.....	0.0111

Total cost of lubrication per 100 car-miles.....\$0.0527

**June, 1907.**

Mileage, 213,979; oil, 334 gallons; journal grease, 735 pounds.	
Cost of car oil per 100 car-miles.....	\$0.0327
Cost of journal grease per 100 car-miles.....	0.0154

Total cost of lubrication per 100 car-miles.....\$0.0481

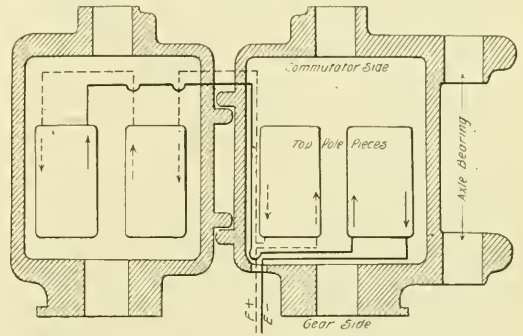

South Bend Shop Schemes—Sketch of Motor Connections.

**January, 1908.**

Mileage, 183,380.4; oil, 317 gallons; journal grease, 220 pounds.	
Cost of car oil per 100 car-miles.....	\$0.03457
Cost of journal grease per 100 car-miles.....	0.00479

Total cost of lubrication per 100 car-miles.....\$0.03936

**Motor Connections.**

To afford the simplest possible guide for a repair man whose duties may require him to assemble a motor, pencil sketches are made showing by means of differently colored lines the motor connections. One such sketch is reproduced

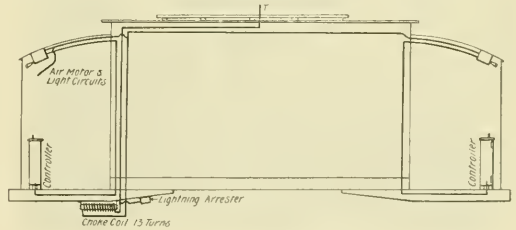

South Bend Shop Schemes—Connections for Lightning Arresters.

herewith and its simplicity is apparent. Similar sketches are furnished any employe who might, in emergency, be required to make motor connections. Each sketch is 12 by 7 inches in size, made on heavy paper, with one-half of the leads shown in black and one-half in red. In this way there is no chance for confusion. In the sketch presented herewith the red lines appearing on the diagram are reproduced dotted. The men about the shop are encouraged to make these and similar sketches and hand them to the foreman for checking.



is had from bent poles, because the adjustment is such that the tension remains practically uniform throughout the raising and lowering of the trolley pole. The rebuilding of these trolley bases was done at a cost of less than \$2.00 each.

Reference to the detail sketches will show the method of oiling the base. The interior of the post is filled with wool waste saturated with oil. This oil is conveyed to the bearing surface by means of pieces of felt fitted in openings cut through the side of the post. When so equipped it is necessary to oil the base but once a month.

#### Boring Bearings.

An ordinary drill press is used to bore both journal and armature bearings. In the chuck of the drill press is placed an adjustable reamer. A facing tool on the same stock serves to face the end and complete the surface finish in one operation when the reamer has passed fully into the bearing. The facing tool is ground to cut a fillet of the proper radius between the end face and inside surface of the bearing. No jig is used to hold the solid bearings, but a hook is slipped over the shell. The end of this hook fits in the hole in the bearing

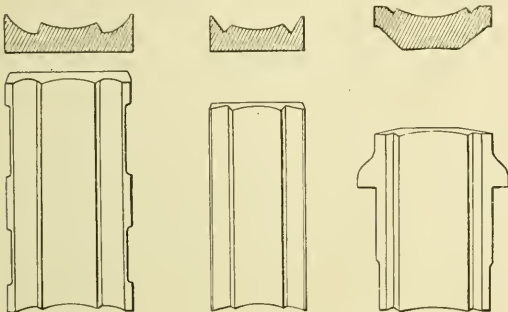

South Bend Shop Schemes—Types of Crown Bearings.

shell and the other end rests against the drill post, thus keeping the bearing from turning.

The journal bearings are also finished on a drill press, being supported in a jig, as shown in one of the accompanying half-tone engravings.

### CENSUS OF ELECTRIC RAILWAYS.

The United States census bureau is taking the census of electric railways. The statistics relate to the year ending December 31, 1907. The canvass is made under the supervision of W. M. Steuart, chief statistician for manufactures of the census bureau. The form of report which has been issued for electric railways stipulates that "the answers in regard to financial matters, other than capitalization, will be held absolutely confidential; the separate reports will be combined so as to show totals for all companies in the different states. The information will be used only for the statistical purposes for which it is given." The list of companies to which requests for information have been sent contains the names of 2,190 companies, including subsidiaries, but many of the latter will be eliminated. In the previous census there were 987 operating and lessor electric railways.

The instructions issued by the bureau to special agents state in part:

The schedule is prepared primarily for railways operated by electricity. All classes of street railways, whether operated in whole or in part by cable, animal, steam or other motive power, and also interurban railways, must be reported on it.

When independent street railways have recently been combined under one ownership one report may be made for the operations of the entire system, provided the roads which

were formerly operated as independent lines are located in the same city or immediate vicinity, but if the system of accounting will permit of the preparation of separate schedules, a separate report should be secured for each of the constituent companies.

The track reported must be given in single-track miles and decimals of a mile carried to two places. The statistics for miles of track must be shown by states.

Give the maximum and minimum weight per yard of the steel rails in use at the time of making the report. A girder rail weighs from 38 to 135 pounds to the yard; T-rails from 15 to 91 pounds per yard. These weights should be used by the agent only to detect wide variations, for which explanation should be made.

The answer to the inquiry concerning overhead electric line construction must show the length of construction. Considering all systems reported at the census of 1902 there were on the average about 52 poles to each mile of line. A wide departure from this average should be explained.

#### Car Mileage.

It is an ordinary practice for street railways to keep an account of this mileage. Where it is not known the car mileage can be estimated fairly well by ascertaining the number of round trips daily on each line or branch of the system and multiplying this by the length of the respective trips. The daily average should be multiplied by the number of days the road was in operation during the year to obtain the total for the period covered by the report. The earnings per car-mile should as a rule be between 10 and 40 cents.

The use of "trailers" is a source of confusion in computing car mileage. As a rule the individual car should be considered as the unit, but when the trailers are small and it is the practice of the company to consider the motor car and the trailer as one car in making the computation, the company's figures should be accepted.

The average number of fare passengers per car-mile in 1902 was 4.26; the cars were run, therefore, on an average, nearly one-fourth of a mile for each fare collected. An extreme variation from this average should be questioned and explained.

The inquiry, "car hours," is not obligatory, but is employed by some roads. Such roads, however, are large and the system of accounts is likely also to include the "car mile." At the census of 1902 the roads which reported car-hours indicated an average of 33 fare passengers per passenger car-hour.

#### Parks or Pleasure Resorts.

The agent must not include parks and pleasure grounds belonging to the community or other interests and entered by street railway systems; but if the company pays for the privilege of touching at these points, a memorandum should be made of that fact, and the number of passengers thus specifically delivered within such pleasure resorts should be noted, if possible, as distinguished from traffic on lines terminating outside public parks or running around them.

#### Financial Operations.

The office has adopted the system of accounting devised by the American Street and Interurban Railway Accountants' Association. The schedule used at the census of 1902 required a separate amount for each item under "cost of construction and equipment." The majority of the companies could not make the segregation and therefore only the totals are required at this census.

The combined balance sheets of all roads must result in showing the total capital stock and funded debt of both operating and leased roads, therefore the proportion of these securities which are owned by street or electric railways should be shown separately, so that a net figure for each kind of capital can be presented. Some companies may consider their own stock or bonds held in the treasury as an asset, but in making up the balance sheet such securities should be treated as not issued and should be omitted from both sides of the balance sheet statement. If there is a profit and loss deficit or if a large amount is reported for "other permanent investments," the reason for the loss and the nature of the investments should be given. Items such as "purchase of completed road" or "payment for franchise" must be included as "cost of construction, equipment and real estate" and not as "sundries" or "other permanent investments."

The Philadelphia Rapid Transit Company announces that Willow Grove park will be opened for the season of 1908 on Memorial day, May 30. Engagements have been made with Pryor's band, Victor Herbert's orchestra, the Theodore Thomas orchestra and Sousa's band to furnish the musical entertainment for the season.

## SHORT TALKS WITH THE CLAIM INVESTIGATOR—III.

BY F. W. JOHNSON, ASSISTANT GENERAL CLAIM AGENT PHILADELPHIA  
RAPID TRANSIT COMPANY.

The average claim investigator does not begin to appreciate the unlimited possibilities to be derived from the use of tact, resourcefulness and originality in connection with his work among witnesses and claimants.

Webster defines "tact" as "a peculiar skill or faculty; nice perception; ready power of appreciating and doing what is required by circumstances."

The last two lines of this definition seem to be particularly applicable to the case in point. The ability to quickly grasp a situation and to formulate a plan of campaign applicable to the peculiar circumstances of each individual case is of the utmost importance in handling refractory witnesses or claimants.

It is a serious mistake for any investigator, no matter what his length of service in claim work has been, to attempt always to handle witnesses and claimants along identically the same lines. The various elements encountered in claim work have to be approached and handled in various ways, if good results are to be obtained, and it remains for the claim man to decide almost at a glance upon the proper course to pursue in opening up negotiations with each individual claimant or witness.

A knowledge of human nature is a valuable asset in this connection. Most men pride themselves upon being fairly accurate judges of human nature, to a greater or less extent, but the sad fact remains that if such they are, they derive but little actual benefit from their talent. The possession of this faculty is best manifested by an ability to put it to some practical use.

## Necessity for Tact.

We see ample evidence of its absence in the person of the claim man who pursues the same stereotyped style in his work, day after day, making practically no changes or allowances for varying conditions, circumstances or individuals. He lacks adaptability in thus attempting to transact business with but a single mode of procedure, whether the claimant be male or female, professional man, business man or laborer. They all look alike to him, and the advantages possible through a change of tactics from time to time, to accommodate ever-changing conditions, are entirely overlooked.

As an illustration of this tendency we will take the case of X, who has been identified with claim work for some years. Nature set him up in business with a superabundance of self-confidence, which characteristic quickly becomes apparent in his interviews with claimants. With a certain type of people his breezy way of getting down to business acts like a charm, and not infrequently serves to sweep opposition aside as though it were so much chaff. The claimant readily falls into line and an amicable adjustment follows nicely and easily.

But then there is an entirely different class of people with whom X has to transact business. There is the claimant or witness, for instance, who carries a perpetual chip upon his shoulder and who fires up like a flash should any representative of the local traction company approach him in any manner other than that of a humble and lowly servant of the public.

This latter class of claimants frequently resents the brisk, breezy manner of Mr. X. They have a way of standing constantly upon their dignity and, besides, they haven't forgotten the fact that a certain conductor carried them a block beyond their destination summer before last. Whatever may be our own private opinion of such genial dispositions, the fact nevertheless remains that people of this stripe require delicate handling, if anything other than a cold turndown is to result from the interview. Unfortunately, X fails to appreciate this very fact. He neglects to shorten sail when dealing

with people who don't take kindly to a good, hearty hand grasp and a cordial greeting. As a natural consequence, sparks fly, personalities are exchanged and the interview is over. Incidentally X fails to make good in so far as the desired release or statement is concerned.

As an instance of just the reverse, consider the style followed by investigator Z. He likewise has been associated in claim work for some years and, in so far as temperament is concerned, is virtually the opposite of X, being of a naturally retiring and reserved disposition. But he also has a stereotyped way of approaching and of handling his people, whether they be clergymen, bartenders, retired capitalists or members of the local cab drivers' union. He travels along a beaten path and, though storm signals may be flying, he fails to rise to the occasion by changing his tactics. As may be expected, he also is very successful with some people, while with others he proves a dismal failure.

In dealing with witnesses, and more particularly claimants, investigators should realize that the other fellow is hard at work "sizing up" the representative of the company from the moment when he first steps inside the door. Hence, if a man follows one certain style or method all of the time, in dealing with all claimants, he unconsciously grows mechanical in his work, neglects to make use of his ability to size up and to weigh his people, and in time becomes as an open book in the hands of shrewd claimants.

It is the ability to size up each individual batsman, and to serve him accordingly, that distinguishes the winning pitcher from the mediocre man. The "box artist" who possesses but one curve, or one style of delivery, cannot be expected to successfully compete with the versatile man who always has a variety of curves on hand, together with a deceptive change of speed, all of which are available for varying conditions.

It is much the same in claim work. The man who has but one style of approaching and of handling people, regardless of the circumstances surrounding each individual case, is unconsciously laboring at a disadvantage. With respect to the two illustrations cited, it is a self-evident fact that both men would have been stronger had they but appreciated the value of tact and of originality in their work among claimants and witnesses. With such an appreciation X at times would instinctively have adopted the style invariably followed by Z, and vice versa. Each lacked adaptability and his field of action as a claim man was thereby restricted unnecessarily.

## A Clever Ruse.

There comes to mind an instance which occurred some years ago which, though of a somewhat unusual character, nevertheless bears upon the point in question. A certain investigator has unexpectedly been pressed into service as an adjuster. Upon the list of injured parties as supplied him appeared the name of a Mr. R.

The adjuster called upon Mr. R. talked shop for a while and soon found that he had a hard task before him. Negotiations were about to be stopped, when the adjuster laughingly suggested a friendly round-or-two with the gloves, having learned in conversation with Mr. R. that this pastime was a sort of specialty with him. Mr. R. readily assented and offered no objection to the adjuster's calling in a number of men from the immediate neighborhood to act as "an audience," as the latter jokingly put it.

The claim man proved to be nervy. Though he knew absolutely nothing about boxing, he nevertheless was willing to take a chance. He had no superfluous time to speak of, for Mr. R. kept him busy picking himself up off the floor. The next morning he arrived at the office with both eyes black. The facts eventually came out, the adjuster modestly observing that, while he hadn't been able to arrange for moving pictures of the mill upon such short notice, he nevertheless had taken the precaution to provide for a sufficient supply of witnesses to prove Mr. R.'s excellent physical condition as demonstrated with the gloves. Mr. R. afterward preferred

to adjust his claim for a reasonable figure, rather than to have the facts passed upon by a jury.

This example, though of a rather humorous nature, nevertheless fully illustrates the possibilities for "scoops" in claim work for the man who is resourceful, and willing to take a chance occasionally with new methods of procedure.

This recalls to mind still another example of originality and resourcefulness upon the part of an investigator, which took place some time ago. A claim of rather serious moment had been presented to the company, and after due investigation it had been adjudged a proper matter for settlement. Several men had been assigned to the case, without results, when it was finally placed in the hands of S.

#### An Example of Resourcefulness.

Bright and early the morning following S. walked confidently up the front steps of the claimant's house and rang the bell. Upon explaining his mission his reception proved even more distressing than he had anticipated, for, without further comment, the door was closed in his face with a slam. The unusually severe character of that "slam" gave him his cue upon the instant.

Whipping out his pocket handkerchief, he swiftly bound it around several fingers of his left hand, simulating meanwhile indications of intense agony, expressly designed for the benefit of the family, whom he knew full well to be just behind the closed blinds of the front room, from which vantage point they were prepared to witness his withdrawal.

A second handkerchief quickly followed, in order fully to stanch the flow of imaginary blood. Thus temporarily relieved, he again rang the door bell. Their curiosity aroused, the family hastened to respond. Controlling his suffering as best he could, he begged of them a few drops of arnica for his hand, explaining that the unexpected closing of the door had caught him unawares and had crushed two of his fingers.

He forthwith was invited into the house and supplied with arnica, with which he liberally dampened the handkerchiefs covering his hand. Apparently the arnica had a soothing effect, for a very pleasant hour's chat followed, during which the family were agreeably surprised to find, contrary to the opinions of ill-advised friends and neighbors, that the company's representative was only a good-natured, well-bred young business man, and not the desperado that had been pictured to them. Upon learning that the company stood ready to do what was fair and just in the matter, negotiations were opened up and the matter disposed of in a manner entirely satisfactory to all concerned.

While the incident entailed the employment of a little deception, it nevertheless was of a harmless character, and was undoubtedly justifiable in view of the rank discourtesy and unfairness displayed by the family in deliberately slamming the door in his face, without cause or justification.

Be versatile, original and resourceful in your work. Get out of the rut and stay out. Cultivate tact and diplomacy. Good business principles are just as applicable to claim work as to any other branch of commercial life.

In short, use your brain more, and your feet and hands less.

The United States consul at Pretoria, Transvaal, South Africa, reports that the town council of Pretoria is contemplating a change in the equipment of the street car line to electric power, and requests that American manufacturers of cars, overhead material and rails furnish information as to the probable cost of an equipment of from 9 to 15 miles. The council desires information as to cost per mile for track and overhead, and also cost per car for 10 or more. The type of car preferred is the ordinary light car that is used in the smaller cities of America. Letters and catalogues may be addressed to Dr. S. R. Savage, mayor of Pretoria, or to the American consul at Pretoria.

#### CLEVELAND STREET RAILWAYS LEASED TO MUNICIPAL TRACTION COMPANY.

The long controversy between the Cleveland Electric Railway and the city of Cleveland was ended on Monday night, when all of the details of the settlement under the holding company plan were finally arranged. As previously stated in these columns, the principal feature of the settlement consists of a lease of the entire street railway property of Cleveland to the Municipal Traction Company, a holding company representing the city, which has promised to operate the street railway lines of Cleveland without profit to itself at a 3-cent fare.

Since December 4, 1907, Mayor Tom L. Johnson, representing the city, and F. H. Goff, representing the Cleveland Electric Railway, have been engaged in determining upon a valuation of the Cleveland Electric Railway property as a basis for the lease. On Tuesday, April 21, Mr. Goff submitted a price of \$55 a share, after deducting indebtedness. The mayor and the city council desired to submit the proposition to the people and during the remainder of the week 16 mass meetings were held in various parts of the city. The expression of the people was almost unanimously in favor of a settlement and on Monday the final details were arranged. During the day stockholders' and directors' meetings of the various companies involved were held for the purpose of approving the plan and all litigation between the city and the companies was dismissed.

#### Details of the Settlement.

The stockholders of the Forest City Railway took the necessary steps to transfer the property to the Cleveland Electric Railway and approved the purchase of the Low Fare Railway for \$64,000. The lease of the Forest City Railway to the Municipal Traction Company, which was made on July 2, 1906, was canceled and the action taken last week in increasing the stock to \$6,000,000 was rescinded.

Stockholders of the Cleveland Electric Railway met and reduced the capital stock from \$23,400,000 to \$12,870,000, the agreed valuation of the property at \$55 a share, after deducting an indebtedness of \$9,314,131. New stock is to be exchanged for the old at the rate of 55 shares for 100. After a recess during which the directors passed resolutions authorizing the lease to the Municipal Traction Company and the purchase of the Forest City Railway the action of the directors was ratified and authority was given to President Andrews and Secretary Davies to execute the contracts. An increase of capital stock to \$35,000,000 was then authorized. The increase is to provide for the purchase of the Forest City Railway and to provide sufficient treasury stock to meet the cost of improvements and to retire certain outstanding bond issues. The stock of the Forest City Railway was acquired by exchange of stock at par for \$1,895,600. It was then voted to reduce the number of directors from 17 to 7. The stockholders will meet again on June 2 to change the name of the company to the Cleveland Railway Company.

The valuation of the Cleveland Electric property as finally decided upon includes \$17,112,098 for physical property, \$4,976,701 for inside franchises and \$95,332 for good will, leaving \$12,870,000 as the value of the 234,000 shares of stock at \$55 a share, after deducting the indebtedness of \$9,314,132. No value was allowed for outside franchises.

At the meeting of the city council in the evening the plan of settlement was formally approved and the security franchise to the Cleveland Electric Railway was passed. Before the security grant was discussed communications were received from the Low Fare Railway relinquishing its franchises and from the Forest City Railway surrendering the franchises on Woodland avenue and other west side streets, which were granted on April 16.

An amendment was offered to the security franchise fixing the rate of ticket fares at six for 25 cents. A small

minority advocated seven tickets for 25 cents, but the ordinance was passed, under suspension of the rules, at the former rate. It will be remembered that the Cleveland Electric Railway's original franchise application last year was at the rate of seven tickets for a quarter. The change to six for a quarter was made in order to secure a better market for the new securities. The franchise runs for 25 years and is renewable every 10 years for a similar period. Provision is made for purchase by the city at the expiration of the grant. The cash fare is to be five cents. In return for the new franchise the Cleveland Electric Railway surrendered all its existing franchises. In case the Municipal company forfeits the lease the Cleveland Electric Railway may operate under the security grant. The ordinance was signed by Charles Lapp, the vice-mayor, Mayor Johnson having absented himself temporarily in order that the validity of the grant might not be affected by his connection with the holding company.

Certified copies of the lease and the security franchise were then exchanged and President Andrews formally turned over the property of the Cleveland Electric Railway to President du Pont of the Municipal Traction Company.

#### Municipal Traction Company.

At the conclusion of the peace arrangements on Monday night Mayor Johnson announced the increase of the directorate of the Municipal Traction Company from five members to nine by the election of himself, F. H. Goff, Newton D. Baker and B. T. Cable of Rock Island, Ill. The old members are: A. B. du Pont, Edward Wiebenson, C. W. Stage, Frederic C. Howe and William Greif. The board is self-perpetuating and each holds an equal amount of the capital stock of the company, which is non-transferable and is limited to \$10,000. The company is to be operated without profit and any excess of net earnings over the 6 per cent required to pay the rental is to be applied either to a reduction in fares, improvements or to a sinking fund for the purpose of purchasing the property. The principal provisions of the lease under which the company will operate are as follows:

The lease runs for 50 years from January 1, 1908, and may be extended upon expiration for another 50 years. At any time during the life of the lease or a renewal the Municipal company or the city may purchase the property at 10 per cent above the par value of the outstanding stock, assuming the liabilities, or the Municipal company may assign the lease to the city. In case the Municipal company purchases the property it shall do so subject to the right of the city to purchase on the same terms plus the cost of any additional betterments, provided the city shall obtain the right of municipal ownership.

The Municipal company is to pay a rental of 6 per cent per annum on the outstanding capital stock of the Cleveland Electric Railway and an amount sufficient to pay the interest on the bonded and floating indebtedness. It is also required to keep a maintenance and renewal account to which will be credited each month and charged to operating expenses five cents per car-mile for the first year, 5¼ cents for the second year and 5½ cents for the third year, and thereafter until readjusted; also an accident reserve fund to which will be credited each month 0.7 cent per car-mile for the first year, 0.8 cent for the second year and 0.9 cent thereafter until readjusted.

At the request of the Municipal company the Cleveland Electric Railway shall issue and sell from time to time such capital stock as may be required to pay for additions and improvements, including \$250,000 for repairs and renewals, \$1,500,000 for track extensions and improvements, \$1,350,000 for new rolling stock, \$2,150,000 for new power houses and car shops and \$1,500,000 for the construction of a high-level bridge across the Cuyahoga river.

Immediately following the transfer of the papers on Monday night the Municipal Traction Company took possession of the property. It was announced that on Tuesday, to celebrate

the settlement, no fares would be charged, and that on April 27 of each year all passengers would be carried free. It was also announced that on Wednesday 3-cent fares would be charged, with no transfers. On Tuesday many of the details of the plans for operation were settled. It was announced that the transfers would be ready by May 7 and that for a short time at least one cent will be charged for each transfer. Eventually it is proposed to give universal transfers for a 3-cent fare. The 3-cent fare applies only to rides within the city. Passengers to or from points outside the city will pay five cents and receive a suburban fare receipt, which will be collected after passing the city limits.

Several changes in routing and schedules are being made and plans are being prepared for the reconstruction of some of the tracks. It is announced that the plan will be tried of stopping the cars only at every other street crossing. The motormen and conductors have been given an increase of wages of approximately one cent per hour, the scale being 22, 24 and 25 cents, according to length of service.

On Tuesday the directors of the Municipal Traction Company met and elected Mayor Johnson treasurer, to succeed William Greif. F. C. Stockberger was appointed purchasing agent and Lawrence Stockberger was appointed superintendent of power. Mr. du Pont will assume the duties formerly performed by Horace E. Andrews, president, and John J. Stanley, vice-president and general manager. It is stated that F. H. Goff will probably be elected chairman of the board of directors.

Most of the members of the Cleveland Electric staff will leave the city. Mr. Andrews will hereafter devote his time to the affairs of the Mohawk Valley Company, of which he is president.

The introduction of 3-cent fares on Wednesday was accompanied by a number of unforeseen difficulties. The motormen and conductors were dissatisfied with the increase of one cent an hour and threatened to strike unless granted the increase of two cents, which was promised them last year by the Cleveland Electric Railway in case of a settlement. Mayor McQuigg of East Cleveland was put off a car for refusing to pay more than three cents for a ride from his suburb to the city and brought suit to compel a 3-cent fare from Cleveland to East Cleveland, which he said is required by a franchise. A third trouble was caused by a scarcity of pennies to make change at the unusual rate.

#### Strength of Chain Links.

Bulletin No. 18, on "The Strength of Chain Links," by C. A. Goodenough and L. E. Moore, has been issued by the engineering experiment station of the University of Illinois.

A series of experiments on chain links and circular rings, covering a period of two years, has been made for the purpose of confirming or disproving a theoretical analysis of the stresses in links and rings. A comparison of calculated and measured distortions affords the desired test. The result of the experiments is a complete confirmation of the analysis. Having a reliable theory, the bending moments and maximum stresses are calculated for links of various forms and the results of such calculations are applied to the formulas for the loading of chains given by Unwin, Bach and Weisbach. It is shown that the usual formulas for chain loads give maximum tensile stresses of 33,000 to 40,000 pounds per square inch, and maximum compressive stresses of 60,000 pounds per square inch. New formulas for safe loads are proposed. The bulletin is concluded with four appendices giving in full the theoretical discussion which is the basis of the experimental work. This bulletin will be of special interest to all engineers and manufacturers who are concerned in any way with hoisting and transmission. Copies may be obtained upon application to the director of the engineering experiment station, Urbana, Ill.



**METHODS RECOMMENDED FOR INCREASING ELEVATED RAILWAY SERVICE IN CHICAGO.**

George Weston, consulting engineer, Chicago, has just submitted to the Chicago city council a report on the Union elevated loop.

The report describes the loop as at present operated and its "rush hour" capacity, and outlines changes that should be made which will increase its capacity in the number of cars per hour that can be passed through it.

The changes recommended are as follows:

1. The through routing of cars between the Northwestern and the South Side companies.
2. The lengthening of the station platforms and the re-locating of certain platforms with reference to the interlocking plants.
3. The introduction of universal transfers between the four companies.

The net increase shown by the calculations made amounts to 43 per cent over the present "rush hour" capacity of the loop.

Tables giving the probable increase in growth of traffic

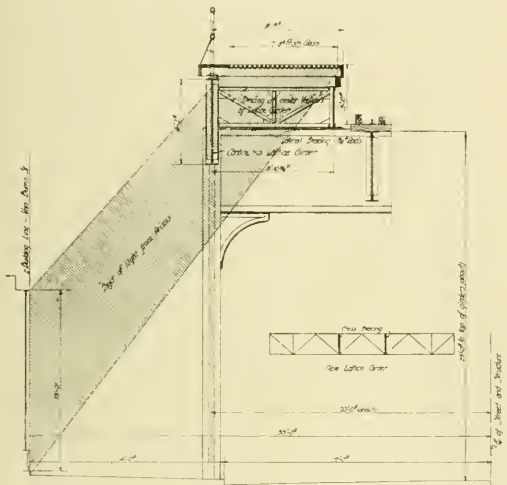

**Chicago Union Elevated Loop—Proposed Arrangement of Platform with Prism Glass Floor.**

show that the future business will outgrow this resulting increase in capacity in the period between 1912 and 1915.

The through routing of cars is essential to the proper expansion of the downtown business district and this view of the necessity for through routing should be the underlying principle to bring it about.

Briefly, Mr. Weston says:

It is evident that the present elevated loop must be supplemented in the near future by additional facilities by which to take care of the rapidly increasing traffic. It is also evident that a complete and comprehensive plan must be devised to ultimately provide in a full and satisfactory manner for the traffic through the congested business district, and which shall tend to stretch out and enlarge this district, but it will take time to evolve and construct such a system and plans that can be put into immediate execution must be determined to furnish the immediate relief so much desired, and it is to the latter problem that the efforts of this report will be confined.

If the increased capacity to be attained by through routing were given entirely to the through routed cars the increase would be 100 per cent upon the number of trains through routed. On the other hand, if the advantage to be gained is used to loop additional trains the track capacity per hour will be increased but 50 per cent. In other words, for every train that is through routed per hour one additional train can be through routed per hour, and for every two trains that

are through routed, one additional train may be looped, the percentage of gain being constant at this ratio.

**Platforms.**

The capacity of the elevated loop can be materially increased if the station platforms are lengthened so as to permit of two trains standing at the platform to load or unload at the same time, thereby eliminating the present extra stops that are required by reason of the trains not being able to run up to the station and make their station stop. The result of numerous observations taken during the rush-hour period shows that the average loss of time per train in making a complete run around the loop, due to these extra stops, is a little in excess of three minutes. The average rush-hour time for one trip around the loop is about 18 minutes. By lengthening the platforms and cutting out these extra stops this average time could be reduced to 15 minutes, thereby making a net saving of time of about 17 per cent. By saving this time more trains can be passed by a given point in a given period of time, hence the capacity is theoretically increased by that percentage. It is hardly possible that all of this time can be saved for the reason that trains will not always come in the proper sequence and, therefore, will not be able to make their station stop without some delay. But it is believed that 60 per cent of this increase can be obtained in practice if the stations are relocated and the track delays reduced to the minimum, which would mean a net increase of about 10 per cent over the present conditions.

The lengthening of the station platforms will also permit of the operation of 6-car trains instead of 5, which is the present maximum. The operation of 6-car trains will increase the number of seats per hour by 20 per cent and hence the capacity of the loop by the same amount. This increase of 20 per cent can be maintained up to the maximum number of 6-car trains that can be passed through the interlocking intersections per hour. The total net increase in capacity per hour due to lengthening the platforms as detailed above amounts to 30 per cent.

The lengthening of the station platforms brings up the question of obstructing the light and darkening the first story of business places adjacent to the platforms. Inasmuch as I am firmly of the belief that the platforms should be lengthened, if permanent or temporary relief to the loop is to be secured, the subject of light in connection with the station platforms has been given careful study with the result that by the use of prismatic glass the station platforms can be made a source of increased light through first-story windows, and instead of the platforms being an obstruction to the light they would be of assistance in lighting the stores or street beneath.

The application of prismatic glass to the station platforms will result in sending daylight into the adjacent stores from three to four times as far as would be possible if there were no elevated structure or any obstruction in the street whatever.

**Increased Capacity.**

The introduction of through routes and the lengthening of the station platforms would result in a net possible increase in the capacity of the loop of about 80 per cent if the capacity of the tracks of the Northwestern and the South Side lines connecting with the loop would permit increasing the number of 6-car trains 100 per cent over the number of 5-car trains that these companies now operate through the loop during the rush hour; and if the provisions of the lease proportioning the number of trains to each road would permit such increases.

The development of speed time curves and distance time curves proves that the minimum theoretical headway possible to operate 6-car trains on the main line double-track roads connecting with the loop, neglecting the block signals, is about 50 seconds.

It is not considered possible, however, to maintain this headway; the minimum headway is probably not less than 60 seconds.

This headway would limit the ultimate capacity of these tracks to 60 trains per hour entering the loop.

Therefore, taking this fact into consideration, together with the provisions in the lease, it is evident that these roads cannot utilize the full 100 per cent increase over the present number of trains that they have in operation and that the total increase in capacity in number of trains per hour as a basis cannot be taken at more than 60.

Summarizing the increases due to the improvements outlined in the report we obtain results which show the total rush-hour passengers, after allowing for all increases and correcting to the limitations of the governing conditions, to be 65,880, a net increase of 43 per cent.

In 1901 there were 22,839 steam locomotives in the United States. In 1906 this number had increased to 29,848.

### WELFARE WORK ON THE FT. WAYNE & WABASH VALLEY.

The value of keeping in close touch the various departments of an organization is well recognized. Frequent interchange of ideas between the heads of departments and the subordinate employes establishes a community of interest which it would be impossible to obtain by a mere issuance of instructions through the ordinary channels. That the element of personality enters into the management of a railway as in other industrial enterprises is acknowledged and therefore a practice that tends to bring out the individuality of a man, whether manager, superintendent, mechanic or section foreman, can result only in benefit both to the company and the employes. The Ft. Wayne & Wabash Valley Traction Company of Ft. Wayne, Ind., has adopted in its maintenance of way department a series of "cabinet" meetings at which papers and discussions are presented by the officials and employes on subjects announced in a programme of the weekly meetings prepared several months in advance. As this method has worked out very satisfactorily on the lines of the Ft. Wayne system a brief description may be of benefit to others interested in promoting closer harmony between the department heads and the employes.

The employes of the maintenance of way department have been organized and divided into three sections or divisions as follows: The Ft. Wayne division, comprising all the employes at Ft. Wayne, on the Bluffton line, and as far west on the Ft. Wayne-Logansport division as La Gro; the Logansport division, comprising employes from Wabash west as far as Rockfield; and the Lafayette division, consisting of employes from Rockfield west to and including Lafayette.

The Ft. Wayne division meets every Tuesday evening at the chief engineer's office, H. L. Weber presiding and Mr. Johnston, his clerk, acting as secretary. The Logansport division meets every other Wednesday evening and the Lafayette division every other Thursday evening. By this arrangement the meetings do not conflict and anyone from any division can attend the meetings of the other divisions if he desires to do so. About once every four to six weeks there is a general meeting at Ft. Wayne and every section foreman on the entire system is expected to attend if possible.

At these meetings subjects of interest pertaining to the work are discussed and any foreman who desires material or help so reports, and ways and means for supplying his wants are discussed. Instructions are then given to the proper party to see that his desires are taken care of. For this year there has been outlined a course of "Topic Talks," by the general manager, heads of departments, section foremen and other employes of the company. On the occasions of the talks by the general manager or heads of departments a general meeting is held in the office of the chief engineer, and all foremen are expected to be present. Each meeting is presided over by a chairman and secretary and all meetings are conducted in a businesslike way. Typewritten copies of the minutes are kept, one copy being sent to the general manager, one copy placed on file and one copy sent to each of the chairmen of the other divisions.

As an example of the diversity of questions discussed we have chosen at random a few of the subjects assigned to the various representatives of the maintenance of way department, taken from a copy of the programme for the weekly meetings during the remainder of the year:

"Construction and Maintenance," by H. L. Weber, chief engineer; "Our Economics," by C. D. Emmons, general manager; "The Renewal and Best Methods to Adopt," by William Dolan, roadmaster; "Our Overhead System," by J. J. Brennen, chief lineman; "Roadbed Drainage," by John Gower, section foreman; "Our Relations," by R. T. Gunn, superintendent of transportation; "Right of Way Fences and Their Maintenance," by H. Bishop, carpenter; "How to Handle a Snow-

storm," by John Betts, gang boss; "The Proper and Best Methods of Switch and Curve Greasing, Oils, Etc.," by Bert Arney, switch tender; "Our Equipments and Their Proper Use," by Lee Jacques, master mechanic.

As will be seen, the subjects covering all phases of the work on this system are presented by those having such work in actual charge and the benefits to be derived from such a method of interchanging ideas are obvious. We are indebted to H. L. Weber, chief engineer of the Ft. Wayne & Wabash Valley system, for this interesting information.

### PLANS FOR BETTER BRAKES AND FENDERS IN NEW YORK CITY.

The total number of fatal and serious accidents upon street railways in Greater New York for the past six months has reached a number so great that the public service commission having jurisdiction over that district adopted on April 28 a resolution intended as the first step toward the reduction of accidents upon the different systems. In this resolution and the remarks of Commissioner Maltbie following it is interesting to note that in the minds of the commission a large number of cars operating in New York City are not properly equipped with either the best type of fenders or wheel guards or with brakes, either power or hand, of an efficiency that would warrant the most successful operation; and that in lieu of this fact a hearing will be ordered to show the advisability of submitting to the commission for approval types of such equipment specified for future rolling stock before it is ordered and placed in service. A blank issued to the railways requests a complete statement of the brakes and fenders now in use. The remarks of Commissioner Maltbie, containing a summary of the accidents since August 1, 1907, follow:

In the six months ending February 1, 1908, the street railways of Greater New York killed 299 persons and seriously injured 944. The total number of accidents due to collisions of street cars was 1,196 and the number of vehicles and persons struck by cars was 7,059. At this rate in an entire year about 600 persons will be killed and 2,000 seriously injured. The number of accidents due to collisions will approximate 2,400 and the number of persons and vehicles struck 14,000. From the standpoint of humanity this is a serious condition and ought not to be allowed to continue if there is any way to prevent it. There is another phase of the subject. For the year ending June 30, 1907, the street railways of New York City paid out for injuries and damages due to accidents over \$2,500,000. Over one-half of this sum was paid by the Manhattan companies and one-third by the Brooklyn companies. Anything, therefore, which will reduce the number of accidents will not only be a blessing to humanity but will result in a saving financially to the companies.

It is probably true that even with the best devices that can be adopted and with the greatest care it will not be possible to prevent accidents entirely, many of which will be serious and even fatal. But until the subject has been thoroughly investigated and every suggested remedy fully considered, our duty will not have been done, and it seems probable that the number of accidents can be very greatly reduced.

The most important factors in the prevention of accidents are brakes and fenders or wheel guards. Certain types of each are more effective than others, and in view of the high speed with which cars are run and in view of the congested character of many districts of the city it is essential that only the most effective types of brakes and fenders be used and that all of low efficiency be eliminated as rapidly as possible. Our division of accidents has investigated hundreds of cases and it is the opinion of the chief of the division, Mr. Daggert, that fully one-half of the accidents would be prevented if a brake of the high power and efficiency claimed for the magnetic track brake were in universal use. A large number of lives would be saved and injuries avoided if every car were equipped with the best type of fender and wheel guard.

I move, therefore, that the companies be directed to report the facts called for in the resolution I have just offered, that the electrical engineer be directed to report upon the relative efficiency of the various types of brakes, fenders and wheel guards used by the street railway companies under the jurisdiction of this commission, and that pending the submission of this report an order for a hearing be issued as to the advisability of requiring every company to submit to the com-

mission for approval the types of brakes, fenders and wheel guards to be used on all cars hereafter purchased before such cars are ordered by the companies.

#### CAR HOUSE FIRE PROTECTION.

F. E. Cabot, supervising engineer of the Boston board of fire underwriters, spoke before the New England Street Railway Club on April 23 on fire protection in car houses. He urged the more general investigation of all the small fires on cars and in the houses and pointed out the need of better organization for fire protection among car house employes. The prevention and control of fire is as important a problem as that of equipment maintenance and every car house foreman should be thoroughly versed in the best methods of protecting the property under his care.

Car houses are much better risks than formerly, especially since the peaked roof construction went out of favor. It should never be forgotten by the insurance man that the first problem in front of the street railway manager is not fire protection, but the operation of his road. By meeting on the common ground of remedying the smaller but none the less important defective conditions, the two parties in interest can get together.

A car house is not half as hazardous a risk as a cotton mill. There are many causes of car house fires and some of these can be easily prevented, such as leaving car heaters on at the high point, bad wiring in shops, accumulation of dirt around heaters, careless use of gasoline torches, corrosion of electrical connections and the practice of running cars into the house when there is an incipient fire in their bodies or in their wiring. The speaker urged the formation of a committee by the club to investigate and report the causes of all fires occurring in the territory controlled by the members, and stated that by attacking the problem in such a definite way much good would result, in the same way that the mutual insurance work of the New England cotton mills had proved such a lasting benefit.

With a reasonable supply of hose and buckets, extinguishers and an alert organization of car house employes, it ought to be possible in all but extraordinary cases to save a house once it gets on fire. The work done in the first few minutes is most important and the effort made to save cars by running them out of the house had better be expended in fighting the fire in the critical moments before the city department arrives.

#### Automatic Sprinklers.

Mr. Cabot spoke strongly in favor of the automatic sprinkler, both of the overhead and the aisle types. All fire apparatus needs maintenance as much as any other equipment, but it is used so seldom that this matter is very often overlooked. No sprinkler can be a success without plenty of water at good pressure, say 25 pounds per square inch at each head. As 15 or 20 heads may go off at once it is desirable to provide for the supply of at least 50 gallons per head per minute, or a total in a large house of 750 gallons per minute at 25 pounds pressure. Good feeling among the car service and pit men is a valuable asset, and the esprit de corps of the car house organization is of more value in the fire problem than all the automatic apparatus or appliances that can be put into the house. The speaker urged more frequent unexpected inspections and the fixing of definite responsibility for fire protection in each department.

It is a mistake to rely too much upon the use of combustible materials in car house construction. It is no sign a material is fireproof because it will not burn. Concrete improperly mixed is a dangerous material and even a steel truss will melt and fall into the house, preventing the proper application of water and the saving of the rolling stock. Plain asbestos board when wet is a bad material for electrical insulating purposes and it is not generally known that this

material has a heat conductivity one-fourth as high as iron or steel. A combustible substance, like the oil in a modern oil switch, is a safer material than a so-called "fireproof" construction of inferior quality. At a cost of about \$7.00 per 100 square feet of car house area for sprinklers and a valuation of \$7,000 per car, the balance is decidedly with the sprinklers, aside from the fact that in about eight or ten years the cost of the protection will be saved in the reduction in insurance premiums. The aisle head is valuable where it does not interfere with operating convenience or suffer damage from the moving parts of cars. The use of wired glass monitors, however, makes it hard to save a car by the aisle sprinkler, for the glass keeps the latter from doing any work inside the car until the roof falls in or the side windows give way.

In the short discussion that followed the address of Mr. Cabot, John Lindall, Boston Elevated, cited the case of a car house fire that seemed to be caused by the removal of rail bonds from the special work in front of the house. A fire occurred in the night which could not be located until the floor was torn up. On inspection it was found that a track spike in the house had become red hot and burned a hole 6 or 8 inches in diameter in the timber under the floor. The spike was in contact with a grounded pipe and it was thought that the removal of the rail bonds outside the building temporarily caused a high difference of potential between the spike and the pipe. As a result the current flowing to the pipe overheated the spike. The stringer was an 8 by 10 inch hard pine piece and was soon set afire by the red hot spike.

F. F. Low, architect Boston Elevated Railway, gave the results of surprise tests made at the company's 25 car houses before the water was turned on for the warm season. In practically every case water was turned on to the hose line by the house organization in less than three minutes after the gong sounded. The quickest time was 1 minute and 20 seconds. Monthly fire drills are held in Boston.

#### EXTENSIVE CONSTRUCTION PLANS OF THE OREGON ELECTRIC RAILWAY.

The Oregon Electric Railway Company, whose new line from Portland to Salem, Ore., 51 miles, was described and illustrated in the Electric Railway Review of February 29, page 258, last week announced its plans for the construction of about 300 miles of new lines during the next three years in the Willamette valley. Amended articles of incorporation were filed increasing the capital stock from \$2,500,000 to \$10,000,000 and the directors met and authorized the following extensions: Salem to Albany, 18 miles; Garden Home to Hillsboro, 12 miles; Hillsboro to Tillamook, 57 miles; Tigardville to Eugene, 125 miles; Salem to Mill City, 54 miles; and Albany to Cascadia, 35 miles.

In a general way the extensions of the Oregon Electric Railway system will provide widely separated parallel lines up the Willamette valley from Portland, one on each side of the Willamette river, together with a main line running to the coast at Tillamook and a number of feeders and laterals throughout the territory reached.

From the Portland-Salem line a road will be built through Washington and Tillamook counties to Hillsboro and Tillamook bay. This line will tap one of the richest dairy and farming sections on the Pacific coast. From Tigardville, also on the Portland-Salem line, a main trunk road will be built through Washington, Yamhill, Polk, Benton and Lane counties, through Corvallis to Eugene. Another line will be built from Dallas to Salem and thence easterly through Marion county to Mill City. There will also be a road constructed from Albany, which will be reached by an extension of the main line from Salem, southeast through Lebanon to Cascadia.

The Willamette Construction Company, which built the Portland-Salem line, has already begun construction on the Garden Home-Hillsboro line and it is planned to begin work

on the Salem-Albany line some time this summer. W. S. Barstow & Co. of New York and Portland will have charge of the construction work.

Moffatt & White of New York are managers of the syndicate that is supplying capital for the Oregon Electric Railway. The officers of the railway are: President, George Barclay Moffatt, New York; vice-president, Guy W. Talbot, Portland; secretary, George F. Nevins, Portland; treasurer, H. W. Brower, New York.

**REVISED BOSTON & EASTERN CONSTRUCTION ESTIMATES.**

A hearing on the revised plans of the proposed Boston & Eastern Electric Railroad was held by the Massachusetts railroad commission on April 27. J. R. Worcester of Boston and R. A. Shailer of New York testified as experts on tunnel construction that the estimated costs of the proposed Boston & Eastern tunnel under Boston harbor in connection with the revised route to Postoffice square were reasonable and provided for a safe general design. The totals of the estimates as revised by the engineer, John H. Bickford, are given herewith. Earlier mention of this project has been made in the Electric Railway Review for July 20, 1907, page 72; September 28, 1907, page 379; November 2, 1907, page 737; and December 7, 1907, page 893. The hearing was continued until May 19 to enable Mr. Bickford to prepare data and testimony showing the difference between his proposed high-speed electric road, the existing street railways in the territory north of Boston and the Boston & Maine and Boston Revere Beach & Lynn steam roads in case the latter should be electrified in the future.

**Estimate of Cost.**

Grading, surfacing, tunneling, etc.....	\$ 1,241,900
Side and retaining walls.....	516,550
Ballasting with stone.....	207,000
Crossings over other railroads.....	228,100
Crossings at streets and ways.....	853,575
Crossings over waterways.....	265,150
Track and track equipment.....	334,620
Signaling system.....	100,000
Stations (exclusive of Boston terminal).....	108,000
Seeding, sodding and fencing.....	32,750
Power station (8,000 kilowatts capacity).....	800,000
Power distribution system.....	340,090
Substations (three, with 10,000 kilowatts total capacity).....	300,000
Cars and car equipment (50, each with four 200-horsepower motors).....	842,500
Car houses and repair shops.....	120,000
Harbor tunnel, subway and terminal.....	2,190,060
Engineering, interest and miscellaneous.....	1,049,000
Real estate.....	1,444,323

Total cost ..... \$10,973,618  
 The cost as originally estimated was \$8,754,960.

It is announced that engineering courses, laboratory practice and research work of interest to practicing engineers, contractors and graduates of technical schools will be given in the coming summer session of the University of Wisconsin, Madison, Wis., beginning June 22 and continuing six weeks. Work is offered in the following departments: Chemical, electrical, hydraulic, steam and gas engineering, mechanical drawing and machine design, mechanics and testing of materials, shop work. In addition to these engineering courses the eighth annual session of the Artisans' school will be held during the same period, in which instruction of more elementary type will be given in the larger portion of subjects noted above, this instruction being adapted to the requirements of students who have common school training or practical experience.

A contemporary devoted to the steam railway field describes an economical and rapid method of handling rails. The novel feature is found in the use of multiple rail hooks worked from the lifting chain of a derrick car. It is stated that by the use of these hooks as many as eight rails may be lifted at one time.

**NEW SINGLE-PHASE LINE IN INDIANA.**

We present herewith a map showing the route of the Chicago Lake Shore & South Bend Railway, extending from South Bend, Ind., to Kensington, Ill., which is expected to be ready for operation by July 1. At Kensington the line connects with the Illinois Central Railroad, which operates an especially frequent suburban service into Chicago. It has been planned to erect a passenger station at Kensington, where five acres of land has been purchased, but these arrangements may be altered and a station erected. The track of the Chicago Lake Shore & South Bend road ends at Hammond; between Hammond and Kensington the electric road will use one track of the Kensington & Eastern Railroad, a new line built by the Illinois Central.

The road is being constructed throughout according to the most substantial standards, using 70-pound rails, white oak ties and 45-foot cross-tied poles. The overhead construction is of the single catenary type. The company owns a 66-foot right of way from South Bend to Hammond, except where the line runs through towns.

The power house and car shops are located at Michigan City. The Westinghouse single-phase system will be used. J. B. Hanna is president and J. W. S. Reigle is chief engineer, both with headquarters at South Bend.

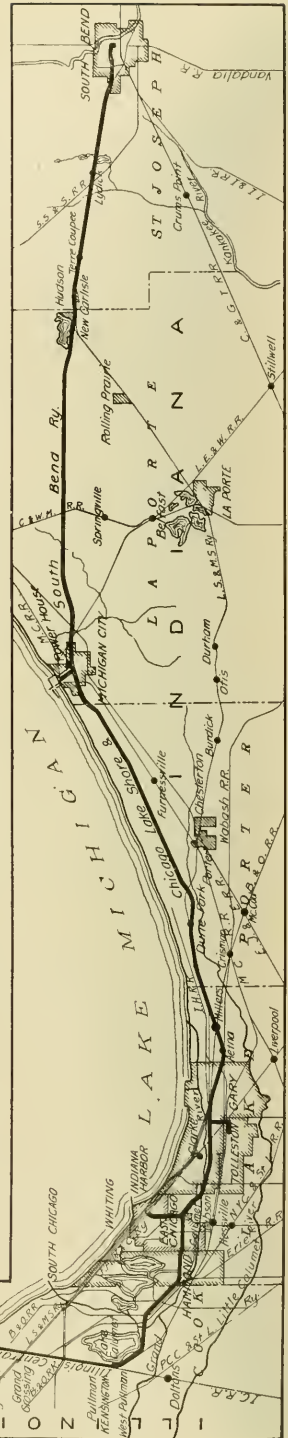

Chicago Lake Shore & South Bend Railway—Map Showing Route of New Line Now Nearing Completion.



## RECENT ELECTRIC RAILWAY LEGAL DECISIONS.

BY J. L. ROSENBERGER, LL. B., OF THE CHICAGO BAR.

**One Running After Car and Falling in Trying to Board It Not Entitled to Damages.**

*Lee v. Rhode Island Company*, 68 Atlantic Reporter, 475.—The supreme court of Rhode Island says that the evidence in this case preponderated against the verdict given the plaintiff. The testimony of all the disinterested witnesses who saw the accident tended to prove that the plaintiff ran after the car after it had started, and in trying to step upon it fell and received the injuries complained of. For this reason the court thinks the defendant was entitled to a new trial.

**Duty Owed to Person Tendering a Transfer Not Accepted.**

*Lewyt v. Dry Dock East Broadway & Battery Railroad Company*, 107 New York Supplement, 14.—The supreme court of New York, appellate term, says that the plaintiff testified that he boarded a Second avenue car at Eighty-sixth street and asked the conductor for a transfer to Grand street, which was given him and which was admitted in evidence; that he rode to Grand street and boarded a Grand street horse car operated by the defendant, and when his fare was demanded offered the transfer to the conductor, who said the "transfer was no good," and that he would have to pay another fare or get off. In the words of the plaintiff: "I told him that I would get off when the car stopped, and with his foot then he kicked the bundle off in the street, and he gave me a punch in the eye, and I fell from the car, and the goods were ruined." The defendant made no attempt to controvert this proof. Judgment was rendered for the defendant, and the plaintiff appealed.

It was urged by the defendant that the plaintiff could not recover damages, as he was not a passenger for hire. This position cannot be upheld. The plaintiff had boarded the car as a passenger, he had tendered in payment of his fare a transfer, and upon being told that the transfer was of no value, he expressed a willingness to leave the car as soon as it could be stopped. He was entitled to as much consideration from the servants and employes of the defendant as though he had actually handed the conductor the fare demanded. The defendant owed him the duty of either carrying him safely to his destination or affording him a reasonable opportunity to alight. Even if he had refused to pay his fare and had persisted in riding, his ejection for nonpayment could only be accomplished by resorting to no more force than was actually necessary. Under the facts disclosed the plaintiff proved a cause of action, and the judgment rendered had absolutely no foundation. Judgment reversed, and new trial ordered.

**Passenger Riding on Bumper and Getting Caught in Rope—Trolley Pole Slipping Off Wire.**

*Feldheim v. Brooklyn Queens County & Suburban Railroad Company*, 107 New York Supplement, 413.—The supreme court of New York, appellate division, second department, says that the plaintiff was riding on the rear bumper of a crowded car. The trolley pole slipped off the wire and the rope attached to it caught the plaintiff about the shoulder and cast his head against the vestibule window, breaking the glass and inflicting slight injuries. He had often seen trolley poles come off the wire, and knew that, when that occurred, the rope went up with the pole. The conductor had collected his fare. The only witness who testified as to the speed of the car said that it was going 12 miles an hour.

It has frequently been held that it is not negligence per se (by itself) to ride upon the platform or running board of a crowded car, though even in such case the passenger assumes the usual risks incident to the position. But the court does not think there is any assurance from the company that a

passenger can ride on a bumper with safety, even though his fare is accepted, because the position is so obviously dangerous that the law will not create an implied assurance of what the party must have known was not the fact. Rather than wait for another car, the plaintiff preferred to take the risk of riding in a perilous situation. By accepting his fare the defendant consented that he do that, and probably agreed that it would not by any affirmative act increase his peril, but it incurred no obligation to protect him from the obvious perils of the situation. The plaintiff should have known that he was likely to be caught by the rope in case the pole slipped off the wire. He voluntarily put himself in the way of that danger, and he was guilty of contributory negligence as matter of law. In any case the plaintiff could not recover damages and a judgment in his favor should be reversed.

**Flying Up of Trap Door in Car.**

*Baum v. New York & Queens County Railway Company*, 108 New York Supplement, 265.—The supreme court of New York, appellate division, second department, says that the trial judge stated in substance that the evidence that the trap door in the floor of the car flew open and struck the plaintiff, a passenger, was sufficient to make out a case to go to the jury, and that it required evidence from the defendant to show or explain the cause. This was correct as a rule of evidence governing the progress of the trial. The maxim that the thing speaks for itself applied; i. e., the flying up of the door raised a presumption that there was something wrong with the car by the defendant's negligence, and that presumption was evidence which made out a case for the plaintiff to go to the jury. The defendant was therefore required at that stage of the trial by the rules of evidence to put in any evidence which it had to show the cause of the occurrence—or, in other words, that the occurrence did not happen from its negligence—if it desired to do so.

**Getting Down Backward from Vehicle at Side of Track—Extension of Rule as to Looking and Listening.**

*State, to use of Carey and others, v. Cumberland & West-ernport Electric Railways Company of Allegany County*, 68 Atlantic Reporter, 197.—The court of appeals of Maryland says that the man struck in this case by a car was struck by it while in the act of stepping down backward from the hub of a wagon wheel toward, if not upon, a railroad track but two feet distant from the wheel, without taking the slightest precaution to ascertain whether a car was approaching. He could have seen the car in time to save himself if he had simply turned around and looked for it. He must have been familiar with the proximity of the railway tracks to the public road, as he resided in the immediate neighborhood. Furthermore, he had been riding along the public road in full view of the railway track just before the happening of the accident which cost him his life. The court is of the opinion that the case was properly taken from the jury.

It has long been the settled law in Maryland that it is negligence per se (by itself) for any one to attempt to cross the tracks of a railway without first looking and listening for approaching trains and stopping to look, if the view be obstructed, and if he neglect these precautions and is injured by collision with a passing train, which he might have seen if he had looked or heard if he had listened, he will be presumed to have contributed to the occurrence of the accident, and unless that presumption be overcome, he cannot recover for the injury. It has been held that this proposition applies to attempts to cross suburban electric railways. It must upon principle be held applicable also to attempts to go upon a railway track or so near to it as to come into collision with a passing train or car. If the injured party in such a case is debarred by his negligence from recovering damages for the injury, it necessarily follows that no suit can be maintained for the benefit of his representatives if his injury prove fatal.

# News of the Week

## Legislation Affecting Electric Railways.

**District of Columbia.**—Representative Madden has introduced in the house a bill to compel the street railways of Washington to equip their cars with air brakes within a year under penalty of \$200 per car.

**New York.**—On April 22 the senate passed a bill introduced by Senator Frawley authorizing the city of New York to purchase the Belmont tunnel at a price to be agreed upon by the city and the owners of the property.—The senate also passed the Robinson bill, which was passed on April 21 by the assembly, as reported in last week's issue, permitting the granting of franchise for subway construction and operation to private corporations.

**Ohio.**—The Wertz bill, providing for initiative and referendum votes on municipal legislation, which was passed by the house last week, was reported to the senate on April 23 by the committee on municipal affairs, with several amendments.

## Chicago City Council to Consider Subway Plans.

Mayor Busse of Chicago on April 27 sent a message to the city council urging it to take up at once the consideration of plans for building a subway to supplement the already overcrowded transportation facilities of the city. The mayor pointed out that the plans for subways should be made so broad and comprehensive as to provide for development and extension to meet the conditions of increased traffic which will be created by future growth of the city and to provide for the solution of several problems relating to the disposal of water mains, sewerage systems and underground wires. He recommended that the entire matter be referred to the committee on local transportation and that the committee be authorized to employ expert assistance.

The message was referred to the committee and a meeting was called for Thursday, April 30, to consider the subject. It is announced that the committee will at once proceed to secure all the information possible on the subject in order to determine upon the most feasible plan. It already has before it two reports submitted by Bion J. Arnold, one in 1902, dealing with a comprehensive subway system, and one in 1906, providing for a temporary loop in the central district. It is believed that there are no important engineering obstacles to be met and that the principal difficulty will be in financing the enterprise.

## Strikes in Pensacola and Chester.

The strike of the motormen and conductors of the Chester (Pa.) Traction Company, which was caused by a reduction of wages, as reported in last week's issue, is still in progress. The cars are being operated regularly by strike-breakers, but there is little travel on account of the boycott declared by strike sympathizers, and general business in Chester has been greatly interfered with. Small disturbances by the strikers have been frequent and several attempts have been made to wreck the cars. President Rigg has offered to take back the old employes as individuals and a few have responded, but he has declined to treat with the union or to increase the wages. A portion of the state militia has been withdrawn from the city. On April 27 a delegation representing the board of trade and the carmen's union went to Washington to confer with the commissioner of labor and the interstate commerce commission in regard to an arbitration of the difficulty under the Erdman law.

The strike of the employes of the Pensacola (Fla.) Electric Company has been attended with several severe riots and the company has been able to operate its cars only with the protection of the state troops and special policemen. Cars were operated at night on April 25 for the first time since the strike was declared. The federal court at Pensacola has issued an injunction restraining the members of the union from interfering with the operation of the cars.

## American Institute of Electrical Engineers.

The annual meeting of the American Institute of Electrical Engineers will be held on Tuesday, May 19, in the Engineering Societies building, New York City. The following papers will be presented: "Comparative Tests of Lightning Protection Devices on the Taylor's Falls System," by J. F. Vaughan; "Studies in Lightning Performance, Season of 1907," by N. J. Neall.

The annual convention of the institute will be held at Atlantic City, N. J., June 29 to July 2. The programme includes the following papers: "Voltage Ratio of Split-Pole

Converters," Comfort A. Adams; "A New Large Generator for Niagara Falls," B. A. Behrend; "Relation of the Manufacturing Company to the Technical Graduate," B. A. Behrend; "Experimental Observations of Electrical Stresses Caused by Arcing Grounds," Ernst J. Berg; "Steam-Turbine Plant: Some Possibilities Resulting from Recent Engineering Developments," J. R. Bibbins; "Thirty-Day Test on Producer Gas Power Plant: Discussion of Results in Relation to Cost of Power," J. R. Bibbins; "Three-Phase Power Factor," Austin Burt; "A New Method for the Design of Alternators," Carl J. Fechtelmeier; "Conductor Rail Measurement," S. B. Fortenbaugh; a paper on certain features of the Southern Power Company's system, J. W. Fraser; "Notes on Electric Locomotive Tests," George Gibbs; a paper on electric fire hazard problems, C. M. Goddard, representing the National Fire Protection Association; "Graphic Treatment of the Rotating Field," R. E. Hellmund; "An Imperfection in the Usual Statement of the Fundamental Law of Electro-Magnetic Induction," Carl Hering; "Ventilation of High-Speed Alternators," Albert Kingstung; "Modern Developments in High-Speed Motor-Generator Sets," F. D. Newbury; "Relation of the Manufacturing Company to the Technical Graduate," L. A. Osborne; "A Minimum Work Method for the Solution of Alternating-Current Problems," Harold Bender; "The Design of High-Tension Water Power Stations," D. B. Rushmore; "Relation of the Manufacturing Company to the Technical Graduate," D. B. Rushmore; "The Fundamental Considerations Governing the Design of Transmission Line Structures," D. R. Scholes; "The General Equations of the Electric Circuit," C. P. Steinmetz; "On the Economical Location of Substations in Electric Railways," Gerard B. Werner; "From Steam to Electricity on a Single-Track Road," J. B. Whitehead; "The Application of Storage Batteries to the Regulation of Alternating-Current Systems," J. Lester Woodbridge.

Other papers are being arranged for by the high-tension, the railway and the educational subcommittees.

**Philadelphia Subways.**—At a meeting of the Engineers' Club of Philadelphia on May 2, S. M. Swaab presented a paper on "The Construction Methods on Section 6, Market Street Subway."

**Western Society of Engineers.**—The next meeting of the Western Society of Engineers will be held in the Monadnock block, Chicago, on May 6. Prof. J. C. Thorp will present a paper on "Recent Development in the Steam Turbine."

**The Analysis and Grading of Creosotes.**—The forestry service of the United States department of agriculture has just issued Circular No. 112, by Arthur L. Dean and Ernest Bateman, which includes data and methods regarding the analysis and grading of creosotes.

**Accidents in Ontario.**—According to a report of the Ontario railway and municipal board 32 persons were killed and 320 injured by electric railways in Ontario during the year 1907. Of those killed 7 were passengers, 7 were employes, 1 was a trespasser and 17 were pedestrians.

**Fox River Valley Railway and Lighting Association.**—A meeting of the recently organized Fox River Valley Railway and Lighting Association was held on April 25 and 26 at Fond du Lac, Wis. E. H. Haughton, general manager of the Bryan Marsh Lamp Company, Chicago, presented a paper on "The Tungsten Lamp."

**Air Brakes Required in Portland.**—The city council of Portland, Ore., has passed an ordinance requiring the Portland Railway Light & Power Company to equip all of its cars over 35 feet long with air brakes within one year. The ordinance also provides that no additional cars less than 35 feet long shall be installed on the Portland lines.

**"Jim Crow" Signs to be Removed in District of Columbia.**—The commissioners of the District of Columbia have requested the steam and electric railways to either remove or cover while operating within the district the so-called "Jim Crow" signs, designating separate seats for white and colored passengers, which are required by the laws of Maryland and Virginia.

**Chicago Trainmen Ask Wage Increase.**—The motormen and conductors of the Chicago Railways Company on April 28 voted to present a demand for increased wages at the expiration of the present contract on May 31. The present scale is 23 cents an hour for the first six months, 25 cents for the next six months and 27 cents thereafter. The proposed new scale is the same for the first year and 33 cents an hour thereafter instead of 27.

**To Order Increased Service on Brooklyn Rapid Transit Lines.**—The New York public service commission is planning to issue an order to the Brooklyn Rapid Transit Company, effective on June 1, to operate enough cars on the Broadway division to give each passenger a seat. At a public hearing

on April 27 A. N. Dutton, superintendent of transportation, said that the company could readily comply with the order except on Sundays and in rush hours, but that it would be difficult to do so at those times.

**No Reindictments for Charleston Accident.**—The Coles county grand jury, sitting at Mattoon, Ill., has decided unanimously not to consider in any way the matter of the inter-urban accident on the line of the Central Illinois Traction Company near Charleston, Ill., last August, for which the officers and directors of the company were indicted. The indictments were quashed by Judge Thompson of the Coles county district court on February 24, in a decision which completely freed the officers and directors from personal responsibility for the accident. The state's attorney endeavored to have new indictments voted.

**Serious Accident at Ypsilanti.**—A serious accident occurred on April 28 on the Detroit Jackson & Chicago Railway, a part of the Detroit United Railway system, when a limited car running between Ypsilanti and Detroit collided head-on with a local car near Ypsilanti, killing nine persons, including the motorman of the limited car, and injuring a large number of others. Both cars were running at a high rate of speed and the limited telescoped the lighter car. The schedule had been changed the day before, so that the limited left Ypsilanti 10 minutes earlier than usual and the reason given for the accident is that the motorman failed to stop at the siding where he was to have met the local car.

**American Institute of Electrical Engineers.**—At the last meeting of the Minnesota branch of the American Institute of Electrical Engineers, held in Minneapolis on Monday, April 20, 1908, the recent institute paper of Henry Floy, entitled, "The Engineer's Activity in Public Affairs—Public Utility Commissions and Franchise Valuations," was discussed from the standpoints of the independent and commercial engineers. Charles L. Pillsbury presented the subject from the independent engineer's point of view. Representatives of the Minneapolis General Electric, Twin City Rapid Transit and various telephone, gas light and telegraph companies, presented the subject from the commercial engineer's viewpoint.

**Wages Reduced in Pittsburg.**—The Pittsburg Railways Company has announced a decrease of wages of approximately one cent per hour, effective on May 1. In a bulletin announcing the decrease the company states that it has increased wages 33 per cent since January 1, 1902, and that the decrease is made necessary by the business depression. An announcement of a proposed reduction was made about a month ago, and after several conferences the proposition was submitted to a committee of arbitration, composed of one man selected by the employees, one by the company and the third by the first two. The third man has not yet been agreed upon. The bulletin states that the reduction will continue in effect to May 1, 1909, unless the arbitrators agree on a scale; in that case the agreed scale will be put into effect as of May 1, 1908.

**Improvements in Brooklyn Bridge Service.**—Mr. Bassett of the New York public service commission has submitted a report to the commission on the recent improvements in the surface car service on the Brooklyn bridge. The report shows that the cars of the Coney Island and Brooklyn Railroad have been largely responsible for delays to traffic. The bridge delays on the Brooklyn Rapid Transit lines have been reduced from 1,060 minutes in September to 385 minutes in March. During March 133,000 surface cars crossed the bridge, an increase of 11,000 over the number for September. At this time one year ago the largest daily number of surface cars that crossed the bridge was approximately 4,000. Today it is approximately 4,700. At this time a year ago the average number of surface cars crossing the bridge between 5 and 6 p. m. was 236. Today it is 310.

**American Society of Mechanical Engineers.**—The next meeting of the American Society of Mechanical Engineers will be held Tuesday evening, May 12, in the Engineering Societies building, New York. The paper will be by Henry Souther of the Henry Souther Engineering Corporation, Hartford, Conn., on the subject of "Clutches," with special reference to the types used on automobiles. Their development will be shown by lantern slides. The meeting will be important, not only to those directly interested in automobile construction, but to all who have to do with the use of clutches for machine tool work, power transmission, hoisting machinery, textile and other classes of machinery. The meeting will afford an opportunity for the full discussion of their design and use. The discussion will be continued at the semi-annual meeting of the society at Detroit, Mich., June 23-26.

The first single-phase electric railway in England has just been put into operation. This new installation is for experimental purposes.

# Traffic and Transportation

## Baggage and Express on Illinois Traction System.

The following rules govern baggage and express handling on the lines of the Illinois Traction System:

"Baggage.—On local cars, baggage and light express handled between all points; on limited cars, baggage handled between terminals only; on 'Corn Belt' limited, baggage handled from and to Springfield and East St. Louis only, but no express is handled on these cars; charge on baggage, 25 cents per piece between any two points on the system.

"Express.—When handled on passenger cars, at shipper's request, regular express rates are charged. When handled on regular express cars, which are scheduled over each division of the road, the rates are the same as charged on the steam roads, based on the Illinois railroad and warehouse commission classification and distance tariff."

**Not Required to Stop at Street Crossings.**—The city council of Circleville, O., recently passed an ordinance requiring the Scioto Valley Traction Company to stop its cars at street intersections wherever passengers desire. The company appealed to the courts and was defeated in the lower court. The Ohio supreme court last week rendered a decision reversing the lower court and declaring the ordinance illegal.

**United Traction Company of Albany Answers Fare Complaint.**—The United Traction Company of Albany has filed with the New York public service commission, second district, an answer to the complaint of residents of Watervliet, regarding the 10-cent fare between Watervliet and Albany. The company states that the 10-cent fare is not discriminatory against Watervliet, as the same fare is charged to Albany from all of the other cities and towns north of the southern boundary of Watervliet and that the citizens of Watervliet are given the same right as to transfers as residents of Troy, Cohoes and Waterford.

**Transfer Decision in New York.**—The New York court of appeals, in a decision rendered on April 24, decides that a street railroad company has the right under Section 104 of the railroad law relating to transfers to regulate by any reasonable limitation the carriage of a passenger upon its line for a single fare. The case at issue, that of Peter C. Kelly against the New York City Railway Company, arose out of the refusal, in accordance with the rules of the company, by a conductor on the Eighth avenue line to accept "a southbound transfer upon a northbound car." Commenting upon the facts recited, Judge Gray points out that, under the construction of the law contended for by the plaintiff, "a passenger would be able to accomplish a round trip on the defendant's line for one fare."

**Protest Against Universal Transfer Scheme in Richmond, Va.**—William Northrop and Henry T. Wickham, receivers for the Virginia Passenger & Power Company of Richmond, Va., have sent a letter to the board of aldermen of Richmond, asking that they be heard with reference to a pending ordinance which would require the issue of universal transfers. The receivers state that the ordinance, in their judgment, would be in violation of contract rights and obligations between the city and the respective companies, which companies are absolutely separate and distinct, with separate stock ownership and bonded indebtedness; that it would entail practical difficulties in operation; and, above all, that it would seriously affect the financial interest of one, at least, of the companies to the hurt of its creditors.

**Handling Intoxicating Liquors.**—The Grand Rapids Holland & Chicago Railway has filed an amendment to the freight tariff with the Michigan railroad commission, refusing to accept shipments of beer, wine or spirits to Holland, Mich. Holland went "dry" at the recent election. Charles A. Floyd, general passenger and freight agent, said: "While there are probably no legal obligations upon us to discontinue hauling intoxicating liquor to Holland, and while there may be legal obligations on our part to handle that traffic, we realize that through the shipment of spirits over our line it would be easy for citizens of Holland to secure intoxicating liquor. It is evident that the citizens of Holland do not want the liquor business continued and it is our purpose to add our support to prevent the use of liquor there as far as possible. It is possible that the case may be decided by the courts, as it is a question whether the railroad commission can accept the schedule as amended. One of the acts of the last legislature provided for the exchange of business between steam and electric roads and the making of joint rates. It will be for the courts or the commission to decide whether our line can refuse shipments of liquor to Holland delivered by other lines."



# Construction News

## FRANCHISES.

**Aberdeen, S. D.**—J. A. Cleaver of Huron, S. D., has applied to the city council for a franchise to construct terminals for an interurban line in Aberdeen. The road will be 82 miles long, with terminals in Aberdeen and Huron, and work will be started as soon as the franchise is granted. It is stated that terminal franchises have been secured in Huron.

**Argenta, Ark.**—An extension of time in which to complete its proposed electric line in Argenta has been granted to the Argenta Railway Company.

**Bluefield, W. Va.**—A franchise has been granted to the Bluestone Traction Company to extend its lines on Bland, South, North and Jefferson streets.

**Charlotte, N. Y.**—The village board of Charlotte has granted a franchise to the Rochester Railway Company for the construction of a 200-yard loop from the Hotel Arundell around the American Cottage. In consideration of the privilege it is stated that the railway company will at once reduce the fare between Rochester and Charlotte. Work on the loop is to be started immediately.

**Evansville, Ind.**—The Evansville Suburban & Newburg Railroad Company, Evansville, Ind., has applied to the city council for permission to enter Evansville over Lincoln avenue and to the county commissioners for a new right of way through the county.

**Goldsboro, N. C.**—The board of aldermen has granted a franchise to T. Oliver and associates to build a 2-mile electric line in Goldsboro.

**Ithaca, N. Y.**—The Ithaca Street Railway Company has again applied for a franchise to double-track certain sections of its lines and to build a single track around the square included in South Tioga, Green and Cayuga streets. The former application, which was refused by the city, provided that a payment of \$10,000 be made to the city. In its place the company now offers to give the city \$500 a year for 50 years and \$750 a year for 49 years thereafter with the understanding that the franchise be for 99 years. This would make a total payment to the city of \$61,750.

**Nazareth, Pa.**—The Allen Street Railway Company of Bethlehem, Pa., has been granted a franchise in Nazareth.

**Pavilion, N. Y.**—The commissioner of highways has granted the Rochester Scottsville & Caledonia Electric Railroad Company permission to cross certain highways in Pavilion.

**Redlands, Cal.**—The Redlands Central Railway Company has applied for a franchise to build an electric line from the limits of Redlands to Redlands Junction, two miles. This work has been planned by the company for some time, but has been delayed on account of opposition by property holders along Brooksidge avenue, the proposed route of the line. The new line will connect Redlands with the main line of the Southern Pacific by trolley instead of by a gasoline line motor as heretofore. It is stated that this will also be part of a proposed road from Redlands to Riverside.

**Seattle, Wash.**—The Seattle Electric Company has applied for a franchise to extend its Alki Point line from the present terminus to a point about half a mile south of Alki Point. It is stated that property owners have subscribed \$25,000 to the bond issue of the company and donated the right of way for the extension. Work will be started as soon as the franchise is granted.

**Sioux City, Ia.**—The Sioux City Traction Company has applied for the renewal of several street railway franchises in Sioux City. A special ordinance has been drawn and the council has been asked to call a special election. The company has withdrawn its offer to build overhead tracks over Wall street, but will contribute \$25,000 toward building a general viaduct.

**Springfield, Ill.**—The Springfield Consolidated Railway Company has been granted permission to lay a double-track line in North Grand avenue from Rutledge street to West Grand avenue. An amendment to the franchise as originally applied for makes the expiration limit co-existent with the Rutledge street franchise, under which the company has been operating.

**Weston, Ore.**—E. S. Isaacs, representing the Washington-Oregon Traction Company of Walla Walla, Wash., has been

granted a franchise for the operation of its interurban line on Water street north and south through the city limits of Weston, Ore. The company now has right of way for the entire distance up Pine creek to Weston, about 10 miles. The road was incorporated last fall to build both steam and electric lines from Walla Walla south into Oregon.

## RECENT INCORPORATIONS.

**Champlain & Sanford Railroad, Albany, N. Y.**—Incorporated in New York with a capital stock of \$600,000 to build a steam or electric railroad from Addison Junction to Sanford Hill, N. Y., 18 miles. Incorporators: Charles M. Hyatt, Andrew Thompson and James McE. Thompson, all of Albany.

**Laurel Railway, Damascus, Va.**—Incorporated in Virginia to build a 5-mile railroad in Washington county. Capital stock, \$5,000 to \$10,000. Incorporators: A. A. Mock, president, Damascus; G. W. Clements, vice-president, and F. G. Clements, treasurer, both of New York; B. W. Mock, secretary, J. F. Rhea and C. A. Baker, all of Damascus, Va.

**Red Oak & Northwestern Interurban Promotion Company.**—Application has been made for a charter in Iowa to promote the construction of an electric railway from Red Oak to Des Moines, Ia., 166 miles. The road as planned will start at Red Oak and pass in a northeasterly direction through Milford, Fontanelle, Greenfield, Stuart, Redfield, Adel and Waukee to Des Moines. It is stated that the line will be financed by local capitalists in the towns and cities served. Capital stock, \$10,000. Incorporators: B. B. Clark, president, Red Oak; G. W. Curtis, vice-president, Redfield; M. N. Spencer and L. D. Goodrich, secretary and treasurer, respectively, Red Oak, Ia.

**Schuylkill & Dauphin Traction Company.**—This company has applied for a charter to build an electric railway connecting the principal towns in Lykens valley and western Schuylkill county, Pennsylvania. Incorporators: J. W. Moyer, Edgar D. Rank, Malcolm G. Stewart, Louis H. Schappell and N. D. Yoder.

**Seattle Snohomish & Everett Railway, Seattle, Wash.**—Incorporated in Washington to build an electric railway from Seattle to Everett by way of Bothell and Snohomish. The preliminary surveys have been made and engineers are now laying out the permanent route. It is proposed to build the first section of the road from Seattle to Bothell, 12 miles, during the summer, with as much additional mileage as can be completed before winter. Stock has been subscribed by land and timber owners along the proposed route and it is stated that work will be started at once. Capital stock, \$500,000. Incorporators: C. W. Kimball, J. H. McLaughlin and Clyde C. Whittenden, all of Seattle, Wash.

**Stillwater Power & Railway Company.**—Incorporated in Montana to build an electric railway from Billings to Cooke City, Mont., by way of Columbus, with branches to Yellowstone, Sweet Grass, Carbon and Park counties. It is stated that work will be started soon. Capital stock, \$3,000,000. Incorporators: Willard Bennett, Helena; George H. Savage, W. E. Defressee and E. E. Congdon, Butte, Mont.

**Taylorville (Ill.) Electric Railway.**—Incorporated in Illinois to build a street railway in Taylorville at a cost of about \$130,000. It is stated that the company has purchased a tract of land at one end of the proposed line, which it will equip for a summer park.

## TRACK AND ROADWAY.

**Birmingham & Gulf Railway & Navigation Company, Birmingham, Ala.**—This company, which proposes to build from Gadsden to Tuscaloosa, Ala., has recently begun construction at Tuscaloosa, and it is reported that construction will begin near Gadsden in a short time. J. M. Dewberry, Birmingham, Ala., is president. (Noted September 25, 1907.)

**Brantford (Ont.) Street Railway.**—It is reported that work will begin about May 1 on the double-tracking of the principal lines in Brantford.

**Brownsville Masontown & Smithfield Street Railway, Masontown, Pa.**—Construction work was started last week on the line from Brownsville to Smithfield, Pa., 20 miles, between Brownsville and Masontown. The contract was awarded to the Pennsylvania Railroad Construction Company. W. J. Sheldon of McKeesport, Pa., is president and E. C. McCullough of Uniontown is chief engineer. (Noted February 15.)

**Buffalo Lockport & Rochester Railway, Niagara Falls, N. Y.**—It is reported that construction on the line between Rochester and Albion, N. Y., is now completed except for a portion of the overhead work and that operation may be started on this section by May 15. On the Albion-Lockport section poles are now being erected and the tracklaying has

been completed from Middleport to Lockport. Edmund Wragge, chief engineer, Toronto, Ont. (Noted March 14.)

**Chambersburg Greencastle & Waynesboro Street Railway, Waynesboro, Pa.**—It is reported that this company expects to operate cars from Waynesboro to Chambersburg, Pa., by May 30. The line between Greencastle and Marion has been completed and construction is now in progress near Chambersburg and Guilford Springs. (Noted April 4.)

**Chicago & Milwaukee Electric Railroad, Highwood, Ill.**—Judge Tarrant has ordered the Fidelity Trust Company to issue \$1,000,000 of 6 per cent receiver's certificates as required, to be used in completing the line into Milwaukee. About eight miles of track remains to be completed. The Columbia Construction Company of Milwaukee has been awarded the contract and has agreed to accept the certificates in payment. Clement C. Smith, president of the construction company, announces that the line will be completed about July 15.

**Connecticut Company, New Haven, Conn.**—This company has applied to the Massachusetts railroad commission for approval of the route and method of construction of the proposed line from Hartford to Middletown, Conn.

**Dallas Interurban Electric Railway, Dallas, Tex.**—This company, which proposes to build a system of electric railways in Dallas, Oak Cliff, West Dallas and Cement City, Tex., about 20 miles, and an interurban line from Dallas to Terrell, 30 miles, is about to issue \$1,500,000 of first mortgage 5 per cent 20-year bonds based on its franchises, right of way and terminal property. Henry Dorsey, president. (Noted February 22.)

**Denver & Interurban Railway, Denver, Colo.**—It is reported that plans are being made for beginning operation about May 15 between Denver and Boulder, Colo. H. W. Cowan, chief engineer. (Noted March 21.)

**Des Moines & Sioux City Railway, Lake City, Ia.**—It is stated that surveys will be started at once for the proposed line from Des Moines to Lake City, Ia., via Sac City and Storm Lake, under the direction of J. G. Killely of Geneva, Ill. S. N. Elwood of Sac City is president. (Noted February 22.)

**Donora & Eldora Street Railway, Monongahela, Pa.**—It is stated that this company has received bids for the construction of its line from Donora to Eldora, 3.3 miles, and that work is to begin at once. The line will include a 350-foot viaduct. B. M. Hanna, 718 Penn avenue, Pittsburg, is president. (Noted November 30, 1907.)

**Edmonton (Alberta) Street Railway.**—Tracklaying has been completed on the municipal street railway line, consisting of about 6½ miles of double track. It is probable that a franchise will be granted for its operation.

**Elmira Corning & Waverly Railroad, Waverly, N. Y.**—It is reported that construction will be resumed this summer on the line between Elmira and Ashland, N. Y., a portion of the proposed Corning-Elmira line. G. T. Rogers of Binghamton, N. Y., is president.

**Ft. Smith (Ark.) Light & Traction Company.**—Construction has been started on an extension to a new suburb on the south side of Ft. Smith.

**Ft. Wayne & Springfield Railway, Decatur, Ind.**—Elections will be held on May 14 in Berne, Monroe, Decatur and Washington, Ind., for the purpose of voting on subsidies amounting to \$5,000 to aid in the construction of the extension from Decatur to Berne. (Noted March 14.)

**Fundy Park Amusement Company, St. John, N. B.**—This company proposes to build an amusement park at Westfield, a suburb of St. John, N. B., and to build an electric street railway from St. John to the park, 3.5 miles. Construction is to begin about June 1. Charles Diggs, 132 West Seventy-eighth street, New York, is secretary.

**Hudson & Long Island Traction Company, New York, N. Y.**—Arthur C. Hume, secretary, writes that this company proposes to build an electric railway from Long Island City across the Blackwell's Island bridge to the West Forty-second street ferry, Manhattan, 1½ miles, via Fifty-seventh street, Eleventh avenue and Forty-third street. The officers are: President, F. K. Morris; vice-president, C. M. Wicker; treasurer, Anthony Stumpf; chief engineer, W. B. Spencer, all with offices in the Times building, New York City. (Noted April 11.)

**Indianapolis Crawfordsville & Western Traction Company, Indianapolis, Ind.**—Officers and directors of this company are reported to have made an automobile inspection trip this week of two proposed routes for extensions west of Crawfordsville, Ind. The present terminus of the line. One route parallels the

Cleveland Cincinnati Chicago & St. Louis Railway to Danville, Ill., and the other extends to Attica, Ind.

**Kansas City & Olathe Electric Railroad, Kansas City, Mo.**—F. P. Dickson, president, writes that grading has been completed on the proposed 2-mile extension of this line from Merriam to Shawnee, Kan., and the overhead construction, which is of the bracket type, from Merriam to Hockers Grove, where a pleasure park is to be operated. Work on the remainder of the distance, 1½ miles, is being pushed. A power house equipped with two 150-horsepower gas engines and two 100-kilowatt generators has been completed at Merriam and furnishes power for that portion of the line from Rosedale to Merriam, which was placed in operation on October 10, 1907. A connection is made at Rosedale with the Metropolitan Street Railway of Kansas City, Mo. A. M. Myers, chief engineer, Merriam, Kan. (Noted April 25.)

**Kansas City (Mo.) Railway & Light Company.**—Construction was started last week on a 2-mile extension in Argentine, Kan.

**Kansas City Springfield & Southern Railway, Nevada, Mo.**—It is reported that grading has been started on the proposed line from Nevada to Springfield, Mo., 90 miles. The right of way was obtained and surveys were made last year. W. B. Forsyth, president; C. C. McFann, general manager. (Noted January 11.)

**Kansas Traction Company, Coffeyville, Kan.**—Surveys are being made in the vicinity of Lawrence, Kan., on the proposed line which is to connect Coffeyville and Lawrence with branches to Topeka and Kansas City. F. B. Shirley, president; Paul Julian, engineer. (Noted April 11.)

**Lake Erie Bowling Green & Napoleon Railway, Bowling Green, O.**—It is reported that this company is making financial arrangements for extending the line from Bowling Green to Tontogony, O. E. H. McKnight, vice-president and general manager. (Noted January 4.)

**Lake View Traction Company, Memphis, Tenn.**—R. F. Tate, president, writes that surveys have been completed from Memphis west to Clarksdale, Miss., and north to Covington, Tenn., 105 miles. The entire length of the line will be 148 miles, 65 of which will be in Mississippi and 83 in Tennessee. The road also will be built east from Memphis to Collierville, Tenn. Mr. Tate states that construction work will be started soon. (Noted February 29.)

**Lima-Honeoye Electric Light & Railroad Company, Lima, N. Y.**—E. D. Watkins, manager, writes that it is proposed to begin construction at an early date on extensions of the Lima-Honeoye line to Rochester on the north and to Atlanta or Wayland on the south. (Noted March 7.)

**Little Rock & Hot Springs Electric Railway, Little Rock, Ark.**—It is reported that construction work will be started within 90 days on the proposed line between Little Rock and Hot Springs, Ark., which it is estimated will serve a total population of about 250,000. The company plans to erect its own power station. As yet no contracts have been awarded. The officers are as follows: President, C. J. Kramer; vice-president, L. Garrett; secretary, J. C. Marshall; superintendent, J. F. Russ; electrical engineer, P. M. Pierce.

**Los Angeles & Port Orient Railway, Los Angeles, Cal.**—William H. Carlson, president, writes that this company proposes to build an electric railway from Hermosa Beach to Culler Station, Cal., seven miles, connecting with the Los Angeles Pacific Railway and the Los Angeles & Redondo Railway and forming a through route between Los Angeles and Redondo. J. H. Mather, chief engineer.

**Mankato (Minn.) Electric Traction Company.**—This company has recently completed a 5-mile street railway line in Mankato and regular operation is expected to begin within a few days. The Knox Engineering Company of Chicago had the contract for building the line. H. E. Hance, superintendent.

**Minneapolis St. Paul Rochester & Dubuque Traction Company, Minneapolis, Minn.**—We are officially advised that a contract has been let to H. A. Whittier of Northfield, Minn., for the grading between Savage and Northfield, Minn., on the proposed line from Minneapolis, Minn., to Dubuque, Ia. F. G. L. Hunt, chief engineer. (Noted April 18.)

**Maryland Electric Railways, Baltimore, Md.**—Rapid progress is being made on the electrification of the old Baltimore & Annapolis Short Line Railroad between Baltimore and Annapolis, Md., and it is stated that operation between Annapolis and Glenburnie will begin within a week. Between Clifffords and Camden a leased track of the Baltimore & Ohio Railroad will be used and the electrified line will reduce the

distance between the two cities to 26 miles. Power will be obtained from the plant of the Consolidated Gas Electric & Power Company at Westport, Md. J. G. White & Co. have the contract for the electrification work. J. Wilson Brown, president. (Noted September 21, 1907.)

**Mt. Hood Railway & Power Company, Portland, Ore.**—C. W. Miller, secretary and general manager, writes that this company proposes to build an electric line from Portland to Bull Run, Ore., 25 miles. Surveys have been made for a line from Portland to the Deschutes river, 150 miles. Grading has been completed and the overhead catenary construction is being erected from Gresham to Bull Run, 16 miles. The power house at Bull Run will be equipped with two 3,000-kilowatt generators. All contracts have been let. The Westinghouse Electric & Manufacturing Company has the contract for the electrical equipment, Pierson, Roeding & Co. for the overhead equipment and the Mason Construction Company for the construction work. E. P. Clark of Los Angeles is president; F. C. Finkle, Los Angeles, chief engineer. (Noted April 11.)

**Murphysboro (Ill.) Street Railway Light Heat & Power Company.**—John G. Hardy, secretary, writes that this company proposes to build a 3-mile extension in the city of Murphysboro the latter part of this year. The company now operates one mile of track and two cars.

**Newark Martinsburg & Mt. Vernon Electric Railway, Newark, O.**—It is reported that financial arrangements have been made for the construction of this proposed road from Newark to Mt. Vernon and Wooster, O., and that work will begin at an early date. Dr. J. F. Schronty is president.

**Northwestern Ohio Electric Railway, Defiance, O.**—This company, which proposes to build an electric railway from Defiance to Montpelier, O., 34 miles, via Bryan and Evansport, has filed a mortgage for \$1,000,000 in favor of the Security Savings Bank & Trust Company of Toledo to secure an issue of a like amount of 5 per cent bonds. G. G. Bloom, president, Stryker, O.; John Crowe, secretary, Defiance, O. (Noted May 4, 1907.)

**Oakland (Cal.) Traction Company.**—The Oakland board of works has ordered this company to widen the space between its tracks on Broadway from Water street to Fourteenth street. The line was formerly operated by cable and the tracks are embedded in cement.

**Prairie State Traction Company, Whitehall, Ill.**—It is reported that this company, which was incorporated last year to build an electric railway from Whitehall to Pana, Ill., has made arrangements for securing financial backing provided the right of way is obtained. (Noted March 23, 1907.)

**Pleasantville (Pa.) Traction Company.**—It is reported that capitalists of Oil City, Titusville and Pleasantville, Pa., have organized this company to build an electric railway connecting the cities named, a distance of about 12 miles.

**Public Service Railway, Newark, N. J.**—President Thomas N. McCarter has informed the Montclair board of trade that the company does not propose to build the proposed line from Montclair to Paterson, N. J., this year because of financial conditions.

**Puget Sound Electric Railway, Tacoma, Wash.**—Work has been started at the Puyallup end of the extension from Tacoma to Puyallup, Wash. W. S. Dimmock, manager. (Noted April 4.)

**Redlands & Yucaipa Electric Railroad, Redlands, Cal.**—This company has issued \$500,000 30-year 5 per cent bonds for the construction of its proposed line from Redlands to Oak Glen, Cal., 20 miles. O. D. Collins is chief engineer.

**Rochester Corning & Elmira Traction Company, Rochester, N. Y.**—Surveys are being made on the line from Hornell to Dansville, N. Y., a branch of the proposed line from Rochester to Elmira, N. Y. (Noted April 11.)

**St. Louis Montesano & Southern Railway, St. Louis, Mo.**—We are officially advised that grading and overhead work is in progress from St. Louis to Kinswick, Mo., 20 miles, on the proposed line from St. Louis to Flat River, 60 miles. Tracklaying has been completed for 1½ miles out of St. Louis. The construction work is being done by the company. A power house and substations for the first division are now under construction. The power house equipment will include compound Corliss engines, 400-kilowatt generator and two Heine boilers. Charles A. Gutke, president; John A. Laird, chief engineer. (Noted February 29.)

**St. Tammany & New Orleans Railway & Ferry Company.**—It is reported that 13 miles of grading have been completed on the line from Mandeville to Covington, La., and that track-

laying will begin at an early date. Clay Riggs of Covington is president. (Noted March 21.)

**Salt Lake & Ogden Railway, Salt Lake City, Utah.**—Simon Bamberger, president, has announced that the electrified line from Salt Lake City to Ogden, Utah, will be ready for operation by May 30. (Noted March 28.)

**Sioux City, Ia.**—Dr. L. A. Westcott and Robert Gracey of Cherokee, Ia., are seeking to interest the Sioux City Commercial Club in a project to build an electric railway from Sioux City to Spirit Lake, Ia.

**Windsor Essex & Lake Shore Rapid Railway, Windsor, Ont.**—The extension from Kingsville to Leamington, Ont., 10 miles, has been completed and was opened for traffic on April 22. (Noted March 28.)

**Yakima Valley Transportation Company, Yakima, Wash.**—Construction has been started on a 3-mile extension in North Yakima, Wash. A. J. Splawn, president. (Noted January 4.)

**York (Pa.) Railways Company.**—David Young, Jr., general manager, writes that this company is not contemplating at the present time any extensions except a short extension of the city lines in York.

#### POWER HOUSES AND SUBSTATIONS.

**Bear Lake Electric Light & Power Company.**—It is stated that this company will erect a new power house and make other improvements for the distribution of current for lighting purposes and the operation of an electric railway from Montpelier to the lake. C. R. Slusser, Montpelier, Idaho, is secretary.

**City & Elm Grove Railroad, Wheeling, W. Va.**—This company intends doubling the capacity of its power house at Elm Grove by installing steam turbines which will utilize the exhaust from the four high-pressure engines at present generating steam power for the electric machinery. These improvements will cost about \$35,000. J. W. Smith, general manager, Wheeling, W. Va.

**Columbia Electric Street Railway Light & Power Company, Columbia, S. C.**—This company will install a 1,000-kilowatt generator and other electrical machinery in its water power plant. E. W. Robertson, president, Columbia.

**Crookston, Minn.**—Elias Steenerson, postmaster of Crookston, Minn., and Knute Aaker of Hubbard are interested in the construction of a proposed dam across the Red river near Hubbard and a power plant which will furnish power for the operation of an electric railway between Fargo and Grand Forks, N. D., and Crookston, Minn. The Ambursen Hydraulic Company, 176 Federal street, Boston, Mass., has prepared plans and estimates. (Noted April 18.)

**Fairmont & Clarksburg Traction Company, Fairmont, W. Va.**—It is announced that this company intends to build a power plant at Clarksburg, W. Va. S. L. Watson, president, Fairmont, W. Va.

**Goose Creek Railway & Power Manufacturing Company, Jesup, Ga.**—D. G. Zeigler & Co., Atlanta, Ga., state that as soon as the plans have been completed contracts for the construction and equipment of this proposed plant will be let. Power will be furnished for the operation of an electric railroad, cotton mills and other commercial enterprises. The plant will cost about \$500,000.

**Hagerman, Idaho.**—It is announced that the Twin Falls Company is preparing to begin work on the construction of a power plant on the Snake river at Lower Salmon Falls, which will furnish power for the operation of projected electric lines in that section.

**North Coast Power Company.**—Work has been started on the construction of a dam across the Clearwater river about four miles north of Lewiston, Idaho. A hydro-electric plant here will generate power for the operation of the proposed interurban railway from Lewiston up the Snake river valley and across into Washington, serving Asotin, Cloverland and other points in that section, with a terminal at Pomeroy, Wash. It is stated that the power plant will be built for 50,000-horsepower ultimate capacity.

**Northern Power Company, Hibbing, Minn.**—Ground is being broken by this company for the construction of a power plant to be located about six miles north of Chisholm, Minn. When completed the plant will furnish power for the operation of the proposed lines of the Northern Traction Company, which will build an electric railway between Hibbing and Chisholm and operate local lines in the two towns. The company also will furnish power for lighting purposes in Chisholm.

## Personal Mention

Mr. William Long, for the past two years master mechanic of the Saginaw-Bay City Railway & Light Company at Saginaw, Mich., has resigned.

Mr. Fred W. Smith of Chicago has been elected a director of the Metropolitan West Side Elevated Railway Company of Chicago, succeeding Mr. Byron L. Smith, resigned.

Mr. J. MacWolf, heretofore superintendent of the Chambersburg Greencastle & Waynesboro Street Railway at Waynesboro, Pa., has resigned, effective on April 15.

Mr. Frederick G. Bourne was elected a director of the Long Island Railroad Company at a meeting of stockholders held last week in Long Island City, succeeding Franklin B. Lord, deceased.

Mr. Robert McArthur, heretofore chief engineer of the New Haven power stations of the Connecticut Company, has been transferred to Stamford, Conn. He will be succeeded at New Haven by Mr. J. F. Kirby, heretofore assistant engineer.

Mr. James R. League, formerly assistant secretary and treasurer of the Augusta Railway & Electric Company, Augusta, Ga., has been appointed general manager of the company, effective on May 1, succeeding Mr. E. P. Wetmore, resigned, as announced in an earlier issue.

Mr. T. C. Roberts, master mechanic of the Pueblo (Colo.) plant of the American Smelting & Refining Company, has been appointed superintendent of power and shops for the Pueblo & Suburban Traction & Lighting Company, with headquarters at Pueblo.

Mr. L. D. Mathes, whose portrait is presented herewith, was re-elected secretary and treasurer of the Iowa Street and Interurban Railway Association at its fifth annual meeting held at Des Moines, Ia., on April 23 and 24, 1908.

Mr. Mathes is about 36 years of age and was born in the south. He is a graduate of the University of Tennessee and before entering street railway work was for a time employed in the shops of the Memphis & Charleston Railroad at Memphis, Tenn. He then became connected with the Edison General Electric Company (now the General Electric Company) and later with the Westinghouse Electric & Manufacturing Company, during which time he was engaged in the construction and equipment of electric railways in various sections of the country. After five years' experience in this line of work he resigned to become general foreman of the Buffalo & Niagara Falls Electric Railway, where he remained until appointed superintendent of the Norfolk & Ocean View Railway at Norfolk, Va., then in the hands of a receiver. While with this company and under his direction a successful freight business was developed and at the end of his 2½ years' service the road was restored to the original owners on a paying basis. He subsequently was appointed general superintendent of the Charleston (S. C.) & Seashore Railway, resigning at the end of a year to accept a similar position with the Norfolk & Atlantic Terminal Company. He later went west to become general manager of the Union Electric Company at Dubuque, Ia., which position he now holds. Mr. Mathes has been secretary and treasurer of the Iowa Street and Interurban Railway Association since that body was organized five years ago.

Mr. J. L. Millsbaugh, heretofore in charge of the transportation department of the Detroit Jackson & Chicago Railway (formerly the Detroit Ypsilanti Ann Arbor & Jackson Railway), has been appointed general superintendent of the western division of the Michigan United Railways, with jurisdiction over the interurban lines between Jackson, Battle

Creek and Kalamazoo and the Kalamazoo and Battle Creek city lines. Mr. Millsbaugh had been connected with the Detroit-Ypsilanti lines since 1898, serving for five years in the mechanical and electrical departments. During the last five years he was in charge of the transportation department of the company.

Mr. Willis Holden has been elected to succeed the late Albert R. Hiscock as treasurer of the Auburn & Syracuse Electric Railroad, Rochester Syracuse & Eastern Railroad, Syracuse Lake Shore & Northern Railroad and the Syracuse & South Bay Electric Railroad. Mr. Fidelio K. Hiscock, a brother of Albert K. Hiscock, has been elected a director of the companies.

Mr. R. W. Harris, whose portrait is presented herewith, was appointed general manager of the Joplin & Pittsburg Railway at Pittsburg, Kan., effective on April 4, as announced in the Electric Railway

Review of April 18. Mr. Harris was born in Gordonsville, Va., on August 24, 1866, and was educated in the public schools of that town. After a four years' engineering course at a private school conducted by Prof. Fountain B. Davis, a well-known educator of Virginia, he entered the engineering department of the Chesapeake & Ohio Railroad, where he remained as assistant construction engineer for about three years. He then became associated with the Flat Top and Trans-Flat Top Coal Land Association of West Virginia, controlled by the E. W. Clark interests, resigning in 1896 to enter street railway work with



R. W. Harris.

the Richmond Traction Company at Richmond, Va., first as night dispatcher, then day dispatcher, chief dispatcher, assistant superintendent and superintendent of the Richmond lines. In July, 1902, when control of this company passed into the hands of Frank J. Gould and others, Mr. Harris was transferred to the Norfolk Railway & Light Company as assistant superintendent and later as superintendent at Norfolk under Mr. E. C. Hathaway, general manager. In December, 1904, he resigned to become superintendent of the Michigan Traction Company at Kalamazoo, Mich., and in December, 1905, when the property was merged with others into the Michigan United Railways, he went to Streator, Ill., as general manager of the Illinois Light & Traction Company, where he remained for two years. In December, 1907, he resigned to become general superintendent of the Joplin & Pittsburg Railway at Pittsburg, Kan., and now succeeds Mr. P. P. Crafts as general manager, who resigned on March 31, as announced last week.

Mr. William E. Price, heretofore in charge of the electrical department of the Pueblo & Suburban Traction & Lighting Company, Pueblo, Colo., has been relieved of these duties and will henceforth act as consulting electrical engineer of the company, with headquarters at Pueblo. The work of remodeling the Pueblo plant of the company, which is about completed, has been under the supervision of Mr. Price.

Mr. L. R. McBroon has been appointed general superintendent of the Rutland Railway Light & Power Company at Rutland, Vt., with charge of the operating and street railway departments, combining the duties heretofore discharged by Mr. Henry W. Brow, electrical engineer, and Mr. Walter H. Horton, general manager, resigned. Mr. McBroon formerly was with the General Electric Company.

### OBITUARY.

Samuel Haigh, formerly superintendent of the Westchester Traction Company, Ossining, N. Y., died last week of pneumonia at his home in Kings county, New York. Mr. Haigh was the first superintendent of the Delaware County & Philadelphia Electric Railway, Clifton Heights, Pa., having held that position from the time the road was placed in operation in the early nineties, until 1902. He was also at one time secretary of the Citizens Electric Light & Power Company of Chester, Pa.

# Financial News

**Birmingham & Gulf Railway & Navigation Company, Birmingham, Ala.**—This company has purchased the belt line at Tuscaloosa, Ala., formerly owned by the Tuscaloosa Belt Railway. The company has given a trust deed to the Carnegie Trust Company of New York as trustee to secure an issue of \$10,000,000 of 5 per cent bonds dated October 1, 1907, and due on October 1, 1957, but subject to call on and after April 1, 1912, at 108 and interest. The company plans to build an electric railway between Tuscaloosa, Birmingham and Gadsden.

**Buffalo & Lake Erie Traction Company, Buffalo, N. Y.**—The outstanding first and refunding mortgage bonds have been increased from \$4,755,000 to \$5,005,000 for the purpose of providing funds for the construction of an extension five miles in length in Mill Creek township, Pennsylvania.

**California Gas & Electric Corporation, San Francisco, Cal.**—A plan has been promulgated providing for the transfer of the properties of the subsidiary corporations, except railways, to this company and the creation of an authorized issue of \$45,000,000 of unifying and refunding mortgage 5 per cent bonds, as follows: To retire outstanding bonded debt after deducting bonds retired by sinking funds, \$30,282,000; to be issued at 90 for refunding existing obligations of the corporation incurred for new construction and improvements, \$3,055,000; to be sold at not less than 90 to provide for 85 per cent of the actual cost of future extensions and new property acquired, \$11,663,000. A syndicate has agreed to purchase the \$3,055,000 aforesaid bonds.

**Calumet & South Chicago Railway, Chicago, Ill.**—This company, which was recently incorporated to consolidate the South Chicago City Railway and the Calumet Electric Street Railway, has increased its capital stock from \$1,000 to \$5,000,000. The property and assets of the Calumet company were taken over on February 24 by permission of the federal court and the receivership will be vacated as soon as certain legal obstacles are removed.

**Ft. Dodge Des Moines & Southern Railroad, Ft. Dodge, Ia.**—L. E. Armstrong of Ft. Dodge has been elected a director.

**Ft. William, Ont.**—The city council is negotiating with the Port Arthur Street Railway for the purchase of that portion of its line which lies within the limits of Ft. William.

**Havana (Cuba) Electric Railway.**—Gross earnings of the railroad in 1907 were \$1,810,888 as compared with \$1,570,202 in 1906. Including the revenue of stage lines gross earnings were \$2,143,122 as compared with \$1,919,103. Operating expenses, taxes and rentals were \$1,232,735 as compared with \$1,251,660. After the payment of preferred dividends aggregating 5½ per cent, there was a surplus of \$91,075 in 1907 as compared with a deficit of \$31,932 after paying preferred dividends of 4 per cent in 1906. Warren Eicknell, the president, says in the annual report that the track-mile earnings during the year were in excess of \$36,000, indicating that the maximum earnings upon the present track mileage are being approximated and that additional mileage will be required soon to handle the increased traffic.—The New York stock exchange has listed \$1,115,000 additional consolidated mortgage 5 per cent bonds, making the total listed \$7,908,000.

**Honolulu Rapid Transit & Land Company, Honolulu, T. H.**—Gross earnings in 1907 were \$367,134 as compared with \$349,916 in 1906. Operating expenses were \$201,228 as compared with \$202,148. Total net income was \$173,381 as compared with \$153,499. A deduction of \$22,807 was made for depreciation as compared with a similar provision in 1906 of \$21,041. L. T. Peck, the president, states in the annual report: "As about one-third of the franchise period has passed by it is proper to remind you of the increasing importance of establishing a sinking fund for retiring, at least in part, the capital investment at the expiration of your franchise."

**Interborough Rapid Transit Company, New York, N. Y.**—The New York public service commission of the first district has authorized a bond issue of \$55,000,000, secured by mortgages on the company's entire property. At present only \$30,000,000 of the bonds will be issued. These will bear interest at 5 per cent, payable semi-annually, and will mature November 1, 1952. The \$30,000,000 of bonds will be issued as collateral security for an issue of \$25,000,000 3-year 6 per cent notes, which may be exchanged after 2½ years for the bonds at 99. It is officially announced that J. P. Morgan & Co. have agreed to underwrite the notes at 97 and accrued interest from November 1, 1907. The commission points out that the new

issue does not increase the company's indebtedness, as it will be used to retire outstanding obligations which mature soon, including the indebtedness incurred in connection with the Brooklyn extension of the subway.—The Continental Securities Company has filed a complaint in the United States circuit court against the Interborough Rapid Transit Company, the Interborough-Metropolitan Company, the Metropolitan Street Railway and the Windsor Trust Company asking for the appointment of a receiver for the Interborough Rapid Transit Company. The complaint alleges that the Interborough-Metropolitan Company is a monopoly, and that the stocks of the various component companies were acquired illegally. The complainant asks that all transactions in regard to the acquisition of stocks be declared invalid and that the stock of the Interborough Rapid Transit Company be re-exchanged and surrendered to the holders of the Interborough-Metropolitan 4½ per cent collateral trust bonds issued by the Windsor Trust Company to the amount of \$67,825,000.

**London Underground Electric Railways.**—Details of the plans for the readjustment of the finances of this company, which has been placed in the hands of Sir George Gibb as receiver, were made public last week. All the cash requirements are to be met through the sale to Speyer & Co. of \$5,000,000 12-year 5 per cent prior lien bonds, the bankers agreeing to provide up to \$1,500,000 additional cash for any possible deficiency in fixed charges during the further development of the enterprise. The plan provides that against the pledge of a total of \$72,500,000 face value of securities the company will issue \$5,000,000 prior lien 5 per cent bonds, the issue which Speyer & Co. are to purchase, \$15,000,000 4½ per cent bonds due 1933 and \$26,000,000 6 per cent income bonds due 1948. The present noteholders are to receive 40 per cent in 4½ per cent bonds and 70 per cent in 6 per cent income bonds, giving them \$1,100 in bonds for each \$1,000 note. In case the earnings of the properties develop sufficiently to enable the company to pay the full interest on the income bonds, the noteholders will get more than 5 per cent interest per annum, the rate which the notes carry now. The noteholders will, by accepting the income bonds, also have the controlling voice in the management, as the income bonds will be entitled to vote.

**Oregon Electric Railway, Portland, Ore.**—This company, which recently completed its line from Portland to Salem, Ore., has filed amended articles of incorporation providing for an increase of capital stock from \$2,500,000 to \$10,000,000 for the purpose of building additional lines.

**Pittsburg & Allegheny Valley Railway, Leechburg, Pa.**—Samuel J. Graham, Walter J. Guthrie and George M. Hosack have prepared a plan of reorganization as follows: "The new company shall have an authorized issue of \$250,000 of 30-year 5 per cent mortgage bonds, which are to be sold (with a bonus of 25 per cent of common stock) at not less than 85 per cent; authorized issues of \$450,000 of 6 per cent cumulative preferred stock and \$250,000 common stock. All bona fide holders of bonds and all persons who have actually paid in cash therefor may participate in the reorganization, the agreements to be signed and deposited with the bonds with the Safe Deposit & Trust Company of Pittsburg. The plan stipulates for a delivery by a large holder of bonds and a release of all his right and title in \$300,000 bonds and the delivery of the stock which he holds as collateral. For each \$1,000 bond the holder is to receive \$1,000 in preferred stock and \$400 in common stock, full paid.

**United Railways Investment Company, New York.**—The issue of \$5,500,000 of 6 per cent serial notes of 1908 has been sold. The company will acquire with the proceeds \$3,500,000 of first preferred 7 per cent stock of the United Railroads of San Francisco. The latter company reports gross earnings in March of \$558,524 as compared with \$537,700 in March, 1907.

**Washington Traction Company, South Charleston, O.**—The property of this company, whose line from Springfield to Charleston, O., 14 miles, has been operated by a receiver, S. B. Rankin, will be sold under foreclosure at the courthouse in Springfield on May 11. George Baker of Washington Court House, O., one of the largest creditors, has been buying bonds and claims against the road and it is understood that he will buy the road and extend it to Washington Court House.

**Waterloo Cedar Falls & Northern Railway, Waterloo, Ia.**—This company has negotiated a loan of \$2,000,000 from Louis Boissot and the First Trust and Savings Bank of Chicago for the purpose of extending its lines. The loan is for a term of 40 years, with interest at 5 per cent, and is secured by a trust deed.

**West Penn Railways, Pittsburg, Pa.**—Net earnings for the year ending March 31, 1908, were \$775,839, an increase over the previous year of \$132,946. The surplus was \$346,622.

# Manufactures and Supplies

## ROLLING STOCK.

**Pittsburg & Butler Street Railway**, Pittsburg, Pa., has ordered two interurban cars from the Cincinnati Car Company.

**Portland Railway Light & Power Company**, Portland, Ore., has placed an order with The J. G. Brill Company for 25 double-truck cars.

**Connecticut Valley Street Railway**, Greenfield, Mass., has placed an order with the Wason Manufacturing Company for five double-truck cars.

**Auburn & Northern Electric Railroad**, Auburn, N. Y., has placed an order with the G. C. Kuhlman Car Company for one large double-truck car.

**Washington Railway & Electric Company**, Washington, D. C., which has been reported in the market for 15 large double-truck cars, expected to place the order this week.

**Walla Walla Valley Traction Company** has placed an order with the Westinghouse Companies for two equipments for large cars, which are now being built by the American Car Company.

**Nanki Railway of Japan** has placed an order through Takata & Co., New York, for 12 double-truck equipments, including motors, trucks and air brakes. The order was secured by the Westinghouse interests.

**Choctaw Railway & Lighting Company**, McAlester, Okla., which was reported in the Electric Railway Review of April 18 to be in the market for two cars, has placed an order with the Niles Car & Manufacturing Company for two interurban trailers.

**Philadelphia Rapid Transit Company**, Philadelphia, Pa., is reported to be considering the adoption of the pay-as-you-enter type car. Estimates on the cost of converting 50 of the old cars have been asked and it is thought that the board of directors will authorize the expenditure.

## SHOPS AND BUILDINGS.

**Nelson (E. C.) Electric Tramway**.—The car houses of this company were destroyed by fire on April 27.

## TRADE NOTES.

**Curtain Supply Company**, Chicago, has moved its New York office to the Hudson Terminals.

**American Bridge Company** has moved its New York offices from 42 Broadway to the Hudson Terminals, 30 Church street.

**American Steel Foundries** has moved its New York offices from 42 Broadway to the Hudson Terminals, 30 Church street.

**Union Spring & Manufacturing Company**, Pittsburg, Pa., has moved its New York office to the Hudson Terminals, 50 Church street.

**Wendell & MacDuffie**, New York, have removed their offices from 26 Cortlandt street to the Hudson Terminals, Fulton building.

**Sherwin-Williams Company**, Cleveland, O., has moved its New York office from 66 Broadway to the Hudson Terminals, 50 Church street.

**Cassier Magazine Company** announces the removal of its New York offices from 3 West Twenty-ninth street to 12 West Thirty-first street.

**Railway Steel-Spring Company**, New York, has removed its general offices from 71 Broadway to the Hudson Terminals, Cortlandt building.

**Pressed Steel Car Company**, Pittsburg, has declared the regular quarterly dividend of 1½ per cent on its preferred stock, payable May 27.

**Eugene Munsell**, president of the Mica Insulator Company, New York, is dead. Mr. Munsell was 56 years old and had been in ill health for a long time.

**Henry F. Gillespie**, who has been assistant superintendent of the Standard Paint Company's works at Bound Brook, N. J., since 1893, has been appointed superintendent.

**Walter H. Baldwin**, for the past 11 years Chicago sales manager of the Lidgerwood Manufacturing Company, New York, has resigned and is now associated with the Adams & Westlake Company, Chicago, as assistant general manager.

The latter company has moved its New York offices to the Hudson Terminals, Cortlandt building.

**American Brake Shoe & Foundry Company**, Mahwah, N. J., has moved its New York offices from 170 Broadway to the Hudson Terminals, Cortlandt building.

**The Wilson Company**, 160 Harrison street, Chicago, publisher of The Railway Age and Electric Railway Review, has moved its New York offices from 150 Nassau street to the Hudson Terminals, Fulton building.

**Ohio Brass Company**, Mansfield, O., on May 8 will remove its New York offices from 43 Exchange place to 1022 Hudson Terminals, Cortlandt building. On May 1 the Chicago offices of the company were moved from 321 Dearborn street to 508 Fisher building.

**Westinghouse Electric & Manufacturing Company's** merchandise creditors' plan, which was outlined in the Electric Railway Review for April 11, has been approved by representatives of claims aggregating \$3,500,000 out of a total of \$4,250,000 of merchandise debt.

**Pantasote Company**, 11 Broadway, New York, has had its Pantasote curtain material and Agosote headlining specified for the 25 cars to be built by The J. G. Brill Company for the Portland Railway Light & Power Company, as reported elsewhere in this issue of the Electric Railway Review.

**Griffin Double Tread Car Wheel Company**, Buffalo, N. Y., has been incorporated with a capital stock of \$200,000 to manufacture a car wheel patented by P. H. Griffin, who recently resigned as general manager of the New York Car Wheel Company, as reported in The-Railway Age for April 24. Mr. Griffin is not an officer or director of the new company, but his two sons, H. F. Griffin and W. A. Griffin, will be president and secretary, respectively.

**Robert W. Hunt & Co.**, Chicago, have established an analytical chemical laboratory in connection with their St. Louis office, 1445 Syndicate Trust building. In addition to general analytical work particular attention will be given to analyses of and advice on iron foundry mixtures. This work and the laboratory will be under the direction of J. B. Emerson, who for several years past had charge of the metallurgical part of the wheel foundry of the Mt. Vernon Car Company. Previous to that Mr. Emerson was in the employ of the Illinois Steel Company.

**Charles A. Maher**, who for many years has been in the business of manufacturing and marketing car wheels, and who is now, and has been since its formation, vice-president of the National Car Wheel Company, Pittsburg, has associated himself with Otis, Bonnell & Co., Cleveland, as sales manager of the car wheel department, and will handle exclusively the cast-iron and steel-tired street and steam railway wheels manufactured by the National Car Wheel Company, as heretofore, with offices 408-410 Cuyahoga building, Cleveland, O. J. E. Rawson will continue as sales manager of the steel department, and William F. Bonnell will devote his time largely to the interests of the Securities Corporation, Limited, of 40 Wall street, New York, and the Guanajuato Development Company, operator of mines, mills and railroads in the city and state of Guanajuato, Mexico.

## ADVERTISING LITERATURE.

(Mention of the Electric Railway Review will assure prompt attention to requests for publications listed here.)

**Portland Rose Festival Association**, Portland, Ore.—A handsomely engraved folder invites attendance at the Portland rose festival to be held June 1 to 6, 1908.

**Purdue University**, Lafayette, Ind.—The annual catalogue for 1907-08, a book of 320 pages, 5 by 7 inches, is published as Vol. VIII, No. 4, of the University Bulletin.

**Goldschmidt Thermit Company**, 90 West Street, New York, N. Y.—A 12-page illustrated leaflet treats the subject of butt welding wrought iron and steel and pipes and rods by the thermit process.

**Hyatt Roller Bearing Company**, Newark, N. J.—A recently issued catalogue devoted to Hyatt roller bearings contains information regarding more than 300 sizes that have been standardized and are now carried in stock. Each bearing has a capacity rating which enables the engineer to determine the most efficient size.

**J. G. White & Co.**, New York, N. Y.—"At Work Around the World" is the title of an artistic book illustrating and describing some of the more important work done on five continents by this company and affiliated companies. The book is unusually interesting from cover to cover and contains many fine illustrations.

**NEW DESIGN FOR PAY-AS-YOU-ENTER CARS.**

The Jewett Car Company has designed and is now putting on the market a new type of pay-as-you-enter car. A full-size model of this car has been on exhibition in New York, and the new features brought out in this design have met with very favorable comment.

The Jewett design provides for wide folding doors on opposite corners of each platform. These doors are closed on the front platform and open at the rear end, this opening being used for exit and entrance ways for passengers. There are small sliding doors at the opposite sides of the platforms, the door at the rear end being closed and locked. The forward sliding door may be used for the exit of passengers.

The particularly interesting feature of the Jewett design consists in the novel arrangement of the folding partitions,

railway managers is the fact that the maximum seating capacity is obtained inside the car body, there being no necessity for cutting out the corner seats for doorways. Folding seats are also arranged to be let down on the front platform, giving room for six passengers in addition to those in the interior of the car body.

**THE WESTINGHOUSE HORIZONTAL DOUBLE-ACTING GAS ENGINE.**

At the end of March, 1908, there were 122 power plants equipped with Westinghouse producer gas engines, comprising 271 engines and aggregating 68,000 brake horsepower, or an average of 553 horsepower per plant. The engines averaged approximately 250 horsepower each, and all equipment

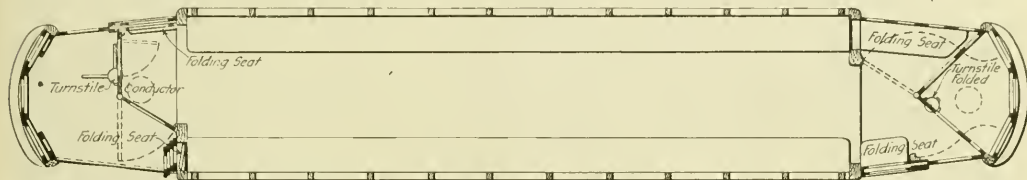

Pay-As-You-Enter Car—Platform Arrangement for Double-End Operation.

which are hinged about an upright pipe placed on the car platform. These partitions are identical at either end of the car and on the front platform are swung into a V-shaped position, forming an inclosed cab for the motorman. On the rear platform one of these partitions is locked at right angles to the center line of the car. The partition carries within itself a swinging door which forms the entrance way for passengers. The other partition on the rear platform swings against the bulkhead, thus closing the rear end of the car completely. This partition is swung to a position at right angles to the

contained in the above total was either in operation at that date or in course of erection. The largest producer plant, about 3,000 brake horsepower, operates the works of the Winchester Repeating Arms Company, New Haven, Conn.

Contrary to the general impression, parallel operation at all but excessive frequencies has ceased to be a difficulty. Although spring couplings are used in the vertical type single-acting engine, they are unnecessary in the horizontal engine, except for special cases.

Recognizing the definiteness of the point of overload

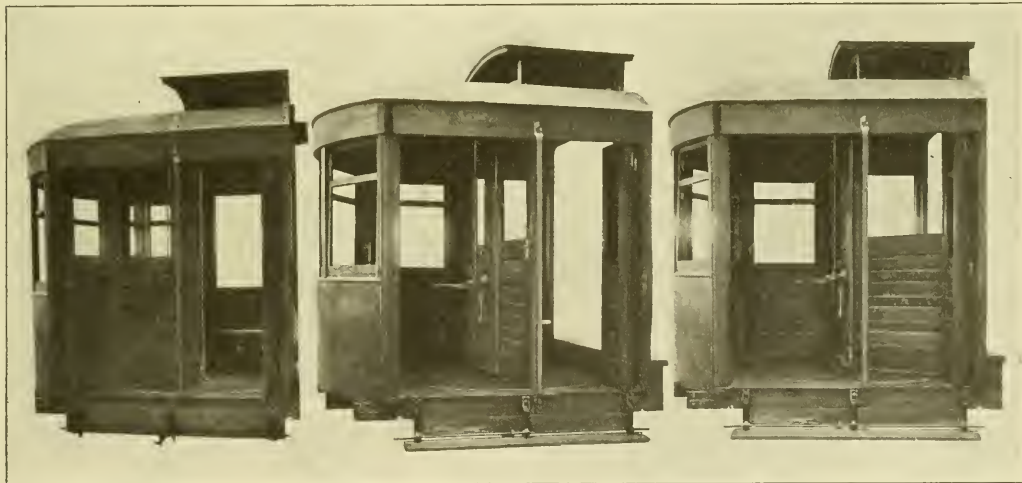

Pay-As-You-Enter Car—Front Platform (Left), Rear Platform with Exit Door Open (Center) and Closed (Right).

center line of the car, and in this position forms the exit at the rear end.

In connection with this car the Jewett company has developed a very interesting type of automatic folding turnstile, which is placed on the partition at the jam of the swinging entrance door. This turnstile is connected to the car register, and positively registers each passenger entering through the entrance door. The turnstile is automatically folded by the movement of the partition, to which it is fastened when this partition is moved to form the motorman's cab. The movement of the swinging partition also automatically folds up the steps at the doors which are not in use on the blind side of the car.

The valuable feature of the design which appeals most to

capacity, the rating of Westinghouse gas engines is placed at the conservative figure of 10 per cent below the maximum load the engine will sustain for a considerable period. Thus, an engine rated at 500 horsepower could sustain 550 horsepower for long periods. Owing to the high efficiency of the 4-stroke cycle gas engine, economy is largely independent of the size of the unit, so that a 200 or 300 horsepower engine is nearly as efficient in heat consumption as an engine of 1,000 or more horsepower. Both show a heat consumption of close to 10,000 British thermal units per brake horsepower-hour, and this efficiency is largely independent of the kind of gas used, due to the fact that leaner gases will stand higher compression, up to 200 pounds for furnace gas. The tandem cylinder arrangement is standard for all sizes of engines, whether

single or double crank. The former gives two power strokes per revolution, the latter four power strokes per revolution, with cranks at 90 degrees. This tandem arrangement, with reasonable size flywheels, easily yields a turning moment sufficiently uniform for all tandem work.

The cylinders of the small engines are symmetrical 1-piece

reservoir with individual sight feeds, all controlled by a single valve so that individual adjustments, once set, need not be changed. One of the engines here illustrated is in the Bessemer works of the Carnegie Steel Company, and is operated by blast furnace gas. It drives an electric generator (1,500 kilowatts direct current) and is rated at 2,400 horse



Westinghouse Horizontal Double-Acting Gas Engine—Engine at the Bessemer Plant of the Carnegie Steel Company.

castings, having an opening in the jacket walls, thus avoiding shrinkage in casting. Split jacket bands close the openings with joints made of a flexible packing, which permits the cylinders to expand independently of the jackets. Suitable openings in the jacket walls permit cleaning the water spaces, which are completely accessible by removing the jacket band and water rings at the bottom, surrounding each exhaust. As previously mentioned, all Westinghouse horizontal engines are of the side crank construction, necessitating the alignment of but two bearings. The smaller shafts are solid forgings and the larger ones are bored hollow. Cranks, counterweights and crankpins are cast in one piece, with the pin at the bottom of the mold to insure homogeneous metal.

The pistons are cast in one piece, symmetrical in design, and avoid internal ribs or sharp corners and without the use of chaplets or other methods of core support. They are permanently mounted on the rod with a straight press fit and a retaining nut turned off flush with the piston after being set up. Rods are made in two parts so as to permit removal through front and rear housing, which avoids the extra building clearance for a through rod. They are bored hollow for cooling water, except at the center of the piston, where the ducts connect. Instead of a single governor valve controlling all inlets from a single point, the governing is accomplished directly at each inlet, the inlet valve performing the function of mixing and governing. Thus gas and air are mixed only at the point of entry to the cylinder, and in exact quantity required by the load, a condition of sensitive governing.

An excellent feature of this engine is that only one eccentric is employed to operate both inlet and exhaust valves, instead of independent cams or eccentrics. This eccentric motion is transmitted by pull rods to a rocking cam motion similar to that used in marine work. Inlet and exhaust are, of course, reversed to accomplish the valve openings at proper points in the cycle. This motion gives the very desirable maximum power at opening, followed by rapidly increasing lift as the valve opens without bringing heavy thrusts upon the eccentric. With fixed eccentrics and no lost motion, it is evident that no opportunity exists for change of adjustment of valves except from wear of the rolling cams, which is obviated by the use of generous contact areas well lubricated. Make and break ignition has been adopted to the exclusion of all other systems after much experimenting, as the most practical for average conditions. Platinum points formerly used are now entirely done away with and cast-iron or a special bronze is employed for the moving contact, working against a fixed steel terminal. High voltages and low current furnished by a small motor generator give the desired results.

Recognizing engine lubrication as a vital necessity the builders have relieved the operator entirely of the work by automatic lubrication. In a number of 500-horsepower plants cylinder oil consumption is as low as from three to five gallons per week when working 10 hours per day. Engine oil is served by a gravity system, including pump, filter and elevated

horsepower. The cylinders are 40 by 54 inches and speed 75 revolutions per minute.

#### BEILHARZ HOUSING FOR EMBEDDED BOLTS.

The accompanying illustration shows a design of metallic housing or socket for securing bolts in concrete or masonry, a patent upon which has been applied for by W. E. Beilharz, 409 Union building, San Diego, Cal. As is apparent from the drawing, the design is such that the bolts can be removed or renewed without difficulty. The chamber inclosing the head prevents the bolt from turning and the lower flange of the casting constitutes an anchor. The small lugs at the top are

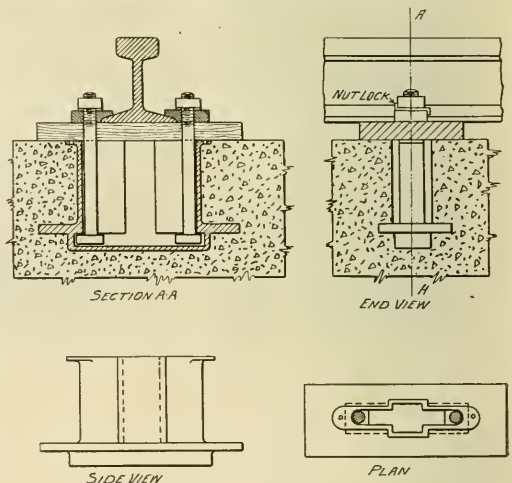

Beilharz Housing for Embedded Bolts.

provided for securing the housing to the forms or templates while being embedded. This housing is intended to be used wherever expansion or other bolts embedded in masonry are required and the application to concrete railroad ties is apparent. Dimensions can, of course, be varied to suit conditions. The illustration shows the housing as applied to a railroad tie.



# IMMEDIATE SHIPMENT

## 40 Westinghouse 56 Motors 12 Extra Armatures for same

All in first-class operative condition.

We will accept in trade other Motors, Cars, Trucks, or Power House Apparatus. Write!

**ARTHUR S. PARTRIDGE**, 425 Olive Street, St. Louis

# Titan Gears and Pinions

WILL OUTWEAR FIVE ORDINARY CUT TOOTH GEARS AND PINIONS. "TITAN" GEARS AND PINIONS MADE OF MANGANESE STEEL.

**ATHA STEEL CASTING CO.**, Newark, N. J.

## Washburn Standard M. C. B. Coupler —equal to every test

This coupler enabled heavy interurban cars to be hauled on their own wheels in trains from St. Louis to Los Angeles—and without a single breakage. The 152 cars equipped with these couplers are now in fast and heavy service on the Pacific Electric Railway, running in trains of from two to six units each, and around the short curves of city streets.

*Our 112-page catalog of traction devices sent free for the asking.*

**Washburn Steel Castings & Coupler Co.**, Minneapolis, Minn.

Western Agents: Tweedy, Hood & Finlen, 2014 Fisher Bldg., Chicago  
Canadian Agent: John Taylor, Montreal

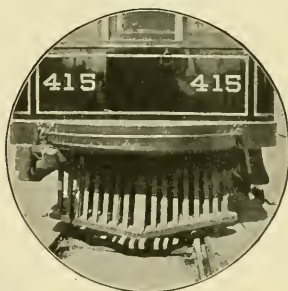

18

# The Moore Track Drill

does not interfere with traffic!

The shifting of one lever and a few seconds' time takes down the drill—the operation reversed makes it ready for work again.

This is only one of the many strong points about the Moore Track Drill that make it worth buying.

*Ask for descriptive catalogue.*

**Kalamazoo Railway Supply Co.** Kalamazoo Michigan

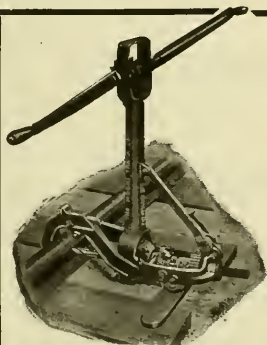

1

---

## THE J. G. BRILL COMPANY, PHILADELPHIA, PA.

AMERICAN CAR COMPANY, ST. LOUIS, MO.  
 G. C. KUHLMAN CAR COMPANY, CLEVELAND, OHIO  
 JOHN STEPHENSON COMPANY, ELIZABETH, N. J.  
 WASON MANUFACTURING CO. SPRINGFIELD, MASS.

MAIN OFFICE: PHILADELPHIA, PA.  
 LONDON OFFICE: 110 CANNON ST. E. C.  
 PACIFIC COAST AGENTS: PIERSON  
 ROEDING & CO., SAN FRANCISCO.  
 AUSTRALIAN AGENTS: NOYES  
 BROTHERS, SYDNEY. CABLES:  
 "BRILL," PHILA., "AXLES" LONDON.

---

*CARS TRUCKS SEATS RATTAN SPRINGS SPECIALTIES SUPPLIES*

## LARGEST EARNING CAPACITY

For service in cities and towns, where an entirely open car with side entrances is desirable during warm weather, no better car can be found than the Brill Convertible. Unquestionably the entirely open car is the most popular summer type and the Brill Convertible overcomes the two drawbacks of the ordinary car--no protection in bad weather and the necessity for a double equipment of cars--and provides exactly what is wanted for every day in the year. Climatic conditions, of whatever kind, are no bar to the use of the Brill Convertible Car; it is equally successful in the Northern States with their arctic winters as in the Gulf States with their tropical summers. The flexible metal panels slide into the roof pockets just as easily as the sashes, therefore any one can operate them. The Brill Convertible Car is the most practical solution of the question of how to always secure the largest amount of traffic.

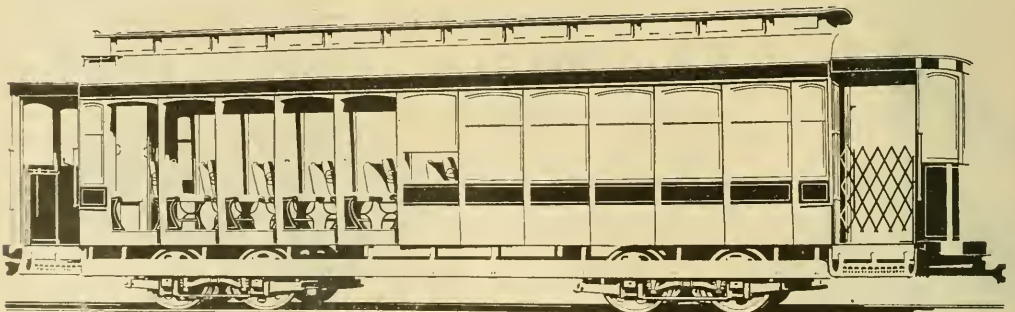

*THE BRILL CONVERTIBLE CAR (PATENTED)*

# General Electric Company

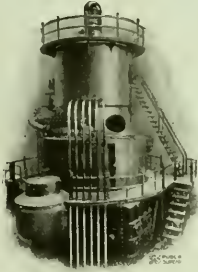

## Curtis Steam Turbines

show a nearly constant efficiency  
over a wide range  
of load

The following load curve is based on tests made in the Fisk Street Power House of the Commonwealth Edison Company, Chicago, Ill., and shows a maximum variation in economy of 5% from 5,000 to 12,000 kilowatts.

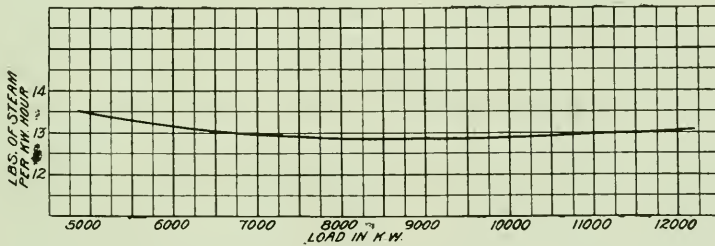

"Load-Water Rate Curve" for a 9,000-K.W., 5-Stage, 750 R. P. M. Curtis Turbo-Generator Unit, Operating at 200 Lbs. Gauge Pressure, with 125° Superheat and 29 Inches Vacuum.

Curtis Steam Turbines  
are made in standard  
sizes from 15 K.W. to  
14,000 K.W.

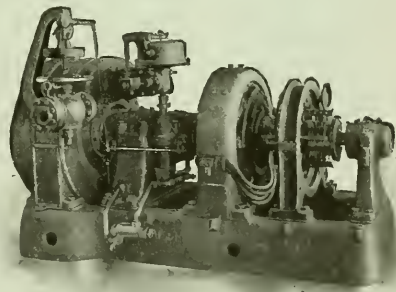

Chicago Office  
Monadnock Bldg.

Principal Office: Schenectady, N. Y.

Sales Offices in  
All Large Cities

# Stuart-Howland Co.

Everything Electrical  
BOSTON

## FOR EVERY KIND OF MEASURING

there's a reliable and absolutely accurate steel tape made by

**THE LUFKIN RULE CO.** New York  
London, England  
Windsor, Canada  
SAGINAW, MICH., U. S. A.



For CABLE, ELECTRIC and  
ELEVATED CARS

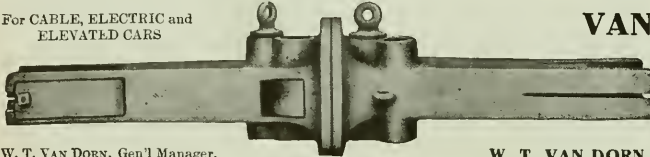

W. T. VAN DORN, Gen'l Manager.

No. 5

## VAN DORN AUTOMATIC COUPLERS

The records go farther than talk.  
Look up the records.  
Send for booklet of information on Couplings.

W. T. VAN DORN COMPANY, 1076 S. Paulina Street, CHICAGO

Your gear and pinion cost can be reduced  
over one-half by lubricating them with

## Whitmore's Gear Protective Composition

We can prove this by roads that are using it.  
Give us an opportunity to demonstrate the  
merits of our product.

**The Whitmore Manufacturing Company**  
LUBRICATING ENGINEERS  
Cleveland, Ohio, U. S. A.



Established 1877.



## ALBERT & J. M. ANDERSON MFG. CO.,

Makers of

**ELECTRICAL APPLIANCES:**  
SWITCHES, SWITCHBOARDS,  
TIME SWITCHES, LINE MATERIAL,  
COPPER CASTINGS (75%) CONDUCTIVITY.  
289-293 A ST., BOSTON, MASS., U. S. A.

New York, 135 Broadway. Chicago, 175 Dearborn Street.

Agencies:  
Boston, Pettingell-Andrews Co. San Francisco, Eccles & Smith Co.  
New York, R. W. Marshall & Co. Atlanta, Newcomer-Manry Co.  
St. Louis, J. C. White. Denver, E. M. Messiter.  
Toronto, Ont., H. J. Surtees.



# Baltimore Center and Side Bearings

## FOR ELECTRIC TRUCKS

Impossible  
to Clog  
Balls

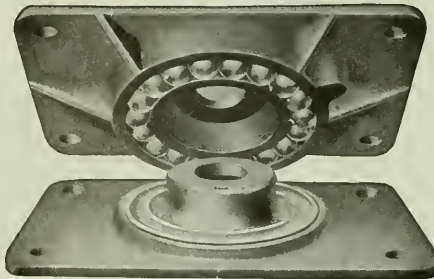

No  
Lubrication  
Necessary

**SAVES:** { FLANGE WEAR  
RAIL WEAR  
TRUCK REPAIRS

**DURABILITY:** { PROVEN  
UNDER  
HEAVIEST  
LOADS

BALTIMORE  
MD.

# THE T. H. SYMINGTON CO.

CHICAGO  
ILL.

# Electric Railway Review

PUBLISHED EVERY SATURDAY.

FORMERLY THE STREET RAILWAY REVIEW.

THE WILSON COMPANY, CHICAGO.

CHICAGO: 160 Harrison Street  
NEW YORK: 50 Church Street  
CLEVELAND: 1529 Williamson Bldg.

Vol. XIX  
No. 19

CHICAGO, MAY 9, 1908

Whole No.  
263

Subscription: Domestic, \$2.00  
Foreign, 5.00  
Canada, 3.50

*Electric Railway Companies can well afford  
to present copies of this standard handbook—*

## “The Motorman and His Duties”

*—to motormen and shopmen, for the result will  
be better, safer, more economical operation.*

¶ The purpose of this book is to familiarize the reader with the operation of electric railway cars.

¶ It explains in simple language, devoid of mathematics and many points not generally understood by the average em do with the operation or care of electric railway rolling edge cannot fail to make his services more valuable more satisfactory to himself, and it will also bett

¶ The revised, enlarged and improved sixth edi 138 illustrations; three folding sheets of mult. diagrams; attractive green cloth binding, stampe

*Price, \$1.50 per copy, prep.  
Special prices in quantities of 50*

*Descriptive pamphlet sent on request.*

THE WILSON COMPANY,

# National Air Compressors

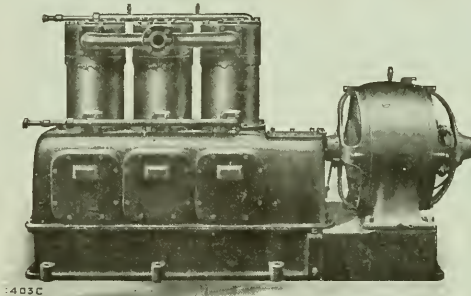

100 cu. ft. Type "3VS" Air Compressor.

These Compressors are especially adapted for service in car shops and barns, where compressed air is used, for various industrial operations, as well as for blowing dust and other accumulations out of car motors, controllers and seats.

Either direct or alternating current motors can be furnished for operating same.

Automatic starters which start and stop the Compressors and keep the air supply within the desired range of pressures are furnished with each Compressor.

Type "3VS" Compressors are built in capacities of 50, 100, 150 and 225 cu. ft. of free air per minute.

Write for Bulletin 84-F

## National Brake & Electric Company MILWAUKEE, WIS., U. S. A.

NEW YORK: 111 Broadway  
SAN FRANCISCO, CAL.: W. F. McKenny, 69-71 First St.

PHILADELPHIA: W. H. Goble, 1722 Westmoreland St.  
BOSTON: F. E. Huntress, 131 State St.

LONDON: 14 Great Smith St., Westminster

General Sales Office: 519 First National Bank Building, Chicago

# THE SYMINGTON JOURNAL BOX IS NOW STANDARD

ON 95 PER CENT OF ALL MODERN ELECTRIC TRUCKS

Impossible  
to Clog  
Balls

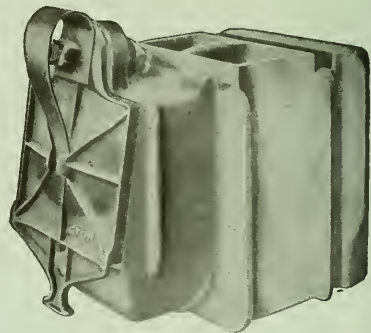
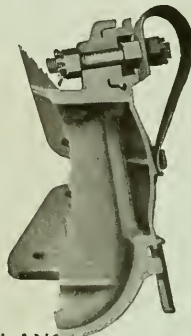

**SAVES:** { FLANG  
RAIL  
TRUCK!

WE ARE PREPARED TO FURNISH AT ONCE  
**REPAIR BOXES**

FOR ANY MAKE OF TRUCK IN SERVICE

BALTIMORE  
MD.

**THE T. H. SYMINGTON CO.**

CHICAGO  
ILL.

# Westinghouse

## No. 93-A<sub>2</sub> Railway Motor

An All Round Motor for All Round Work

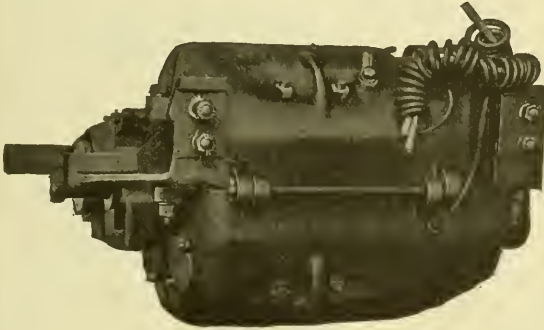

*For City Service:* A double equipment will operate under usual conditions any single or double truck car not exceeding in length 35 to 40 ft. over all and weighing not over 30,000 lbs. without equipment, at an average speed of 10 to 13 miles per hour.

*For City and Suburban Service:* A quadruple equipment will operate double-truck cars from 40 to 50 ft. over all, weighing not over 30,000 lbs. without equipment, at an average speed of 17½ miles per hour.

*For Interurban Service* the same equipment as for suburban cars will maintain a schedule of 23 to 28½ miles per hour.

Circular 1101 for particulars.

## Westinghouse Electric & Mfg. Co.

Atlanta  
Baltimore  
Boston

Buffalo  
Chicago  
Cincinnati

Cleveland  
Dallas  
Denver

Detroit  
Kansas City  
Los Angeles  
Minneapolis

New Orleans  
New York  
Philadelphia

Pittsburg  
St. Louis  
Salt Lake City

San Francisco  
Seattle  
Syracuse

Canada: Canadian Westinghouse Co., Ltd., Hamilton, Ontario Mexico: G. & O. Braniff & Co., City of Mexico

## Westinghouse "AMM" Automatic Brake

assures quick service, graduated release, quick recharge and high pressure in emergency for one to five car trains.

**Quick Deceleration  
is more important than  
Quick Acceleration  
in electric traction  
service.**

You may have the most powerful motors, capable of attaining the highest speeds in the shortest time, but their use would be neither practical nor safe without improved automatic air brakes capable of stopping, with equal or greater celerity, cars running at any speed.

### Westinghouse Traction Brake Co.

Pittsburg, Pa.

New York, Chicago, St. Louis,  
City Investing Bldg. Ry, Exchange Bldg. 1322 N. Broadway

For Canada: Canadian Westinghouse Co., Ltd., Hamilton, Ont.

## Have you exhaust steam?

If so, there is no need to increase your boiler equipment to get a greater electric power output.

## Westinghouse Exhaust-Steam Turbines

may double your power-producing capacity with the steam you are now wasting. They will, in some cases, even generate more power than the primary engine. Our nearest sales office will give you full particulars regarding this latest development in Westinghouse Turbines.

### The Westinghouse Machine Co.

New York, 105 Broadway  
Boston, 131 State Street  
Cleveland, New England Building  
Chicago, 171 La Salle Street  
Cincinnati, Traction Building

Atlanta, Candler Building  
St. Louis, Chemical Building  
Pittsburg, Westinghouse Bldg.  
Philadelphia, N. American Bldg.  
Denver, McPhee Building

San Francisco, Hunt, Mirk & Co.

ALPHABETICAL INDEX TO ADVERTISEMENTS.

Advance Lumber Co. ....	Dearborn Drug & Chemical Works ..... 11	Model Stoker Co. .... 14	Standard Brake Shoe Co. .... 14
Allis-Chalmers Co. ....	Detroit Bolt Co. .... 12	Morden Frog & Crossing Wks. ....	Standard Motor Truck Co. .... 11
Aluminum Co. of America. 11	Dousett & Co. .... 12	National Brake & Electric Co. 24	Standard Paint Co. .... 12
American Brake Shoe & Fdry. Co. ....	Drouvé, G., Co. .... 12	National Brake Co. .... 24	Standard Steel Works Co. .... 16
American Electrical Works. ....	Eclipse Railway Supply Co. 20	National Lock Washer Co. .... 22	Standard Underground Cable Co. ....
American Frog & Switch Co. ....	Electric Railway Equipment Co. .... 23	National Pole Co. .... 22	Star Brass Works. .... 21
Anderson, Albert & J. M., Mfg. Co. .... 28	Electric Ry. Improvement Co. 28	National Tube Co. .... 5	Stone & Webster Engineering Corporation ..... 15
Armstrong Oiler Co. .... 28	Electric Service Supplies Co. .... 14	Naugle Pole & Tie Co. .... 22	Stuart-Howland Co. .... 2
Arnold Company ..... 14	Engineers and Contractors. 14	New York Switch & Crossing Co. .... 17	Symington, T. H., Co. .... 21
Atha Steel Casting Co. .... 23	Fairbanks, Morse & Co. .... 12	Niles Car & Mfg. Co. .... 17	Telegraph Signal Co. .... 21
Automatic Trolley Guard Co. 14	Ford, Bacon & Davis. .... 14	Northern Engineering Works. 21	Trolley Supply Co. .... 21
Babeock & Wilcox Co. .... 11	Galena-Signal Oil Co. .... 23	Nuttall, R. D., Co. .... 21	U. S. Metal & Mfg. Co. .... 19
Baker, Wm. C., Heating & Supply Co. .... 17	Garford Co. .... 28	Ohio Brass Co. .... 17	Van Dorn & Dutton Co. .... 19
Baldwin Locomotive Works. 16	General Electric Co. .... 27	Okonite Co., Ltd. .... 16	Van Dorn, W. T., Co. .... 18
Barbour-Stockwell Co. .... 16	General Engineering Co. .... 14	Pacific Coast Pole Co. .... 22	Van Valkenburg, E. C. .... 18
Barnes, G. H., Hardwood Lumber Co. .... 22	Griffin Wheel Co. .... 14	Pantastote Co. .... 18	Wanted and For Sale Cards. .... 20
Beldler, Francis, & Co. .... 22	Hagy, J. Milton, Waste Wks. 11	Partridge, Arthur J. .... 25	Washburn Steel Castings & Coupler Co. .... 25
Bellamy Vestiette Mfg. Co. 18	Hale & Kilburn Mfg. Co. .... 14	Patten, Paul B. .... 22	Washington Machine Co. .... 3
Berthold & Jennings. ....	Hartshorn Co., Stewart. .... 14	Pay-As-You-Enter Car Co. .... 9	Western Electric Co. .... 5
Bridgport Brass Co. .... 28	Heine Safety Boiler Co. .... 14	Power Specialty Co. .... 22	Westinghouse Elec. & Mfg. Co. .... 3
Brill, J. G., Co. .... 21	Heywood Bros. & Wakefield Co. .... 18	Pressed Steel Car Co. .... 17	Westinghouse Traction Brake Co. .... 3
Brown, Harold P. .... 19	Holman, D. F., Ry. Tracklayer Co. .... 22	Queen & Co. .... 21	Weston Electrical Instrument Co. .... 24
Brown Hoisting Machy. Co. 15	Humbird Lumber Co., Ltd. ....	Rail Joint Co. .... 16	Wharton, Wm., Jr., & Co. .... 16
Buckeye Engine Co. .... 16	Jewett Car Co. .... 17	Railway Specialty & Supply Co. .... 16	Wheeler Condenser & Eng'g Co. .... 14
Burnham, Williams & Co. 16	Johns-Manville, H. W., Co. .... 5	Register, A. L., & Co. .... 14	Wheel Truing Brake Shoe Co. .... 14
Bylesby, H. M., & Co. .... 14	Kalamazoo Ry. Supply Co. .... 25	Robertson, Wm., & Co. .... 13	Whitmore, H. M., & Co. .... 18
Central Inspection Bureau. 14	Landsley Bros. Co. .... 22	Roder Ballast Car Co. .... 14	Wilson, J. G., Mfg. Co. .... 24
Chase-Shawmut Co. .... 23	Lord & Burnham Co. .... 18	Rooke Automatic Register Co. 23	Woodruff, Carlton Co. .... 14
Chicago Mica Co. .... 21	Larkin Rule Co. .... 28	Russell Car & Snow-Plow Co. 20	Woodman, B., Mfg. & Supply Co. .... 12
Churchill Cedar Co. .... 22	Lumen Bearing Co. .... 28	S-E. Missouri Cypress Co. .... 22	Worcester, C. H., Co. .... 22
Cincinnati Car Co. .... 22	Macallen Co. ....	St. Louis Car Wheel Co. .... 7	Zelnicke, Walter A., Supply Co. .... 20
Cleveland Frog & Cross. Co. ....	McGuire-Cummings Mfg. Co. ....	St. Louis Car Wheel Co. .... 7	
Collier, Barron G. .... 18	Marshall, R. W., & Co. .... 20	Sanderson & Porter. ....	
Columbia Construction Co. .... 14	Meyers, Fred J., Mfg. Co. .... 12	Saxton, E. ....	
Consolidated Car Fender Co. 22	Michigan Steel Boat Co. .... 20	Shinners Chase Co. .... 14	
Consolidated Car-Heating Co. 14	Miller Anchor Co. .... 12	Sheaff & Jastad. ....	
Contractors' Supply & Equip-ment Co. .... 12	Milloy Electric Co. .... 12	Shelby Electric Co. .... 24	
Crane Co. .... 14		Simmons, John, Co. .... 21	
Creaghead Engineering Co. 14		Smith, Peter, Heater Co. .... 14	
Curtain Supply Co. .... 14		Speer Carbon Co. .... 14	
Davis, John, Co. ....			

CLASSIFIED LIST OF ADVERTISERS.

Advertising Designs and Plates. Woodbury-Carlton Co., Worcester, Mass.	Badges and Buttons. Electric Service Supplies Co., 200 Plymouth Bldg., Chicago.	Boilers—Continued. Lord & Burnham, Irvington-Hudson, N. Y.	Brakes and Brake Parts—Continued. Wason Mfg. Co., Springfield, Mass.
Advertising Service. Van Valkenburg, E. C., 2117 West One Hundred and Second St., Chicago.	Ballast Cars—(See Cars. Ballast).	Boiler Cleaning Compounds. Dearborn Drug & Chemical Works, Chicago.	Westinghouse Traction Brake Co., Pittsburg, Pa.
Advertising, Street Car. Collier, Barron G., Flat Iron Bldg., New York.	Ball Bearings. Symington, T. H., Co., Baltimore, Md.	Johns-Manville, H. W., Co., New York.	Brakeshoes. American Brake Shoe & Fdry. Co., Malhawk, N. J.
Air Brakes—(See Brakes and Brake Parts).	Bases—(See Trolley Poles and Fittings).	Bonds, Rail. Brown, H. P., 120 Liberty St., New York.	American Car Co., St. Louis.
Air Compressors—(See Compressors, Air).	Bearings. Electric Service Supplies Co., 200 Plymouth Bldg., Chicago.	Chase-Shawmut Co., Newburyport, Mass.	Barbour-Stockwell Co., Cambridgeport, Mass.
Alloys and Bearing Metals. Brown, H. P., 120 Liberty St., New York.	General Electric Co., Schenectady, N. Y.	Electric Railway Improvement Co., Cleveland, O.	Brill, J. G., Co., Philadelphia.
General Electric Co., Schenectady, N. Y.	Lumen Bearing Co., Buffalo, N. Y.	Electric Service Supplies Co., 200 Plymouth Bldg., Chicago.	Kuhlman, G. C., Car Co., Cleveland.
Lumen Bearing Co., Buffalo, N. Y.	McGuire-Cummings Mfg. Co., Chicago.	General Electric Co., Schenectady, N. Y.	McQuire-Cummings Mfg. Co., Chicago.
Ohio Brass Co., Mansfield, O.	Marshall, R. W., & Co., 95 Liberty St., New York.	Johns-Manville, H. W., Co., New York.	Marshall, R. W., & Co., 95 Liberty St., New York.
St. Louis Car Co., St. Louis, Mo.	Nuttall, R. D., Co., Pittsburg.	Ohio Brass Co., Mansfield, O.	St. Louis Car Co., St. Louis.
Aluminum Wire, Etc. Aluminum Co. of America, Pittsburgh.	Van Dorn & Dutton Co., Cleveland, O.	Symington, T. H., Co., Baltimore, Md.	Standard Brake Shoe Co., Aurora, Ill.
Anchors. Electric Service Supplies Co., 200 Plymouth Bldg., Chicago.	Bells and Gongs. American Car Co., St. Louis.	Ohio Brass Co., Mansfield, O.	Stephenson, John, Co., Elizabeth, N. J.
Miller Anchor Co., Norwalk, O.	Brill, J. G., Co., Philadelphia.	St. Louis Car Co., St. Louis.	Wason Mfg. Co., Springfield, Mass.
Ohio Brass Co., Mansfield, O.	General Electric Co., Schenectady, N. Y.	Stephenson, John, Co., Elizabeth, N. J.	Wagon Mfg. Co., Springfield, Mass.
Armatures and Coils, Winding and Repairing. Electric Service Supplies Co., 200 Plymouth Bldg., Chicago.	Wason Mfg. Co., Springfield, Mass.	Western Electric Co., Chicago.	Wharton, Wm., Jr., & Co., Philadelphia.
General Electric Co., Schenectady, N. Y.	Block System—(See Signals).	Boilers. American Brake Co., 888 Elliott Sq., Buffalo, N. Y.	Wheel Truing Brake Shoe Co., Detroit.
Marshall, R. W., & Co., 95 Liberty St., New York.	Boiler. American Brake Co., 888 Elliott Sq., Buffalo, N. Y.	Chicago.	Bridge Timbers. Beldler, Francis, & Co., Chicago.
Stuart-Howland Co., Boston.	Boiler. American Brake Co., 888 Elliott Sq., Buffalo, N. Y.	Chicago.	Brushes, Motor and Dynamo. Electric Service Supplies Co., 200 Plymouth Bldg., Chicago.
Armature Lifts. Electric Service Supplies Co., 200 Plymouth Bldg., Chicago.	Boiler. American Brake Co., 888 Elliott Sq., Buffalo, N. Y.	Chicago.	General Electric Co., Schenectady, N. Y.
Articles Materials. H. V. Co., Pittsburg.	Boiler. American Brake Co., 888 Elliott Sq., Buffalo, N. Y.	Chicago.	McGuire-Cummings Mfg. Co., Chicago.
Axe—(See Tools and Axes).	Boiler. American Brake Co., 888 Elliott Sq., Buffalo, N. Y.	Chicago.	National Brake Co., 888 Elliott Sq., Buffalo, N. Y.
Babbit Metals—(See Alloys and Bearing Metals).	Boiler. American Brake Co., 888 Elliott Sq., Buffalo, N. Y.	Chicago.	National Brake & Electric Co., Milwaukee.
	Boiler. American Brake Co., 888 Elliott Sq., Buffalo, N. Y.	Chicago.	Stephenson, John, Co., Elizabeth, N. J.



# WESTERN ELECTRIC

CHICAGO DENVER PITTSBURG COMPANY SAINT PAUL NEW YORK  
 ST. LOUIS PITTSBURG CINCINNATI CLEVELAND ATLANTA  
 SAN FRANCISCO SEATTLE SALT LAKE CITY LOS ANGELES KANSAS CITY PHILADELPHIA

WE CARRY IN STOCK

a complete line of

Trolley Overhead Material and  
 Electric Street Railway Supplies

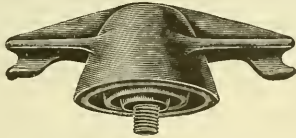

insulated with the well-known



INSULATION

We can make quick deliveries on your largest orders. Write for bulletins and prices.

## Will the Tape You Use Stand This Test?

Two pieces of JOMANCO FRIC-TION TAPE stuck together will hold a 37 pound weight without pulling apart or breaking. Do you know of any other tape that will stand this test?

There is no danger of JOMANCO TAPE breaking when applying it. When it is once applied, you can rest assured that it will stay where it is put.

## Jomanco Tape

has great strength and adhesive qualities, which, with its exceptionally long life, make it the best tape on the market. Our process of calendaring the composition distributes it evenly and thoroughly works it into the fabric, so there are no lumps or pinholes. Every roll contains just the yardage and weight you pay for, and one roll is just as good as another.

Write nearest Branch for sample and booklet.

## H. W. JOHNS-MANVILLE CO.



NEW YORK	PITTSBURG	MINNEAPOLIS
MILWAUKEE	CLEVELAND	SAN FRANCISCO
CHICAGO	BUFFALO	LOS ANGELES
BOSTON	BALTIMORE	SEATTLE
PHILADELPHIA	NEW ORLEANS	DALLAS
ST. LOUIS	KANSAS CITY	LONDON

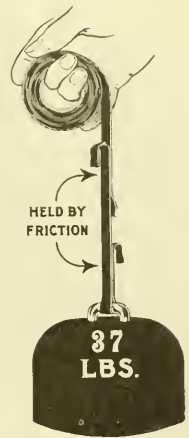

# AN INTERESTING PROBLEM

Simplicity + Durability + Perfection = ?  
 Answer: The "Kewanee" Union

Octagon Pattern



**SIMPLICITY**—Only three parts—no inserted brass pieces to loosen or drop out.

**DURABILITY**—Brass to iron thread connection absolutely prevents corrosion in the thread; can therefore be disconnected and reconnected indefinitely without injury, thus outlasting several ordinary unions.

**DESIGN**—Only three perfect parts.

**MATERIAL**—Brass and Iron; cannot corrode.

**FORM**—Can be easily moved with a common monkey wrench.

**SERVICE**—Equally good for steam, water, air, gas, oil, etc.

**TEST**—Before shipment with compressed air under water.

Fill out Coupon and get the "Answer"

## National Tube Company

General Sales Offices, Frick Bldg.  
 PITTSBURG, PA.

NEW YORK, N. Y.—Hudson Terminal Bldgs.  
 PHILADELPHIA, PA.—Pennsylvania Bldg.  
 ST. LOUIS, MO.—Third Nat. Bank Bldg.  
 SALT LAKE CITY, UTAH—Dooly Bldg.

### DISTRICT SALES OFFICES

PITTSBURG, PA.—Frick Bldg.  
 DENVER, COLO.—Majestic Bldg.  
 SAN FRANCISCO, CAL.—Crocker Bldg.  
 PORTLAND, ORE.—Wells Fargo Bldg.

ATLANTA, GA.—Candler Bldg.  
 CHICAGO, ILL.—Commercial Nat. Bank Bldg.  
 NEW ORLEANS, LA.—Maison Blanche.  
 SEATTLE, WASHINGTON—Alaska Bldg.

### COUPON

NATIONAL TUBE COMPANY, 1824 Frick Bldg., PITTSBURG, PA.  
 Gentlemen:—Enclosed find ten cents (stamps or coin) to partly pay postage on sample Octagon "Kewanee" Union, that I may test its merits. I will report on same after testing.

Name \_\_\_\_\_ Street \_\_\_\_\_

City \_\_\_\_\_ State \_\_\_\_\_

Name of dealer from whom supplies are usually bought \_\_\_\_\_

E. R. R.

## CLASSIFIED LIST OF ADVERTISERS—Continued.

- Car Replacers—Continued.**  
Fairbanks, Morse & Co., Chicago.  
Kalamazoo Railway Supply Co., Kalamazoo, Mich.  
Ohio Brass Co., Mansfield, O.  
U. S. Metal & Mfg. Co., 25 Broad St., New York.
- Car Seats.**  
American Car Co., St. Louis.  
Brill, J. G., Co., Philadelphia.  
Hale & Kilburn Mfg. Co., Philadelphia.  
Heywood Bros. & Wakefield Co., Wakefield, Mass.  
Kuhlman, G. C., Car Co., Cleveland.  
St. Louis Car Co., St. Louis.  
Stephenson, John, Co., Elizabeth, N. J.  
Wason Mfg. Co., Springfield, Mass.
- Car Steps.**  
Electric Service Supplies Co., 200 Plymouth Bldg., Chicago.
- Car Trimmings—(See Trimmings, Car).**
- Cars, Ballast.**  
Rodger Ballast Car Co., Chicago.  
St. Louis Car Co., St. Louis.
- Cars, Dump.**  
Fairbanks, Morse & Co., Chicago.  
Rodger Ballast Car Co., Chicago.  
Russell Car & Snow-Plow Co., Ridgway, Pa.  
St. Louis Car Co., St. Louis.
- Cars, Passenger and Freight.**  
American Car Co., St. Louis.  
Brill, J. G., Co., Philadelphia.  
Cincinnati Car Co., Cincinnati.  
Detroit Carbuilding & Equipment Co., Detroit, Mich.  
Electric Railway Improvement Co., Cleveland, O.  
Fairbanks, Morse & Co., Chicago.  
Jewett Car Co., Newark, O.  
Kuhlman, G. C., Car Co., Cleveland.  
McGuire-Cummings Mfg. Co., Chicago.  
Niles Car & Mfg. Co., Niles, O.  
Pressed Steel Car Co., Pittsburg.  
Rodger Ballast Car Co., Chicago.  
Russell Car & Snow-Plow Co., Ridgway, Pa.  
St. Louis Car Co., St. Louis.  
Standard Motor Truck Co., Pittsburg.  
Stephenson, John, Co., Elizabeth, N. J.  
Wason Mfg. Co., Springfield, Mass.
- Cars, Pay-As-You-Enter.**  
Pay-As-You-Enter Car Co., 26 Cortland St., New York.
- Cars, Rebuilt.**  
Detroit Carbuilding & Equipment Co., Detroit, Mich.
- Cars, Second-Hand.**  
Detroit Carbuilding & Equipment Co., Detroit, Mich.  
Marshall, R. W., & Co., 95 Liberty St., New York.  
Zelnicker, Walter A., Supply Co., St. Louis.
- Cars, Steel.**  
Pressed Steel Car Co., Pittsburg.  
St. Louis Car Co., St. Louis.  
Standard Motor Truck Co., Pittsburg.
- Castings, Brass.**  
Star Brass Works, Kalamazoo, Mich.
- Castings, Iron and Steel.**  
American Brake Shoe & Foundry Co., Mahwah, N. J.  
Green Engineering Co., Com'l Nat. Bk. Bldg., Chicago.  
National Brake & Electric Co., Milwaukee.  
Standard Steel Works Co., Philadelphia, Pa.  
Washburn Steel Castings & Coupler Co., Minneapolis.
- Catchers—(See Trolley Retrievers and Catchers).**
- Cattleguards.**  
Fairbanks, Morse & Co., Chicago.
- Circuit-Breakers.**  
Electric Service Supplies Co., 200 Plymouth Bldg., Chicago.  
General Electric Co., Schenectady, N. Y.  
Western Electric Co., Chicago.
- Coal Handling Machinery—(See Conveyors).**
- Coils—(See Armatures and Coils)**
- Commutators and Parts.**  
Electric Service Supplies Co., 102-24 Filbert St., Phila.  
General Electric Co., Schenectady, N. Y.  
Marshall, R. W., & Co., 95 Liberty St., New York.  
Ohio Brass Co., Mansfield, O.  
Stuart-Howland Co., Boston.
- Compressors, Air.**  
Fairbanks, Morse & Co., Chicago.  
General Electric Co., Schenectady, N. Y.  
National Brake & Electric Co., Milwaukee.  
Westinghouse Traction Brake Co., Pittsburg.
- Concrete Mixers.**  
Contractors' Supply & Equip. Co., Chicago.
- Condensers.**  
Wheeler Condenser & Engineering Co., Carteret, N. J.
- Conduits.**  
Electric Service Supplies Co., 200 Plymouth Bldg., Chicago.  
Western Electric Co., Chicago.
- Connectors, Solderless.**  
Dossert & Co., 212 W. Forty-first St., New York.
- Contractors.**  
Arnold Company, 181 La Salle St., Chicago.  
Bylesby, H. M., Co., Am. Trust Bldg., Chicago.  
Columbia Construction Co., Milwaukee, Wis.  
Creaghead Engineering Co., Cincinnati, O.  
Green Engineering Co., Com'l Nat. Bk. Bldg., Chicago.  
Register, A. L., & Co., 112 N. Broad St., Philadelphia.  
Sanderson & Porter, 52 William St., New York.  
Saxton, E., 811 Eldensburg Rd., Washington, D. C.  
Sheaff & Jaastad, 88 Broad St., Boston.  
Stone & Webster Engineering Corporation, Boston.  
Wharton, Wm., Jr., & Co., Philadelphia.  
White, J. G., & Co., 49 Exchange Pl., New York.
- Controllers and Attachments.**  
Electric Service Supplies Co., 200 Plymouth Bldg., Chicago.  
General Electric Co., Schenectady, N. Y.  
Johns-Manville, H. W., Co., New York.  
Marshall, R. W., & Co., 95 Liberty St., New York.  
Western Electric Co., Chicago.  
Westinghouse Electric & Mfg. Co., Pittsburg.
- Conveyors and Coal Handling Machinery.**  
Green Engineering Co., Com'l Nat. Bk. Bldg., Chicago.  
Northern Engineering Works, Detroit, Mich.
- Cord, Bell and Trolley.**  
American Car Co., St. Louis.  
Brill, J. G., Co., Philadelphia.  
Electric Service Supplies Co., 1020-24 Filbert St., Phila.  
Kuhlman, G. C., Car Co., Cleveland.  
St. Louis Car Co., St. Louis.  
Stephenson, John, Co., Elizabeth, N. J.  
Stuart-Howland Co., Boston.  
Wason Mfg. Co., Springfield, Mass.
- Couplers, Car.**  
American Car Co., St. Louis.  
Brill, J. G., Co., Philadelphia.  
Kuhlman, G. C., Car Co., Cleveland.  
McGuire-Cummings Mfg. Co., Chicago.  
Ohio Brass Co., Mansfield, O.  
St. Louis Car Co., St. Louis.  
Stephenson, John, Co., Elizabeth, N. J.
- Couplers, Car—Continued.**  
Van Dorn, W. T., Co., Paulina St., Chicago.  
Washburn Steel Castings & Coupler Co., Minneapolis.  
Wason Mfg. Co., Springfield, Mass.
- Coverings, Pipe and Boiler.**  
Johns-Manville, H. W., Co., New York.
- Cranes, Hoists and Lifts.**  
American Car Co., St. Louis.  
Brill, J. G., Co., Philadelphia.  
Brown Hoisting Machinery Co., Cleveland, O.  
Kuhlman, G. C., Car Co., Cleveland.  
Northern Engineering Works, Detroit, Mich.  
Railway Specialty & Supply Co., Chicago.  
Stephenson, John, Co., Elizabeth, N. J.  
Van Dorn & Dutton Co., Cleveland, O.  
Wason Mfg. Co., Springfield, Mass.
- Cross Arms—(See Brackets and Cross Arms).**
- Crossing Gates—(See Gates and Guards).**
- Crossings, Track—(See Switches, Frogs and Crossings).**
- Curtains, Fixtures and Materials.**  
American Car Co., St. Louis.  
Brill, J. G., Co., Philadelphia.  
Curtain Supply Co., 93 Ohio St., Chicago.  
Electric Service Supplies Co., 200 Plymouth Bldg., Chicago.  
Hartshorn Co., Stewart, East Newark, N. J.  
Kuhlman, G. C., Car Co., Cleveland.  
Marshall, R. W., & Co., 95 Liberty St., New York.  
National Lock Washer Co., Newark, N. J.  
Pantaso Co., 11 Broadway, New York.  
St. Louis Car Co., St. Louis.  
Stephenson, John, Co., Elizabeth, N. J.  
Wason Mfg. Co., Springfield, Mass.
- Cylinder Oil.**  
Power Specialty Co., 111 Broadway, New York.
- Derailing Devices.**  
Cleveland Frog & Crossing Co., Cleveland, O.
- Doors and Fixtures.**  
American Car Co., St. Louis.  
Brill, J. G., Co., Philadelphia.  
Kuhlman, G. C., Car Co., Cleveland.  
St. Louis Car Co., St. Louis.  
Stephenson, John, Co., Elizabeth, N. J.  
Wason Mfg. Co., Springfield, Mass.
- Doors, Steel Rolling.**  
Wilson, J. G., Mfg. Co., New York.
- Draft Rigging.**  
Van Dorn, W. T., Co., Chicago.  
Washburn Steel Castings & Coupler Co., Minneapolis.
- Drills, Track.**  
Brown, H. P., 120 Liberty St., New York.  
Electric Service Supplies Co., 200 Plymouth Bldg., Chicago.  
Fairbanks, Morse & Co., Chicago.  
Kalamazoo Railway Supply Co., Kalamazoo, Mich.  
Marshall, R. W., & Co., 95 Liberty St., New York.
- Dynamos and Generators.**  
Fairbanks, Morse & Co., Chicago.  
General Electric Co., Schenectady, N. Y.  
National Brake & Electric Co., Milwaukee, Wis.  
Western Electric Co., Chicago.  
Westinghouse Electric & Mfg. Co., Pittsburg, Pa.
- Electrical Instruments.**  
Electric Service Supplies Co., 200 Plymouth Bldg., Chicago.  
General Electric Co., Schenectady, N. Y.
- Electrical Instruments—Continued.**  
Johns-Manville, H. W., Co., New York.  
Queen & Co., Philadelphia.  
Western Electric Co., Chicago.  
Westinghouse Electric & Mfg. Co., Pittsburg, Pa.  
Weston Electrical Instrument Co., Newark, N. J.
- Electric Railway Supplies, General.**  
Creaghead Engineering Co., Cincinnati, O.  
Electric Service Supplies Co., 200 Plymouth Bldg., Chicago.  
Fairbanks, Morse & Co., Chicago.  
General Electric Co., Schenectady, N. Y.  
Johns-Manville, H. W., Co., New York.  
Marshall, R. W., & Co., 95 Liberty St., New York.  
Ohio Brass Co., Mansfield, O.  
Stuart-Howland Co., Boston.  
Western Electric Co., Chicago.
- Engineers and Contractors.**  
Arnold Company, Chicago.  
Bylesby, H. M., & Co., Chicago.  
Columbia Construction Co., Milwaukee, Wis.  
Ford, Bacon & Davis, New York.  
Register, A. L., & Co., Philadelphia.  
Sanderson & Porter, New York.  
Saxton, E., Washington, D. C.  
Sheaff & Jaastad, Boston.  
Stone & Webster Engineering Corporation, Boston.  
White, J. G., & Co., New York.
- Engines, Gas and Oil.**  
Buckeye Engine Co., Salem, O.  
Fairbanks, Morse & Co., Chicago.  
Westinghouse Machine Co., Pittsburg.
- Engines, Hoisting.**  
Fairbanks, Morse & Co., Chicago.
- Engines, Steam.**  
Buckeye Engine Co., Salem, O.  
Westinghouse Machine Co., Pittsburg.
- Fans, Exhaust and Ventilating.**  
General Electric Co., Schenectady, N. Y.  
Westinghouse Electric Co., Chicago.  
Westinghouse Elec. & Mfg. Co., Pittsburg.
- Fare Boxes—(See Electric Railway Supplies).**
- Fare Registers and Register Fittings.**  
Electric Service Supplies Co., 200 Plymouth Bldg., Chicago.  
Rooke Automatic Register Co., Providence, R. I.
- Feed Water Apparatus.**  
Wheeler Condenser & Engineering Co., Carteret, N. J.
- Feed Wire—(See Wire and Cables).**
- Fenders and Guards.**  
Consolidated Car Fender Co., Providence, R. I.  
Eclipse Railway Supply Co., Cleveland, O.  
Electric Service Supplies Co., 1020-24 Filbert St., Phila.  
McGuire-Cummings Mfg. Co., Chicago.  
Marshall, R. W., & Co., 95 Liberty St., New York.
- Flangers, Snow.**  
Kalamazoo Railway Supply Co., Kalamazoo, Mich.  
McGuire-Cummings Mfg. Co., Chicago.  
Ohio Brass Co., Mansfield, O.  
Van Dorn & Dutton Co., Cleveland, O.
- Frogs—(See Switches, Frogs and Crossings).**
- Fuses and Fuse Devices.**  
Chase-Shawmut Co., Newburyport, Mass.  
Electric Service Supplies Co., 200 Plymouth Bldg., Chicago.  
General Electric Co., Schenectady, N. Y.  
Johns-Manville, H. W., Co., New York.

# ST. LOUIS CAR CO. ST. LOUIS-MO.



## St. Louis Car Company's Semi-Convertible Type

The illustration represents one of the cars recently shipped by us to the Houston Electric Company, Houston, Texas.

These cars are of our own design—a practically perfect Semi-Convertible type. Both lower and upper sashes raise into the roof. They move easily and when in the roof pockets are securely fastened, with no possible danger of falling and injuring passengers.

### Our construction of the Semi-Convertible Car is the very best that has yet been devised

These Houston cars are 28' over corner posts and 31' 6" over all. Width over arm rail, 8' 6". They are finished with very handsomely figured mahogany, provided with curtains at each window and each door opening and have the St. Louis Car Company's latest improved "Walkover" seat.

The cars are mounted on St. Louis Car Company's No. 47 Short Wheel Base Truck, which has been adopted as standard in a great many of the larger cities. The channel-iron and steel construction of the "Robertson type" permits the arm rail of the car to be placed very low and adds much to the appearance.

*Photographs, Blue Prints and Specifications will be mailed upon request.*

## CLASSIFIED LIST OF ADVERTISERS—Continued.

- Fuses and Fuse Devices—Continued.**  
Western Electric Co., Chicago.  
Westinghouse Elec. & Manufacturing Co., Pittsburgh.
- Gaskets, Bronze.**  
Power Specialty Co., 111 Broadway, New York.
- Gates and Guards.**  
Kalamazoo Railway Supply Co., Kalamazoo, Mich.
- Gear Cases.**  
Electric Service Supplies Co., 200 Plymouth Bldg., Chicago.  
General Electric Co., Schenectady, N. Y.  
Marshall, R. W., & Co., 95 Liberty St., New York.
- Gears and Pinions.**  
Atha Steel Casting Co., Newark, N. J.  
Electric Service Supplies Co., 200 Plymouth Bldg., Chicago.  
General Electric Co., Schenectady, N. Y.  
Marshall, R. W., & Co., 95 Liberty St., New York.  
Nuttall, R. D., Co., Pittsburgh.  
Van Dorn & Dutton Co., Cleveland, O.
- Generators—(See Dynamos).**
- Gongs—(See Bells and Gongs).**
- Graphite Paint—(See Paint).**
- Grates, Chain.**  
Green Engineering Co., Com'l Nat. Bk. Bldg., Chicago.
- Grease—(See Lubricants).**
- Grinders.**  
Brown, H. P., 120 Liberty St., New York.
- Ground Connection Clamps.**  
Chase-Shawmut Co., Newburyport, Mass.
- Guy Anchors—(See Anchors).**
- Haps, Trolley—(See Trolley Poles and Fittings).**
- Headlights.**  
Electric Service Supplies Co., 200 Plymouth Bldg., Chicago.  
Fairbanks, Morse & Co., Chicago.  
General Electric Co., Schenectady, N. Y.  
St. Louis Car Co., St. Louis.  
Stuart-Howland Co., Boston.  
Trolley Supply Co., Canton, O.
- Heaters, Car, Electric.**  
Consolidated Car-Heating Co., New York, N. Y.  
Johns-Manville, H. W., Co., New York.
- Heaters, Car, Hot Water, and Stoves.**  
Baker, Wm. C., Heating & Sup. Co., New York.  
McGuire-Cummings Mfg. Co., Chicago.  
Smith, Peter, Heater Co., Detroit, Mich.
- Hoists—(See Cranes, Hoists and Lifts).**
- Hose Bridges.**  
Ohio Brass Co., Mansfield, O.
- Hydraulic Machinery.**  
Watson-Stillman Co., 26 Cortland St., New York.
- Inspection.**  
Central Inspection Bureau, 17 State St., New York.
- Inspection Cars, Gasoline.**  
Stover Motor Car Co., Freeport, Ill.
- Instruments, Measuring and Testing—(See Electrical Instruments).**
- Insulating Tapes.**  
General Electric Co., Schenectady, N. Y.  
Johns-Manville, H. W., Co., New York.  
Okonite Co., Ltd., 253 Broadway, New York.  
Western Electric Co., Chicago.
- Insulations and Insulating Material—Continued.**  
Craghead Engineering Co., Cincinnati, O.  
Electric Railway Equipment Co., Cincinnati, O.  
Electric Service Supplies Co., 200 Plymouth Bldg., Chicago.  
General Electric Co., Schenectady, N. Y.  
Johns-Manville, H. W., Co., New York.  
Macallen, The, Co., Boston.  
Ohio Brass Co., Mansfield, O.  
Okonite Co., Ltd., 253 Broadway, New York.  
Standard Paint Co., 100 William St., New York.  
Stuart-Howland Co., Boston.  
Western Electric Co., Chicago.
- Jacks.**  
American Car Co., St. Louis.  
Brill, J. G., Co., Philadelphia.  
Electric Service Supplies Co., 200 Plymouth Bldg., Chicago.  
Fairbanks, Morse & Co., Chicago.  
Kalamazoo Railway Supply Co., Kalamazoo, Mich.  
Kuhlman, G. C., Car Co., Cleveland.  
Marshall, R. W., & Co., 95 Liberty St., New York.  
Morden Frog & Crossing Co., Chicago.  
Stephenson, John, Co., Elizabeth, N. J.  
Wason Mfg. Co., Springfield, Mass.  
Watson-Stillman Co., 26 Cortland St., New York.
- Joints, Expansion—(See Steam Fittings).**
- Joints, Rail.**  
Rail Joint Co., 29 W. 34th St., New York.
- Journal Boxes.**  
American Car Co., St. Louis.  
Brill, J. G., Co., Philadelphia.  
Kuhlman, G. C., Car Co., Cleveland.  
McGuire-Cummings Mfg. Co., Chicago.  
St. Louis Car Co., St. Louis.  
Stephenson, John, Co., Elizabeth, N. J.  
Symington, T. H., Co., Baltimore, Md.  
Wason Mfg. Co., Springfield, Mass.
- Journal Lubricators—(See Lubricants).**
- Journal Packing, Steel Wool.**  
Robertson, Wm., & Co., Fifth Floor Great Northern Bldg., Chicago.
- Lamps, Arc and Incandescent.**  
Anderson, A. & J. M., Mfg. Co., Boston.  
Electric Service Supplies Co., 200 Plymouth Bldg., Chicago.  
General Electric Co., Schenectady, N. Y.  
Stuart-Howland Co., Boston.  
Western Electric Co., Chicago.  
Westinghouse Electric & Mfg. Co., Pittsburgh, Pa.
- Lamp Sockets.**  
Electric Service Supplies Co., 200 Plymouth Bldg., Chicago.  
General Electric Co., Schenectady, N. Y.  
Johns-Manville, H. W., Co., New York.
- Lantern Globes.**  
Railway Specialty & Supply Co., Chicago.
- Lifts—(See Cranes, Hoists and Lifts).**
- Lightning Arresters.**  
Electric Service Supplies Co., 200 Plymouth Bldg., Chicago.  
General Electric Co., Schenectady, N. Y.  
Stuart-Howland Co., Boston.  
Western Electric Co., Chicago.  
Westinghouse Elec. & Manufacturing Co., Pittsburgh.
- Line Material.**  
Anderson, A. & J. M., Mfg. Co., Boston.  
Craghead Engineering Co., Cincinnati, O.  
Johns-Manville, H. W., Co., New York.  
Electric Ry. Equipment Co., Cincinnati, O.  
Electric Service Supplies Co., 200 Plymouth Bldg., Chicago.
- Line Material—Continued.**  
General Electric Co., Schenectady, N. Y.  
Macedo, Co., Boston.  
Marshall, R. W., & Co., 95 Liberty St., New York.  
Stuart-Howland Co., Boston.  
Western Electric Co., Chicago.
- Lock and Nut Washers.**  
National Lock Washer Co., Newark, N. J.
- Lockers, Metal.**  
Electric Service Supplies Co., 200 Plymouth Bldg., Chicago.
- Locomotives.**  
Baldwin Locomotive Works, Philadelphia.
- Locomotives, Electric.**  
American Car Co., St. Louis.  
Baldwin Locomotive Works, Philadelphia.  
Brill, J. G., Co., Philadelphia.  
General Electric Co., Schenectady, N. Y.  
Kuhlman, G. C., Car Co., Cleveland.  
McGuire-Cummings Mfg. Co., Chicago.  
Stephenson, John, Co., Elizabeth, N. J.  
Wason Mfg. Co., Springfield, Mass.  
Westinghouse Elec. & Manufacturing Co., Pittsburgh.
- Locomotives, Gasoline.**  
Fairbanks, Morse & Co., Chicago.  
Stover Motor Car Co., Freeport, Ill.
- Lubricants.**  
Dearborn Drug & Chemical Works, Chicago.  
Galena-Signal Oil Co., Franklin, Pa.  
Whitmore Mfg. Co., Cleveland, O.
- Lumber.**  
Advance Lumber Co., Cleveland, O.  
Barnes, G. H., Hardwood Lumber Co., St. Louis, Mo.  
Beidler, Francis, & Co., Chicago.  
Berthold & Jennings, St. Louis.  
Lindsay Bros. Co., Spokane, Wash.  
S-E Missouri Cypress Co., Campbell, Mo.
- Malleable Iron.**  
St. Louis Car Co., St. Louis.
- Measuring Tapes.**  
Lufkin Rule Co., Saginaw, Mich.
- Meters.**  
Johns-Manville, H. W., Co., New York.  
Queen & Co., Philadelphia.  
Weston Electrical Instrument Co., Newark, N. J.
- Mica, Raw and Manufactured.**  
Chicago Mica Co., Valparaiso, Ind.
- Motor Cars, Gasoline.**  
Stover Motor Car Co., Freeport, Ill.
- Motors, Electric.**  
Fairbanks, Morse & Co., Chicago.  
General Electric Co., Schenectady, N. Y.  
National Brake & Electric Co., Milwaukee.  
Partridge, Arthur S., 425 Olive St., St. Louis, Mo.  
Western Electric Co., Chicago.  
Westinghouse Elec. & Manufacturing Co., Pittsburgh.
- Nut Locks.**  
Chase-Shawmut Co., Newburyport, Mass.  
National Lock Washer Co., Newark, N. J.  
Railway Specialty & Supply Co., Chicago.  
St. Louis Car Co., St. Louis.  
U. S. Metal & Mfg. Co., 25 Broad St., New York.
- Nuts and Bolts.**  
National Lock Washer Co., Newark, N. J.  
Railway Specialty & Supply Co., Chicago.
- Oilers.**  
Armstrong Oil Co., 31st and Chestnut St., Philadelphia.
- Oils—(See Lubricants).**
- Overhead Equipment—(See Electric Railway Supplies).**
- Packings.**  
Electric Service Supplies Co., 200 Plymouth Bldg., Chicago.  
Johns-Manville, H. W., Co., New York.  
Power Specialty Co., 111 Broadway, New York.
- Packing, Steel Wool Journal.**  
Robertson, Wm., & Co., Fifth Floor Great Northern Bldg., Chicago.
- Paints.**  
Standard Paint Co., 100 William St., New York.
- Pay-As-You-Enter Cars.**  
Pay-As-You-Enter Car Co., 26 Cortland St., New York.
- Pipe Bends and Fittings—(See Steam Fittings).**
- Poles, Metal.**  
Craghead Engineering Co., Cincinnati, O.  
Electric Railway Equipment Co., Cincinnati, O.  
Electric Service Supplies Co., 200 Plymouth Bldg., Chicago.
- Poles and Ties, Wood.**  
Advance Lumber Co., Cleveland, O.  
Barnes, G. H., Hardwood Lumber Co., St. Louis, Mo.  
Beidler, Francis, & Co., Chicago.  
Berthold & Jennings, St. Louis.  
Churchill Cedar Co., Spokane, Wash.  
Humbird Lumber Co., Sand Point, Idaho.  
Lindsay Bros. Co., Spokane, Wash.  
National Pole Co., Escanaba, Mich.  
Naugle Pole & Tie Co., 226 La Salle St., Chicago.  
Pacific Coast Pole Co., Spokane, Wash.  
S-E Missouri Cypress Co., Campbell, Mo.  
Worcester, C. H., Co., Tribune Bldg., Chicago.
- Punches—(See Ticket Punches).**
- Rail Benders.**  
Electric Service Supplies Co., 200 Plymouth Bldg., Chicago.  
Fairbanks, Morse & Co., Chicago.
- Rail Bonds—(See Bonds, Rail).**
- Rail Bonds, Flexible.**  
Chase-Shawmut Co., Newburyport, Mass.
- Rail Drills—(See Drills, Track).**
- Rail Feed Wire—(See Wire and Cables).**
- Rail Joints and Chairs—(See Joints, Rail).**
- Rails, New.**  
New York Switch & Crossing Co., Hoboken, N. J.  
Wharton, Wm., Jr., & Co., Philadelphia.
- Rails, Relaying.**  
Zelnicke, Walter A., Supply Co., St. Louis.
- Railway Velocipedes.**  
Fairbanks, Morse & Co., Chicago.  
Kalamazoo Railway Supply Co., Kalamazoo, Mich.
- Registers and Fittings—(See Fare Registers).**
- Relays.**  
Weston Electrical Instrument Co., Newark, N. J.
- Roofing.**  
Johns-Manville, H. W., Co., New York.
- Sand Apparatus.**  
American Car Co., St. Louis.  
Brill, J. G., Co., Philadelphia.  
Electric Service Supplies Co., 200 Plymouth Bldg., Chicago.

From the company's viewpoint  
the great value of

## Pay-As-You-Enter Cars

is in the fact that they increase revenue, increase the safety of operation, permit increased speed and promote adherence to schedules.

From the passenger's viewpoint their value is in much improved service, greater personal comfort and freedom from accidents incident to entering and leaving cars.



**Pay-As-You-Enter Cars** have proved to be the greatest improvement of modern times in street railway operation. They have been tried out under the most severe conditions in a number of widely differing cities—and have demonstrated that they are not experimental in any sense.

Companies having lines subject to congestion, and consequently upon which revenue is lost daily by reason of non-payment of fares, should write the undersigned for particulars regarding licenses to build and operate.

All patents are owned exclusively by

**The Pay-As-You-Enter Car Company**

DUNCAN McDONALD  
President

50 Church Street, New York

THOS. W. CASEY  
Manager

## CLASSIFIED LIST OF ADVERTISERS—Continued.

## Sand Apparatus—Continued.

Kuhlman, G. C., Car Co., Cleveland.  
Marshall, R. W., & Co., 95 Liberty St., New York.  
Ohio Brass Co., Mansfield, O.  
St. Louis Car Co., St. Louis.  
Stephenson, John, Co., Elizabeth, N. J.  
Wason Mfg. Co., Springfield, Mass.

## Sash Balances and Fixtures.

National Lock Washer Co., Newark, N. J.

## Sash Operating Devices.

Drouvé, G., Co., Bridgeport, Conn.  
Lord & Burnham, Irvington-on-Hudson, New York.

## Seats, Car—(See Car Seats).

## Shade Rollers—(See Curtains, Fixtures and Materials).

## Signals.

Telegraph Signal Co., Rochester, N. Y.

## Signal Supplies.

Railway Specialty & Supply Co., Chicago.

## Skylights.

Drouvé, G., Co., Bridgeport, Conn.  
Lord & Burnham, Irvington-on-Hudson, New York.

## Snow Plows, Sweepers and Scrapers.

American Car Co., St. Louis.  
Brill, J. G., Co., Philadelphia.  
Kalamazoo Railway Supply Co., Kalamazoo, Mich.  
Kuhlman, G. C., Car Co., Cleveland.  
McGuire-Cummings Mfg. Co., Chicago.  
Russell Car & Snow-Plow Co., Ridgeway, Pa.  
Stephenson, John, Co., Elizabeth, N. J.  
Wason Mfg. Co., Springfield, Mass.

## Sockets, Waterproof.

Johns-Manville, H. W., Co., New York.

## Solder Paste.

Chase-Shawmut Co., Newburyport, Mass.

## Springs.

American Car Co., St. Louis.  
Brill, J. G., Co., Philadelphia.  
Kuhlman, G. C., Car Co., Cleveland.  
McGuire-Cummings Mfg. Co., Chicago.  
Marshall, R. W., & Co., 95 Liberty St., New York.  
Railway Steel Spring Co., 71 Broadway, New York.  
St. Louis Car Co., St. Louis.  
Standard Steel Works Co., Philadelphia, Pa.  
Stephenson, John, Co., Elizabeth, N. J.  
Wason Mfg. Co., Springfield, Mass.

## Sprinkling Cars.

American Car Co., St. Louis.  
Brill, J. G., Co., Philadelphia.  
Kuhlman, G. C., Car Co., Cleveland.  
McGuire-Cummings Mfg. Co., Chicago.  
Stephenson, John, Co., Elizabeth, N. J.  
Wason Mfg. Co., Springfield, Mass.

## Stage Pockets and Plugs.

Chase-Shawmut Co., Newburyport, Mass.

## Steam Fittings, Etc.

Crane Co., Chicago.  
Davis, John, Co., Chicago.  
Simmons, John, Co., 110 Centre St., New York.  
Power Specialty Co., 111 Broadway, New York.

## Steel Cars.

American Car Co., St. Louis.  
Brill, J. G., Co., Philadelphia.  
Kuhlman, G. C., Car Co., Cleveland.  
St. Louis Car Co., St. Louis.  
Stephenson, John, Co., Elizabeth, N. J.  
Wason Mfg. Co., Springfield, Mass.

## Steel Tapes.

Lufkin Rule Co., Saginaw.

## Stokers.

Babcock & Wilcox Co., 85 Liberty St., New York.  
Green Engineering Co., Com'l Nat. Bk. Bldg., Chicago.  
Model Stoker Co., Dayton, O.  
Westinghouse Machine Co., Pittsburg.

## Superheaters.

Power Specialty Co., 111 Broadway, New York.

## Switches, Frogs and Crossings.

Barbour-Stockwell Co., Cambridgeport, Mass.  
Cleveland Frog & Crossing Co., Cleveland, O.  
Fairbanks, Morse & Co., Chicago.  
Mowbray Frog & Crossing Co., Rookery, Chicago.  
New York Switch & Crossing Co., Hoboken, N. J.  
Railway Specialty & Supply Co., Chicago.  
Wharton, Wm., Jr., & Co., Philadelphia.

## Switchboards and Switchboard Instruments.

Anderson, A. & J. M., Mfg. Co., Boston.  
Chase-Shawmut Co., Newburyport, Mass.  
General Electric Co., Schenectady, N. Y.  
Western Electric Co., Chicago.  
Westinghouse Electric & Mfg. Co., Pittsburg.  
Weston Electrical Instrument Co., Newark, N. J.

## Tapes and Webbing.

Johns-Manville, H. W., Co., New York.  
Okonite Co., Ltd., 253 Broadway, New York.

## Testing Instruments.

Queen & Co., Philadelphia.  
Weston Electrical Instrument Co., Newark, N. J.

## Test Lamps, Pocket.

Chase-Shawmut Co., Newburyport, Mass.

## Ticket Choppers and Destroyers.

Patton, Paul B., Salem, Mass.

## Ticket Punches.

Meyers, Fred J., Mfg. Co., Hamilton, O.  
Woodman Mfg. & Sup. Co., Boston.

## Ties and Poles, Wood—(See Poles and Ties).

## Timber.

Beidler, Francis, & Co., Chicago.  
Lindsay Bros. Co., Spokane, Wash.  
S-E. Missouri Cypress Co., Campbell, Mo.

## Track Cleaners and Scrapers.

American Car Co., St. Louis.  
Brill, J. G., Co., Philadelphia.  
Kalamazoo Railway Supply Co., Kalamazoo, Mich.

## Track Cleaners and Scrapers—Continued.

Kuhlman, G. C., Car Co., Cleveland.  
McGuire-Cummings Mfg. Co., Chicago.  
Marshall, R. W., & Co., 95 Liberty St., New York.  
Ohio Brass Co., Mansfield, O.  
Stephenson, John, Co., Elizabeth, N. J.  
Van Dorn & Dutton Co., Cleveland, O.  
Wason Mfg. Co., Springfield, Mass.

## Track Drills—(See Drills, Track).

## Tracklaying Machinery.

Holman, D. F., Ry. Tracklayer Co., 1102 Ellsworth Bldg., Chicago.

## Track Tools.

Electric Service Supplies Co., 200 Plymouth Bldg., Chicago.  
Kalamazoo Railway Supply Co., Kalamazoo, Mich.

## Trimmings, Car.

American Car Co., St. Louis.  
Brill, J. G., Co., Philadelphia.  
Curtain Supply Co., Park Row Bldg., New York.  
Kuhlman, G. C., Car Co., Cleveland.  
National Lock Washer Co., Newark, N. J.  
St. Louis Car Co., St. Louis.  
Stephenson, John, Co., Elizabeth, N. J.  
Wason Mfg. Co., Springfield, Mass.

## Trolley Guards.

Automatic Trolley Guard Co., 391 Elliott Sq., Buffalo, N. Y.  
Electric Service Supplies Co., 200 Plymouth Bldg., Chicago.

## Trolley Poles and Fittings.

Garford Company, Elyria, O.  
General Electric Co., Schenectady, N. Y.  
Johns-Manville, H. W., Co., New York.  
Humphrey Trolley & Mfg. Co., 125 Chamber of Commerce Bldg., Detroit, Mich.  
Marshall, R. W., & Co., 95 Liberty St., New York.  
Milley Electric Co., Bucyrus, O.  
Nuttall, R. D., Co., Pittsburg.  
Star Brass Works, Kalamazoo, Mich.  
Trolley Supply Co., Canton, O.  
Westinghouse Electric & Mfg. Co., Pittsburg, Pa.

## Trolley Retrievers and Catchers.

Electric Service Supplies Co., 200 Plymouth Bldg., Chicago.  
Milroy Electric Co., Bucyrus, O.  
Trolley Supply Co., Canton, O.

## Trolley Wagons.

Kalamazoo Railway Supply Co., Kalamazoo, Mich.

## Trolley Wheels—(See Trolley Poles and Fittings).

## Trolley Wire—(See Wire and Cables).

## Trucks, Car.

American Car Co., St. Louis.  
Baldwin Locomotive Works, Philadelphia.  
Brill, J. G., Co., Philadelphia.  
Kuhlman, G. C., Car Co., Cleveland.  
McGuire-Cummings Mfg. Co., Chicago.  
St. Louis Car Co., St. Louis.  
Standard Motor Truck Co., Pittsburg, Pa.  
Stephenson, John, Co., Elizabeth, N. J.  
Van Dorn & Dutton Co., Cleveland, O.

## Trucks, Car—Continued.

Wason Mfg. Co., Springfield, Mass.

## Turbines.

General Electric Co., Schenectady, N. Y.  
Westinghouse Machine Co., Pittsburg, Pa.

## Valves—(See Steam Fittings).

## Varnish.

Electric Service Supplies Co., 200 Plymouth Bldg., Chicago.  
Standard Paint Co., 100 William St., New York.

## Ventilators.

Drouvé, G., Co., Bridgeport, Conn.  
Lord & Burnham, Irvington-on-Hudson, N. Y.

## Vestettes.

Bellamy Vestlette Mfg. Co., Cleveland, O.

## Waste, Cotton and Wool.

Hazy, J. Milton, Waste Wks., Philadelphia, Pa.  
Railway Specialty & Supply Co., Chicago.

## Water Softening Compounds.

Dearborn Drug & Chemical Works, Chicago.

## Wheels and Axles.

American Car Co., St. Louis.  
Brill, J. G., Co., Philadelphia.  
Griffin Wheel Co., Chicago.  
Kuhlman, G. C., Car Co., Cleveland.  
McGuire-Cummings Mfg. Co., Chicago.

Marshall, R. W., & Co., 95 Liberty St., New York.

Railway Steel-Spring Co., New York.

St. Louis Car Co., St. Louis.

St. Louis Car Wheel Co., St. Louis.

Standard Steel Works Co., Philadelphia, Pa.

Stephenson, John, Co., Elizabeth, N. J.

Wason Mfg. Co., Springfield, Mass.

## Wheel Grinders.

Wheel Truing Brake Shoe Co., Detroit, Mich.

## Window Fixtures.

Drouvé, G., Co., Bridgeport, Conn.

## Wiping Rags.

Hazy, J. Milton, Waste Wks., Philadelphia, Pa.

## Wire, Aluminum.

Aluminum Co. of America, Pittsburg, Pa.

## Wire, Insulated.

Aluminum Co. of America, Pittsburg, Pa.  
American Electrical Works, Providence, R. I.

General Electric Co., Schenectady, N. Y.

Okonite Co., Ltd., 253 Broadway, New York.

Standard Underground Cable Co., Pittsburg, Pa.

Stuart-Howland Co., Boston.

## Wire and Cables.

Aluminum Co. of America, Pittsburg, Pa.  
American Electrical Works, Providence, R. I.

Bridgeport Brass Co., Bridgeport, Conn.

General Electric Co., Schenectady, N. Y.

Okonite Co., Ltd., 253 Broadway, New York.

Standard Underground Cable Co., Pittsburg, Pa.

**ANY** on Railway and Allied Subjects  
**BOOK** now in print sent prepaid upon receipt of price by  
THE WILSON CO., 160 HARRISON STREET CHICAGO

**STANDARD HIGH-SPEED "INTERBOROUGH" DOUBLE TRUCK**

TYPE C-60

**"Solid Forged"**

WITHOUT WELDS

FRAMES ARE MADE FROM ROLLED OPEN-HEARTH STEEL WITHOUT WELDS. ALL WEARING BOLTS ARE TURNED AND CASE HARDENED, AND WEARING HOLES STEEL THIMBLED. M. C. B. STANDARD PRINCIPLES ARE FOLLOWED. WE ARE PREPARED TO BUILD TRUCKS IN ACCORDANCE WITH PURCHASER'S DESIGNS AND SPECIFICATIONS.

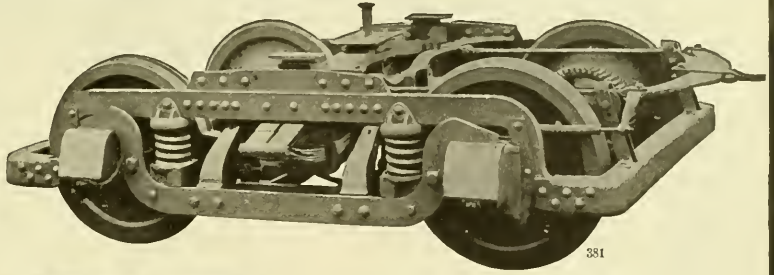

381

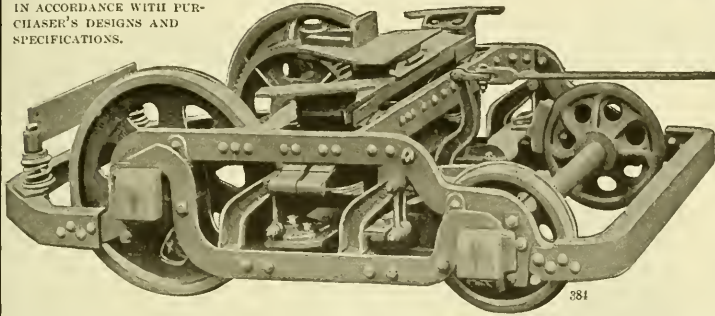

384

**STANDARD "MAXIMUM TRACTION" DOUBLE TRUCK**

CITY AND SUBURBAN TYPE O-45

OVER TWO HUNDRED OF THESE "MAXIMUM TRACTION" TRUCKS ARE IN SERVICE IN BROOKLYN, NEW YORK, AND ARE PRONOUNCED "HIGHLY SATISFACTORY."

**STANDARD MOTOR TRUCK COMPANY, FRICK BUILDING, PITTSBURGH, PENNSYLVANIA**  
 NEW YORK OFFICE: 170 BROADWAY WORKS: NEW CASTLE, PA. CHICAGO OFFICE: FISHER BUILDING

**THE BABCOCK & WILCOX COMPANY**

85 Liberty Street, New York

Babcock & Wilcox — Stirling — A & T Horizontal — Cahall Vertical

**WATER TUBE STEAM BOILERS**

STEAM SUPERHEATERS

Works: Bayonne, N. J. Barberton, Ohio.

MECHANICAL STOKERS

BRANCH OFFICES:

BOSTON, Delta Bldg.  
 PHILADELPHIA, 110-112 North American Bldg.  
 SAN FRANCISCO, 63 First Street  
 PITTSBURGH, Farmers Deposit Nat. Bank Bldg.  
 NEW ORLEANS, 343 Beronne St.

DENVER, 410 Seventeenth St.  
 SALT LAKE CITY, 313 Atlas Block  
 WASHINGTON, Colorado Building  
 CHICAGO, Marquette Bldg.  
 ATLANTA, GA., 1132 Candler Bldg.

CLEVELAND, 706 New England Bldg.  
 MEXICO CITY, 7 Avenida, Juarez  
 HAVANA, CUBA, 116 1/2 Calle de la Habana  
 LOS ANGELES, 321 First Bldg.  
 CINCINNATI, O., Traction Bldg.

**In Buying Waste It is Important to Know—**

- FIRST—That it is free from dirt and grit.
- SECOND—That it is easy to pack.
- THIRD—That it is made up of all long strands.
- FOURTH—That it will absorb the oil in a manner insuring a free and even lubrication.

*Hagy Waste meets specific conditions and ordinary ones*

**The J. Milton Hagy Waste Works**  
 433 Spruce Street Philadelphia

**ALUMINUM**

**Railway Feeders**

And all kinds of **Electrical Conductors**

Aluminum Feeders are less than one-half the weight of copper feeders and are of equal conductivity and strength. If insulated wire or cable is required, high grade insulation is guaranteed.

*Write for prices and full information.*

**Aluminum Company of America**  
 PITTSBURGH, PA.

Formerly The Pittsburgh Reduction Company



Factory of The Milloy Electric Company  
Bucyrus, Ohio

## The Milloy Trolley Base

built in our new and specially equipped factory, insures a quality which will give excellent service under ordinary and extraordinary conditions.

The Milloy Base is unusually low, has even tension on high or low wire. Has no fulcrum, no friction, no oil, no center post. Always efficient. Particulars on request.

**THE MILLOY ELECTRIC COMPANY**  
Bucyrus, Ohio

## Hydraulic Jacks

Plain, Base, Claw, Low, Wrecking, Outside Pump, Double Piston Pump, Vreeland, Independent Pump, Pulling, Vertical, Horizontal and Reversed. 400 types and sizes; 2 tons to 1,000 tons. Each one thoroughly guaranteed.

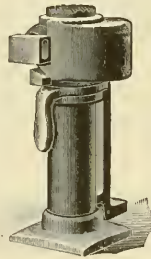

Send for Jack Catalogue.

**THE WATSON-STILLMAN CO.**  
50 Church Street, New York City  
Branch Office: 453 The Rookery, Chicago, Ill.

## Gasoline Motor Cars for Street Car Service

Can be used advantageously for owl car service and on branch lines of large railroads where the passenger traffic does not warrant the maintenance of a regular train schedule.

Address R. R. Dept. No. 757 MS.

**Fairbanks, Morse & Co.**  
CHICAGO, ILLINOIS



## Black Air-Drying Varnish

—for quick repairs to dynamos and motors, air-cooled transformer coils, magnet coils, underframe work of cars, etc. Invaluable in the shop where baking facilities are not available. It forms a tough, elastic, odorless coating, is easily applied with a brush, and withstands overheating, water, snow and sleet.

We have an interesting booklet for you.

**The Standard Paint Co.** 100 William Street  
NEW YORK N.Y.  
Chicago St. Louis Kansas City Boston Philadelphia New Orleans

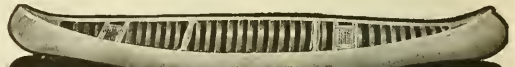

## Best grade cedar canoe for \$20

Best grade of Cedar Canoe for \$20.00. We sell direct, saving you \$20.00 on a canoe. All canoes cedar and copper fastened. We make all sizes and styles, also power canoes. Write for free catalog and log prices with retailers' profit cut out. We are the largest manufacturers of canoes in the world. DETROIT BOAT COMPANY, 266 Bellevue Avenue, Detroit, Mich.

## VALVES—FITTINGS—STEAM SPECIALTIES

**CRANE CO.**  
CHICAGO  
ESTABLISHED 1855

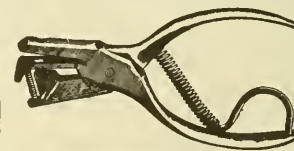

The Fred. J. Meyers  
Mfg. Co. Hamilton, O.

Largest Manufacturers in the World of  
**TICKET and CONDUCTORS' PUNCHES**

Send for catalog of 75 different styles of punches with 1000 different dies. Write for special prices.



## This Punch

is made in more than 500 different die designs.

For description and prices, write

**R. WOODMAN MFG. & SUPPLY CO.** 2  
63 Oliver St., Boston, Mass., U. S. A.



## PATTEN TICKET DESTROYER



Don't burn your used tickets. Destroy them, and avoid fraud. Remember, it is difficult to get a man to destroy anything of value to him.

Sell the old stock—it will soon pay for machine. In use on the Boston & Northern R. R., Old Colony St. Ry. Co., Brockton St. Ry. Co., Waterbury Rl. Co., Bridgeport Traction Co., Buffalo Ry. and others. Write for circular.

**PAUL B. PATTEN**  
78 Lafayette Street - SALEM, MASS., U. S. A.

## Send Us Your Book List

We publish a number of standard works on railway and allied subjects, both electric and steam. We sell all that are in print. Write us.

**The Wilson Company** 160 Harrison Street  
CHICAGO



Have You Sent for Your Sample of

# Steel Wool Journal Packing

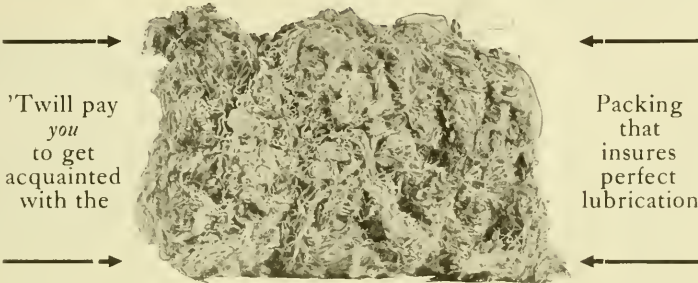

→  
←  
←  
→

'Twill pay  
*you*  
to get  
acquainted  
with the

←  
→  
→  
←

Packing  
that  
insures  
perfect  
lubrication

A two-cent stamp and a minute will bring enough to enable you to decide whether these claims are true

- 
- Steel Wool** → saves one-half the packing  
**Journal** → saves one-third the oil  
**Packing** → saves labor and wear  
 → prevents hot boxes **positively.**
- 

You can never know what real economy in journal packing is until you get in touch with

## William Robertson & Co.

General Office: Fifth Floor Great Northern Bldg., Chicago  
 Factory: 75 South Jefferson Street, Battle Creek, Mich.

→ Drop us a line now--while you think of it ←

**THE ARNOLD COMPANY**  
 ENGINEERS—CONSTRUCTORS  
 ELECTRICAL—CIVIL—MECHANICAL  
 101 LA SALLE STREET  
 CHICAGO

**A. L. REGISTER & CO.**  
 Engineers and General Contractors—Electric Railways  
 112 North Broad St. PHILADELPHIA, PA. Established 1889

**SHIMER & CHASE CO.**  
 Experienced Promoters of Electrical Railway Projects  
 Correspondence Solicited OMAHA, NEB.

**CENTRAL INSPECTION BUREAU**  
 Inspection of Rails, Ties, Cars, Motors, Bridges, Buildings, Etc.  
 17 STATE STREET - - - - NEW YORK CITY

**LINE MATERIAL**  
 ELECTRIC SUPPLIES FOR RAILWAYS, POWER PLANTS, ETC.  
 THE CREAGHEAD ENGINEERING CO., 346 Main Street, Cincinnati, Ohio

**THE CURTAIN SUPPLY CO.**  
 CAR CURTAINS  
 CHICAGO, 85-93 Ohio Street Hudson Terminal, 50 Church St., NEW YORK

**HARTSHORN'S SPRING SHADE ROLLERS**  
 Used the World Over Wherever Cars are Run  
 STEWART HARTSHORN CO.  
 EAST NEWARK, N. J.



**AUTOMATIC TROLLEY GUARD CO.**  
 61-69 Carroll St., Buffalo, N. Y. 3  
 "IT PUTS THE WHEEL ON THE WIRE"

**HOT WATER HEATERS FOR CARS**  
 THE PETER SMITH HEATER COMPANY, Detroit, Mich.

**ELECTRIC HEATERS** For All Classes of Cars  
 New York Consolidated Car-Heating Co. Chicago

**HART CONVERTIBLE BALLAST, GONDOLA AND CONSTRUCTION CAR**  
 RODGER BALLAST CAR CO., Railway Exchange, CHICAGO

**BRAKESHOOES**  
 STANDARD BRAKESHOE COMPANY  
 GEN'L OFFICES & WORKS—AURORA, ILL.—CHICAGO OFFICE 315 1/2 EICH.

**WHEEL TRUING BRAKE SHOES**  
 Repair Crippled Wheels While Running  
 THE WHEEL TRUING BRAKE SHOE CO., Detroit, Mich.

**GRIFFIN WHEEL CO.**  
 CHICAGO  
 CHILLED IRON CAR WHEELS IRON OR STEEL AXLES

**HEINE SAFETY BOILER CO.**  
 421 OLIVE STREET, ST. LOUIS, MO.  
 Manufacturers of WATER TUBE BOILERS

WRITE TO **MODEL STOKER COMPANY** DAYTON OHIO  
 for detailed information about the best  
**AUTOMATIC SMOKELESS FURNACE**

**SPRINGS—TIRES—STEEL-TIRED WHEELS**  
**RAILWAY STEEL-SPRING CO.**  
 General Offices: Cortlandt Bldg., 30 Church St., New York

**H. M. Bylesby & Company**  
 Incorporated  
 ENGINEERS  
 American Trust Bldg., Chicago

Design, Construct and Operate  
 Railway, Light, Power and  
 Hydraulic Plants EXAMINATIONS AND  
 REPORTS

**J. G. WHITE & COMPANY**  
 INCORPORATED  
**Engineers, Contractors**  
 43-49 Exchange Place, New York, N. Y.  
 41-43 Wall Street  
 Principal Philippine Office: Manila, P. I.

**Ford, Bacon & Davis,**  
 Engineers,  
 115 BROADWAY,  
 NEW YORK.

**COLUMBIA CONSTRUCTION CO.**  
 BUILDERS OF  
**Electric Railways**  
 Colby and Abbot Building : MILWAUKEE, WIS.

**Surface, Jet and Barometric Condensers**  
**Edwards Air Pumps Centrifugal Pumps**  
**Water Cooling Towers**  
 Wheeler Condenser & Engineering Company  
 CARTERET, N. J.  
 90 West Street, NEW YORK Monadnock Block, CHICAGO, ILL.

**GREEN TRAVELING LINK GRATES**  
 Highest Capacity  
 Highest Efficiency  
 Automatic Smokeless  
 Labor Saving Cheap Fuel

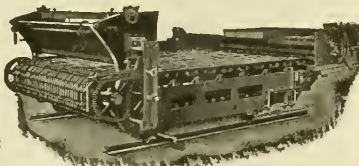

**GREEN ENGINEERING CO.**  
 Main Office: Commercial National Bank Bldg., Chicago, Ill.  
 BRANCH OFFICES: Pittsburgh : St. Louis : St. Paul : Louisville  
 General Foundry Work a Specialty



Taylor's Falls Power House and Dam.

## Water Power

This power house and dam on the St. Croix River, Wisconsin, develops 12,000 H. P. for use in the City of Minneapolis, Minn., about forty miles distant. The concrete dam is 750 feet long, 50 feet high and 40 feet wide at the base. This whole development was designed by us and built under the supervision of our engineers and construction corps. We are prepared to design and construct similar water power developments and power stations, either new work or extensions.

Our service begins with the making of preliminary reports and estimates and ends when we turn over the finished plant, completely equipped, ready for operation. We provide for and supervise every detail.

By our form of contract—cost plus a fixed sum, or cost plus a percentage—we become our client's agent, guarding and promoting his interest at every stage.

*If you have water power work in prospect, write us for Terre Haute Booklet.*

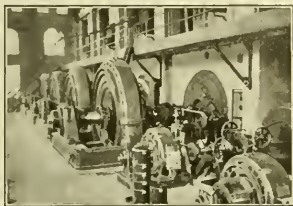

Interior of Power House.

**Stone & Webster Engineering Corporation**  
**Constructing Engineers :: 147 Milk St., BOSTON, MASS.**

We are prepared to design and construct water power developments, power stations, industrial buildings, railways, electrical transmission lines and distributing systems, either new work or extensions. Correspondence invited.

# Brown Hoist Electric Locomotive

**CRANES DO VALUABLE SERVICE IN LIFTING AROUND POWER STATIONS AND CAR HOUSES**

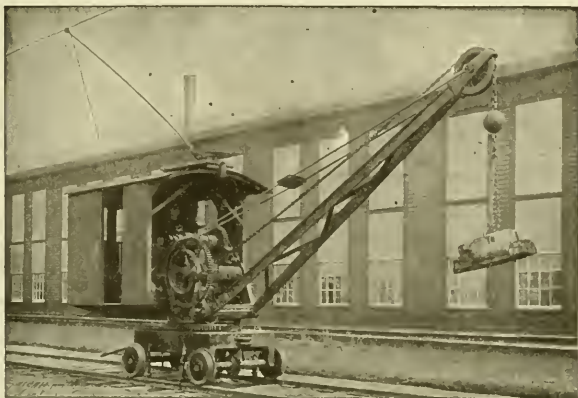

EVERY SORT OF HOISTING APPARATUS IS SHOWN IN OUR CATALOGUE

## THE BROWN HOISTING MACHINERY CO.

HAVEMEYER BLDG., NEW YORK

CLEVELAND, OHIO

FRICK BLDG., PITTSBURG, PA.

## Baldwin Locomotive Works

BURNHAM, WILLIAMS & CO., PHILADELPHIA, PA., U. S. A.



Builders of  
**LOCOMOTIVES**  
of every description  
including  
**ELECTRIC  
LOCOMOTIVES**

**ELECTRIC TRUCKS**

## Standard Steel Works Co.

HARRISON BLDG., PHILA., PA., U. S. A.

New York, N. Y. Cleveland, O. St. Louis, Mo. Denver, Colo.  
Portland, Ore. Richmond, Va. Chicago, Ill. St. Paul, Minn.  
San Francisco, Cal. Seattle, Wash. Winnipeg, Can.

**Solid Forged**

**Rolled and Steel Tired Wheels**

Mounted on axles fitted with Motor Gears  
for Electric Railway Service.

**LOCOMOTIVE TIRES  
FORGINGS**

**RAILWAY SPRINGS  
CASTINGS**



**OKONITE FEEDER WIRES FOR POWER TRANSMISSION.**

Whether overhead, underground or submarine, success-fully meet the most exacting conditions of modern traction systems. Used by the most prominent Street Railways in the country

**The Standard for Rubber Insulation**  
Samples and Estimates on application

**THE OKONITE CO. Ltd., 253 Broadway, NEW YORK**  
GEORGE T. MANSON, Gen'l Supt.; W. H. HODGINS, Secretary.

WILLARD L. CANDEE, H. DURANT CHEEVER, Managers

 <b>CONTINUOUS JOINT</b>	<p>Over <b>25,000</b> miles in use</p>	 <b>WEBER JOINT</b>	<p>Rolled from <b>Best Quality</b> Steel</p>	 <b>WOLHAUPTER JOINT</b>	<p><b>Catalogs at Agencies</b> Baltimore, Md. Portland, Ore. Boston, Mass. Seattle, Wash. Chicago, Ill. St. Paul, Minn. Denver, Colo. St. Louis, Mo. Pittsburg, Pa. Troy, N. Y. London, Eng. Montreal, Can.</p> <p>HIGHEST AWARDS—Paris, 1900; Buffalo, 1901; St. Louis, 1904</p>
-----------------------------	--	------------------------	--	-----------------------------	---

Additional safety and economy in **Track Maintenance** has been proved by the use of Continuous, Weber and Wolhaupter base-supported rail joints—after ten (10) years' service, having a record of over **25,000 miles** in use—the extent of which is evidence of their excellence.

**THE RAIL JOINT COMPANY**  
General Offices: **29 West 34th Street, New York City**  
Makers of Rail Joints for Standard and Special Rail Sections, also Girder, Step or Compromise, and Insulating Rail Joints, protected by patents in United States and Foreign Countries.

# Special Work for Street Railways

<p>Switches Mates Frogs</p>	 Cast Weld Compromise Rail	<p>and Crossings with Hard Steel Centers</p>
-------------------------------------	-------------------------------	--

**Barbour - Stockwell Co., 205 Broadway, Cambridgeport, Mass.**

# WHARTON SPECIAL TRACK WORK

OF EVERY DESCRIPTION  
FOR ALL CLASSES OF SERVICE

**MANGANESE  
STEEL  
TRACK WORK  
IS OUR SPECIALTY**

**WM. WHARTON JR. & CO.  
INCORPORATED.**  
PHILADELPHIA, PA. JENKINTOWN, PA.

# FOR SALE. FOR QUICK DELIVERY

## 6 55-ft. Passenger, Baggage and Smoking Car Bodies

Main Compartment 26' 0"  
 Smoking " 10' 6"  
 Baggage " 10' 0"  
 Seating Capacity, 54

## 8 60-ft. Passenger, Baggage and Smoking Car Bodies

Main Compartment 28' 6"  
 Smoking " 11' 0"  
 Baggage " 8' 0"  
 Seating Capacity, 58

## 5 52-ft. Passenger and Smoking Car Bodies — Double End

Seating Capacity, 60

## 3 52-ft. Passenger and Baggage Car Bodies — Double End

Seating Capacity, 56

## 2 50-ft. Express Car Bodies

*Write or wire us for further information.*

# The Jewett Car Co. Newark Ohio

**THE MIGHTY MIDGET**

## HOT WATER CAR HEATER

Adapted for Large Electric Cars and Long Distance Lines. Exclusively used on Largest Electric Systems. Ask for Catalog

**THE WILLIAM C. BAKER HEATING & SUPPLY CO.,** 143 LIBERTY STREET NEW YORK



## NILES CARS — THE ELECTRIC PULLMANS

LARGE, FAST INTERURBANS  
 OUR SPECIALTY

## NILES CAR & MFG. COMPANY

WORKS: NILES, OHIO

Sales Office:  
 J. A. HANNA Co., 312 Electric Bldg., Cleveland, O.

# Steel Passenger Cars and Trucks

For Steam and Electric Railways

Steel and Composite Freight Cars for all Classes of Service

# Pressed Steel Car Co.

NEW YORK, PITTSBURGH, CHICAGO, ST. LOUIS, ATLANTA, MEXICO CITY, BUENOS AIRES, SYDNEY, N.S.W.

**CAR ADVERTISING**  
*Barron & Collier*  
**ALMOST EVERYWHERE**  
*Flat Iron Building, New York.*

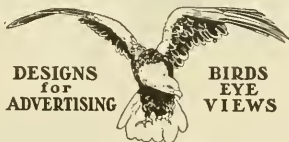

DESIGNS  
for  
ADVERTISING

BIRDS  
EYE  
VIEWS

**HALF TONES**  
 Photographing Machinery  
 & Retouching. ART PRINTING  
**WOODBURY CARLTON & CO.**  
 WORCESTER, MASS.



THE  
**Bellamy Vestlette**

For Street Railway Conductors

**ABSOLUTELY SAFE. Money cannot be lost or stolen from these pockets OVER 150,000 IN USE**

Saves the price of a coat yearly. Conductor's uniform always presentable. Adopted as a part of the uniform by over 200 Street Railway Companies. Price \$2.00, sent to any address prepaid, where we have no agent. Agents wanted on every line.

The Bellamy Vestlette Mfg. Co., Cleveland, O. and A. F. JURY, 265 Yonge St., Toronto, Canada

Patented April 27, 1897

*Pantasote*

The National Standard for Car Curtains and Car Upholstery.

**AGOSOTE HEADLINING**

The only headlining made in one solid piece. Will not separate, warp or blister. Waterproof and homogeneous.

**THE PANTASOTE COMPANY**

707 Fisher Building, Chicago, Ill.

11 Broadway, New York

**WAKEFIELD CAR SEATS**

We make everything necessary to seat a car of any description. Our line includes Reversible seats of both the Slideover and Turnover types for Steam and Electric service, as well as the only practical Double Revolving seat on the market.

Our Longitudinal Spring Seating is unexcelled for superiority of workmanship and durability.

We also carry a large variety of Rattan Chairs for Parlor and Observation Cars.



**Heywood Brothers & Wakefield Company**

New York, N. Y.

Wakefield, Mass.

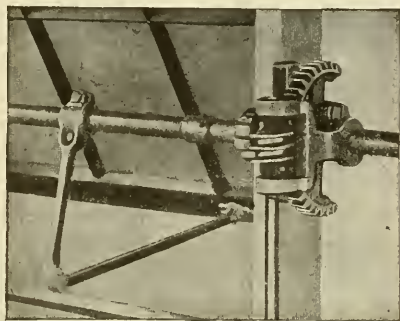

**The Ventilation**

of your Shops, Foundries and Car Barns is made especially effective by a speedy, positive and easily manipulated **Sash Operating Apparatus** which automatically locks the sash at any position.

Let us send you our catalogue.

**Lord & Burnham Company**  
 Irvington-on-Hudson, N. Y.

**WHEN** a salesman calls on you for the purpose of selling you material or supplies, you expect him to show you how and why it is to your advantage to use his goods.

Is there any reason why you should not use as much care in pointing out to your patrons, or those who should be your patrons, the attractions and advantages of your road and your service as does the successful salesman in presenting the strong points of his goods?

The **Van Valkenburgh Advertising Service** applies the methods of the successful salesman in calling the attention of the public to your commodity—transportation.

Let's get together.



**E. C. Van Valkenburgh**  
**Promotional Advertising**  
**for Electric Railways**  
 2117 West 102d Street, Chicago

# U.S. Metal & Mfg. Co.

City Investing Building, 165 Broadway, New York  
Pittsburg, 1509 Arrott Bldg. Chicago, 414 Railway Exchange

## Perfect <sup>Pressed Steel</sup> Car Replacer



Size No. 2. For Interurban and Electric Railroads

Weight, 55 pounds per set. Will fit any size rail from 5 inches down.

3

# RAIL BOND Maintenance.

The SEMI-PLASTIC PLUG RAIL BOND is applied on either Girder or T Rail without disturbing the pavement or removing the angle plates.

The condition of the Bond can be determined by a track walker from its appearance.

Its conductivity is 900,000 c. m., which can be maintained at a trifling expense without removing Bond.

Cheaper in first cost than No. 4/o copper bond and more easily applied.

*Write for details.*

**HAROLD P. BROWN,**  
120 Liberty Street, New York, N. Y.

THE  
**Van Dorn & Dutton Co.**  
CLEVELAND, OHIO  
MANUFACTURERS OF  
**GEARS AND PINIONS**

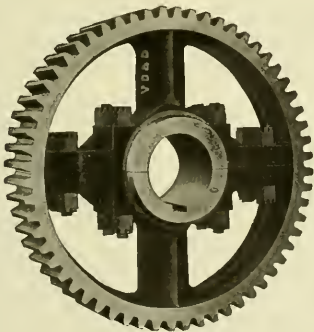

For All Types of Motors

HIGHEST QUALITY

# RE-ENFORCED SPOKE WHEELS

For City and Suburban Cars

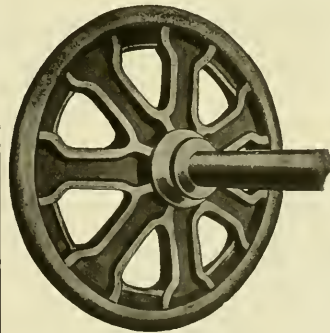

This wheel is being substituted in place of the Old Style Plate Wheel because it does not rumble and roar when on paved city streets.

The only spoke wheel for Heavy High Speed Service.

Stronger Spokes  
Stronger Flange  
Deep, Even Chill  
Greater Mileage  
Absolute Safety

A Sample Order Will Prove Its Superiority Over the Old Style Spoke Wheel

WRITE FOR BOOKLET ON WHEELS

**ST. LOUIS CAR WHEEL CO.**  
ST. LOUIS, MO.

# CLASSIFIED ADVERTISEMENTS

Undisplayed advertisements are inserted under this heading at the uniform rate of one cent a word; minimum charge twenty-five cents. Replies directed to this office will be forwarded when required to any address in the United States, Canada or Mexico without extra charge. Advertisements received at the Chicago office by 9 a. m. Thursday will appear in the issue for the same week.

## POSITIONS WANTED.

Wanted—Position as armature winder and mechanic. Ten years' experience. Can furnish good reference. Address "No. 556," care of Electric Railway Review, Chicago.

Expert street car electrician, city or interurban lines, desires a change. Fifteen years' experience; capable handling men; also railway park manager. Now with a large railway. Address "No. 578," care of Electric Railway Review, Chicago.

Transportation man of seventeen years' experience, young, reliable and thoroughly familiar with organization, dispatching and timetable work, desires a position as superintendent or one of equal responsibility. Highest references regarding character, ability and past service. Address replies to "No. 577," care Electric Railway Review, Chicago.

Position wanted with a proposed interurban electric road by a man with eight years' experience in the preliminary work. Can take complete charge of the engineering work, procuring right of way, franchises, stock selling; and also knows the conditions which must exist before a road can be successfully financed. Address "No. 584," care of Electric Railway Review, Chicago.

Position wanted as auditor and accountant. Sixteen years of steam, electric and general experience; good working knowledge of details of general contracting business; clever buyer; possess ability to organize. Can furnish first-class reference as to character and ability and work accomplished in past, leaving present work because closed; at liberty to accept position any time. Address "No. 576," care of Electric Railway Review, Chicago.

## POSITIONS WANTED.

Wanted—Middle-aged man with 26 years' experience in railway operation and supplies and equipment wants to represent good firms in the southwest, with headquarters at Oklahoma City. (By permission refers to Electric Railway Review.) Address "No. 581," care of Electric Railway Review, Chicago.

An experienced supply salesman, who also has had thirteen years' operating experience on city lines, desires to form connection with a railway supply house handling either electric or steam supplies or both. Would consider proposition to open sales agency. Address "No. 566," care of Electric Railway Review, Chicago.

Wanted—To correspond with company needing the services of high-class general manager or general superintendent. Electrical and civil engineer; 17 years' experience with large properties and in construction and operation. Address "No. 568," care of Electric Railway Review, Chicago.

Wanted—Position as superintendent of rolling stock or master mechanic on city or interurban railway. Have satisfactorily handled similar work on large metropolitan properties since horse car days. At liberty now; references exceptional. Address "No. 580," care of Electric Railway Review, Chicago.

Experienced electrical engineer wants position with manufacturing concern or with company operating electric railways. Graduate Purdue University, 1906. Will go anywhere for permanent position. Age 26; married; A No. 1 references as to habits and ability. Address "No. 570," care of Electric Railway Review, Chicago.

## POSITIONS WANTED.

Detective, three years' experience. Both ends. Do you expect a strike? If you do I can make you a good proposition. Address "No. 587," care of Electric Railway Review, Chicago.

## MISCELLANEOUS WANTS.

Want to buy second-hand equipment, machinery or material? A card inserted in the Electric Railway Review, stating just what you want, will bring immediate response. The cost is small—only \$1.20 an inch (measuring 1 inch deep by 1 1/2 inches wide) per insertion. Send orders to Electric Railway Review, 160 Harrison St., Chicago.

What have you to sell in the way of second-hand equipment, machinery or material? Buyers read the "For Sale" cards on the following page and there is the place to tell your story. "For Sale" cards are inexpensive—only \$1.20 an inch (measuring 1 inch deep by 1 1/2 inches wide) per insertion. Special rates on contracts for 100 inches or more to be used within one year. Now is the time to send your order to Electric Railway Review, 160 Harrison St., Chicago.

## BOOKS AND PUBLICATIONS.

Wanted—Copies of the Street Railway Review of April, 1900, May, 1901, and August, 1902. State price and condition. Address "No. 558," care of Electric Railway Review, Chicago.

Wanted—Copies of Street Railway Review, January to June, 1906, inclusive, and one copy each January and February, 1906. Also Electric Railway Review for January 5, 1907. State condition and price. Address "No. 582," care of Electric Railway Review, Chicago.

## BUSINESS OPPORTUNITIES.

Wanted—Man with some capital and a knowledge of railway track supplies to join the advertiser—a salesman handling locomotive and car supplies—in a general railway supply business. Address "No. 568," care of Electric Railway Review, Chicago.

Recharging Dry Batteries, the only book ever published giving complete directions of how to prepare chemicals for renewing dry batteries. If you are not more than pleased with this book, your dime back. Large electrical catalogue and book postpaid, 10 cents. Adams Electric Co., Dept. E. R., Kewanee, Ill.

## BOOKS AND PUBLICATIONS.

We want your friends to read the Electric Railway Review. You will do them—and us—a favor by sending their addresses. We will gladly mail free sample copies. Electric Railway Review, 160 Harrison Street, Chicago.

Interstate commerce national legislation to July 1, 1906, is fully covered in our reference pamphlet. It contains the full text of the act to regulate commerce as amended, including the Elkins and Hepburn acts, and of the supplementary act relating to the testimony of witnesses before the interstate commerce commission. It also contains the texts of the expedition act, the anti-trust act of 1906, the employers' liability act and the safety equipment laws. Difference in type shows the parts expunged from, and the parts added to, the interstate commerce and Elkins acts by the Hepburn act. This pamphlet is of special value to railway men and lawyers. Mailed prepaid for 25 cents in stamps or coin. Special prices for quantities. The Wilson Company, 160 Harrison St., Chicago.

**R. W. MARSHALL & CO.**  
50 Church St., New York  
Second-Hand Machinery and Equipment  
**ELECTRIC RAILWAY MATERIALS**

Rare Bargains in  
**RAILS AND EQUIPMENT**  
WALTER **ZELNICKER** SUPPLY CO.  
A. In ST. LOUIS  
DO YOU RECEIVE OUR STOCK LIST?

The Russell Combination Electric Car and Snow-Plow.  
Remove the noses of your Russell electric combination car and snow-plow and you have an electric locomotive, freight, baggage or express car in one. One investment buys two pieces of equipment. Write us. **RUSSELL CAR & SNOW-PLOW CO.**, Ridgeway, Pa. **Wendell & MacDuffie**, New York; C. A. Ratson, Chicago  
**IS USEFUL ALL THE YEAR ROUND**

**Rowboat #20<sup>00</sup>**  
20 Different Designs  
Can ship immediately in any quantity. Need No Boat House, No Leak, Crack or Rot. Every boat has water tight compartment, so cannot sink. Write for FREE Illustrated Catalog and Special Prices.  
**MICHIGAN STEEL BOAT COMPANY**, 266 Bellevue Avenue, Detroit, Mich.

**ECLIPSE Life Guard**  
Manufactured by the  
**ECLIPSE RAILWAY SUPPLY CO.**  
Cleveland, Ohio

**FOR SALE: Three Car Bodies and Three Pairs of Double Trucks**  
with or without electric equipment and air brakes; all new and never used. Compelled to sell, as these cars will not operate over a leased line by reason of their width and length.  
**R. W. MARSHALL & CO.**, 50 Church St., New York, N. Y.

**HELP** of any kind is easily and quickly secured by advertising in the Electric Railway Review. One cent a word per insertion.



# Dearborn Water Purifying Reagents

Increase the efficiency and the years of service of steam boilers by keeping them in good condition internally. Gallon sample of the water required for analysis before preparing treatment.

## Dearborn Drug & Chemical Works

ROBT. F. CARR, PRESIDENT

299 BROADWAY, NEW YORK      POSTAL TELEGRAPH BLDG., CHICAGO



Electric Hoists  
Overhead Tracks

### NORTHERN CRANES

Coal and Ash Handling Cranes

Locomotive or Car Pillar Cranes for Coaling, Wrecking, etc. Steam or Electric. Hand and Electric Traveling Cranes.

**NORTHERN ENGINEERING WORKS, DETROIT, MICH.**

# Mica Prices Reduced

Compare our prices on Raw Mica and Manufactured Mica with prices you have been paying our competitors

**WHY PAY FANCY PRICES?**

*We do not intend to change or increase our list prices. We do not follow our competitors.*

Chicago Mica Co.      Valparaiso, Ind.

## The SIGNAL SYSTEM

that prevents accidents, facilitates traffic and promotes adherence to schedules

is made by the



**Telegraph Signal Co.**  
82 State St., Rochester, N. Y.

## Queen Testing Sets

*"The Recognized Standard"*

Voltmeters  
Ammeters  
Switchboard and Portable  
Alternating and Direct Current



Queen Acme Testing Set

U. S. Standard Testing Sets  
Rail Bond Testers  
Galvanometers, etc., etc.  
Electrical Instruments for All Purposes

**QUEEN & CO., Inc., Philadelphia, Pa.**

# PIPE FITTINGS AND VALVES

FOR THE HEATING AND PLUMBING TRADE

TRADE  MARK

## JOHN SIMMONS CO.

104-110 Centre Street, NEW YORK



WE NOW MAKE 75% OF THE TROLLEY WHEELS  
WE WANT TO MAKE THE OTHER 25%

THE STAR BRASS WORKS  
KALAMAZOO, MICH.

## "Not an Experiment"

The Providence Fender is the Children's Fender. It is equally as effective in saving a child, and the person who has stumbled, as it is in saving those who are on their feet.

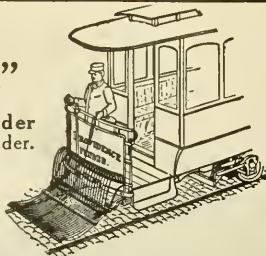

### CONSOLIDATED CAR FENDER COMPANY

Office and Factory: PROVIDENCE, R. I.  
Branch Office: 110 E. Twenty-third St., New York  
European Agents: Comptoire d'Electricite, 6, Rue Boudreau, Paris, France

# NATIONAL

Curtain Fixtures  
Sash Locks Sash Balances  
and Nut Locks

COMPLETE CURTAINS

## The National Lock Washer Co.

NEWARK, N. J.  
CHICAGO OFFICE: 419 Monadnock Block

THE RAILWAY SPECIALTY  
AND SUPPLY CO.

## SMITH NUTS

Great Northern Building  
CHICAGO

# FOSTER SUPERHEATERS

INSURE ECONOMICAL STEAM CONSUMPTION ON LIGHT ROADS

POWER SPECIALTY COMPANY  
111 Broadway, New York

## POLES and PILING

20,000 35s and 40s, Ready to Ship at Once  
S-E. MISSOURI CYPRESS CO., CAMPBELL, MO.

## Poles and Ties

A Selected Stock in Chicago for Rush Shipment  
A Number of Large Yards in the North  
**NAUGLE POLE & TIE CO.**  
CHICAGO OFFICE: 226 LA SALLE STREET

## Red Cedar Poles White

Prompt deliveries at right prices.

**NATIONAL POLE COMPANY**  
EVERETT, WASH. ESCANABA, MICH.

## Idaho Cedar Poles

PACIFIC COAST POLE CO.

SPOKANE, WASH.

## C. H. WORCESTER CO. CEDAR POLES

PRODUCERS AND WHOLESALERS

Suite 1710 Tribune Building

CHICAGO

## TRACKLAYING BY MACHINERY

SIMPLE, RAPID AND ECONOMICAL

D. F. HOLMAN RAILWAY TRACKLAYER CO., 1102 Ellsworth Bldg., Chicago

## G. H. BARNES HARDWOOD LUMBER CO.

Office and Yard: Main and Wash Sts., ST. LOUIS, MO.

Ties, Car Oak, Poplar, Ash, Cherry, Plain and Quartered Oak

We are Producers and Wholesale Dealers in Western

## CEDAR POLES

Yards in Washington, Idaho, Montana  
and British Columbia  
WRITE US FOR DELIVERED PRICES

**CHURCHILL CEDAR CO.**, Box 1409, Spokane, Wash.

## Send Us Your Book List

We publish a number of standard works on rail-  
way and allied subjects, both electric and steam.  
We sell all that are in print. Write us.

**The Wilson Company** 160 Harrison Street  
CHICAGO

# The Lindsley Brothers Company

Producers and Shippers of

and Manufacturers of

## WESTERN CEDAR POLES

## RED FIR CROSS ARMS

Eastern Sales Office, Monadnock Bldg., CHICAGO

SPOKANE, WASHINGTON

# Electric Railway Lubrication

THE same skillful expert supervision given in this service as in steam railway service has produced most satisfactory results. Lower cost of lubrication with better service.

We are under contract with many of the largest Street and Interurban railways in the country.

We guarantee cost per thousand miles in Street and Electric Railway Service when conditions warrant it.

Including both  
Rolling Stock  
and Power House  
Equipment

Write for further particulars.

Galena-Signal Oil Company  
FRANKLIN, PENNSYLVANIA

# TUBULAR POLES IRON OR STEEL



FOR  
ELECTRIC  
RAILWAYS  
ELECTRIC  
LIGHTING CO'S  
SIGNAL  
TELEPHONE } SERVICE  
TELEGRAPH } VICE  
TRANSMISSION  
L I N E S  
AND  
CATENARY  
SUSPENSION  
L I N E S

ELECTRIC RAILWAY EQUIPMENT CO.  
General Office: CINCINNATI-O-U-S-A  
Shops: READING PA - WHEELING WVA

# STOP THIEF!

That is what our  
NEW BOND GUARD DOES



## Why Not Try Some

WHERE YOU HAVE TROUBLE  
WITH THEFT OF BONDS?  
*At Least Send for Literature*

CHASE-SHAWMUT CO.  
Newburyport, Mass.

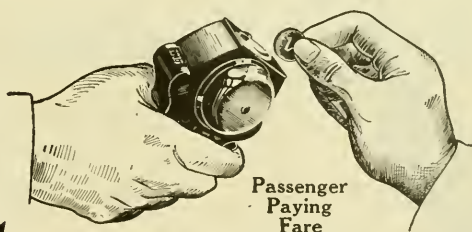

## Yes! It is safe to use the Rooke Automatic Fare Collector

because it is accurate,  
reliable and non-tamperable

Any attempt made to interfere with its  
mechanism breaks a seal and affords indisputable  
evidence of the attempt.

Rooke Automatic Register Co.  
Providence, Rhode Island

# ROLLING DOORS

In Steel, Wood or Bronze

FOR CAR BARNs, FREIGHT SHEDS, ETC.

Made by the

## JAS. G. WILSON MFG. CO.

New York Office: 3 W. 29th Street

ESTABLISHED 1876

Incorporated 1903

# WESTON Electrical Instrument Co.

Main Office and Works:  
WAVERLY PARK, NEWARK, N. J.



Illuminated  
Dial Station  
Instruments

SEND FOR NEW CATALOGUE

Berlin—European Weston Electrical Instrument Co., Ritterstrasse, No. 88  
Paris, France—E. H. Cadot, 12 Rue St. Georges  
London—Andrey House, Ely Place, Holborn  
New York Office—74 Cortlandt St.  
Model 11



# SHELBY STREET RAILWAY LAMPS

Filaments double anchored. They stand the knocks and bumps of street railway service. Deliver 50% more light below. We can reduce your lamp bills. Let us tell you about our special lamp for sign and park use. It's a current saver

## THE SHELBY ELECTRIC CO., SHELBY, OHIO

OFFICES IN ALL PRINCIPAL CITIES

# Peacock Brakes

are standard on more than  
half of all electric railways in  
the United States and Canada

Now think what it means to have a greater number of roads using Peacock Brakes than are using all other makes combined. It means that Peacock Brakes are better in every way—superior in design and construction, and consequently in results.

*Ask for interesting booklet.*

## National Brake Co.

888 Ellicott Square  
BUFFALO, N. Y.

# Electric Railway Review

PUBLISHED EVERY SATURDAY BY THE WILSON COMPANY, CHICAGO

Entered as second-class matter January 5, 1907, at the postoffice at Chicago, Ill., under the act of March 3, 1879.

CHICAGO: 160 Harrison Street  
NEW YORK: 50 Church Street  
CLEVELAND: 1529 Williamson Bldg.

Vol. XIX  
No. 19

CHICAGO, MAY 9, 1908

Whole No.  
263

Subscription: Domestic, \$2.00  
Foreign, 5.00  
Canada, 3.50

There are many instances which demonstrate that an intelligent board of railway commissioners is of great value to the roads operating under its jurisdiction. This statement is confirmed by a recent example in Massachusetts. Some time ago the legislature demanded an inquiry with a view to the issuing of an order which would compel

electric railways to carry on their cars lifting jacks and possibly tackle, so that after an accident a body might be removed before the arrival of an emergency crew. The Massachusetts board now points out that this scheme is not feasible. It states that nothing that has come to its attention in the way of information convinces it that any type of lifting jack now available would serve the intended purpose if placed in the sole charge of a car crew. Only the assistance of trained emergency men with their blocking, chains and ropes would make safe the raising of a car body or trucks. Otherwise would a living human being under a street car he would be subject to hazardous attempts by inexperienced men to lift the car, which would more than likely result in his receiving additional injuries. Also those handling the jacks, unless experienced, and bystanders, who would naturally be drawn to the scene of the accident, might be injured by the slipping of the jacks or the overturning of the car body. As the result of its inquiry the board has stated that it considers the safety of the traveling public paramount to any consideration of economy, and while this board has been authorized to recommend the equipment of all cars with jacks if it deemed this plan best, yet it feels that more satisfactory results can be obtained by the present method of stationing trained emergency crews with their necessary equipment at suitable points along the routes.

In the preservative treatments of timbers and ties for railway and electric railway work creosote is so important a factor that

**Grading of Creosotes.** It seems strange that more is not generally known of the value of its various chemical constituents. Creosote under present practice is made to conform to certain liberal specifications formulated after the ideas of the engineer or manager prescribing them and usually having no better foundation than an individual opinion influenced by a possible single practical test with creosote said to have the analysis specified. The result is that we find a large number of sets of specification extant which are widely different in essential features. It is true that creosotes intended for one purpose may not be suitable for another purpose allowing a different degree of exposure or a different volatilization, but there seems to have been no especial consideration given to these conditions in the specifications referred to. The forest service of the United States department of agriculture has conducted a series of tests upon creosotes and recommends for practical purposes two methods of analysis. Creosote is divided into four grades, dependent upon distillation, the index of refraction and other factors, and the uses to which each grade is applicable are prescribed. While these uses indicated probably will not prove entirely in accord with the developments of practice there is undoubtedly much of unusual value in the report. It should serve to effect the abandonment of the

practice of adopting or using haphazard specifications or of buying all creosotes upon the same basis. Certainly enough money is being expended annually upon creosotes to warrant the giving of most careful consideration to the values of its different properties and consequently to the return upon the money invested.

It has been difficult for the average engineer or railway official to keep in touch with the many new processes of timber treatment which have been developed in the past decade in which the necessity for timber preservation began to be fully appreciated. A review of the more important of these processes and a brief description of the methods and materials used is given in a paper by Eugene P. Schoch of the University of Texas before the Southwestern Electrical and Gas Association at El Paso, Tex., May 7, 8 and 9, which is abstracted in this issue of the Electric Railway Review. By considering the item of cost for each kind of treatment he presents figures which will enable one to form a correct idea of the relative merits of the several processes considered from a practical point of view. The cause of decay, the value of seasoning, the action of the preservative agents and the method of application or injection are also outlined. It is singular that very few articles have been written which treat of the broader subject of wood preservation in its details, although many have been published describing separate processes. The problem has now been narrowed down to five or six methods of treatment, such as the Burnett process, the Wellhouse process, straight creosote, zinc chloride, zinc tannin and creosote-zinc chloride. These have proved satisfactory when properly applied and when used in climates to which they are best suited.

The all-prevailing desire for greater economies in current generation has brought about the present widespread study of internal combustion engines. There are gas engines which are said to have been operating satisfactorily under the severe electric railway service for a number of years, and yet many power station engines are just now being convinced of their future. With the increasing scarcity of coal there must follow prime movers which can utilize other fuels or operate with less coal per unit of output. The gas engine seems to fulfill this latter requirement and the problem now confronting its designer is to increase its reliability of operation. The character of the gas fed to an engine has largely to do with its smoothness of operation. In this issue W. B. Tuttle, vice-president and general manager of the San Antonio Gas & Electric Company, presents an especially thorough discussion of one phase of the gas engine fuel problem. He describes the various types of gas producer plants, compares their methods of operation and exhibits test data with which to substantiate his statements. A statement in his conclusion is worth repeating: "The reliability of the service of gas engines operating on producer gas has been established, but in this connection it is well to call attention to the fact that all gas engines require

**Watch the Gas Engine.**

greater care on the part of the operators than do steam engines. \* \* \* While careful attention should be given to a steam plant it must be given to a gas engine plant."

#### EXTRA CHARGE FOR TRANSFERS IN PHILADELPHIA.

Announcement that the transfer system of the Philadelphia Rapid Transit Company will be radically changed denotes action that is consistent with the recent curtailment of transfers between the lines of the New York City Railway and the Third Avenue Railroad of New York. In two of the leading cities of the country important steps have now been taken to prevent abuse and overcome the unprofitable effect of too general acceptance of overliberal transfer privileges. The attention of managers has been upon the leaks attending transfer systems for a long while, and the crystallization of opinion into action in New York and Philadelphia affords precedents which other companies may follow with wisdom.

In discussing the transfer system which has prevailed in Greater New York, J. F. Calderwood, third vice-president and general manager of the Brooklyn Rapid Transit Company, stated in an interview, which was republished in the Electric Railway Review of April 11, 1908, page 461, that "the number of transfers issued by \* \* \* the traction companies of the larger cities \* \* \* has increased to an alarming degree." It frequently requires courage to deal with a situation of this character when it is possible that the announcement of a change will bring criticism and perhaps political abuse and injustice upon a public service corporation. The directors of the Philadelphia Rapid Transit Company, however, have determined to attempt to solve the transfer problem in their city. Liberal extension of the transfer privilege in Philadelphia has continued, as in many other places, with development of properties and public insistence upon longer rides for one fare. Directors of this company have evidently been obliged to consider plans for increasing the gross and net revenue. Under the new contract between the Philadelphia Rapid Transit Company and the city of Philadelphia, entered into on July 1, 1907, it was provided that present rates of fare might be changed only with the consent of both parties to the contract. With this clause of the contract in mind certain directors suggested unofficially some months ago that a revision of fares be made in order to raise the revenues of the company to a point commensurate with the larger cost of operation. The suggestion, though only tentative, met with so much opposition that formal or further consideration of any change was abandoned. A special committee of directors was appointed to study the subject of abuse of transfers and the present action of the board is based upon the conclusion of this committee that the only certain method of stopping abuses would be to require the passenger to pay something more for a ride with a transfer than for a trip without transfer, and to issue transfers upon request at the time of payment of fare only. This committee consisted of John B. Parsons, president of the company; J. J. Sullivan, W. H. Shelmardine, Clarence Wolf and Mayor Reyburn, the latter being ex officio a member of the board.

Pursuant to the recommendation of this special committee the directors met on Monday of the present week and passed an order providing that on and after May 18 a free transfer ticket would be issued only upon the payment of a 5-cent fare and only when a passenger requested a transfer at the time of paying the fare.

As the contract with the city contains no reference whatever to the issuance or regulation of transfers the company is not hampered by municipal interference in its reform. The company has long suffered from serious abuse of the transfer privilege, and previous efforts to remedy the abuse and to regulate the use of transfers have been ineffectual. The plan of giving the transfers to passengers as they alighted from cars was tried, but after experiment the conclusion was

reached that this system would not yield the desired results. It was found that transfers were sold by conductors in some cases and that boys and keepers of small stores disposed of large numbers of transfers. Under the new plan the company will discontinue the practice which it has followed in the past of giving transfers for tickets costing an average of 4 or 4½ cents each.

The use of transfers in many large cities has undoubtedly reached a point where it involves not only waste but great loss to the transportation corporation. The situation respecting transfers should be investigated carefully by every large company. With operating expenses as high as they are at present and with slight prospect of a reduction in expense it is necessary that the public should bear its proportion of the added cost met by the company in furnishing service. Curtailment of the transfer system will aid in raising net revenues to levels where they will permit proper returns on the investment.

#### THE EXPANSION OF SHOP EQUIPMENT.

As business develops on a small or medium sized electric road it becomes something of a problem to know how to fit the shop equipment to the situation. Labor-saving devices are helpful on large roads as well as small, but as the number of cars to be maintained increases the need of specialized tools becomes more pressing if repairs are to be handled quickly. A company which has to maintain only a dozen or two cars naturally cannot as a rule afford many refinements in its shop facilities, and in such cases the use of home-made "rigs" and "kinks" pays a heavy interest on their cost. When the total volume of repair work to be handled reaches a point where the time required to place the work in the tool is important, then it is well to consider whether or not a standard machine tool built to perform certain operations in a positive and continuous way will not be efficient enough to warrant its purchase.

From the standpoint of the mechanical engineer interested in shop production in a broad way the average small electric railway repair shop depends too much upon makeshift methods. Such a man feels that the tendency of the shop is away from these methods as the demand for its work extends. The practical street railway master mechanic, on the other hand, finds in the home-made device a chance to save in the first cost of shop equipment, and when the apparatus is set up ready for the work it usually is the case that the job can be done with as much economy as with the more expensive tool bought in the machinery market. The fact is, however, that as the road grows and more cars are handled in the shops, if one or two tools are depended upon for a variety of operations, there is apt to be more or less delay in the work, for the demand upon the individual tool tends to become too large for it to handle.

Each road must decide for itself when the conditions require the expansion of its shop equipment, but in facing this question it is interesting to consider what are the essential tools of a street railway shop from the point of view of the machine shop expert who is studying the general problem of production rather than the administration of repairs on a road of limited means. Such a man will probably say that the indispensable tools for a good machine repair shop are a car wheel lathe, grinder, axle lathe, engine lathe, milling machine, planer, drills, grinders, bolt cutters and forges. To these may be added, as the company can afford them, a punching and shearing machine, power hammer, pipe cutting and threading machine, power hack saw, boring mill, radial drill, turret lathe and shaper. There is still a chance in many small shops for the more extensive use of small cranes and hoists and many shops are not yet equipped with enough woodworking tools.

Such a list as this looks rather extensive for the average

small road, and yet we venture to say that as shop practice becomes more and more settled in its methods on a road and as the conditions approach those of the factory in parts of the repairs undertaken, the above list will not seem too large for economical service. The repair of electric railway rolling stock is never likely to become a sequence of production processes in regular order, such as may be found in the ordinary manufacturing plant, but as the quantity of work to be carried on grows larger it will pay the operation company to extend its tool list rather than to depend too much upon substitute methods. The time element is the important factor in the cost of car repairs on all systems, but it is felt more in the shop as the total number of cars repaired increases.

ANNUAL REPORTS.

United Railways Investment Company.

The United Railways Investment Company of New York, a holding corporation which controls the United Railroads of San Francisco and the Philadelphia Company of Pittsburgh, has made its report for 1907. The figures, with a comparison with the previous year, make the following showing:

	1907.	1906.	Increase.
Gross income .....	\$1,560,864	\$1,334,222	\$226,642
Expenses .....	67,639	28,897	38,742
Balance .....	\$1,493,225	\$1,305,325	\$187,900
Charges .....	1,090,591	582,710	508,481
Net income .....	\$ 402,634	\$ 723,215	*\$320,581

\*Decrease.

The principal source of income was the dividends received and accrued on stocks owned, which amounted last year to \$1,457,772, as compared with dividends received of \$1,295,398 in the preceding year. The larger charges resulted mainly from the greater amount of bonds outstanding and an increase in bills payable. The amount of loans and bills payable on December 31, 1907, was \$2,061,488, while the balance sheet of one year before showed \$1,000,000 notes payable. Current assets amounted at the close of 1907 to \$1,782,323, and current liabilities to \$2,443,804, an excess of liabilities of \$661,481.

The amount of collateral trust 5 per cent bonds outstanding at the end of last year was \$18,150,000, as compared with \$15,750,000 at the conclusion of 1906. The preferred and common stock issues were unchanged at \$15,000,000 and \$19,400,000, respectively. Preferred stock dividend certificates aggregated \$1,462,500, as compared with \$1,087,500 at the end of 1906.

In his remarks to shareholders Ernst Thalmann, the president, says:

No dividends in cash or scrip were paid during 1907 by the United Railroads of San Francisco, all its receipts over and above fixed charges and expenses, and all the surplus earnings of the Philadelphia Company, above the amount of dividends paid by it, having been retained by the respective companies for their respective corporate purposes.

The most salient feature in the financial history of your company was the strike on the lines of the United Railroads of San Francisco. At the date of presentation of the last annual report your directors firmly hoped that some arrangement, fair and just, both to the employes and to the company itself, would be amicably reached, their hope being founded on the facts that the United Railroads of San Francisco had fulfilled the requirements of the decision of the arbitrators fixing a rate of wages for the period terminating May 1, 1907, and that the officers of the United Railroads were prepared to meet the demands of the employes in a reasonable and conciliatory spirit. These reasonable expectations were not fulfilled, and a strike on the part of practically all of the employes of the United Railroads began on May 5, 1907, and lasted approximately six months. The lines of the United Railroads were subjected to a persistent and continuous boycott. Furthermore, the employes were exposed to repeated attacks, and their lives for the greater portion of that period were constantly in danger. Through the efficient manage-

ment of the officers, involving a complete disregard of all considerations of their own personal safety, the result of the strike was never for a moment in doubt, and though it resulted in a large immediate loss, it is the belief of your board that the ultimate outcome will be beneficial to the city of San Francisco and to your company.

Naturally, the earnings of that company during this period fell to an extremely low figure, but they have recently regained their former level. The earnings for March, 1908, were \$558,932, while those for March, 1907, were \$537,700. This comparison furnishes reasonable ground for encouragement as to the future. The consensus of reports received from those familiar with existing conditions in San Francisco justifies a firm belief that the future prosperity of that city is assured, and in that future prosperity there is every reason to believe the United Railroads of San Francisco will fully participate.

The losses sustained by the United Railroads of San Francisco through the strike, as well as the financial requirements of that company, among other things, rendered it both impracticable and inadvisable to issue the \$3,000,000 of 3-year notes of this company and to carry into effect the contemplated plan with respect thereto. A substitute arrangement has been carried into effect since the last fiscal year, which in the opinion of the board will result beneficially, to your company as well as to the United Railroads. Your company subscribed to the remaining \$3,500,000 (par value) of cumulative first preferred stock of the United Railroads, and made the shares of such first preferred stock owned by this company, including the shares to be issued to it under such subscription, the basis for \$3,500,000 of 6 per cent notes of this company. The United Railroads of San Francisco is to apply the proceeds of the subscription to the stock toward the payment of its floating indebtedness.

Mr. Thalmann adds that the proceeds of the stock extinguish practically all of items aggregating \$1,469,427, upon which the Investment company had a contingent liability on December 31, 1907.

Washington Railway & Electric Company.

The report of the Washington (D. C.) Railway & Electric Company for 1907 shows, as compared with the results of 1906, increases of 8.06 per cent in gross earnings, 8.41 per cent in operating expenses and 7.69 per cent in net earnings. Miscellaneous income was slightly reduced, but the addition to fixed charges was less than the increases in the items of gross or net revenue from operation, and the surplus available for distribution to shareholders showed a gain of 9.26 per cent. Operations of the last three years compare as follows:

	1907.	1906.	1905.
Gross earnings .....	\$3,385,748.58	\$3,133,240.52	\$2,905,907.35
Operating expenses ...	1,748,752.58	1,613,096.71	1,478,466.55
Net earnings .....	\$1,636,996.00	\$1,520,143.81	\$1,427,440.80
Miscellaneous income ..	42,353.18	44,595.59	50,553.47
Gross income .....	\$1,679,349.18	\$1,564,739.40	\$1,477,994.27
Taxes .....	170,029.09	157,682.29	149,156.79
Interest .....	937,199.34	883,436.12	850,298.57
Total charges .....	\$1,107,228.43	\$1,041,118.41	\$ 999,455.36
Net divisible income...	572,120.75	523,620.99	478,538.91
Dividends .....	425,000.00	425,000.00	425,000.00
Surplus .....	\$ 147,120.75	\$ 98,620.99	\$ 53,538.91

The percentage of gross earnings required for operating expenses in the last year was 51.66 as compared with 51.49 per cent in 1906 and 50.86 per cent in 1905. Totals of the operating expenses are given, but no division of the expenditures as between maintenance and the cost of conducting transportation is shown. The report states, however, that the cost of maintenance increased last year \$98,822 or 26.12 per cent. From this it may be computed that the total expenditure during the year for maintenance was about \$477,122 or about 27.3 per cent of the total operating expense or about 14.1 per cent of the total gross earnings from operation. Allan L. McDermott, the president, states that the slight increase in the operating ratio is due to a continued increased expenditure for maintenance. He adds that the increase in cost of mainte-

nance "is partly due to the continuation of the policy of your management of endeavoring to maintain your properties each year in better condition than heretofore and, as in the previous year, to the increasing cost of materials which enter into the construction and operation of such properties."

Charges to capital account during the year amounted to \$1,146,005, of which \$914,175 was for account of the Potomac Electric Power Company and \$102,293 represented the discount on securities issued by the Washington Railway & Electric Company and the Potomac Electric Power Company and sold for construction purposes.

Credits to capital account during the year aggregated \$91,526. Underlying liens amounting to \$912,881 were retired and obligations of a total of \$2,073,250 were issued.

The total funded debt on December 31, 1907, was \$13,073,709 and there were outstanding \$8,500,000 preferred stock and \$6,500,000 common stock. The cost of property stood on the balance sheet at \$27,871,483.

## Communications

### CLASSIFICATION—ESSENTIAL CHARACTERISTIC OF SIMPLICITY IS LACKING.

To the Editors:

A review of the tentative classification as prepared by the interstate commerce commission indicates that it has taken electric railways as similar in organization, operating conditions and characteristics to the steam railroad companies. This is not the fact, as any one who is at all familiar with the organization and operation of these two common carriers knows, and as has been shown in a number of articles published in this and other technical journals on the subject. The action of the interstate commerce commission in submitting a tentative classification of operating expenses for electric railways with the steam road classification as a basis, crudely modified to meet some electric railway conditions, is not easily understood, especially when the commission has at hand the best thought on the subject of classification of accounts for electric railway properties, represented in the "Classification" committee of the American Street and Interurban Railway Accountants' Association.

In preparing a classification of accounts to apply to all the electric railways having organizations, characteristics and conditions of operation—many of these conditions being imposed by ordinances of municipalities in which they operate—varied to the extent that there are hardly two electric railway properties that operate under the same conditions, and in view of the fact that a large percentage of electric railways is operated in connection with electric lighting and often with gas and electric light and water plants, it is absolutely necessary that the classification which would be uniform on all properties must have simplicity as its most prominent characteristic, should provide only for the least number of accounts that would indicate the essential features of maintenance and operation and allow as many subdivisions as any property, however large, may wish to make, being applicable at the same time to the smaller companies without subdivision.

There are three purposes to be covered in a uniform classification of accounts:

First—It should be designed to show operating and departmental costs of value to the individual road, which must be done in order that the road may be operated economically.

Second—To form a basis of comparison between the operation of different electric railway properties, not only for the railway companies themselves but for the public at large.

Third—For general statistical purposes.

That the tentative classification as prepared by the inter-

state commerce commission does not contain the essential characteristic to make it of value as a uniform classification, namely, simplicity, is patent to every one. Even though the accounts as outlined in this classification could be made to apply to electric railway properties, which is not the case, it is deficient as a uniform classification because of the many proportionate charges necessary to follow out its provisions and the various joint facility accounts, the numerous adjustment and clearing accounts making operation under this classification a most complex problem and producing, as the classification certainly would, a mass of figures intended to represent maintenance and operating costs, which would simply be a compilation of guesses for every company operating under the classification; none of the three purposes for which a uniform classification should be designed would be accomplished.

Some of the provisions of the interstate commerce commission tentative classification, especially that of separating a service rendered by an outside company, or maybe an individual, into what represents cost of manufacture to the outside company or individual and what represents a return on the capital invested are absurd. The most striking example of this is in account No. 79, "purchased power." The text indicates that "power purchased" must be divided as between cost of manufacture and use of capital, the cost of manufacture being charged to operating expenses and the expense which represents use of capital to the income account. Therefore, if a railway company purchased power from an electric power company, which many do at a certain price per kilowatt-hour of consumption, the electric power company must inform the railway company what it costs to manufacture the power so purchased and what represents a return to the power company on the capital invested in its plant. It is not likely that an electric power company will tell its customer (the railway company) what it costs to manufacture the power, and if figures were given as to cost of manufacture they would probably be entirely unreliable for obvious reasons. If this principle were followed out in its entirety it might be carried back to the mines where the coal used by the electric power company is mined, to get first cost or what represented cost to the mining company mining the coal and what represented a return on the capital invested in the mines. One would have just as much reason to expect the coal mining company to give this information to a purchaser of coal as to expect an electric power company to give a statement showing the detailed costs to a customer who purchases power.

The division of electric railway companies into two classes, one to use a classification consisting of 22 accounts and the other or larger companies to use a classification consisting of 116 primary accounts, is another feature of this interstate commerce commission tentative classification that makes it valueless as a uniform classification. By dividing the electric railway lines into two classes the commission practically destroys the value of the classification for statistical as well as for comparative purposes. With one class of electric railway properties using 116 primary accounts and another class using only 22 accounts the statistics of the entire industry cannot be tabulated consistently. The best that could be done for statistical purposes would be to condense the operating expenses of the companies using the 116 accounts into the 22 accounts used by the smaller companies.

The operating expenses of the smaller companies using the 22 accounts could not be distributed over the 116 accounts as kept by the larger companies and therefore the data obtained from the companies using the 116 accounts would be of no practical benefit. The same criticism applies when it comes to a comparison of operating costs as between a company using 22 accounts and one using 116 accounts.

This tentative classification is not consistent in its treatment of material and labor charges. In a number of accounts under the head of "maintenance of way and structures" mate-



rial only is to be charged, while the labor of applying the material charged to these several accounts is all included in one account entitled "roadway and track." Other accounts cover both labor and material and it is essential that all accounts should do so. Why is the labor separated from the material in these special accounts and not in all accounts?

Under a number of the principal maintenance accounts of this tentative classification the following note appears:

"This account may include each month a proportion of the total amount authorized or approximated during the fiscal year, regardless of the month in which the actual expense is incurred."

This is not good practice because it does not show the true facts. The estimated amount based upon the annual appropriation for certain work may be far from the actual cost and for 11 months of the year accounts thus treated would simply represent guesswork, misleading to the operating officials as well as for statistical purposes, particularly when the units of cost per car-mile or per car-hour are applied to the individual monthly operating expenses. One month of the year must take up the deficit or surplus on the various appropriations made.

No good purpose can be served by adopting a classification as uniform which will practically destroy the records of maintenance and operating costs on electric railway properties for the past series of years, as this tentative classification submitted by the interstate commerce commission would most certainly do. It is to be hoped that the electric railway companies will be given due consideration in this matter before any classification is adopted by the interstate commerce commission.

S. C. ROGERS,

Treasurer and Auditor Mahoning & Shenango Railway & Light Company.

Youngstown, O., May 1, 1908.

#### THE PUBLIC SERVICE LAWS OF WISCONSIN.\*

BY PROF. B. H. MEYER, CHAIRMAN WISCONSIN RAILROAD COMMISSION.

The public utilities law requires among other things the commission to value the property of all the public utilities, specifically, all the property "used and useful" for the convenience of the public. The question arises: What is property "used and useful"? The first step is a physical valuation. An engineering staff of some 30 men, organized in groups, each with its special line of work, is assigned to this. On the basis of their statistics a certain price is agreed upon for the different physical parts of the plant, the sum total of which will be the value of the physical property. After such physical valuation has been tentatively worked out a day is set for hearing.

Perhaps the most difficult question that has arisen here is the amount that should be allowed over and above the value of the physical property of the utilities. It is argued, for instance, that you may have in your possession all the parts of a chair and the labor required to put that chair into shape paid for in advance, and yet the combined cost of the parts of material and the labor going into that chair do not constitute its value. How much shall be added? The representatives of the utilities say that all the way from 5 to 100 per cent shall be added, and the line of reasoning in support of this, generally speaking, appears to be something like this: If the price of gas is \$1.25 and the price of light, say, is 15 cents per kilowatt-hour, and you, representing that utility, find that you must add to the physical value 50 per cent in order to justify your rate, you tell us you claim 50 per cent "going value"; and if you find you must add 75 per cent you state that 75 per cent is the "going value." In other words, "going value" can be made a general, elastic term to express whatever value is required over and above the physical value to justify whatever rate you choose to put in.

Now, there are, of course, in the term "going value" certain definite things. I want to say that I am still open to conviction, but have very strong suspicions in certain directions. If, for instance, the representative of a utility can show that in building up a business he has spent so much money; that during the first five years he just covered operating ex-

penses and perhaps paid only 2 or 3 per cent additional, and that for the next two years he paid 5 or 6 per cent, and then, finally, after 10 years he paid 8 or 10, then I imagine we would all agree that he is entitled to some return now, because of the fact that during the first three, four or five years he earned nothing, or very little, or possibly went in debt. That is a tangible and demonstrable thing. But when you have the physical property and the amount expended in getting your customers, when all that is accounted for, and then you come in and ask for an addition of 25 or 50 per cent, I think you will agree with me that you must show some adequate reasoning besides the mere say so of somebody's "judgment."

Then there is the matter of standards. With a view of arriving at certain standards which the commission might promulgate, as it is required to do under the law, a conference was held with representatives of all the utilities in the state. As a result of this conference the commission hopes to announce a few relatively simple rules which can be applied immediately, and then to elaborate and add to them. A great deal can be said about unjust discrimination in the service and rates of public utilities. Free and reduced rate service exists very generally, and to a certain extent still exists, because under the law many of these discriminations cannot be removed without an advance, and, as no rate can be advanced without authority, these discriminations will continue until the commission can get around to them.

Professor Meyer then answered questions from various members, saying in part:

The owner of a telephone plant in a small town applied for permission to take out of his schedule a combined business rate of \$1.75 and put in a residence rate of \$1.00 and a business rate of \$1.25. The commission felt it could not decide the question, which involved an advance in revenues of something like \$30 a year, without having an actual valuation made. An expert accountant went over the pocket memoranda and other documents of the owner and the engineers took an inventory. Putting their findings together the commission found that this proprietor, without charging anything for his own personal services or for depreciation, had made scarcely 4 per cent on his actual money investment in the telephone business. In the electric light branch, without allowing him anything for services, or for depreciation, he had \$126 at the end of the year. This is only one illustration of how this law will put the administration of public utility properties on a business basis.

The commission is obliged to prescribe a uniform system of accounts. In that system of accounts, depreciation, for instance, is expressly provided for. How much that shall be is a question of fact in each case; but depreciation must be provided for and all accounts kept in a certain way, so that at the end of a financial period it is possible, or rather will be possible, to make comparisons among the different utilities throughout the state, not only the different company utilities, but also the municipal utilities. It will not be possible hereafter lawfully to charge to the street cleaning department the labor of 25 men, say, for three months, who have been working for the water department, if the water department is a public enterprise.

If the valuation is not satisfactory there is an appeal, as well as in all other cases, to the circuit court, and from the circuit court to the supreme court. The record before the commission is made the record before the circuit court, and no new evidence can be introduced. Cases of appeal from commissions to courts have frequently been made new questions before the courts. Railways or utilities have not always tried cases on their merits before a commission, because they wanted to appeal and make a test before the court. But under the Wisconsin law, if a railway company or a public utility introduces new testimony in court, thereby automatically the case is thrown out of court and back to the commission. If that additional testimony leads the commission to change its decision it may do so. On the other hand, all of the evidence before the commission, or all the facts which weighed in the minds of the commissioners in arriving at a judgment, cannot be made a part of the record on which the case goes to the court, because the commission is not tied down to the technical rules of evidence in hearings, nor is it tied down to the record in the case; it goes outside of the record. However, the commission endeavors at all times to play fair, and to place before the utility or the railway company or a complainant all the information it has.

In a state like Wisconsin, in most communities it will be possible to maintain the plant in a good physical condition, to put aside a liberal depreciation reserve, to maintain a surplus fund to carry it through uneven years, and at the same time have very reasonable rates. We hope that investments in public utility enterprises will gain in attractiveness rather than lose.

\*Abstract of address delivered before the City Club, Chicago, April 11, 1908.

**THE GROWTH OF THE KOKOMO MARION & WESTERN TRACTION COMPANY.**

BY C. A. TUPPER, PUBLICITY MANAGER ALLIS CHALMERS COMPANY.

As an illustration of what may be accomplished in building up an existing electric railway, lighting and power distributing system and at the same time strengthening the industrial position of an entire community, the management

projected to Terre Haute and Lafayette on the west, distant respectively 130 and 79 miles from the eastern terminus of the road.

**Track and Overhead.**

The line of the interurban road, built on a 40-foot private right of way, has easy curves and a maximum grade of no more than two degrees, most of the track being laid on the level. Seventy-pound rail is used, joined by 6-bolt standard splice bars.

The Ohio Brass Company's No. 0000 compressed bonds and soldered bonds are used on the interurban line and No. 00 compressed bonds on the city tracks.

The road is ballasted with crushed stone and gravel six inches deep beneath the ties. The ties are of white oak. Side arm construction has been used for the entire course of the line. The brackets are 9 feet long with 1½-inch tubing made by the Ohio Brass Company. The lightning arresters, four to the mile, are grounded by means of copper wire and ¾-inch iron rods driven into the ground by the side of the pole and also connected to the rail. The trolley wires consist of two No. 000 wires suspended by Ohio Brass Company type D hangers. Feeders of 300,000 and 500,000 circular-mil copper cables feed the interurban trolley wires 10 miles from the power station. The feeder from the substation is stranded aluminum equivalent to 300,000 circular-mil copper.

**Cars.**

There are six passenger cars, one freight car and one work car. Cars are run on one hour headway, only three being ordinarily in service at the same time. The interurban cars are operated at an average speed of 25 miles per hour. The Jewett Car Company built the cars. They are equipped with four 50-horsepower 93 A motors, K-28 controllers and straight air brakes. Inside they are fitted with every modern convenience, including overhead bundle racks, Peter Smith hot water heaters, toilet rooms and lights of high candle-power. About two-fifths of the interurban car is devoted to a smoking compartment having comfortable arm chairs arranged along the sides, and the remainder has aisle seats nicely upholstered. Direct telephone connection can be opened at any time between the cars and the train dispatcher's



Kokomo Marion & Western—Track on Private Right of Way.

of the Kokomo Marion & Western Traction Company furnishes one of the most striking and instructive examples to be met with anywhere in the country. At the time ownership of the system was assumed by the interests now in control,

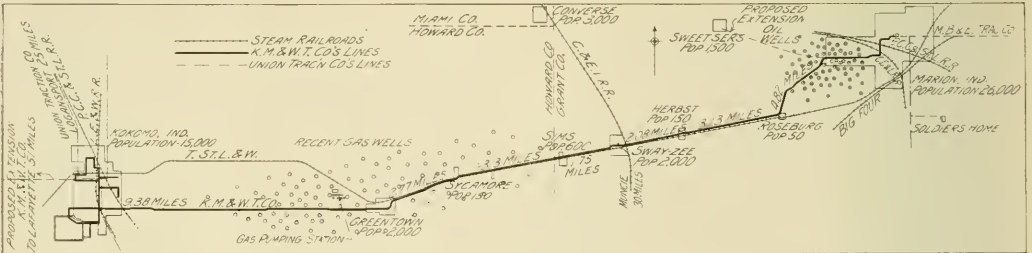

Kokomo Marion & Western—Map of Line and Connections.

less than four years ago, there was a small street railway and electric lighting plant, having no greater output than 500 kilowatts, a few miles of trackage wholly within the city of Kokomo, Ind., and circuits containing several hundred arc and incandescent lamps. Today 22,000 incandescent and 395 arc lamps in and about Kokomo are supplied with electric current and more than one-half of the company's customers have various electric household devices; factories in the vicinity take upward of 1,000 horsepower daily in current for operating motors; the street railway system has been extended to a trackage of 10 miles, and a finely equipped interurban line 28 miles long extends from Kokomo, a city of about 18,000 inhabitants, to Marion, which has a population of 26,000, through several substantial towns. Further extensions are

office by a pole and hook connection operated in accordance with the Stromberg-Carlson system.

The city cars, built by the Cincinnati Car Company, are 22 in number, each having two 40-horsepower 92 A motors and K-10 controller. Some of them are equipped with air brakes.

**Car Barn and Repair Shops.**

In the city of Kokomo there is a car barn 150 by 50 feet with four tracks and a pit underneath the entire length of one. The repair shop adjacent to this is 45 by 70 feet and contains two tracks, one having a pit 60 feet long beneath it and the other having a pit of sufficient size to be used in taking out a truck. This shop is equipped with a full line of shop tools.

Among outward signs of progress the most prominent is the development of the new power station, which has recently been equipped with two Allis-Chalmers steam turbines and generators having an aggregate normal capacity of 2,000 kilowatts and delivering two-phase 60-cycle current at a terminal pressure of 2,300 volts. The first of these machines, put in operation on February 21, 1907, was found so satisfactory that a second unit of like construction was ordered, the latter being placed on the line on December 7 of the same year.

#### Power Station Building.

Everything connected with the physical equipment of the system has been very carefully looked after and one of the best evidences of this is the power house itself, which is a well-planned well-built fireproof structure. The exterior walls are faced with standard pressed brick laid in three-fourths

the building. There, by means of a bucket elevator and inclined conveyor, the material is discharged to storage bins at one side of the building and unloaded into cars, which take it to points along the line where it can be used as ballast.

#### Boilers and Stacks.

The boiler equipment, set on concrete foundations reaching to bedrock, consist of three batteries, two of which include four Stirling boilers, each having a capacity of 235 horsepower and the third comprising one Atlas water tube boiler with a capacity of 400 horsepower. Two of the Stirling boilers discharge into one steel stack, 6 by 80 feet, and the other two, with the Atlas boiler, into a stack 6 by 125 feet, also of steel. The shorter of these stacks is equipped with an engine driven blower, made by the Sturtevant company, by means of which enough draft can be induced to give large



Kokomo Marion & Western—General View of Power Plant, with Storage Battery House in Foreground.

English bond, with headers in each fourth course, affording a thorough bond into the wall. All of the interior surfaces in the engine room which have not been enameled are faced with Kokomo pressed sand brick of buff color and the remaining brick work is of the ordinary kiln-rnn quality. Tile roofing covers the building.

The foundations above grade are of Indiana cut limestone and below of concrete resting on bedrock.

The floors are of concrete with smooth surface, the engine room floor being supported on steel beams and under each of the turbine units there is an independent concrete foundation to a depth of 13 feet 6 inches, foundations for the exciters, condensers and other auxiliaries being correspondingly massive. All machinery foundations rest on bedrock.

#### Coal Handling.

Coal, consisting of a comparatively low grade of Indiana screenings, is brought in on a spur from the Lake Erie & Western Railway and unloaded through a trestle extending the entire length of the firing room, so that it is heaped up in front of the furnaces, which are hand fired.

Removal of ashes is accomplished by an inexpensive device. Instead of the customary ash pit with track and cars there has been installed a tunnel and screw conveyor through which the ashes are constantly transferred to a pit outside

temporary overload capacity to the two boilers with which it is connected.

#### Piping and Auxiliaries.

A main steam header 12 inches in diameter, located above the pump compartment in the steam turbine room, is in the form of a loop, from which each turbine unit is fed by a 7-inch pipe. Gate valves are placed between each battery of boilers and between each turbine inlet, these valves being of the Crane type with rising stems. There is also a 4½-inch auxiliary header. A proper arrangement of valves enables any part of the plant to be fed from any boiler at will. Heat insulation is provided in the shape of heavy covering, furnished by the Johns-Manville Company. The system includes Cochrane steam separators.

The condensers and all of the other auxiliaries exhaust into a Cochrane heater (with Sorge water purifier), where a temperature of from 200 degrees to 212 degrees F—never less than 200 degrees—is constantly maintained. Water may be drawn from either the condenser suction or discharge pipes, from a deep well or from the city mains, and discharged into an elevated tank which feeds by gravity into the heater and from there by gravity into the boiler feed pumps, or the water may be by-passed directly to the boiler.

Two Worthington pumps are used for supplying the tank

over the heater and two Dean pumps for boiler feed. Either one of any of these two is, however, of sufficient capacity to feed of the water system of the entire plant. The former are now being displaced by a centrifugal pump with 2½-inch discharge, driven by an induction motor supplied with current directly from the main generator buses through a step-down transformer, but the steam pumps will be held in reserve.

Water for condensation and boiler feed is taken from a creek about 350 feet distant through a 16-inch cast-iron pipe and discharged back to the stream through 20-inch tile. The water is drawn from a concrete basin in the creek, 7 feet square inside and extending 6 feet below the water mark, with walls extending to high-water mark and a gate on the down-stream side where the water enters. This gate can be readily closed down tight when desired and the water ex-

pistons. Other details of special interest will be mentioned briefly under the subjects to which they belong.

The turbines operate at 1,800 revolutions per minute, with a steam pressure of 140 pounds at the throttle, dry saturated, and a vacuum of 28 inches of mercury referred to a 30-inch barometer at the exhaust nozzle. Large temporary overload capacity has been provided for in the design of these machines: high efficiency is maintained, and close regulation secured, even under the most unfavorable operating conditions, as a result both of good design and efficient station management. The turbines are frequently run six weeks at a time without taking the load off and then only to make inspection.

#### Bed Plate.

The bed plate is divided into two parts, one carrying the low-pressure end of the turbine and the bearings of the

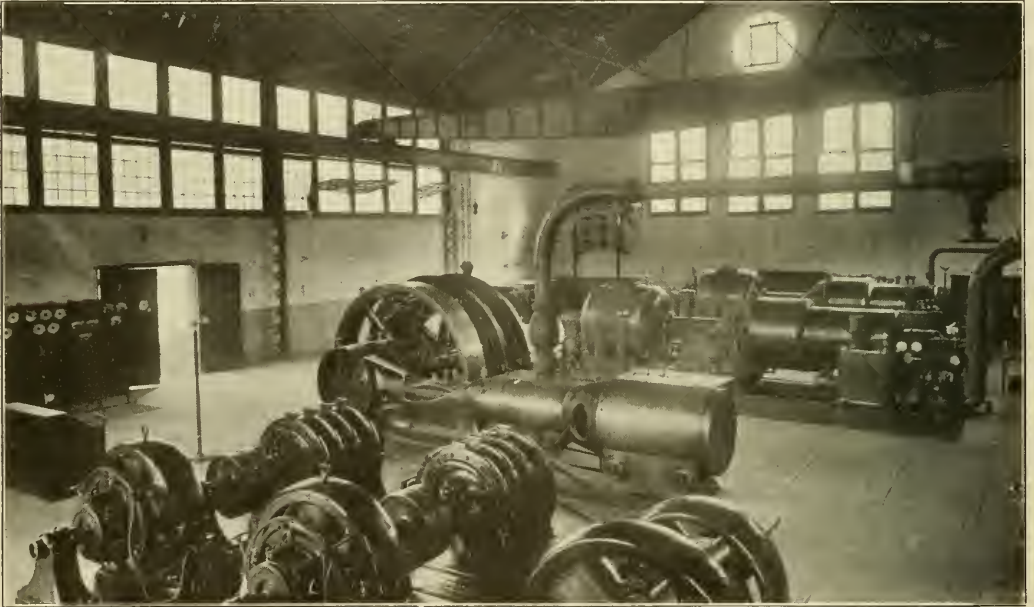

Kokomo Marion & Western—Interior of Power Station,

Showing Turbo-Generators, Engines and Motor Generators.

hausted by pumps in the power plant, so as to facilitate cleaning the basin of sand and mud.

#### Steam Turbines.

The turbine operating floor is 5½ feet above the boiler and pump room floor, 11 feet above the basement floor and 30 feet below the roof trusses, the foundation of each generating unit being kept entirely separate from the steel frame of the concrete flooring. Overhead is a 10-ton crane, hand operated.

In this room are placed two horizontal steam turbines and generators, of 1,000 kilowatts capacity each, a 330-kilowatt engine driven alternator operated in parallel with them, the exciter for these units and substation apparatus, transformers, switchboard, etc., as later described.

Incorporated in these turbines are the various patented features controlled by their builder, Allis-Chalmers Company, among which may be mentioned channel shaped shrouds protecting the ends of the blading from injury, machine cut slots in the foundation rings insuring accurate spacing of the blades; a method of fastening the latter which effectually prevents them from working loose, and improved balance

generator and the other the high-pressure end of the turbine. The turbine is secured to the former, while the latter is provided with guides which permit the turbine to slide back and forth with differences of expansion caused by varying temperature, at the same time maintaining the alignment. This arrangement permits of the utilization of the entire space between the foundation piers and below the turbine, for the condensing apparatus. A grating is provided in the engine room floor directly over the condenser pumps and engines, so that operators above and below can watch each other's movements and signals, and the auxiliary engines can ordinarily be watched from above.

The condensers for the steam turbines are of the jet type, built by Allis-Chalmers Company, each capable of giving the best possible service when its unit is operating at full rated load. Cycloidal air pumps, direct connected to inclosed, self-oiling, high-speed engines, and duplex double-acting circulating pumps are installed with this apparatus, as is also a third condenser to take the exhaust from the remainder of the plant.

The speed of each turbine is regulated within close limits by a governor driven from the shaft through cut gears

working in an oil bath. This governor, by means of a relay, operates a balanced throttle valve. The entire mechanism is so proportioned as to respond at once to variation of load, but its sensitiveness is kept within such bounds as to secure the best results in the parallel operation of the two turbo-generators in this station. The governors can be adjusted for speed while the turbines are running, thereby facilitating the synchronizing of the alternators and dividing the load as may be desired. In order to provide for any possible accidental derangement of the main governing mechanism, there is an entirely separate safety or overspeed governor. This governor is driven directly by the turbine shaft without the intervention of gearing, and is so arranged and adjusted that if the turbine should reach a predetermined speed above that for which the main governor is set, the safety governor will come into action and trip a valve, shutting off the steam and stopping the turbine.

The bearings are of the self-adjusting ball and socket

direct-current motors, taking their power from the exciter circuits. No oil of any kind is used in the interior of the Allis-Chalmers steam turbines, nor in the glands through which their shafts pass. Low oil alarms have been provided for the turbines.

The hot parts of each turbine, up to the exhaust chamber, are covered with an ample thickness of non-conducting material and lagged with planished steel, so applied that it may be easily removed. The non-conducting covering is also removable at the cylinder joint to facilitate the opening of the turbine for examination.

**Coupling.**

Between the turbine and its generator a special type of flexible coupling is used to provide for any slight inequality in the wear of the bearings, to permit axial adjustment of the turbine spindle, and to allow for difference in expansion. This coupling is so made that it can be readily disconnected for the removal of the turbine spindle or of the revolving field of the generator. Provision is made for ample lubrication of the adjoining faces of the coupling.

**Turbo-Generators.**

The revolving field alternators driven by these turbines are of Allis-Chalmers Company's standard type, designed for high efficiency and safe operation at high peripheral speeds. The field core is built up of steel discs, each in one piece, giving high magnetic permeability and great strength. Coils are placed in radial slots, thereby avoiding side pressure on slot insulation and the complex stresses resulting from centrifugal force, which, in these rotors, acts normal to the flat surface of the strip windings. Bronze wedges hold the coils firmly in the slots, making the surface of the rotor a smooth cylinder, reducing windage losses and insuring quiet operation, and the end connections are securely held by chrome-nickel steel rings.

The stator is completely inclosed, eliminating noise of operation. Coils were completely wound and insulated before being placed on the core, thus obviating the risk of defective ventilation. Stator windings are placed in open slots, rendering the coils readily removable. End connections are firmly braced, preventing deformation of coils in case of short-circuit.

For the purpose of obtaining adequate ventilation and for muffling the noise produced by the circulation of air, the turbo-generators are inclosed in such a manner that the air is taken in at the sides through fans mounted on the rotor shaft which discharge it over the end connections of the armature coils into the bottom of the machine, whence it passes through the ventilating ducts of the core to an opening at the top. This system of ventilation is most efficient.

**Exciters.**

Excitation of the two turbo-generators is accomplished by means of exciters of 35 kilowatts and 30 kilowatts, the former being driven by an Allis-Chalmers induction motor and the latter by an Erie Ball engine. The engine driven generating unit has a 5-kilowatt belt ed exciter. Turbo-generator

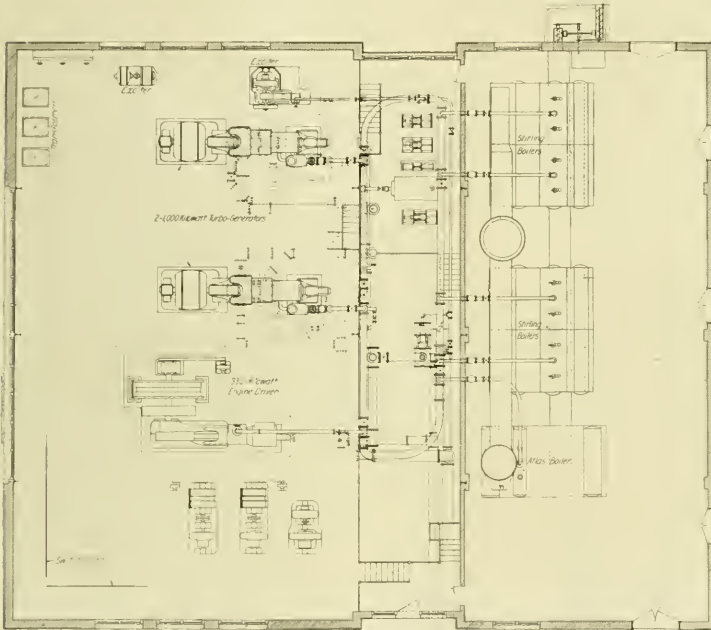

Kokomo Marion & Western—Plan of Power House.

pattern, especially designed for high speed. Shims are provided for proper alignment.

**Lubrication.**

The lubrication of the four bearings, two for the turbine and two for the generator, is effected by supplying an abundance of oil to the middle of each bearing by means of a small cycloidal pump driven from the turbine shaft and allowing it to flow out at the ends. The oil is passed through a tubular cooler with water circulation and pumped back to the bearings.

It is not necessary to supply the bearings with oil under pressure, but only at a head sufficient to enable it to run to and through the bearings, this head never exceeding a few feet. The oil cooling system is taken care of by two induction motor driven centrifugal pumps, supplied by Thomas & Smith of Chicago and the American Well Works, and the gland water for the turbines is also supplied by two centrifugal pumps purchased from the former company, propelled by

excitation at full load is 120 volts, 160 amperes. The exciters do not take care of the station lighting. Current for this is derived directly from the main busbars or from a storage battery.

#### Station Load.

As above intimated, the character of the load put upon this station is railway, lighting and power combined. At present there is a normal consumption of current somewhat under the rated capacity of the turbines, so that one can be held constantly in reserve, and this drops to a minimum during the early morning hours of about 300 kilowatts.

A feature to be particularly commended is the thorough keeping of station records and the frequent checking of efficiencies of different parts of the plant. On the company's log sheet the daily load curve is plotted, thereby enabling it to be easily comprehended for the 24 hours at a glance. All costs and station performances are also recorded on the daily log. In addition to this records are kept in the office of the outside distributing circuits and two Wright demand meters are constantly used to check the loads on lighting and power transformers over the town.

Alternating current is generated at two-phase, 2,300 volts, and transformed to three-phase, 11,000 volts, for transmission over the line of the interurban railway. In the main station there are used for this purpose three 150-kilowatt oil-filled self-cooled transformers, Scott connected, and in the substation, 17 miles distant, there are three 150-kilowatt step-down transformers delta connected. These transformers have 1½-inch outlet pipes run directly through the floor, so that in case of fire oil can be emptied into barrels in the basement where the oil supplied is stored.

Direct current for the city railway system and 10 miles of the interurban line is supplied through motor generator sets in the main station, delivering power at an operating pressure of 600 volts, and the substation at Swayzee, 18 miles east of Kokomo, contains three rotary converters for the purpose of transforming the alternating to direct current. One of these, having a capacity of 200 kilowatts, is equipped with an induction starting motor and two of the 75 kilowatts each are started through a storage battery from the direct-current end.

#### Distribution of Current.

Current from the main generator busbars passes to the outgoing lines through double through switches, ammeters, wattmeters and fuses, all such circuits being also put through integrating wattmeters. Three hundred thousand circular-mil cable is used, with high voltage rubber insulation. The wiring from the generators to the switchboard is open work, fastened to the under side of the engine room floor. The busbar system is in duplicate. Any machine or any feeder can be operated off of any set of buses. The switchboard rests on insulated stringers.

#### Storage Batteries.

In a separate building, located about 60 feet from the main generating station, is a battery installation supplied by the Electric Storage Battery Company, which has a capacity of 480 ampere-hours and consists of 288 "chloride accumulator" cells. A smaller storage battery, consisting of the same number of cells, but having a capacity of 320 ampere-hours, is installed in the substation at Swayzee. The latter has glass cells and the former are of wood with lead lining. The function of these batteries is to eliminate load fluctuations on the rotaries so that their output will be constant. Regulating boosters are installed in conjunction with each battery, of such design as to automatically regulate the charge and discharge of the battery, causing it to discharge when the load is in excess of the average and charge at times when the load is less than the average.

Alternating current passes from the switchboard busbars through the transformers, as above mentioned, and stick

breakers are provided between the high-tension sides of the transformers and the outgoing lines, which are led through high-voltage bushings protected by round glass plates set in tile.

The lines are equipped with Westinghouse low-equivalent arresters and Westinghouse choke coils, to which ready access is had from the gallery. The lightning feeders have G.E. lightning arresters and choke coils built at the station. On the direct-current railway system Garton lightning arresters are used, there being four of these to every mile.

#### Services.

Kokomo has an exceptionally large number of factories and industrial establishments of various kinds, most of which are located on a belt railway that runs around the city at its border. This insures to the city lines large traffic the year through and in summer it is augmented by pleasure trips made to a beautiful and much visited park which the city maintains on the outskirts of the town. Adjacent to this there is also a well-equipped amusement park owned by the company.

A stone quarry, which was originally owned and operated by the company, in order to provide crushed rock for ballast, but has since passed into the possession of others, is located on the line of the interurban railway; and the larger part of the product of the plant—about 300 cubic yards per day—is transported by the company to the steam roads and out into various parts of the state. All of the machinery of this quarry used in crushing, elevating, etc., as well as of another quarry having similar capacity, is operated by motors run on alternating current taken from the power circuits.

Among other important customers taking power for motors are a brass works and spark coil factory, two machine shops, a large flour mill, an automobile manufactory, bottling works, leather and harness establishment, glass factory, canners, planing mill, cooperage plant, mitten works, lumber yards and nearly all of the smaller factories and shops in Kokomo, representing no less than 84 distinct industries. The use of small single motors and groups of two or three operated for various purposes is also growing throughout the city, so that electric drive has become one of the recognized features of the town. To accomplish this result, which has been brought about within comparatively recent time, T. C. McReynolds, secretary-treasurer and manager, and P. H. Palmer, the company's engineer and lighting superintendent, have made a systematic study of local power requirements and are prepared to give each prospective customer a detailed statement as to just what improvements can be effected in his particular case by the substitution of motor drives in place of power applied through shafting, belting, etc. Furthermore, the company is ready at all times to back up its assertions by satisfactory guarantees and to submit complete engineering plans involved by the proposed change. It is indeed a stubborn proprietor or manager who, seeing certain advantages of electrical operation set forth in black and white and guaranteed by a responsible concern, is not willing to listen to such overtures as the central station people in this city are ready to make.

The company's campaign has, however, not stopped at factories, shops, stores or industrial establishments of any kind; but has been carried into the homes of the city. Electric lighting is now become general and more than one-half of the company's customers have electrical apparatus of one kind or other, including laundry irons, heaters and cooking utensils. If progress made along this line during the next few years is at all commensurate with present indications, it will mean an enormous increase in business and the probability is that more will be done in this direction than the most sanguine would believe, for the results of such work multiply almost in geometric ratio.

G. J. Marott, Indianapolis, is president of the company; T. C. McReynolds, secretary-treasurer and manager; P. H. Palmer, engineer; and H. P. Martzolf, superintendent of trans-

portation. To each of these officials must be given credit for far more than the average enterprise and foresight, and to those actively concerned in the operation of the system for downright hard work. With a management so intensely interested in promoting the welfare of a company success is unavoidable and the best prophecy of the future is the very encouraging testimony of the present.

**USEFUL ARMATURE REPAIR SHOP METHODS.**

BY NORMAN G. MEADE.

The economical operation of the repair shop and its ability to quickly execute necessary repairs is a subject of importance to every electric railroad. The equipment of tools and labor saving devices and the manner in which the work

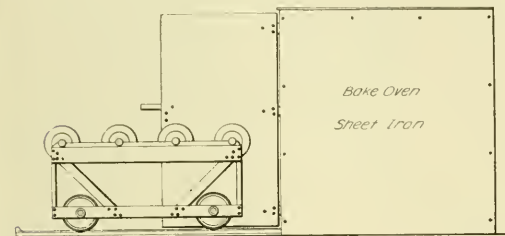

Figure 1.

is systematized are important factors upon which the ultimate economy of the repair work depends.

There are numerous small devices that are inexpensive and add greatly to the quality of the work and uniformity of the product. The shop equipment should include a lathe, shaper or planer, drill press, milling machine with an indexed head, a bake oven for the baking of armatures and field coils, a winding machine and numerous molds for armature and field coils.

**Bake Oven.**

A very convenient and serviceable oven is shown in Figure 1. It is made of an angle-iron frame covered with

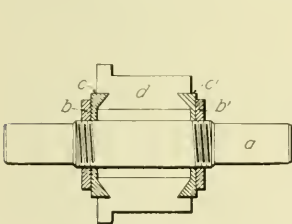

Figure 3.

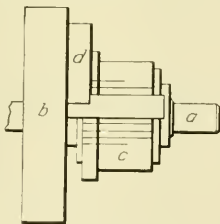

Figure 4.

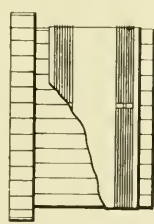

Figure 5.

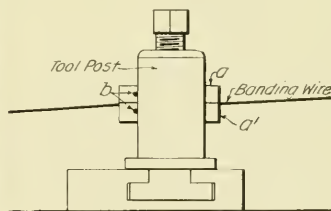

Figure 6.

sheet-iron lagging and provided with a large door. Steam coils are arranged about the inside for maintaining the requisite temperature. In the figure a track is shown, together with a small car with an angle and channel iron frame and provided with notches for receiving the armature shafts. When commutator or field coils are to be dried a sheet of iron may be laid on the car forming a table. The convenience of such an arrangement will be readily appreciated, as all heavy parts can be easily loaded and unloaded in the open by means of a crane or hoist.

A sloping rack for storing extra armatures is easily made of timber, occupies little space, and permits the armatures to be readily removed when needed.

The commutator is the part of the motor subjected to the greatest wear, therefore the facilities for quickly refilling them and making extras should be at hand. The first operation is loosening the armature leads and removing the old commutator. The segments should be bound tightly with heavy cord and the shell removed, when templates corresponding to the bore of each end should be made. Drop-forged segments for refilling can generally be purchased for the various standard motors. Sheet micanite is desirable for insulation between the segments and pieces can easily be cut out with a pair of snips, using one of the new segments as a pattern.

To assemble the segments stand them upright on a smooth surface, with the insulation in place as shown at b in Figure 2. They should then be clamped firmly by an iron or steel clamp shown at a, one-half being shown in the upper portion of the illustration where c and c' are holes to receive bolts, and d and d' dowel pins. The assembled segments are now ready for boring and may be clamped in the chuck of a lathe and bored at each end to correspond with the templates already prepared.

A device for holding the segments while finishing the outer surfaces is shown in Figure 3. The segments are shown at d and a is an arbor and b and b' are clamping nuts for holding the collars, c and c', in position. The temporary shell should be applied before loosening the outer clamp shown in Figure 2. When in place the assembled segments can be turned and finished. They are then ready for the slots that receive the leads. The milling machine is used for this purpose and the indexed head serves for spacing the slots properly.

The segments should next be carefully lined up as shown in Figure 4, where a is the arbor, b a surface plate, c the segments and d a try square. By sighting along the edge of the blade it is easily determined whether or not each segment is in line. If any one is out of line it should be driven into position by means of a small cold chisel and hammer. The outside clamp should next be applied and the temporary shell

removed when the segments are ready for assembling in the original shell. When removing the worn-out segments from the shell care should be taken to keep the insulating rings at each end intact for future use. After the new segments are assembled in the shell the commutator should be placed in the oven until thoroughly heated and the shell again tightened. The commutator, after a final polishing, is then ready for use. Care should be taken in all the operations to see that no metal chips become embedded in the insulation and before the commutator is used it should be thoroughly tested for grounds or short-circuits.

It is desirable when refilling a commutator to make up

several sets of segments ready for future use. This can be done by placing bands about the segments as shown in Figure 5. The bands consist of brass wire wound tightly and held in place by clips and solder as shown. The bands should be separated from the segments by heavy paper. A convenient arrangement for placing tension on the banding wire is shown in Figure 6. It consists of two pieces of fiber, a and a', with retaining pins, b, held in the tool post of the lathe. Any tension desired can be obtained by means of the clamping screw.

If the slots in the commutator for the armature leads are tinned before using, the soldering operation is much simplified. This can be done by applying soldering flux to the slots and immersing the shoulder in melted tin. Figure 7 shows a device, a, for lowering the commutator, b, into the tin, the ring on top being readily attached to a hand hoist.

**Armature Coils.**

Armature coils, to be successfully made, must be wound on forms and carefully shaped. When tearing apart a burned-out armature at least one of the old coils should be taken out carefully enough to preserve its original shape, so that a sketch can be made and the dimensions taken. Figure 8 shows the essential parts of a form for the first process in the making of coils. The center, a, and one side, b, are shown in plan view, and the opposite side, b', in side elevation.

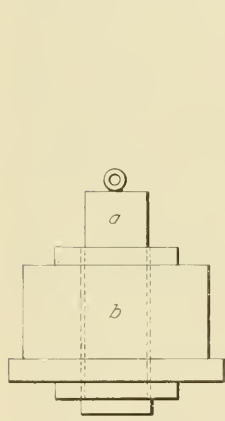

Figure 7.

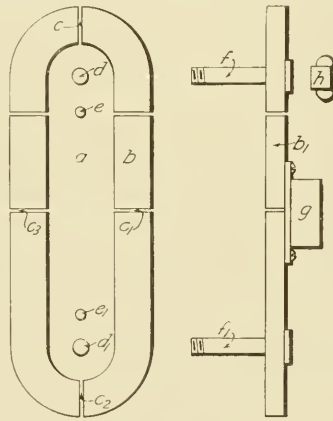

Figure 8.

tion. The slots, c, c<sub>1</sub>, c<sub>2</sub> and c<sub>3</sub>, are to receive pieces of cord for tying the completed coil together, so that it will retain its shape until taped. The holes, d and d', are to receive the bolts, f and f<sub>1</sub>; e and e<sub>1</sub> are dowel pins, h is one of two thumb nuts that screw on the bolts, f and f<sub>1</sub>, to clamp the parts of the form together. The center, a, is permanently attached to the side, b, so that it can be removed with the coil intact, when it can be easily taken off the form. A boss, g, is bored and threaded to screw on the winding machine shown in Figure 9. The slots in band, b, opposite the dowel pin, e, are for the coil ends.

The winding machine is a simple device, consisting of a spindle on which the forms are screwed, the necessary gearing for speed reduction and a pulley for the driving belt. The driving motor can be mounted under the bench and the controller operated by a foot treadle.

A coil is formed in the first operation and partially taped. To shape the coil a device shown in Figure 10 is used consisting of a wood base, a, to which grooved wood strips, b, are attached. The upper sketch shows a cross section of the form. One side of the coil is slipped into one groove and the other pulled over and slipped into the opposite groove, as shown. The ends are easily straightened with a mallet.

Figure 11 illustrates a soldering appliance for soldering the leads in the commutator. The apparatus is shown in section and the armature complete with a clamp on the shaft for lifting. A circular metal bowl mounted on legs forms the solder pot. The melted solder should be kept up to the level of the dotted line, a. A circular gas burner is shown below the pot. The armature is placed in the position shown, rest-

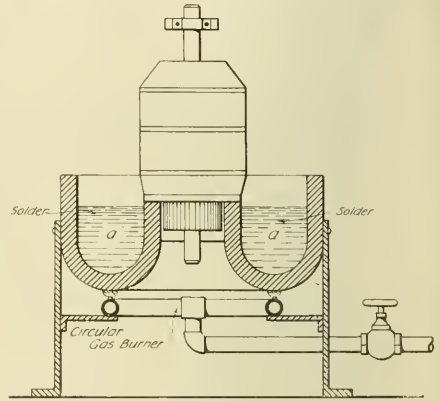

Figure 11.

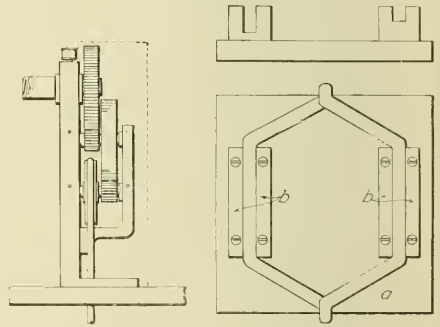

Figure 9.

Figure 10.

ing on the commutator shoulder, and the level of the solder raised by inserting a piece of heated metal, such as iron or steel. Any size of commutator can be soldered by using a bushing slipped over it, which will rest on the bowl.

Recent press reports have related that an electric truck is in operation about the shops of the Union Pacific Railroad at Omaha, Neb., the energy which operates it being transmitted wirelessly from a central station in the middle of the grounds. This report is incorrect in its essential features, though an interesting innovation is indeed being worked out. W. R. McKeen, Jr., superintendent of motive power of the Union Pacific at Omaha, advises us that a storage battery truck is in use in the Omaha shop yard. For experimental purposes this truck has been equipped with necessary receiving wires and wireless waves have been used in connection with a wireless telegraph coherer for making and breaking the circuit between the batteries and the motor on the car, thus starting and stopping the car. This system, while not wireless transmission of energy in the popular sense, should involve some very nice apparatus; and this, the reports state, is being worked out by Dr. Frederick H. Millener, working under the direction of Mr. McKeen.—Railway and Engineering Review.



**SHORT TALKS WITH THE CLAIM INVESTIGATOR—IV.**

BY F. W. JOHNSON, ASSISTANT GENERAL CLAIM AGENT PHILADELPHIA RAPID TRANSIT COMPANY.

A working knowledge of the principles of the law of negligence is of the utmost importance to the investigator who is desirous of some day standing at the head of his own department. Its value to him cannot be overestimated.

Many young men in claim work seem to labor under the impression that they have, for the time being, reached the limit of their development in the work of the department when they have become proficient in the securing of statements and of releases. Having reached this stage, they let up somewhat in aggressiveness and resign themselves to waiting patiently for promotion.

**Necessity for Study.**

Right here is where they are misled. Having successfully negotiated the first steps in accident work, instead of waiting for good luck, they should immediately reload their guns and follow the trail for even larger game. Vacancies higher up are bound to occur sooner or later; if not in one company then in another. When that opening does come, the man who has had the foresight to prepare himself in advance for added responsibilities stands in a class by himself, for he has stolen a march upon many another man just as capable as himself, but who lacked his foresight.

To the investigator who is desirous of broadening his knowledge of claim work the suggestion is herewith advanced that he take the matter up direct with the head of his department, explaining to him his wishes in this direction and asking for his advice and assistance. He will find his chief only too willing to aid him in every way within his power.

A systematic course of work, devoting say one hour a day to study, will prove of incalculable assistance to the investigator in his daily work, and in time will give him an insight into the principles of the law of negligence, particularly of his own state, that will qualify him for broader fields of action. With the possession of this knowledge comes promotion, and with promotion comes the ever welcome increase in salary.

**Knowledge of Medical Terms.**

Having branched out in the right direction, go one step further and acquire as well a working knowledge of the medical and surgical terms commonly met with in this work. Here again can the head of the department render valuable aid in offering suggestions concerning the course of study. It is not essential that a man should attempt to qualify himself as a full-fledged expert; the idea rather is to gain sufficient knowledge to enable one to intelligently understand the reports submitted by the company's examining surgeons, and to accurately judge of the severity of an injury, and of the probabilities of the future.

The ability to recognize defects, wherever they may exist, and to advance suggestions of a remedial character, is another feature of claim work the possibilities of which are too little appreciated by the average investigator.

It doubtless is true that investigators sometimes hesitate to advance suggestions of this nature for fear of offending or of incurring the displeasure of the head of the department. There should be absolutely no grounds for such a feeling, for if a man has any breadth of view at all he cannot but recognize the value of suggestions of just this character.

**Value of Offering Suggestions.**

A man doesn't have to go four or five hundred miles from home in search of defects. The condition of the company's rolling stock, roadbed and overhead construction, the daily work of the men upon the cars, the advantages of safety appliances in connection with the operation of cars, the methods followed by the department in its routine work, the organization of the office force, and the blanks and forms in use in the depart-

ment—all of these and countless other matters furnish abundant opportunity for constant improvement, if only a man is sharp enough to recognize defects.

An illustration of this very point may be cited in the custom followed at the immense plant of the National Cash Register Company at Dayton, O. Here every inducement is offered the company's employes to advance suggestions of this very character. A recording device, designed expressly for this purpose, is placed in each of the many departments. Upon these suggestions are noted by the employes, one copy going to the company, the other being detached and retained by the employe.

Upon the occasion of a recent visit to the plant the visitors were informed that countless suggestions of a very valuable character had been advanced by the employes in this way. Due acknowledgment is given by the company of suggestions so received, and it has been found that the interest and enthusiasm of the several thousand employes of the company have been stimulated by their efforts to improve always upon the methods in operation. One interesting instance was cited wherein the desire of an employe to better conditions in his department resulted in a discovery of considerable moment to both the employe and the company. It appeared that the company used a roll of paper, supposed to be of a certain specified length, in connection with the output of one of its departments. The employe in question decided to measure these rolls one day, in order to verify the measurement. To his astonishment he found that they averaged from 20 to 30 yards in excess of the supposed length. This discovery naturally resulted in a considerable saving to his employers in the course of a year.

The opportunities for offering suggestions of this character are just as great in claim work as in any other line of business. A man should not require a special invitation to give to his chief whatever suggestions occur to him along this line. In claim work suggestions should always be put in writing, addressed to the head of the department, and should represent the best thought of the writer upon the subject referred to, as opposed to hasty conclusions formed upon the impulse of the moment.

**Personal Appearance.**

The matter of personal appearance likewise is a subject which should not be entirely overlooked by the claim man of the present day. First impressions are said to be lasting ones, and in his line of business it is of considerable importance that the first impression formed of him by claimants and witnesses should be as favorable to him as possible. By this it should not be inferred that he must be expensively clothed, or that he should possess the manners of a dancing master, in order to create a favorable impression.

It is simply a question of neatness and of good taste. An occasional pressing of the business suit, shoes blackened daily, face clean shaven, clean linen and a becoming scarf, carefully tied, all cost but little, yet go far toward imparting a wholesome, well-groomed appearance to a man. It is just a question of whether you prefer to appear as a clean-cut, successful young business man or as a recent arrival from the backwoods district.

In conclusion, bear ever in mind the value, from a business point of view, of a good, clean record. If you have any such thought, disillusionize your mind of the belief that trickery, fraud or questionable tactics have any place in claim work. Remember that an advantage gained through fraudulent means can be but temporary in character and of no actual benefit to your company or to yourself.

Endeavor at all times to act fairly and honorably toward your employer, toward your witnesses and claimants, and toward yourself.

You will find it a winning combination that will leave no bad taste in the mouth.

## A REVIEW OF THE PRESENT PRACTICE AND ECONOMICS OF TIMBER PRESERVATION.\*

BY EUGENE P. SCHOCH, UNIVERSITY OF TEXAS.

The increased price of timber has led many users of wood to inquire carefully into the subject of timber preservation. The railroads have carried on a systematic and painstaking investigation for a number of years and the United States government, through the department of agriculture, more particularly the bureau of forestry, has studied the subject in a way that has supplemented and augmented the information gathered by our railroads and European governments so as to bring it down to a point where answers to the question, "Does it pay?" can definitely be given.

The problem before us in its simplest terms amounts to this: "Is wood preserving profitable?" This is not a simple problem to solve. So many factors enter into the final calculation of the cost that one general answer cannot be given. Granted that a wood preserver is certain to lengthen the life of a tie, the question becomes: How much may we spend for a preservative in order to gain a certain increase of life? Evidently the preservative which would lengthen the life of the tie to the greatest extent is not necessarily the most economic preservative to use, because it is possible that the extra cost of the best preservative over some cheaper, but less effective, article or method is not balanced by the extra length of life of the tie. In this calculation must be included the calculation for the relaying of the tie, which would seem to give the advantage again to the preservative that insured the greatest gain in the life of the tie. On the other hand, however, we may be confronted with the difficulty that the tie may be destroyed through mechanical wear or influence other than decay before the expiration of its assumed life, and for this reason a cheaper method again may be preferable. And so one consideration after the other must be duly weighed before a final answer can be given.

### Causes of Decay.

The causes of decay are bacteria and fungi which attack the fibers of the wood. For a detailed description of the action of these fungi in their attack upon wood fiber see Bulletin No. 10, division of forestry, "Timber: An Elementary Discussion of the Characteristics and Properties of Wood," and Bulletin No. 14 of the bureau of plant industry, "The Decay of Timber and Methods of Preventing It." (These two and all other United States government bulletins referred to in this paper are published by the department of agriculture.)

These fungi and bacteria grow best when they have an abundant supply of food and certain conditions of heat, moisture and air. In the absence of one of these growth is inhibited. The efforts in timber preservation should be directed as much toward prevention of the best conditions for the growth of the fungi and bacteria as it should be directed toward poisoning these organisms. Thus, green timber, containing in its sap an ample supply of readily assimilated food, as well as a proper amount of moisture, presents in that state splendid conditions for the development of bacteria and fungi, whereas well-seasoned wood presents unfavorable conditions—the sap has dried out and the fibers and remaining portions are not in a form in which they are as readily assimilated for food as they were before the sap was dry. Also the absence of moisture retards the growth of bacteria and fungi. Hence, wood may be said to be extensively preserved by proper seasoning.

The advisability of seasoning rests not only upon this point, but furthermore upon the fact that preservative liquids cannot be injected into the wood unless the space occupied by the sap had been previously made vacant by the removal of the latter. Furthermore, the preservative liquids in general penetrate only a part of the wood, and if in the parts not reached the conditions for the development of fungi and bacteria are suitable, decay will set in there and continue, although the outer portions may be completely preserved. The baneful effects of preservative treatment without preliminary seasoning of some sort or other are well known to all practical wood preservers, and as the result of general experience it may be said that the most essential first step in the preservation of timber is proper seasoning.

### Seasoning Timber.

Seasoning is attained in different ways. Of course, the commonest is air drying—read in this connection Bulletin No. 41, bureau of forestry, "Seasoning of Timber." It is remarkable what results can be attained when by proper stacking timber is given a chance to season. Even three months'

seasoning is very beneficial. In many cases over three-fourths of the moisture in green timber is evaporated during the first four weeks. Four months' summer seasoning is adequate for wood used for many purposes, notably for ties and posts. The main thing that is necessary for this purpose is a proper stacking of the timbers, and attention to this detail cannot be urged too much. In suitable localities satisfactory seasoning may be practiced without requiring therefor an amount of time that would seem to make it impracticable.

Artificial seasoning becomes necessary when the local conditions do not admit of air seasoning or when time does not permit. The method of kiln drying may then be practiced, though naturally more particularly by the lumber dealers rather than the timber users. The large wood preserving plants which have cylinders for pressure treatment are using a system of steam pressure seasoning, which is very effective, but it is only used in connection with pressure preservative treatments.

### Preservatives.

If through proper seasoning the interior of the timber has been rendered practically free of conditions for the development of bacteria and fungi, all future attack becomes possible only through the entrance of moisture from without. If, then, the moisture entering the wood is thoroughly saturated with poisonous substances which inhibit the growth of bacteria and fungi, decay is effectively prevented. This is the basal idea of the preservative treatment. Many substances have been used as antiseptics for this purpose. At present there are four distinct kinds of substances used as wood preservers. First of all, coal tar distillates—creosote; second, poisonous salts of metals—zinc chloride, corrosive sublimate; third, crude oil; and fourth, wood tar distillates. These substances are far from being equally successful. They are mentioned here merely as the substances that are actually thought of today as possible preservatives. In some processes combinations of several of these substances are used. The American Railway Engineering and Maintenance of Way Association, in the proceedings of the fifth annual convention, page 68, states that the following processes have stood the test of time: Creosoting, zinc chloride with creosote, zinc chloride alone and zinc chloride with glue and tannin. The latter are added merely to fix the zinc chloride in the wood and prevent its being washed out. Corrosive sublimate also has been used and has proven itself very efficient, but its extremely poisonous effect upon high organisms makes it an objectionable substance. These substances are essentially antiseptics; that is, water that has come in contact with these substances inhibits the growth of bacteria and fungi.

The third class of substances, mineral oil or crude oil, has recently been thought of as a wood preserver, and a few experimental trials have been made. A record of results published by the American Railway Engineering and Maintenance of Way Association, volume 8, page 471, shows that crude oil does not effectively preserve wood except when used in sufficiently large quantities to exclude moisture from the wood. It is not a germicide.

The fourth class of wood preserving substances, distillates of wood tar, might be expected to be just as efficient as distillates of coal tar. Such is far from being the case. They have been offered to the public for many years, but they do not appear to have come into any extended use.

Of the substances that are admittedly good wood preservatives the tar oil distillates hold the highest rank. The mixture of tar oils known as creosote has been used as a preservative for such a great length of time that there is now no question as to its efficiency. However, it is a very complex substance and the question arises, "Are all of these components of equal value for purposes of wood preserving or are some of lesser and others of greater value?" An answer to this question was sought by means of analyzing timber that had successfully withstood decay for a long number of years, to determine which ingredients of the original creosote remained in the wood to preserve it. Such investigations were carried out by Charles Coisne in 1862 for the Belgian government; again in 1882 by S. B. Boulton for the London & Northwestern Railway; recently again by Gellert Allen for the United States department of agriculture, and by Von Schrenk, Fulks & Kammerer. The observations and conclusions of all these investigators agree in the following: (1) That the tar acids, such as carbolic acid, which formerly were considered to be the most valuable constituents of creosote, are soon lost, either washed out or evaporated from the wood, and hence do not serve permanently to preserve the wood. (2) Naphthalene and the low boiling oils are markedly evaporated from the wood during the early years of exposure. (3) The high boiling tar oils, notably the portions boiling from 270 degrees and upwards, are the substances that permanently remain in the wood. All investigators agree in pronouncing these high boiling oils the most valuable portions of creosote.

\*Abstract of paper read before the Southwestern Electrical and Gas Association at El Paso, Tex., May 7, 8 and 9, 1908.

For references in this connection see the "Preservation of Timber," by S. B. Boulton, published by D. Van Nostrand Company, New York; Circular 98 of the forest service, "Quantity and Character of Creosote in Well-Preserved Timbers," by Gellert Alleman; and reprint from Bulletin 93, American Railway Engineering and Maintenance of Way Association, "Changes Which Take Place in Coal Tar Creosote During Exposure," by Von Schrenk, Fulks & Kammerer.

The following approximations may be of interest here: Creosote as found in the market contains from 15 to 30 per cent of the high boiling oils. Also 30 to 60 per cent of the oil is lost by evaporation during the first 8 or 10 years of exposure, the loss being confined to the low boiling constituents, including naphthalene. For the most up-to-date detailed discussion on the grading of creosotes see Forest Service Circular No. 112, "The Analysis and Grading of Creosote," which has just been issued.

#### Action of Preservatives.

Opinions differ somewhat with regard to the theory of the action of these preservatives. Of course, all have agreed that the preservatives must be germicides, and hence that their action is to poison, or at least inhibit the growth of, bacteria and fungi by their mere presence. With such substances as zinc chloride or corrosive sublimate the mode of action is simple enough: The germicides dissolve in the moisture that enters the wood, forming a solution of the proper germicidal value. Wherever such moisture may penetrate bacteria and fungi cannot live. While this action is the only one possible with zinc chloride or corrosive sublimate, there is an additional one possible with oil such as creosote, namely, the utter exclusion of moisture.

If moisture is effectively excluded bacteria and fungi cannot grow, and hence it is not surprising to hear of the results recently reported by Mr. Faulkner of the Atchison Topeka & Santa Fe Railroad (see Volume 8, American Railway Engineering and Maintenance of Way Association, page 473). Fourteen ties were treated with California crude oil, the ties taking up from 4 to 8 gallons of the oil apiece. Crude oil has no germicidal power whatever, yet these ties laid in the experimental track on the Beaumont division of the Santa Fe, near Pelican, in 1902, are still in good condition. Of course, we must remember that from 4 to 8 gallons of oil per tie is a large amount and must close effectively all pores and openings so that moisture cannot possibly enter. Merely coating the surface of wood with what might be assumed to be an impervious coat is ineffective. This is shown by the comparative inefficiency of a coat of hot tar applied to timber, a procedure which, though known to be inefficient, yet is resorted to frequently by engineers and others who should know better. Recent experiments at the Wyoming experimental station (see Bulletin 75, Wyoming experimental station) show that posts that had been dipped in hot crude oil or in hot tar lasted slightly longer than untreated posts, but the tar did not protect as well as the crude oil. Yet, even soaking for 24 hours in crude oil is not economically efficient, as has been pointed out elsewhere above. While it is probable that in piles creosoted for marine exposure in which 20 or more pounds of creosote per cubic foot are injected, the action of the oil tending to exclude water does as much to preserve the wood as is due to its germicidal power, yet with creosoting for land exposure, by the Rueping process, in which not exceeding five pounds per cubic foot are left in the wood, the action is mainly or entirely germicidal. It must be remembered that in all these cases of creosoting for land exposure large central portions of posts and ties receive really no oil and yet decay does not set up in these portions, unless the surface is removed, exposing large portions of untreated wood, in which case decay will readily set in at these exposed places.

These facts lead to the conclusion that in most cases the detail of the preservative action is as follows: Moisture may enter through the layers containing the creosote, in a sense filtering through these portions, and saturate itself with the oil. The moisture is then strongly germicidal, a fact that has been ascertained by direct laboratory experiment by shaking up water with creosote oils. This moisture in its passage to inner untreated portions of the wood prevents decay. While moisture may actually enter the wood during wet seasons, it may just as readily pass out again, because the outer layer of the oil does not prevent evaporation, thus leaving room for other portions of moisture introducing in turn more of the preservative. Any slight quantity of moisture which may probably be present when the wood is treated may thus evaporate after treatment, and at some time or other be replaced by other moisture which contains the germicide. It is readily seen that with a layer of tar this action will not effectively take place. Moisture may enter through cracks in the tar, which cracks will be certain to occur, and hence the entrance of moisture cannot be prevented, yet such

moisture has little or no chance to absorb any of the tar. The evaporation of moisture, on the other hand, is effectively hindered because the surface in general is closed by the tar, and hence, under some conditions, an impervious coating of paint or tar may actually hasten decay.

The germicidal power of high boiling tar oils has scarcely been stressed enough so far. The quantity of oil which will dissolve in water, it is true, is exceedingly small, and hence the amount of the oil used up in the course of time is practically negligible, yet that small amount renders the water absolutely germicidal to a degree only attained by a comparatively large concentration of zinc or mercury salts.

We have, then, as the first important property of preservatives their germicidal power. Next to this comes their lasting power. Reference has already been made to the fact that portions of creosote, such as the tar acids, carboic acid, naphthalene and, in general, all oils boiling below 270 degrees, are either so readily volatilized, or are so readily dissolved in water, that they gradually disappear from the wood, hence it is primarily the high boiling oils which give creosote its value as a wood preserver, because besides being highly germicidal they are quite permanent. Zinc and mercury salts have their greatest defect in their solubility, on account of which they are readily washed out of the wood, particularly in wet localities.

#### Wood Preservers.

Besides the preservative substances above discussed there are on the market many of what may be called proprietary wood preservers. As far as I know none of them contains ingredients essentially different from those mentioned above. Of course, several of these substances may be variously combined. Depending upon the quality and the relative amounts of the ingredients these proprietary wood preservers may or may not be worth their price. Although the ultimate test of any wood preservative is the practical result it produces, yet chemical analyses properly interpreted by experienced parties, in my opinion, may be relied upon in judging the value of an article approximately justly. Hence, I would advise parties who contemplate the purchase of a wood preserver to ascertain the composition of the substance, and then judge its value with reference to the points discussed above, namely, its germicidal value and its power to resist atmospheric influences, considering in connection the amounts to be injected per cubic foot or per square foot surface.

It might be pointed out here that a wood preserver should not form an outer coating, but should soak into the outer layers of the timber. The statements made with reference to the efficacy of the four classes of substances previously discussed may serve as a basis for judging the value of the proprietary composition. Much valuable advice may be obtained in this connection from the United States forest service. The value of a certain brand lies mainly in the assurance it gives of furnishing uniformly the article it claims to furnish, and if everything else is favorable this assurance has a considerable market value.

It is unfortunate that the life of timber in its natural state and as treated by different preservatives cannot be definitely given, because so many factors enter into the determination of its life. There is first of all the kind of wood, then the season in which it is cut, the extent of seasoning or drying, and all the other special points which have been called the "idiosyncracies" of timber. Above all, the local climatic conditions determine the life of timber, so that it becomes almost impossible to make definite statements regarding the life of untreated timber, or of timber treated with different preservatives. However, if we have unusually favorable or unfavorable local climatic conditions, and remember that individual pieces of timber may show results differing considerably from the averages, then the following few statements based on a large number of observations may be ventured. Life of white oak and cedar ties, untreated, 10 years; inferior woods, such as tamarack, loblolly pine, etc., 4 to 5 years. Inferior wood ties treated as follows: Burnettizing, 12 years; creosoting, very light treatment, about 4 to 5 pounds per cubic foot, 16 years; 12 pounds creosoting, 20 years; 18 or more pounds creosote, 25 to 30 years. In addition the following, found by the railroads of the United States, may be considered as particularly reliable: Pine ties treated with zinc chloride, east of the Mississippi, 10½ years, west of the Mississippi, 11½ years; treated with creosote, even with light treatment, the life is greater than with zinc chloride. Reference has already been made to the fact that wood tar distillates and crude oil used in moderate quantities have not increased the life of timber to a satisfactory degree.

#### Quantity and Cost.

Considering next the quantity of preservative used and the cost of the operation, I may offer the following as general averages obtained in the operation of the large "pressure"

plants and as actual cost conditions, to which a reasonable amount of profit must be added before a commercial price can be arrived at. Cost of Burnettizing, 5 cents per cubic foot, or 15 cents per tie of 3 cubic feet. Cost of Wellhouse zinc tanning process, 6 cents per cubic foot, or 18 cents per tie. Cost of the zinc chloride-cresosote process, 9 cents per cubic foot, or 27 cents per tie. Cresosoting, light treatment, enough for 16 years life, 10 cents per cubic foot, or 30 cents per tie. Twelve pounds cresosote, 18 cents per cubic foot, or 55 cents per tie. Heavy treatment, enough for 30 years, 28 cents per cubic foot, or 85 cents per tie. The operating cost of large pressure plants is from 5 to 8 cents per cubic foot of timber. The efficiency of the pressure treatment using a sufficient quantity of a good cresosote is beyond question and needs no further comment. In some cases, for instance piles for marine exposure, nothing else will answer. It appears to be the conclusion of the railroads that pressure treatment is the most efficient. Doubtless this is partly due to the fact that they own and operate their own plants and operate on a large scale. The high price of cresosote led the railroads to try zinc chloride extensively. The substance is comparatively readily washed out of the wood, so that its use in moist regions is inadvisable. In dry regions it appeared to be serviceable, particularly because the ties are destroyed by wear and tear in about 10 years, and zinc chloride is able to prevent decay for this length of time. Since the introduction of tieplates and of the Rueping process, which uses only small quantities of cresosote, the tendency is to abandon zinc chloride treatment. I should add here that the use of zinc chloride for poles gives little promise of success, because the salt is so readily washed out.

Purchasers of treated timber are confronted with the same difficulties in a sense that they are confronted with in buying a commercial brand of wood preserver. In the first place, the word "treated" is entirely too vague—the details of treatment must be specified. In good pressure treatment the following amounts are injected: Zinc chloride, from ¼ to 1 pound per cubic foot of timber; cresosote, from 5 to 15 pounds per cubic foot (the latter is the maximum that should be asked for in land exposure). The zinc-cresosote process treats first with 12 pounds of 2 per cent zinc chloride solution per cubic foot, then allows the timber to dry for 10 days, and subsequently injects 3 pounds of cresosote per cubic foot. With the stipulation of the amount of injection should go the specification for the kind of cresosote.

The railroads have come to the conclusion that it is profitable to use the best cresosote only. Their standard specification for coal tar cresosote runs as follows:

Specific gravity at 38 degrees C., 1.03; no distillate below 200 degrees C.; up to 210 degrees not more than 5 per cent; up to 235 degrees not more than 25 per cent; residue beyond 355 degrees, if it exceeds 5 per cent in quantity, must be soft.

Purchasers should insist on being furnished with the statement of the tests on the cresosote with which the wood is said to be treated. But even with all the specific statements as to quantity and quality of the cresosote which has been injected, fraud is possible and has been practiced. Professor Allen of the United States forest service states that of 12 specimens cut from a consignment of piling guaranteed to contain 16 pounds of oil to the cubic foot of timber, some contained less than 3 pounds and none over 7 pounds. The writer has examined many samples of cresosote in the market, and has met some samples which would be little better than crude oil or wood tar distillates—they are nothing but low boiling oils with tar dissolved or suspended in them. The purchaser should take sample borings from the shipment and have them analyzed by a competent chemist to determine the quantity and quality of the cresosote or zinc present.

#### Application.

The open-tank method for the treatment of timber, which was developed recently by the United States forest service, has so far not been in practical use, and hence it is difficult to say whether or no it will be economically efficient. We pass then to the consideration of wood preserving by so-called superficial applications. These methods are usually not considered by the large users of wood which can use pressure treatment, because at first sight they seem to give little hope for success. Yet the unprejudiced observer must admit that the proper substances "superficially" applied add greatly to the life of timber.

During former years, when less was known about the causes of decay, absolute penetration was thought to be positively necessary to preserve the wood. Since absolute penetration was not always attainable, and the inner untreated portions of the wood remained intact, the views as to the necessity of complete penetration were gradually abandoned. The treatments, particularly with cresosote on account of its high price, became lighter and lighter. Yet, under these conditions, very few instances of absolute failure of cresosote preserving

have been cited. The penetration attained with pressure differs only in degree from that attainable without pressure. The question how little penetration will prove itself economically successful has not been experimented upon sufficiently to give a definite answer. Referring to the explanation for the mode of action of the preservative given above, it appears to be necessary that the treated layer of wood be so thick that any moisture passing into the wood during wet seasons may take up enough of the germicide to inhibit the growth of fungi. Naturally, the thickness of this layer should bear some proportion to the thickness of the timber. All things being equal, the deeper the penetration, the greater would be the protection. If the timber checks to a great extent openings may be made into the untreated portions and decay may enter there. This, of course, may happen even with cresosoted timber. In this connection it may be mentioned that whenever cresosoted timbers have to be cut so that untreated surfaces are exposed the workmen are directed to paint them with cresosote, a procedure which all users of cresosoted timbers have found very beneficial.

A preservative which is placed close to the outer surface of the wood is exposed more rigorously to wind and water and hence must withstand solution or evaporation to a remarkable extent. Thus material for superficial application will probably be more expensive; but the lesser cost of the application may counterbalance the additional cost. This procedure of superficial application has been in use for many years, but not until very recently have comparative tests been instituted to determine the comparative efficiency of different materials applied by dipping and brushing. (See United States Forest Service Circulars 104, 111 and 136 and Year Book of Department of Agriculture, 1905, page 455.) Hence we are not able to say anything with reference to the comparative economic value of superficial treatments and deep penetration treatments. I cannot refrain from referring again to the fact that either of these properly done differs only in degree from the other. On page 11, United States Forest Service Circular 111, we find the statement: "For small individual operators who cannot afford the cost of a large plant brush treatments are feasible and economical."

A few figures of cost for labor for superficial application may not be out of place here. From figures obtained by the United States forest service it is seen that the cost of painting the huts of poles for the length of six feet with as much of the preservative as the wood would absorb with two coats, the cost per pole is about 8 cents for labor. (See United States Forest Service Circular 136, page 18.) Cedar, chestnut and arbor vitae poles during this treatment will take up about 2½ to 3 pounds of tar oils per pole for 20 square feet surface. Ties may be dipped into a preservative liquid and allowed to remain there for a sufficient length of time to absorb from 2 to 6 pounds per tie at a cost of 3 to 5 cents per tie for labor.

Returning now to the question, "Does it pay?" I feel that I cannot do better than to quote two estimates furnished by the forest service, adding, however, that the estimates are exceedingly conservative, and could safely be made much more striking. A hemlock tie as furnished and laid in the track cost 75 cents. Its treatment in the railroad's own plant cost 12 cents. Using the formula,

$$r = R \left[ \frac{(1.0 p)^n \times 0.0 p}{1.0 p} \right] \div [(1.0 p)^n - 1],$$

in which  $r$  is the annual charge,  $R$  the initial expenditure,  $p$  the rate of interest and  $n$  the years of the recurring period, we find that the annual charge on the untreated tie with the assumed life of five years and interest at 4 per cent gives us 16.8 cents. For the treated tie, if it lasts only one year additional, the annual charge is 16.6 cents. This shows that the added life of a single year pays for the cost of treatment. Since zinc chloride treatment adds five years at least to the life of the tie, and since the annual charge for 10 years' time is 10.7 cents, we see that the treatment secures even a saving of 36.3 per cent on the annual charge.

The following is quoted from United States Forest Service Circular 136, page 30:

"Assuming the life of an untreated pole to be 12 years, its cost \$9.00 set in the line, the rate of interest on the investment at 6 per cent and the cost of the carbolineum brush treatment 45 cents, it is found that the treatment will have to add about one year to the life of the pole to pay for itself. The forest service considers that the treatment will add at least three years to the life of the pole. Even with these figures, which are high for the quantity and cost of material used, and extremely low for the added life, the treatment makes 200 per cent profit on its cost."

In conclusion I may safely say that the question "Does it pay?" has received such a positive affirmative answer that the real question confronting every timber user is: Which treatment is the most economical? This is a problem that every man must figure out for himself as given in the preceding examples. It is safe to say that future market conditions will add largely to the calculated profit.

**PRODUCER GAS FOR ENGINE USE: ITS MANUFACTURE AND CHARACTERISTICS.\***

BY W. B. TUTTLE, VICE-PRESIDENT AND GENERAL MANAGER SAN ANTONIO GAS & ELECTRIC COMPANY.

It is not my intention to go into the details of gas engine operation, except in so far as it is necessary to deal with the action of producer gas in gas engines. This paper is intended mainly to deal with gas producers.

Almost all gas producers follow the same general form. There is first a generator. This is usually a round shell, lined with fire brick, and provided with a grate near the bottom and a charging door at the top. To the generator is usually connected an economizer. The economizer is frequently in the form of a small boiler with tubes connected to the flue leading from the generator. The scrubber, usually connected to the economizer, is an iron shell, which is filled with checker work of coke or some other substance over which water is sprayed. To the scrubber is usually connected a tar extractor. This may be either a rotary tar extractor or one of the P & A type. In the latter type the gases pass through holes in a plate, and impinge on the surface of another plate. Again, simply a box filled with shavings may be used. Some producers also have a purifying box in which oxide of iron is used to remove the sulphur from the gas. This, however, is not common.

There are various modifications of the generator part of the producer. Different styles of shaking grates have been used, and in some cases down draft is used instead of an up draft. There are two general types of producers in use: (1) Positive pressure producers, (2) suction producers.

The positive pressure producer receives its air supply from a blower; usually either a centrifugal blower or a Koerting steam blower. The producer works under pressure all the time, and the gas, after leaving the tar extractor, is conveyed to a small holder or gas tank, from which it is supplied to the engine. The suction producer, as its name implies, is not under pressure at any time, and this producer is connected direct to an engine without an intervening holder, and the air necessary for combustion is drawn into the producer by the suction of the engine.

**Method of Operation.**

In either type of producer the method of operating is about as follows: The generator is filled with fuel in some form, either coke or coal, and when this fuel has been ignited air is supplied to the fuel bed, usually from below. This air passes into the incandescent fuel bed, and combustion immediately takes place. Most of the air unites with the carbon from the fuel and burns to carbon dioxide, so that at the top of the zone of combustion almost all the air has been formed into carbon dioxide and nitrogen. The fuel bed, however, is deep and the carbon dioxide and nitrogen have to pass through additional incandescent fuel. In this passage the carbon dioxide is converted into carbon monoxide, the nitrogen remaining unchanged, so that we have emerging from the top of the fuel bed a gas composed of carbon monoxide and nitrogen. This is the theoretical result if air only is used, and if all the carbon dioxide is converted into carbon monoxide in the fuel bed. As a matter of fact, however, in most producers the fuel bed becomes so hot that the ash and fuel form clinkers, unless some means is taken to prevent it. Most producers are therefore arranged so that steam generated in the economizer can be introduced into the fuel bed along with the air. This steam helps to keep the fuel bed below the temperature at which clinkers form readily, but the steam in passing through the fuel is decomposed and carbon monoxide and hydrogen are both formed, together with some carbon dioxide.

As will be explained further on, the formation of hydrogen has an important effect on the operation of an engine running on producer gas. The fuel itself contains more or less moisture, and this also adds to some extent to the formation of hydrogen. Besides this, particularly where bituminous and lignite coals are used, there is a certain amount of volatile matter driven off of the fuel, and a part of it passes over in the gas in the form of methane, while some is condensed out as the gas is cooled in the form of tar. This tar has been one of the serious obstacles which has confronted those that have attempted to use lignite or bituminous coals for producer gas, but it may, however, be satisfactorily extracted by passing the gas through a tar extractor.

**Fuel.**

Almost all kinds of coal can be successfully used in gas

\*Abstract of paper read before the Southwestern Electrical and Gas Association, El Paso, Tex., May 7, 8 and 9, 1908.

producers. The following results taken from a report of the testing plant of the United States geological survey would indicate the relative values of Illinois and Indian Territory coals and Texas lignite:

**Analysis of Fuel.**

	Illinois.	Indian Territory.	Texas.
Moisture (per cent) .....	12.43	5.00	33.50
Volatile matter (per cent) .....	32.65	36.51	32.34
Fixed carbon (per cent) .....	45.70	19.98	23.80
Ash (per cent) .....	9.22	8.51	10.36
Sulphur (per cent) .....	1.41	1.43	0.63

**Analysis of Gas by Volume.**

	Illinois.	Indian Territory.	Texas.
Carbon dioxide (per cent) .....	9.72	8.25	11.10
Oxygen (per cent) .....	0.12	0.11	0.22
Carbon monoxide (per cent) .....	15.12	19.39	14.43
Hydrogen (per cent) .....	9.98	7.69	10.54
Methane (per cent) .....	6.00	4.92	7.48
Nitrogen (per cent) .....	59.06	59.65	56.22

**Coal Consumed in Producer.**

	Illinois.	Indian Territory.	Texas.
Pounds per hp. per hour per e. hp. at switchboard—			
Coal as fired .....	1.76	1.77	2.98
Coal, dry .....	1.55	1.69	1.99
Combustible .....	1.38	1.53	1.68
Pounds per hp. per hour per b. hp. at engine—			
Coal as fired .....	1.50	1.50	2.54
Coal, dry .....	1.31	1.43	1.69
Combustible .....	1.17	1.30	1.43

**Gas Produced.**

	Illinois.	Indian Territory.	Texas.
Cubic feet, standard, per pound consumed in producer—			
Coal as fired .....	51.1	51.6	28.4
Coal, dry .....	58.4	54.1	42.7
Combustible .....	65.3	59.4	50.6
British thermal units per cubic foot of gas .....	151	159	169

These figures show that Texas lignite can be used to advantage in gas producers.

**The Effect of Hydrogen.**

In the operation of gas engines using producer gas it is extremely desirable to keep the amount of hydrogen at a minimum. This can readily be accomplished where a positive blower producer is used; the steam can be added just in sufficient proportion to take care of the fuel bed, thus keeping the amount of hydrogen at a minimum. In the suction type of producer, where the load varies, it is extremely difficult to prevent having an excess of hydrogen in the gas at times, and much of the trouble that has been experienced in the operation of small gas engines equipped with suction producers comes from this source.

Hydrogen and carbon monoxide both have approximately the same calorific value—about 320 British thermal units per cubic foot. Carbon monoxide, however, when it burns, forms carbon dioxide, while hydrogen burns to water. The temperature of a gas engine is such that this water invariably leaves the engine in the form of steam, carrying with it a large amount of latent heat. This heat so lost amounts to about 15 per cent of the calorific value of hydrogen. Besides this, hydrogen gas burns very quickly, while carbon monoxide burns slowly. As a result of this it is impossible to set the igniter, on an engine using producer gas containing a large proportion of hydrogen, at a point where the greatest efficiency can be obtained. If the igniters are set "early" enough, so that the carbon monoxide will be completely burned up in the explosion, the hydrogen will be exploded too quickly, while if the igniters are set at a point where the hydrogen explodes at the proper time, the carbon monoxide will not be entirely burned up before the exhaust valves are opened, and, as a consequence, it will pass out burning through the exhaust valves and into the exhaust pipe. The result is a loss in economy in the engine and, furthermore, the exhaust valves and pipes are burned out.

These troubles are particularly noticeable in engines running on suction producers because the per cent of hydrogen in the gas varies with the load on the engine, and it is very difficult to set the igniter so as to get fairly economical results. As a matter of fact, a gas may be very high in heat units, and yet it may be impossible to put full load on the engine on account of a high per cent of hydrogen.

The troubles resulting from the presence of a large amount of hydrogen in producer gas have led up to the in-

vention of a method of operation in which, instead of a jet of steam introduced under the fuel bed to keep down the temperature of the fuel, a part of the exhaust gas is returned and so introduced. The exhaust gas is composed principally of carbon dioxide and nitrogen. The mixture of the air and exhaust gas passes into the hot fuel bed and the carbon dioxide which is thus introduced takes the place of the steam. Carbon dioxide unites with the carbon in the fuel and forms carbon monoxide. In this process heat is taken up and compensates in part for the heat given off, as the air and fuel burn to carbon dioxide, so that the fuel bed is kept at such a low temperature that the fusion of ash and the formation of clinkers does not take place.

The following analyses show the difference in the gas made in this way and ordinary producer gas:

(The mixture of air and exhaust gases entering the producer includes: Carbonic acid (CO<sub>2</sub>), 3.3 per cent; oxygen (O<sub>2</sub>), 18.9 per cent; carbonic oxide (CO), 0.1 per cent.)

**Analysis of Supply Gas (Per Cent).**

	Using exhaust gases.	Ordinary system.
Carbonic acid (CO <sub>2</sub> )	1.8	5.8
Oxygen (O <sub>2</sub> )	1.2	1.3
Carbonic oxide (CO)	26.2	19.8
Hydrogen (H <sub>2</sub> )	0.4	15.1
Marsh gas (CH <sub>4</sub> )	0.7	1.3
Nitrogen (N)	69.7	56.7
British thermal units per cubic foot by gas calorimeter (high value)	103.7	136.0

**Results.**

As a result of this method several advantages are gained. In the first place, the igniters of the engine may be properly timed for the complete combustion of the carbon monoxide, and thus the greatest economy can be obtained; second, very little energy is lost through the latent heat carried off when steam forms at the time of the explosion; third, the gas leaves the producer at a lower temperature, and less water is required in the scrubber, and less heat is lost from the producer; fourth, the economy of the engine may be very largely increased by increasing the compression. The compression of the engine may be raised up from 140 pounds, which is about the maximum that is used in ordinary practice, to 200 pounds, and not only is the efficiency of the engine very materially improved, but the capacity of the engine is also increased. Certain tests have been made showing that an increase of 38 per cent in efficiency was gained, and that 25 per cent increase in load carrying capacity was also gained. It might be well here to call attention to the fact that this process is patented and the patent is held by the Combustion Utilities Company, 60 Wall street, New York.

The following is a record showing the results obtained on the same engine, which in one case was run on ordinary producer gas, and in another case on gas made without the presence of steam, and with the exhaust gas introduced:

**Data and Results of Economy Tests.**

	Exhaust gases used.	Ordinary system.
Date of test, 1906—	March 28-29.	April 5-6.
Duration, hours	25.5	14.05
Total time engine was running, hours	25.5	13.17
Maximum brake horsepower developed	110.5	99.8
Minimum power developed, horsepower	50.0	7.6
Average brake horsepower developed for engine period	102.5	78.7
Average brake horsepower for running period	102.5	84.1
Total weight of dry coal consumed, pounds	2,927.0	1,988.0
Total ash and refuse, pounds	391.0	317.0
Percentage of ash and refuse in dry coal	13.5	15.9
Weight of dry coal per hour, pounds	114.8	141.5
Dry coal consumed per brake horsepower per hour, pounds	1.12	1.8
Combustible consumed per brake horsepower per hour, pounds	0.97	1.51

The reliability of the service of gas engines operating on producer gas has been established, but in this connection it is well to call attention to the fact that all gas engines require greater care on the part of the operators than do steam engines. Steam engines, if they are supplied with steam and oil, will run in some sort of fashion as long as the load is not so great as to stall them; but gas engines will not run at all unless every part is in good working order, and, while careful attention should be given to a steam plant, it must be given to a gas engine plant.

**IMPOSSIBILITY OF DIVISION OF OPERATING EXPENSES ACCORDING TO TENTATIVE CLASSIFICATION.**

Accompanying the uniform letter to the interstate commerce commission criticizing Accounting Series Circular No. 20, published in the Electric Railway Review of May 2, 1908, page 529, was a circular from the Indiana and Ohio lines represented at the meeting in Indianapolis on April 14. This letter, signed by Joseph A. McGowan, secretary of the meeting, contained the following:

After a very thorough discussion of the following paragraph of the American Street and Interurban Railway Association's circular—"It is suggested, in order to develop the practicability and application of the proposed classification to the electric railway industry, that each company subdivide its 1907 operating expenses among the proposed accounts, in as approximate an estimate as time and convenience will permit"—the consensus of opinion was that in endeavoring to comply with this request it was found that the subdivisions could not be made with any degree of accuracy; that over one-half the apportionments would be mere estimates and that to be of real value to the interstate commerce commission the figures should be correct. To arrive at an accurate distribution would necessitate such an enormous expenditure of labor and time that it could not be correctly made within the period required.

One of the largest interurban railways of Indiana made an extraordinary effort to subdivide its operating expenses in accordance with the classification contained in Circular No. 20, and after devoting such time to the task, found that only 72 of the 116 accounts could be used; that 95 per cent of the operating expenses was contained in 35 accounts and that the remaining 5 per cent was distributed over 37 other accounts. It was further shown that out of the 72 accounts used the figures for 42 of these had to be estimated. The subdivisions in many cases amounted to only one-tenth of 1 per cent, and in some instances to one-hundredth of 1 per cent.

Rather than render an unreliable division of operating expenses to the interstate commerce commission it was unanimously

Voted, That the secretary of the meeting communicate with Prof. Henry C. Adams, in charge of statistics and accounts of the interstate commerce commission, Washington, D. C., and advise him that after an earnest effort to do so, the representatives of the interurban railways of Indiana and Ohio find it impossible to correctly subdivide their operating expenses for 1907 among the proposed accounts with any degree of accuracy within the allotted time, and that in their opinion it would be misleading to the commission and fail in its object and purpose to furnish any figures which did not represent actual results. It was further

Voted, That a copy of this resolution be also forwarded to the American Street and Interurban Railway Association.

**PAY-AS-YOU-ENTER CAR TRIED IN DES MOINES, IA.**

The Des Moines City Railway has been conducting an experiment of the pay-as-you-enter type of cars with one of its standard cars, of which the rear platform has been rebuilt to conform to the new method of fare collection. The tests will be made both with and without a 3-arm turnstile in the entrance passage.

The platform is eight feet long and is arranged similarly to other pay-as-you-enter cars, having an exit passage 24 inches wide and an entrance passage 36 inches wide. The turnstile is placed in front of the conductor's railing and registers all passengers. The conductors are also supplied with the Rooke automatic register and fare collector. The entrance door to the car body swings inward. The exit door slides toward the center of the bulkhead and is operated by the conductor by means of a lever. Passengers may enter the car by the front platform and may stand there but will not be permitted to stand on the rear platform until all the seats in the car are occupied.

It is announced that if the experiment proves successful all of the company's lines will be equipped with pay-as-you-enter cars within a year.

The Mankato Electric Traction Company opened for traffic on May 1 its 5-mile street railway in Mankato, Minn., which has been under construction since July, 1907.

**STEAM TURBINE DEVELOPMENT.\***

BY PROF. J. C. THORP, UNIVERSITY OF ILLINOIS.

Among the noteworthy facts that impress themselves upon the mind of the investigator of the development of steam turbines is the very close resemblance of the earliest types to many of the present-day machines that are proving such efficient prime movers in our power stations of both large and small capacity.

The principal difficulties in design and construction were early recognized. From the earlier days designers have endeavored to reduce the energy losses to a minimum and it is this desire that inspires present-day designers who have brought the steam turbine to the prominent place which it occupies in the list of prime movers. The energy losses, mentioned with their approximate values, may be classified as follows:

	Per cent.
Friction between the steam and the metallic surfaces, both stationary and moving	10
Friction due to eddy currents	5
Resistance to the rotation of moving parts in the atmosphere of steam, called "windage"	6
Mechanical friction in journal bearings, glands, stuffing boxes, etc.	5
Leakage through clearance spaces, glands, etc.	3
Radiation loss, residual velocity in exhaust	4

**Performance.**

In 1902, after very careful consideration of the steam turbine problem, the then Commonwealth Electric Company of Chicago purchased the first 5,000-kilowatt machine that was built. It is worthy to note that the turbine, unit No. 1 in the Fisk street station of the present Commonwealth Edison Company, was the result of the first effort that had ever been made in this country to build a machine of this type larger than 600 kilowatts. The 600-kilowatt turbine mentioned was a 2-stage horizontal Curtis machine, installed in 1901 in the shops of the General Electric Company at Schenectady, N. Y. It is a compliment to the engineers and management of the General Electric Company, who built and installed this first larger unit, that they planned and built so well and confidently at that time.

The writer has been privileged during the past two years to conduct tests on three of the units in the Fisk street station of the Commonwealth Edison Company. A brief summary of the results of these tests is presented in the following table:

Operating Conditions.			
Comparative Results—Best Performance.			
Nominal rating of machine, kilowatts	5,000	5,000	8,000
Load—			
Gross output, kilowatts	6,137	5,970	10,156
Per cent normal rating	1.25	1.20	1.25
Water rate—			
Observed kilowatt-hour	23.85	16.56	12.94
Corrected for "contract conditions"	23.94	16.72	13.07
Observed electric horsepower-hour	17.89	12.42	9.71
Corrected for "contract conditions"	17.96	12.54	9.80
Initial pressure, pounds	176.6	174.0	176.0
Vacuum observed, inches	28.10	28.0	29.17
Vacuum, 30-inch barometer, inches	28.52	28.30	29.50
Superheat, degrees F.	139.0	184.0	147.0
First stage pressure, pound gauge	5.66	24.8	46.7
Normal speed, revolutions per minute	500	500	500

Accompanying curves, Figure 1, present the relative steam economies of these three units in a very interesting manner. It will be seen that the scale of the vertical ordinate, representing "water rate," is continuous, thus giving a direct comparison of the units, all values of the steam economy having been reduced to the basis indicated. Another notable feature is the flatness of the load curve for unit No. 8. It is noticeable in No. 4, but less markedly, and the tendency to give a wide range of economy with a considerable range of load is hardly perceptible in the first unit. It is difficult to say what the results would have been in the latter case had the load been increased to 75 per cent overload, as in the case of No. 8. These curves serve better than words to illustrate the remarkable development in the design and operation of large turbine units of this type during the past five years.

Figure 2 presents the steam economy of Westinghouse-Parsons units of various rated capacities, under the actual operating conditions. It is significant that the curve of water rate of the 400-kilowatt unit coincides with the curve of the 5,500-kilowatt machine up to their normal capacities. Both

machines were operating under similar initial and final pressures, but the small unit was supplied with steam superheated 100 degrees, whereas the initial steam for the large machine was saturated.

It is exceedingly important that accurate means be secured for reducing the performance to a common basis for purposes of comparison, whether various types and sizes of units are involved, or the agreement of actual performance with guarantees in contracts is in question. For these purposes "performance curves" should always be determined which will present the variation in economy due to changing conditions of vacua, superheat, pressure, etc. Typical "performance curves" are shown in Figure 3. Most significant of these curves and most worthy of special mention is the "initial pressure" curve, which demonstrates the utility, from the standpoint of economy, of increasing the initial pressure much above 140 pounds gauge. Up to this point the inclination of the curve is quite marked, and the advantage of increasing pressures as a means of reducing water rates very apparent. Beyond this point the curve tends to become more nearly parallel to the pressure co-ordinate, indicating an advantage, and that a somewhat questionable one, only in gaining capacity. This deduction is in accord with numerous investigations recently conducted, which have resulted in a diminishing of enthusiasm for high initial steam pressures. It will be of interest to mention that the government engineers in charge of the steaming tests of the United States geological survey have also advanced the proposition that lower steam

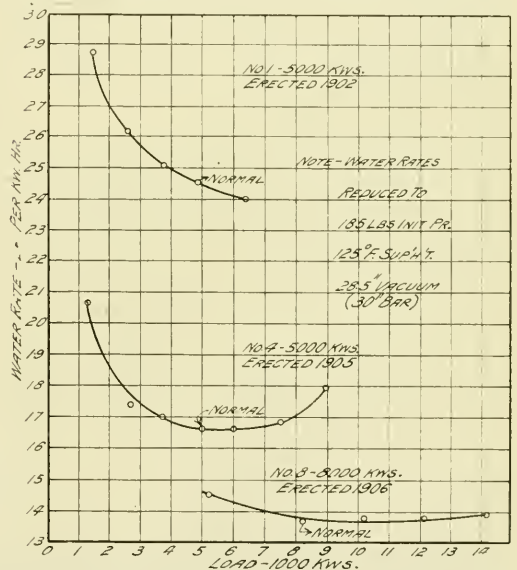

Turbine Development—Figure 1—Economy Curves for Curtis Units of Three Sizes.

pressures and high degrees of superheat will be found desirable and economical in the operation of steam prime movers.

**Small Turbines.**

Before passing from the consideration of steam economy it will be well to consider examples of the numerous smaller machines that are attracting attention. Among the turbines of this class that have appeared quite recently are the Kerr, the product of the Kerr Steam Turbine Company of Wellsville, N. Y.; the Sturtevant, recently perfected by the B. F. Sturtevant Company; and the Terry, built by the Terry Steam Turbine Company of Hartford, Conn. These small machines are all of the multi-stage impulse type, the Kerr applying the principle of the Pelton wheel and all of the others mentioned being modifications of the Riedler-Stumpf pattern.

**Low-Pressure Turbines.**

A number of plants have been installed more or less recently that have employed low-pressure turbines as prime movers, which are operating on the exhaust steam from reciprocating engines in the same station. By this means great economy is effected in the use of the steam, and a saving

\*Abstract of paper presented before the Western Society of Engineers, Chicago, May 6, 1908.

of practically 65 per cent may be effected by the use of a high-vacuum condensing equipment. Practically all of the builders of turbines of large capacity have developed a low-pressure turbine, and these are playing a prominent part in the design of power plant extensions. One of the prominent installations of low-pressure turbines is in the power station of the Philadelphia Rapid Transit Company. This machine is an 800-kilowatt Curtis turbine unit, operating on the exhaust from Corliss engines and utilizing a vacuum of 28 inches. The guarantee provides that the steam consumption per kilowatt-hour shall not exceed 36 pounds at full load, and 40 pounds at half load. Tests that have been made indicate a water rate well within the guarantee. Tests made in the shops of the Westinghouse company upon a 1,250-kilowatt low-pressure unit have resulted in a water rate of 30 pounds per brake horsepower-hour, this being the equivalent of approximately 38 pounds per kilowatt-hour.

**Heat Efficiencies.**

The Willans-Robinson Company of England recently entered into a contract for the construction and erection of a 3,000-kilowatt unit. This contract contained a performance guarantee clause, stipulating a water rate of 12.9 pounds per kilowatt-hour. This is equal to the best performance of the 8,000-kilowatt Curtis turbine.

We are fast approaching the limit of economy in the prime mover itself, and future developments must be looked for in the performance of the boilers. It is significant that practically the same rated boiler capacity was installed for the first 5,000-kilowatt unit in the Pisk street station of the Commonwealth Edison Company of Chicago, as six years later was installed to operate the 9,000-kilowatt units. This points to developments in boiler practice as well as to remarkable advances in the large turbo units.

**Boiler Economy.**

In most plants the steam-driven auxiliaries do not furnish enough exhaust steam to heat the feed water above 120 degrees F. The possibility of increasing economy by using hot feed water has been taken advantage of in some cases by the installation of economizers. Other engineers have taken steam from the second or third stage of the turbines to increase the feed water temperature, and this without suffering a deleterious effect in economy.

In a recent article before the American Institute of Electrical Engineers, J. T. Findlay presented a very interesting

horsepower, instead of 10, as now used. Experiments such as are now being made, of which the one cited is a good example, foreshadow the design and operation of larger boiler units, the reconsideration of generally accepted theories regarding heat transmission through boiler heating surface, and the redesign of boiler settings that have been standard for years. There must be a constant striving for better evaporative performance—for a decrease in the radiation and unaccounted-for losses in boiler practice—if this factor in power plant development is to keep pace with the modern prime movers.

**Rating of Steam Turbines.**

An inspection of curves suggests a very significant fact pertaining to the rating of steam turbines. The maximum steam economy is obtained at loads varying from 115 to 130 per cent of the rated capacity of the units, and no considerable increase in water rate occurs at 150 per cent of the normal rating. This is in direct contrast to the conditions

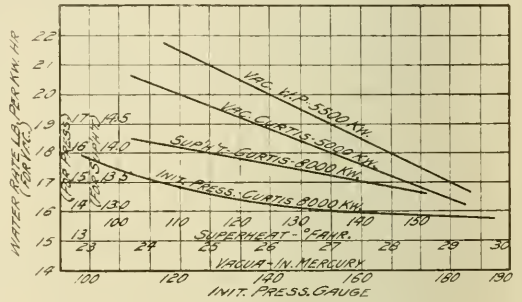

**Turbine Development—Figure 3—Performance Curves.**

which obtain in reciprocating engine practice, where increasing the load above the normal rating or point of maximum economy brings about a marked increase in the water rate. The reciprocating units are designed to sustain a certain overload for a period of time, usually 50 per cent for two hours, but it is obvious that this maximum capacity should not form the basis for normal rating. In the light of these facts a change is being effected in the system of rating turbines, and it will not be long until such rating will be based upon the continuous maximum operating capacity instead of upon a normal load basis of the turbines, and generators will be installed capable of such continuous operation. It will be seen that this will not present a radical departure from the practice which now obtains with reference to some prime movers, such as gas engines or water turbines, where the best performance occurs at points of maximum capacity, and where guarantees of performance seldom contemplate any considerable overload capacity.

In conclusion it should not be said or inferred that the steam turbine is supplanting the steam engine in the broad field of the latter's usefulness, nor that the days of the "old reliable" are numbered. Certain it is, however, that for electric generation for all purposes, particularly in large units, the steam turbine of the past decade has proven its superiority.

**Where Electric Locomotives Gain.**

Each ton moved, whether of useful trailing load or of locomotive weight, costs a certain amount of money. If the locomotive weighs 150 tons and the train consists of, say, five cars, aggregating about 250 tons, then the useful car ton mileage will be only 62.5 per cent of the total. Take an actual case: On the New York Central line, between the Grand Central terminal and North White Plains, each steam locomotive moved each day an average of 25,620 ton-miles. Of this total 12,960, or 51 per cent, were locomotive ton-miles and 12,660, or 49 per cent, were useful car ton-miles. With electric operation each locomotive moves each day 33,210 ton-miles. Of this 11,700, or 35 per cent, are locomotive ton-miles, and 21,510, or 65 per cent, are useful car ton-miles. These figures plainly show the great saving of non-revenue bearing ton mileage which is made possible by the use of the electric locomotive.—Electric Trunk Line Gate.

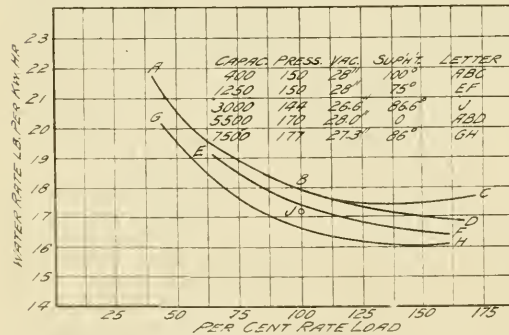

**Turbine Development—Figure 2—Economy Curves for Westinghouse Units of Three Sizes.**

discussion of experiments with double stoker boilers in the power plant of the Interborough Rapid Transit Company of New York City, made under the general supervision of H. G. Stott, superintendent of motive power of the Interborough company. These boilers were 500-horsepower units, set with two Roney stokers, one as in the standard setting and the other at the rear at a somewhat lower level. The horizontal baffling was so arranged that the gases from both stokers intermixed and traversed the same passes over the heating surface. This increase in volume of gases, with the resultant higher velocity, effected an increase in capacity of 80 per cent, with no appreciable difference in over all efficiency.

This suggests what is very much discussed, namely, the possibility of securing a greater amount of work from our boilers. It leads to the prediction that we are rapidly approaching the point when we will be able to rate water tube boilers on a basis of five square feet of heating surface per



## PARKS OF THE GRAND RAPIDS RAILWAY.

The problem of conducting a summer amusement park as a successful money-making venture has been satisfactorily worked out by the Grand Rapids Railway Company at its two parks, Ramona and North park, near Grand Rapids, Mich. In round numbers the two amusement resorts represent an outlay of \$250,000, and, according to Louis J. DeLamater, manager of the resort properties, the returns on the investment are entirely satisfactory to the company.

Ramona, which covers an area of 23 acres and which has been called "The Coney Island of the Middle West," is situ-



Grand Rapids Railway—Ramona Pavilion.

ated on Reed's lake about three miles from the heart of Grand Rapids and is reached by three of the company's lines. The park is a part of the village of East Grand Rapids, which has about 1,000 population. Besides a large pavilion containing a summer theater, refreshment booths and a Japanese restaurant, a large number of concessions are located about the grounds. There is also one of the largest ball parks in

built a few years ago to replace an old one which was burned. It is a wooden and steel structure, 182 by 203 feet, open on three sides, and represents an investment of \$50,000.

The theater, stage and auditorium occupy nearly three-fourths of the entire structure and 1,200 persons may comfortably attend a performance. The stage has a 40-foot opening, is 38 feet deep and 68 feet wide and is equipped with all modern stage improvements. The electric lights are supplied with current by the Grand Rapids-Muskegon Power Company of Grand Rapids. The vaudeville acts are booked from selections offered by the Western Vaudeville Association and are of a high class. The prices for admission to the auditorium, which contains 18 boxes besides regular theater chairs, are 10, 20 and 30 cents at the evening performances and 10 and 15 cents at matinees, except on Sundays and holidays, when evening prices prevail. At the rear of the auditorium is a board partition about four feet high, over which persons may view the performance free of charge. The theater is flanked on one side by an ice cream parlor and on the other by the Japanese restaurant. These concessions are separated from the theater by clouded glass partitions.

In the rear of the theater is a large resting room, open on three sides, and provided with benches. A small cigar and tobacco stand and a candy stand occupy a small portion of this room. On one side of the pavilion is a long veranda with benches.

Around the pavilion "on the circle" are the following concessions: "Figure Eight," laughing gallery, "Ye Olde Mill," roller rink, miniature railway, photograph gallery, shooting gallery, "Razzle Dazzle," Japanese ball game, box ball alleys, moving picture theater, circle swing, together with candy stands, soft drink booths, popcorn stands, etc. The railway company owns the roller rink.

Leading from the main steps of the pavilion a concrete walk runs to the boat landing, where electric launches, row-boats and steamboats await. On the shore of the lake is the fine new building of the Colonial Club, one of the most exclusive clubs maintained by Grand Rapids society. There are benches scattered here and there along the lake shore in front of the pavilion, the building itself being upon a small elevation. To the east of the pavilion is a small concert garden conducted by private parties, where vaudeville shows are held. Several social clubs also have fine homes at the resort. All parts of the grounds are open and no admission



Grand Rapids Railway—Pavilion and Boat House at North Park.

the middle west and a large picnic ground. Boating, bathing and fishing are among the attractions offered.

The grounds of the railway company are located on the north shore of Reed's lake, which is about 1½ miles long and 1 mile wide. In the rear of the grounds is Fisk lake, about ½ mile across in either direction. The two lakes are connected by a small channel. On the other side of Reed's lake is Manhattan beach, a bathing and picnic resort, not controlled by the railway company, which is reached by two steamers and electric launches.

The pavilion at Ramona is practically new, having been

whatever is charged to the resort. No liquor is sold on the grounds and the village council strictly enforces the Sunday liquor law in the whole village.

To the south of Ramona pavilion is the railway company's large baseball park, Ramona Athletic Park, which is used regularly by the Central and Grand Rapids baseball leagues and at other times by picnickers. A charge of \$15 per day is made for the park. In cases where large picnics are held this \$15 is usually refunded to the organization giving the picnic in some kind of a donation. The grounds and grand stand represent an outlay of \$25,000 and about 6,000 persons

can be comfortably seated in the grand stand and on the bleachers. At the west of this is the picnic ground, occupying about two acres. There is another small picnic ground to the north of Ramona pavilion.

Among the features promised for the season which opens May 16 is a miniature Panama canal, built by Fred Kempf of Grand Rapids. This is a model operated by complicated machinery and shows the work along the canal, the cities, the ocean and steamships, the railroad trains, etc. There will also be an aerial cable railway, a "devil's slide," something on the order of the "figure eight" roller coaster and a "human laundry." It is promised that the bookings at Ramona this season will be of a higher class than usual. The summer programme includes balloon ascensions and several feature days, such as toy hunts, fairyland nights, Venetian nights, animal hunts, Teddy bear day and Japanese night. Already arrangements are under way for several big picnics to be held this season.

The fare to the lake from any part of the city is five cents and it can be reached from any point in Grand Rapids within half an hour.

North park, the company's other resort, is located about six miles north of the city on the Grand river. It is served by the Wealthy avenue and Taylor street line, which connects it with Reed's lake, passing through the city and near the Michigan Soldiers' Home, which is about one-fourth of a mile from the park. The park may be reached from Reed's lake in about half an hour for a 5-cent fare. North park occupies about four acres of ground and represents an investment of about \$50,000. It contains a pavilion 85 by 160 feet, the boat-house of the Grand Rapids Boat and Canoe Club, and a 2-acre picnic ground. In the pavilion are refreshment parlors, a boat livery and a large dance hall. Balloon ascensions and band concerts are held frequently during the summer.

Considerable traffic is also derived by the railway company from John Ball park, a municipal park located west of the city.

#### SECURING PUBLIC GOOD WILL BY BULLETINS.

The Portland (Ore.) Railway Light & Power Company has begun publishing a series of bulletins in the daily papers of the city which are designed to secure the good will of the public by pointing out what efforts the company is making to give good service and explaining the difficulties which are involved in street railway operation. Bulletin No. 1 deals with the subject of "Kicks" and presents the case in such an excellent manner that we publish it in full, as follows:

The Portland Railway Light & Power Company is a public service corporation and we realize that the most valuable asset a public service corporation can have is the good will of the public. We are trying to be candid and sincere in all our dealings with the public and with the city, and we frankly admit that we shall consistently strive to secure and maintain the good will of the people of Portland.

It is an important part of our business to run a street railway and to run it efficiently. We feel that we can do more, ordinarily, by attending to our business than by entering into discussions or explanations.

The secret of getting along with the other fellow in this world is to have a better understanding of his troubles. The man who is the sharpest critic is often the best friend when he understands the other fellow's job.

Comparatively few people realize the difficulties of modern street railway operation. When anything goes wrong, everybody notices it; whenever everything goes right, nobody notices it.

We want to have everything go right and everybody to notice it. We feel that we are making friends with the people of Portland, and that our efforts to give the best service possible are being appreciated. This is not the accomplishment of a day, but the result of grinding work and large expenditures for some years past, and we desire to show the public what we have done and are doing for the improvement of the service; what problems we meet with daily, and some of the methods which would be mutually helpful and beneficial to the railway company and the public.

You may take this fact as assured, that it will not be possible to remove all sources of complaint. There is the amiable gentleman who kicks at home and growls all day at his office.

We cannot expect to escape him between time. He will probably kick at the publication of these articles. But, leaving him out of the question, it is still plain, from the nature of the business, that there will frequently be unavoidable troubles and inconveniences.

We carry a large portion of the population of Portland twice a day. Counting the transfers, people step up and down from the cars 320,000 times a day. The street cars of Portland pass backward and forward through crowded streets, covering about 29,000 miles, or one and one-quarter times the circumference of the globe, in a single day. There will always be accidents under these circumstances. Then, too, the conductor's lot is not a happy one. He has to collect money from people of all sorts and dispositions. He alone is expected to keep his temper, and it is his duty to do so. If he does not, upon proper complaint, he is disciplined, and perhaps discharged. We endeavor to secure the highest class of employes. We are proud of the character and courtesy of our men, and we believe that, as a body, they have not their superiors in the country. Still, they are only human, and they make mistakes. Many a reasonable kick will necessarily be registered against us. The unreasonable kicks come hard. We feel that we can do away with many of them if the public understands the street car business a little better. We want to present to you a series of articles discussing some of the problems, together with a statement of how we are meeting them.

As for the reasonable kicks, we want to hear them. They help us. We realize that we can best serve ourselves by serving you. An outsider can sometimes suggest remedies for existing conditions which have escaped the men engaged in the detail of the work. Suggestions are solicited.

If, by telling you our story, you will understand us better, and the spirit of mutual helpfulness will be advanced, we shall feel that our work has been well done. We welcome honest criticism, particularly if it is good-natured.

#### REPORT ON ELECTRIC RAILROADS IN PENNSYLVANIA.

The annual report of the bureau of railways of the state of Pennsylvania for the year ended June 30, 1907, has been submitted to the governor by James H. Craig, superintendent of the bureau. The total capitalization of the street railways of the state is given at \$464,553,942; total capital stock outstanding, \$144,890,438; total funded and unfunded debt, \$79,439,443; total cost of roads and equipment, \$225,798,775.

Figures showing the increases for the year, as compared with 1906, include the following:

Capital stock outstanding .....	\$29,231,020
Funded debt outstanding .....	19,541,702
Current liabilities .....	7,797,888

Capitalization and current liabilities .....	\$56,570,620
Cost of road and equipment .....	\$41,905,336
Stocks and bonds of other companies owned .....	13,586,174
Cash and current assets .....	1,857,468

Total assets .....	\$57,348,978
Gross earnings from operations .....	\$ 2,911,331
Income from other sources .....	646,502

Total income .....	\$ 3,558,260
Operating expenses .....	\$ 2,787,061
Taxes .....	79,861
Interest on debt .....	595,979
Rentals .....	426,165
Other expenses .....	176,682
Dividends .....	259,013

Total .....	\$ 3,968,397
Miles of single track and branches operated .....	264.53
Length of all tracks operated .....	304.20
Total number of cars .....	690
Total number of employes .....	3,396
Total compensation .....	\$2,093,537
Total passengers carried, including transfers .....	87,935,058
Capital stock outstanding .....	\$33,255,019
Funded and unfunded indebtedness .....	2,692,219
Cost of road and equipment .....	28,112,956
Income through rental of road and other sources .....	1,294,882
Dividends paid .....	2,004,210

## RECENT ELECTRIC RAILWAY LEGAL DECISIONS.

BY J. L. ROSENBERGER, LL. B., OF THE CHICAGO BAR.

**Company Not Liable for Injuries to One Passenger Caused by Another Giving Signal to Start.**

*Wagner v. New York City Railway Company*, 107 New York Supplement, 807.—The supreme court of New York, appellate term, says that the question upon which this case turned was: By whom was the signal given that caused this car to start after it had stopped and while the plaintiff was in the act of alighting? The defendant's testimony was that the bell to start was given, not by the conductor, but by "a young man standing on the back platform," who "rang the bell twice and the car went ahead," who got off the car before the conductor got to the back platform. This testimony was not rebutted, stood absolutely uncontradicted, and was the only testimony in the case on either side as to the cause of the car's starting while the passenger was alighting. Under such circumstances a verdict for the plaintiff could not stand. How could negligence of the defendant be predicated upon the unauthorized act of this passenger? Certainly the motorman, in receiving the signal and starting his car, was not guilty of an act from which negligence could be deduced.

**Duty of Pedestrian Walking on Track.**

*San Antonio Traction Company v. Kelleher*, 107 Southwestern Reporter, 64.—The court of civil appeals of Texas says that a pedestrian usually is expected to take the sidewalk, when not crossing the street, a part of the street generally dedicated to the use of those traveling over it on foot. Conditions, however, may be such as may induce him to exercise his right to walk along that part over which the car track is laid. But when he does this he has no right to prevent those in the exercise of their right to travel in street cars of the convenient and speedy mode of transportation for which street railway companies are designed by walking in front of an approaching car, and thereby limit the speed of the car to that made by him in walking. In such event it is his duty, if he is where he can safely do so, to step aside and let the street car go on at its usual speed. It is true that the one operating the car cannot run him down if he sees that he is not going to leave the track; but the court apprehends that the company is not without the right to have him removed and kept off the track until its car passes.

**Motormen Must Keep Close Lookout and Give Warning at Crossings—Concealment of Headlight by Dust.**

*Zalotuchin v. Metropolitan Street Railway Company*, 106 Southwestern Reporter, 548.—The Kansas City court of appeals says that the plaintiff's evidence abundantly sustained the charge that the bell was not rung as the car approached the crossing, and that the motorman was negligently inattentive to the track ahead of him. Whether the rate of speed at which the car was running was 25 or 30 miles per hour, as the testimony of the plaintiff's witnesses would seem to indicate, or was only 10 or 12 miles per hour, as stated by the witnesses for the defendant, the fact remained that the motorman was operating a powerful and dangerous vehicle along a public thoroughfare where others had a right to be, and, in the exercise of reasonable care, could not approach a crossing where he had reason to anticipate the presence of vehicles and pedestrians without keeping a close lookout and without giving warning of the presence of the car.

But the assertion of the driver of a wagon that when he looked just before starting the car was not visible, for the reason that it was at that time more than a block away, and, on account of its great speed, was raising a cloud of dust in front of it which totally obscured the headlight, was too absurd to merit serious consideration. It could not have been more than 100 feet away, even had it been going at top speed,

and the contention that a swiftly moving vehicle under ordinary conditions of wind and weather will throw up a cloud of dust in advance of it is a proposition in physics beyond the comprehension of reasonable minds. Such evidence goes for naught against the plain physical facts of the situation.

**Duty at Stations.**

*Birmingham Railway Light & Power Company v. Landrum*, 15 Southern Reporter, 198.—The supreme court of Alabama says that the place where the injury occurred in this case was at a station, where the cars were in the habit of stopping for persons to get on and off the train. Under such circumstances the carrier owes them a duty, that while making their egress they be not struck by other passing trains, and, while a passenger is not struck from the duty of exercising care for his safety, he has a right to presume that the tracks intervening between the place where he is to alight and the station will be kept safe while he is crossing; so that the mere fact that he fails to look and listen for an approaching train before attempting to cross will not, as a matter of law, be ascribed to his contributory negligence, and will not prevent a recovery of damages if he is struck by such a train. Again, the court says that a passenger may alight from a slowly moving street car. A passenger car, within a very short distance of a station, is likely to be discharging passengers, and it would be culpable negligence for another car operated by the same company upon the same highway, to run at full or very rapid speed.

**Injury to Man Stooping Over in Way of Car to Unload Wagon—Duty of Motorman—Assumptions—When No Car Has Passed in 15 Minutes.**

*Volosko v. Interurban Street Railway Company*, 82 North-eastern Reporter, 1090.—The court of appeals of New York says that the plaintiff was struck by an electric car while he was standing on the hub of a wagon, engaged in unloading blocks of marble from the wagon, which was standing near the track, the distance between the rail and the hub of the rear wheel being five or six inches. While the jury would have been authorized to find the defendant guilty of negligence, was the evidence strong enough to permit it to find the plaintiff free from contributory negligence? The court thinks not, because he knew that he was in a place of danger, and it was his duty to exercise some care for his own safety; yet he took no care whatever. While he had a right to stop his wagon where he did, temporarily, for the purpose of unloading, his rights were subordinate to those of the railroad company, which had the right of way. He had no right to obstruct travel upon the railroad, and it was his duty to get out of the way when a car came along so as to let it pass.

The plaintiff had no right to assume that there was no danger because no car had passed for 15 minutes, as the longer the interval without a car the stronger the probability that one would come along at once. He stood for 5 or 10 minutes so near the track of a street railroad as to be within reach of a passing car, without once looking to see or listening to hear whether one was coming, and the court thinks he was guilty of negligence as matter of law, even if his duties required him to stoop over so that looking or listening was not as easy as if he had been in an upright position. The law required him to use ordinary care, such as a person of average prudence would use under like circumstances.

Assuming, without deciding, that the plaintiff had the same rights as a street sweeper, for instance, still he could not keep his eyes upon his work all the time and not look, listen or observe any caution of any kind for his own safety without so contributing to the injury he sustained as to defeat a recovery of damages. The case was properly nonsuited.

# News of the Week

## Brooklyn Subway Extension Opened.

The extension of the Interborough subway from the terminus of the East river tunnel at Borough Hall, Brooklyn, to the Atlantic and Flatbush avenue station of the Long Island Railroad was opened for traffic on May 1. The new branch serves three stations in Brooklyn and connects the Manhattan lines with the extensive system of the Long Island Railroad. The opening of the new line was made the occasion of elaborate celebration in Brooklyn and a banquet was held in the evening at the Union League Club, at which officers of the company and city officials made speeches. August Belmont, who financed the construction of the subway, was the guest of honor. After reviewing the development of transportation facilities since the days of the horse car, he said in part:

"Today we are at a standstill because we have become unreasonable in our hostility and are sapping the life out of our transportation lines with increasing taxes and hostile legislation. You will say 'What is the remedy?' I can't tell you what it absolutely is, but I can tell you what I think will effect a cure. Standardize your traction securities by permitting them before they do anything else to make a profit. Limit it fairly so that the investor has unflinching confidence in its securities and then let the city take its compensation in a surplus in lieu of all taxes and any and all state and municipal charges. Until you bring about something of this nature you have reached the point where the increase in transportation facilities in New York, but more particularly on Manhattan island, is liable to remain practically checked. I feel, however, that we are on the road to a clearer and better understanding, and I cannot but believe that the coming year will see a beginning of a new and important move toward very much greater transportation facilities."

## Aid by the United Railways & Electric Company in Reconstruction of Baltimore.

Bulletin No. 10 is the conclusion of the remarkable series which has been published by the United Railways & Electric Company of Baltimore. This bulletin states in part:

"When in February, 1904, the business section of our city lay in ashes; when the 'calamity howlers' said that the city was as a city of the dead; that its business and commerce would pass to more favored cities, and that our working population would seek homes elsewhere, what was then the policy of our company?"

"It was the hardest hit of any enterprise in the city. The great flames had swept into the Pratt street power house; the feed and trolley wires in the burnt district lay in twisted masses on the streets; the company's main offices were destroyed, and its whole clerical force was without official home. Inside of 12 hours the company's cars were running through the unburned section, and, as quickly as the streets were cleared, wires were strung and the company's cars followed.

"The company not only responded quickly to the need of transportation service at the time, but the fire was hardly out before its directors developed large and more comprehensive plans than ever before for the improvement and restoration of the street car service and for leading in the restoration of the city. These plans have been steadily pursued.

"Since the fire the company has expended for the general betterment of the street car service, for the reconstruction of tracks with heavy grooved rails, for the purchase of large, commodious cars, for extensions, for conveniently located car houses, for building, rebuilding and equipping power houses and for other betterments which would increase the efficiency of service, over \$10,000,000."

## Strike Threatened in Cleveland.

Immediately after assuming control of the Cleveland street railway lines on April 28 the Municipal Traction Company found itself involved in difficulties with its employees on the question of wages. President A. B. du Pont announced that the former employees of the Cleveland Electric Railway would be paid the same scale as had been paid to the Forest City men, 22 cents an hour for the first year, 24 for the second and 25 for the third and thereafter, an increase of one cent an hour over the Cleveland Electric scale, and that they would be given one uniform a year free, but no free transportation.

The men refused to be satisfied with the increase, saying that the loss of free transportation while in uniform was not compensated for by the 1-cent increase, and demanded the fulfillment of the agreement made by the Cleveland Electric Railway on December 26, 1906, that, in case the company

secured a renewal of its franchises from the city a scale of 23, 25 and 26 cents would be put into effect at once. The Cleveland Electric men also considered that they were unfairly treated because the Forest City employees were in many cases given a preference of runs. Mr. du Pont had followed the plan of arranging the men according to seniority and giving a Cleveland Electric man the first choice, a Forest City man the second, etc.

Mr. du Pont refused to abide by the Cleveland Electric agreement, saying that the Cleveland Electric Railway was not operating the property and that he had been assured by Mr. Goff and other lawyers at the time of the settlement that it was not binding on the Municipal company. The dissatisfaction of the men was further increased by the discharge of about 50 men on charges of dishonesty, breaches of discipline and for refusing to collect fares from fellow employees.

On Friday night a meeting of the union was held and the executive committee was authorized to call a strike if the increase was not granted by Sunday morning. On Saturday and Sunday several conferences were held between representatives of the union, Mayor Johnson, President du Pont and members of the state board of arbitration. Mr. du Pont refused to recognize the agreement in any way and the mayor endeavored to conciliate the men by promising an increase as soon as it had been demonstrated that the earnings would justify it. On Sunday it was agreed to appoint an arbitration committee, consisting of one man selected by the company, one by the men and a third by the first two, to determine whether the agreement was binding. Mr. du Pont wished to have the general question of wages, rather than the validity of the agreement, passed upon by the arbitration committee and declined to appoint an arbitrator until a meeting of the directors could be held.

The union then presented an ultimatum that if the company's representative were not appointed by 2 p. m. Tuesday the strike would be declared Wednesday morning, but on Tuesday it was decided to await a meeting of the directors, to be held on Wednesday or Thursday.

The suburbs outside of Cleveland are up in arms because the 3-cent fare is made effective only within the city limits. As reported in last week's issue, Mayor McQuigg of East Cleveland was put off a car for refusing to pay a 5-cent fare and the village brought suit against the company. The suburb's claim is based on the franchise granted to the Cleveland Electric Railway in 1906, which, it is claimed, specified a 5-cent fare to the center of Cleveland or such rate of fare as may be charged on the Euclid avenue line. Since the settlement the Euclid avenue line is operated at a 3-cent fare. Residents of Lakewood, Collinwood and Corlett protested because they were obliged to pay a 5-cent and sometimes an 8-cent fare to Cleveland, and plans are being made to attack the company's franchises.

President du Pont has announced that transfers would be received from the printers and put in use this week. A charge of one cent will be made for transfers. The officials of the company have been at work on extensive plans for re-routing some of the car lines as soon as the transfers are received.

F. H. Goff, who represented the Cleveland Electric Railway in the negotiations leading to the settlement, has declined election as chairman of the board of directors of the Municipal company.

**Dashboard Destination Signs Replaced.**—At the request of the city council the Portland (Ore.) Railway Light & Power Company has replaced the dashboard destination signs, displaying the initial letter of the name of the line, which were recently removed from the cars.

**Elevated Road Consolidation in Chicago.**—Another attempt is being made to bring about the consolidation of the elevated railways of Chicago with the possible ultimate intention of including in the combination the Commonwealth Edison Company. Samuel Insull, president of the latter corporation, has undertaken to carry the negotiations to a conclusion.

**Racine Franchise in Dispute.**—Burr Jones, an attorney of Madison, Wis., who has been retained by the city of Racine, Wis., to investigate the status of the franchise of the Milwaukee Light Heat & Traction Company, has rendered an opinion that the company's franchise in Racine expires on May 27. The company claims that the franchise is indeterminate.

**St. Paul-Seattle Air Line Declared Fraudulent.**—According to press reports from Seattle the St. Paul Minneapolis & Seattle Electric Railroad, which was incorporated several months ago to build an air line third-rail electric railway from St. Paul to Seattle, and which has been disposing of large amounts of stock at bargain prices, has been prohibited

from circulating its alluring advertising literature through the mails by the postoffice department at Seattle on the ground that the promoters of the company are not financially responsible. W. C. Webber of Minneapolis is president of the company.

**Tirey L. Ford Acquitted in San Francisco Franchise Case.**—Tirey L. Ford, general counsel of the United Railroads of San Francisco, was acquitted on May 2 of the charge of having bribed a supervisor to vote for the company's overhead trolley franchise. This is the second time Mr. Ford has been acquitted on similar charges. Several other indictments remain to be tried.

**Protest Against New York Rapid Transit Bill.**—Several civic organizations of New York have asked Mayor McClellan to disapprove of the Robinson bill, recently passed by the state legislature, which permits the granting of franchises for subways to private corporations. The principal objection urged against the bill is that it provides for an alternative to municipal ownership.

**Increase of Wages on New York Suburban Lines.**—Justice Morschauser of the New York supreme court has issued an order authorizing the receivers of the Yonkers Railroad, the Westchester Electric Railroad and the Tarrytown White Plains & Mamaroneck Railway to increase the wages of their conductors and motormen approximately 15 cents per day. The employees were made a party to the application of the receivers for permission to increase wages.

**Convention Committee Visits Denver.**—The joint committee of the American Street and Interurban Railway Association and the American Street and Interurban Railway Manufacturers' Association, appointed to determine the date and the place for holding the next annual convention, has been visiting Denver this week to confer with the Denver Convention League and to investigate the facilities afforded by the city for the convention as compared with other cities which have extended invitations to the associations.

**American Society for Testing Materials.**—The eleventh annual meeting of the society will be held at the Hotel Traymore, Atlantic City, N. J., Tuesday to Saturday, June 23 to 27, 1908, inclusive. The congestion of the programme in past years, necessitating parallel sessions, has led this year to the extension of the time of the meeting from three to five days. By this arrangement it is hoped that the necessity of holding sessions concurrently will be avoided, and that provision may be made for periods of recreation and special social features. Since the last annual meeting the membership has risen from 925 to 1,005.

**Interborough Rapid Transit Company Sustained in Tax Decision.**—The New York appellate division, third department, on May 6 rendered a decision sustaining the claim of the Interborough Rapid Transit Company that it is exempt from special franchise assessments. The company appealed from the action of the state board of tax commissioners in assessing the special franchises at \$9,000,000 for the year 1905, on the ground that it was exempt from this class of taxation under the provisions of the rapid transit act, under which the subways in New York City were constructed and are now operated by the Interborough company.

**Toronto Section American Institute of Electrical Engineers.**—The regular meeting was held April 24 in the engineering building of the University of Toronto. H. W. Price of the University of Toronto presented a paper on the oscillograph, showing by means of slides the essential characteristics of manufacture and operation. Slides were also shown of oscillograph records of current and voltage taken on the occasion of sundry operations with direct and alternating current motors. A number of oscillograph records taken on the lines of the Ontario Power Company at Niagara Falls were then shown and explained by Mr. Johnson, assistant engineer of that company.

**W. R. Willcox on New York Public Service Commission.**—William R. Willcox, chairman of the New York public service commission of the first district, addressed the City Club of Chicago on Monday of this week in regard to the work of the New York commission. Mr. Willcox expressed himself as heartily in favor of state regulation of public utilities and stated that the commission had been very successful in New York in bringing about improvements in service. He said that the fact that companies are required to seek the commission's permission before issuing additional securities has been of great value to the companies because its authorization of an issue, based on a thorough investigation of a company's condition, provides a sort of guarantee that the securities are amply protected. Such matters as rate regulation, he said, could be handled more profitably by a com-

mission than by the state legislature, because the latter had neither the time nor the familiarity with the subject requisite for proper decision. In regard to the plans for the proposed subway in Chicago Mr. Willcox said that the city should build the subway itself and lease it to an operating company, but if the city was unable to finance the construction a franchise might be granted to a private company, with a reservation of the right of the city to purchase the property after 25 years.

**The Alternating-Current Commutating Motor.**—Dr. Charles B. Steinmetz delivered an address on alternating-current motors before the Ithaca section of the American Institute of Electrical Engineers on April 17. There were 250 students and instructors present. Dr. Steinmetz discussed the various types of the alternating-current commutating motor, explaining the difficulties of commutation in such motors. He pointed out that compensation for the reactance and transformer voltages involved was a complicated problem and showed the latest inventions and devices for insuring satisfactory commutation at various loads and speeds.

**New York Railroad Club.**—The next regular meeting of the New York Railroad Club will be held at the building of the United Engineering Societies, 29 West Thirty-ninth street, on Friday evening, May 15, 1908, at 8 o'clock. The technical paper of the occasion will be presented by Alexander Crawford Chenoweth, his subject being "Reinforced Concrete with Special Regard to Its Use in Railroad Work." This paper was arranged for in response to requests from a number of members of the club, and in view of the experience and knowledge of the author as an expert, an interesting and instructive evening is anticipated. All interested in the topic are invited to attend and participate in the discussion.

**Pittsburg Wage Controversy Submitted to Arbitration.**—The fear of a strike of the car men employed by the Pittsburg Railways Company, which was threatened when the company announced a decrease of one cent an hour on May 1, has been averted by the appointment of a third arbitrator to consider the question. Two arbitrators were appointed several weeks ago to decide on the wage scale for the coming year, but they failed to select a third. Following the notice of the decrease issued on May 1 representatives of the company and the car men held a conference and decided on Judge J. J. Miller of the Allegheny county court. The other two members of the board of arbitration are M. K. McMullin, representing the company, and Calvin Wyatt, representing the union. The decrease has been postponed until May 9 and both sides are pledged to abide by the decision of the board.

**Controversy over Car License Fees.**—The city of Chicago and the Chicago & Oak Park Elevated Railroad are engaged in a controversy over the payment of car license fees. On Monday of this week the company sent a check for \$4,800 to the city collector as payment of the \$50 fee on 96 cars in regular use. The check was returned with a demand for payment on the company's entire equipment of 163 cars and a threat that if the amount were not paid within three days the company would not be allowed to use the Lake street bridge. Clarence A. Knight, president of the road, promptly returned the check, stating that the company's franchise only required it to pay on the cars in regular use and that the question is now in litigation before a master in chancery. The city council committee on track elevation has under consideration an ordinance compelling the company to elevate its tracks from Fifty-second avenue to the city limits.

**No Federal Arbitration of Chester Strike.**—The commissioner of labor and Martin A. Knapp, chairman of the interstate commerce commission, have announced that they have no authority to appoint a board of arbitration under the Erdman labor law to settle the strike of the motormen and conductors of the Chester (Pa.) Traction Company. Representatives of the strikers went to Washington last week to ask for such a settlement, but after a conference on May 1 it was decided that the federal government has no jurisdiction in the case because the company is chartered under the street railroad act of Pennsylvania, although its tracks extend to Wilmington, Del. Governor Stuart of Pennsylvania has stated that he has no jurisdiction in the matter except to preserve peace as far as possible by sending the state militia to Chester. President Rigg of the Chester Traction Company has declined to arbitrate, saying that the reduction of wages from 18½ to 16½ cents an hour was made necessary by the decrease in earnings. The cars are being run on schedule but are carrying few passengers.

Recent statistics prepared by a committee of the Master Car Builders' Association show that over 60 per cent of the removals of wheels were for flange wear or flange failures.

# Traffic and Transportation

# Construction News

## Traffic on Washington Baltimore & Annapolis Line Exceeds Expectations.

Traffic on the Washington Baltimore & Annapolis Electric Railway since the formal opening of the line has exceeded all expectations. That this situation exists is a great tribute to the attractiveness of the electric service, which must meet the competition of the numerous steam railway trains operated between Baltimore and Washington. Up to this time the Washington Baltimore & Annapolis road has operated cars on an hourly schedule between Washington and Baltimore, but it is now expected to increase the service so that a car will be run every half hour between Baltimore and Washington between the hours of 6:30 a. m. and 7:30 p. m., beginning on May 10.

### Fare Announcement.

The Waverly Sayre & Athens Traction Company of Waverly, N. Y., has made the following announcement:

"Commencing on May 1, 1908, one fare of five cents will transport a passenger to any point in the village of Waverly, N. Y., and the boroughs of Athens, Sayre or South Waverly, Pa., with the privilege of one transfer. A special commutation ticket will be sold by the conductors, 44 tickets for \$2.00, good for transportation between the hours of 5:30 and 7:30 a. m. and 5 to 7 p. m., with transfer privilege. One of these tickets will transport a passenger to any point on the line in the four towns. Transfers must be asked for at the time fare is paid to the conductor. These rates of fare compare favorably with those in the largest cities in the country, it being possible to ride nine miles for five cents."

**Freight Handling in Montreal.**—The council of the board of trade of Montreal has decided to urge the city council of that city to grant to the Montreal Street Railway the privilege of handling freight in the streets under such restrictions as would prevent interference with passenger business or the ordinary street traffic.

**Transfers Limited in Philadelphia.**—The board of directors of the Philadelphia Rapid Transit Company has issued an order stating that on and after May 18 the company will issue free transfer tickets only upon the payment of a 5-cent fare and only at the time the 5-cent fare is paid, when requested by the passenger.

**Complaint Regarding Freight Rates.**—The New York public service commission, second district, has been asked to investigate the freight rates charged by the United Traction Company of Albany between Albany, Troy, Watervliet and other near points and by the Electric Express Company. The commission has served a copy of the complaint upon the companies and has asked them to answer within 20 days from April 28.

**Philadelphia Rapid Transit Company Handling Milk Traffic.**—Under the provisions of the trolley freight bill passed by the last legislature of Pennsylvania the Philadelphia Rapid Transit Company has begun the operation of a car to carry cans of milk. The car starts from Doylestown, Pa., at 6:24 a. m. The rate charged is 12 cents for a 30-quart can. The rate charged by the Philadelphia & Reading Railway, a steam road, is 15 cents for a can of the same size.

**Elevated Road Traffic in Chicago.**—The Northwestern Elevated Railroad of Chicago carried a daily average of 103,569 passengers in April, 1908, an increase of 13,434 over the corresponding month of last year. The South Side Elevated Railroad carried a daily average of 117,889 passengers in April, an increase of 14,753 over the corresponding month of last year. The Metropolitan West Side Elevated Railway carried a daily average of 146,638 passengers, a decrease of 9,627 from April, 1907.

**Hearing on Coney Island Fare.**—At the inquiry before the New York public service commission, first district, on April 27, regarding the 10-cent fare charged by the Brooklyn Heights Railroad to Coney Island, testimony was offered by Howard Abel, comptroller of the company, to show that the road lost \$141,769 in the operation of its lines in 1907 and that a reduction of the fare from 10 cents to 5 cents would add to the annual loss. Mr. Abel said that the larger part of the territory through which the lines of the company extend is unsettled and that the average number of passengers carried per car is small. He said that if the company averaged 50 passengers per car between terminals it could afford to carry passengers the entire distance for 5 cents and would make an annual profit of over \$230,000.

## FRANCHISES.

**Baltimore, Md.**—The right of the Maryland Electric Railway Company to use the tracks of the Baltimore & Ohio Railroad in entering Baltimore with its interurban line without securing a terminal franchise has been sustained by the board of estimate. The company was authorized to lay tracks on Russell street for a distance of three blocks. A park tax of 9 per cent amounting to \$65 per year will be paid for the privilege.

**Brooklyn, N. Y.**—The New York & Queens County Railway Company has filed notice of intention to extend its line from its tracks on Jackson avenue, in the borough of Queens, opposite the bridge plaza of Blackwell's Island bridge, and thence along the bridge plaza and approach across the bridge to the borough of Manhattan.

**Calgary, Alberta, Can.**—P. A. G. Roderique has applied to the city council for a franchise to operate a street railway in Calgary.

**Farmingdale, L. I.**—The Nassau county supervisors have granted the Huntington Railroad Company an extension of time to May 1, 1909, for beginning work on its line along Main street, Farmingdale, a county road, and until May 1, 1910, in which to complete the road under the franchise granted by the board on November 3, 1906. The road will be a cross island route from Huntington to Babylon, L. I.

**Littleton, Colo.**—Pending the passing of a franchise ordinance the town council of Littleton has granted permission to the Denver & South Platte Railroad Company to construct its line through that town, work on which will be started immediately. The road later will be extended to Roxbury Park and Colorado Springs. W. E. Hughes of Denver is president.

**Oakland, Cal.**—It is stated that the San Francisco Oakland & San Jose Railway Company will apply for a franchise for the extension of its lines to Twelfth and Union streets, where a station will be erected.

**Piedmont, Md.**—A 50-year franchise has been granted to the Potomac Valley Railway Company for the operation of its proposed interurban line in Piedmont, where the headquarters of the company are located. Louis Trabe and others of Wheeling, W. Va., are interested. (Noted April 11.)

**Portland, Ore.**—The F. B. Holbrook Company has applied for a franchise to construct and operate a single-track electric railway in Portland from East Thirtieth and Alberta streets north of East Thirtieth street to Ainsworth avenue and through the Irvington Park addition, six blocks. It is understood that this will be part of the Portland Railway Light & Power system and that transfers between the two lines will be exchanged.

**Springfield, Mass.**—The Springfield Street Railway Company has secured franchises for spurs on Hickory street, on State street at Federal street and on State street at the Highland brewery, all being for the purpose of establishing a trolley freight business.

## RECENT INCORPORATIONS.

**Cochise County Electric Railroad.**—Incorporated in Arizona to build an electric railway from Bisbee to Douglas, Ariz. Capital stock, \$500,000. Incorporators: James S. Douglas, W. H. Brophy, M. J. Cunningham, M. J. Brophy and George H. Neale.

**Indianapolis Frankfort Delphi & Chicago Traction Company, Frankfort, Ind.**—Incorporated in Indiana to succeed the Frankfort Delphi & Northern Traction Company, which was incorporated in January, 1907, to build an electric railway from Frankfort, Ind., to Chicago, Ill., by way of Delphi, Monticello, Monon and Hammond. The new company will improve the water power at Monticello, which will be used to generate power for the operation of the proposed line. Capital stock, \$100,000. W. H. Cohee, Frankfort, Ind., was vice-president and general manager of the earlier organization.

**Oklahoma-El Reno Interurban Traction Company.**—Incorporated in Oklahoma to build an interurban railway from Oklahoma City to El Reno. It is stated that work will be started immediately on the construction of the line. Capital stock, \$2,000,000. Incorporators: Howard M. Hyatt, A. M. Spencer, Stephen Brown, Joseph Brown and J. A. Stevenson, all of Oklahoma City.

**Valley Power Company.**—Incorporated in Oregon to construct an electric railway from West Woodburn through Monitor to Scott Mills and on to Willhoit Springs, Ore. It is stated that work will be started this month. Capital stock, \$100,000. Incorporators: Frank Robertson, Charles H. Carey and William S. Turner of Portland, Ore.

**Wheeling & Western Traction Company, Cleveland, O.**—Incorporated in Ohio to operate street railways in Ericsville, Dennison, Bridgeport, Cambridge, Stenbenville, Zanesville, Belleaire and Louis Mills, O. Capital stock, \$1,000. Incorporators: A. Evans Townsend, T. H. Bierbach, Josiah Wolf, Nathan Fronsline and Herbert Goldpaden.

#### TRACK AND ROADWAY.

**Alabama Railway & Electric Company, Opelika, Ala.**—It is reported that this company proposes to build an electric railway from Opelika to Eufaula, Ala., 55 miles. Judson C. Chapman of Atlanta, Ga., is interested.

**Belleville & Pinckneyville Traction Company.**—It is reported that this company has practically completed its surveys and estimates and proposes to begin construction at an early date on its proposed line from Belleville to Pinckneyville, Ill., 46 miles. The officers are: President, L. D. Turner, Belleville; vice-president, C. R. Hincke; secretary, George F. Meade; treasurer, J. A. Hamilton, Marissa Ill.; chief engineers, Harpe Brothers, East St. Louis, Ill.

**Bennington & North Adams Street Railway, Hoosick Falls, N. Y.**—It is reported that this company will expend \$100,000 for repairs and improvements on its line.

**Birmingham (Ala.) Railway Light & Power Company.**—An interlocking plant has been established at the crossing of the Louisville & Nashville Railroad tracks at First avenue and Twenty-ninth street in Birmingham.

**Connecticut Company, New Haven, Conn.**—The Massachusetts railroad commission has approved the route and the method of construction for the proposed line from Hartford to Middletown, Conn. The directors have voted not to build the line this year but the preliminary work will be disposed of as far as possible. Most of the right of way has been secured. (Noted May 2.)

**Crown Point, Ind.**—Herman E. Sasse writes that the business men of Crown Point have secured a 50-foot right of way from Crown Point to Gary, Ind., 11 miles, which they are ready to donate to any company which will build an interurban railway connecting either Gary or Hammond and Crown Point before May 1, 1910. The property is held by three trustees, John Brown, W. G. Woods and H. E. Sasse, who also have a franchise over the Lake county highways. The county commissioners have appropriated \$7,500 for the construction of a concrete bridge over the Little Calumet river at Crown Point, which could be used by an electric line. The Gary & Hobart Electric Railway and H. W. Seaman have applied for the right of way.

**Drake's Branch, Va.**—It is reported that surveys are being made for an electric railway from Drake's Branch on the Southern Railway, via Charlotte Court House, to a connection with the Virginian Railway.

**Greenville & Carolina Railway, Greenville, N. C.**—This company has been organized to build an electric railway from Asheville to Greencastle, N. C., 70 miles. At a meeting held last week officers were elected and it was decided to begin construction in August. The contract will be awarded to the Carolina Construction Company. T. E. Smith is president and L. W. Walker secretary and treasurer.

**Huron (S. D.) Gas & Electric Railway Company.**—This company is making surveys for its proposed line from Huron to Aberdeen, S. D.

**Interstate Consolidated Street Railway, Attleboro, Mass.**—It is reported that this company has let a contract to Eveline Brothers of Attleboro for the construction of an extension from Thacher street to Washington street, South Attleboro.

**Jeanette Montclair & Woodland Traction Company, Washington, D. C.**—A stockholders' meeting has been called for May 12 to reorganize this company, which proposes to build an electric railway from Woodland to Brawley, Cal. Construction is to be started this summer. A contract for grading and excavation has been awarded to John Hahwood of Brawley and work is to be started this summer. The officers are: President, Albert Mollizal; vice-president, Ladd Veitt, Tulsa, Okla.; treasurer, Bruce Clark, El Reno, Okla.; secretary and manager, A. E. Culley, 407 Hudson street, New York, N. Y.

**Kansas City (Mo.) Railway & Light Company.**—Work on

the extension of the Tenth street line is nearly completed. The track has been laid, the overhead work is in progress and it is stated that the line will be in operation in a few days.

**Kansas-Colorado Power & Railroad Company.**—A. B. Hulit, representing the Northern Electrical Company of Madison, Wis., is seeking to interest several towns in the Arkansas Valley in a project to construct a large electric power system serving the entire valley and an electric road connecting Canyon City, Pueblo, Rocky Ford and La Junta, Colo., with Dodge City, Kan. It is proposed to erect a large power plant near Canyon City.

**Lake Erie & Youngstown Railroad, Youngstown, O.**—It is reported that financial arrangements have been made for building this proposed line from Youngstown to Conneaut, O., 60 miles, and that 75 per cent of the right of way has been obtained. John H. Ruhlman is president and George Tod, Jr., is chief engineer. (Noted September 7, 1907.)

**Louisville (Ky.) Railway.**—It is reported that this company is considering a plan to extend the Okolona line to Washington, Ky., 16 miles. T. J. Minary is president and general manager.

**Little Rock & Hot Springs Electric Railway, Little Rock, Ark.**—L. Garrett, vice-president and general manager, writes that conditions are favorable for beginning construction within 90 days on the proposed line from Little Rock to Hot Springs, Ark., 56 miles, including three miles of city line in the two cities. Contracts have not yet been let. The road will serve a population of 250,000 and will be built and equipped for handling freight and passenger traffic. C. J. Kramer, 319 Main street, Little Rock, is president; J. C. Marshall, secretary; G. W. Rogers, treasurer; P. M. Pierce, electrical engineer. (Noted May 2.)

**Manchester (Ky.) Traction Company.**—It is reported that this company has been organized to build an electric railway from Manchester to Harboursville, Ky., 25 miles. Right of way has been secured. Louis des Cognets, Lexington, Ky., is president.

**Marquette Negaunee & Ishpeming Interurban Railway, Marquette, Mich.**—This company is preparing to begin construction this spring on its proposed line connecting Marquette, Negaunee and Ishpeming, Mich., 14 miles. The site for the power house has not yet been chosen. L. M. Sigler, Cleveland, O., is president; J. W. Barber, Cleveland, is secretary. The Roberts & Abbott Company, Cleveland, is acting as consulting engineer.

**Mattoon Shelbyville Pana & Hillsboro Traction Company.**—W. R. Patton, president, Charleston, Ill., writes that this company proposes to build an electric railway from Mattoon to Hillsboro, Ill., 68 miles, via Windsor, Shelbyville, Nokomis, Pana and Witt. Surveys have been completed but it has not been definitely decided when construction will begin. (Noted April 18.)

**Milwaukee & Fox River Valley Electric Railroad, Fond du Lac, Wis.**—It is reported that this company has agreed to complete the line from Plymouth to Elkhart, Wis., by July 1. J. M. Saemann of Sheboygan is president. (Noted February 29.)

**Mt. Hood Railway & Power Company, Portland, Ore.**—Construction on the line from Portland to Bull Run, Ore., has been suspended temporarily on account of a dispute in regard to the right of way near Gresham. (Noted May 2.)

**Omaha & Council Bluffs Street Railway, Omaha, Neb.**—It is announced that the route for the proposed extension of the Manawa line to the Iowa School for the Deaf has been finally decided. Right of way has been secured, plans have been prepared and construction is to be started this summer. (Noted March 28.)

**Paul's Valley, Okla.**—Scott Jones is said to be interested in a project to build an electric railway from Paul's Valley to Anadarko via Chickasha and Lindsay.

**Pendleton, Ore.**—It is reported that W. H. Coe of Portland, Ore., is interested in a project to build an electric railway from Pendleton to Irrigon, Ore., and that surveys are now being made.

**Schenectady (N. Y.) Railway.**—It is announced that this company will double-track the Broadway line in Schenectady from Campbell avenue to Guiderland avenue and also a short portion of the Campbell avenue line.

**Spokane & Inland Empire Railroad, Spokane, Wash.**—It is reported that surveys are being made for a branch line from

Steptoe, Wash., to the summit of Steptoe butte, about four miles.

**Terre Haute Indianapolis & Eastern Traction Company, Indianapolis, Ind.**—John J. Appel, vice-president, and C. C. Reynolds, general manager, are reported to have announced that plans are now being considered for the proposed extension from Crawfordsville, Ind., to Danville, Ill. County franchises have been secured.

**Washington Westminster & Gettysburg Railroad, Washington, D. C.**—James B. Colegrove, president, writes that surveys have been completed for the proposed line from Washington, D. C., to Gettysburg, Pa., 90 miles, via Sandy Spring, Laytonville, Damascus, Mt. Airy, Westminster and Littleton. Contracts are to be let for the entire construction and grading is to be started this summer. The maximum grade will be 1½ per cent and the maximum curvature 4 degrees except in towns. It is proposed to use 70-pound T-rails. The road would accommodate a large excursion traffic and traverse a rich agricultural region. A. A. Chapin is vice-president and W. Atlee chief engineer. (Noted April 18.)

**Wellsburg Bethany & Washington Traction Company, Wellsburg, W. Va.**—Work was started this week in Bethany on the city portion of the line from Wellsburg to Bethany, W. Va., seven miles, and it is stated that the road will be in operation this month. T. E. Cramblett of Bethany is president.

**West Chester & Wilmington Electric Railway, West Chester, Pa.**—This company has awarded a contract to the Eastern Railway Construction Company for the construction of its proposed line from West Chester, Pa., to Wilmington, Del., 16½ miles. Surveys have been completed and construction is to be started at once. Thomas E. O'Connell, president. (Noted April 11.)

**Winona Interurban Railway, Winona Lake, Ind.**—S. C. Dickey, general manager, has announced that the Winona-Warsaw line should be ready for operation by July 4. The grading between Akron and Warsaw is nearly completed and tracklaying is to begin at an early date. (Noted April 11.)

**Yakima Valley Transportation Company, North Yakima, Wash.**—This company, which recently completed a 3-mile electric road in North Yakima, has announced plans for the construction of a system of lines amounting to about 70 miles in the Yakima valley. Preliminary surveys have been made and a portion of the capital has been subscribed. The plans include a line to the state fair grounds southeast of the city to be built this year, which is to be extended to Yakima City, Parker and Zillah and eventually to Granger and Sunnyside, Wash.; a line running southeast of the city for about 12 miles through the Moxee valley, and another extension of the present line to Ahtanum, six miles. A. J. Splawn is president and G. S. Rankin vice-president and general manager. (Noted January 4.)

#### POWER HOUSES AND SUBSTATIONS.

**Virginia Passenger & Power Company, Richmond, Va.**—This company contemplates the expenditure of about \$70,000 for a substation on Church Hill. (Noted February 8.)

**Winchester & Washington Railway.**—S. H. Hansbrough, president of this company, which owns and operates a large power plant on the Shenandoah river at Millville, Va., and supplies light and power to Winchester, Berryville and Charlestown, is reported as announcing that the capacity of the plant will be doubled at once. It is stated that contracts for \$50,000 worth of additional machinery have been let for installation in July. The plant will then have a capacity of about 3,000 horsepower.

**Milwaukee Light Heat & Traction Company, Milwaukee, Wis.**—It is announced that this company will begin the construction of a temporary power station at Watertown, Wis., to care for the operation of the electric line now building from Oconomowoc to Watertown. This work is preliminary to the construction of a large power plant to be erected next year for the operation of all the lines radiating from Watertown, estimates on which are being made by Davidson, Ran & Kahill, engineers at Milwaukee.

**Greenville & Carolina Railway, Greenville, S. C.**—It is stated that this company, recently organized to build a 70-mile interurban line from Greenville, S. C., to Hendersonville and Asheville, N. C., will build a water power electric plant which will develop about 6,000 horsepower for the transmission of electricity to operate its lines and various electric light plants in that section. The contract has been awarded to the Carolina Construction Company of Asheville, N. C., which will start construction work in the near future. T. E. Smith, Greer, S. C., is president of the railway company.

## Personal Mention

Mr. J. F. Lardner, vice-president and general manager of the Tri-City Railway at Davenport, Ia., has resigned to engage in other business in Davenport.

Mr. Henry J. Davies, secretary of the Cleveland Electric Railway, has been elected treasurer also and will be the active representative of the company in Cleveland.

Mr. Grant Buchanan has been appointed assistant superintendent and chief dispatcher of the Chicago Lake Shore & South Bend Railway at South Bend, Ind. Mr. Buchanan formerly was superintendent of construction of the Youngstown & Ohio River Railroad at Youngstown, O.

Mr. A. J. McAndrews has been appointed master mechanic of the Bloomington lines of the Illinois Traction System, with headquarters at Bloomington, Ill., effective at once. Mr. McAndrews formerly was connected with the Indianapolis & Cincinnati Traction Company at Rushville, Ind.

Mr. Henry Haigh has been elected president of the Cincinnati Georgetown & Portsmouth Railroad, Cincinnati, O., succeeding the late A. W. Comstock. Mr. Haigh is a well-known railway builder and is at present engaged in the construction of the extension of the Milwaukee Northern Railway from Port Washington to Sheboygan, Wis.

Mr. R. W. Cooke has been appointed superintendent of the Municipal Traction Company of Cleveland, O. He succeeds Mr. George L. Radcliffe of the Cleveland Electric Railway, which has been leased to the Municipal Traction Company. Mr. Cooke has been superintendent and chief engineer of the Forest City Railway. Mr. Lawrence Crecelius has been appointed superintendent of power. Mr. Terrance Scullin, master mechanic of the Cleveland Electric Railway, has been retained by the Municipal Traction Company.

Mr. A. B. du Pont, president of the Municipal Traction Company, which, by the recent settlement, now operates under a lease all the street railway lines in Cleveland, was



A. B. du Pont.

born in Louisville, Ky., on April 26, 1865. Mr. du Pont comes from a family long identified with street railroads, an uncle, A. V. du Pont, and his father, Bidermann du Pont, having had large holdings for many years in the street railway lines of Louisville and other large American cities. Mr. du Pont graduated from the Rensselaer Polytechnic Institute of Troy, N. Y., at the age of 21 years, and for a short time was engaged as a mining engineer. Desiring to enter street railway work he went to Louisville, Ky., where he was employed in the track department of the city lines on construction and maintenance. At this time Tom L. Johnson, a friend of the family and the present mayor of Cleveland, was associated with the lines in Brooklyn, N. Y., and at his solicitation Mr. du Pont went to that city to engage in the construction and equipment of the cable lines. After completing this work he was placed by his uncle, A. V. du Pont, in charge of the reconstruction and equipment for electrical operation of the Louisville lines, during which time he designed and built power houses and invented several railway appliances, among them the du Pont truck. He then engaged in similar work in Detroit and later, when all the lines of that city were consolidated, he was appointed general manager of the combined properties. He subsequently became vice-president and general manager of the St. Louis Transit Company, where he was engaged for three years in reconstructing and equipping the lines for electrical operation. He also designed and installed the large terminals for handling the crowds at the St. Louis world's fair in 1904. In 1905 he resigned from this position with the intention of retiring from active business connections. The traction difficulties in Cleveland, however, under the leader-



ship of Mayor Johnson, have since occupied his attention and, as earlier stated, their adjustment has resulted in the Municipal Traction Company being in control of all the lines of that city with Mr. du Pont as president.

Mr. L. R. Gaw, for the past year master mechanic of the Ohio Central Traction Company at Gallion, O., has resigned to accept a similar position with the Saginaw-Bay City Railway & Light Company at Saginaw, Mich., succeeding Mr. William Long, resigned, as noted in the Electric Railway Review of May 2. Mr. Gaw formerly was with the Toledo & Indiana Railway.

Mr. J. C. Gillette, who has been in charge of the engineering work for the Roberts & Abbott Company of Cleveland, O., in connection with the overhead construction of the Washington Baltimore & Annapolis Electric Railway, Baltimore, Md., has been appointed electrical engineer of that road, effective at once. Mr. Gillette formerly was electrical engineer for the Columbus Delaware & Marion Railway at Delaware, O.

Mr. H. R. Fothergill, heretofore general superintendent of the Greenville (S. C.) Traction Company and superintendent of the Greenville Gas & Electric Light & Power Company and the Paris Mountain Water Company, has resigned to re-enter the contracting business. Mr. Fothergill has been connected with electric railway and lighting properties for the past 15 years, having been particularly engaged in power plant construction.

Mr. J. G. Huntoon, heretofore superintendent of transportation of the Tri-City Railway at Davenport, Ia., has been appointed general superintendent of the company, with entire charge of the operation of the lines of that road. Mr. Huntoon was born in Rock Island, Ill., and has been connected with the Tri-City company in various departments for the past 20 years. He succeeds Mr. James F. Lardner, whose resignation is announced elsewhere.

Mr. C. E. A. Carr, heretofore manager of the Helena Light & Railway Company, Helena, Mont., has resigned to become managing director of the Quebec Gas Railway & Electric Light Company of Quebec, Canada. Mr. Carr had been connected with the Helena property since 1905, when he was engaged by J. G. White & Co. as manager with entire charge of the construction and reconstruction work on the property in 1906 and 1907. He was born at Thornton, Ont., in 1870 and was actively engaged in street railway work in Canada for several years, having had charge of the conversion of the London (Ont.) Street Railway from horsepower to electricity in 1905, and holding at the same time the position of general manager and secretary of the Montreal Park & Island Railway, a 40-mile suburban road operating between Montreal and Quebec.

#### OBITUARY.

A. W. Comstock, formerly president of the Cincinnati Georgetown & Portsmouth Railroad, Cincinnati, O., died on Thursday, April 30.

#### Pay-As-You-Enter Cars Give Satisfaction in New York.

The new pay-as-you-enter cars which were placed in service in New York on March 21 are giving entire satisfaction, according to a recent statement by Oren Root, general manager for the receivers of the New York City Railway.

"Passengers are co-operating with us, by having the exact fare ready to hand the conductors upon entering the cars," said Mr. Root, "and the signs on the sides of the cars, calling the attention of the public to this requirement, have helped as a constant reminder. We have had few complaints about the new cars, and I can hardly class as complaints those we have received from men that the steps are too high, particularly for short, stout people. This was one of the first deficiencies we noticed ourselves, and, as the cars are an experiment with us, we have been giving them close attention.

"On 65 of the 155 cars installed we have already lowered the steps 2½ inches, which is lower than the steps on the standard closed cars in operation on the other lines. The steps on the remaining number will be lowered within the next two weeks. We have found the doors are a little too narrow, and this defect will be remedied in the next lot of cars we shall order. They will be made wider than those of the present cars by 1½ inches, which is sufficient to meet all requirements. We contemplate placing an order for 150 more of these cars, which we shall probably run on the Eighth avenue line.

"We may say that the new cars are a great success, and they certainly facilitate the loading and unloading of passengers."

## Financial News

**American Light Heat & Traction Company, New York.**—Earnings on the stock of subsidiary companies in the quarter ended March 31, 1908, were \$600,463, as compared with \$571,519 in the corresponding quarter of 1907. Miscellaneous earnings were \$58,630, as compared with \$56,496; net earnings available for distribution were \$647,093, as compared with \$616,015. After provision for accrued dividends, the surplus for the quarter was \$332,140, as compared with \$317,963. A deduction of \$176,500 was made for reconstruction reserve in each quarter.

**Augusta-Aiken Railway & Electric Company, Augusta, Ga.**—Stuart F. Knott, Gordon N. Buck, W. S. Johnson, J. H. Hellen and C. C. Tegethoff have been elected new directors to succeed W. T. Van Brunt, D. S. Herdy, H. B. Parson and W. P. Gardiner. This company controls the Augusta Railway & Electric Company, the Augusta & Aiken Railway and other properties.

**Boston & Northern Street Railway, Boston, Mass.**—This company has asked the Massachusetts railroad commission to approve the issue of \$1,250,000 of 6 per cent cumulative preferred stock.

**Camden & Trenton Railway, Camden, N. J.**—Protective committees representing bondholders of this company, the Trenton & New Brunswick Railroad and the New Jersey Short Line Railroad met on April 16 in Philadelphia and decided to retain Ford, Bacon & Davis of New York to examine the properties and report what improvements will be necessary to enable profitable operation. A majority of each class of bonds has been deposited with the West End Trust Company of Philadelphia.

**Chicago & Milwaukee Electric Railroad.**—George G. Moore of Detroit has been appointed one of the receivers for this road to succeed H. A. Haugan, president of the State Bank of Chicago. The issue of \$1,000,000 of receivers' certificates, the proceeds of which will be used to complete the construction of the line to Milwaukee, has been purchased by the Investment Registry, Limited, of London, which had previously acquired an interest in the bonds of the Chicago & Milwaukee Electric Railroad of Wisconsin. The certificates were purchased at 95.

**Evansville (Ind.) Terminal Railway.**—An issue of \$200,000 of an authorized amount of \$300,000 of first mortgage 30-year 5 per cent bonds has been made. The bonds are offered for sale at 90 and interest, with a bonus of 30 per cent in 6 per cent cumulative preferred stock of the Evansville Railways Company. The latter owns the outstanding stock of the Terminal railway and guarantees principal and interest of the bonds. The bonds are described as follows: "The \$200,000 bonds are issued for the purpose of providing funds with which to construct a line between Evansville and Newburg, Ind., nine miles; the line to be operated by both electricity and steam. It is proposed to lease the present property belonging to the Evansville & Eastern Electric Railway, in operation between Newburg and Rockport, 21 miles, and to operate the lines as one system, together with the line west to Mr. Vernon, Ind.; total mileage, 48 miles. The business at present handled by the Evansville Suburban & Newburg Railway for the account of the Evansville & Eastern road shows annual business amounting to \$23,152 and cost of operation, \$6,250. The Evansville Railways Company owns all of the stock of the Evansville & Mt. Vernon Electric Railway and 98 per cent of the outstanding stock of the Evansville & Eastern Electric Railway, besides the total capital stock of the Evansville Terminal Railway. The company has \$1,000,000 common stock and \$500,000 preferred stock. It has no bonded debt and has not heretofore guaranteed bonds of either of the other roads owned by it."

**Fairmont & Clarksburg Traction Company, Fairmont, W. Va.**—The authorized stock of this company has been increased from \$2,000,000 to \$5,000,000.

**Hartford & Springfield Street Railway, Hartford, Conn.**—The directors deferred the usual semi-annual dividend due in May, on account of business conditions and the existence of a floating debt of \$40,000. An explanatory statement by the company to shareholders said that it was inadvisable to attempt at present to dispose of securities to provide for the payment of this debt. While nearly all of the electric railways in New England have shown a decrease in passenger revenue for the first quarter of this year, this company, the statement said, showed an increase for each of the three

months. In the quarter gross earnings amounted to \$32,051.98, as compared with \$30,359.45 in the first three months of 1907. The statement added further that it was believed that earnings in 1908 would be materially larger than in any previous year, and the directors expressed the hope that the earnings would be sufficiently large to warrant payment of the deferred dividend at a later date.

**Hudson Valley Railway, Glens Falls, N. Y.**—Gross earnings for the quarter ended March 31, 1908, were \$112,300, as compared with \$107,884 for the corresponding quarter of the previous year. Operating expenses were \$107,103, as compared with \$103,602. The final deficit, after meeting fixed charges, was \$60,050, as compared with \$43,959.

**Northern Texas Traction Company, Ft. Worth, Tex.**—An amendment to the charter authorizing an increase in the capital stock from \$2,500,000 to \$3,000,000 has been approved by the authorities of Texas.

**Old Colony Street Railway, Boston, Mass.**—Application has been made to the Massachusetts railroad commission for approval of an issue of \$750,000 of 6 per cent cumulative preferred stock.

**Philadelphia Company, Pittsburg.**—Gross earnings for the quarter ended March 31, 1908, were \$4,662,000, as compared with \$5,102,113 in the corresponding quarter of the previous year. Expenses and taxes were \$2,838,799, as compared with \$2,947,214, and net earnings were \$1,823,261, as compared with \$2,154,899 in the 1907 quarter.—Gross earnings of the Philadelphia Company and affiliated corporations for the year ended December 31, 1907, were \$19,082,099. Operating

expenses and taxes were \$9,668,328. Net earnings were \$9,413,771. From the net income of \$5,061,000 there was deducted \$2,136,726 for improvements, betterments and extraordinary expenses.

**Portland (Ore.) Railway Light & Power Company.**—This company has acquired the properties of the subsidiary Portland Railway Company, Oregon Water Power & Railway Company and the Portland General Electric Company.

**Public Service Corporation, Newark, N. J.**—Thomas N. McCarter, the president, states: "The directors have authorized the execution of a first mortgage upon all the property of the corporation, securing an issue of \$50,000,000 of 5 per cent bonds, dated May 1, 1908. The mortgage is designed to provide a complete financial scheme for the company for years to come. It covers all the real estate, the leases of gas and electric properties, and pledges as security thereunder all the shares and bonds of underlying companies. By the terms \$3,725,000 bonds are to be delivered by the trustee to recoup the company for betterments recently made and contracted for; \$7,250,000 bonds are reserved for retiring a like amount of collateral gold notes, dated November 1, 1904; \$6,250,000 bonds are reserved for retiring a like amount, or so many thereof as may not have been converted, of the convertible notes, dated April 16, 1906. The remainder of the issue is reserved under most carefully restricted provisions for future betterments. After delivery of the \$3,725,000 bonds no future bonds can be delivered by the trustee unless there be delivered to the trustee a certificate, verified by affidavit, that so far as any portion of said issue up to \$25,000,000 is concerned, the earnings from the leased properties mortgaged and the income from pledged securities for the 12 calendar months

## ELECTRIC RAILWAY EARNINGS.

	Gross earnings.	Operating expenses.	Net earnings.	Total charges.	Surplus.
Kansas City Railway & Light Company, March, 1908.....	\$ 488,740.89	\$ 267,037.17	\$ 221,703.72	\$ 153,823.77	\$ 67,879.95
Kansas City Railway & Light Company, March, 1907.....	478,464.49	258,893.81	219,570.68	152,052.45	67,518.23
Kansas City Railway & Light Company, June 1, 1907, to March 31, 1908.....	5,127,918.49	2,658,672.25	2,469,246.24	1,532,895.65	936,350.59
Kansas City Railway & Light Company, June 1, 1906, to March 31, 1907.....	4,753,616.19	2,385,948.27	2,367,667.92	1,464,063.93	903,602.99
Twin City Rapid Transit Company, March, 1908.....	484,622.79	252,823.96	231,798.83	123,386.09	108,412.74
Twin City Rapid Transit Company, March, 1907.....	479,301.47	233,731.01	245,570.46	115,258.26	130,312.10
Twin City Rapid Transit Company, January 1, 1908, to March 31, 1908.....	1,408,458.37	764,668.44	643,789.93	368,130.56	275,659.37
Twin City Rapid Transit Company, January 1, 1907, to March 31, 1907.....	1,355,941.10	694,296.77	661,644.33	345,775.04	315,869.29
Montreal Street Railway, March, 1908.....	288,674.07	202,389.80	86,284.27	52,257.46	34,026.81
Montreal Street Railway, March, 1907.....	271,588.07	185,461.28	86,126.79	43,211.64	42,915.15
Montreal Street Railway, October 1, 1907, to March 31, 1908.....	1,747,136.88	1,145,865.73	601,271.15	272,282.01	328,989.14
Montreal Street Railway, October 1, 1906, to March 31, 1907.....	1,599,048.45	1,073,656.96	525,391.49	238,878.42	286,513.07
Toledo Railways & Light Company, March, 1908.....	*202,186.83	114,879.80	87,307.03	68,898.65	18,408.38
Toledo Railways & Light Company, March, 1907.....	*214,837.48	118,714.64	96,122.84	63,457.53	32,665.31
Toledo Railways & Light Company, January 1, 1908, to March 31, 1908.....	*628,624.10	356,269.70	272,354.40	205,952.59	66,401.81
Toledo Railways & Light Company, January 1, 1907, to March 31, 1907.....	*637,425.61	369,256.73	268,168.88	188,920.08	79,248.50
Duluth Street Railway, March, 1908.....	67,454.73	44,218.83	23,235.90	18,416.67	4,819.23
Duluth Street Railway, March, 1907.....	64,565.54	31,292.44	33,064.10	17,616.92	15,447.18
Duluth Street Railway, January 1, 1908, to March 31, 1908.....	194,300.09	130,275.47	64,024.62	55,250.01	8,774.61
Duluth Street Railway, January 1, 1907, to March 31, 1907.....	176,697.61	97,798.29	78,899.32	52,720.70	26,178.62
Aurora Elgin & Chicago Railroad, March, 1908.....	95,773.72	56,652.42	39,121.30	28,190.92	10,930.38
Aurora Elgin & Chicago Railroad, March, 1907.....	102,416.23	58,174.82	43,701.41	26,991.95	16,709.46
Aurora Elgin & Chicago Rd., July 1, 1907, to March 31, 1908.....	1,058,539.30	584,313.48	474,401.82	249,392.27	225,009.55
Aurora Elgin & Chicago Rd., July 1, 1906, to March 31, 1907.....	979,055.65	532,522.44	446,533.21	237,309.56	209,223.65
Whitcomb County Railway & Light Company, February, 1908.....	27,568.61	17,250.79	10,317.82	6,373.01	3,944.81
Whitcomb County Railway & Light Company, February, 1907.....	25,706.74	15,873.32	10,033.42	6,197.74	3,835.68
Whitcomb County Railway & Light Company, March 1, 1907, to February 29, 1908.....	359,805.32	214,405.64	145,399.68	78,275.39	67,124.29
Whitcomb County Railway & Light Company, March 1, 1906, to February 28, 1907.....	289,863.86	184,672.22	105,191.64	52,839.88	52,351.76
Dallas Electric Corporation, February, 1908.....	84,185.57	62,994.04	21,191.53	20,115.29	1,076.24
Dallas Electric Corporation, February, 1907.....	78,072.56	64,150.83	13,921.73	16,646.67	*2,724.94
Dallas Electric Corporation, March 1, 1907, to Feb. 29, 1908.....	1,134,078.44	814,322.44	319,756.00	230,348.31	89,407.69
Dallas Electric Corporation, March 1, 1906, to Feb. 28, 1907.....	1,041,009.91	731,857.22	309,152.69	189,028.75	120,123.94
Northern Texas Electric Company, February, 1908.....	71,310.83	46,727.47	24,583.36	11,935.01	12,648.35
Northern Texas Electric Company, February, 1907.....	67,292.14	45,557.57	21,734.57	10,300.00	11,434.57
Northern Texas Electric Co., March 1, 1907, to Feb. 29, 1908.....	1,064,221.49	624,501.53	439,719.96	131,572.76	308,147.20
Northern Texas Electric Co., March 1, 1906, to Feb. 28, 1907.....	892,280.02	567,295.39	325,984.63	120,136.68	205,847.95
Brockton & Plymouth Street Railway, February, 1908.....	6,341.04	6,890.25	*549.21	1,849.32	*2,398.53
Brockton & Plymouth Street Railway, February, 1907.....	5,485.06	5,471.24	13.82	1,795.52	*1,781.70
Brockton & Plymouth Street Railway, March 1, 1907, to February 29, 1908.....	120,612.43	91,091.83	29,520.60	21,573.87	7,946.73
Brockton & Plymouth Street Railway, March 1, 1906, to February 28, 1907.....	112,318.03	71,240.15	41,077.88	21,773.43	19,304.45

\*Includes miscellaneous income.

next preceding the date of the certificate exceed by 33 1/3 per cent the interest on all the bonds issued under said mortgage, plus interest on the bonds, the certification and delivery of which is desired; and that so far as the issue of the remaining \$25,000,000 bonds is concerned, there must be delivered to the trustee a certificate, verified by affidavit, that earnings from the leased properties mortgaged and the income from pledged securities for the 12 calendar months next preceding the date of the certificate, exceed by 50 per cent the interest on the bonds issued under said mortgage, plus interest on the bonds, the certification and delivery of which is desired. Not more than \$25,000,000 bonds can be delivered under the mortgage prior to January 1, 1911, and thereafter not more than \$4,500,000 bonds can be issued in any one year for betterments, except that this last provision is cumulative."

**Rutland (Vt.) Railway Light & Power Company.**—G. T. Rogers, the president, has issued a statement to holders of stock and bonds saying that the final consolidation of the Rutland properties has been completed, and giving a balance sheet as of April 1, 1908, together with the figures of earnings for the year ended March 31, 1908, with comparisons. The railway earnings and earnings of the consolidated properties for three years have been as follows:

Railway—	Earnings.	Expenses.	Net.
1906.....	\$ 93,726.22	\$ 55,369.97	\$ 38,356.25
1907.....	105,154.55	56,003.09	49,151.46
1908.....	105,484.93	58,213.43	47,271.50
Consolidated—			
1906.....	180,026.08	115,189.98	64,836.10
1907.....	222,019.41	130,454.89	91,564.52
1908.....	254,835.18	144,379.29	110,455.89

Mr. Rogers states: "Notwithstanding the splendid increase in both gross and net receipts, all indications point to a still further increase, as the company has entered into a number of contracts for power with some of the largest consumers in this section."

**Sheboygan (Wis.) Light Power & Railway Company.**—This company has executed a lease whereby it takes over for a period of 25 years the section projected by the Milwaukee & Fox River Valley Railway between Plymouth and Elkhart Lake, Wis. Ernest Gonzenbach, general manager of the Sheboygan company, states that this section will be rushed to completion.

**Springfield (Mass.) Street Railway.**—The Massachusetts railroad commission has approved the issue of \$500,000 additional capital stock, making the total outstanding \$2,758,100. The proceeds will provide for floating debt and additions to property.

**Toledo Urban & Interurban Railway, Toledo, O.**—We are advised by an official of this company that there is no truth in a report that the joint operation of the Toledo Urban & Interurban Railway and the Toledo Bowling Green & Southern Traction Company will be abandoned and the Ohio Electric Railway will acquire an interest in the former property.

**Union Electric Company, Dubuque, Ia.**—A block of \$125,000 of first mortgage 5 per cent bonds, due on May 1, 1924, is offered for sale by Perry, Coffin & Burr, Boston. Gross earnings of the company in 1907 were \$294,922 and net earnings were \$90,448. Interest amounted to \$32,500, leaving a surplus of \$57,948.

**United Traction Company, Albany, N. Y.**—Gross earnings in the quarter ended March 31, 1908, were \$453,777, as compared with \$456,644 in the corresponding quarter of the previous year. Operating expenses were \$323,799, as compared with \$292,621. Net earnings were \$129,978, as compared with \$164,023. Other income was reduced and charges were a little higher, so that the final surplus was \$71,343, as compared with \$114,183.

**Vicksburg (Miss.) Railway & Light Company.**—The property of this company was sold at auction on May 4 at Vicksburg to H. S. Bullis of Olean, N. Y., for \$50,000.

**Dividends Declared.**

- Columbus (O.) Railway, preferred, quarterly, 1 1/4 per cent.
- Connecticut Railway & Lighting Company, New Haven, Conn., common, assenting, quarterly, 1 per cent; non-assenting, quarterly, 0.15 per cent; preferred, quarterly, 1 per cent.
- Dartmouth & Westport Street Railway, New Bedford, Mass., quarterly, 2 per cent.
- Ohio Traction Company, Cincinnati, O., preferred, quarterly, 1 1/4 per cent.
- Tampa (Fla.) Electric Company, 3 1/2 per cent.
- Union Street Railway, New Bedford, Mass., quarterly, 2 per cent.

# Manufactures and Supplies

**ROLLING STOCK.**

**Spokane Traction Company, Spokane, Wash.,** has ordered four double-truck cars from the St. Louis Car Company.

**Marion Bluffton & Eastern Traction Company, Bluffton, Ind.,** has ordered one 18-bench open car from the Cincinnati Car Company.

**Snohomish Valley Railway, Snohomish, Wash.,** is in the market for three direct-current interurban cars, three trailers and one express car.

**Chicago South Bend & Northern Indiana Railway, South Bend, Ind.,** has ordered 10 closed cars and one portable substation car from the Cincinnati Car Company.

**Pittsburg & Butler Street Railway, Pittsburg, Pa.,** which was reported in the Electric Railway Review for May 2 to have placed an order with the Cincinnati Car Company for two cars, has ordered four combination passenger interurban cars from this company.

**SHOPS AND BUILDINGS.**

**Texas Traction Company, Dallas, Tex.**—It is reported that this company has leased a lot, 47 by 200 feet, on Commerce street, Dallas, and will build a station on it.

**TRADE NOTES.**

**Railway Materials Company, Chicago,** has moved its New York office to the Singer building.

**Quincy, Manchester, Sargent Company** has moved its Chicago offices to 1175 Old Colony building.

**Lufkin Rule Company, Saginaw, Mich.,** reports a satisfactory increase in the demand for its well-known measuring

**Nanz Clock Company, New York,** manufacturer of watchman's time detectors, announces the removal of its office, salesroom and repair shop to 178 Fulton street.

**A. L. Whipple, formerly with the Curtain Supply Company,** has re-entered the railway supply field as manager of sales for the Forsyth Brothers Company, Chicago. Mr. Whipple will engage in the eastern field and will at once open an office in New York.

**John A. Stewart Electric Company, Cincinnati, O.,** has contracted with the Joplin & Pittsburg Railway of Kansas City and Pittsburg, Kan., for two 600-kilowatt direct connected railway units and complete power house equipment, consisting of water tube boilers, etc.

**James G. Wilson Manufacturing Company, New York,** manufacturer of rolling steel shutters, rolling wood partitions and rolling wood doors for roundhouses, has established an office at 305 Real Estate Trust building, Philadelphia, Pa., which will be in charge of A. H. Dodge.

**Charles H. Spotts, for the past 10 years manager of the paint department of the Joseph Dixon Crucible Company, Jersey City, N. J.,** has resigned. Mr. Spotts is contemplating establishing a paint manufacturing plant in the vicinity of New York and is making his headquarters for the present at the Engineers' Club, New York.

**H. W. Johns-Manville Company, New York,** on account of increasing business in Detroit, Mich., and the adjacent territory, will soon open a branch office in that city at 72 Jefferson avenue. Willard K. Bush, who has been connected with the Milwaukee office of the company for a number of years, will be manager of the new branch. A complete stock of Johns-Manville products will be carried, so that shipments can be ordinarily made direct.

**J. G. White & Co., incorporated, New York,** has been awarded the contract for engineering and constructing a complete hydro-electric plant, with transmission lines, substations, etc., for the Central Georgia Power Company. This plant will be built on the Ocmulgee river, about 36 miles above Macon, Ga., supplying power to that point and to other points in the vicinity. The normal capacity of the plant will probably be 12,500 kilowatts, generated by water wheels under a 100-foot head. The crest of the dam will probably be 750 feet.

**Horace H. Lane** has announced the opening of an engineering office at 822 Penobscot building, Detroit, Mich. Mr. Lane will conduct a general engineering and construction business, including steam equipment, electrical installation,

structural work and complete plants. He has lived in Detroit almost continuously for the past six years, during which time he was connected with Westinghouse, Church, Kerr & Co., New York. Mr. Lane was in charge of the construction of the American Car & Foundry Company's plant at Detroit and has devoted his entire life to engineering work.

**Technical Publicity Association, New York,** at its annual meeting, April 30, elected the following officers to serve during the ensuing year: President, C. S. Redfield, advertising manager Yale & Towne Manufacturing Company; first vice-president, Rodman Gilder, publicity manager Crocker-Wheeler Company; second vice-president, C. N. Manfred, manager advertising department H. W. Johns-Manville Company; secretary, H. H. Kress, publicity department A. S. Cameron Steam Pump Works; treasurer, H. M. Davis, advertising manager Sprague Electric Company; members of executive committee, F. H. Gale, in charge of advertising General Electric Company, and C. W. Beaver, special representative Yale & Towne Manufacturing Company. Twenty new members have joined the association since the last annual meeting.

**Goldschmidt Thermit Company, New York,** announces the establishment of an office and works at 103 Richmond street, West, Toronto, Ont. The new branch was opened for business May 1, and is under the management of E. C. Rutherford. Mr. Rutherford has a wide acquaintance in Canada, having been for several years the manager of the Magann Air Brake Company and of the Canadian Brake & Supply Company. A complete stock of thermit and appliances will at all times be carried at Toronto, and the branch organization will be in a position to execute promptly the welding of heavy steel sections, such as stern posts of ships, crankshafts, etc., as well as trolley rails in paved streets, motor cases and other broken steel sections. A fully equipped repair shop will be in operation for the repair of steel castings up to 1,000 pounds in weight.

**General Electric Company, Schenectady, N. Y.,** has issued its report for the year ended January 31, 1908. The net profits of the company were \$6,586,653.37. Dividends paid during the year aggregated \$5,183,614, leaving \$1,403,039.37 carried to the surplus account. The total surplus January 31, 1908, was \$16,513,836.14. The total sales billed during the year were \$70,977,168, and the total orders received, \$59,301,040. The company's consolidated balance sheet, as of January 31, 1908, showed total assets of \$98,525,765. Of this sum \$12,250,720 represented cash, \$18,000,089 stocks and bonds, \$541,900 real estate, \$29,857,726 notes and accounts receivable, \$1,276,294 work in progress, \$70,673,067 merchandise inventories, \$12,900,000 factory plants, including all lands, buildings and machinery, and \$2,701,976 invested in copper mining. The total liabilities included \$55,000 in 5 per cent debentures of 1892, \$2,047,000 in 3½ per cent debentures of 1902, \$12,872,750 in 5 per cent debentures of 1907, \$108,791 in accrued interest on debentures, \$1,759,517 in accounts payable, \$1,469 in unclaimed dividends, \$65,167,400 in capital stock outstanding, and \$16,513,836 in surplus. C. A. Coffin, president of the General Electric Company, in his report, says: "Late in the year there was a sudden and severe shrinkage in the value of all merchandise and materials used by your company, notably copper. All said materials, whether raw, manufactured or in process of manufacture, which were on hand January 31, 1908, were inventoried at the lower prices then prevailing. The book value of such inventories was thereby reduced by about \$2,000,000. During the year all the assets and liabilities of the Stanley G. I. Electric Manufacturing Company, Pittsfield, Mass., were taken over by your company, and the factories owned by that company at Pittsfield are now a part of the factory plants of your company. In this practical liquidation of the Stanley company there has been a considerable shrinkage in the valuation of its factory properties, inventories and other assets, thus adding to the otherwise large depletion in the profits for the year. In view of the then great expansion in business your directors deemed it wise, early in 1907, to provide for future development at some point nearer the central west, in preference to a further enlargement of the plants at Schenectady and Lynn. For this purpose the unencumbered fee of about 700 acres of land adjacent to the city of Erie, Pa., was purchased at a cost, including engineering and other expenses, of \$232,301.53. In view of the existing depression the erection of buildings thereon is deferred for the present."

#### ADVERTISING LITERATURE.

(Mention of the Electric Railway Review will assure prompt attention to requests for publications listed here.)

**Bruce-Meriam-Abbott Company, Cleveland, O.**—Vertical gas engines are illustrated and described in a recently issued catalogue.

**American Asphaltum & Rubber Company, Chicago, Ill.**—A leaflet illustrates the use of "Pioneer" reservoir waterproof-

ing asphalt in reservoirs at Jola and Independence, Kan., and Chickasha and Okmulgee, Okla.

**H. W. Johns-Manville Company, 100 William Street, New York, N. Y.**—An illustrated booklet sets forth the advantages of "Magic" boiler compound.

**American Engineering Company, Indianapolis, Ind.**—An interesting subject is handled in an interesting manner in a recently issued booklet entitled "Forty-nine Reasons Why New Railways Fail."

**Allis-Chalmers Company, Milwaukee, Wis.**—Recent publications include a leaflet devoted to portable air compressors, a bulletin on rotary kilns for cement plants and one on "Modern Rock Crushers."

**United Electric Car Company, Ltd., Preston, Eng.**—A 90-page catalogue recently issued shows the wide variety of rolling stock types built at this company's works for both electric and steam service. The catalogue is illustrated by a large number of halftone views.

**Rock Island Lines.**—The passenger department at Chicago has issued six unique mailing cards under the title of "Rock Island Bear Series," which are calculated to impress ticket agents of connecting lines with the desirability of ticketing people in need of vacations to Colorado via the Rock Island.

**National Bridge Company, Indianapolis, Ind.**—A recently issued catalogue of 148 pages and cover is devoted to concrete bridges. There are 63 full-page views of bridges designed by this company, many of them for steam and electric railways. Twenty-two full-page views show the same bridges under construction. The book also includes a large amount of valuable engineering information.

**Association of American Portland Cement Manufacturers, Land Title Building, Philadelphia.**—The Concrete Review for May has an increased number of pages and shows marked improvements from a typographical standpoint. In view of the additional expense involved in issuing the publication a minimum charge of 50 cents a year or 5 cents a copy will hereafter be made. The publishers state it is their intention to still further increase the monthly contents so that the journal may be thoroughly worthy of the important industry it represents.

**General Electric Company, Schenectady, N. Y.**—The CQ motor is described in detail in Bulletin No. 4584, recently issued. This motor is for direct-current circuits and is made up to 20 horsepower in size, and for voltages of 115, 230 and 550. Descriptions are given of belt tightener attachments, backgear devices, motor generator sets consisting of two CQ motors rigidly connected, etc. The application of the motor to ventilating outfits, machine tools, etc., is also outlined. The extensive tables of dimensions, capacities, etc., in the bulletin will be found useful in preparing specifications.—Bulletin No. 4578 describes in a comprehensive manner the essentials of the various standard motor controllers manufactured for railway service. Among the controllers described are type B, which include the necessary contacts and connections for electric braking; type K, for series parallel operation of the motors; type L, also in the series parallel class, but which completely open the power circuit when changing from series to parallel; type R, which are designed to control the motor speeds by means of resistance only; and a brief outline of the Sprague-General Electric type M control system. Tabulated data and dimension diagrams of the many standard forms of controllers, together with illustrations of the apparatus, provide ready means of reference.—Bulletin No. 4579 describes the construction, installation and operation of the luminous arc headlight, for which is claimed many advantages over the carbon arc headlight for use on interurban roads or heavy railway service. The upper electrode of the luminous arc is a copper forging and the lower electrode an iron tube filled with a special composition. As the copper forging wears away very slowly, its life being from two to three thousand hours, the arc is kept constantly in focus and the light obtained being in excess of that given by the carbon arc, a very brilliant illumination is obtained. The parts of the mechanism are substantially made and few in number, and the appearance of the headlight is similar to the ordinary carbon arc headlight. If the polarity of the electrode is reversed the light given is very much less and this is utilized for dimming the headlight when passing through the streets of cities and towns.—Bulletin No. 4576 describes the type F form K-3 line of oil switches for panel installation and remote control. It contains extensive data for selecting the proper switch, current transformer, etc., for any desired service.

During the month of April the Chicago City Railway installed 391,595 duct feet of underground conduit and laid 8.7 miles of track, of which 5.21 miles were paved.

# IMMEDIATE SHIPMENT

**40 Westinghouse 56 Motors**  
**12 Extra Armatures for same**

All in first-class operative condition.

We will accept in trade other Motors, Cars, Trucks, or Power House Apparatus. Write!

**ARTHUR S. PARTRIDGE, 425 Olive Street, St. Louis**

## Noise and Wear Can be Reduced by Using Manganese Steel **GEARS AND PINIONS**

MADE ONLY BY **ATHA STEEL CASTING CO.** NEWARK, N. J.

BOARD OF TRADE BLDG. 348 RAILWAY EXCHANGE BLDG. 509 AM. NATL. BANK BLDG. 407 CANTON BLDG.

BOSTON, MASS.

CHICAGO, ILL.

RICHMOND, VA.

CLEVELAND, O.

## WASHBURN Traction Draft Rigging

The highest development of its kind, so designed and constructed that the draft rigging is always directly in the line of all pulling and buffing strains. In other words, the spring takes up all shocks without undue strains on the rigging.

This is the draft rigging that enabled heavy interurban cars to be hauled on their own wheels in trains from St. Louis to Los Angeles without a breakage.

Further comment on their strength is unnecessary.

*Ask for new catalogue of traction devices.*

**Washburn Steel Castings & Coupler Co., Minneapolis, Minn.**

Western Agents: Tweedy, Hood & Finlen, 2014 Fisher Bldg., Chicago

Canadian Agent: John Taylor, Montreal

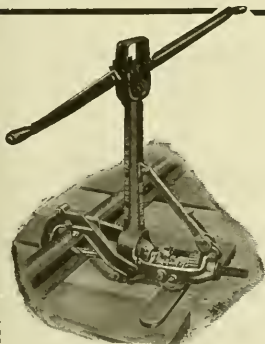

## The Moore Track Drill

does not interfere with traffic!

The shifting of one lever and a few seconds' time takes down the drill—the operation reversed makes it ready for work again.

This is only one of the many strong points about the Moore Track Drill that make it worth buying.

*Ask for descriptive catalogue.*



**Kalamazoo Railway Supply Co.** Kalamazoo Michigan

## THE J. G. BRILL COMPANY, PHILADELPHIA, PA.

AMERICAN CAR COMPANY, ST. LOUIS, MO.  
G. C. KUHLMAN CAR COMPANY, CLEVELAND, OHIO  
JOHN STEPHENSON COMPANY, ELIZABETH, N. J.  
WASON MANUFACTURING CO. SPRINGFIELD, MASS.

MAIN OFFICE: PHILADELPHIA, PA.  
LONDON OFFICE: 110 CANNON ST. E. G.  
PACIFIC COAST AGENTS: PIERSON  
ROEDING & CO., SAN FRANCISCO.  
AUSTRALIAN AGENTS: NOYES  
BROTHERS, SYDNEY. CABLES:  
"BRILL," PHILA., "AXLES" LONDON.

*CARS TRUCKS SEATS RATTAN SPRINGS SPECIALTIES SUPPLIES*

## LARGEST EARNING CAPACITY

For service in cities and towns, where an entirely open car with side entrances is desirable during warm weather, no better car can be found than the Brill Convertible. Unquestionably the entirely open car is the most popular summer type and the Brill Convertible overcomes the two drawbacks of the ordinary car--no protection in bad weather and the necessity for a double equipment of cars--and provides exactly what is wanted for every day in the year. Climatic conditions, of whatever kind, are no bar to the use of the Brill Convertible Car; it is equally successful in the Northern States with their arctic winters as in the Gulf States with their tropical summers. The flexible metal panels slide into the roof pockets just as easily as the sashes, therefore any one can operate them. The Brill Convertible Car is the most practical solution of the question of how to always secure the largest amount of traffic.

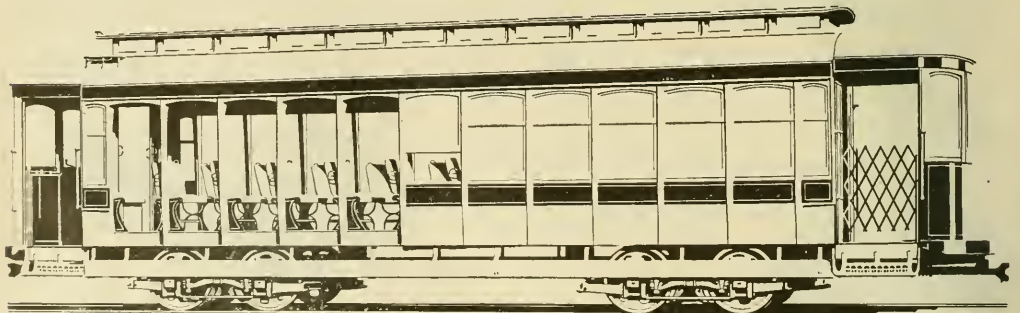

*THE BRILL CONVERTIBLE CAR (PATENTED)*

# General Electric Company

## Circuit Breakers Type MR



For Car Equipments

MR-10A-50 to 150 Amperes  
MR-11A-100 to 300 Amperes

MR-12A-200 to 600 Amperes  
MR-13A-300 to 900 Amperes

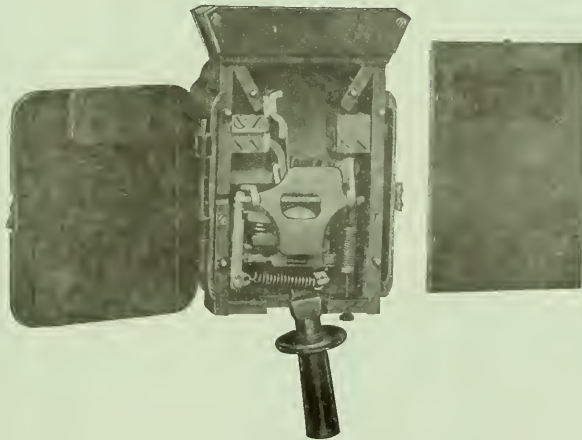

SMALL

COMPACT

RELIABLE

All parts readily accessible for repair or inspection

**Contacts and Operation:** Main contact brush protected by auxiliary contact fingers. Positive catch and wiping contact prevent sticking. Cannot remain in any position except full on or full off.

**Arc Chute:** Arc rupture concealed by extension arc chute.

**Insulation:** No "live" parts exposed. All working parts encased in insulated box

These breakers can be used as a device to automatically break the main trolley circuit in case of excessive overloads or short circuits, and as a hand operated main circuit switch.

Chicago Office:  
Monadnock Building

Principal Office:  
**Schenectady, N. Y.**

Sales Offices in  
All Large Cities



That "Phono-Electric" Trolley Wire will stand hard service is best determined by actual test. Our "Red Booklet" is mailed free. Write today.

**BRIDGEPORT BRASS COMPANY**  
253 Broadway, New York  
Mills: Bridgeport, Conn.



There are other steel measuring tapes—but none so reliable and absolutely accurate as those made by

**THE LUFKIN RULE CO.** New York, London, England, Windsor, Canada  
SAGINAW, MICH., U. S. A.

## Shelby Trolley Poles

Made from Cold Drawn Seamless Steel Tubing. Immediate delivery all sizes from stock.

**The Garford Company : Elyria, O.**

We make a *Truck Bearing* that meets the demands of modern equipment—that costs less—is less liable to heat—lasts longer than the old type—and can be used in any standard box. Prompt deliveries. Ask for prices.

Buffalo **LUMEN BEARING CO.** Toronto

One road reports gear cases packed with

## Whitmore's Gear Protective Composition

car in continuous operation one year and one week, no further applications made, absolutely no wear on either gears or pinions. These results are what cause our competitors to make false statements about the use of our goods. Try it and be convinced.

**The Whitmore Manufacturing Company**  
LUBRICATING ENGINEERS  
Cleveland, Ohio, U. S. A.

Established 1877.

## ALBERT & J. M. ANDERSON MFG. CO.,

Makers of

**ELECTRICAL APPLIANCES:**  
SWITCHES, SWITCHBOARDS,  
TIME SWITCHES, LINE MATERIAL,  
COPPER CASTINGS (75% CONDUCTIVITY).  
289-293 A ST., BOSTON, MASS., U. S. A.

Branches: New York, 135 Broadway. Chicago, 175 Dearborn Street.

Agencies:  
Boston, Pettingell-Andrews Co. San Francisco, Eccles & Smith Co.  
New York, R. W. Marshall & Co. Atlanta, Newcomer-Manly Co.  
St. Louis, J. C. White. Denver, E. M. Messiter.  
Toronto, Ont., H. J. Surtees.

# Satisfaction Always Follows BONDING or REBONDING

when done by the modern and economical methods—

## Electric Brazing and Copper Welding

Their superiority can be easily demonstrated on your own road if you give us the opportunity.

Names of users cheerfully furnished. Ask them whether they are satisfied.

**THE ELECTRIC RAILWAY IMPROVEMENT COMPANY**  
6005 Carnegie Avenue CLEVELAND, OHIO





# Electric Railway Review

PUBLISHED EVERY SATURDAY.

FORMERLY THE STREET RAILWAY REVIEW.

THE WILSON COMPANY, CHICAGO.

CHICAGO: 160 Harrison Street  
NEW YORK: 50 Church Street  
CLEVELAND: 1529 Williamson Bldg.

VOL. XIX  
No. 20

CHICAGO, MAY 16, 1908

Whole No.  
261

Subscription: Domestic, \$2.00  
Foreign, 5.00  
Canada, 3.50

## A Practical Book

*For Every Man*

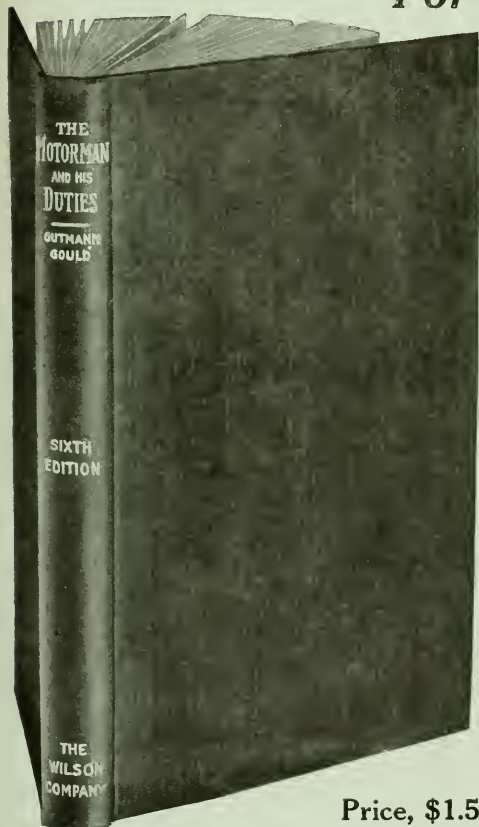

whose services will be made more valuable to himself and to his employer by acquiring intimate knowledge of the principles governing the operation of electric railway cars.

*Buy, read and study this book!* A practical application of the knowledge imparted will result in better, safer and more economical operation.

*"The Motorman and His Duties"* explains in simple language, free from mathematics and technicalities, many points not generally comprehended. It outlines clearly the relation existing between the track, overhead, power station and the car itself.

No other book completely covers the subject in a manner so easily understood!

*"The Motorman and His Duties,"* in the eleven chapters of its recently published sixth edition, comprises 198 pages, 5 by 7 inches, attractively bound in green cloth. It is illustrated by 138 halftones and zinc etchings. It includes a subject index, a glossary and three large inserts of car wiring diagrams.

**Price, \$1.50 per Copy, Prepaid**

Send your address on a postal for a 16-page pamphlet of sample pages, etc.

**The Wilson Company** 160 Harrison Street  
CHICAGO, U. S. A.

# A Big Reduction in Cost of Repairs

**Repairs Less Frequent    Repairs Made Quicker    Repairs at Less Expense**

Lyon Sheet Steel Gear Cases have been proven to be less expensive to maintain than malleable cases.

Repairs are less frequent, due to the fact that sheet steel will not break or crack as will malleable iron.

When repairs are necessary, Sheet Steel Gear Cases can be more quickly repaired, as they can be handled in pits or repair shops by one man, since they weigh from 50 to 75 pounds less than malleable cases.

If a Lyon Case is struck by a cobble stone or other object, it does not break, but simply bends and can be easily reformed with a hammer, at practically no expense. We are glad to send sample gear cases on trial. Give us the motor ratio and the style of motor and allow us to send samples on trial.

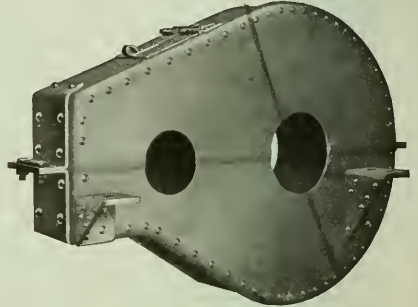

Patented May, 1905, and December, 1906

## ELECTRIC SERVICE SUPPLIES CO.

Railway Material & Electrical Supplies

MAYER & ENGLUND DEPT.  
PHILADELPHIA

NEW YORK

GARTON-DANIELS DEPT.  
KEOKUK

PITTSBURG    SAINT LOUIS

PORTER & BERG DEPT.  
CHICAGO

ATLANTA

# National Air Compressors

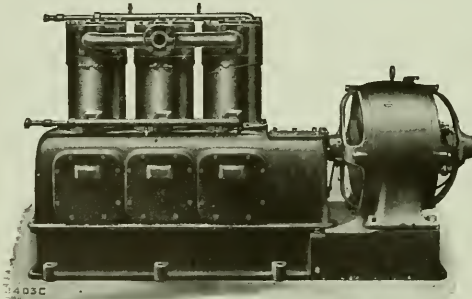

100 cu. ft. Type "3VS" Air Compressor.

These Compressors are especially adapted for service in car shops and barns, where compressed air is used, for various industrial operations, as well as for blowing dust and other accumulations out of car motors, controllers and seats.

Either direct or alternating current motors can be furnished for operating same.

Automatic starters which start and stop the Compressors and keep the air supply within the desired range of pressures are furnished with each Compressor.

Type "3VS" Compressors are built in capacities of 50, 100, 150 and 225 cu. ft. of free air per minute.

Write for Bulletin 84-F

## National Brake & Electric Company

MILWAUKEE, WIS., U. S. A.

NEW YORK: 111 Broadway

SAN FRANCISCO, CAL.: W. F. McKenny, 69-71 First St.

PHILADELPHIA: W. H. Goble, 1722 Westmoreland St.

BOSTON: F. E. Huntress, 131 State St.

LONDON: 14 Great Smith St., Westminster

General Sales Office: 519 First National Bank Building, Chicago

# Westinghouse

## Steam Turbines

The first heavy-duty steam turbines in the field, and the first in position today. Over 1,250,000 horsepower in operation or in course of erection. A Westinghouse Steam Turbine, once installed, has never been displaced.

Ask about our Non-Condensing Steam Turbines, for use where cooling water is not available.

Ask about our Exhaust-Steam Turbines, which operate on the exhaust steam now wasted from non-condensing engines, pumps, compressors, etc.

Steam Turbine Catalogue 7002 mailed upon request.

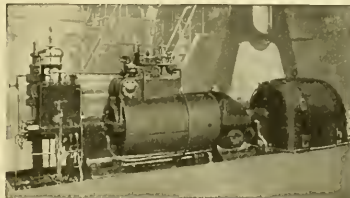

## The Westinghouse Machine Co.

Steam Turbines, Steam Engines, Gas Engines, Gas Producers, Storage Batteries and The Roney Stoker

New York, 165 Broadway  
 Boston, 131 State Street  
 Atlanta, Candler Building  
 St. Louis, Chemical Building

Pittsburg, Westinghouse Building  
 Cleveland, New England Building  
 Chicago, 111 La Salle Street  
 Cincinnati, Traction Building

Philadelphia, North American Building  
 Denver, McPhee Building  
 San Francisco, Hunt, Mirk & Co.

## M. P. Lightning Arresters

are single pole for use on potentials not exceeding 1000 volts, and can be located on a car, on a pole or in the station.



They embody a new principle in protective apparatus.

The static discharge spreads itself over a carborundum block along a number of minute discharge paths.

The voltage across each gap being very small, the line voltage cannot maintain an arc across them.

Circulars 1132 and 1146 for particulars.

## Westinghouse Electric & Mfg. Co.

Atlanta	Cincinnati	Kansas City	New York	Salt Lake City
Baltimore	Cleveland	Los Angeles	Philadelphia	San Francisco
Boston	Dallas	Minneapolis	Pittsburg	Seattle
Buffalo	Denver	New Orleans	St. Louis	Syracuse
Chicago	Detroit	Mexico	G. & O. Braniff & Co.	City of Mexico

Canada: Canadian Westinghouse Co., Ltd., Hamilton, Ont.

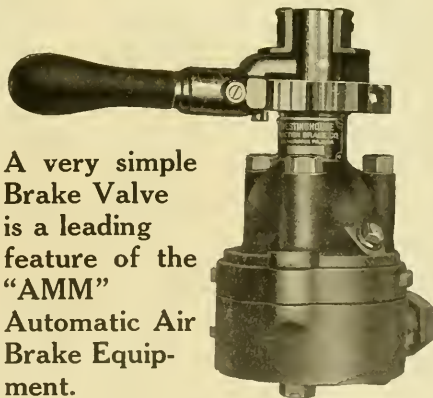

A very simple Brake Valve is a leading feature of the "AMM" Automatic Air Brake Equipment.

This brake valve in release position makes a wide open connection from the feed valve to the brake pipe, as there is always feed valve pressure on top of the rotary valve instead of main reservoir pressure. This is of special value in handling single cars, the overcharging of the brake system being thereby made impossible. This, in connection with the quick-recharge, graduated-release and high-pressure-in-emergency features of the "AMM" equipment, makes it possible to handle single cars, or trains up to five cars, with a flexibility and safety otherwise impossible.

Westinghouse Traction Brake Co.  
 Pittsburg, Pa.

## ALPHABETICAL INDEX TO ADVERTISEMENTS.

Advance Lumber Co. ....18	Dearborn Drug & Chemical Works .....23	Miller Anchor Co. ....14	Standard Brake Shoe Co. ....14
Allis-Chalmers Co. ....11	Dossert & Co. ....13	Model Stoker Co. ....14	Standard Motor Truck Co. ....11
Aluminum Co. of America. ....11	Drouvé, G. Co. ....13	Morden Frog & Crossing Wks.16	Standard Paint Co. ....14
American Brake Shoe & Fdry. Co. ....13	Eclipse Railway Supply Co. ....10	National Brake & Electric Co. 2	Standard Steel Works Co. ....16
American Electrical Works. ....13	Electric Railway Equipment Co. ....15	National Brake & Electric Co. 2	Standard Underground Cable Co. ....10
Anderson, Albert & J. M., Mfg. Co. ....19	Electric Ry. Improvement Co.15	National Lock Washer Co. ....21	Star Brass Works. ....16
Armstrong Oiler Co. ....14	Electric Service Supplies Co. 2	National Pole Co. ....13	Stone Master Engineering Corporation. ....16
Arnold Company. ....14	Engineers and Contractors. ....14	National Tube Co. ....23	Stuart-Howland Co. ....26
Atha Steel Casting Co. ....23	Fairbanks, Morse & Co. ....17	Naugle Pole & Tie Co. ....18	Symington, T. H. Co. ....26
Automatic Trolley Guard Co. ....18	Ford, Bacon & Davis. ....12	New York Switch & Crossing Co. ....16	Telegraph Signal Co. ....19
Babcock & Wilcox Co. ....11	Galena-Signal Oil Co. ....13	Niles Car & Mfg. Co. ....17	Trolley Supply Co. ....12
Baker, Wm. C., Heating & Supply Co. ....17	Garford Co. ....13	North American Engineering Works. ....19	U. S. Metal & Mfg. Co. ....12
Baldwin Locomotive Works. ....16	General Electric Co. ....25	Ohio Brass Co. ....5	Van Dorn & Dutton Co. ....14
Barbour-Stockwell Co. ....19	Green Engineering Co. ....14	Okonite Co., Ltd. ....12	Van Dorn, W. T. Co. ....26
Barnes, G. H., Hardwood Lumber Co. ....18	Griffin Wheel Co. ....14	Pacific Coast Pole Co. ....18	Van Valkenburgh, E. C. ....26
Beidler, Francis, & Co. ....18	Hagy, J. Milton, Waste Wks.11	Pantastoc Co. ....12	Wanted and For Sale Cards. ....20, 21
Bellamy Vestlette Mfg. Co. ....18	Hals & Kilburn Mfg. Co. ....12	Patten, Paul E. ....9	Wasburn Steel Castings & Coupler Co. ....21
Berthold & Jennings. ....13	Hartshorn Co., Stewart. ....14	Pay-As-You-Enter Car Co. ....9	Watson-Stillman Co. ....12
Bridgeport Brass Co. ....19	Heine Safety Boiler Co. ....14	Specialty Co. ....12	Western Electric Co. ....5
Brill, J. G. Co. ....24	Heywood Bros. & Wakefield Co. ....14	Pressed Steel Car Co. ....12	Westinghouse Electric & Mfg. Co. ....3
Brown, Harold P. ....14	Holman, D. F., Ry. Tracklayer Co. ....16	Rail Joint Co. ....16	Westinghouse Machine Co. ....3
Brown Hoisting Machy. Co. ....14	Humbird Lumber Co., Ltd. ....12	Railway Specialty & Supply Co. ....14	Westinghouse Traction Brake Co. ....3
Buckeye Engine Co. ....19	Jewett Car Co. ....17	Railway Steel-Spring Co. ....14	Weston Electrical Instrument Co. ....26
Burnham, Williams & Co. ....16	Johns-Manville, H. W. Co. ....5	Register Co. ....14	Wharton, Wm., Jr., & Co. ....26
Bylesby, H. M., & Co. ....14	Kalamazoo Ry. Supply Co. ....21	Robertson, Wm., & Co. ....12	Wheeler Condenser & Eng'g Co. ....12
Central Inspection Bureau. ....14	Lindsay Bros. Co. ....18	Rodger Ballast Car Co. ....14	White, J. G., & Co. ....14
Chase-Shawmut Co. ....15	Lord & Burnham Co. ....12	Rooke Automatic Register Co.22	Whitmore Mfg. Co. ....19
Chicago Mica Co. ....19	Lufkin, Rule Co. ....26	Russell Car & Snow-Plow Co.21	Wilson, J. G. Mfg. Co. ....19
Churchill Cedar Co. ....18	Lumen Bearing Co. ....14	S-E. Missouri Cypress Co. ....18	Woodbury Carlton Co. ....19
Cincinnati Car Co. ....18	Macallen Co. ....17	St. Louis Car Co. ....7	Woodbury Carlton Co. ....19
Cleveland Frog & Cross. Co. ....14	McGuire-Cummings Mfg. Co.17	St. Louis Car Wheel Co. ....14	Woodman, R. Mfg. & Supply Co. ....12
Collier, Barron G. ....14	Marshall, R. W., & Co. ....21	Sanderson & Porter. ....14	Worcester, C. H. Co. ....18
Consolidated Car Fender Co.14	Meyers, Fred J., Mfg. Co. ....21	Saxton, E. ....14	Zelnicker, Walter A., Supply Co. ....21
Consolidated Car-Heating Co.14	Michigan Steel Boat Co. ....14	Sheaff & Jastaad. ....12	
Contractors' Supply & Equipment Co. ....14		Shelby Electric Co. ....12	
Crane Co. ....14		Simmons Engineering Co. ....12	
Craghead Engineering Co. ....14		Smith, Peter, Heater Co. ....14	
Curtain Supply Co. ....14		Speer Carbon Co. ....14	
Davis, John, Co. ....12			

## CLASSIFIED LIST OF ADVERTISERS.

<b>Advertising Designs and Plates.</b> Woodbury-Carlton Co., Worcester, Mass.	<b>Badges and Buttons.</b> Electric Service Supplies Co., 200 Plymouth Bldg., Chicago.	<b>Boilers—Continued.</b> Hins Safety Boiler Co., 421 Olive St., St. Louis. Lord & Burnham, Irvington-on-Hudson, N. Y.	<b>Brakes and Brake Parts—Continued.</b> Stephenson, John, Co., Elizabeth, N. J. Wason Mfg. Co., Springfield, Mass. Westinghouse Traction Brake Co., Pittsburg, Pa.
<b>Advertising Service.</b> Van Valkenburgh, E. C., 2117 West One Hundred and Second St., Chicago.	<b>Ballast Cars—(See Cars, Ballast).</b>	<b>Boiler Cleaning Compounds.</b> Dearborn Drug & Chemical Works, Chicago. Johns-Manville, H. W., Co., New York.	<b>Brakeshoes.</b> American Brake Shoe & Fdry. Co., Mahwah, N. J. American Car Co., St. Louis. Barbour-Stockwell Co., Cambridgeport, Mass. Brill, J. G. Co., Philadelphia. Kuhlman, G. C., Car Co., Cleveland. McGuire-Cummings Mfg. Co., Chicago. Marshall, R. W., & Co., 95 Liberty St., New York. St. Louis Car Co., St. Louis. Standard Brake Shoe Co., Aurora, Ill. Stephenson, John, Co., Elizabeth, N. J. Wason Mfg. Co., Springfield, Mass. Wharton, Wm., Jr., & Co., Philadelphia.
<b>Advertising, Street Car.</b> Collier, Barron G., Flat Iron Bldg., New York.	<b>Ball Bearings.</b> Symington, T. H., Co., Baltimore, Md.	<b>Bonds, Rail.</b> Brown, H. P., 120 Liberty St., New York Chase-Shawmut Co., Newburyport, Mass. Electric Railway Improvement Co., Cleveland, O. Electric Service Supplies Co., 200 Plymouth Bldg., Chicago. General Electric Co., Schenectady, N. Y. Lumen Bearing Co., Buffalo, N. Y. McGuire-Cummings Mfg. Co., Chicago. Marshall, R. W., & Co., 95 Liberty St., New York. Nuttall, R. D., Co., Pittsburg. Ohio Brass Co., Mansfield, O. Symington, T. H., Co., Baltimore, Md. Van Dorn & Dutton Co., Cleveland, O.	<b>Bridge Timbers.</b> Beidler, Francis, & Co., Chicago.
<b>Air Brakes—(See Brakes and Brake Parts).</b>	<b>Bases—(See Trolley Poles and Fittings).</b>	<b>Brackets and Cross Arms.</b> Anderson, Albert & J. M., Mfg. Co., Boston. Craghead Engineering Co., Cincinnati, O. Electric Railway Equipment Co., Cincinnati, O. Electric Service Supplies Co., 200 Plymouth Bldg., Chicago. Johns-Manville, H. W., Co., New York Lindsay Bros. Co., Spokane, Wash. Ohio Brass Co., Mansfield, O. Stuart-Howland Co., Boston. Western Electric Co., Chicago.	<b>Brushes, Motor and Dynamo.</b> Electric Service Supplies Co., 200 Plymouth Bldg., Chicago. General Electric Co., Schenectady, N. Y. Speer Carbon Co., St. Marys, Pa.
<b>Air Compressors—(See Compressors, Air).</b>	<b>Bearings.</b> Electric Service Supplies Co., 200 Plymouth Bldg., Chicago. General Electric Co., Schenectady, N. Y. Lumen Bearing Co., Buffalo, N. Y. McGuire-Cummings Mfg. Co., Chicago. Marshall, R. W., & Co., 95 Liberty St., New York. Nuttall, R. D., Co., Pittsburg. Ohio Brass Co., Mansfield, O. St. Louis Car Co., St. Louis. Stephenson, John, Co., Elizabeth, N. J. Wason Mfg. Co., Springfield, Mass. Western Electric Co., Chicago.	<b>Bumper Cars.</b> American Car Co., St. Louis. Brill, J. G., Co., Philadelphia. Kuhlman, G. C., Car Co., Cleveland. St. Louis Car Co., St. Louis. Stephenson, John, Co., Elizabeth, N. J. Wason Mfg. Co., Springfield, Mass.	<b>Car House Doors.</b> Wilson, J. G., Mfg. Co., New York.
<b>Alloys and Bearing Metals.</b> Brown, H. P., 120 Liberty St., New York. General Electric Co., Schenectady, N. Y. Lumen Bearing Co., Buffalo, N. Y. Ohio Brass Co., Mansfield, O. St. Louis Car Co., St. Louis, Mo.	<b>Bells and Gongs.</b> American Car Co., St. Louis. Brill, J. G. Co., Philadelphia. Electric Service Supplies Co., 1020-24 Filbert St., Phila. Kuhlman, G. C., Car Co., Cleveland. McGuire-Cummings Mfg. Co., Chicago. National Tube Co., Pittsburg, Pa. Ohio Brass Co., Mansfield, O. St. Louis Car Co., St. Louis. Stephenson, John, Co., Elizabeth, N. J. Wason Mfg. Co., Springfield, Mass.	<b>Block System—(See Signals).</b>	<b>Car Replacers.</b> Electric Service Supplies Co., 200 Plymouth Bldg., Chicago.
<b>Aluminum Wire, Etc.</b> Aluminum Co. of America, Pittsburg.	<b>Blue Printing Machines.</b> Buckeye Engine Co., Salem, O.	<b>Boilers.</b> Babcock & Wilcox Co., New York. Fairbanks, Morse & Co., Chicago.	
<b>Anchors.</b> Electric Service Supplies Co., 200 Plymouth Bldg., Chicago. Miller Anchor Co., Norwalk, O. Ohio Brass Co., Mansfield, O.			
<b>Armatures and Coils, Winding and Repairing.</b> Electric Service Supplies Co., 200 Plymouth Bldg., Chicago. General Electric Co., Schenectady, N. Y. Marshall, R. W., & Co., 95 Liberty St., New York. Stuart-Howland Co., Boston.			
<b>Armature Lifts.</b> Electric Service Supplies Co., 200 Plymouth Bldg., Chicago.			
<b>Asbestos Materials.</b> Johns-Manville, H. W., Co., New York.			
<b>Axles—(See Wheels and Axles).</b>			
<b>Babbitt Metals—(See Alloys and Bearing Metals).</b>			

# WESTERN ELECTRIC COMPANY

CHICAGO DENVER PITTSBURG SAINT PAUL NEW YORK  
 SAINT LOUIS PITTSBURG CINCINNATI ATLANTA  
 SAN FRANCISCO SEATTLE SALT LAKE CITY LOS ANGELES KANSAS CITY PHILADELPHIA

## A. C. GENERATORS

From your standpoint as the user, the three most important features of A. C. GENERATORS to be considered are Heating, Regulation and Efficiency.

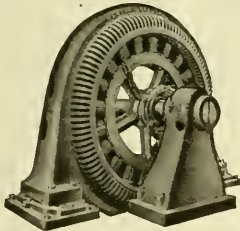

The heating is kept low by a generous and especially well ventilated design of those parts in which heat is developed.

Perfect regulation is obtained by so proportioning the parts as to reduce to the lowest possible value the quantities which tend most strongly against good regulation.

### WESTERN ELECTRIC A. C. GENERATORS

will give you the highest average or all-day efficiency.

Send for a copy of our Catalogue No. 5210-C on Alternators.

## Why Take Chances When Buying Tape?

Why not test it before buying and be sure of what you buy — the same as most large and careful buyers do — instead of taking chances of getting tape that is full of pinholes, lumps and bad spots and that has only enough friction to make it stick for a short time.

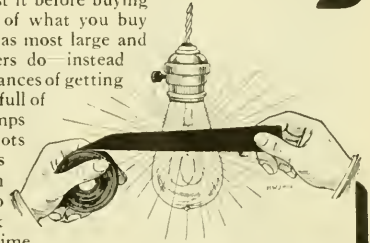

## JOMANCO FRICTION TAPE

will show no pinholes or thin spots under the strongest light. You can examine it with a magnifying glass and not find any lumps in the composition. The fabric will support a 37 lb. weight without breaking. And its exceptional friction is shown by the fact that it takes 1 hour and 25 minutes for a 2 lb. weight to unroll 10 feet.

Write Nearest Branch for Sample and Booklet.

## H. W. JOHNS-MANVILLE CO.

NEW YORK  
 MILWAUKEE  
 CHICAGO  
 BOSTON  
 PHILADELPHIA  
 ST. LOUIS

PITTSBURG  
 CLEVELAND  
 BUFFALO  
 BALTIMORE  
 SAN FRANCISCO  
 LOS ANGELES

SEATTLE  
 KANSAS CITY  
 MINNEAPOLIS  
 NEW ORLEANS  
 DALLAS  
 LONDON

811

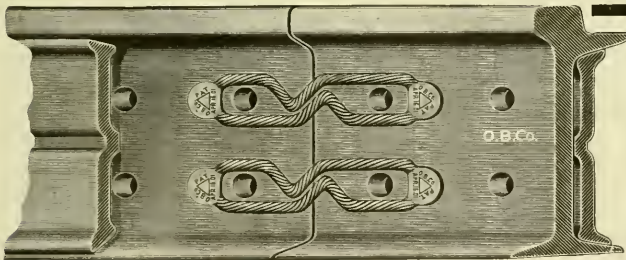

## There Are No JOINTS

IN

## "All Wire" Bonds

### "All Wire" Compressed Terminal Rail Bonds

❑The "ONE PIECE" construction of "All Wire" Bonds ELIMINATES the internal resistance caused by joining bond terminals to the body by welding or other processes.

❑The body and terminals of "ALL WIRE" BONDS are formed from ONE CONTINUOUS PIECE of flexible copper cable and the uniform conductivity throughout the ENTIRE bond EQUALS that of pure drawn copper.

❑The strands are not bent at acute angles; vibratory stresses are evenly distributed throughout the bond so that a maximum durability is obtained.

See Catalogue No. 7, Pages 173-222, for Bonds and Bonding Tools

# THE OHIO BRASS COMPANY

Main Office—MANSFIELD, OHIO, U. S. A.—Works

NEW YORK—32 Cortlandt Street

ST. LOUIS—10 North 4th Street

CHICAGO—27 Dearborn Street

BURT GELLATLY, 223 Fourth Avenue, PITTSBURG

PIERSON, ROEDING & CO., SAN FRANCISCO. LOS ANGELES. SEATTLE

## CLASSIFIED LIST OF ADVERTISERS—Continued.

- Car Replacers—Continued.**  
Fairbanks, Morse & Co., Chicago.  
Kalamazoo Railway Supply Co., Kalamazoo, Mich.  
Ohio Brass Co., Mansfield, O.  
U. S. Metal & Mfg. Co., 25 Broad St., New York.
- Car Seats.**  
American Car Co., St. Louis.  
Brill, J. G., Co., Philadelphia.  
Hale & Kilburn Mfg. Co., Philadelphia.  
Heywood Bros. & Wakefield Co., Wakefield, Mass.  
Kuhlman, G. C., Car Co., Cleveland.  
St. Louis Car Co., St. Louis.  
Stephenson, John, Co., Elizabeth, N. J.  
Wason Mfg. Co., Springfield, Mass.
- Car Steps.**  
Electric Service Supplies Co., 200 Plymouth Bldg., Chicago.
- Car Trimmings—(See Trimmings, Car).**
- Cars, Ballast.**  
Rodger Ballast Car Co., Chicago.  
St. Louis Car Co., St. Louis.
- Cars, Dump.**  
Fairbanks, Morse & Co., Chicago.  
Rodger Ballast Car Co., Chicago.  
Russell Car & Snow-Plow Co., Ridgway, Pa.  
St. Louis Car Co., St. Louis.
- Cars, Passenger and Freight.**  
American Car Co., St. Louis.  
Brill, J. G., Co., Philadelphia.  
Cincinnati Car Co., Cincinnati.  
Detroit Carbuilding & Equipment Co., Detroit, Mich.  
Electric Railway Improvement Co., Cleveland, O.  
Fairbanks, Morse & Co., Chicago.  
Jewett Car Co., Newark, O.  
Kuhlman, G. C., Car Co., Cleveland.  
McGuire-Cummings Mfg. Co., Chicago.  
Niles Car & Mfg. Co., Niles, O.  
Pressed Steel Car Co., Pittsburg.  
Rodger Ballast Car Co., Chicago.  
Russell Car & Snow-Plow Co., Ridgway, Pa.  
St. Louis Car Co., St. Louis.  
Standard Motor Truck Co., Pittsburg.  
Stephenson, John, Co., Elizabeth, N. J.  
Wason Mfg. Co., Springfield, Mass.
- Cars, Pay-As-You-Enter.**  
Pay-As-You-Enter Car Co., 26 Cortlandt St., New York.
- Cars, Rebuilt.**  
Detroit Carbuilding & Equipment Co., Detroit, Mich.
- Cars, Second-Hand.**  
Detroit Carbuilding & Equipment Co., Detroit, Mich.  
Marshall, R. W., & Co., 95 Liberty St., New York.  
Zelmecker, Walter A., Supply Co., St. Louis.
- Cars, Steel.**  
Pressed Steel Car Co., Pittsburg.  
St. Louis Car Co., St. Louis.  
Standard Motor Truck Co., Pittsburg.
- Castings, Brass.**  
Star Brass Works, Kalamazoo, Mich.
- Castings, Iron and Steel.**  
American Brake Shoe & Foundry Co., Mahwah, N. J.  
Green Engineering Co., Com'l Nat. Bk. Bldg., Chicago.  
National Brake & Electric Co., Milwaukee.  
Standard Steel Works Co., Philadelphia, Pa.  
Washburn Steel Castings & Coupler Co., Minneapolis.
- Catchers—(See Trolley Retrievers and Catchers).**
- Cattleguards.**  
Fairbanks, Morse & Co., Chicago.
- Circuit-Breakers.**  
Electric Service Supplies Co., 200 Plymouth Bldg., Chicago.  
General Electric Co., Schenectady, N. Y.  
Western Electric Co., Chicago.
- Coal Handling Machinery—(See Conveyors).**
- Coils—(See Armatures and Coils).**
- Commutators and Parts.**  
Electric Service Supplies Co., 200 Plymouth Bldg., Chicago.  
General Electric Co., Schenectady, N. Y.  
Marshall, R. W., & Co., 95 Liberty St., New York.  
Ohio Brass Co., Mansfield, O.  
Stuart-Howland Co., Boston.
- Compressors, Air.**  
Fairbanks, Morse & Co., Chicago.  
General Electric Co., Schenectady, N. Y.  
National Brake & Electric Co., Milwaukee.  
Westinghouse Traction Brake Co., Pittsburg.
- Concrete Mixers.**  
Contractors' Supply & Equip. Co., Chicago.
- Condensers.**  
Wheeler Condenser & Engineering Co., Carteret, N. J.
- Conduits.**  
Electric Service Supplies Co., 200 Plymouth Bldg., Chicago.  
Western Electric Co., Chicago.
- Connectors, Solderless.**  
Dossert & Co., 242 W. Forty-first St., New York.
- Contractors.**  
Arnold Company, 131 La Salle St., Chicago.  
Byllesby, H. M., Co., Am. Trust Bldg., Chicago.  
Columbia Construction Co., Milwaukee, Wis.  
Creaghead Engineering Co., Cincinnati, O.  
Green Engineering Co., Com'l Nat. Bk. Bldg., Chicago.  
Register, A. L., & Co., 112 N. Broad St., Philadelphia.  
Sanderson & Porter, 52 William St., New York.  
Saxton, E., 841 Bladensburg Rd., Washington, D. C.  
Sheff & Jaastad, 88 Broad St., Boston.  
Stone & Webster Engineering Corporation, Boston.  
Wharton, Wm., Jr., & Co., Philadelphia.  
White, J. G., & Co., 49 Exchange Pl., New York.
- Controllers and Attachments.**  
Electric Service Supplies Co., 200 Plymouth Bldg., Chicago.  
General Electric Co., Schenectady, N. Y.  
Johns-Manville, H. W., Co., New York.  
Marshall, R. W., & Co., 95 Liberty St., New York.  
Western Electric Co., Chicago.  
Westinghouse Electric & Mfg. Co., Pittsburg.
- Conveyors and Coal Handling Machinery.**  
Green Engineering Co., Com'l Nat. Bk. Bldg., Chicago.  
Northern Engineering Works, Detroit, Mich.
- Cord, Bell and Trolley.**  
American Car Co., St. Louis.  
Brill, J. G., Co., Philadelphia.  
Electric Service Supplies Co., 1026-24 Filbert St., Phila.  
Kuhlman, G. C., Car Co., Cleveland.  
St. Louis Car Co., St. Louis.  
Stephenson, John, Co., Elizabeth, N. J.  
Stuart-Howland Co., Boston.  
Wason Mfg. Co., Springfield, Mass.
- Couplers, Car.**  
American Car Co., St. Louis.  
Brill, J. G., Co., Philadelphia.  
Kuhlman, G. C., Car Co., Cleveland.  
McGuire-Cummings Mfg. Co., Chicago.  
Ohio Brass Co., Mansfield, O.  
St. Louis Car Co., St. Louis.  
Stephenson, John, Co., Elizabeth, N. J.
- Couplers, Car—Continued.**  
Van Dorn, W. T., Co., Paulina St., Chicago.  
Washburn Steel Castings & Coupler Co., Minneapolis.  
Wason Mfg. Co., Springfield, Mass.
- Coverings, Pipe and Boiler.**  
Johns-Manville, H. W., Co., New York.
- Cranes, Hoists and Lifts.**  
American Car Co., St. Louis.  
Brill, J. G., Co., Philadelphia.  
Brown Hoisting Machinery Co., Cleveland, O.  
Kuhlman, G. C., Car Co., Cleveland.  
Northern Engineering Works, Detroit, Mich.  
Railway Specialty & Supply Co., Chicago.  
Stephenson, John, Co., Elizabeth, N. J.  
Van Dorn & Dutton Co., Cleveland, O.  
Wason Mfg. Co., Springfield, Mass.
- Cross Arms—(See Brackets and Cross Arms).**
- Crossing Gates—(See Gates and Guards).**
- Crossings, Track—(See Switches, Frogs and Crossings).**
- Curtains, Fixtures and Materials.**  
American Car Co., St. Louis.  
Brill, J. G., Co., Philadelphia.  
Curtain Supply Co., 93 Ohio St., Chicago.  
Electric Service Supplies Co., 200 Plymouth Bldg., Chicago.  
Hartshorn Co., Stewart, East Newark, N. J.  
Kuhlman, G. C., Car Co., Cleveland.  
Marshall, R. W., & Co., 95 Liberty St., New York.  
National Lock Washer Co., Newark, N. J.  
Pantastote Co., 11 Broadway, New York.  
St. Louis Car Co., St. Louis.  
Stephenson, John, Co., Elizabeth, N. J.  
Wason Mfg. Co., Springfield, Mass.
- Cylinder Oil.**  
Powell Specialty Co., 111 Broadway, New York.
- Derailing Devices.**  
Cleveland Frog & Crossing Co., Cleveland, O.
- Doors and Fixtures.**  
American Car Co., St. Louis.  
Brill, J. G., Co., Philadelphia.  
Kuhlman, G. C., Car Co., Cleveland.  
St. Louis Car Co., St. Louis.  
Stephenson, John, Co., Elizabeth, N. J.  
Wason Mfg. Co., Springfield, Mass.
- Doors, Steel Rolling.**  
Wilson, J. G., Mfg. Co., New York.
- Draft Rigging.**  
Van Dorn, W. T., Co., Chicago.  
Washburn Steel Castings & Coupler Co., Minneapolis.
- Drills, Track.**  
Brown, H. P., 120 Liberty St., New York.  
Electric Service Supplies Co., 200 Plymouth Bldg., Chicago.  
Fairbanks, Morse & Co., Chicago.  
Kalamazoo Railway Supply Co., Kalamazoo, Mich.  
Marshall, R. W., & Co., 95 Liberty St., New York.
- Dynamos and Generators.**  
Fairbanks, Morse & Co., Chicago.  
General Electric Co., Schenectady, N. Y.  
National Brake & Electric Co., Milwaukee, Wis.  
Western Electric Co., Chicago.  
Westinghouse Electric & Mfg. Co., Pittsburg, Pa.
- Electrical Instruments.**  
Electric Service Supplies Co., 200 Plymouth Bldg., Chicago.  
General Electric Co., Schenectady, N. Y.
- Electrical Instruments—Continued.**  
Johns-Manville, H. W., Co., New York.  
Queen & Co., Philadelphia.  
Western Electric Co., Chicago.  
Westinghouse Electric & Mfg. Co., Pittsburg, Pa.  
Weston Electrical Instrument Co., Newark, N. J.
- Electric Railway Supplies, General.**  
Creaghead Engineering Co., Cincinnati, O.  
Electric Service Supplies Co., 200 Plymouth Bldg., Chicago.  
Fairbanks, Morse & Co., Chicago.  
General Electric Co., Schenectady, N. Y.  
Johns-Manville, H. W., Co., New York.  
Marshall, R. W., & Co., 95 Liberty St., New York.  
Ohio Brass Co., Mansfield, O.  
Stuart-Howland Co., Boston.  
Western Electric Co., Chicago.
- Engineers and Contractors.**  
Arnold Company, Chicago.  
Eylesby, H. M., & Co., Chicago.  
Columbia Construction Co., Milwaukee, Wis.  
Ford, Bacon & Davis, New York.  
Register, A. L., & Co., Philadelphia.  
Sanderson & Porter, New York.  
Saxton, E., Washington, D. C.  
Sheff & Jaastad, Boston.  
Stone & Webster Engineering Corporation, Boston.  
White, J. G., & Co., New York.
- Engines, Gas and Oil.**  
Buckeye Engine Co., Salem, O.  
Fairbanks, Morse & Co., Chicago.  
Westinghouse Machine Co., Pittsburg.
- Engines, Hoisting.**  
Fairbanks, Morse & Co., Chicago.
- Engines, Steam.**  
Buckeye Engine Co., Salem, O.  
Westinghouse Machine Co., Pittsburg.
- Fans, Exhaust and Ventilating.**  
General Electric Co., Schenectady, N. Y.  
Western Electric Co., Chicago.  
Westinghouse Elec. & Mfg. Co., Pittsburg.
- Fare Boxes—(See Electric Railway Supplies).**
- Fare Registers and Register Fittings.**  
Electric Service Supplies Co., 200 Plymouth Bldg., Chicago.  
Rooke Automatic Register Co., Providence, R. I.
- Feed Water Apparatus.**  
Wheeler Condenser & Engineering Co., Carteret, N. J.
- Feed Wire—(See Wire and Cables).**
- Fenders and Guards.**  
Consolidated Car Fender Co., Providence, R. I.  
Eclipse Railway Supply Co., Cleveland, O.  
Electric Service Supplies Co., 1026-24 Filbert St., Phila.  
McGuire-Cummings Mfg. Co., Chicago.  
Marshall, R. W., & Co., 95 Liberty St., New York.
- Flangers, Snow.**  
Kalamazoo Railway Supply Co., Kalamazoo, Mich.  
McGuire-Cummings Mfg. Co., Chicago.
- Fuses and Fuse Devices.**  
Chase-Shawmut Co., New York, Mass.  
Electric Service Supplies Co., 200 Plymouth Bldg., Chicago.  
General Electric Co., Schenectady, N. Y.  
Johns-Manville, H. W., Co., New York.

# ST. LOUIS CAR CO. ST. LOUIS - MO.



## St. Louis Car Company's Semi-Convertible Type

The illustration represents one of the cars recently shipped by us to the Houston Electric Company, Houston, Texas.

These cars are of our own design—a practically perfect Semi-Convertible type. Both lower and upper sashes raise into the roof. They move easily and when in the roof pockets are securely fastened, with no possible danger of falling and injuring passengers.

### Our construction of the Semi-Convertible Car is the very best that has yet been devised

These Houston cars are 28' over corner posts and 31' 6" over all. Width over arm rail, 8' 6". They are finished with very handsomely figured mahogany, provided with curtains at each window and each door opening and have the St. Louis Car Company's latest improved "Walkover" seat.

The cars are mounted on St. Louis Car Company's No. 47 Short Wheel Base Truck, which has been adopted as standard in a great many of the larger cities. The channel-iron and steel construction of the "Robertson type" permits the arm rail of the car to be placed very low and adds much to the appearance.

*Photographs, Blue Prints and Specifications will be mailed upon request.*

## CLASSIFIED LIST OF ADVERTISERS—Continued.

**Fuses and Fuse Devices—Continued.**  
Western Electric Co., Chicago.  
Westinghouse Elec. & Manufacturing Co., Pittsburg.

**Gaskets, Bronze.**  
Power Specialty Co., 111 Broadway, New York.

**Gates and Guards.**  
Kalamazoo Railway Supply Co., Kalamazoo, Mich.

**Gear Cases.**  
Electric Service Supplies Co., 200 Plymouth Bldg., Chicago.  
General Electric Co., Schenectady, N. Y.  
Marshall, R. W., & Co., 95 Liberty St., New York.

**Gears and Pinions.**  
Atha Steel Casting Co., Newark, N. J.  
Electric Service Supplies Co., 200 Plymouth Bldg., Chicago.  
General Electric Co., Schenectady, N. Y.  
Marshall, R. W., & Co., 95 Liberty St., New York.  
Nuttall, R. D., Co., Pittsburg.  
Van Dorn & Dutton Co., Cleveland, O.

**Generators—(See Dynamos).**

**Gongs—(See Bells and Gongs).**

**Graphite Paint—(See Paint).**

**Grates, Chain.**  
Green Engineering Co., Com'l Nat. Bk. Bldg., Chicago.

**Grease—(See Lubricants).**

**Grinders.**  
Brown, H. P., 120 Liberty St., New York.

**Ground Connection Clamps.**  
Chase-Shawmut Co., Newburyport, Mass.

**Guy Anchors—(See Anchors).**

**Harps, Trolley—(See Trolley Poles and Fittings).**

**Headlights.**  
Electric Service Supplies Co., 200 Plymouth Bldg., Chicago.  
Fairbanks, Morse & Co., Chicago.  
General Electric Co., Schenectady, N. Y.  
St. Louis Car Co., St. Louis.  
Stuart-Howland Co., Boston.  
Trolley Supply Co., Canton, O.

**Heaters, Car, Electric.**  
Consolidated Car-Heating Co., New York, N. Y.  
Johns-Manville, H. W., Co., New York.

**Heaters, Car, Hot Water, and Stoves.**  
Baker, Wm. C., Heating & Sup. Co., New York.  
McGuire-Cummings Mfg. Co., Chicago.

Smith, Peter, Heater Co., Detroit, Mich.

**Hoists—(See Cranes, Hoists and Lifts).**

**Hose Bricks.**  
Ohio Brass Co., Mansfield, O.

**Hydraulic Machinery.**  
Watson-Stillman Co., 26 Cortlandt St., New York.

**Inspection.**  
Central Inspection Bureau, 17 State St., New York.

**Inspection Cars, Gasoline.**  
Stover Motor Car Co., Freeport, Ill.

**Instruments, Measuring and Testing—(See Electrical Instruments).**

**Insulating Tapes.**  
General Electric Co., Schenectady, N. Y.  
Johns-Manville, H. W., Co., New York.  
Okonite Co., Ltd., 253 Broadway, New York.  
Western Electric Co., Chicago.

**Insulations and Insulating Material.**  
Anderson, A. & J. M., Mfg. Co., Boston.

**Insulations and Insulating Material—Continued.**

Craghead Engineering Co., Cincinnati, O.  
Electric Railway Equipment Co., Cincinnati, O.  
Electric Service Supplies Co., 200 Plymouth Bldg., Chicago.  
General Electric Co., Schenectady, N. Y.

Johns-Manville, H. W., Co., New York.  
Macallen Company, Boston.  
Ohio Brass Co., Mansfield, O.  
Okonite Co., Ltd., 253 Broadway, New York.  
Standard Paint Co., 100 William St., New York.  
Stuart-Howland Co., Boston.  
Western Electric Co., Chicago.

**Jacks.**

American Car Co., St. Louis.  
Brill, J. G. Co., Philadelphia.  
Electric Service Supplies Co., 200 Plymouth Bldg., Chicago.  
Fairbanks, Morse & Co., Chicago.  
Kalamazoo Railway Supply Co., Kalamazoo, Mich.  
Kronit, G. C., Car Co., Cleveland.  
Marshall, R. W., & Co., 95 Liberty St., New York.  
Morden Frog & Crossing Co., Chicago.  
Stephenson, John, Co., Elizabeth, N. J.  
Wason Mfg. Co., Springfield, Mass.  
Watson-Stillman Co., 26 Cortlandt St., New York.

**Joints, Expansion—(See Steam Fittings).**

**Joints, Rail.**  
Rail Joint Co., 29 W. 34th St., New York.

**Journal Boxes.**  
American Car Co., St. Louis.  
Brill, J. G. Co., Philadelphia.  
Kuhlman, G. C., Car Co., Cleveland.  
McGuire-Cummings Mfg. Co., Chicago.

St. Louis Car Co., St. Louis.  
Stephenson, John, Co., Elizabeth, N. J.  
Symington, T. H., Co., Baltimore, Md.  
Wason Mfg. Co., Springfield, Mass.

**Journal Lubricators—(See Lubricants).**

**Journal Packing, Steel Wool.**  
Robertson, Wm., & Co., Fifth Floor Great Northern Bldg., Chicago.

**Lamps, Arc and Incandescent.**  
Anderson, A. & J. M., Mfg. Co., Boston.

Electric Service Supplies Co., 200 Plymouth Bldg., Chicago.  
General Electric Co., Schenectady, N. Y.  
Shelby Electric Co., Shelby, O.  
Stuart-Howland Co., Boston.  
Western Electric Co., Chicago.  
Westinghouse Electric & Mfg. Co., Pittsburg, Pa.

**Lamp Sockets.**  
Electric Service Supplies Co., 200 Plymouth Bldg., Chicago.  
General Electric Co., Schenectady, N. Y.  
Johns-Manville, H. W., Co., New York.

**Lantern Globes.**  
Railway Specialty & Supply Co., Chicago.

**Lifts—(See Cranes, Hoists and Lifts).**

**Lightning Arresters.**  
Electric Service Supplies Co., 200 Plymouth Bldg., Chicago.  
General Electric Co., Schenectady, N. Y.  
Stuart-Howland Co., Boston.  
Western Electric Co., Chicago.  
Westinghouse Elec. & Manufacturing Co., Pittsburg.

**Line Material.**  
Anderson, A. & J. M., Mfg. Co., Boston.  
Craghead Engineering Co., Cincinnati, O.  
Johns-Manville, H. W., Co., New York.  
Electric Ry. Equipment Co., Cincinnati, O.  
Electric Service Supplies Co., 200 Plymouth Bldg., Chicago.

**Line Material—Continued.**

General Electric Co., Schenectady, N. Y.  
Macallen Co., Boston.  
Marshall, R. W., & Co., 95 Liberty St., New York.  
Stuart-Howland Co., Boston.  
Western Electric Co., Chicago.

**Lock and Nut Washers.**  
National Lock Washer Co., Newark, N. J.

**Lockers, Metal.**  
Electric Service Supplies Co., 200 Plymouth Bldg., Chicago.

**Locomotives.**  
Baldwin Locomotive Works, Philadelphia.

**Locomotives, Electric.**  
American Car Co., St. Louis.  
Baldwin Locomotive Works, Philadelphia.  
Brill, J. G. Co., Philadelphia.  
General Electric Co., Schenectady, N. Y.  
Kuhlman, G. C., Car Co., Cleveland.  
McGuire-Cummings Mfg. Co., Chicago.  
Stephenson, John, Co., Elizabeth, N. J.  
Wason Mfg. Co., Springfield, Mass.  
Westinghouse Elec. & Manufacturing Co., Pittsburg.

**Locomotives, Gasoline.**  
Fairbanks, Morse & Co., Chicago.  
Stover Motor Car Co., Freeport, Ill.

**Lubricants.**  
Dearborn Drug & Chemical Works, Chicago.  
Galena-Signal Oil Co., Franklin, Pa.  
Whitmore Mfg. Co., Cleveland, O.

**Lumber.**  
Advance Lumber Co., Cleveland, O.  
Barnes, G. H., Hardwood Lumber Co., St. Louis, Mo.  
Beidler, Francis, & Co., Chicago.  
Berthold & Jennings, St. Louis.  
Lindsay Bros. Co., Spokane, Wash.  
S-E, Missouri Cypress Co., Campbell, Mo.

**Malleable Iron.**  
St. Louis Car Co., St. Louis.

**Measuring Tapes.**  
Lufkin Rule Co., Saginaw, Mich.

**Meters.**  
Johns-Manville, H. W., Co., New York.  
Queen & Co., Philadelphia.  
Weston Electrical Instrument Co., Newark, N. J.

**Mica, Raw and Manufactured.**  
Chicago Mica Co., Valparaiso, Ind.

**Motor Cars, Gasoline.**  
Stover Motor Car Co., Freeport, Ill.

**Motors, Electric.**  
Fairbanks, Morse & Co., Chicago.  
General Electric Co., Schenectady, N. Y.  
National Brake & Electric Co., Milwaukee.  
Partridge, Arthur S., 425 Olive St., St. Louis, Mo.  
Western Electric Co., Chicago.  
Westinghouse Elec. & Manufacturing Co., Pittsburg.

**Nut Locks.**  
Chase-Shawmut Co., Newburyport, Mass.  
National Lock Washer Co., Newark, N. J.  
Railway Specialty & Supply Co., Chicago.  
St. Louis Car Co., St. Louis.  
Ut. S. Metal & Mfg. Co., 25 Broad St., New York.

**Nuts and Bolts.**  
National Lock Washer Co., Newark, N. J.  
Railway Specialty & Supply Co., Chicago.

**Oilers.**  
Armstrong Oil Co., 31st and Chestnut St., Philadelphia.

**Oils—(See Lubricants).**

**Overhead Equipment—(See Electric Railway Supplies).**

**Packings.**  
Electric Service Supplies Co., 200 Plymouth Bldg., Chicago.  
Johns-Manville, H. W., Co., New York.  
Power Specialty Co., 111 Broadway, New York.

**Packing, Steel Wool Journal.**  
Robertson, Wm., & Co., Fifth Floor Great Northern Bldg., Chicago.

**Paints.**  
Standard Paint Co., 100 William St., New York.

**Pay-As-You-Enter Cars.**  
Pay-As-You-Enter Car Co., 26 Cortlandt St., New York.

**Pipe Bends and Fittings—(See Steam Fittings).**

**Poles, Metal.**  
Craghead Engineering Co., Cincinnati, O.  
Electric Railway Equipment Co., Cincinnati, O.  
Electric Service Supplies Co., 200 Plymouth Bldg., Chicago.

**Poles and Ties, Wood.**  
Advance Lumber Co., Cleveland, O.

Barnes, G. H., Hardwood Lumber Co., St. Louis, Mo.  
Beidler, Francis, & Co., Chicago.  
Berthold & Jennings, St. Louis.  
Churchill Cedar Co., Spokane, Wash.  
Humbird Lumber Co., Sand Point, Idaho.  
Lindsay Bros. Co., Spokane, Wash.  
National Pole Co., Escanaba, Mich.  
Nagle Pole & Tie Co., 226 La Salle St., Chicago.  
Pacific Coast Pole Co., Spokane, Wash.  
S-E, Missouri Cypress Co., Campbell, Mo.  
Worcester, C. H., Co., Tribune Bldg., Chicago.

**Punches—(See Ticket Punches).**

**Rail Benders.**  
Electric Service Supplies Co., 200 Plymouth Bldg., Chicago.  
Fairbanks, Morse & Co., Chicago.

**Rail Bonds—(See Bonds, Rail).**

**Rail Bonds, Flexible.**  
Chase-Shawmut Co., Newburyport, Mass.

**Rail Drills—(See Drills, Track).**

**Rail Feed Wire—(See Wire and Cables).**

**Rail Joints and Chairs—(See Joints, Rail).**

**Rails, New.**  
New York Switch & Crossing Co., Hoboken, N. J.  
Wharton, Wm., Jr., & Co., Philadelphia.

**Rails, Relaying.**  
Zelnicke, Walter A., Supply Co., St. Louis.

**Railway Velocipedes.**  
Fairbanks, Morse & Co., Chicago.  
Kalamazoo Railway Supply Co., Kalamazoo, Mich.

**Registers and Fittings—(See Fare Registers).**

**Relays.**  
Weston Electrical Instrument Co., Newark, N. J.

**Roofing.**  
Johns-Manville, H. W., Co., New York.

**Sand Apparatus.**  
American Car Co., St. Louis.  
Brill, J. G. Co., Philadelphia.  
Electric Service Supplies Co., 200 Plymouth Bldg., Chicago.





## Passengers alight from the front end of PAY-AS-YOU-ENTER CARS

and the door is under sole control of the motorman. When a stop is made, he throws a lever and the door slides open. Before starting, he releases the lever and the door closes. ¶ Confusion between passengers alighting and those entering is entirely eliminated, as they use separate doors. The time required for loading and unloading is materially cut down, too. ¶ Accidents resulting from attempts to board the front platform while car is in motion and those caused by starting while passengers are in the act of entering or leaving are also eliminated. ¶ And the company gets every passenger's fare before the car is entered.

We license manufacturers and railways to build and use the  
Pay-As-You-Enter Car, the patents on which are owned by

## The Pay-As-You-Enter Car Company

DUNCAN McDONALD,  
President

50 Church Street, New York

THOS. W. CASEY,  
Manager

## CLASSIFIED LIST OF ADVERTISERS—Continued.

- Sand Apparatus—Continued.**  
Kuhlman, G. C., Car Co., Cleveland.  
Marshall, R. W., & Co., 95 Liberty St., New York.  
Ohio Brass Co., Mansfield, O.  
St. Louis Car Co., St. Louis.  
Stephenson, John, Co., Elizabeth, N. J.  
Wason Mfg. Co., Springfield, Mass.
- Sash Balances and Fixtures.**  
National Lock Washer Co., Newark, N. J.
- Sash Operating Devices.**  
Drouvé, G. Co., Bridgeport, Conn.  
Lord & Burnham, Irvington-on-Hudson, New York.
- Seats, Car—(See Car Seats).**
- Shade Rollers—(See Curtains, Fixtures and Materials).**
- Signals.**  
Telegraph Signal Co., Rochester, N. Y.
- Signal Supplies.**  
Railway Specialty & Supply Co., Chicago.
- Skiylights.**  
Drouvé, G. Co., Bridgeport, Conn.  
Lord & Burnham, Irvington-on-Hudson, New York.
- Snow Plows, Sweepers and Scrapers.**  
American Car Co., St. Louis.  
Brill, J. G., Co., Philadelphia.  
Kalamazoo Railway Supply Co., Kalamazoo, Mich.  
Kuhlman, G. C., Car Co., Cleveland.  
McGuire-Cummings Mfg. Co., Chicago.  
Russell Car & Snow-Plow Co., Ridgway, Pa.  
Stephenson, John, Co., Elizabeth, N. J.  
Wason Mfg. Co., Springfield, Mass.
- Sockets, Waterproof.**  
Johns-Manville, H. W., Co., New York.
- Solder Paste.**  
Chase-Shawmut Co., Newburyport, Mass.
- Springs.**  
American Car Co., St. Louis.  
Brill, J. G., Co., Philadelphia.  
Kuhlman, G. C., Car Co., Cleveland.  
McGuire-Cummings Mfg. Co., Chicago.  
Marshall, R. W., & Co., 95 Liberty St., New York.  
Railway Steel-Spring Co., 71 Broadway, New York.  
St. Louis Car Co., St. Louis.  
Standard Steel Works Co., Philadelphia, Pa.  
Stephenson, John, Co., Elizabeth, N. J.  
Wason Mfg. Co., Springfield, Mass.
- Spinkling Cars.**  
American Car Co., St. Louis.  
Brill, J. G., Co., Philadelphia.  
Kuhlman, G. C., Car Co., Cleveland.  
McGuire-Cummings Mfg. Co., Chicago.  
Stephenson, John, Co., Elizabeth, N. J.  
Wason Mfg. Co., Springfield, Mass.
- Stage Pockets and Plugs.**  
Chase-Shawmut Co., Newburyport, Mass.
- Steam Fittings, Etc.**  
Crane Co., Chicago.  
Davis, John, Co., Chicago.  
National Tube Co., Pittsburg, Pa.  
Power Specialty Co., 111 Broadway, New York.  
Simmons, John, Co., 110 Centre St., New York.
- Steel Cars.**  
American Car Co., St. Louis.  
Brill, J. G., Co., Philadelphia.  
Kuhlman, G. C., Car Co., Cleveland.  
St. Louis Car Co., St. Louis.  
Stephenson, John, Co., Elizabeth, N. J.  
Wason Mfg. Co., Springfield, Mass.
- Steel Tapes.**  
Lufkin Rule Co., Saginaw.
- Stokers.**  
Babcock & Wilcox Co., 85 Liberty St., New York.  
Green Engineering Co., Com'l Nat. Bk. Bldg., Chicago.  
Model Stoker Co., Dayton, O.  
Westinghouse Machine Co., Pittsburg.
- Superheaters.**  
Power Specialty Co., 111 Broadway, New York.
- Switches, Frogs and Crossings.**  
Barbour-Stockwell Co., Cambridgeport, Mass.  
Cleveland Frog & Crossing Co., Cleveland, O.  
Fairbanks, Morse & Co., Chicago.  
Morden Frog & Crossing Co., Rooley, Chicago.  
New York Switch & Crossing Co., Hoboken, N. J.  
Railway Specialty & Supply Co., Chicago.  
Whitton, Wm., Jr., & Co., Philadelphia.
- Switchboards and Switchboard Instruments.**  
Anderson, A. & J. M., Mfg. Co., Boston.  
Chase-Shawmut Co., Newburyport, Mass.  
General Electric Co., Schenectady, N. Y.  
Western Electric Co., Chicago.  
Westinghouse Electric & Mfg. Co., Pittsburg.
- Tapes and Webbing.**  
Johns-Manville, H. W., Co., New York.  
Okonite Co., Ltd., 253 Broadway, New York.
- Testing Instruments.**  
Queen & Co., Philadelphia.  
Weston Electrical Instrument Co., Newark, N. J.
- Test Lamps, Pocket.**  
Chase-Shawmut Co., Newburyport, Mass.
- Ticket Choppers and Destroyers.**  
Patten, Paul B., Salem, Mass.
- Ticket Punches.**  
Meyers, Fred J., Mfg. Co., Hamilton, O.  
Woodman Mfg. & Sup. Co., Eoston.
- Ties and Poles, Wood—(See Poles and Ties).**
- Timber.**  
Behler, Francis, & Co., Chicago.  
Lindsay Bros. Co., Spokane, Wash.  
S. E. Missouri Cypress Co., Campbell, Mo.
- Track Cleaners and Scrapers—Continued.**  
Kalamazoo Railway Supply Co., Kalamazoo, Mich.  
Kuhlman, G. C., Car Co., Cleveland.  
McGuire-Cummings Mfg. Co., Chicago.  
Marshall, R. W., & Co., 95 Liberty St., New York.  
Ohio Brass Co., Mansfield, O.  
Stephenson, John, Co., Elizabeth, N. J.  
Van Dorn & Dutton Co., Cleveland, O.  
Wason Mfg. Co., Springfield, Mass.
- Track Drills—(See Drills, Track).**
- Tracklaying Machinery.**  
Holman, D. F., Ry. Tracklayer Co., 1102 Ellsworth Bldg., Chicago.
- Track Tools.**  
Electric Service Supplies Co., 200 Plymouth Bldg., Chicago.  
Kalamazoo Railway Supply Co., Kalamazoo, Mich.
- Trimming, Car.**  
American Car Co., St. Louis.  
Brill, J. G., Co., Philadelphia.  
Curtain Supply Co., Park Row Bldg., New York.  
Kuhlman, G. C., Car Co., Cleveland.  
National Lock Washer Co., Newark, N. J.  
St. Louis Car Co., St. Louis.  
Stephenson, John, Co., Elizabeth, N. J.  
Wason Mfg. Co., Springfield, Mass.
- Trolley Guards.**  
Automatic Trolley Guard Co., 391 Elliott Sq., Buffalo, N. Y.  
Electric Service Supplies Co., 200 Plymouth Bldg., Chicago.
- Trolley Poles and Fittings.**  
Garford Company, Elyria, O.  
General Electric Co., Schenectady, N. Y.  
Johns-Manville, H. W., Co., New York.  
Humphrey Trolley & Mfg. Co., 725 Chamber of Commerce Bldg., Detroit, Mich.  
Marshall, R. W., & Co., 95 Liberty St., New York.  
Nuttall, R. D., Co., Pittsburg.  
Star Brass Works, Kalamazoo, Mich.  
Trolley Supply Co., Canton, O.  
Westinghouse Electric & Mfg. Co., Pittsburg, Pa.
- Trolley Retrievers and Catchers.**  
Electric Service Supplies Co., 1096-24 Filbert St., Phila.  
Trolley Supply Co., Canton, O.
- Trolley Wagons.**  
Kalamazoo Railway Supply Co., Kalamazoo, Mich.
- Trolley Wheels—(See Trolley Poles and Fittings).**
- Trolley Wire—(See Wire and Cables).**
- Trucks, Car.**  
American Car Co., St. Louis.  
Baldwin Locomotive Works, Philadelphia.  
Brill, J. G., Co., Philadelphia.  
Kuhlman, G. C., Car Co., Cleveland.  
McGuire-Cummings Mfg. Co., Chicago.  
St. Louis Car Co., St. Louis.  
Standard Motor Truck Co., Pittsburg, Pa.  
Stephenson, John, Co., Elizabeth, N. J.  
Van Dorn & Dutton Co., Cleveland, O.
- Trucks, Car—Continued.**  
Wason Mfg. Co., Springfield, Mass.
- Turbines.**  
General Electric Co., Schenectady, N. Y.  
Westinghouse Machine Co., Pittsburg, Pa.
- Union Couplings.**  
National Tube Co., Pittsburg, Pa.
- Valves—(See Steam Fittings).**
- Varnish.**  
Electric Service Supplies Co., 200 Plymouth Bldg., Chicago.  
Standard Paint Co., 100 William St., New York.
- Ventilators.**  
Drouvé, G. Co., Bridgeport, Conn.  
Lord & Burnham, Irvington-on-Hudson, N. Y.
- Vestiblets.**  
Beavy Vestlette Mfg. Co., Cleveland, O.
- Waste, Cotton and Wool.**  
Hagy, J. Milton, Waste Wks., Philadelphia, Pa.  
Railway Specialty & Supply Co., Chicago.
- Water Softening Compounds.**  
Dearborn Drug & Chemical Works, Chicago.
- Wheels and Axles.**  
American Car Co., St. Louis.  
Brill, J. G., Co., Philadelphia.  
Griffin Wheel Co., Chicago.  
Kuhlman, G. C., Car Co., Cleveland.  
McGuire-Cummings Mfg. Co., Chicago.  
Marshall, R. W., & Co., 95 Liberty St., New York.  
Railway Steel-Spring Co., New York.  
St. Louis Car Co., St. Louis.  
St. Louis Car Wheel Co., St. Louis.  
Standard Steel Works Co., Philadelphia, Pa.  
Stephenson, John, Co., Elizabeth, N. J.  
Wason Mfg. Co., Springfield, Mass.
- Window Fixtures.**  
Drouvé, G. Co., Bridgeport, Conn.
- Wiping Rags.**  
Hagy, J. Milton, Waste Wks., Philadelphia, Pa.
- Wire, Aluminum.**  
Aluminum Co. of America, Pittsburg, Pa.
- Wire, Insulated.**  
Aluminum Co. of America, Pittsburg, Pa.  
American Electrical Works, Providence, R. I.  
General Electric Co., Schenectady, N. Y.  
Okonite Co., Ltd., 253 Broadway, New York.  
Standard Underground Cable Co., Pittsburg, Pa.  
Stuart-Howland Co., Boston.
- Wire and Cables.**  
Aluminum Co. of America, Pittsburg, Pa.  
American Electrical Works, Providence, R. I.  
Bridgeport Brass Co., Bridgeport, Conn.  
General Electric Co., Schenectady, N. Y.  
Okonite Co., Ltd., 253 Broadway, New York.  
Standard Underground Cable Co., Pittsburg, Pa.

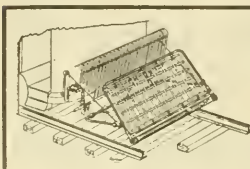

## ECLIPSE Life Guard

Manufactured by the  
ECLIPSE RAILWAY SUPPLY CO.  
Cleveland, Ohio



## TROLLEY WIRE, BARE COPPER CABLES WEATHERPROOF WIRE AND CABLES

RUBBER COVERED CABLES AND LEAD COVERED UNDERGROUND CABLES  
FOR ANY SERVICE. WRITE US FOR SPECIAL PRICES AT THIS TIME  
STANDARD UNDERGROUND CABLE CO.

Pittsburg New York Boston St. Louis San Francisco Chicago  
Philadelphia Los Angeles Atlanta

# STANDARD HIGH-SPEED "INTERBOROUGH" DOUBLE TRUCK

TYPE C-60

"Solid Forged"

WITHOUT WELDS

FRAMES ARE MADE FROM ROLLED OPEN-HEARTH STEEL WITHOUT WELDS. ALL WEARING BOLTS ARE TURNED AND CASE HARDENED, AND WEARING HOLES STEEL THIMBLED. M. C. B. STANDARD PRINCIPLES ARE FOLLOWED. WE ARE PREPARED TO BUILD TRUCKS IN ACCORDANCE WITH PURCHASER'S DESIGNS AND SPECIFICATIONS.

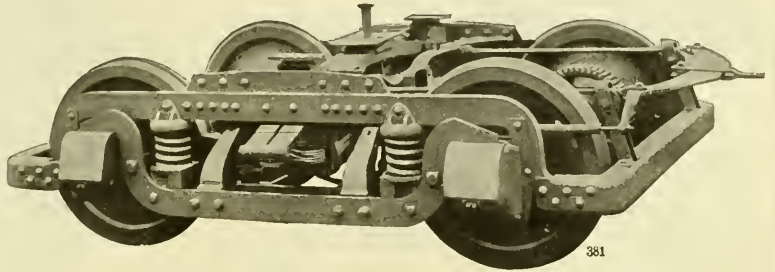

381

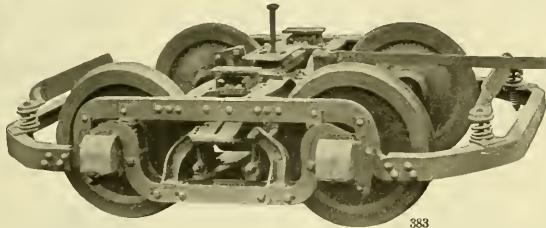

383

## STANDARD "SHORT WHEEL BASE"

CITY AND SUBURBAN

DOUBLE TRUCK

TYPE O-50

STANDARD MOTOR TRUCK COMPANY, FRICK BUILDING, PITTSBURGH, PENNSYLVANIA  
 NEW YORK OFFICE: 170 BROADWAY WORKS: NEW CASTLE, PA. CHICAGO OFFICE: FISHER BUILDING

## THE BABCOCK & WILCOX COMPANY

85 Liberty Street, New York

Babcock & Wilcox — Stirling — A & T Horizontal — Cahall Vertical

# WATER TUBE STEAM BOILERS

STEAM SUPERHEATERS

Works: Bayonne, N. J. Barberton, Ohio.

MECHANICAL STOKERS

BRANCH OFFICES:

BOSTON, Delta Bldg.  
 PHILADELPHIA, 110-1112 North American Bldg.  
 SAN FRANCISCO, 63 First Street  
 PITTSBURGH, Farmers Deposit Nat. Bank Bldg.  
 NEW ORLEANS, 343 Baronne St.

DENVER, 410 Seventeenth St.  
 SALT LAKE CITY, 313 Atlas Block  
 WASHINGTON, Colorado Building  
 CHICAGO, Marquette Bldg.  
 ATLANTA, GA., 1132 Candler Bldg.

CLEVELAND, 706 New England Bldg.  
 MEXICO CITY, 7 Avenida, Juarez  
 HAVANA, CUBA, 116 1/4 Calle de la Habana  
 LOS ANGELES, 321 Trust Bldg.  
 CINCINNATI, O., Traction Bldg.

Do you know the difference between

## GE Motor Packing Waste

and other kinds?

The service each renders, of course, proves the case. A sample order for enough *Motor Packing Waste* to pack a few motor boxes will show the difference. All kinds of high-grade Wastes, Wiping Rags, etc.

The J. Milton Hagy Waste Works  
 433 Spruce Street Philadelphia

# ALUMINUM

## Railway Feeders

And all kinds of Electrical Conductors

Aluminum Feeders are less than one-half the weight of copper feeders and are of equal conductivity and strength. If insulated wire or cable is required, high grade insulation is guaranteed.

Write for prices and full information.

Aluminum Company of America  
 PITTSBURGH, PA.

Of all the good things we can say about the

## Knutson Trolley Retriever

the best is this—it is in successful use on a majority of the high-speed electric railways of America.

What more need we say?

Only this—send for a lot and make a thorough test on your road at our expense. Write to

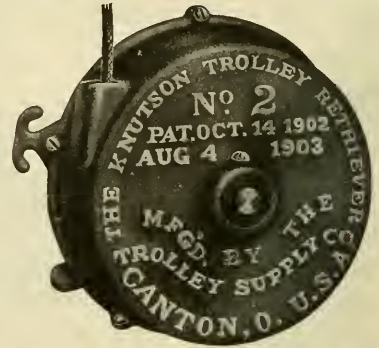

**The Trolley Supply Co., Canton, Ohio**

8

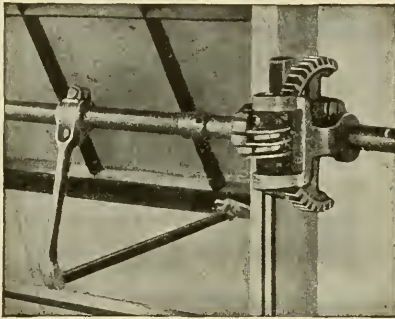

## The Ventilation

of your Shops, Foundries and Car Barns is made especially effective by a speedy, positive and easily manipulated **Sash Operating Apparatus** which automatically locks the sash at any position.

*Let us send you our catalogue.*

**Lord & Burnham Company**  
Irvington-on-Hudson, N. Y.

## Hydraulic Wheel Presses

Our Special Forcing Press Catalogue contains eighteen different types of wheel presses, comprising vertical, inclined and horizontal types; hand, belt and electric driven, in sizes from 30 to 600 ton capacity.

Each tool thoroughly guaranteed.

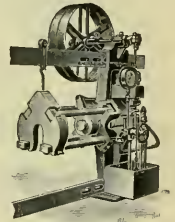

*Send for Forcing Press Catalogue No. 70.*

**THE WATSON-STILLMAN CO.**

50 Church Street, New York City  
Branch Office: 453 The Rookery, Chicago, Ill.

4

## STEEL WOOL JOURNAL PACKING

really is superior to and far more economical than all other kinds of packing. A comparative test under hard service will prove this to your complete satisfaction.

*We will gladly furnish a liberal sample*

**WM. ROBERTSON & COMPANY**

General Office: Great Northern Bldg., CHICAGO  
Factory: 75 S. Jefferson St., BATTLE CREEK, MICH.

11

## PIPE FITTINGS AND VALVES

FOR THE  
HEATING AND PLUMBING TRADE

TRADE  MARK

**JOHN SIMMONS CO.**  
104-110 Centre Street, NEW YORK

One cent a word for want ads in the  
Electric Railway Review

More than three million square feet of

# Anti-Pluvius Skylight

now in use is mighty good evidence of its value.

For all electric railway buildings requiring an abundance of light, there is nothing quite so good as the *Anti-Pluvius Skylight*. It lets in all the light and keeps out all the rain and dust.

'Twill pay you to investigate the merits of *Anti-Pluvius Skylights*—made only by

**THE G. DROUVÉ CO.**

Bridgeport, Conn., U. S. A.

Western Office: 40 Dearborn Street, Chicago

6



The M. C. B. Christie Flanged Steel Back Brake Shoe for use on wheels with 3-inch tread and over.

## Brake Shoe Standardization

is not the extremely expensive process you may have imagined it to be.

It is really a simple proposition—means merely a change in the brake head—no change in brake hanger, rigging or truck.

And the saving in brake shoe material bought, handled and scrapped will more than pay for the change.

Give us the opportunity of studying your brake shoe problem and we'll show you how to save money.

*Address the nearest office, please.*

## Electric Railway Lubrication

THE same skillful expert supervision given in this service as in steam railway service has produced most satisfactory results. Lower cost of lubrication with better service.

We are under contract with many of the largest Street and Interurban railways in the country.

We guarantee cost per thousand miles in Street and Electric Railway Service when conditions warrant it.

Including both Rolling Stock and Power House Equipment

Write for further particulars.

**Galena-Signal Oil Company**  
FRANKLIN, PENNSYLVANIA

## American Brake Shoe & Foundry Company

Mahwah, N. J.

170 Broadway  
New York

Western Union Bldg.  
Chicago

8

**THE ARNOLD COMPANY**  
 ENGINEERS—CONSTRUCTORS  
 ELECTRICAL—CIVIL—MECHANICAL  
 181 LA SALLE STREET  
 CHICAGO

**A. L. REGISTER & CO.**  
 Engineers and General Contractors—Electric Railways  
 112 North Broad St. PHILADELPHIA, PA. Established 1889

**H. M. Bylesby & Company**  
 Incorporated  
 ENGINEERS  
 American Trust Bldg., Chicago  
 Design, Construct and Operate  
 Railway, Light, Power and  
 Hydraulic Plants EXAMINATIONS AND  
 REPORTS

**CENTRAL INSPECTION BUREAU**  
 Inspection of Rails, Ties, Cars, Motors, Bridges, Buildings, Etc.  
 17 STATE STREET - - - - NEW YORK CITY

**LINE MATERIAL**  
 ELECTRIC SUPPLIES FOR RAILWAYS, POWER PLANTS, ETC.  
 THE CREGHEAD ENGINEERING CO., 346 Main Street, Cincinnati, Ohio

**THE CURTAIN SUPPLY CO.**  
 CAR CURTAINS  
 CHICAGO, 85-93 Ohio Street Hudson Terminal, 50 Church St., NEW YORK

**J. G. WHITE & COMPANY**  
 INCORPORATED  
**Engineers, Contractors**  
 43-49 Exchange Place, New York, N. Y.  
 41-43 Wall Street  
 Principal Philippine Office: Manila, P. I.

**AUTOMATIC TROLLEY GUARD CO.**  
 61-69 Carroll St., Buffalo, N. Y.  
 "IT PUTS THE WHEEL ON THE WIRE" <sup>3</sup>

**HOT WATER HEATERS FOR CARS**  
 THE PETER SMITH HEATER COMPANY, Detroit, Mich.

**Complete Plants for the Rapid  
 Handling of Material**  
 Every Sort of Hoisting Apparatus  
 BROWN HOISTING MACHINERY CO. Cleveland, Ohio

**ELECTRIC HEATERS** For All Classes  
 of Cars  
 New York Consolidated Car-Heating Co. Chicago

**GEARS AND PINIONS**  
 FOR ALL TYPES OF MOTORS  
 THE VAN DORN & DUTTON CO., CLEVELAND, OHIO

INSULATING  
 VARNISHES  
 (BAKING; AIR-DRYING)  
 COMPOUNDS  
 TAPE



Possess the  
 Highest Insula-  
 tive Efficiency.  
 The Standard Paint Co.  
 100 William St.  
 New York.

**RE-ENFORCED SPOKE WHEELS**  
 For City and Suburban Cars  
 ST. LOUIS CAR WHEEL CO., St. Louis, Mo.

**HART CONVERTIBLE BALLAST, GONOLA AND CONSTRUCTION CAR**  
 RODGER BALLAST CAR CO., Railway Exchange, CHICAGO

We've eliminated machine work in  
**Lumen Metal Mold Axle Bearings.**  
 Our claim that these bearings will effect a saving of about  
 30 per cent is worth investigating. Write us—today!  
 Buffalo LUMEN BEARING CO. Toronto <sup>1</sup>

**BRAKESHOOES**  
 STANDARD  
 BRAKESHOE COMPANY  
 GEN'L OFFICES & WORKS—AURORA, ILL. CHICAGO OFFICE: 315 RY. EXCH.

**SMITH CONCRETE MIXER**  
 does the work better, quicker, cheaper and lasts longer.  
 CONTRACTORS' SUPPLY & EQUIPMENT COMPANY  
 Old Colony Building, Chicago 170 Broadway, New York <sup>9</sup>



SPEER  
 HIGH GRADE  
 BRUSH  
 ST. MARYS - PA.

**GRIFFIN WHEEL CO.**  
 CHICAGO  
 CHILLED IRON CAR WHEELS IRON OR STEEL AXLES

**HEINE SAFETY BOILER CO.**  
 421 OLIVE STREET, ST. LOUIS, MO.  
 Manufacturers of WATER TUBE BOILERS

VALVES—FITTINGS—STEAM SPECIALTIES  
**CRANE CO.**  
 CHICAGO  
 ESTABLISHED 1855

WRITE TO **MODEL STOKER COMPANY** DAYTON OHIO  
 for detailed information about the best  
**AUTOMATIC SMOKELESS FURNACE**

SPRINGS—TIRES—STEEL-TIRED WHEELS  
**RAILWAY STEEL-SPRING CO.**  
 General Offices: Cortlandt Bldg., 30 Church St., New York

# Independent Investigation

of the modern bonding and rebonding methods

## Electric Brazing and Copper Welding

will prove the truth of our claim

→that they are the only methods of reasonable cost producing perfect mechanical and electrical union of bond and rail, and possessing long life.

We will gladly send the names of users upon your request. Then ask what they think.

**THE ELECTRIC RAILWAY IMPROVEMENT COMPANY**

6005 Carnegie Avenue

CLEVELAND, OHIO

11

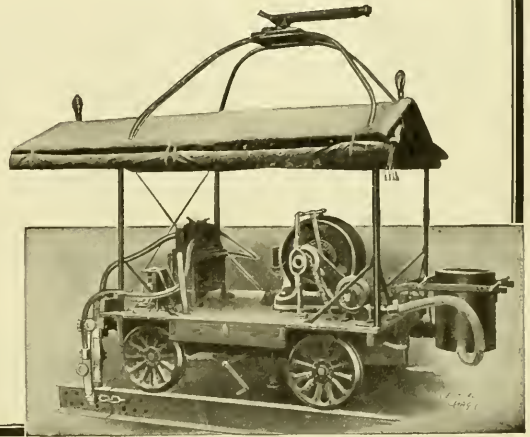

## TUBULAR POLES IRON OR STEEL



FOR  
ELECTRIC RAILWAYS  
ELECTRIC LIGHTING CO'S  
SIGNAL )  
TELEPHONE ) SER-  
TELEGRAPH ) VICE

TRANSMISSION  
L I N E S  
AND  
CATENARY  
S U S P E N S I O N  
L I N E S

**ELECTRIC RAILWAY EQUIPMENT CO.**  
General Office: CINCINNATI - O - U.S.A.  
Shops: READING PA - WHEELING WVA

## STOP THIEF!

That is what our  
NEW BOND GUARD DOES



## Why Not Try Some

WHERE YOU HAVE TROUBLE  
WITH THEFT OF BONDS?  
*At Least Send for Literature*

**CHASE-SHAWMUT CO.**  
Newburyport, Mass.

### Baldwin Locomotive Works

BURNHAM, WILLIAMS & CO., PHILADELPHIA, PA., U. S. A.

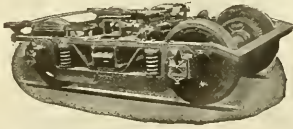

Builders of  
**LOCOMOTIVES**  
of every description  
including

**ELECTRIC  
LOCOMOTIVES**

**ELECTRIC TRUCKS**

### Standard Steel Works Co.

HARRISON BLDG., PHILA., PA., U. S. A.

New York, N. Y. Cleveland, O. St. Louis, Mo. Denver, Colo.  
Portland, Ore. Richmond, Va. Chicago, Ill. St. Paul, Minn.  
San Francisco, Cal. Seattle, Wash. Winnipeg, Can.

**Solid Forged  
Rolled and Steel Tired Wheels**

Mounted on axles fitted with Motor Gears  
for Electric Railway Service.

**LOCOMOTIVE TIRES  
FORGINGS**

**RAILWAY SPRINGS  
CASTINGS**



## MORDEN FROG AND CROSSING WORKS

MANUFACTURERS OF

618 The Rookery, Chicago

**Street Railway Special Track Work**

Works: { SOUTH CHICAGO and CHICAGO HEIGHTS

“UNION” Track Jacks, Switches, Frogs, Crossings, Rail Braces, Etc.

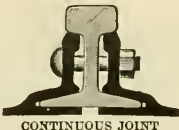

CONTINUOUS JOINT

Over  
**25,000**  
miles  
in use



WEBER JOINT

Rolled  
from  
**Best Quality**  
Steel



WOLHAUPTER JOINT

Catalogs at Agencies  
Baltimore, Md. Portland, Ore.  
Boston, Mass. Seattle, Wash.  
Chicago, Ill. St. Paul, Minn.  
Denver, Colo. St. Louis, Mo.  
Pittsburg, Pa. Troy, N. Y.  
London, Eng. Montreal, Can.

HIGHEST AWARDS—Paris, 1900;  
Buffalo, 1901; St. Louis, 1904

Additional safety and economy in Track Maintenance has been proved by the use of Continuous, Weber and Wolhaupter base-supported rail joints—after ten (10) years' service, having a record of over 25,000 miles in use—the extent of which is evidence of their excellence.

### THE RAIL JOINT COMPANY

General Offices: 29 West 34th Street, New York City  
Makers of Rail Joints for Standard and Special Rail Sections, also Girders, Steps or Compromise, and Insulating Rail Joints, protected by patents in United States and Foreign Countries.

**Avoid  
Accidents**

By Using  
This  
Switch



## Anti-Straddling or Anti-Kicking Tongue Switch

It will not drive down at the heel, because it is held to either side with a spring tension and firmly down on its bed. A car can not straddle this tongue.

WRITE FOR SPECIAL CIRCULAR

SPECIAL TRACK WORK OF EVERY DESCRIPTION

**New York Switch & Crossing Co.**

HOBOKEN, N. J.



## Advertise in the Electric Railway Review

To get an employe.  
To secure a job.  
To sell second-hand  
machinery, cars, etc.

Want Ads cost only one cent a word per insertion. Special rates on “For Sale” Cards—ask about them.



# FOR SALE. FOR QUICK DELIVERY

## 6 55-ft. Passenger, Baggage and Smoking Car Bodies

Main Compartment	26' 0"
Smoking	10' 6"
Baggage	10' 0"
Seating Capacity, 54	

## 8 60-ft. Passenger, Baggage and Smoking Car Bodies

Main Compartment	28' 6"
Smoking	11' 0"
Baggage	8' 0"
Seating Capacity, 58	

## 5 52-ft. Passenger and Smoking Car Bodies — <sup>Double</sup>End

Seating Capacity, 60

## 3 52-ft. Passenger and Baggage Car Bodies — <sup>Double</sup>End

Seating Capacity, 56

## 2 50-ft. Express Car Bodies

*Write or wire us for further information.*

# The Jewett Car Co. Newark Ohio

**THE MIGHTY MIDGET**

## HOT WATER CAR HEATER

Adapted for Large Electric Cars and Long Distance Lines. Exclusively used on Largest Electric Systems. Ask for Catalog

**THE WILLIAM C. BAKER HEATING & SUPPLY CO.,** 143 LIBERTY STREET NEW YORK



## NILES CARS — THE ELECTRIC PULLMANS

LARGE, FAST INTERURBANS  
OUR SPECIALTY

## NILES CAR & MFG. COMPANY

WORKS: NILES, OHIO      Sales Office: J. A. HANNA Co., 312 Electric Bldg., Cleveland, O.

# McGUIRE-CUMMINGS MFG. Co. CHICAGO



SPRINKLERS, CARS, TRUCKS AND RAILWAY EQUIPMENT

**BERTHOLD & JENNINGS**  
LUMBERMENS BLDG. SAINT LOUIS, MO.

**TIMBERS**  
L. L. Pine, Oak

**POLES**  
Cedar, Cypress, Chestnut

**TIES**  
Oak, Cypress, Chestnut

**WHITE CEDAR** **P** Large Stock 14 to 65 ft.  
**P O L E S** Prompt Shipment

**POLES**

**YARDS:** **FRANCIS BEIDLER & CO.**  
Menominee, Mich. Escanaba, Mich. Superior, Wis. Deer River, Minn. Chicago, Ill.

For prompt deliveries of

**Cedar Poles** Red or White  
write either office today.

**NATIONAL POLE COMPANY**  
EVERETT, WASH. ESCANABA, MICH.

**Poles and Ties**  
A Selected Stock in Chicago for Rush Shipment  
A Number of Large Yards in the North  
**NAUGLE POLE & TIE CO.**  
CHICAGO OFFICE: 226 LA SALLE STREET

**C. H. WORCESTER CO.**  
**CEDAR POLES**  
PRODUCERS AND WHOLESALERS  
Suite 1710 Tribune Building CHICAGO

**Idaho Cedar Poles**  
PACIFIC COAST POLE CO. SPOKANE, WASH.

We are Producers and Wholesale Dealers in Western  
**CEDAR POLES**  
Yards in Washington, Idaho, Montana and British Columbia  
WRITE US FOR DELIVERED PRICES  
**CHURCHILL CEDAR CO.,** Box 1409, Spokane, Wash.

**Shelby Trolley Poles**  
Made from Cold Drawn Seamless Steel Tubing.  
Immediate delivery all sizes from stock.  
**The Garford Company : Elyria, O.**

**G. H. BARNES HARDWOOD LUMBER CO.**  
Office and Yard: Main and Walnut Sts., ST. LOUIS, MO.  
Ties, Car Oak, Poplar, Ash, Cherry, Plain and Quartered Oak

**For Sale** Cards produce results in the  
Electric Railway Review

**POLES and PILING** 20,000 35s and 40s, Ready to Ship at Once  
S-E. MISSOURI CYPRESS CO., CAMPBELL, MO.

**The Lindsley Brothers Company**  
Producers and Shippers of **WESTERN CEDAR POLES** and Manufacturers of **RED FIR CROSS ARMS**  
Eastern Sales Office, Monadnock Bldg., CHICAGO SPOKANE, WASHINGTON

**POLES and TIES**

We have a nice selected stock of  
**Chestnut Poles**  
White and Common  
**OAK and CHESTNUT TIES**

**The Advance Lumber Co.**  
1313 Rockefeller Building  
CLEVELAND OHIO



## "Nuttall," Trolleys

"Nuttall" Trolleys are made for all conditions of service. Our Catalogue No. 10 illustrates 12 standard types for you to choose from; always ready for shipment.

*If in a hurry, wire us.*

**R. D. Nuttall Company**  
Pittsburg, Pa.

Our Southern office has been transferred from the Southern States Electric Company to the Electric Service Supplies Company, Atlanta, Ga.

## Your Dispatcher's Orders



are apt to prove valueless at the critical moment unless he has a positive means at hand of enforcing them.

He can do this *every time* with the Telegraph Signal System.

Investigate its merits! Write

**Telegraph Signal Company**

282 State Street - Rochester, N. Y.  
10

## "Not an Experiment"

The Providence Fender is the Children's Fender. It is equally as effective in saving a child, and the person who has stumbled, as it is in saving those who are on their feet.

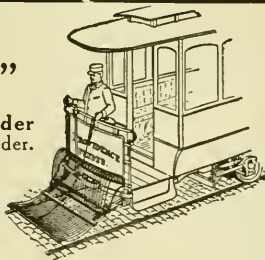

**CONSOLIDATED CAR FENDER COMPANY**

Office and Factory: PROVIDENCE, R. I.  
Branch Office: 110 E. Twenty-third St., New York  
European Agents: Comptoir d'Electricite, 6, Rue Boudreau, Paris, France

## Mica Prices Reduced

Compare our prices on Raw Mica and Manufactured Mica with prices you have been paying our competitors

**WHY PAY FANCY PRICES?**

*We do not intend to change or increase our list prices. We do not follow our competitors.*

Chicago Mica Co. Valparaiso, Ind.

## Roads that are using Whitmore's Gear Protective Composition

have reduced their gear and pinion cost one half what it previously cost with other lubricants. The proof of this the users will substantiate.

**The Whitmore Manufacturing Company**  
LUBRICATING ENGINEERS  
Cleveland, Ohio, U. S. A.



Established 1877.



**ALBERT & J. M. ANDERSON MFG. CO.,**

Makers of

**ELECTRICAL APPLIANCES:**  
SWITCHES, SWITCHBOARDS,  
TIME SWITCHES, LINE MATERIAL,  
COPPER CASTINGS (75%) CONDUCTIVITY.  
289-293 A ST., BOSTON, MASS., U. S. A.

Branches: New York, 135 Broadway. Chicago, 175 Dearborn Street.

Agencies: Boston, Pettingell-Andrews Co. San Francisco, Eccles & Smith Co.  
New York, R. W. Marshall & Co. Atlanta, Newcomer-Manly Co.  
St. Louis, J. C. White. Denver, E. M. Messiter.  
Toronto, Ont., H. J. Surtees.



# CLASSIFIED ADVERTISEMENTS

Undisplayed advertisements are inserted under this heading at the uniform rate of one cent a word; minimum charge twenty-five cents. Replies directed to this office will be forwarded when required to any address in the United States, Canada or Mexico without extra charge. Advertisements received at the Chicago office by 9 a. m. Thursday will appear in the issue for the same week.

## POSITIONS WANTED.

**Wanted**—Position as armature winder and mechanic. Ten years' experience. Can furnish good reference. Address "No. 586," care of Electric Railway Review, Chicago.

**Wanted**—To correspond with company needing the services of high-class general manager or general superintendent. Electrical and civil engineer; 17 years' experience with large properties and in construction and operation. Address "No. 568," care of Electric Railway Review, Chicago.

An experienced supply salesman, who also has had thirteen years' operating experience on city lines, desires to form connection with a railway supply house handling either electric or steam supplies or both. Would consider proposition to open sales agency. Address "No. 566," care of Electric Railway Review, Chicago.

Experienced electrical engineer wants position with manufacturing concern or with company operating electric railways. Graduate Purdue University, 1905. Will go anywhere for permanent position. Age 26; married. A No. 1 references as to habits and ability. Address "No. 570," care of Electric Railway Review, Chicago.

Position wanted as auditor and accountant. Sixteen years of steam, electric and general experience; good working knowledge of details of general contracting business; clever buyer; possess ability to organize. Can furnish first-class reference as to character and ability and work accomplished in past; leaving present work because closed; at liberty to accept position any time. Address "No. 575," care of Electric Railway Review, Chicago.

## POSITIONS WANTED.

**Detective**, three years' experience. Both ends. Do you expect a strike? If you do I can make you a good proposition. Address "No. 587," care of Electric Railway Review, Chicago.

**Want work on right of way, franchises, stock sales, etc.** Promoter's right-hand man. Always in harness. Reliable and experienced. Address "No. 588," care of Electric Railway Review, Chicago.

**Wanted**—Position as superintendent of rolling stock or master mechanic on city or interurban railway. Have satisfactorily handled similar work on large metropolitan properties since horse car days. At liberty now; references exceptional. Address "No. 559," care of Electric Railway Review, Chicago.

**Transportation man of seven-**teen years' experience, young, reliable and thoroughly familiar with organization, dispatching and timetable work, desires a position as superintendent or one of equal responsibility. Highest references regarding character, ability and past service. Address replies to "No. 577," care of Electric Railway Review, Chicago.

## POSITIONS OPEN.

**General manager** wanted for combined electric railway, electric light and gas property, operating 25-mile city and interurban railway located in middle west. Promotion assured for capable man. Must be able to handle relations with public, as well as operate property economically. Address "No. 589," care of Electric Railway Review, Chicago.

## MISCELLANEOUS WANTS.

**Want to buy second-hand** equipment, machinery or material? A card inserted in the Electric Railway Review, stating just what you want, will bring immediate response. The cost is small—only \$1.20 an inch (measuring 1 inch deep by 1½ inches wide) per insertion. Send orders to Electric Railway Review, 160 Harrison St., Chicago.

**What have you to sell in the** way of second-hand equipment, machinery or material? Buyers read the "For Sale" cards on the following page and there is the price, to tell your story. "For Sale" cards are inexpensive—only \$1.20 an inch (measuring 1 inch deep by 1½ inches wide) per insertion. Special rates on contracts for 100 inches or more to be used within one year. Now is the time to send your order to Electric Railway Review, 160 Harrison St., Chicago.

## BOOKS AND PUBLICATIONS.

Interstate commerce national legislation to July 1, 1906, is fully covered in our reference pamphlet. It contains the full text of the act to regulate commerce as amended, including the Elkins and Hepburn acts, and of the supplementary act relating to the testimony of witnesses before the interstate commerce commission. It also contains the texts of the expedition and the trust act of 1890, the employers' liability act and the safety equipment laws. Difference in type shows the parts expunged from and the parts added to, the Interstate Commerce and Elkins acts by the Hepburn act. This pamphlet is of special value to railway men and lawyers. Mailed prepaid for 25 cents in stamps or coin. Special prices for quantities. The Wilson Company, 160 Harrison St., Chicago.

## BUSINESS OPPORTUNITIES.

**Wanted**—Man with some capital and a knowledge of railway track supplies to join the advertiser—a salesman handling locomotive and car supplies—in a general railway supply business. Address "No. 553," care of Electric Railway Review, Chicago.

**Wanted**—To exchange first mortgage gold bearing 5½ per cent bonds for material for electric railway, issue limited as to amount per mile; right of way held by company in fee simple. Those interested address Chicago Ottumwa & Western Railway, Hamilton, Ia.

**Recharging Dry Batteries**, the only book ever published giving complete directions of how to prepare chemicals for renewing dry batteries. If you are not more than pleased with this book your dime back. Large electrical catalogue and book postpaid, 10 cents. Adams Electric Co., Dept. E. R., Kewanee, Ill.

## BOOKS AND PUBLICATIONS.

**Wanted**—Copies of the Street Railway Review of April, 1900, May, 1901, and August, 1903. State price and condition. Address "No. 553," care of Electric Railway Review, Chicago.

**We want your friends** to read the Electric Railway Review. You will do them—and us—a favor by sending their addresses. We will gladly mail free sample copies. Electric Railway Review, 160 Harrison Street, Chicago.

**Wanted**—Copies of Street Railway Review, January to June, 1906, inclusive, and one copy each January and February, 1906. Also Electric Railway Review for January 5, 1907. State condition and price. Address "No. 582," care of Electric Railway Review, Chicago.

## NOTICE OF SALE

# Detroit, Flint and Saginaw Ry.

June 18, 1908, 12:00 Noon, Front Door of Court House, City of Flint.

The Company was organized to build an electric railway between the cities of Saginaw and Flint, State of Michigan, of which 12 miles have been completed from Saginaw, south through the village of Bridgeport to the village of Frankenmuth, which is now being operated by a receiver.

**Power House and Car Barns**, fully equipped, are located at Bridgeport.

**Franchises** for complete right of way from Saginaw to Flint will be sold with the physical properties of the road as an entirety.

### Unusually Attractive Opportunity for Capital

as the road when completed would consist of only about 35 miles and serve a population of about 112,000 people, with splendid freight possibilities. For full particulars, write

**DETROIT TRUST COMPANY, Receiver**  
Penobscot Building, DETROIT, MICH.

# "Wanted" and "For Sale" Cards

especially for the marketing of second-hand equipment, machinery, material, etc., are carried on this page at a uniform rate of **\$1.20 an inch** (measuring 1 inch deep by 1 5/8 inches wide) **per insertion.**

Special rates made on contracts covering 100 inches or more.

Send orders to

**Electric Railway Review**  
160 Harrison Street - CHICAGO

**R.W. MARSHALL & CO.**  
50 Church St., New York  
Second-Hand Machinery and Equipment  
**ELECTRIC RAILWAY MATERIALS**

Rare Bargains in  
**RAILS AND EQUIPMENT**  
WALTER **ZELNICKER** SUPPLY CO.  
in ST. LOUIS  
DO YOU RECEIVE OUR STOCK LISTS?

The Russell Combination Electric Car and Snow-Plow.  
Remove the noses of your Russell electric combination car and snow-plow and you have an electric locomotive, freight, baggage or express car in one. One investment buys two pieces of equipment. Write us, **RUSSELL CAR & SNOW-PLOW CO.**, Ridgway, Pa., Wendell & MacDuffie, New York; C. A. Rolston, Chicago  
**IS USEFUL ALL THE YEAR ROUND**

One cent a word for want ads in the **Electric Railway Review.**

**FOR SALE**  
Baldwin-Westinghouse Electric Trolley Switching Locomotive  
Weight about 53,000 lbs., gauge 4 ft. 8 1/2 in., 4 motors, 220 volts, diameter of drivers 30 in.  
Address "**Electric Locomotive**"  
Office of Electric Railway Review  
50 Church Street, New York City

**FOR SALE: Three Car Bodies and Three Pairs of Double Trucks**  
with or without electric equipment and air brakes; all new and never used. Compelled to sell, as these cars will not operate over a leased line by reason of their width and length.  
**R. W. MARSHALL & CO., 50 Church St., New York, N. Y.**

**THE NATIONAL LOCK WASHER CO., NEWARK, N. J.**  
Curtains - Curtain Fixtures - Sash Locks - Sash Balances - Nut Locks  
CHICAGO OFFICE: 419 MONADNOCK BLOCK

**Washburn "M" Type Traction Coupler** Strongest, Simplest and Cheapest Traction Coupler Ever Made

Illustration shows two "M" Type couplers on a forty-five degree curve and coupled with a short cast link as used on cars having a short wheel base. For longer cars a longer link casting is furnished, giving any amount of distance between cars, and affording the desired clearance when traveling curves.

Ask for new catalogue of traction devices.

**Washburn Steel Castings & Coupler Co.**  
MINNEAPOLIS, MINN.  
Western Agents: Tweedy, Hood & Finlen, 204 Fisher Bldg., Chicago Canadian Agent: John Taylor, Montreal

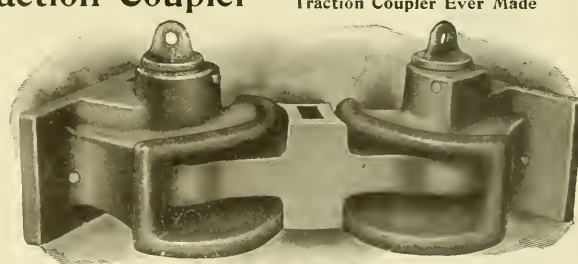



**The Moore Track Drill**  
does not interfere with traffic!

The shifting of one lever and a few seconds' time takes down the drill—the operation reversed makes it ready for work again.

This is only one of the many strong points about the Moore Track Drill that make it worth buying.

Ask for descriptive catalogue.

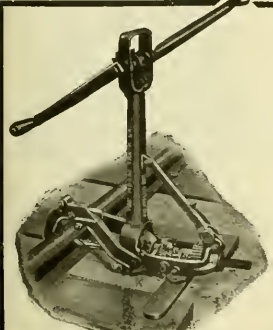
**Kalamazoo Railway Supply Co.** Kalamazoo Michigan

# Peacock Brakes

could not be so widely used as they are if it were not true that they have proved their superiority over all other chain brakes]

Simply impossible, you know, to sell from five hundred to a thousand and on up to seventeen hundred Peacock Brakes to a single road unless they had made good in service.

And Peacock Brakes have made good—so good that they replace all others, both as service brakes and as auxiliary brakes, when once thoroughly tested.

We'd like to equip a car for you at our expense.

## National Brake Co.

888 Ellicott Square  
BUFFALO, N. Y.

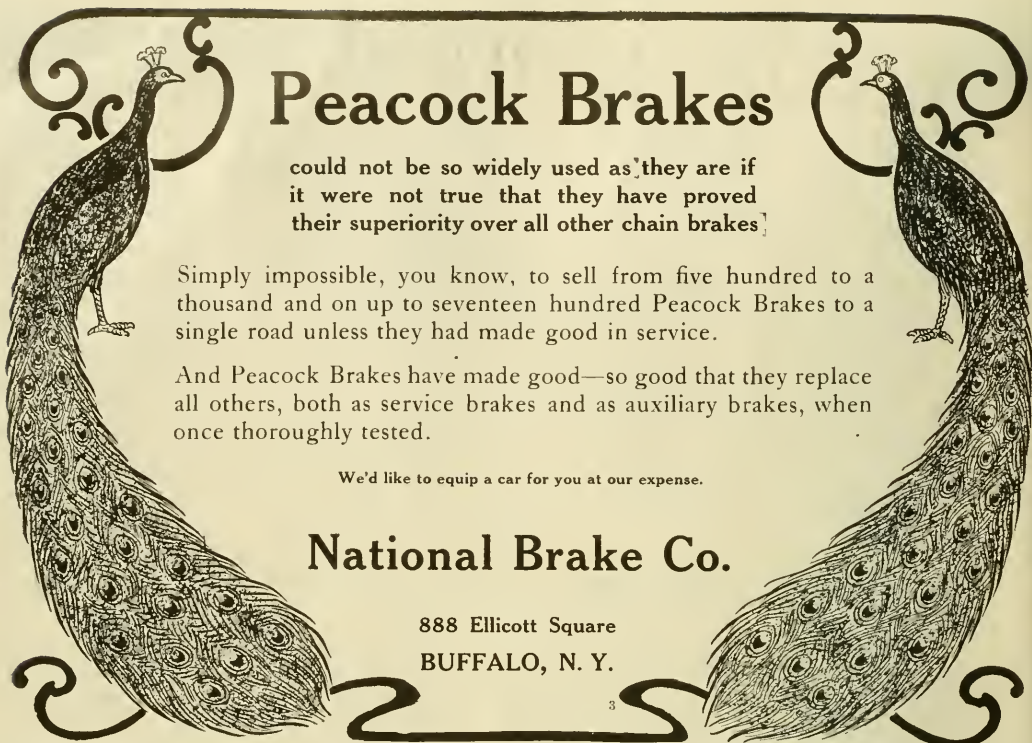

# SHELBY STREET RAILWAY LAMPS



Built to withstand vibration. 50% more light below the lamp. No additional current required. We make a special current-saving lamp for park use. Write for prices

## THE SHELBY ELECTRIC CO., Shelby, O.

# Collecting and Registering Fares

—by the Rooke Automatic Collector System:

PASSENGER COMPANY Conductor

—by all old-fashioned register systems:

PASSENGER CONDUCTOR Company (?)

Under old-fashioned systems nickels are often collected without being registered—and unregistered nickels never reach the treasury.

Under the Rooke System every nickel is registered before it reaches the conductor's hand.

There is no chance for the nickel to go astray.

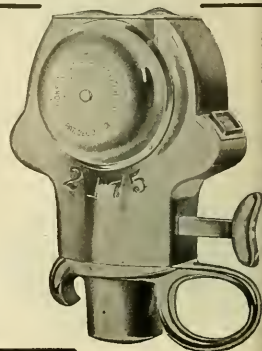

Rooke Automatic Register Co. : Providence, R. I.

# Electric Railway Review

PUBLISHED EVERY SATURDAY BY THE WILSON COMPANY, CHICAGO

Entered as second-class matter January 5, 1907, at the postoffice at Chicago, Ill., under the act of March 3, 1879.

CHICAGO: 160 Harrison Street  
NEW YORK: 50 Church Street  
CLEVELAND: 1529 Williamson Bldg.

VOL. XIX  
No. 20

CHICAGO, MAY 16, 1908

Whole No.  
261

Subscription: Domestic, \$2.00  
Foreign, 5.00  
Canada, 3.50

## THE REVIEW AND THE JOURNAL TO BE MERGED.

We have pleasure in announcing that with the first issue in June the Electric Railway Review and the Street Railway Journal will be consolidated. It has been the belief of the publishers of both these journals that the exacting requirements of the electric railway field could be much better met by one publication embodying all the editorial strength and all the business resources of both organizations.

The tendency toward specialization in the several departments of electric railways has called for an increasingly high order of ability in the personnel of the corporations engaged in that great industry. This necessarily has made larger demands upon the resources of the publications which are seriously engaged in the dissemination of news and in the treatment of the problems in a rapidly growing field. The endeavor on the part of each paper to give the latest and best information has resulted in a considerable duplication of matter, and from this has followed an unnecessary expense in preparing and printing twice matter that might be just as well circulated if printed but once.

Moreover, advertisers have indicated in many important instances a feeling that there was not room for two strong weekly papers. The tendency toward a division of the patronage of many large advertisers necessitated a reduction in the amount of space which both they and the publishers felt was desirable, not to say necessary, to insure profitable results.

The consolidated paper will make a technical journal of such wide reach and scope, such editorial and financial potency, as will easily meet the demands of the most critical and exacting. The "Electric Railway Journal," which will be the name of the consolidation of the Electric Railway Review and the Street Railway Journal, will draw to it not only the good-will, the equipment and the traditions, but for the main part the personnel, of both the existing papers. We bespeak for the "Electric Railway Journal" the good-will, the patronage and the support of all of our friends who have so warmly assisted us in making of the Electric Railway Review the strong and reputable publication which it is.

The "Electric Railway Journal" will carry out all engagements which the Review has contracted with both advertisers and subscribers. The subscribers to the Review will receive the "Electric Railway Journal" to the end of the terms for which they have paid their Review subscriptions. Those who are now subscribers to both papers will be credited on the "Journal" mailing list with the unfulfilled terms of their Review subscriptions.

Reports from Cleveland during the past week indicate that a semi-municipal holding company is not a panacea for all the inconveniences incidental to street railway

### Three-Cent Fares and Three-Cent Service.

transportation in a large city and that even 3-cent fares may have their disadvantages. We have previously expressed in these columns a curiosity as to how Mr. Johnson proposed to operate a system at a rate of fare less than the ordinary figure for operating expenses. The past few days have brought some enlightenment and the people of Cleveland are learning things about 3-cent fares that were not included in the campaign speeches. The Municipal Traction Company is charging only three cents within the city limits of Cleveland but two cents additional is charged for a ride beyond the city limits and one cent additional for each transfer. Thus many of the suburban residents are obliged to pay six and even seven cents for a ride to the business district. In addition cars are being rerouted to reduce mileage and short unprofitable routes are being abandoned. The protests against the service of the Municipal Traction Company, voiced at the meeting of the city council last Monday evening, differed from similar expressions against private corporations that we have heard only in the fact that this time the mayor was on the other side of the fence. A 3-cent fare would be an excellent thing if it did not mean 3-cent service.

The conditions surrounding turnouts and sidings vary widely on interurban roads and frequently the obstructions along the

### Painting Poles Near Switches.

right of way are such that a motorman must be thoroughly familiar with the track if he is to approach a switch with any degree of certainty as to just where that switch is located. Sometimes a siding may be just around a curve so that it is very desirable to have a car under full control before the target on the switchstand can be seen. Again, on straight track the line of poles may hide the target so that if the ground is covered with snow it is also especially advisable that some fixed sign be placed where it can always be seen by the motorman and tell him how far he is from the switch. On the Illinois Traction System, to serve the purpose of indicating the location of a switch, a scheme of painting the poles has been found to satisfactorily meet these requirements. Starting at a fixed distance away from the switch, say 1,000 feet, the base of the pole to a height of about 12 feet is painted white. From this pole with its coating of paint 12 feet high each following pole toward the switch is similarly painted, except that the height of the band of paint is regularly decreased by steps. With a line of poles so painted, no matter whether they be on straight track or on a curve, the motorman soon learns to tell without thinking how much distance he has yet available in which to stop his car before it will reach a switch. This scheme of painting poles to a varying height has so many advantages over a sign board which exhibits only the distance between the board and the siding that there is considerable to be said in its favor.

Several recent derailments, some with and others without loss of life, emphasize strongly the value of guard rails. Our steam railway friends, who are, we must admit, more experienced in track construction than we, consider the guard rail a vital part of their track structures and have studied its functions thoroughly. True it is that guard rail construction takes various forms, but the differing types of rails and stringers all are laid with the same end in view. Probably far more than a dozen serious accidents have been averted on interurban lines during the last year from no other reason than that even though the car wheels had left the rails there was a guard rail which constrained these wheels to a path on the ties until some bridge or trestle had safely been passed. In view of the unified agreement that a track structure is not properly built unless the sharp curves and rails on trestles have guard rails or guard stringers, and also because there are many widely different arrangements of rail, stringer and bolted plate, all of which are intended to serve the same purpose, we would suggest that the subject of guard rails is a fit one for consideration by the committee on "Way Matters" of the Engineering association.

#### Standardize the Guard Rail.

---

### SECOND-HAND MACHINERY IN RAILWAY PLANTS.

---

The economies resulting from the use of second-hand machinery in moderate capacity power plants are many. The increasing size of generating and auxiliary equipment in city stations, the need of concentrating as much generating capacity as possible in a given floor space, and the improvements in economy of operation which designers of large units are striving to attain are all tendencies in favor of the transfer of partly worn-out machines to plants where the requirements are less severe.

In the power service of a great urban system it is on the whole true that the traffic is sufficient to support refinements in machinery design which cannot be afforded by the small road. There is consequently an opportunity now and then in connection with the rehabilitation of a large or even moderate sized city plant for the smaller plant of the outlying districts to secure additional machinery suitable for its needs at a reduction in cost considerably below the expense of new equipment.

Large generating stations are almost always designed in detail long before the dates for machinery delivery as promised by the manufacturers, and as a rule provision for future expansion is made with apparatus of the latest type in mind, rather than with second-hand units. Even if the latter type of equipments could be utilized satisfactorily, there would be no certainty that it would be available when it became necessary to enlarge the plant. The need of the most efficient machinery and the most reliable service which money can effect in the plant supplying the larger systems does not favor the use of anything but first-hand apparatus in the majority of large plants. Then, too, the capacities of generators and engines ordinarily available in the second-hand markets do not exceed 750 to 1,000 kilowatts, and it is becoming a rare practice for a large station to install units of such small power in extensions. The small road, however, in most cases finds a machine of even 500-kilowatt rating a most important addition to its resources.

If expansion becomes necessary it is a mistake to overlook the possibilities of the second-hand market if the company is one of rather limited resources. It sometimes happens that even a large plant can be carried past a bad breakdown period by the temporary installation of a second-hand unit.

The most important point in the purchase of any second-hand unit or auxiliary machinery is its physical condition and capacity for the work in the new location. Too much cannot

be known of the operating history of any such apparatus, and after an option is taken upon it, inspection by an engineer of experienced judgment should invariably precede purchase. It is absurd to expect that even a second-hand machine for power plant service can be bought for little or nothing. A machine in good condition may be sold in the second-hand market for perhaps 50 to 80 per cent of its original price, but when the price goes much below these figures it is safe to make a very exhaustive study of the machine's capabilities before accepting it. It may be possible in some cases to make tests of service capacity, regulation, insulation, valve action, parallel operation and convenience of adjustment before taking the unit away from its first place of service. If records of the repairs expended on the machine can be had so much the better. Some consideration also should be given to the ease and safety with which the machine can be taken from its original service and transferred to the new site. The important point of the whole problem is that it is much better for a small road to have the benefits of service from second-hand machines of relatively large capacity, provided they are reliable, than to be short of power through the inability to buy machinery of the latest and most efficient design.

It is not too much to expect a renewed lease of life when a machine of standard design is transferred from the exacting conditions of city service to the less severe requirements of the smaller road, provided it is in fair condition when sold. The fluctuations of the load are relatively more severe in the case of the smaller road, but as a rule the total load is for a time well within the capacity of the plant as a whole when a machine of several hundred kilowatts rating is added to the equipment. An old machine originally designed for railway service will generally stand such fluctuations within its limits of capacity better than it will hold its service under excessive overloads.

To a large extent, of course, each problem in connection with the selection and purchase of a second-hand unit is one of special characteristics. On account of the greater cost of generating units as compared with auxiliary equipment and the enhanced ease of inspection of the latter apparatus, it is not worth while usually to spend much time upon the second-hand market for auxiliaries. Low cost generating capacity interests the average manager of a small road more than reduced prices on minor equipment.

---

## Communications

---

### CLASSIFICATION—HEARING AND ACTION BY OHIO RAILROAD COMMISSION.

To the Editors:

This commission listened to arguments concerning the classification of accounts tentatively proposed by the interstate commerce commission presented by a committee representing about 30 interurban lines in Ohio and Indiana, and also considered the brief filed by these lines with the interstate commerce commission criticizing and suggesting changes in such classification. [See Electric Railway Review of May 2, 1908, page 529.—Eds.] After having heard the committee and considered the brief, the commission addressed a communication to Prof. H. C. Adams of the interstate commerce commission calling attention to the objections of the traction lines and bespeaking for them the consideration of the interstate commerce commission in the matter of the changes suggested in such classification. The commission is in receipt of a letter, in response to the one herein referred to, from Professor Adams, in which he states that his office has modified the tentative classifications to Circular No. 20 very much along the lines indicated by the traction people in their brief.

H. D. MANINGTON,

Secretary Railroad Commission of Ohio.

Columbus, O., May 9, 1908.



**REMODELING AN ELECTRIC RAILWAY POWER STATION.**

The power plant of the Jacksonville Electric Company in Florida has recently been completely remodeled. The new work, which has been carried on by the Stone & Webster Engineering Corporation, included the installation of new machinery and a rearrangement of the existing equipment. An account of this interesting work may be of value to those railway engineers whose power stations will soon need to be remodeled or increased in capacity.

The Jacksonville station is located about a quarter of a

mile from the business center of Jacksonville on the shore of the St. Johns river. The arrangements of the machinery before and after the present improvements were made are shown in the accompanying engravings.

The remodeled plant contains all the machinery that was in the old station with the exception of the old stack and an induced draft system located near the original batteries of boilers on the engine room side of the partition wall dividing the station into two parts. This old stack was built in part of brick and in part of steel, being 100 feet high above the grates and 60 inches in inside diameter. With the aid of a 108-inch fan, driven by an 8 by 6 inch engine, direct connected, it served 1,250 horsepower capacity of water tube boilers. With the additional 520-horsepower boiler to be placed in the plant, there became necessary a new stack 108 inches in diameter and 175 feet high above foundations, and to make room for a new electric generating unit the old stack and fan system were dismantled. The new stack was erected on the outside of the building beyond the boiler room. A flue was run around the outside of the building to the stack, as shown in the illustration, thus making it possible for the stack to serve both batteries. Part of the space formerly occupied by the fan set and old stack is now devoted to the condensing equipment of the new 800-kilowatt unit.

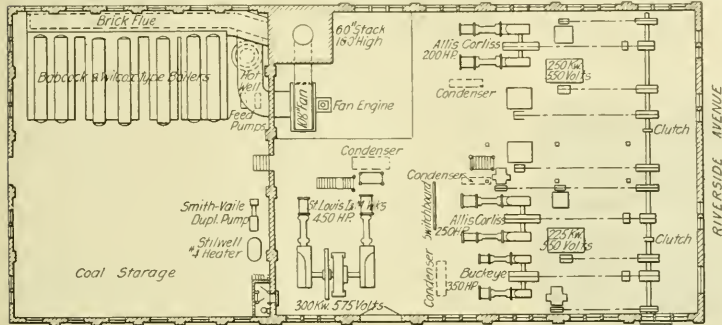

Jacksonville Power Station—Plan Before Remodeling.

mile from the business center of Jacksonville on the shore of the St. Johns river. The arrangements of the machinery before and after the present improvements were made are shown in the accompanying engravings.

The remodeled plant contains all the machinery that was in the old station with the exception of the old stack and an induced draft system located near the original batteries of boilers on the engine room side of the partition wall dividing the station into two parts. This old stack was built in part of brick and in part of steel, being 100 feet high above the grates and 60 inches in inside diameter. With the aid of a 108-inch fan, driven by an 8 by 6 inch engine, direct connected, it served 1,250 horsepower capacity of water tube boilers. With the additional 520-horsepower boiler to be placed in the plant, there became necessary a new stack 108 inches in diameter and 175 feet high above foundations, and to make room for a new electric generating unit the old stack and fan system were dismantled. The new stack was erected on the outside of the building beyond the boiler room. A flue was run around the outside of the building to the stack, as shown in the illustration, thus making it possible for the stack to serve both batteries. Part of the space formerly occupied by the fan set and old stack is now devoted to the condensing equipment of the new 800-kilowatt unit.

The natural draft of the new stack is sufficient to take care of all the boilers in the plant. Part of the stack is cut off with a baffle in the flue arranged so that in the event of the extension of the station still farther in the direction of the boiler room the other side of the stack can be used for the reception of a flue from future boilers. The stack foundations are of concrete on piling, the former being 14 feet deep and 24 feet square. The present boiler plant includes three 150-

and it is turned into the river on the other side of the wharf and about 150 feet from the suction inlet.

The new generating unit is an 800-kilowatt General Electric 600-volt, flat-compounded, direct-current machine, direct connected to a 24 and 48 by 48 Rice & Sargent horizontal cross-compounded condensing engine whose normal speed is 100 revolutions per minute. This engine has a maximum rating of 2,300 horsepower and its steam guarantees are, at 26-inch vacuum, 100 revolutions per minute and 150 pounds pressure at the throttle:

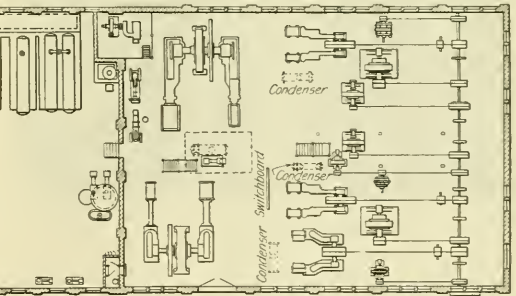

Jacksonville Power Station—Plan After Remodeling.

and it is turned into the river on the other side of the wharf and about 150 feet from the suction inlet.

The new generating unit is an 800-kilowatt General Electric 600-volt, flat-compounded, direct-current machine, direct connected to a 24 and 48 by 48 Rice & Sargent horizontal cross-compounded condensing engine whose normal speed is 100 revolutions per minute. This engine has a maximum rating of 2,300 horsepower and its steam guarantees are, at 26-inch vacuum, 100 revolutions per minute and 150 pounds pressure at the throttle:

Per cent of load.....	50	75	100	125	150
Pounds .....	14.2	13.0	13.0	13.5	14.3

The engine has a 25-ton flywheel and a reheating receiver of 400 square feet surface. It is provided with a 6-inch connection off the auxiliary steam main of the station, which can

two 400 and one 520 horsepower water tube Babcock & Wilcox boilers set in two rows with a central firing aisle 24 feet wide between the old and the new equipment. Space is available for the installation of two more boilers of like capacity as they may be needed. The present load upon the plant is very largely for railway purposes, although the company also supplies current for power and lighting. The new boiler contains 5,200 square feet of heating surface and 88.1 square feet of grate area, with 1/2-inch air spaces. There are two hundred and fifty-two 4-inch tubes in the new boiler. The old boilers are operated at 125 pounds steam pressure, but the new unit is designed for 200 pounds pressure.

The coal supply of the plant is obtained from barges which are brought alongside a wharf located about 600 feet east of the plant. The barges are unloaded by derrick, the coal being discharged into push carts on an elevated platform, whence it is wheeled along the platform structure to a storage yard. It is planned to build an industrial track from the coal storage space across the yard and through the boiler room. Means for weighing the coal will be provided near the entrance to the boiler room.

A Wefugo water softening equipment has been erected outside the boiler room with a connection to the well which supplies the plant and to a new automatic Wilcox

water measuring device installed in the boiler room. The supply of condensing water for the station is drawn from the river through a 16-inch suction pipe carried on hangers beneath a wharf. Near the end of the wharf a suction inlet screen box is installed of capacity enough for two 16-inch pipes with separate compartments for individual cleaning. The main discharge pipe for the plant is 30 inches in diameter

be used to operate the low-pressure side through a reducing valve in case the high-pressure side of the unit is disabled.

The new condensing apparatus consists of an Alberger barometric set with an 8 and 16 by 12 horizontal rotative dry vacuum pump and a volute centrifugal pump driven by an 8½ by 10 inch Harrisburg engine. The condenser is large enough for two 800-kilowatt units, and will condense 40,000 pounds of steam per hour with a 26-inch vacuum and a circulating water temperature of 85 degrees F.

The old equipment of the station, which is retained for railway service, includes a 300-kilowatt generator, direct connected to a 16 and 32 by 42 inch engine and two 250-kilowatt belted sets. It is planned to use the latter only at times of peak load or in other emergencies when economy of operation is not the first requisite. The balance of the machinery is used for power or lighting service. The 300-kilowatt set is piped to the barometric condenser so that either that or a

minimum interference with piping and other station fixtures, and the space occupied was so small that very little delay was occasioned by the existence of the apparatus.

#### STANDARDIZATION COMMITTEE MEETING.

The standardization committee of the American Street and Interurban Railway Engineering Association met at Pittsburg on May 7 and 8 pursuant to a call issued by the chairman, W. H. Evans, International Railway Company, Buffalo. There were present at the meeting the following members of the committee:

W. H. Evans, chairman master mechanic, International Railway, Buffalo, N. Y.

M. O'Brien, master mechanic United Railways Company of St. Louis, St. Louis, Mo.

J. M. Larned, engineer maintenance of way Pittsburg Railways Company, Pittsburg, Pa.

H. W. Blake, editor Street Railway Journal, New York City.

L. E. Gould, editor Electric Railway Review, Chicago, Ill.

C. B. Fairchild, editor Electric Traction Weekly, Cleveland, O.

A complete report of the work accomplished at this meeting is not yet available for publication.

The subjects considered were: "Standard Height of Couplers for City and Interurban Cars"; "Standard Automatic Couplers for Interurban Cars and Radial Draft Rigging"; "Standard Height of Platforms, Car Steps and Bumpers."

The committee's work at Pittsburg mainly comprised the formulating of a scheme for obtaining complete data with which the committee may be able to consider these problems from the standpoint of the requirements of the entire country.

#### PRaise FOR THE BOSTON ELEVATED RAILWAY.

A. E. Pinanski of Harvard law school has been awarded the Baldwin prize of \$100, offered by the National Municipal League for the best essay on municipal relations. The subject of Mr. Pinanski's thesis was "The Street Railway System of Metropolitan Boston." The writer says in part:

In spite of remarks to the contrary (for there will always be those persons who are too ready to attack public service corporations), it must be admitted that the Boston Elevated Railway today puts its great resources and facilities at the service of the public in the most efficient way and in absolute good faith. The position which it now holds in the community may be attributed in a large degree to the high standard of its officials, who have endeavored to meet all questions in a public-spirited way.

The company has continued its liberal policy toward its employes in respect to their wages, as well as in other matters. It is only because of this fact that we are able to say that the employes of the Boston company compare favorably with those of any other large city in the world, in matters of politeness and efficiency, and some enthusiasts say that the standard of the employes is unsurpassed in any other city.

In continuing the policy of introducing semi-convertible cars to parts of the urban and suburban system which will properly admit of their use, the Boston Elevated Railway is continuing the traditions of the Hub's leadership in street railroading. These cars, involving the latest improvements in construction, are characterized by an easy access arrangement, the opening and closing of the doors by compressed air power under control of the motorman, folding cabs in which the motorman operates the car free from the jostling and comments of the passengers and the most improved and modern system of ventilation. Thus it seems that the city of Boston at the present time has very little cause for complaint.

The last report of the Boston Elevated Railway shows that 11 per cent of its net earnings is returned to the city in taxes and other assessments. This is a better dividend to the municipality than is given by any of the municipally operated roads in Europe, including Glasgow. The road gives good service, has no water in its stock, pays dividends to its stockholders and pays the city (which has none of the expense or trouble of management) for the privilege of doing business, \$1,500,000 a year.

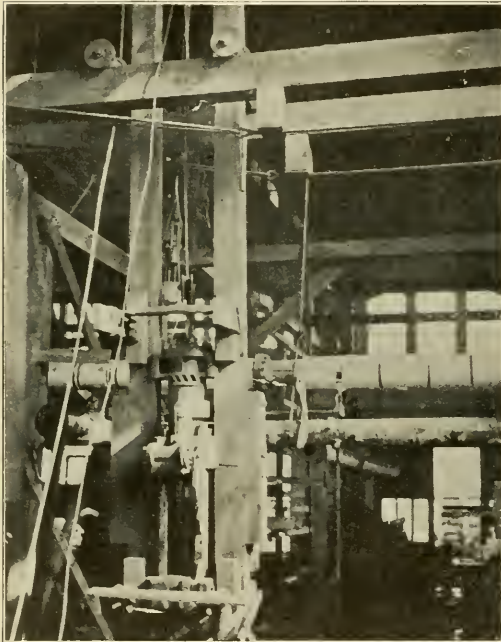

Jacksonville Power Station—Roller Supported Pile Driver Inside Station.

surface condenser originally supplied can be utilized. Ordinarily the new condensing set will be used. All the other old engines are provided with individual surface condensers, but the piping is so arranged that they can also exhaust into the barometric condenser.

In connection with the generator installation the railway switchboard was remodeled and six new single-circuit 1,200-ampere feeder panels added. The board now contains 16 panels, of which three are devoted to alternating-current service and the balance to direct-current uses.

The accompanying halftone engraving illustrates a portable pile driver carrier which was used in the plant's construction in connection with the foundation work for the new generating unit. The driver was installed on a frame carried on two longitudinal timbers and free to move back and forth on roller wheels as shown. The cross timbers were strengthened by iron truss rods on their under sides. The arrangement enabled the work of the driver to be done with the

**BRIEF ON ACCOUNTING SCHEME SUBMITTED TO PUBLIC SERVICE COMMISSION, SECOND DISTRICT, ON BEHALF OF NEW YORK STATE ASSOCIATION.\***

It may be remarked as curious, although doubtless it is immaterial upon the subject under discussion, that the legislature should have seen fit to make provision for a uniform system of accounts for street railroads, the purpose of which must be largely the protection of its public investors, while the many municipalities and quasi-municipalities within the state of New York, all of whose operations are matters of public interest, have never been required to establish any uniform system of accounting with respect to the operations of any of their departments, regardless of whether they involve the operation of public utilities or not. Scientific and exact information with respect to the conduct of municipal government within this state, would seem to be more worthy, or at least as worthy of the efforts of the legislators as similar knowledge about street and electric railroads.

**Differences Between Electric and Steam Roads.**

Neither the federal statute nor the state statute requires, by a fair construction, that the accounting of all common carriers should be uniform and identical, and the marked distinction in the methods of construction and operation of steam or general railroads and street or electric railroads renders the same system of classification of accounts for both kinds of railways incongruous and objectionable.

The certificate of incorporation of a railroad company in New York state must differentiate as to the kind of road to be built or operated. And after incorporation the powers and rights are distinguished in many ways, among them being: (a) With respect to the rights to operate on highways, steam railroads applying to the supreme court and street railroads applying to property owners and local authorities. (b) Street railroads may make extensions, while no such provision or right exists in a steam railroad. (c) Rates of fare are different and governed by different sections. (d) Street railroads are required to issue transfers in certain cases, while no such obligation exists with respect to steam railroads. (e) Street railroads are obliged to pave between their tracks. (f) A street railroad is obliged to permit another street railroad to use its terminals in certain cases, an obligation which is not imposed upon steam railroads. (g) The time within which a street surface railroad may construct and operate its railroad is further limited by the railroad law.

In addition to the distinctions running through all statute law in respect to general or steam railroads and street or electric railroads, there are physical differences even more marked.

1. The rails themselves are different, and the street railroad may not use certain kinds of rails.

2. The roadbed of most street and electric railroads is located upon public highways, while the roadbed of most steam or general railroads is located upon private right of way.

3. The roadbed itself is of different type of construction. 4. The motive power is differently produced and differently applied. While in many cases the primal source of power is the same, to-wit, coal, it is not necessarily so, as many electric railroads are operated by electric power produced from the fall of water, but even where the primal agency is coal, the method of utilizing it as a motive force is entirely distinct in steam and electric railways, with the resultant economies largely in favor of the street or electric railway. In the case of street railways the coal is converted into electricity at a central power station, and is transmitted by means of conductors to the motors on the cars. In the case of steam railroads, the coal is burned on the unit, or train, converting water into steam on that unit, in operation. In the case of the electric railroad a large investment in electrical machinery, buildings and transmission conductors is necessary, which has no counterpart in steam railroad accounts.

5. The character of the service rendered is entirely different, steam or general railroads deriving their main income from freight, while street or electric railroads derive their main revenue from passenger service.

\*Abstract of document prepared by the following committee of the Street Railway Association of the State of New York: Henry J. Pierce, president International Railway Company of Buffalo, chairman; C. Loomis Allen, vice-president and general manager Syracuse Rapid Transit Company; E. S. Fasseti, general manager United Traction Company, Albany; A. L. Linn, Jr., general auditor Mohawk Valley lines; J. C. Collins, auditor Rochester Railway Company; H. M. Beardsley, treasurer Elmira Water Light & Railroad Company; Morris Cohn, Jr., counsel to the committee.

Upon this subject we submit the following comparative statement, showing gross earnings of steam and electric railways in the state of New York:

	Steam Railways		Electric Railways.	
	Amount.	Per cent.	Amount.	Per cent.
Passenger .....	\$ 99,720,261.64	26.35	\$77,848,747.92	98.76
Freight .....	250,313,697.83	66.13	498,207.06	.63
Express .....	10,756,622.40	2.84	271,473.69	.35
*Miscellaneous..	17,689,888.22	4.68	200,875.42	.26
	\$378,480,470.09	100.00	\$78,819,304.09	100.00

\*Miscellaneous earnings contain mail and baggage receipts, rent of equipment, etc.

A comparative statement of cars in service for steam and electric roads follows:

Steam railroads—			
Locomotives .....		9,125	2.79%
Passenger cars .....		8,089	2.47%
Freight cars .....		307,312	94.00%
Baggage and mail .....		2,438	0.74%
Total .....		326,964	100%
Electric railways—			
Locomotives .....		9	0.06%
Passenger cars .....		*14,442	93.55%
Freight, express and mail .....		987	6.39%
Total .....		15,438	100%

\*This includes motor cars and trailers.

Note.—Snow plows, snow sweepers and work cars are not in this report.

6. Street railroads operate small train units, consisting of one or two cars, and at frequent intervals, while steam railroads operate large train units of from 4 to 12 passenger cars, and from 20 to 100 freight cars, at infrequent intervals.

7. The method of collecting and registering fares is entirely dissimilar. On street railroads fares are for the most part collected in cash by conductors on the cars, while on steam railroads fares are received, for the most part through the sale of tickets at depots, the tickets covering, frequently, not only the railroad at whose station the ticket is sold, but also various other lines, which means an entirely different system of accounting in this respect.

8. The units of comparison used by street railroads are the "car-mile," the "car-hour" and the "per car per hour," while on steam railroads the units of comparison are "passenger—per mile," "ton—one mile" and "train-mile."

9. There is an entire and obvious dissimilarity between the terminal facilities and charges of steam railroads and street railroads.

10. In practice street railroads construct their lines to the doors of their passengers, while steam railroads are operated usually between large centers. The street railroad goes to the home of the passenger, while the passenger is obliged to go from his home to the steam railroad.

Upward of 60 years of steam railroad practice have evolved a system of accounting for steam railroads which may fit its requirements, and for over 20 years the greater part of the steam railroads have been subject to the jurisdiction of the interstate commerce commission and that commission and its officials have become entirely familiar with all the methods and characteristics, both in respect to accounting and otherwise of the steam railroads. The street railroad companies have been operated by electricity as a motive power for the most part for less than 20 years, and a very large percentage of the street and electric railroads have not been operated for over 10 years. The street and electric railroads have not either for a long time or in a great measure been in touch with the interstate commission and an intimate knowledge of methods of operation and accounting which the interstate commission has acquired in 20 years of familiarity with steam railroads cannot possibly have been acquired in respect of street and electric railroads in the brief interval of not exceeding two years, that the attention of the interstate commission has been turned to street and electric railroad matters.

In a very large degree street railway problems are entirely local. In so far as the street railways are operated within the confines of a single city, the application to them of the necessarily large and comprehensive views of the interstate commission is likely to be misfitted. The large majority of street and electric railroads, both urban and interurban, under the jurisdiction of the public service commission of the second district, New York, are in no manner engaged in interstate commerce and are not subject to the control of the interstate commission.

At the meeting of the American Street and Interurban Railway Association and the American Street and Interurban

Railway Accountants' Association, held at Atlantic City in October, 1907, the matter of the classification was taken up, with the result that the former classification was enlarged so as to include 50 primary accounts, and the classification adopted by these associations in October, 1907, contains, as this committee believes, full and sufficient primary accounts for all the known purposes of the street and interurban railways within the jurisdiction of the public service commission, second district, New York. The influences which caused the enlarged number of primary accounts adopted at Atlantic City were the growth and requirements of interurban railways and the agitation of various supervising boards and bodies in reference to the character of the accounts of street and interurban railways. As 50 primary accounts, amplified to meet the particular requirements of individual roads, furnish all the detail and information which the managing and operating officers of a street railroad need, it seems to the committee to follow that they must contain all the information which supervising and regulating bodies or the public would care to know.

It is respectfully submitted that the results of the years of work of the street and electric railway accountants should not be lightly set aside and a substantially steam railroad classification substituted therefor, without the strongest and most important reasons. In fact, if steam and electric railway accounting must be identical, it is respectfully submitted that steam railroads are more likely to become electric railroads than are electric railroads to become steam railroads, and therefore, logically, the system of steam railroad accounting might better be amended to conform to the experience, theory and practice of electric railroads than otherwise. We venture to say that there are few if any cases of the substitution of steam as a motive power upon a railroad which had been operated electrically and the contrary tendency is everywhere apparent.

#### Primary Operating Expense Accounts Unduly Extended.

The primary operating expense accounts in the tentative classification are unduly extended beyond the point of practical benefit for any electric railroad, and its adoption would cause peculiar and unnecessary hardships upon the smaller roads affected if the keeping of 116 primary accounts shall be incumbent upon all lines having a gross annual revenue of \$50,000 or over.

The following electric railroads operated in the state of New York in the year ended June 30, 1906:

		First district.	Second district.	New York state.
Gross earnings and number of companies of less than \$	10,000	6	8	14
Between \$	10,000 and 25,000	1	16	17
	25,000 and 50,000	3	10	13
	50,000 and 75,000	2	11	13
	75,000 and 100,000	1	4	5
	100,000 and 200,000	4	10	14
	200,000 and 300,000	2	3	5
	300,000 and 400,000	..	2	*3
	400,000 and 500,000	1	..	1
	500,000 and 600,000	1	1	2
	600,000 and 700,000	..	1	1
	700,000 and 800,000	..	..	..
	800,000 and 900,000	1	2	3
	900,000 and 1,000,000	1	..	1
	1,000,000 and 1,500,000	..	1	1
	1,500,000 and 2,000,000	3	1	4
	2,000,000 and 3,000,000	..	1	1
	3,000,000 and 4,000,000	1	..	1
	4,000,000 and 5,000,000	..	1	1
	5,000,000 and 10,000,000	..	..	..
	10,000,000 and 20,000,000	3	..	3
Total		30	72	103

\*One company located in both districts.

The distribution of payments for damages over eight separate primary accounts will result in confusion rather than clarity. The cause of a given claim for damages is not infrequently in itself uncertain or the result of two or more unrelated facts, so that the expense may be distributed as caprice may direct. The percentage of earnings of electric railways which are absorbed by claims for damages are very much higher than the percentage of earnings required for this purpose by steam railroads.

In the same manner the distribution of expenses of stationery and printing over seven accounts and the distribution of insurance over six accounts and the distribution of expense of power over various accounts, where it cannot be absolutely measured, but can only be arbitrarily divided, are fair examples of the criticism which we have made upon the unneces-

sary refinements involved in the tentative classification.

The so-called "adjustment accounts" introduce a new factor in street railway accounting. Heretofore only the net results of outside operations have been treated at all, and those have been treated as credits to income account from sources other than operation. With the majority of street railroad corporations these accounts will be of minor consequence, but in the absence of a classification of electric railway revenue, no benefit or statistical information of value can be obtained from the addition of the accounts referred to.

While the committee does not urge all the foregoing criticisms as formidable and insurmountable objections to the tentative classification, may it not in fairness ask why the classification containing these troublesome, expensive and necessarily inaccurate accounts should be imposed upon the street railroad companies, arbitrarily destroying comparisons to that extent with the past, and setting up accounts which years of street railway practice have not found necessary, and which street railway accountants and managers almost universally condemn? The committee thoroughly believes that a system of classification which would eliminate subgeneral accounts, limit the primary accounts to approximately 50, which should be compulsory upon all street railroads, and allow subprimary accounts to those street railways which desired to use them, would make for a harmonious and logical system of accounting which would not be burdensome upon the smaller roads, and the option of using subprimary accounts of which would be almost universally exercised by the larger roads.

#### Construction Expenditures.

The substance and character of the criticisms made in respect to the operating expense accounts are largely applicable to the tentative classification of expenditures for road and equipment.

The present classification of construction and equipment accounts has been in use for years and has proved entirely adequate for the needs of existing street railway companies. Heretofore these accounts have been kept under a single head known as construction and equipment accounts, and it would be exceedingly difficult, if not impossible, to divide the charges heretofore made to this single account so as to conform to the tentative classification of expenditures for road and equipment submitted in Circular No. 20. To keep the future expenditures for road and equipment in accordance with the proposed classification would not be either difficult or impossible, but would be of slight value in the case of existing companies where by far the larger part of the expenditures for road and equipment have been already made and cannot be so subdivided.

The general objection as to excess of detail made in respect to the primary operating expense accounts applies with equal force to the proposed classification of expenditures for road and equipment. The note to account No. 61 under this head which forbids the charging of discounts on securities issued for construction purposes against construction is against all precedent, and no necessity for such rule is suggested or we believe can be shown. It is apparent that securities issued for construction cannot at all times and under all circumstances be sold at par or without a discount, and where the discount is paid, whether it is paid direct to a purchaser or whether it is paid as commission to a broker makes no difference in fact, and ought to make no difference in the theory of such an account.

#### Joint Facilities Accounts.

The joint facilities accounts involve expense and detail out of proportion to the statistical value of the results, and although the principle involved may be correct in theory, its use would produce inaccuracies in practice because of actual conditions.

The avowed purpose of the joint facilities accounts is, we take it, to correctly state and distribute the actual revenues and actual expenditures between companies using the same tracks or facilities, in whatever form or manner such use may occur, and the payment for it be made. This question arises in electric railway practice, for the most part, in the case of interurban companies whose cars are operated on other lines within the limits of large cities. Passengers are transported over the city lines under contract agreements of innumerable differences of character and detail. The practicability or necessity of applying to electric railway carriers the principles involved in the complicated structure of joint facilities accounts is, in view of the circumstances and number of the transactions involved, doubtful. Its main practical importance would be upon the percentages of total operations when combining the reports of all the electric railroads in the country or a given district, and the circumstances and number of these transactions are not sufficiently great to make an appreciable impression upon the total percentages.

Let us assume the case of an interurban road whose cars are operated over a city line, for which service the city company receives a proportion of the fare collected within the city, say 2½ or 3 cents for a 5-cent fare per passenger. It is proposed by the tentative classification to divide the money so received between: 1. Use of capital. 2. Maintenance expenses. 3. Transportation expenses. 4. Administration expenses, if any.

The first difficulty which is met in making such a subdivision is found in the fact that the cars are usually operated over a given piece of track by the interurban company, and that passengers are frequently transferred without additional charge to other lines of the city company, with which the interurban company has nothing to do. How is it possible, except by arbitrary statement, to fix the amount of capital used? And how can even any such arbitrary statement represent any degree of accuracy? How is it possible, by other than an arbitrary division, to fix the amount of the fare properly chargeable to maintenance, and what part of the track, if less than the whole, is included within the maintenance to be charged? How is the power expense of the city company to be divided and how is the amount of power used by the interurban company to be ascertained? And the same questions arise, no matter what the form of the operating agreement. This subject opens up such a tremendous field of speculative accounting as to be little less than appalling. Moreover, all of the contracts under which such joint facilities are now provided have already been made and run for many years. If the total payments under existing contracts are not all absorbed by the four subdivisions laid down, to what account should the surplus be credited, and if a total computation of the four items stated shows that they exceed the amount received in the way of income, from what source shall the deficiency be made up? Any information obtained under the plan proposed would be more than likely to be untrustworthy and valueless because made on arbitrary division. The amounts involved in the joint facilities in the second district of New York are exceedingly small but in some instances there are two or more urban companies upon whose tracks one or more interurban companies are operating. An attempt to follow out the joint facilities accounts in respect to expenditures would only result in a condition of confusion which would be hopeless and inextricable. The committee, with some diffidence, ventures to urge that, so far as electric railroads are concerned, the whole question of joint facilities can be disposed of in the revenue accounts, if the lessee company shall deduct from its gross revenue payments made by it on account of joint facilities, and the lessor company shall include such items in its gross revenue. No confusion can accrue under such a plan in assembling statistics into totals.

We also venture to respectfully differ from the statement made in respect to the tentative classification that so far as relates to street railways there is a definite and long-felt deficiency in the subject which these particular accounts meet.

#### Depreciation.

The mandatory and arbitrary charges for depreciation contained in the tentative classification should not be required.

The discussion of the subject of depreciation opens an apparently inexhaustible field, and the committee believes that by subdividing the subject a clearer view of the matter can be obtained. In what is said the committee has not been un mindful of the expressions made by your honorable commission in its report for the six months ended December 31, 1907, in which you say in substance that the question of keeping a depreciation account is one that you cannot consider to be open to debate.

#### History of the Past and Theory of Depreciation.

The wonderful development of railroads in the United States is primarily accounted for by the energy of its people, stimulated by its climate and the fertility and resources of its soil. The construction and operation of railroads have been fostered and encouraged by legislative enactment, and the incentive of substantial profits has in the past induced courageous and far-seeing men to devote their abilities and lives to railway construction and operation, and it may be assumed that only these favorable conditions and incentives would have so influenced them.

The history of American railroads has been with a few minor setbacks a story of progressively increasing earnings, largely due to the upbuilding of the country by the existence of the railroads themselves, and while this condition of progress has continued it has not been thought essential or proper to keep from the owners of the property that return upon their investment which the net earnings and actual increase in the value of the property, as shown by the increase of gross earnings, would apparently warrant. During this period of progressively increasing gross earnings, direct

charges for depreciation have been for the most part omitted in all railway accounting, and doubtless, as was stated in the report of this commission for the six months ended December 31, 1907, "such depreciation has been handled not infrequently by increasing the capitalization."

Steam railroad companies have thus been permitted to keep up their properties, without objection, and, as we believe, without harm, to the public, for a period covering in many cases half a century, and the electric railroads which are even yet not far beyond the threshold of their development have naturally and, as we maintain, rightfully followed the same practice.

In theory, of course, charges of depreciation in respect of roadbed, buildings, structures and equipment, and credits of appreciation for right of way, terminals and franchises, would doubtless have been more scientific, but probably not more exact. The question of depreciation is fundamentally, to use part of the language of Professor Adams, a question of values, and following that premise it may be fairly said that the question of depreciation or appreciation of a property is not a question of accounting at all, but is a question of policy and judgment, to be wholly determined by the directors.

Charges of depreciation, when made, are of necessity arbitrary, and the extent of charges to meet actual depreciation in roadway, buildings, structures and equipment will necessarily vary. They are dependent upon the nature of the original construction and character of the original equipment, the extent of the use, topography, climate, the relation between type and character of equipment and roadway construction, the extent of maintenance charges, the length of franchise rights and other matters of detail, and the establishment of an arbitrary or standard rule of depreciation in respect to roadway, buildings, structures and equipment will be of little value to anybody for any purpose.

Assume, if you please, that a corporation owns and is engaged in the management of a piece of real estate in a growing community upon which is located an office building; that the building depreciates in physical condition year by year, but the rents and value of the land each continue to increase. Would anyone contend for a moment that a proper system of accounting would require that the corporation reduce its book assets annually by the amount of depreciation of the building and limit its capacity to make returns to the owners of the property by such a system of accounting? There has clearly been no depreciation of the value of the property as a whole, as is evidenced by the increase of its rental production, and a theory or system of accounts which would require the charging off of depreciation of the property by the extent of depreciation of the building while a progressive increase of the rental and salable value continues inflicts an injustice upon the present owner, whatever may be its effect upon the distant future owner.

We assume that it is not the purpose of any board or body to take the position that any future increase in the value of the real estate and franchises of a street or electric railroad corporation belongs wholly to the public, and not to the stockholders, and that the latter should be deprived of the benefits of any such increase in value. If the owners of these properties are entitled to a fair share of the benefits accruing from the growth of the communities in which the properties are located, and from the increase of the business of the company, then the question of the amount of depreciation to be charged (under perhaps some public regulation to prevent a waste of the property) should be wholly left to the discretion of those to whom the owners have entrusted its management.

#### Effect on the Present.

The mandatory establishment of depreciation accounts in any form would have a discouraging effect upon those progressive spirits who have been responsible for the extraordinary development of electric railways in this country. It would be an exceptional experience for a street railroad that it should from the commencement of its operations be able to pay its fixed charges, and it would be extraordinary for a street railroad to be able from the commencement of its operation to pay its fixed charges and a dividend upon its stock.

The result of the establishment of fixed arbitrary and mandatory depreciation charges may be to serve notice upon any projected enterprise of this character, that under no possible conditions will it be able to remain solvent, if it is constructed out of the proceeds of bonds whose interest constitutes a fixed charge upon its property; and, therefore, unless it is prepared to face a series of years of deficits, the enterprise should be abandoned at its inception.

As to the existing properties, the mandatory depreciation accounts will prevent the continuance of dividend payments in the few instances where such payments are now made, and in respect to the others will either involve the exhibition of a deficit in its income account or so slight a surplus as to in

either event limit its capacity to obtain further moneys for necessary extensions, betterments and improvements.

Sixty-one of the 72 companies in the second district paid no dividends during the year ended June 30, 1906, and the surplus for that year showed a narrow margin above expenses and fixed charges in almost every case.

It is but fair for the committee to acknowledge its belief that the charging off of a sum for depreciation would give to the company a credit and reputation of stability that would be of value, but this credit and reputation would not overbear in the minds of investors the fact of an actual deficit shown or a discontinuance of dividends heretofore paid; and the amount of the charge for depreciation for this reason, as well as for the differences in physical and operating conditions above given is a matter that should be determined (subject always to the control of the commission) by those in charge of the management of the property.

The committee does not deny that possible benefits may accrue to the street railway companies in their relations to the public, from the keeping of some depreciation account, and at the meeting of the Street Railway Association of the State of New York, at which this committee was appointed, the committee was authorized to attempt to procure the establishment of a permissive depreciation account, to be treated as a deduction from income.

#### Proposed System of Depreciation Accounts Should Not be Adopted.

It is respectfully submitted that the number of the separate accounts for depreciation, each of which must be based upon an estimate solely, is a theoretical and technical structure, which in actual practice is more than likely to collapse. Separate and definite depreciation accounts for the various portions of the property, as set forth in the tentative classification, could be used only for the purposes set forth therein and could not be transferred from one account to the other, as occasion might require.

It is further respectfully submitted that the prices of equipment and of material, and the total construction cost upon which depreciation is to be charged varies greatly in different years, so much so, in fact, that we have seen certain kinds of second-hand material sell within recent years for more than its original cost new. Under full and complete maintenance charges it might be fairly said that there could be no depreciation, and the inevitable result of fixed depreciation charges along the lines of the tentative classification will be to prevent the prompt adoption of the newest methods and equipment because of the existence of the depreciation accounts. We think it cannot be claimed that fixed monthly charges for depreciation are theoretically correct, since that part of depreciation which is due to use is greatest when use and earnings are the greatest, and since use in each month is not constant and uniform, by the same sign depreciation due to use is greatest in the month when use and earnings are greatest. All depreciation is, of course, not due to use, and the above argument would not apply to depreciation due to lapse of time obsolescence, casualty and other causes unrelated to actual use.

A single depreciation account or fund established and continued as the condition of the railroad and the judgment of its directors might require, created and used for the replacement of all or any portion of the property according to the judgment of those entrusted with its management, is all that ought, from any point of view, to be included in any classification imposed or adopted by governmental officials. Accounts are records of the past and present, while depreciation deals largely with the future.

The establishment of any depreciation accounts at the present time is revolutionary enough. Some companies have taken steps in the direction of the establishment of such accounts. They are for the most part the older and better established railways, and the charges in these instances for depreciation have been usually based upon a percentage of the gross revenue.

It is the unanimous and unqualified judgment of the members of the committee, all of whom have had large experience with electric railway operation management or accounting, that the present establishment of depreciation accounts along the lines contained in the tentative classification should not be made, and that the adoption of the tentative classification in this respect would work a serious hardship and injustice upon the street railway corporations, their bondholders, their stockholders, their future development, and upon the traveling public, and the communities which these corporations serve.

It is respectfully urged that the postponement of a determination upon this exceedingly important subject is, in view of existing financial conditions, highly desirable, and that a gradual evolution, rather than a radical revolution, in treating and disposing of the matter of depreciation will be

for the ultimate benefit of all, and presents the correct method of solving the problem.

#### Conclusion.

The committee would be glad to supplement this brief, at a hearing to be appointed by the public service commission, where such formal or informal discussion of the questions presented by the brief as the commission may think of value, could be had.

The committee begs to acknowledge the courteous treatment of the commission in permitting the presentation of the views of the committee on behalf of the Street Railway Association, and solicits such further action on the part of the commission as shall avoid the various serious difficulties and disasters which the committee believes would follow the adoption of the tentative classification contained in Circular No. 20 of the interstate commerce commission.

#### REPLY TO INTERSTATE COMMERCE COMMISSION'S ACCOUNTING CIRCULAR.

BY M. E. STARRING, PRESIDENT NORTHWESTERN ELEVATED RAILROAD, CHICAGO.

Referring to Accounting Series Circular No. 20 and the questions submitted by the interstate commerce commission this company begs to submit the following statement: That it recognizes that the questions were formulated for the consideration of so-called interurban electric railroads; that is, as we understand it, those railroads organized under the general railway act and reporting to the state railway commissions. We therefore feel that suggestions or criticisms from us should be made with a view solely to the application of these questions and the proposed standard of accounting to elevated railroads only.

Referring to the tentative classification issued by the American Street and Interurban Railway Association, with a view to obtaining from the companies interested therein data regarding the availability or lack of availability of 116 numbered accounts and 6 clearing accounts, this company begs to report that 37 of said accounts are not applicable in any way to the business transacted by this company; that the division of some of the accounts, such as those numbered 80 and 81, would entail upon this company a large increased bookkeeping expense without, so far as it can see, aiding in any way in any needed comparison. As to some of the accounts the charges thereto would amount to less in dollars and cents than the value of the time for the clerk employed in making them; for instance, "Bridges, Trestles and Culverts," of which this company maintains one, which so far has cost nothing for maintenance; the company considering that the depreciation thereon is taken care of in its general depreciation account.

With regard to the line of demarcation based upon the annual gross receipts, while this company would not be affected thereby, it nevertheless believes that to compel companies with annual gross receipts of under \$50,000 to keep and carry out such an elaborate distribution of accounts would cost the companies more than any possible saving to them or good to the public could warrant. If a line of demarcation is to be observed we respectfully submit that the line should be drawn at annual gross receipts of \$1,000,000.

The approximate aggregate charge to operating expenses for the year ending June 30, 1908, resulting from the application of the theory of depreciation to the equipment of this company, as outlined in Account No. 59 (a), would amount to \$24,427.92; that being the amount which it is estimated would amortize the original investment at the end of 25 years. As this company endeavors to maintain its equipment at 100 per cent good, the depreciation upon its equipment for utility would be practically nothing. It is uncertain what, if anything, should be charged for depreciation for style.

It is announced that the Northwestern Elevated Railroad will begin operating trains over the new Evanston extension on Saturday, May 16.

MONROVIA STATION OF THE PACIFIC ELECTRIC RAILWAY.

The Pacific Electric Railway of Los Angeles, Cal., has recently completed a handsome concrete passenger and freight

of Myrtle and Olive avenues. The building is 121 feet long and with the concrete platforms occupies a space 36 feet wide.

The principal features of the construction are shown in the drawings presented herewith, for which we are indebted to George E. Pillsbury, chief engineer of the Pacific Electric



Pacific Electric Railway—Standard Concrete Station at Monrovia.

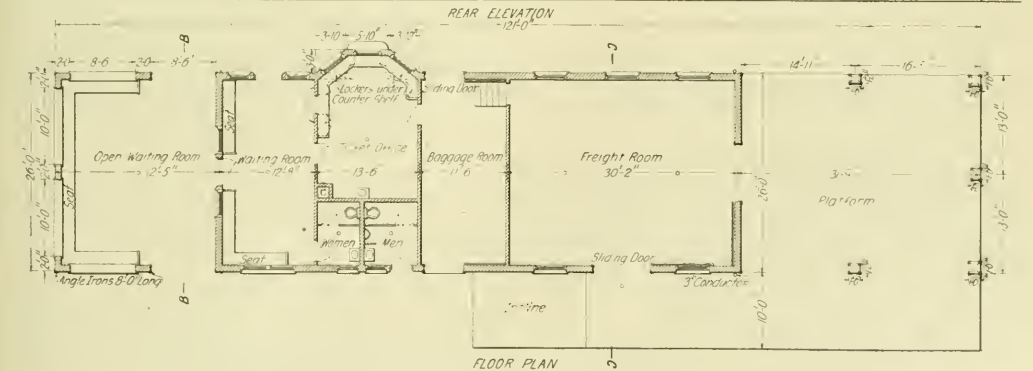
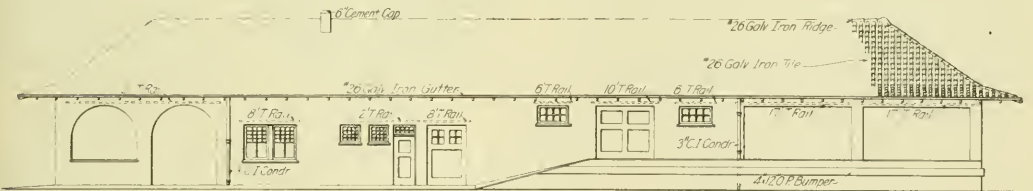
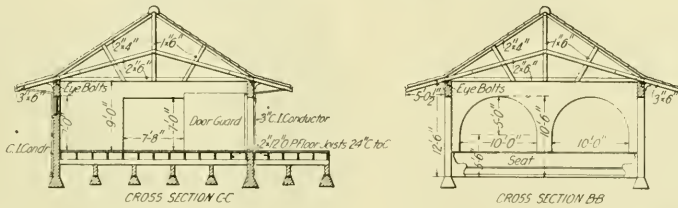

Pacific Electric Railway—Floor Plan, Elevation and Section of Monrovia Station.

station at Monrovia, Cal., which is illustrated in the accompanying engravings. In general the details of the building correspond closely to the company's standard type for suburban passenger stations. It is located at the southeast corner

Railway. Both the foundations and the walls are of concrete, all openings being reinforced by T-rails, varying from 6 to 21 pounds per yard in weight. All corners are protected by angle iron. The roof is of galvanized iron tiling painted red.

The walls are painted buff, with brown trimmings, giving a very pleasing effect.

Except in the open waiting room, which has a cement floor, the flooring is of Oregon pine boards. In the waiting room and the ticket office a wainscot extends to a height of 3 feet 7 inches. The baggage room has a wainscot 8 feet high.

The accommodations consist of open and closed waiting rooms, toilets, ticket office, telegraph office, baggage room, freight room and a platform for the loading and unloading of freight matter. At the rear of the building an incline leads to the platform for the handling of freight. Facilities are also provided for the handling of express matter by Wells Fargo & Co., a portion of the baggage room being set apart for this purpose.

#### CONDITION OF THIRD AVENUE RAILROAD, NEW YORK.

F. W. Whitridge, receiver of the Third Avenue Railroad of New York, has sent a report to the bondholders' committee concerning the disclosures made by investigation of the property and the prospects held out by the future.

Regarding the recent abolition of transfers between lines of the Third Avenue road and the Metropolitan Street Railway, Mr. Whitridge says: "The result to some extent has been disappointing, as the number of passengers carried has fallen off during the first few days something like 60,000 a day. The receipts, however, remain about what they were, and I am hopeful that a part, at least, of the passengers who have abandoned us will return." Mr. Whitridge stated that he is preparing a petition to the United States circuit court for permission to abolish transfers in the Bronx with the Manhattan elevated road.

Mr. Whitridge estimates that \$4,056,000 should be spent on the property within a short time to build an extension and provide, among various additions, the following: 250 to 300 new cars, at a cost of about \$1,500,000; new substation for the Union Railway at One Hundred and Sixty-first street, \$225,000; repairs on substations, \$109,000; putting old cars in first-class order, \$300,000; new cars ordered, \$300,000; repairs to track, \$136,000; substation at Kingsbridge, \$225,000; repairs to buildings, \$151,000; and a club for employes.

In referring to funds received from the sale of bonds of the Third Avenue road, Mr. Whitridge said he had ascertained from bankers that checks for \$17,000,000 from the National City Bank, \$17,564,444 from the National Bank of Commerce and another for \$1,943,000 were turned over to the company. In his judgment there is "no evidence on earth or under the earth of the expenditure of any such sum of money on the system."

The auditor appointed by the receiver had reported that more than \$20,000,000 of the money was expended prior to the lease to the Metropolitan company upon work, part of it done by contract for which the contractor's pay was 15 per cent on the cost. Mr. Whitridge continued:

As respects the balance of the money I have not found and no one has furnished me with evidence of misappropriation, waste or peculation. I believe, generally speaking, that everything which has been done can be traced, but to endeavor to track the whole of the money would cost possibly \$200,000. There would be no certainty after I had tracked it that I should be able to recover any part of it for the bondholders or the company. Under these circumstances I deem it my duty not to undertake any suits or proceedings of any kind in respect to the expenditure of this money.

The company has claims against the Metropolitan Street Railway and the New York City Railway companies in large amounts, but Mr. Whitridge can perceive "no very great use in obtaining judgments." He added:

No such judgments could be collected. They would only share in the foreclosure sale of the Metropolitan, and, as has been very well said, they would represent practically only "stage money." If some provision can be made for the settlement of the franchise taxes by the receivers of the Metro-

politan road and for the refunding to me of the cash collected upon the Third Avenue road subsequent to the date of the last payment by the Metropolitan under the lease, less the cost of operation, I think it would be good business and a great economy of time, temper and legal expenses for all these claims on both sides to be abandoned.

Mr. Whitridge said that when he took charge as receiver the company had no offices and no supplies; that its shops had been neglected for years and that the tracks and cars were in very bad shape, the power house only being in good condition. Of the 567 cars turned over to him by the New York City Railway there was only one which did not need immediately some repairs.

The replies of Mr. Whitridge to orders of the public service commission, first district, attached to the report, comment caustically upon the work of the commission. In response to an order for 360 new cars in less than 90 days, Mr. Whitridge wrote:

If you have anybody on your staff who can show us how to get material before the manufacturers will agree to furnish it, and who can turn out 360 cars in this Third avenue shop between now and May 1, I will pay him any salary you will fix to take charge of the job until that date; otherwise I am obliged to say to you that, with the best will in the world, I cannot comply with order 260. The only thing I can say is that to the extent of my capacity I shall be only too glad to come as near to the terms of that order as possible.

Respecting the general utility of the commission Mr. Whitridge said:

Almost any commission, however inexperienced or ill-informed, would have been a boon to the investing public and the Third Avenue Railroad during the seven or eight gay years of the Metropolitan's misspent life. The commission which now exists will also doubtless prove useful; it has not spared expense nor shunned publicity in its desire to serve the public. It has directed to me orders of one sort or another on an average of one every five days, and I annex copies of some of my replies thereto so that those who undertake the reorganization of this property may judge of the degree of assistance or hindrance they are likely to meet from the public service commission. However useful it may become it is the fact that so far as the Third Avenue Railroad is concerned, the public service commission has, as yet, with the exception of a trifling suggestion about insulating certain wires under the cars, proposed nothing novel; has hastened nothing which we were trying to do and has accomplished nothing at all, except to give me a little more trouble, "of which," as the late Mr. Dingley observed of books printed in foreign languages, "we already have a sufficiency."

#### CENTRAL ELECTRIC RAILWAY ASSOCIATION.

F. D. Carpenter, president, announces that the next regular meeting of the Central Electric Railway Association will be held at the Boody House, Toledo, O., on Tuesday, May 26, 1908. This being the last regular meeting until September 24 it is hoped that as many as possible will be in attendance, as the "Mileage Book" and "Traffic" committees will make their final reports and it is desirous that some definite action be taken so that the work may be carried on during the summer.

The programme will be as follows:

##### Morning Session.

10 a. m. Order of business.

11 a. m. "Insulation of High-Tension Transmission Lines." Paper by Francis S. Denneen of the Ohio Brass Company, Mansfield, O.

12:30 p. m. Adjourn for lunch.

##### Afternoon Session.

1:30 p. m. "Merit and Demerit System of Discipline." Paper by Frank Hardy, superintendent Ft. Wayne & Wahash Valley Traction Company, Huntington, Ind.

2:30 p. m. "Tickets as a Fare Medium for Street and Interurban Railway Traffic." Paper by John F. Ohmer, president The Ohmer Fare Register Company, Dayton, O.

3:45 p. m. "Employers' Mutual Benefit Association." Paper by H. E. Vordebank, auditor Ft. Wayne & Wahash Valley Traction Company, Ft. Wayne, Ind.



## ANNUAL CONVENTION SOUTHWESTERN ELECTRICAL AND GAS ASSOCIATION.

The fourth annual convention of the Southwestern Electrical and Gas Association was held on May 7, 8 and 9 at the St. Regis hotel, El Paso, Tex., and in point of attendance and exhibits of supply houses was the most successful ever held by the association. The application of 13 companies for membership in the association was accepted. The attendance was 140, of whom 27 were ladies.

### Thursday Session.

The convention was called to order on Thursday morning, May 7, by President H. T. Edgar, vice-president and manager of the Northern Texas Traction Company, Ft. Worth, Tex. Hon. Joseph U. Sweeney, mayor of El Paso, made the address of welcome, which was responded to by H. S. Cooper, manager of the Galveston Electric Company. The president then read his annual address, giving a résumé of the work of the year and making several recommendations for the good of the association, which may be summarized as follows:

That meetings of the executive committee be held at least twice a year.

That the work of the secretary in collecting and classifying data regarding taxes, donations, etc., paid by the member companies be continued, and also that the secretary arrange in the future to collect and classify other information of general interest to the members of the association.

That the past records of the association be printed and sent out to the members.

That future conventions always arrange suitable exhibit space to be furnished free for the use of associate members.

That an assistant secretary be appointed, to be paid by the secretary and to maintain an office in Dallas.

That certificates of membership be furnished to the members of the association, with the request that they be framed and put up in their offices.

That a committee of four be appointed for the purpose of fostering closer relations with the national and other societies.

That a committee on municipal ownership be appointed. A committee of five was appointed to act upon the recommendations contained in the president's address. The programme was then taken up. Mark Lowd, southwestern manager of the Stone & Webster Engineering Corporation, Dallas, Tex., had prepared a paper on "Track Construction," which is published elsewhere in this issue. In the absence of Mr. Lowd the paper was read by C. H. Ladd of Ft. Worth and was followed by a discussion. J. A. Myler, Jr., then read a paper on "Testing and Proving Gas Meters." After a discussion of the paper the meeting adjourned until 2:30 p. m.

The first order of business at the afternoon session was a discussion on "What Policy Should be Pursued by Public Service Corporations in Making Extensions," which was participated in by representatives of the electric railway, lighting, telephone and gas interests. The remainder of the afternoon was devoted to a discussion of the "Question Box," edited by Samuel Kahn of San Antonio, Tex. Extracts from the "Question Box" will be found elsewhere in this issue.

### Friday Session.

The Friday morning session was opened with a paper on "Gas Producers and Gas Engines," by W. B. Tuttle, vice-president and general manager of the San Antonio Traction

Company. In Mr. Tuttle's absence the paper was read by Mr. Kahn. Mr. Tuttle's paper was published in the Electric Railway Review of May 9, page 571. Prof. E. P. Schoch of the University of Texas read a paper entitled "A Review of the Present Practice and Economics of Timber Preservation." This paper was published in last week's issue, page 568. This paper was received with great interest by the members present and discussed for fully an hour. H. S. Cooper, manager of the Galveston Electric Company, presented the report of the committee on standardization of the high T-rail. The report recommended that the secretary be instructed to address a letter to the American Street and Interurban Railway Association, stating the attitude of the association in behalf of a standard T-rail and suggesting that the national association secure from minor associations and the railroads statements in behalf of a standard rail. At the afternoon session the "Question Box" was further discussed and considerable time was devoted to a consideration of the automotoneer. The supply men then took charge of the meeting and Samuel Hobson, representing the supply men, took the chair yielded by President Edgar. The meeting then adjourned to the exhibit rooms to inspect the exhibits in a body.

### Saturday Session.

At the Saturday morning session a paper was read by C. W. Kellogg, Jr., on "Electric Illuminants and Their Efficiency." President Edgar then announced that Bernard V. Swenson, secretary and treasurer of the American Street and Interurban Railway Association, was present at the meeting. On being invited to address the convention, Mr. Swenson spoke of the work of the American association and urged the members of the Southwestern association to affiliate more closely with the national organization. He reviewed the work of the American association and the allied organizations and commended the Southwestern association on its ability to handle local matters in a way impossible for a general organization.

Invitations for the next meeting of the association were received from Houston, Beaumont, Amarillo, Ft. Worth, Yoakum and Dallas, Tex.

The committee appointed to act on the recommendations contained in the president's address submitted a report in the form of resolutions recommending that they be adopted by the association. The treasurer's report was read, showing that there was a balance in the treasury of \$887.86.

### Election of Officers.

The nominating committee then announced its recommendations for officers for the ensuing year, and the following were unanimously elected:

President, R. B. Stichter of the Dallas Securities Company, Dallas, Tex.

First vice-president, W. B. Tuttle, vice-president and general manager San Antonio Traction Company, San Antonio, Tex.

Second vice-president, W. B. Head.

Third vice-president, Joseph E. Carroll.

Secretary, J. A. Myler, Jr., Dallas, Tex.

Treasurer, A. E. Judge, president and general manager Tyler Electric Light & Power Company, Tyler, Tex.

Executive committee, H. T. Edgar, Ft. Worth; H. M. Moore, Austin; E. L. Wells, Taylor; F. M. Lege, Jr., Galveston; A. E. Judge, Tyler.

The entertainments, which were provided by the El Paso Electric Company, included a trolley ride through El Paso and Juarez, Mexico, for the visiting ladies on Thursday afternoon; a visit to the largest smelter in the United States in special cars on Thursday evening; a trolley ride and luncheon at the Country Club for visiting ladies on Friday afternoon; and a reception and band concert at Ft. Bliss on Saturday afternoon. On Friday evening there was a "Rejuvenation of the Sons of Jove."



R. B. Stichter, President-Elect.

## T-RAIL TRACK CONSTRUCTION.\*

BY MARK LOWD, SOUTHWESTERN MANAGER STONE & WEBSTER ENGINEERING CORPORATION.

T-rail construction is the type which the writer believes to be the best for the operating companies from the standpoint of first cost and economy of operation. In many cities the type of rail is designated by ordinance, unfortunately in most cases specifying grooved rail. These ordinances are largely the result of a lack of attention and inexperience on the part of the railway companies in the early days of electric traction.

As traffic grew the manufacturers gave us the girder rail of greater height and weight, in various forms, and the grooved rail, also of greater weight. It is probable that the first good results in paved streets were obtained by the use of the girder and grooved rails, and this is the principal reason that so many cities demand the use of such rails today.

With the increase in weight and height of the T-rail occasioned by the needs of the steam railroads for heavier rail to meet the requirements of high speed and greater weights, there came an opportunity to demonstrate that the T-rail could be used in any kind of a paved street with ex-

which in most cases is unnecessary, the needed height can be obtained by using a lighter section of high T-rail.

A 7-inch T-rail is recommended as giving the necessary height. The base of the rail can be well embedded in the concrete, thus increasing the rigidity of the rail and preventing to a great extent the loosening of spikes and other fastenings. Even with the use of a 90-pound standard section the necessary height to give the best results can hardly be obtained.

It is admitted that the standard section is mechanically stronger and has more metal in the head, with consequently a slightly longer life, but after considerable experience with many kinds of pavement the writer believes that the 7-inch T-rail meets every requirement.

In this connection attention is called to the fact that the use of the 7-inch T-rail was recommended by the committee on "Rails" at the 1907 convention of the American Street and Interurban Railway Association.

## Roadbed.

Both the "tie construction" and the "stringer construction" may be used with the concrete foundation, though the concrete stringer construction should not be used unless the

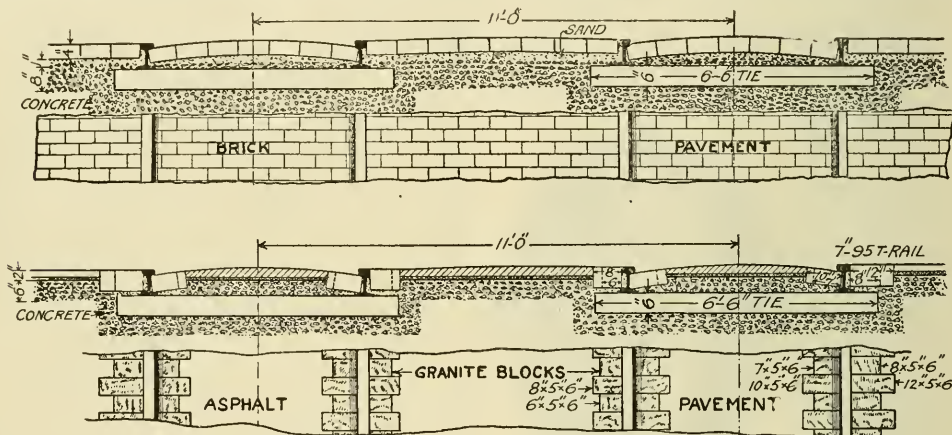

Cross Sections of T-Rail Track Construction in El Paso, Tex.

cellent results, both in regard to car operation and maintenance of roadway.

The T-rail has many advantages over either the girder or grooved types, and no disadvantages that are known to the writer. The T-rail is preferred for the following reasons:

- (1) It is designed on better mechanical lines; there is no eccentric loading as in the case of the grooved rail.
- (2) There is no excessive waste of metal when heavy traffic and large wheel flanges are to be considered. In many cities grooved rails weighing from 125 to 150 pounds per yard have been used, where an 80 or 90 pound T-rail would have been sufficient.
- (3) The flange way is always ready for an increase in the size of wheel flanges of the local cars, or for the interurban car with the large flanges necessary for high-speed work.
- (4) The T-rail is not so noisy.
- (5) Car wheel maintenance is less.
- (6) It has a longer life, particularly at the joint, which is the vital point of any rail.
- (7) It is more easily handled, and high-priced shop curves are unnecessary.

Considerable discussion has taken place on the question of the use of standard T-section instead of the high T or Shanghai sections.

The standard section has the advantage of lower cost, being some eight dollars a ton less than the high T, so that for the same money one can get a heavier rail by the use of the standard section.

But with any character of paving the height of the rail should be considered first, and unless an excessively heavy standard rail is used, say from 90 to 100 pounds per yard,

subgrade is well drained and of good hard sand or gravel. The "tie construction" is always reliable, and will be considered in this article, time and space preventing a discussion of the "stringer."

The subgrade should be well drained; this is very important, but in some places local conditions make it nearly impossible. The subgrade should be well tamped or rolled; tile and gravel drains connecting to sewers or other outlets should be used when necessary to improve drainage.

Ties should be of good sound timber, untreated if completely encased in concrete, spaced on 3-foot centers, using a "brace tieplate" on every third tie. This will do away with the use of the tie rod, which is objectionable where brick or stone paving is used.

Concrete should be made of one part of best quality Portland cement, four parts of clean sharp sand, and seven parts of clean gravel or crushed stone, and should be allowed to set at least seven days. If, on account of operating conditions, it is necessary to use the track sooner, and this condition is frequently met with, see that the track is solidly blocked up and that double the proportion of cement is used. Don't hurry operation over fresh concrete if it can be avoided. Many a track has been ruined by too early use.

The concrete should not be less than 6 inches in depth under the ties, and should extend around and above the ties, completely encasing them and the base of rail. Carry the concrete as high as the paving brick or block will permit, leaving half to three-quarters of an inch for cushion. A 2-inch cushion, commonly used, is unnecessary, and the space had better be occupied by concrete. Put the concrete in place as wet as it can be handled without losing the cement by washing away. It will flush better around the ties and rail and will produce the best results. Tamping concrete under the ties and rail is an uncertain problem, depending too much on the human element.

\*Abstract of paper read before Southwestern Electrical and Gas Association, El Paso, Tex., May 7, 8 and 9, 1908.

Rails should be 60 feet in length; these cost \$2.00 more per ton than the 30-foot length, but this is offset by the saving in number of joints and bonds. Even if the difference in price was much greater, the immense advantage of elimination of one-half the joints and bonds, which spell trouble with a big "T," fully warrants the increased cost of the 60-foot rail over the 30-foot rail.

The weight of rail should be governed by the traffic, and it is important to consider the team traffic as well as the car operation and weights. Heavy trucking will affect the condition of the rail to a great extent, and a heavier rail is necessary in streets where the team traffic is considerable than in a street where the car service and weights are the same, but where there is little teaming.

Of course, it is very difficult to determine what the future car operation or team travel may be in many cases, but as a general proposition, the experienced manager can judge what the travel is likely to be for many years to come. For residential streets, or other streets where light travel can be reasonably expected, a 70-pound 7-inch T-rail is suitable. In streets where travel of all classes is heavy, or likely to be in a short time, the 80-pound 7-inch T-rail should be used. Where extreme conditions of car and team traffic prevail, as in the business centers of large cities, it would be advisable to use a 95-pound 7-inch T-rail.

It must be remembered that the life of the rail is governed by the life of the joint. Likewise, the condition of the joint is responsible to a great extent for the condition of the bond. It is extremely difficult to maintain any kind of a bond at a loose joint.

The angle bar is not much better than the ancient fish-pate, and in every case a continuous joint should be used in preference to the angle bar, which is so much in evidence on had joints.

There are several types of soldered and compressed terminal bonds which may be used with good results, though local conditions must be considered in connection with the selection of bonds. Conditions of soil and climate have rendered the use of soldered bonds impracticable in a few instances. A concealed bond applied to the web of the rail, under the joint plate, gives general satisfaction, and is not easily stolen.

For any kind of traffic the "hardened center" special track work, which is made by several reliable concerns, is the best and most economical in the end. "Built up" or "home made" special work is only temporary construction at the best.

One-inch bolts of the best quality, and spikes  $\frac{3}{8}$  by 5 inches, also of good material, should be used with all weights of rail recommended.

#### Paving.

A good vitrified brick or paving block makes a most satisfactory form of pavement, especially in the south and southwestern country. If asphalt or bitulithic pavement is used, do not under any circumstances permit the asphalt or bitulithic to be laid against the rail. Use a brick or stone liner against the rail. This will not only permit the tightening of a joint bolt or the renewal of a bond without disturbing the adjoining pavement, but will also make a more durable job. The use of the special or "nosed" brick is unnecessary and rather unsatisfactory.

The regular brick laid as shown in the illustration of the cross section of T-rail track will give far better results. This construction has been used with great success in Milwaukee and other large cities. A rich cement grout makes the most satisfactory filler for brick or stone pavement.

The cost of track with this form of construction, the paving requirements being eight feet in width, will run from \$5.25 to \$6.75 per lineal foot of single track, varying with the cost of materials, weight of rail, wages and character of labor and local conditions on each job.

There are a few cities having a good sandy soil, where excellent results have been obtained in brick paved streets without the use of concrete foundation. This is very satisfactory in residential streets, but is not advisable in the important business thoroughfares.

The Maryland Electric Railways Company has begun the operation of electric trains on the Baltimore & Annapolis Short Line, a former steam road 27 miles long, from Baltimore to Annapolis, Md. Several electric trains are run daily between Annapolis and Cliffs, four miles out from Baltimore, but the line is not yet prepared to continue the electric service into Baltimore, and steam locomotives take the trains from Cliffs to the city terminus at Camden Station. Steam trains will be gradually superseded by electric trains until the entire service is conducted by electricity.

#### SOME QUESTIONS WITH ANSWERS BY PRACTICAL MEN.

We desire to compliment the Southwestern Electrical and Gas Association on the excellent "question box" which was presented at its El Paso convention. The question box with its answers comprised a book of nearly 200 pages, 5½ by 9 inches in size. The questions were well chosen, the answers were of practical value and the whole must have required a vast amount of work on the part of the "question box" editor, Samuel Kahn, resident engineer San Antonio Traction Company.

A number of the questions (with original numbering) and answers of timely interest to electric railway operators follow:

C-1. What effect does the injection of heated air over the fire have on smoke prevention or on fuel economy and what temperature must the injected air have in order to produce the best results?

Air is essential and best admitted through the grate bars to the furnace in innumerable fine jets, since gas and air mix only gradually. Air in bulk mixes only superficially with gas, and, by abstracting heat, cools the furnace. Gases to be thoroughly burned in the furnace must be intercepted at the start, else the combination, which is at best gradually, will not be completed in season. A proper amount of air entering the furnace above the fuel in small quantities assists somewhat in the combustion of the gases, but a great quantity is detrimental and injurious. I think if the fuel is not put in too thick a layer no necessity for such introduction of air is necessary. There are certain practical objections to heating the air supply for boiler furnaces. First, for every 480 degrees F. of added heat its bulk is enlarged by the amount of its original volume so that at 3,000 degrees, the heat of the interior of the furnace, it has six times its original volume. It is consequently, more unmanageable; and as its contained oxygen retains the same weight, its mixture with the gas becomes more difficult, while when mixed it can only do the same work as before. I think it would be much better to condense the air than to expand it. Next, if heated by passing through flame or over burning coal, the air will be robbed of a greater or less part of its vital oxygen. This is a positive loss.—J. B. Baltimore, Hillsboro.

Has a beneficial effect, and should have a temperature of not less than 2,400 degrees where coal is used. Will prevent smoke under proper conditions, but furnaces of this kind are rather expensive, and the same or better results can be obtained by other arrangements.—A. C. Stucky, San Antonio.

C-6. What is the saving in one of the modern waste cleaning machines?

I know of no more modern waste-cleaning machine other than the one I am using. I made it and never saw one like it, and will explain it to any one interested. My oil and waste cost for February, 1907, was \$13.15, and with this machine, for February, 1908, it was \$3.25, cost of lubricants and waste including engine and cylinder oil, which is ¼ mill per kilowatt or ½ cent per hour for 24-hour service.—E. D. Kelly, Hillsboro.

If the man in charge of the waste-cleaning machine operates it in a competent manner there should result a saving of 75 per cent in waste. The amount of oil that is obtained by wringing the waste, that can be filtered and reused, is considerable.—J. C. Marshall, Laredo.

You can save more of the oil contained in the waste by first pressing it. By using both press and machine should save three-fourths of waste bill, besides the oil saved.—E. L. White, Ft. Worth.

The saving due to the machine of the Oil & Waste Saving Machine Company should be about 30 per cent in oil and about 50 per cent in waste.—El Paso Electric Railway Company.

Have obtained 80 per cent with centrifugal machine.—J. R. Cox, Ft. Worth.

G-1. If the length and size of the top of a pole is decided upon what specifications further should be given to obtain a reasonably straight and round pole?

We specify that white cedar poles must conform to the specifications of the Northwestern Cedar-men's Association, as follows:

"Poles must be cut from live growing timber, peeled and reasonably well proportioned for their length. Tops must be reasonably sound and, when seasoned, must measure as follows: Five-inch poles, 15-inch circumference; 6-inch poles, 18½-inch circumference; 7-inch poles, 22-inch circumference; and 8-inch poles, 25-inch circumference at top end.

"On poles 4 inches, 16 and 15 feet long, a 1-way sweep of 4 inches and on poles 4 inches, 20 and 25 feet long, a 1-way sweep of 5 inches is allowable. On sizes 5 inches, 25 feet and upward, 1-way sweep, allowable not exceeding 1 inch for

every 5 feet; for example, in a 25-foot pole, sweep not to exceed 5 inches, and in a 40-foot pole, 8 inches; in longer lengths, 1 inch additional sweep permissible for each additional 5 feet in length. Measurement for sweep shall be taken as follows: That part of the pole when in the ground (6 feet) not being taken into account in arriving at sweep, tightly stretch a tape line on the side of the pole where the sweep is greatest, from a point 6 feet from butt to the upper surface at top, and having so done, measure widest point from tape to surface of pole, and, if, for illustration, upon a 25-foot pole said widest point does not exceed 5 inches, said pole comes within the meaning of these specifications. But rot in the center, including small ring rot outside of the center, total rot must not exceed 10 per cent of the area of the butt. But rot of a character which plainly seriously impairs the strength of the pole above ground is a defect. Wind twist is not a defect unless very unsightly and exaggerated. Rough knots, if sound and trimmed smooth, are not a defect."

Experienced users have realized that rot as found in cedar poles is an incident of growth and not of decay; the latter indicated by the fact that the rot does not spread after the tree has been cut and that, thereafter, cedar is the most durable timber procurable for pole purposes.—W. W. Reed, Houston.

N-1. Can the largest cities of Texas profitably build their own cars if these cars are double-truck, semi-convertible type of the latest model?

The largest city in Texas, San Antonio, has tried building its own cars and found it unprofitable. If lumber yard ash, oak and other lumber is used, cars will shrink and become loose, and to provide sheds and dry kilns to have your hardwood seasoned as it should be would be an expense and an outlay far in excess of a regular car builder's profit.—T. C. Brown, San Antonio.

I do not think so, as not enough building would be done to keep experienced help and pay interest on machinery investment.—V. W. Berry, Dallas.

N-18. What is the better practice to use, solid or split axle gears, and why?

Under ordinary conditions split axle gears are preferable. The chief argument in their favor being that they can be removed without disturbing the wheel. The new 4-bolt gear has proved more satisfactory than the old 8-bolt type.—W. L. Weston, Ft. Worth.

Solid, by all means, as they eliminate all possibilities of broken bolts in gearing and can be installed at less expense than split gears.—V. W. Berry, Dallas.

Solid gears, for the advantage over split gears in not getting loose on the axle, and I would recommend them for that reason.—G. H. Clifford, Ft. Worth.

Solid, first cost less. No bolt to get loose and get between gear and pinion and delay traffic.—M. Miers, Houston.

Solid gears are better, as they have no bolts to work loose.—El Paso Electric Railway Company.

N-23. What can be done to decrease the number of cars pulled in daily for equipment failures?

Have one or more car inspectors out on the road. The writer has had such a man for the past four months, and he has decreased the pull-ins two-thirds. This man has nothing to do with schedules and discipline except the abuse of equipment by motormen. This he reports to the superintendent of transportation. The saving of shedmen's wages by making such a change, to say nothing of the interruption of traffic, more than pays the inspector's wages.—T. C. Brown, San Antonio.

Frequent and thorough inspection has eliminated most of our pull-ins; trouble with signal bells are attended to as far as possible while the car is in service.—W. J. Jones, Austin.

More careful and rigid inspection, better education of trainmen and by keeping systematic records of causes of failures.—V. W. Berry, Dallas.

Careful and systematic inspection, with systematic records thereof, is the proper solution of this question.—El Paso Electric Railway Company.

Keeping equipment in good condition and by close inspection at night.—G. H. Clifford, Ft. Worth.

Special attention to brush holders and spacing of same.—M. Miers, Houston.

N-24. What are you doing in regard to adopting the standards as approved by the American Street and Interurban Railway Association?

We are standardizing our equipment as far as possible with the type of equipment we now have, using those parts supplied by the manufacturer of the equipment in preference to purchasing elsewhere.—W. J. Jones, Austin.

Recommending adopting the standards as far as possible on all new equipment.—V. W. Berry, Dallas.

O-23. Porcelain and glass break strains are much cheaper than wood and composition break strains. What arguments

are there in using a wood or composition break strain in a 600-volt trolley system?

Wood strain insulators possess the advantage that they are not easily broken. Have tested them wet up to 10,000 volts, using hydrant water. Leakage was very slight at 10,000 volts. Rain is generally pure, and pure water being a non-conductor, the properly filled hardwood strain insulator has a good field of usefulness.—J. R. Cox, Ft. Worth.

The advantage of a wood break strain is that in case of mechanical failure the break is plainly apparent, and no grounding of span or guy results through the device itself, which could happen with glass, porcelain or composition.—C. W. Davis, Dallas.

The newest form of porcelain break strains are the most satisfactory thing for this purpose.—El Paso Electric Railway Company.

Have been using glass strain insulators for four years and find them without an equal for this climate.—Flint McGregor, Houston.

P-6. To what extent should street inspectors look up accidents for the claim department?

Inspectors should not be permitted to do anything but inspect. If you require and have a claim department you should have sufficient force to tend to that department. However, when a serious accident occurs an inspector should go to the place of the accident at once to see that the schedule is maintained, and, of course, when there, if he can get the names of any witnesses that had not been procured by the conductor, he should do so, and caution the motorman not to talk. This is a caution that it seems has to be repeated over and over again.—T. C. Brown, San Antonio.

Inspectors should give every assistance to the claim department in looking up accidents, as this will put them in a position to judge for themselves whether or not the trainmen are at fault, and if the inspectors are educated along these lines it keeps them on the lookout for witnesses, and as they are with the crews the most of the time they can often get very valuable information if interested in this line of the work.—G. H. Clifford, Ft. Worth.

Street inspectors should give whatever information they may gather in connection with their regular duties to the claim department. We do not think it feasible for them to do anything further than this in the investigation of accidents.—Uriah Foss and R. T. Sullivan, Houston.

Think inspectors should get all the information possible in relation to an accident, which should be turned over to the claim department.—W. J. Jones, Austin.

R-29. What are the most forcible arguments that can be brought up before a city council for the repeal of a girder rail ordinance?

The opinion of city engineers and other similar officials is gradually getting, year by year, more favorable toward the T-rail in paved streets, and a thorough correspondence with city engineers all over the country will furnish a large amount of information on this subject. In El Paso the city council, after thoroughly trying grooved girder rail, have reached the conclusion that T-rail is preferable in paved streets and has officially approved this form of track construction.—El Paso Electric Railway Company.

#### DATES AHEAD.

Western Society of Engineers. Next meeting, Chicago, May 18.

National Electric Light Association. Annual meeting, Chicago, May 19, 20, 21 and 22.

Central Electric Traffic Association. Next meeting, Toledo, O., May 25.

Central Electric Railway Association. Next meeting, Toledo, O., May 26.

Oklahoma Electric Light, Railway and Gas Association. Annual meeting, Guthrie, Okla., May 25, 26 and 27.

New England Street Railway Club. Next meeting, Boston, Mass., May 28.

Canadian Electrical Association. Next meeting, Toronto, Ont., June 10, 11 and 12.

American Society of Mechanical Engineers. Spring meeting, Detroit, Mich., June 23, 24, 25 and 26.

American Institute of Electrical Engineers. Annual meeting, Atlantic City, N. J., June 29 to July 2.

Street Railway Association of the State of New York. Annual meeting, Niagara Falls, Ont., June 30 and July 1.

Michigan Electrical Association. Annual meeting, Grand Rapids, Mich., August 18 to 21.

**COST OF WIRING AND INSTALLING CONTROL APPARATUS ON THE METROPOLITAN ELEVATED.**

In December, 1906, the Metropolitan West Side Elevated Railway Company, Chicago, received 50 motor cars of a design which has now become standard. A year later 20 cars of this same type, built by the Pullman Company, were delivered. These have just been put into service. Through the courtesy of E. T. Munger, superintendent of motive power and equipment, we present a statement showing in detail the costs of material and labor required for installing Westinghouse electro-pneumatic control and general wiring on the last 20 cars. This statement follows:

	Material.	Labor.
Bending, placing and hanging conduit for trolley and control wiring .....		\$26.75
Installing control equipment .....	\$68.87	32.08
Installing trolley wiring on car bodies and trucks .....	18.71	2.90
<b>Total .....</b>	<b>\$87.58</b>	<b>\$61.73</b>
		\$7.58

Total cost per car.....\$149.31

These figures were taken direct from the books of the company's auditor. The cost of material and labor for installing the control and wiring on the 50 cars delivered in December, 1906, as compared with that for the 20 cars delivered in 1907 show that the later work was done at less expense. For the later work the cost of material increased \$2.44 per car, while labor decreased \$11.79 per car, leaving a net decrease in the cost of installing the control and wiring of \$9.35 per car.

The results of operating the first 50 cars during the past year have been so satisfactory that the wiring and electrical equipment on the 20 new cars has been installed in exactly the same way as on the earlier equipments. It is said that one of the principal reasons why this control wiring has been giving such satisfactory service is that all the parts are very rigidly attached to the framing. This security of attachment assures that there will be no vibration from which can result chafing or loosening of mechanical and electrical joints.

To illustrate the general arrangement of the control apparatus and conduits as installed in the Metropolitan shops we present the accompanying engraving reproduced from a line drawing. It will be noted that the conduits are carried through the steel framing wherever it is found necessary to make a workmanlike job. As a protection against fire the underframing, below which are the electrical conduits and all the apparatus except governors, is completely covered with sheet steel.

This standard type of motor car equipment was described and fully illustrated in the Electric Railway Review for February 9, 1907, page 180.

The length of the car body on the center line over end plates is 47 feet 7 3/4 inches; the distance between center of trucks is 33 feet 7 inches. The extreme width of the car over side sills is 8 feet 6 inches. The height of the car from top of rail to top of upper deck roof is 12 feet 10 inches, and the height of the car floor above top of rail (light) is 3 feet 10 inches. The cars seat 48 passengers.

In the construction of the underframe there are no center sills, and this assists materially in simplifying the arrangement of the auxiliary equipment under the car. The side sills are 9-inch I-beams weighing 21 pounds per foot and running the full length of the car. These are reinforced by 1 1/2-inch truss rods with 1 3/8-inch turnbuckles. The end sills are 9-inch channels weighing 25 pounds per foot. These extend to the outer edge of the side sills. The body bolster is a box beam built up of plates and angles; it is 12 1/2 inches wide and 9 inches deep. The beams which support the floor extend across between the side sills. They are 6-inch I-beams weighing 12 1/4 pounds per foot, with the exception of those nearest the bolster, which are 6-inch plate girders with 3-inch angle-iron flanges.

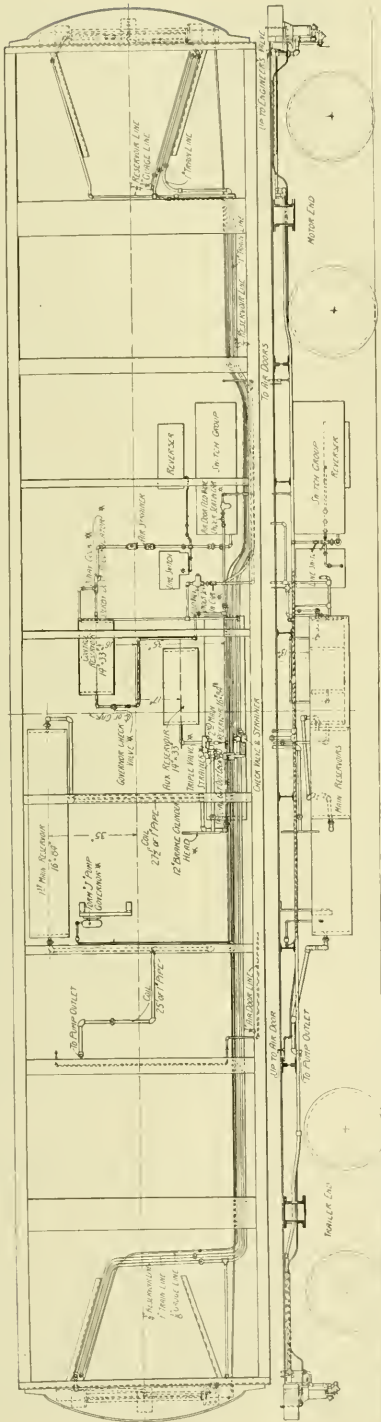

Plan and Elevation of Underframing for New Motor Cars of the Metropolitan West Side Elevated Railroad, Showing Arrangement of Apparatus and Conduits.

## RECENT ELECTRIC RAILWAY LEGAL DECISIONS.

BY J. L. ROSENBERGER, LL. B., OF THE CHICAGO BAR.

### When Several Passengers Signal to Stop Car.

Lanci v. Boston Elevated Railway Company, 83 Northeastern Reporter, 1.—The supreme judicial court of Massachusetts holds that if there were three persons who gave signals to stop a car at a certain street, of whom a certain passenger was the farthest from the conductor, the conductor could not be found guilty of negligence if he stopped the car on the signal of one of the others, without noticing her signal, and without knowing that she wished to alight.

### Passenger in Dispute as to Payment of Fare May Refuse to Allow Another to Pay it.

Birmingham Railway Light & Power Company v. Lee, 45 Southern Reporter, 164.—The supreme court of Alabama says that there was a dispute between the plaintiff and the conductor of a car as to whether she had paid 10 cents fare to a point to which she wished to go, or only 5 cents to an intermediate point. When it became evident that the conductor was going to eject her from the car a fellow passenger offered to pay her fare, when she told him not to do so, but the passenger paid it. The plaintiff had the right to refuse to allow this other person to pay her fare. Such payment by her consent would have been an acknowledgment that she had not paid it, and the conductor was entitled to it, and in such case she would have been in duty bound to refund it to this outsider.

### Car Running 150 Feet After Application of Brakes—Not Anticipating Negligent Operation of Car—More Cars at Moderate Speed Recommended.

Louisville & Southern Indiana Traction Company v. Short, 83 Northeastern Reporter, 265.—The appellate court of Indiana, division No. 2, holds that the fact that a car ran 150 feet after the brake was applied was relevant to the question of equipment, and tended to show that the brake or other equivalent apparatus was ineffective.

An adult is not necessarily negligent in failing to anticipate the negligent operation of a street car and the standard by which the conduct of a child is measured is not so high as that applied to the action of an adult.

Here a child crossing a track was struck by a car without a fender running at an excessive rate of speed, without apparent concern or precaution. It is extremely easy for companies operating street cars to avoid liability for damages on account of such occurrences as the one in question, and also to avoid killing either children or adults. They can do so by simply running cars at moderate speed, and keeping them under reasonable control. The necessity of rapid transit will be more completely served by moderate speed and a sufficient number of cars properly controlled than by fewer cars recklessly run.

### Woman Getting on Running Board or Step Does Not Justify Emergency Stop.

Sheppard v. New York City Railway Company, 107 New York Supplement, 553.—The supreme court of New York, appellate term, says that the testimony of the plaintiff was that as the car on which she was a passenger neared the street corner she arose and signaled the conductor to stop. The conductor gave one bell and the car slowed up. She then got down on the running board of the car, ready to alight, and while she was in that position the conductor gave three bells and the car stopped with a jerk, which loosened her hold and threw her to the street. The conductor was also called by the plaintiff, and gave the same account of the accident, except that he added that, after giving one bell, his attention was diverted from the plaintiff by a drunken person, and that, upon turning

back again, he saw her on the running board and "gave three bells to stop the car for fear she would step down." The trial resulted in a judgment for the plaintiff, from which this appeal was taken, based upon the refusal of a motion to dismiss the complaint upon the ground that the plaintiff's evidence showed that the conductor gave the three bells at a time when the plaintiff was in apparent danger, and for her protection, and that, even if he made a mistake in judgment, the defendant was not responsible therefor. But while the principle relied upon by the defendant was undoubtedly sound, the court does not think it applied to this case. There was no evidence that the plaintiff had extended her foot or made any preparation to alight, other than that she was on the running board. The only apparent danger to which she was exposed is present every time a woman gets upon the running board or step of a car ready to alight before the car comes to a complete stop. None of the cases called to the attention of the court has held that such a situation or any similar one calls for or justifies emergency action by a railway employe, and the court thinks that to say that this principle applied to the facts here would be to extend it to an unreasonable and dangerous length.

### Duty to Trespassers, Adult and Infant—Child Sitting on End of Crosstie—Requirements of Motorman.

Birmingham Railway Light & Power Company v. Jones, 45 Southern Reporter, 177.—The supreme court of Alabama says it is settled by that court that it is the common law duty of a motorman, running a street car in a populous town or city, to keep a lookout for persons rightfully on the track and liable to be run over by the cars.

But as a general proposition it must be conceded that a railroad company owes to a trespasser no duty to keep a lookout for him. It must also be conceded that this doctrine, according to the Alabama decisions and to the weight of authority elsewhere, applies with equal force to adults and infants, except in cases where infants are enticed upon the track.

In this case an infant only 16 months old crawled to a crosstie laid on the surface of the earth and was sitting on the end of it when she was struck by a passing car. On the facts of the case and the principles of law adverted to the court cannot escape the conclusion that the plaintiff was a trespasser on the road.

However, it will not do to lay down, as an invariable rule applicable to all cases, that a railroad company owes no duty to trespassers. Conduct which might, under one set of circumstances, show that all ordinary and reasonable care and diligence had been observed might, under a different set of circumstances, be insufficient to show an observance of such care and diligence. Such rule could mean no more than this: Taking the locality where the car is running, and all the attendant circumstances, if those in control of the movement of the car have no reason to apprehend that there may likely be a human being on the track in front of it, they are under no duty to one who in fact may be there, until they have actually discovered that he is there.

If, from the locality or attending circumstances known to the company, there is no reason to apprehend that the track in front of the car may not be clear of human beings, then it would seem it is the duty of the employes of the company to keep a lookout ahead of the car. This, it seems to the court, is a safe and conservative judicial principle—one which will conserve human life and at the same time place no burden on the company.

Whether the motorman was under any duty to keep a lookout for the plaintiff or not if he discovered the plaintiff's peril in time to prevent injuring her and he negligently failed to use the means or appliances at his command to prevent the injury, and the injury resulted from such failure, by all the authorities liability for the injury would be fixed on the defendant.

# News of the Week

## Accidents in Indiana.

The report of the Indiana railroad commission for January, February and March, 1908, shows that 71 persons were injured, 9 fatally, on the interurban lines of the state during the quarter. During the first quarter of the fiscal year 34 persons were injured, 8 fatally, and during the second quarter 70 were injured, 14 fatally. The accidents are classified as follows: Passengers, 57; travelers on highways, 5; travelers on foot, 3; employes, 6; trespassers, 3.

## Electric Railways in Michigan.

In the twenty-fifth annual report of the Michigan commissioner of labor for the year ended June 30, 1907, just issued, interesting and valuable data concerning the electric railways of the state are given. The report shows that there are at present 23 electric railway companies in the state, operating 1,253 miles of track. Of the total number six companies operate entirely inside of cities, four are entirely interurban, but have city connections, and 13 are both city and interurban. The amount of capital stock outstanding is \$38,031,000, an increase over 1904, the date of the last report, of \$3,956,000. During 1907 20 companies made improvements costing \$2,133,767. Six companies built new track amounting to 20 miles.

The total number of passengers carried was 222,788,795, the receipts from passenger service amounting to \$9,717,473.95. Fourteen lines reported receipts from freight traffic, the total amount received from this traffic being \$533,329.75. Nineteen lines reported receipts from other sources amounting to \$207,785.40, making the gross receipts \$10,458,589.10, an increase of \$3,548,378 over 1904.

The number of passenger cars operated on all lines was 1,803, an increase of 451, while the number of freight cars was 102. The total amount of wages paid was \$4,692,762.

## John B. McDonald on Subway Plans.

On Tuesday of this week Comptroller Metz of New York City made public a letter from John B. McDonald, the contractor for the present subway, criticizing in detail the plans of the public service commission for additional subways and especially for the Fourth avenue subway, for which bids have just been received. Mr. McDonald estimates the cost of the Broadway-Lexington route, construction and equipment, at \$127,000,000, and of the Fourth avenue route at \$44,000,000. He also says that the lines if built will not earn enough to pay interest on the cost of construction, and suggests the following extensions to the present subway system:

"For the east side, extension should be made from Forty-second street via Lexington avenue, Southern boulevard, Westchester avenue to Pelham Bay park. This will give a through line from Pelham Bay park to the Battery, with increased facilities at the Grand Central station. For the west side, extension should be made from Broadway and Forty-fifth street south through Seventh avenue, Greenwich street, West Broadway to a terminal under Battery park. This would complete a west side line from the Bronx to Battery park. This extension is of the greatest importance to the business interests of the city, especially in connection with the Pennsylvania terminal, which is approaching completion, and which is unequalled by anything of its kind in the world, and will handle more than 200,000 people a day, for whom transportation facilities must be provided in the very near future.

"Another feature of this extension is that by the construction of a short line through Canal street, connecting with the Brooklyn-Manhattan loop, now being built by the city, a direct line to the new Pennsylvania station will be given to the people of Brooklyn."

Mr. McDonald also criticizes the Fourth avenue line as running through a sparsely settled territory. He suggests that it be made a 2-track line instead of four tracks and that a 2-track subway be built on Bedford and Lafayette avenues to the Williamsburg bridge.

## Labor Troubles in Chicago.

A strike of the employes of the Chicago Railways Company has been threatened this week because of the refusal of the company to discharge 19 men who had resigned from the union and refused to pay their dues. The members of the union held a meeting on May 10 and decided by a vote of 4,303 to 59 to declare a strike if the delinquent members were not discharged. Eight of the latter have applied for an injunction restraining the company from discharging them and the union from conspiring to enforce their discharge.

The trouble which has led to the present crisis grows out of a long controversy between two factions of the union, the minority faction being composed of the 19 members who re-

signed in January because of dissatisfaction with the policy of the union. The men have been working for six years under a tacit "closed shop" agreement, which has heretofore been adhered to, and the company has always obliged members to pay their dues to the union. President J. M. Roach has offered to submit the present dispute to arbitration, but has declined to compel men to remain in the union against their wishes. Officers of the union refused the offer of arbitration and ordered a strike vote.

On Tuesday, May 12, eight of the former members of the union applied to Judge Carpenter for an injunction, stating that they had resigned because of dissatisfaction with the manner in which the funds of the union had been expended and that the union, by threatening a strike, was seeking to force their discharge. They claimed that \$1,200 had been expended in the last municipal campaign to defeat the traction ordinances against their wishes, and that although \$190,000 had been paid in dues and assessments, only about \$5,000 remained in the treasury. The court refused to issue the injunction on an ex parte hearing and upon application of attorneys for the union a hearing on the injunction was appointed for Friday morning.

W. D. Mahon, president of the Amalgamated Association of Street and Electric Railway Employes, arrived in Chicago on Wednesday and ordered the men not to take any action until after the injunction case is decided. On Wednesday trouble was threatened because a motorman refused to take out a car with a conductor who had been suspended from the union, but another conductor was substituted.

The employes of the Chicago Subway Company are on a strike for increased wages and the service has been interfered with to some extent. Several conflicts have occurred between pickets and strikebreakers. The company has refused to deal with the strikers and their places have been filled.

## Bids Received for Brooklyn Subway.

The New York public service commission of the first district received bids on May 8 for the construction of the Brooklyn Fourth avenue subway, extending from the Brooklyn terminal of the Manhattan bridge to Forty-third street.

In order to provide an opportunity for the city to make at least a beginning on the building of the road the commission divided the route into six sections and advertised for bids for the construction of each separately. After the commission has decided upon its awards a report showing the bids accepted by the commission will be sent to the board of estimate. That body will not have the power to change the awards, but the building of the subway cannot be begun until the board of estimate has appropriated the money. Bids were received for construction alone. Some arrangement for the operation of the subway will be made at a later date.

Thirty-four bids were received in all, from 15 contracting firms. William Bradley, one of the subcontractors for the Manhattan subway, bid on all six sections. The lowest bidders for the six sections were: James P. Graham, William Bradley, William Bradley, E. E. Smith Contracting Company, James P. Graham and Remington & Sherman Company and F. W. Carlin Construction Company, which submitted a joint bid. The total of the lowest bids is \$14,344,775 for the six sections. Westinghouse, Church, Kerr & Co. submitted a bid on the "master and servant" principle, proposing to build the subway on the basis of an agreed schedule of unit costs for materials and labor. The company also submitted a schedule of prices.

The plans call for the construction of a 4-track railroad, with pipe galleries, but the contractor will not be required to lay tracks, ties or ballast. The method of construction is to be excavation under cover, except at certain points specified.

There is considerable doubt as to whether the city can provide funds for undertaking the subway project this year. Comptroller Metz has stated that there is only \$2,000,000 available under the debt limit and that although this amount is expected to be increased by about \$40,000,000 by July 1, the city is already committed to many other needed improvements. The comptroller has received a letter from John B. McDonald saying that it will be impossible to secure bidders for the operation of the subway at a rental sufficient to pay interest on the cost of construction.

The public service commission appointed a hearing for May 15 on a proposal made by several civic associations of Staten Island, that the Fourth avenue subway be extended to Staten Island. The original plans as prepared by the old rapid transit commission provided for an extension to Ft. Hamilton, but according to the plans of the public service commission, on which bids have just been received the route ends at Forty-third street.

The public service commission has petitioned the appellate division of the supreme court asking for an order extending the time in which subway may be built in Manhattan

under the original position given to the old rapid transit commission for five years from October 15, 1908. The routes referred to are the Third avenue, Seventh and Eighth avenue, Lexington avenue, White Plains, Jerome avenue, Gerard avenue and the Thirty-fourth and Fourteenth street routes.

#### Street Railway Affairs in Cleveland.

The Municipal Traction Company, which has been operating the street railway lines of Cleveland since April 27, is meeting with all sorts of difficulties, and storms of protest have been aroused by its methods of operation.

On May 6 Judge Babcock granted the injunction applied for by the village of East Cleveland restraining the Municipal Traction Company from charging more than a 3-cent fare to the suburb, on the ground that the franchise specified that the fare should be the same as on the Euclid avenue line. The company retaliated by increasing the headway of the cars from 4 minutes to 10 minutes, and on May 7 the village council passed an ordinance requiring an 8-minute headway during the day and a 4-minute headway during rush hours. The fare on the other suburban lines was not reduced. The village of Lakewood has also protested against the service given by the company and has threatened to take steps to forfeit the franchise.

The new transfers were put into effect on Saturday, May 9. A charge of one cent was made for each transfer, and as two cents additional is charged for a ride to a point outside the city many of the suburban residents were obliged to pay six cents. After the transfer system was put in operation it was found that it was not complete and it was necessary to use old Cleveland Electric transfers in the emergency. President du Pont says that in 90 days free transfers will be issued. Mayor Johnson has announced that the average receipts of the company are \$13,000 a day and that 7 per cent of the passengers purchased transfers on Saturday. The company has abandoned service on several short lines which were declared unprofitable and has changed the routing of cars in many cases.

At the city council meeting on Monday six resolutions were presented protesting against the changing of routes, the abandonment of service on some lines and the curtailment of transfer privileges. It was decided to hold a public meeting of the street railway committee on Wednesday to receive complaints in regard to the service. Mayor Johnson agreed to be present.

The company proposes to build a more direct line on Euclid avenue, and on May 11 men were employed to secure consents of property owners for a line from East Twenty-second to East Fortieth street.

Officials of the Municipal Traction Company and representatives of the car men's union, who have threatened a strike unless their demand for an increase of wages was granted, signed articles of arbitration on Tuesday of this week. E. S. Meyer was selected to represent the car men and S. H. Tolles was chosen to represent the company. The arbitrators are to settle all points of difference between the company and its employes, the chief of which is as to whether the agreement of the Cleveland Electric Railway to give an increase of two cents per hour in the event of a renewal of its franchises is binding on the Municipal Traction Company. Other points to be settled are the status of the agreement between the Municipal company and its old employes and the right of the union's international organization to revoke the charter of the old Forest City union. In case the two arbitrators fail to agree within three days after the testimony has been heard they may select a third or they may extend the time, and their decision is to be final.

**Western Society of Engineers.**—An extra meeting of the Western Society of Engineers will be held in the society's rooms in the Monadnock block, Chicago, on May 18. Dr. P. H. Dudley of the New York Central will present an illustrated paper on "Steel Rails for Present Service: Their Manufacture and Their Failures."

**Conference on Operating Rules in Michigan.**—The Michigan railroad commission has decided to call a meeting of officials of the interurban railroads of the state at Lansing some time within the next two weeks to discuss a uniform system of dispatching. The occasion for the conference lies in the dissatisfaction of the commissioners, who have been investigating the recent accident on the Detroit United Railway, with the verbal system of train orders used by that company, and in the desire to establish a system of written orders.

**New York Subway Trains Delayed by Short-Circuit.**—Traffic in the Brooklyn extension of the New York subway was seriously interfered with during the rush hours on May 7 by an accident to the signal system. Rain water leaking into the Willow street wire shaft caused a short-circuit in the alternating-current system controlling the signals and at 5:15 p. m. every signal from the Brooklyn Bridge station to Atlantic av-

enue stopped working. All the signals were set at danger and the automatic trippers were set up so that all trains had to move slowly. The conductors were obliged to hold down each tripper until the trains had passed. From 5:20 to 7:42 the trains were kept running in this manner on both tracks, although irregularly, until the short-circuit was discovered and removed. The direct-current power in the third rail was at no time interfered with.

**Agree on Track Elevation in Chicago.**—President Knight of the Chicago & Oak Park Elevated Railroad, Chicago, has reached an agreement with the track elevation committee of the city council in regard to the proposed ordinance providing for the elevation of the company's tracks from Fifty-second avenue west to the city limits. The committee had been considering a mandatory ordinance. Mr. Knight said that his road was chartered under the railroad laws of Illinois, that the city had no power to compel it to elevate its tracks, and that it would not consider elevation under a mandatory ordinance. He agreed, however, to accept a contract ordinance under the condition that the city should grant a 14-year extension of the Market street franchise, so as to make that franchise expire at the same time as the company's other franchises. It was finally decided that the city track elevation superintendent should draft an ordinance to be submitted to the company.

**Strike Situation in Chester.**—City officials of Chester, Pa., appeared before the Pennsylvania railroad commission on May 5 to complain against the service given by the Chester Traction Company since the strike was declared several weeks ago. The city solicitor filed a formal statement saying that the company is not fulfilling its franchise requirements as to service and that in operating its cars with non-union men it is employing incompetent and inexperienced motormen and conductors. The subject was fully discussed at a hearing on the following day, but the commission reserved its decision until a further hearing could be held. Members of the commission said that it was questionable whether the power of the commission should be invoked to settle difficulties involved in a strike. On May 5 an attempt was made by strikers or sympathizers to blow up a car with dynamite. The explosive was placed on the track at Ninth street and Morton avenue in Chester. Several windows were broken and a portion of the car flooring was torn up. There were no passengers in the car and the motorman and conductor escaped injury.

**Conference on Chicago Elevated Loop.**—Representatives of the four elevated railroads of Chicago held a conference with the city council committee on local transportation on May 7 to discuss the report of Engineer George Weston on means for relieving the congestion of the Union loop. Mr. Weston's report, which was abstracted in the Electric Railway Review of May 2, page 539, recommended, among other changes, the through routing of the South Side Elevated and the Northwestern Elevated cars and the introduction of universal transfers between the four companies. The Northwestern Elevated Railroad and the Chicago & Oak Park Elevated were in favor of the changes mentioned, but the other two roads were unwilling to adopt them unless concessions were granted by the city. It was finally agreed to have the engineers of the four roads meet with Mr. Weston and discuss the subject. On Tuesday of this week a meeting was held in Mr. Weston's office, but with no definite result. It was decided to await a conference with a representative of Ford, Bacon & Davis, who made a report on the same subject for the Northwestern during the winter.

**Wage Arbitration in Pittsburg.**—The committee appointed to arbitrate the controversy between the Pittsburg Railways Company and its employes on the subject of the wage scale to be put into effect for the ensuing year held a hearing on May 8, at which representatives of the union and of the company submitted arguments. It was announced that no decision would probably be reached until next week. In the meantime the company has agreed to suspend its proposed reduction of one cent per hour, which was originally intended to go into effect on May 1, until a decision is reached. The finding of the committee is to be binding. Clarence Burleigh, attorney for the company, stated that owing to the prevailing business depression the company's receipts had been decreased to such an extent that it was necessary to rearrange the wage schedule on a lower basis. He presented figures showing that in only one year in the last 10 had the company earned a profit; that the yearly deficit amounted to from \$25,000 to \$100,000 a year, and since 1902 had aggregated \$451,000. William D. Mahon, international president of the Amalgamated association, and W. J. Brennan, attorney for the local union, argued that the company's business was non-competitive, that its basic source of revenue, a 5-cent fare, remained the same, and that if fewer passengers were carried fewer cars were run.



# Traffic and Transportation

## Fare Increase is Disapproved.

The Massachusetts railroad commission has rendered a decision on a complaint regarding an increase in fares by the Connecticut Valley Street Railway of Greenfield, Mass. An abstract of the decision follows:

"The railway directors voted to make certain changes in fares, which would increase the number of fare collections on the Millers Falls division from two to three, effective on April 1, 1908, and at the same time petitioned the board to approve the withdrawal of a free transfer at Lake Pleasant, a junction point, on the ground that no further occasion will exist therefor. If the additional fare is found to be reasonable, and the withdrawal of the free transfer is approved, the fare from Montague village to Turners Falls, substantially seven miles, will be 15 cents, and the fare from Millers Falls to Turners Falls, a lake distance, will be the same sum.

"The railway serves a substantial area in the Connecticut valley and exclusively affords a main route of street railway transportation from a prosperous city through and into several thriving towns. While the company as a whole has not in its short existence as a consolidated system earned dividends satisfactory to its stockholders, it is yet true that the theory of consolidation is predicated upon the ability of the company through saving in operation to ultimately realize satisfactory financial returns, and eventually justify the expectations and prove the judgment of those persons who have put their money into the enterprise. Whatever the future may disclose relative to the earning ability of the company, the board at this time is unwilling, under all the circumstances of the case, to approve the selection of a single division of this recently consolidated system, and by a substantial advance increase the fare thereon to the rate now established by the directors. It may be that experience will demonstrate the failure of this company to realize an adequate return upon investment, but we prefer a demonstration by experience as a criterion upon which to base our official action.

"In view of the whole situation, giving due regard to the enterprise as a whole, its history, geographical location and financial condition, and applying the principles that should obtain in ascertaining the reasonableness of a passenger rate, the board is unable to adjudicate the fare a reasonable one. We are confirmed in this decision by our inability to find anything in the way of comparative rates for like service under like conditions upon this road or elsewhere in Massachusetts to justify the company in charging 15 cents for a ride over a part only of its system in the township, thus creating a 20-cent fare within the town limits. Upon these facts, therefore, there can be but one conclusion, and that is that the charge of which complaint is made is unreasonable and excessive. We recommend a reduction. In view of this recommendation we must at the same time withhold our approval of the petition of the company for withdrawal of the free transfer at Lake Pleasant."

**Express Service Planned.**—Officials of the Lehigh Valley Transit Company, Allentown, Pa., have under consideration the establishment of express service between Philadelphia and Allentown.

**Effect of 2-Cent Steam Railway Fares.**—M. E. McCaskey, second vice-president of the Mahoning & Shenango Railway & Light Company, Youngstown, O., states that the adoption of 2-cents-per-mile fares by steam railways will not affect, in his opinion electric railway traffic. He believes that the decrease in steam railway fares to two cents per mile will not cause any reduction or increase in the fares on interurban electric roads.

**Testimony in Atlanta (Ga.) Fare Case.**—In the hearing before the Georgia railroad commission regarding the complaint concerning city and suburban fares of the Georgia Railway & Electric Company, Atlanta, Ga., an inventory and appraisal of the physical property and franchises constituting the assets of the company devoted to the railway service were presented. Figures were given of gross earnings, operating expenses and taxes, showing allowances for depreciation and contingencies. The company made an exhibit of the service furnished, showing the class of equipment, physical condition of the property and the reduction of average rate of fare by extension of lines and development of transfer privileges, etc. The company also had a written statement from the leading citizens of the community testifying that the service was good, the fares reasonable to the public and the public generally satisfied, and suggesting that no reduction in fares be made.

# Construction News

## FRANCHISES.

**Bellefontaine, O.**—The Ohio Electric Railway Company has received from the city of Bellefontaine a 25-year renewal of its original franchise and an outlet for its Lima & Toledo line, which has been completed to within three miles of Bellefontaine. The city has dismissed the suits which it brought against the company and the company has paid \$4,300 on a disputed paving assessment, donated ground to the city for a street and entered into an agreement to improve another street by widening it. These adjustments now settle the differences formerly existing between the city and the company and it is expected that the line will be in operation from Bellefontaine to Lima within six weeks, thus completing the Schoepf syndicate's "river-to-the-lake" line.

**Kimmick & Northern Railway, St. Louis, Mo.**—This company has applied for a franchise to build a single or double track line through various streets and alleys in the southwestern part of St. Louis with a terminus at Ivory avenue and Broadway, and for the construction of a bridge across the River des Peres.

**Monroe, Mich.**—Attorney Willis Baldwin has notified the city council that the Toledo Ottawa Beach & Northern Railway Company will apply for a franchise to operate its interurban line through Monroe. It is stated that the line will be extended from Toledo Beach to Wyandotte, a suburb of Detroit. L. E. Beilstein, general manager, Toledo, O.

**Redlands, Cal.**—The franchises which have been granted to the Redlands and Yucaipe Electric Railroad Company during the past year have been extended as follows: Thirty days additional in which to expend the \$5,000 required for the first year's work on the State street, Citrus avenue, Reservoir street and the Yucaipe road; the rails and ties for this line have been ordered and are expected within 30 days; six months' extension in which to build from the western to the eastern city limits on Colton avenue and on Sixth street to connect with the State street line of the road; 60 days additional in which to commence the construction of the electric line to Crafton. This franchise was originally granted to C. C. Haskell, a San Bernardino attorney, who has assigned it to the Redlands & Yucaipe company, which will use a portion of the route for its line, the remainder being used for the line to Crafton. R. H. Dunn and C. S. Chesnut are the holders of the franchises.

**Spokane, Wash.**—Jay P. Graves, president of the Spokane & Inland Empire Railroad, has applied to the city council for a franchise for the construction of a line in Mendenhall avenue, the continuation of East Riverside, from Madella street and Olive avenue to Sprague avenue and Freya street, about two miles. This will give direct service to the Spokane interstate fair association grounds, four miles east of the heart of the business district.

**Stockton, Cal.**—The city council has granted a franchise to the Central California Traction Company for an extension of its line in Stockton.

**Terre Haute, Ind.**—The Grand Central Traction Company, Indianapolis, Ind., which has made application for a franchise to enter Terre Haute with its Bloomington-Terre Haute branch, has been required by the city council to deposit \$15,000 as a guarantee that the work would be started and completed within a reasonable time. The contract also must contain a clause stating that the company will not sell out.

## RECENT INCORPORATIONS.

**Alabama Railway & Electric Company.**—Incorporated in Alabama to build an electric railway through the counties of Calhoun, Clay, Tallapoosa, Chambers, Lee, Russell, Barbour, Dale and Houston, connecting Opelika and Eufala, Ala., a total distance of 55 miles. Capital stock, \$200,000. Judson C. Chapman, Atlanta, Ga., is vice-president and counsel. (Noted May 9.)

**Columbus Canton & Eastern Transit Company.**—Incorporated in Ohio to construct an electric railway through Canal Dover, Coshocton, New Philadelphia, Newcomerstown and Newark, O. Preliminary surveys have been made and construction will be started as soon as financial arrangements are completed. Headquarters, New Philadelphia, O. Capital stock, \$200,000. Incorporators: W. J. Wise, W. W. Snyder, Clyde J. Knisely, Frank J. G. Kuenzli, F. O. Richards, A. W. Reiser and E. S. Rhodes.

**Oklahoma City Belt Line Railroad.**—Incorporated in Oklahoma with a capital stock of \$250,000. W. W. Bierce, Oklahoma City, Okla., is one of the incorporators.

**San Angelo Power & Traction Company, San Angelo, Tex.**—Incorporated in Texas to build a street railway in San Angelo. Capital stock, \$50,000. Incorporators: T. M. Vaughan, J. A. Williams, W. D. Fuller and others.

**Twin Cities & Lake Superior Street Railway.**—Incorporated in Wisconsin to build an electric railway from Minneapolis and St. Paul, Minn., to Superior, Wis., 130 miles. The company originally was incorporated under the laws of the state of Maine for the construction of this line under the name of the Twin City & Lake Superior Railway. The Wisconsin articles provide for a road from Sunrise to Peet and from Foxboro to Superior. Capital stock, \$7,000,000. Incorporators: E. L. Peet, Gransburg, Wis.; G. B. Haugan, Duluth, Minn.; F. R. Duxberry, St. Paul, Minn.; E. Lewis, Storm Lake, Minn.; Edward Henry, Minneapolis. (Noted October 12, 1907.)

**Wood River East Alton & Bunker Hill Traction Company.**—Incorporated in Illinois to build an electric railway between Wood River, East Alton, Bethalto, Moro, Bunker Hill, Gillespie and Litchfield, Ill., about 60 miles. The overhead trolley system will be used and power for lighting and other purposes will be furnished to cities and towns along the route. It is planned to locate the power station and repair shops at Bethalto, Ill. Practically all the right of way and franchises through several towns have been secured. Capital stock, \$250,000. Incorporators: J. T. W. Rudisill, president; R. A. Mavey, vice-president; S. B. Knepper, secretary; R. M. Smith, treasurer; all of East St. Louis, Ill.

#### TRACK AND ROADWAY.

**Alabama Railway & Electric Company, Atlanta, Ga.**—Judson C. Chapman, vice-president and counsel, writes that this company proposes to build an electric railway from Lafayette to Eufaula, Ala., 80 miles, which will ultimately be extended to the coast of the gulf of Mexico. Surveys have been completed and grading has been completed from Lafayette to Opelika. A contract is to be let for grading between Opelika and Eufaula within 30 days. Grades and curves will be light, but several short bridges and trestles will be required. It is the purpose of the company to have at least 15 miles in operation this year. A. M. Buchanan of Opelika is president.

**Ashtabula (O.) Electric Street Railway.**—This company intends to construct its proposed road from Ashtabula to Ashtabula Harbor, 5½ miles, this year. The company proposes to use the overhead trolley system and to operate five cars. No contracts have been awarded. Officers: C. E. Wallin, president; E. P. Broden, vice-president; J. V. Paulson, secretary; O. Arvidson, treasurer; and C. F. Brotherton, general manager.

**Berkeley, Cal.**—Capitalists of this city are considering the advisability of organizing a company to build an electric car line through Cragmont up the Berkeley hills to the top of Grizzly peak, on a 6 per cent grade.

**Canadian Valley Railway, Mutual, Okla.**—This company, which proposes to build an electric railway from Mutual to Oklahoma City, Okla., 150 miles, is reported to have elected Thomas H. Martin, president, and E. O. McCance, secretary. (Noted April 18.)

**Chicago & Milwaukee Electric Railroad, Highwood, Ill.**—Tracklaying has been started on the line in the city of Milwaukee from the Sixth street viaduct to the terminal at Wells and Second streets. The Columbia Construction Company of Milwaukee has the contract for the city portion of the work remaining to be completed. (Noted May 2.)

**Cincinnati, O.**—J. G. Schmidlapp, who is interested in a project to build an elevated railroad in Cincinnati, has announced that the line will be extended to Hamilton, O., a distance of 23 miles, via Norwood.

**Citizens' Light & Transit Company, Pine Bluff, Ark.**—This company is engaged in building a double track on West Sixth avenue from Main street to Cherry street, a distance of 10 blocks, replacing T-rails with 73-pound girder rails with a concrete foundation. F. E. Cherot, general manager.

**Cleveland Brooklyn & Elyria Railway, Cleveland, O.**—At the annual meeting last week the following officers were elected: President, J. J. Breiting, Cleveland; vice-president, W. E. Brooks, Elyria; secretary, Harry Knisely, Jr., Cleveland; and treasurer, B. E. Oppman, Cleveland. The company proposes to build an electric railway from Cleveland to Elyria, Orrville and Zanesville. It is stated that construction will be started in about 60 days. (Noted April 4.)

**Hanover & McSherrystown Street Railway, Hanover, Pa.**—This company, which recently began construction work on its proposed line from McSherrystown, 5½ miles, has increased its capital stock from \$30,000 to \$200,000. R. B. McKinnon of York, Pa., is chief engineer. (Noted April 18.)

**Illinois Central Electric Railway, Canton, Ill.**—The electrified line from Canton to St. David, Ill., which has been operated heretofore with gasoline motor cars, was opened for traffic on May 10. The present line is six miles long. Several extensions are planned. (Noted April 25.)

**Juniata Valley Electric Street Railway, Huntingdon, Pa.**—This company has filed a notice of its intention to extend its line over various streets in Huntingdon. R. W. Jacobs, president.

**Kansas City Springfield & Southern Railway.**—C. C. McFann, general manager, writes that the report that grading had been started on the proposed line from Nevada to Springfield, Mo., is erroneous, and that probably no work will be done on the line this summer. (Noted May 2.)

**Kentucky & Ohio River Interurban Railway, Paducah, Ky.**—This company has awarded a contract to the Western Engineering & Construction Company of Minneapolis, Minn., for the construction of the proposed line from Paducah, Ky., to Cairo, Ill., 40 miles. John J. Freundlich is general manager. (Noted April 18.)

**Mankato (Minn.) Electric Traction Company.**—This company, which recently completed a 3-mile electric line in Mankato, Minn., has filed a trust deed for \$400,000 in favor of the Northwestern Trust Company of St. Paul to secure a bond issue to pay for the construction and equipment of the present line and for extensions. (Noted May 2.)

**Milner & North Side Railroad, Milner, Idaho.**—D. C. MacWatters, president, writes that grading is in progress from Gooding to Jerome, 26 miles, on the proposed line from Gooding to Milner, Idaho, 65 miles, via Hillsdale, Jerome and Wendell. Donald Grant & Co. have the contract for grading and tracklaying. Maximum grade, 1 per cent; maximum curvature, 0.8 degree. R. S. A. Bickel, chief engineer, and Fentress Hill, secretary. (Noted April 11.)

**Milwaukee (Wis.) Light Heat & Traction Company.**—Construction work on the extension from Oconomowoc to Watertown, Wis., is being rushed with the intention of opening the line by July 1. (Noted February 22.)

**Niagara St. Catharines & Toronto Railway, St. Catharines, Ont.**—The 5-mile extension from Fonthill to Welland, Ont., was opened for traffic on May 4.

**Northwestern Interurban Railway, Fargo, N. D.**—A. T. Russell, secretary, writes that this company proposes to build an electric railway from Fargo to Fargo Junction, Minn., about 40 miles, and to use the tracks of the Minneapolis St. Paul & Sault Ste. Marie Railway from Fargo Junction to Detroit, 3½ miles. Surveys have been completed and a contract has been let to White & McCoy for grading from Lake Center to Fargo Junction, nine miles. This section is expected to be in operation by August of this year and the remainder of the road is to be built next year. The first section will be operated by steam at first, but it is the intention to erect a power house later at Rollag, located near the center of the line. The officers are: President, C. N. Callander of Fargo; treasurer, E. H. Probstfield; secretary, A. T. Russell; chief engineer, D. L. Buckingham, Cormorant, Minn.

**Ohio Electric Railway, Cincinnati, O.**—W. Kesley Schoepf, president, is quoted as saying that the Lima-Bellefontaine line, 34 miles long, will be opened for traffic about June 15. (Noted April 18.)

**Ontario West Shore Electric Railway, Goderich, Ont.**—This company is making surveys for its proposed line between Goderich and Kincardine, Ont. V. M. Roberts, chief engineer. (Noted February 1.)

**Oregon Interurban Railway, Oregon, Mo.**—It is reported that surveys have been made for a line from Oregon to Forest City, Mo., five miles, but that the company is not yet ready to let contracts. Benjamin F. Morgan is president and George Custer of Marysville, Mo., is chief engineer.

**Portland, Ore.**—It is reported that a company has been organized to build an electric railway from Condon to Bend, Ore. H. I. Keeny, George C. Mason, Mark W. Gill and others of Portland and Seattle are interested.

**St. Louis, Mo.**—W. C. Dines of the Citizens' Investment Company, 510 Pine street, St. Louis, desires to secure the assistance of one or two railroad contractors in connection with the construction of an electric railroad in this vicinity.

**Salt Lake & Ogden Railway, Salt Lake City, Utah.**—Details in regard to the crossing of the Union Pacific tracks near Salt Lake City have been settled and work is being pushed on the line between Salt Lake City and Ogden with the intention of opening the line by June 1. Simon Bamberger, president. (Noted May 2.)

**Seattle Snohomish & Everett Railway, Seattle, Wash.**—C. M. Kimball writes that this company proposes to build an electric railway from Seattle to Everett, Wash., 30 miles, via Bothell and Snohomish. Right of way is now being secured for the section from Seattle to Everett and contracts are to be let soon. It has not yet been decided whether to build an independent line into the city of Seattle or to connect with the Seattle Electric Company's line. (Noted May 9.)

**Seattle (Wash.) Electric Company.**—Jacob Furth, president, recently stated to a committee representing the West Woodland Improvement Club which petitioned for an extension of the Fremont-Ballard line from Forty-fifth street to Sixty-fifth street that the company proposes to construct the line as soon as financial conditions permit.

**Snohomish Valley Railroad, Snohomish, Wash.**—It is reported that financial arrangements have been made for beginning construction immediately on the first 15 miles of the proposed line from Snohomish to Seattle and Tacoma, Wash. Edward Wright, president. (Noted September 7, 1907.)

**Sparta-Melrose Electric Railway & Power Company, Sparta, Wis.**—This company, which proposes to build an electric railway from Sparta to Melrose, Wis., 28 miles, has elected new officers as follows: President, Charles Newland; vice-president, James Cole; secretary, Howard Teasdale; treasurer, W. A. Sholes. The proposed route has been changed so as to make a more direct line by leaving out Trout Falls. Construction has been started. (Noted March 30, 1907.)

**Swallow Falls Electric Light & Power Company.**—It is reported that this company proposes to build an electric railway from Swallow Falls to Oakland, Md., about eight miles. H. P. Tasker of Oakland, Md., is interested.

**Taylorville (Ill.) Electric Railway.**—It is reported that sufficient stock has been subscribed by residents of Taylorville to insure the construction of the proposed street railway this summer. W. B. Adams is interested. (Noted May 2.)

**Toledo Ottawa Beach & Northern Railway, Toledo, O.**—It is reported that this line will be extended next year from Toledo Beach along the shore of Lake Erie to Wyandotte, a suburb of Detroit. The preliminary work of securing right of way and franchises is to be undertaken this year. L. E. Bellstein, general manager.

**Toronto & York Radial Railway, Toronto, Ont.**—This company expects to build an extension from Jackson's Point to Sutton, Ont., 1½ miles. James McDougall, chief engineer.

**Toronto (Ont.) Suburban Railway.**—Surveys are being made for an extension from Fairview avenue to Swansea. Ont. G. C. Royle of Toronto Junction is general manager.

**Troy Rensselaer & Pittsfield Street Railway, Pittsfield, Mass.**—A large force is now engaged in the construction of a line from Troy, N. Y., to Pittsfield, Mass. It is expected that the line will be in operation from Lebanon mountain to Pittsfield by August 1.

**Westchester & Wilmington Electric Railway, Westchester, Pa.**—This company, which recently awarded a contract to the Eastern Railway Construction Company for the construction of the line from Westchester, Pa., to Wilmington, Del., 16½ miles, has increased its capital stock from \$254,000 to \$500,000. Thomas E. O'Connell, president. (Noted May 9.)

**West Penn Railways, Connelville, Pa.**—This company is building an extension from New Salem Junction to Brownsville, Pa., which is to be opened by July 1. L. H. Conklyn, general superintendent.

**Wood River East Alton & Bunker Hill Traction Company.**—It is stated that W. H. Morgan of Edwardsville, Ill., will soon begin surveying the proposed line from Wood River in Madison county, Illinois, to Gillespie, in Montgomery county, Illinois.

**Yakima Intervalley Electric Railroad, North Yakima, Wash.**—T. A. Noble, engineer, has presented plans of the proposed line from North Yakima to Granger, Wash., to the county commissioners, who will appoint a hearing on the company's application for a franchise. The route includes Parker, Zillah and Sunnyside and as surveyed is about 38 miles long. (Noted February 15.)

## POWER HOUSES AND SUBSTATIONS.

**Birmingham (Ala.) Railway Light & Power Company.**—A new rotary converter substation for transforming current for the regulation of the lighting system at Ensley and Wylam, Ala., has recently been completed at Ensley.

**Interurban Railway & Terminal Company, Cincinnati, O.**—This company recently placed orders for the construction and equipment of a new substation to include two 250-kilowatt Allis-Chalmers rotary converters with transformers and switchboard complete.

**Portland Railway Light & Power Company, Portland, Ore.**—This company has installed an electric lighting system at Gresham, Ore., the power for which is furnished from the Cazadero plant of the company on the Clackamas river, about 25 miles south of Gresham.

**Cedar Rapids & Iowa Railway & Light Company, Cedar Rapids, Ia.**—It is reported that this company will increase the capacity of its power station by the installation of a 750-kilowatt motor-generator set for railway purposes. W. G. Dows, president and general manager, Cedar Rapids.

**Stroudsburg & Water Gap Street Railway, Stroudsburg, Pa.**—This company is planning to increase the capacity of its power house by the installation of a 250-horsepower slow-speed engine and a 100-horsepower boiler. H. E. Sweeney, vice-president and purchasing agent, Stroudsburg, Pa.

**Idaho Washington & Oregon Traction Company.**—Frank McKean, an engineer representing this company, which proposes to build an electric railway from Lewiston, Idaho, to Pomeroy and other points in Washington, has filed notice for a 12,000-horsepower water right along the line under the name of the North Coast Power Company. Work already has been started on the construction of a dam across the Clearwater river, about four miles north of Lewiston. (Noted May 2.)

**Northern Electric Company, Madison, Wis.**—At a recent meeting at Pueblo, Colo., A. B. Hullt, representing this company, submitted a proposition for the construction of a large power plant at Canyon City coal fields and an interurban electric line from Canyon City, Colo., by way of Pueblo to Dodge City, Kan., with a branch line from Garden City to Scott City, Kan. The company also proposes to establish pumping plants along the Arkansas river.

**York Haven (Pa.) Water Power Company.**—Work has been started by this company on a power house extension which will accommodate new generating units of 10,000 horsepower. It is stated that 10 generators, each to be driven by a pair of water wheels, have been ordered from the General Electric Company. It is expected that by the time of completing the additional installation it will be possible to extend the high-tension transmission system to Lancaster and other cities.

**Menominee & Marinette Light & Traction Company, Menominee, Mich.**—Announcement is made that this company has decided to purchase the controlling interest in the Grand Rapids water power, two miles east of Igalis, Mich., and will begin some time in June the construction of a large power house and dam, which will furnish light and power for the operation of its lines in Menominee and Marinette. The minimum capacity will be about 4,500 horsepower. The company recently has increased its capital stock to \$1,000,000, of which amount \$440,000 will be offered for sale to the residents of the two cities. Edward Daniell, general manager, Menominee, Mich.

A party of officials of the Texas Traction Company of Dallas, Tex., together with a large number of city officials and business men of Dallas, made an inspection trip over the new Dallas-Sherman line between Dallas and McKinney on April 23 in a train hauled by a steam locomotive.

Fifty members of the syndicate that financed the construction of the Washington Baltimore & Annapolis Electric Railway, Baltimore, Md., made a trip of inspection over the line on Tuesday of this week in a special train, accompanied by George T. Bishop, president, and J. N. Shannahan, general manager. The party included a large number of Cleveland capitalists.

Since the opening of the Brooklyn extension of the New York subway it is possible to ride from New Rochelle to the Flatbush avenue terminal of the Long Island Railroad, a distance of 23 miles, for eight cents, five cents on the surface line and three cents for a transfer to the Third avenue elevated road, from which a free transfer to the subway is given at One Hundred and Forty-ninth street.

## Personal Mention

Mr. C. F. Burns has resigned as a director of the United Traction Company and the Hudson Valley Railway Company, controlled by the Delaware & Hudson Company.

Mr. J. B. Rumsey, heretofore general manager of the Buffalo Southern Railway, Buffalo, N. Y., has resigned. He will be succeeded by Mr. J. J. Bangert of New York City.

Mr. B. E. Tilton has resigned as engineer of maintenance of way of the Cleveland Electric Railway, which is now operated under a lease by the Municipal Traction Company.

Mr. B. W. Mendenhall has been appointed commercial agent for the Utah Light & Railway Company of Salt Lake City, Utah, effective at once. Mr. Mendenhall formerly was manager of the Ely Light & Power Company at Ely, Nev.

Mr. G. S. Shinnick, chief clerk of the Ohio Electric Railway Company at Newark, O., has been transferred to Columbus, O., as chief assistant to Mr. W. A. Gibbs, manager of the Dayton and Zanesville lines of the company. Mr. Shinnick formerly was auditor of the Columbus Buckeye Lake & Newark Traction Company at Columbus.

Mr. Ivan Overholm, chief engineer of the electrification department of the Swedish government railways, is on a visit of inspection to this country in connection with the electrification of railways in the southern part of Sweden. He will visit a number of the most important heavy electric traction and single-phase roads while here, for the purpose of collecting data on this subject, which, on account of the high price and increasing scarcity of coal in his country, is occupying the attention of the railway engineers. He will return to Sweden the latter part of May.

Mr. H. H. Adams, heretofore superintendent of shops of the United Railways & Electric Company of Baltimore, Md., has been appointed to the position of superintendent of rolling stock and shops of the New York City Railway, with headquarters at 775 Seventh avenue, New York, effective on May 11. The superintendent of equipment and the master mechanic will report to the superintendent of rolling stock and shops, who will report to the general manager for the receivers, Mr. Oren Root. Mr. Adams is a graduate of Stevens Polytechnic Institute of the class of 1893. After graduation he became connected with the Consolidated Traction Company of New Jersey and for about six years was connected with the North Jersey Street Railway of Newark, N. J. On January 1, 1902,

he resigned as master mechanic of the North Jersey system to become superintendent of shops of the United Railways & Electric Company at Baltimore, which position he has held until his present appointment. Mr. Adams is well known to readers of the Electric Railway Review through his connection with the American Street and Interurban Railway Engineering Association, of which he was president for two years, from 1905 to 1907, and of which he is now a member of the "Standardization" committee. Mr. Adams is an associate member of the American Institute of Electrical Engineers, a member of the New York Railroad Club and an associate member of the American Street and Interurban Railway Association.

Mr. Harry R. Ivers, for the past year treasurer and assistant to the president of the Bangor Railway & Electric Company at Bangor, Me., has been appointed general manager of the Lewiston Augusta & Waterville Street Railway, Lewiston, Me., the latter road being a consolidation of all the electric lines in the middle and western part of Maine. Mr. Ivers will retain his position as assistant to the president, John R. Graham, who also is president of the consolidated company. He will be succeeded as treasurer of the Bangor Railway &

Electric Company by Mr. James W. Cartwright, Jr., formerly purchasing agent of the company. Mr. Walter L. Sawtelle, who has had in charge the soliciting of new business, will in addition take over the duties of purchasing agent, succeeding Mr. Cartwright.

Mr. Henry A. Haigh, who has been elected president of the Cincinnati Georgetown & Portsmouth Railroad, Cincinnati, O., to succeed the late A. W. Comstock, was born in Dearborn, Mich., in 1854. He was educated in the public schools and in 1874 and 1878, respectively, received degrees from the Michigan Agricultural College and from Michigan University. He was admitted to the bar in 1878 and practiced law in Detroit for a number of years. In 1899 he became interested in various industrial and transportation enterprises, being one of the organizers and builders of the Toledo Fremont & Norwalk Railroad, now a part of the Lake Shore Electric Railway system. He also built the Rochester & Eastern Rapid Railway of Rochester, N. Y. He was formerly vice-president



Henry A. Haigh.

of the Detroit Ypsilanti Ann Arbor & Jackson Railway (now the Detroit Jackson & Chicago), owned by the Detroit United system, and is treasurer and one of the builders and owners of the Milwaukee Northern Railway, Sheboygan, Wis., which will comprise a total of 121 miles when completed. Thirty miles of this road are now in operation, with an extension under construction from Port Washington to Sheboygan. Mr. Haigh also is president and treasurer of the Comstock-Haigh-Walker Company, railway engineers and constructors, and is connected with various organizations, including banks, newspapers, etc. His election as president of the Cincinnati Georgetown & Portsmouth Railroad also includes the presidency of the Felicity & Bethel Railroad, which is a branch of the former road, although having an independent organization.

Mr. Thomas F. Mullaney, who for the past 20 years has been connected with the engineering department of the General Electric Company, has resigned to become chief engineer of the Third Avenue Railroad of New York City. On the evening of May 6 a few friends and business associates of Mr. Mullaney gave a dinner at the Engineers' Club in New York, at which Mr. Mullaney was the guest of honor. The guests included a large number of prominent officials of the General Electric Company and of the New York electric roads. In the course of a speech as toastmaster, Mr. William J. Clark of the General Electric Company, presented Mr. Mullaney with a handsome watch, chain and charm, a gift from his old associates in the General Electric Company as a token of esteem and recognition of past efficient service. Mr. Mullaney has had in charge the installation of electrical machinery for some of the largest plants in the country for the Thomson-Houston Company and the General Electric Company and in earlier years was identified with the construction and operation of the underground conduit system during the period of that important phase of electrical and railway development. For several years past Mr. Mullaney's work has been confined to New York City, where he has had charge of many large installations of electrical machinery for the General Electric Company.

### OBITUARY.

Joseph Brower, who was identified in an official capacity with the Fifth and Sixth Street railway lines in Philadelphia during the early days of their construction and operation, died recently in Mississippi City, Miss., aged 82 years.

Hosmer Buckingham Parsons, formerly president of the Wells, Fargo & Co.'s bank, New York City, a director of the Knickerbocker Trust Company of New York, a director of the Augusta-Aiken Electric Railway and the North Augusta Electric Improvement Company, Augusta, Ga., and interested in other large financial corporations, is dead.

# Financial News

**Anderson (S. C.) Traction Company.**—Judge Pritchard of the United States circuit court at Asheville, N. C., has turned over to Robert E. Ligon, Edwin W. Robertson and Frank R. Frost, as receivers, the property of the Anderson Traction Company. This action was taken on complaint of the International Trust Company of Baltimore, Md., and supersedes the previous action whereby the property was placed in the hands of Mr. Robertson and Mr. Ligon as receivers on application of the Anderson Machine & Foundry Company.

**Berkshire (Mass.) Street Railway.**—Application has been made to the Massachusetts railroad commission for approval of an increase in the capital stock from \$1,648,100 to \$1,933,100. The proceeds will provide for floating debt and additions to property.

**Chicago Railways Company.**—The Merchants' Loan & Trust Company and the Union Trust Company of Chicago have purchased \$1,200,000 of 5-year 6 per cent collateral trust notes dated February 1, 1908, and secured by deposit of \$1,666,000 series A bonds.

**Chicago Union Traction Company.**—The cost of the receivership, excluding the reorganization expenses and the fees of attorneys employed in connection therewith, was, as shown by reports of the receivers filed in the United States circuit court at Chicago, as follows: Trust companies and special attorneys of trust companies (including \$79,326.58 allowed certain New York financial interests in November, 1904), \$312,826.58; receivers' services (remuneration by decree of court, exclusive of special remuneration allowed by directors and stockholders), \$295,770.48; assessment of stockholders for legal services and expenditures in the protection of their rights, \$905,078; remuneration allowed by court for special legal services in connection with the receivership, \$365,924.41; total, \$1,879,599.47.

**Concord Maynard & Hudson Street Railway, Maynard, Mass.**—Application has been made to the Massachusetts railroad commission for approval of an issue of \$25,000 of 20-year 5 per cent bonds. The issue of these bonds would make a total of \$200,000 bonds outstanding.

**Danbury & Bethel Street Railway, Danbury, Conn.**—An issue of \$75,000 of 6 per cent debenture bonds, dated March 1, 1908, and due March 1, 1918, has been made. The bonds are redeemable at 105 after due notice on any interest date. The proceeds will provide for additions to the power house, for other permanent improvements and for retirement of the floating debt. The bonds are offered at par and interest by Clarence E. Thompson & Sons of New Haven and Bridgeport, Conn. No additional mortgage may be placed on the property without provision for these debentures.

**Fulton Ferry Railway, New York.**—Notice has been given by the Guaranty Trust Company of New York as trustee under the deed securing the first mortgage bonds dated November

1, 1895, that the receivers for the Metropolitan Street Railway, who are operating the ferry property under a trackage agreement, have announced that they are about to disaffirm the contract and give up the operation of the road. Bondholders are, therefore, requested to send information to the trust company regarding their holdings.

**Interborough-Metropolitan Company, New York, N. Y.**—The application of Attorney-General Jackson to bring suit in the name of New York state to forfeit the charter of the company has been denied by the appellate division of the supreme court, first department.

**Maryland Electric Railways Company, Baltimore, Md.**—The Fidelity Trust Company of Baltimore has purchased the remaining \$250,000 of the \$1,000,000 of first mortgage 5 per cent bonds of the Baltimore & Annapolis Short Line. The proceeds will be used in constructing a terminal station at Annapolis and for other purposes.

**New York New Haven & Hartford Railroad.**—The Massachusetts supreme court has rendered a decision that the New York New Haven & Hartford Railroad has transgressed the law in securing control of five street railroads in Massachusetts. Acquisition of control of the Springfield Street Railway was held not to be in violation of the law. Attorney-General Malone of Massachusetts maintained that the New Haven road, either directly or indirectly, and contrary to law, owns and controls the Worcester & Webster Street Railway, the Webster & Dudley Street Railway, the Springfield Street Railway, the Berkshire Street Railway, the Worcester & Southbridge Street Railway and the Blackstone Valley Street Railway. The court says that the New Haven road, through the purchase and ownership of the street railway corporations named, by its creature, the Consolidated Railway Company, transgressed the law as to all the street railway companies mentioned in the information except the Springfield Street Railway, and that it is still transgressing in the same way as to the Worcester & Webster and the Webster & Dudley companies.

**Philadelphia Company, Pittsburg, Pa.**—W. B. Carson, the secretary, and Russell H. Beggs of Pittsburg and Sidney H. March of New York have been elected directors.—The combined income account for the year ended March 31, 1908, of the Philadelphia Company and affiliated operating companies, not including the Allegheny Heating Company, is as follows: Gross earnings, \$18,767,441.46; operating expenses and taxes, \$9,698,315.48; net earnings, \$9,069,125.98; other income, \$226,554.15; total income, \$9,295,689.13; deductions from income, \$1,325,271.64; net income before deducting fixed charges, improvements, betterments, extensions, etc., \$7,970,408.49; fixed charges (interest on funded debt), \$3,311,625.72; net income, \$4,658,782.77; improvements, betterments, extensions and extraordinary maintenance expenses, \$1,697,328.16; notes issued April 1, 1905, for extension of pipe lines, retired during the year, \$375,000; car trust notes issued December 1, 1905, retired during the year, \$40,000; total, \$2,112,328.16; surplus, \$2,546,454.61; dividends on preferred stocks, \$383,201; surplus, \$2,163,253.61.

## ELECTRIC RAILWAY EARNINGS.

	Gross earnings.	Operating expenses.	Net earnings.	Total charges.	Surplus.
El Paso (Tex.) Electric Company, February, 1908.....	\$ 43,862.74	\$ 30,987.71	\$ 12,875.03	\$ 5,842.21	\$ 7,032.82
El Paso (Tex.) Electric Company, February, 1907.....	36,558.96	29,967.34	6,591.62	4,564.30	2,027.32
El Paso (Tex.) Electric Co., March 1, 1907, to Feb. 29, 1908..	523,756.51	384,122.36	139,634.15	63,059.99	76,574.16
El Paso (Tex.) Electric Co., March 1, 1906, to Feb. 28, 1907..	410,114.10	296,782.42	113,331.68	48,740.78	64,590.90
Pensacola (Fla.) Electric Company, February, 1908.....	15,377.72	14,476.81	900.91	3,586.70	*2,685.79
Pensacola (Fla.) Electric Company, February, 1907.....	17,369.08	11,879.14	5,489.94	3,125.00	2,364.94
Pensacola (Fla.) Electric Co., March 1, 1907, to Feb. 29, 1908..	227,006.16	155,658.89	71,347.27	41,845.84	29,501.43
Tampa (Fla.) Electric Company, February, 1908.....	48,567.81	31,784.11	16,783.70	964.49	15,819.21
Tampa (Fla.) Electric Company, February, 1907.....	38,692.66	29,375.11	9,317.55	994.45	8,323.10
Tampa (Fla.) Electric Co., March 1, 1907, to February 29, 1908..	532,355.46	390,360.42	141,995.04	6,515.66	135,479.38
Tampa (Fla.) Electric Co., March 1, 1906, to February 28, 1907..	478,196.39	300,754.39	177,442.00	3,377.92	174,064.08
Houghton County St. Railway, Hancock, Mich., February, 1908..	17,335.83	13,885.69	3,450.14	3,916.72	*466.58
Houghton County St. Railway, Hancock, Mich., February, 1907..	15,205.19	12,243.15	1,962.04	3,876.81	*1,914.77
Houghton County Street Railway, Hancock, Mich., March 1, 1907, to February 29, 1908.....	254,782.80	154,400.99	100,381.81	47,510.71	52,871.10
Houghton County Street Railway, Hancock, Mich., March 1, 1906, to February 28, 1907.....	231,886.10	149,113.23	82,772.87	47,089.43	35,683.44
Columbus (Ga.) Electric Company, February, 1908.....	28,844.19	14,062.60	14,781.59	10,727.31	4,054.28
Columbus (Ga.) Electric Company, February, 1907.....	25,619.84	12,793.84	12,826.00	10,457.43	2,368.57
Columbus (Ga.) Electric Co., March 1, 1907, to Feb. 29, 1908..	347,576.91	187,200.09	160,376.82	123,887.94	36,488.88
Jacksonville (Fla.) Electric Company, February, 1908.....	31,377.85	23,281.80	8,096.05	5,598.96	2,497.99
Jacksonville (Fla.) Electric Company, February, 1907.....	30,006.04	20,188.69	9,817.35	3,475.00	6,342.35
Jacksonville (Fla.) Electric Company, March 1, 1907, to February 29, 1908.....	394,898.39	261,377.10	133,521.29	54,240.21	79,281.08
Jacksonville (Fla.) Electric Company, March 1, 1906, to February 28, 1907.....	340,916.91	214,207.49	126,709.42	41,003.61	85,705.81

# Manufactures and Supplies

## ROLLING STOCK.

**Bloomington Pontiac & Joliet Electric Railway**, Pontiac, Ill., is in the market for three cars.

**Sheffield Company**, Sheffield, Ala., is in the market for one double-truck interurban passenger and baggage car.

**Jersey Central Traction Company**, Keyport, N. J., has contracted with The J. G. Brill Company for four open double-truck cars.

**Municipal Traction Company**, Cleveland, O., has ordered 100 more of its cars rebuilt so that the pay-as-you-enter system of fare collection may be used on them.

**Oneonta & Mohawk Valley Railroad**, Oneonta, N. Y., has ordered five interurban double-truck cars from the Cincinnati Car Company. The trucks will be built by the American Locomotive Company.

**Philadelphia Rapid Transit Company**, Philadelphia, Pa., is having The J. G. Brill Company convert 49 of its standard type cars so that the pay-as-you-enter system of fare collection may be used on them.

**Washington Railway & Electric Company**, Washington, D. C., was reported in our issue of May 2 as about to close contracts for 15 large double-truck cars. We understand that contracts have been placed with The J. G. Brill Company for both cars and trucks.

**Interurban Railway & Terminal Company**, Cincinnati, O., has placed an order with the Allis-Chalmers Company for one quadruple 75-horsepower car equipment and two Christensen air brake equipments. The same company has also ordered two quadruple 50-horsepower car equipments from the Westinghouse Electric & Manufacturing Company.

## TRADE NOTES.

**Humphrey Trolley & Manufacturing Company**, Detroit, Mich., has opened offices at 725 Chamber of Commerce building.

**Texas Portland Cement Company**, Dallas, Tex., announces that it has purchased the holdings and good will of the Iola Portland Cement Company of Texas.

**Swetland Publishing Company**, New York, publisher of the American Architect and Municipal Journal and Engineer, announces the removal of its Chicago office to 1664 Monadnock block.

**General Electric Company**, Schenectady, N. Y., at the annual meeting held on May 12, re-elected the old directors for the ensuing year and elected B. E. Sunny, vice-president, of Chicago, a director to succeed Frederick P. Fish, resigned.

**Walter D. Snow**, publicity engineer, has recently increased his facilities by removal to larger quarters at 170 Summer street, Boston, Mass., and the establishment of an addressing and mailing department, in connection with which select mailing lists will be maintained for the special use of his clients.

**B. E. Sunny**, whose resignation as vice-president and western manager of the General Electric Company and election to a vice-presidency of the American Telephone & Telegraph Company was reported in the Electric Railway Review for April 5, has been elected president of the Chicago Telephone Company.

**National Brake Company**, Buffalo, N. Y., reports among recent large orders for Peacock brakes a contract with the Chicago Railways for 600, to be installed on the new cars building and to be built, and also an order from the New York City Railway for 250 brakes, to be installed on the cars now being built by The J. G. Brill Company.

**Northwestern Expanded Metal Company**, Old Colony building, Chicago, announces changes in its personnel and staff resulting as follows: Henry S. Ames, president; Oscar Bradford, vice-president; William Hall, treasurer; W. G. Bartlett, secretary; Howard W. Foote, general manager; Ernest McCullough, chief engineer; G. F. Dodge, assistant chief engineer; C. S. Mooney, engineer and superintendent, Chicago factory; F. M. Whetstone, superintendent, Canton, O., factory.

**George E. Pratt**, formerly general sales manager of the Hicks Locomotive & Car Works, Chicago, has become vice-president and general manager of the Central Inspection Bureau, 17 State street, New York, and president of H. A. Clark & Co., dealers in passenger and freight cars and car specialties

and sales agents for the Middletown Car Works, Middletown, Pa. Mr. Pratt has had a wide experience in the railway supply business and is well and favorably known among railway men.

**American Blower Company**, Detroit, Mich., has purchased the foundry formerly operated by the Northwestern Foundry & Supply Company of Detroit, manufacturer of cast-iron soil pipe and fittings and plumbers' specialties and expects to operate it for the manufacture of blower, exhaust fan, engine and heater castings. The company desires to dispose immediately of all of the soil pipe and fitting patterns and foundry equipment complete, and also a large stock of finished pipe fittings, bell traps, etc.

**Westinghouse Machine Company**, just at the close of 1907, received one of the largest orders ever placed for mechanical stoking equipment, aggregating 14,400 boiler horsepower. This was for one of the large Brooklyn power stations operated by the Transit Development Company, New York. The order comprised 24 stokers suited to 600-horsepower boilers of the B. & W. water tube type. Moreover, this is the second large order placed by this company for Roney stokers, and may be regarded as the direct result of a year's successful operation of the original 7,200-horsepower installation at the Kent avenue station. As this station was originally equipped with flat grates for hand firing the merits of mechanical stoking have unquestionably been demonstrated along the lines of high economy and low operating cost.

## ADVERTISING LITERATURE.

(Mention of the Electric Railway Review will assure prompt attention to requests for publications listed here.)

**Munn & Co.**, 361 Broadway, New York, N. Y.—The 1908 edition of the Scientific American Index of Manufacturers has been issued.

**Illinois Malleable Iron Company**, Chicago.—An 8-page pamphlet describes the different types of brakeshoes for steam and electric railways manufactured by this company.

**George W. Jackson, Inc.**, Chicago, Ill.—A handsome publication of value to all interested in the transportation of all kinds of material underground and overhead has been issued by the disposal station department of this company. Maps and diagrams show important work done by the company in and about Chicago and a number of interesting halftone views are included.

## DIRECTORY OF ELECTRIC RAILWAY ASSOCIATIONS.

**American Street and Interurban Railway Association.** Secretary, Bernard V. Swenson, 29 West Thirty-ninth street, New York.

**American Street and Interurban Railway Accountants' Association.** Secretary, Elmer M. White, 29 West Thirty-ninth street, New York.

**American Street and Interurban Railway Claim Agents' Association.** Secretary, B. B. Davis, claim adjuster Columbus Railway & Light Company, Columbus, O.

**American Street and Interurban Railway Engineering Association.** Secretary, J. W. Corning, electrical engineer Boston Elevated Railway, Boston, Mass.

**American Street and Interurban Railway Manufacturers' Association.** Secretary, George Keegan, 2321 Park Row building, New York, N. Y.

**American Street and Interurban Railway Transportation and Traffic Association.** Secretary, Bernard V. Swenson, 29 West Thirty-ninth street, New York.

**California Electric Railway Association.** Secretary, L. E. W. Ploda, Oak and Broderick streets, San Francisco, Cal.

**Canadian Street Railway Association.** Secretary, Acton Burrows, 157 Bay street, Toronto, Ont.

**Central Electric Railway Association.** Secretary, A. L. Neereamer, Indianapolis, Ind. Next meeting, Toledo, O., May 26.

**Central Electric Traffic Association.** Chairman, A. L. Neereamer, Indianapolis, Ind. Next meeting, Toledo, O., May 25.

**Colorado Electric Light Power and Railway Association.** Secretary, John F. Dostal, Denver Gas & Electric Company, Denver, Colo.

**Electric Railway Shop Foremen's Association.** Secretary, W. D. Bower, Public Service Corporation of New Jersey, Elizabeth, N. J.

**Fox River Valley Railway & Lighting Association.** Secretary, A. K. Ellis, general superintendent Wisconsin Light Heat & Power Company, Appleton, Wis.

**Iowa Street and Interurban Railway Association.** Secretary, L. D. Mathes, general manager Union Electric Company, Dubuque, Ia.

Massachusetts Street Railway Association. Secretary, Charles S. Clark, 70 Kilby street, Boston, Mass. Meetings held in Boston on second Wednesday of each month, except July and August.

Michigan Electric Association. Secretary, A. C. Marshall, Port Huron, Mich. Annual meeting, Grand Rapids, Mich., August 18 to 21.

National Amusement Park Association. Secretary, C. H. Oberheide, Trenton, N. J. Annual meetings third Tuesday of each November.

New England Street Railway Club. Secretary, John J. Lane, 12 Pearl street, Boston, Mass. Meetings held on fourth Thursday of every month, Boston, Mass.

Northwestern Electrical Association. Secretary, Roger N. Kimball, Kenosha, Wis.

Oklahoma Electric Light Railway and Gas Association. Secretary, Galen Crow, Guthrie, Okla. Annual convention, May 25, 26 and 27, Guthrie, Okla.

Pennsylvania Street Railway Association. Secretary, Charles H. Smith, superintendent Lebanon Valley Street Railway, Lebanon, Pa.

Southwestern Electrical and Gas Association. Secretary, J. A. Myler, Jr., Dallas, Tex.

Street Railway Association of the State of New York. Secretary, J. H. Pardee, 611 West One Hundred and Thirty-seventh street, New York, N. Y. Annual meeting, June 30 and July 1, Niagara Falls, Ont.

**NEW ARC HEADLIGHT AND TROLLEY RETRIEVER.**

The most recent products of the Trolley Supply Company, Canton, O., are a new headlight and a new retriever. Both of these devices are the result of long manufacturing experience along similar lines.

The new arc headlight known as the "Star" is built either with or without incandescent lamps. An accompanying half-tone engraving shows in detail the more important parts of the headlight and clearly illustrates the method of

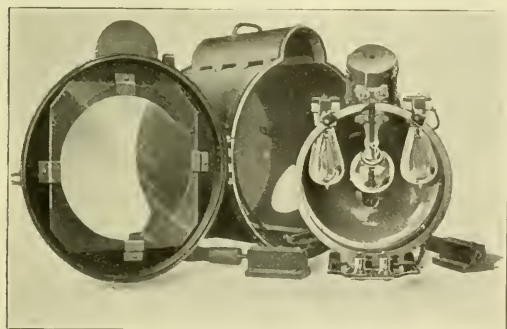

The "Star" Arc and Incandescent Headlight with Lamp Removed from Case.

using square instead of round glass in the front door of the lamp. It has been the aim of the manufacturer to build a headlight which would be a lasting piece of machinery and not deteriorate rapidly from the severe service occasioned on high-speed interurban roads. In the design of the new Star headlight valuable suggestions made by street railway men have been incorporated.

One of the chief criticisms of headlights has been that of excessive repairs partly occasioned by weakness in the frame and case. For this reason the door, frame and backplate of the new headlight are made of malleable iron. The bottom plate and lower carbon holder and rings that hold the reflector and the incandescent attachment are also made of malleable iron, so that the lamp is a strong unit.

For operating the positive carbon an especially powerful magnet inclosed in a malleable iron holder, has been provided. This holder is lined with asbestos, so that the coils of the magnet are well protected from the heat of the arc. The mechanism of the lamp is all mounted on malleable iron bottom plates, so that it may easily be taken from the case of the lamp. The removal requires only the unfastening of a thumb screw which can be reached through an opening in the side of the case. Then the lamp mechanism may easily be swung from the case, moving as it does about a pivot bar at the lower end of the front of the case. The current cables are

fastened to terminals on the front of the removable bottom plate.

The manufacturer of the Star headlight heretofore has used aluminum for the reflector of its "Clinax" headlight. This practice is not adhered to in the new lamp, but instead of aluminum the reflectors are spun from 18-gauge brass, heavily nickel plated. A reflector of this construction is said to hold its luster far longer and be more easily cleaned than an aluminum reflector. Prominent among the valuable features claimed for the new headlight are the steadiness of the light thrown and the ease with which the length of the arc may be regulated.

The new "Peerless" retriever embodies many improvements in design, which it is thought, combined with the general simplicity, will win considerable favor. One important improvement is found in the method of connecting the trolley rope to the retriever. All that is necessary to make this con-

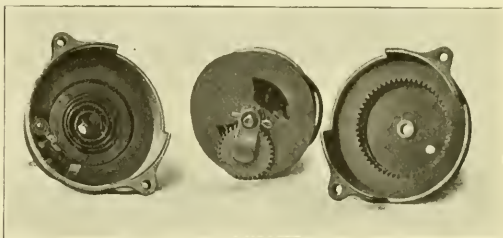

Parts of the "Peerless" Trolley Retriever, Showing Low-Tension Gear, Which Takes the Place of a Weak Spring.

nection is to tie a firm knot in the end of the rope and insert it in a slot provided for the purpose in the reel.

Probably the most important change from the earlier types of retrievers is the absence of what is known as a "weak" spring. The new retriever has only one spring, which is a retrieving or high-tension spring. The absorbing of the slack, so that the rope may always be kept taut, is accomplished by back gearing attached to the reel, as shown in the engraving. This ingenious arrangement of back gear, as simple as it is, takes the place of the weak spring.

The new retriever is an unusually strong device, built largely of malleable iron. It is arranged with a cushioning feature so that at the instant the trolley wheel leaves the wire the pawls cushion on the retrieving spring and thus do not strike a hard blow on the case, rendering it liable to damage from excessive hammering. Severe conditions of weather are said to affect the new retriever far less than in the former designs. Water can get into the mechanism of the machine only under the most severe conditions, and this is practically impossible if the mechanism is occasionally oiled. In the winter, during ice storms, the new retriever will work better than one of the earlier design, because the large opening provided in the case, together with the large cord space, prevent buckling of the rope, which feature, combined with the strong uniform low tension and the continual working of the trolley, break the ice that may form on the rope and allow the drum to move freely.

**G. E. MOTOR PACKING WASTE.**

For many years the J. Milton Hagy Waste Works of Philadelphia has manufactured packing waste suitable for journal boxes. Fourteen years ago this company first introduced spun yarn for this purpose. It is now of interest to electric railway operators that the name of one of the popular brands of waste will hereafter be "G. E. Motor Packing Waste."

The yarn in the G. E. motor packing waste is the result of many years' experience and a continued aim to get the best practical packing material that could be sold for the least money. Some of the manufacturer's claims for this waste are as follows:

It is a clean mixture of wool and hair and therefore is resilient and a good absorbent. The possession of these characteristics results in an even lubrication, assuring a low cost for oil.

The waste is clean and the absence of dirt and grit assures that there will be no grinding inside the journal box.

Owing to the care in its manufacture the waste is composed of long strands, which factor materially reduces the amount of waste required for a given service.

The character of the material is such that it may be easily

packed and therefore the labor cost for maintaining journals is low.

As there are neither any jute nor any soluble mordants in its makeup the waste is said to thoroughly guard against hot boxes.

#### THE TROLLEY ELECTRIC VEHICLE.

Electric railway companies have engaged extensively in the transportation of freight and express during the past few years, but the small package business in cities has not received the attention which it deserves. This has been largely on account of the lack of a suitable medium for transporting small units and the lack of facilities for delivering packages directly to their destination. The Trolley Electric Vehicle Company of Philadelphia has a vehicle, invented by Russell Thayer, president of the company, which is designed to meet the requirements of small units and facility of delivery at any point. The trolley electric vehicle may be constructed of any desirable type for operation over the tracks of a street railway or on the surface of the streets. While traveling on the car tracks it is propelled by the current from the trolley circuit, which is received through a trolley pole, and while traveling on the streets it is propelled by current from a storage battery.

The accompanying engraving from a photograph shows a 5-ton trolley truck, which has been thoroughly tested in commercial service in Pittsburgh. This truck is equipped with four 110-volt  $2\frac{1}{2}$ -horsepower motors, one to each wheel, and while on the tracks receives 500-volt current with the motors in series. While operating independently of the trolley circuit current is obtained from a 42-cell storage battery, furnished by the Electric Storage Battery Company of Philadelphia, and



Trolley Electric Vehicle—Five-Ton Truck Running on Car Track.

the motors are connected in parallel. The motors are geared to a speed of 22 miles per hour on track and 8 miles per hour on the streets.

A 1-ton truck of this type has been tested in Pittsburgh for about two years, in making deliveries from railroad stations to merchants and in transporting provisions from merchants to consumers. Tests have also been made with trucks of 3, 5 and 10 tons capacity. The 5-ton type, which is illustrated herewith, has been used for about six months. The trucks have been operated over the street railway tracks under an arrangement with the Pittsburgh Railways Company and have fully demonstrated their ability to run over the tracks at the schedule speed of the street cars without interfering with the cars. Experience has shown that in usual business the truck operates for about 90 per cent of the distance over the tracks without drawing upon the storage battery. The battery is charged at night, but in the heavier types of vehicles it is planned to recharge the battery from the trolley circuit.

Among the advantages claimed for the truck are the following: It has a much more extended radius of action than the ordinary electric vehicle, as it can run for most of the distance without drawing on the battery, and at the same time uses current from the most economical source. It may be profitably operated at night, thus making use of power equipment which is ordinarily performing no service at the time. It may be used to transport passengers to parks or other portions of a city where tracks may not be laid. It occupies less space in the street than a horse-drawn vehicle and is thus a lesser obstruction to traffic while performing a more efficient service.

#### THE ROOT TRACK SCRAPER.

The illustration presented herewith shows a heavy track scraper in operating position on one of the Philadelphia Rapid Transit Company's elevated cars. This type, known as the Root scraper, is manufactured by the Kalamazoo Railway

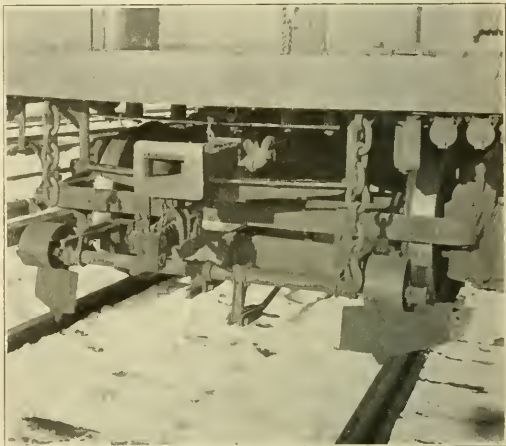

Root Track Scraper in Operation.

Supply Company, Kalamazoo, Mich., and is designed for heavy work and high-speed service. The springs are manufactured of 90 per cent carbon, oil-tempered spring steel, while the shovels are made of 75 to 80 per cent carbon spring steel.

Very small space is required for the installation of the Root scraper, and by the use of the desired length of brackets and chain it may be installed on any height of car above 19 inches from the top of the rail to the bottom of the sills or platform knees.

The Root scraper has given satisfactory service on many important electric railways for the past five years.

#### A NEW RAILWAY MOTOR PINION.

The General Electric Company, Schenectady, N. Y., reports that the remarkable properties which are exhibited by the new "Grade F" pinion now being placed on the market, have caused a number of railways to introduce it in various classes of service. The physical characteristics of tensile strength and elastic limit are greatly in excess of those ordinarily found in this part of the equipment and the claims that one of these pinions will outlast three ordinary pinions is apparently well founded.

As the vital factor of gear economy is the maintenance of the correct outline of the teeth, it is frequently, if not generally, necessary to replace the pinions two or three times during the life of a single gear. The substitution of "Grade F" pinions for the ordinary soft pinion will, therefore, eliminate all the expense for these renewals as well as prevent the inefficient operation of pinions with worn teeth. Worn pinion teeth produce among other evils an increased demand on the power station, excessive wear on motors and trucks and a highly objectionable noise. Even without the economy in renewals, therefore, a pinion having a life approximately equal to the gear is a good business investment.

The General Electric Company is furnishing the "Grade F" pinion on all new equipments.



# The Boilers Will be Out of Service a Much Shorter Time for Washing

thereby requiring very much less labor, to say nothing of the saving in fuel and the increased efficiency of the boilers, if the incrusting solids and other deleterious salts in the water are acted upon by **Dearborn Compounds** and their injurious properties destroyed. Send us gallon sample of your feed water for analysis.

## Dearborn Drug & Chemical Works

ROBT. F. CARR, PRESIDENT

299 BROADWAY, NEW YORK      POSTAL TELEGRAPH BLDG., CHICAGO

WE ARE NOW PREPARED TO FURNISH

# Manganese STEEL PINIONS

FOR USE WITH "TITAN" GEARS

ATHA STEEL CASTING COMPANY, Newark, N. J.

# AN INTERESTING PROBLEM

Simplicity + Durability + Perfection = ?

Answer: The "Kewanee" Union

*Octagon Pattern*



**SIMPLICITY**—Only three parts—no inserted brass pieces to loosen or drop out.

**DURABILITY**—Brass to iron thread connection absolutely prevents corrosion in the thread; can therefore be disconnected and reconnected indefinitely without injury, thus outlasting several ordinary unions.

**DESIGN**—Only three perfect parts.

**MATERIAL**—Brass and Iron; cannot corrode.

**FORM**—Can be easily moved with a common monkey wrench.

**SERVICE**—Equally good for steam, water, air, gas, oil, etc.

**TEST**—Before shipment with compressed air under water.

Fill out Coupon and get the "Answer"

## National Tube Company

General Sales Offices, Frick Bldg.  
PITTSBURG, PA.

### DISTRICT SALES OFFICES

NEW YORK, N. Y.—Hudson Terminal Bldg.  
PHILADELPHIA, PA.—Fenwick Building  
ST. LOUIS, MO.—Third Nat. Bank Bldg.  
SALT LAKE CITY, UTAH—Dooly Bldg.

PITTSBURG, PA.—Frick Bldg.  
DENVER, COLO.—Majestic Bldg.  
SAN FRANCISCO, CAL.—Crocker Bldg.  
PORTLAND, ORE.—Wells Fargo Bldg.

ATLANTA, GA.—Candler Bldg.  
CHICAGO, ILL.—Commercial Nat. Bank Bldg.  
NEW ORLEANS, LA.—Maison Blanche.  
SEATTLE, WASHINGTON—Alaska Bldg.

### COUPON

NATIONAL TUBE COMPANY, 1824 Frick Bldg., PITTSBURG, PA.  
Gentlemen:—Enclosed find ten cents (stamps or coins) to partly pay postage on sample Octagon "Kewanee" Union, that I may test its merits. I will report on same after testing.

Name \_\_\_\_\_ Street \_\_\_\_\_  
City \_\_\_\_\_ State \_\_\_\_\_

Name of dealer from whom supplies are usually bought \_\_\_\_\_ E. R. R.

## THE J. G. BRILL COMPANY, PHILADELPHIA, PA.

AMERICAN CAR COMPANY, ST. LOUIS, MO.

G. C. KUHLMAN CAR COMPANY, CLEVELAND, OHIO

JOHN STEPHENSON COMPANY, ELIZABETH, N. J.

WASON MANUFACTURING CO. SPRINGFIELD, MASS.

MAIN OFFICE: PHILADELPHIA, PA.

LONDON OFFICE: 110 CANNON ST. E.C.

PACIFIC COAST AGENTS: PIERSON

ROEDING & CO., SAN FRANCISCO.

AUSTRALIAN AGENTS: NOYES

BROTHERS, SYDNEY, CALIF.

"BRILL," PHILA. "AXLES" LONDON.

*CARS TRUCKS SEATS RATTAN SPRINGS SPECIALTIES SUPPLIES*

## LARGEST EARNING CAPACITY

For service in cities and towns, where an entirely open car with side entrances is desirable during warm weather, no better car can be found than the Brill Convertible. Unquestionably the entirely open car is the most popular summer type and the Brill Convertible overcomes the two drawbacks of the ordinary car--no protection in bad weather and the necessity for a double equipment of cars--and provides exactly what is wanted for every day in the year. Climatic conditions, of whatever kind, are no bar to the use of the Brill Convertible Car; it is equally successful in the Northern States with their arctic winters as in the Gulf States with their tropical summers. The flexible metal panels slide into the roof pockets just as easily as the sashes, therefore any one can operate them. The Brill Convertible Car is the most practical solution of the question of how to always secure the largest amount of traffic.

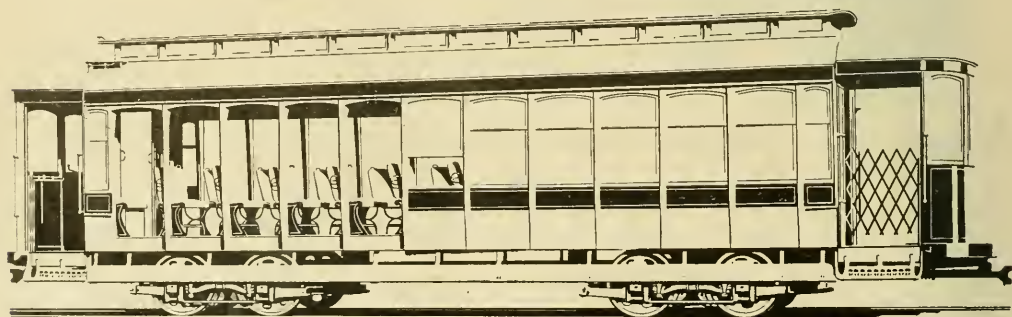

*THE BRILL CONVERTIBLE CAR (PATENTED)*

# Electric Railway Review

PUBLISHED EVERY SATURDAY.

FORMERLY THE STREET RAILWAY REVIEW.

THE WILSON COMPANY, CHICAGO.

CHICAGO: 160 Harrison Street  
NEW YORK: 50 Church Street  
CLEVELAND: 1529 Williamson Bldg.

VOL. XIX  
No. 21

CHICAGO, MAY 23, 1908

Whole No.  
265

Subscription: Domestic, \$2.00  
Foreign, 5.00  
Canada, 3.50

*Electric Railway Companies can well afford  
to present copies of this standard handbook—*

## “The Motorman and His Duties”

*—to motormen and shopmen, for the result will  
be better, safer, more economical operation.*

¶ The purpose of this book is to familiarize the reader with the operation of electric railway cars.

¶ It explains in simple language, devoid of mathematics and technicalities, many points not generally understood by the average employe who has to do with the operation or care of electric railway rolling stock. Such knowledge cannot fail to make his services more valuable to his company and more satisfactory to himself, and it will also better fit him for promotion.

¶ The revised, enlarged and improved sixth edition has 200 pages; 138 illustrations; three folding sheets of multiple-unit car wiring diagrams; attractive green cloth binding, stamped in gold.

*Price, \$1.50 per copy, prepaid.*

*Special prices in quantities of 50 and 100.*

*Descriptive pamphlet sent on request.*

THE WILSON COMPANY, 160 HARRISON ST.  
CHICAGO



Passenger  
Paying  
Fare

## Street Railways using the Rooke Automatic Fare Collector

get every nickel collected because every nickel is registered *before* it reaches the conductor's hand. No chance to go astray!

**Rooke Automatic Register Co.**  
Providence, Rhode Island

5

## TRADE **WALKOVER** MARK Car Seat

Gives more room,  
more comfort, and  
more money value  
than any other  
seat made.

No. 99A  
In Rattan



Notice its superior  
construction and sub-  
stantial appearance.  
Specify and insist on our seats  
for your new Electric Cars;  
they cost less, in the end, than  
the worthless imitations some-  
times offered instead.

**The Hale & Kilburn Mfg. Co.**  
PHILADELPHIA

NEW YORK

CHICAGO

WASHINGTON

# National Air Compressors

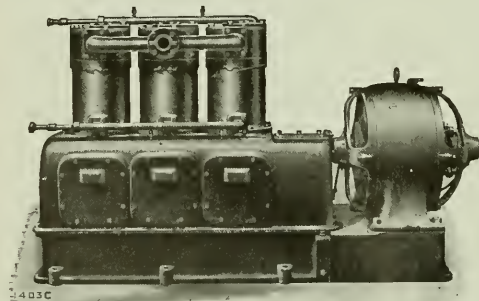

100 cu. ft. Type "3VS" Air Compressor.

These Compressors are especially adapted for service in car shops and barns, where compressed air is used, for various industrial operations, as well as for blowing dust and other accumulations out of car motors, controllers and seats.

Either direct or alternating current motors can be furnished for operating same.

Automatic starters which start and stop the Compressors and keep the air supply within the desired range of pressures are furnished with each Compressor.

Type "3VS" Compressors are built in capacities of 50, 100, 150 and 225 cu. ft. of free air per minute.

Write for Bulletin 84-F

## National Brake & Electric Company MILWAUKEE, WIS., U. S. A.

NEW YORK: 111 Broadway  
SAN FRANCISCO, CAL.: W. F. McKenny, 69-71 First St.

PHILADELPHIA: W. H. Goble, 1722 Westmoreland St.  
BOSTON: F. E. Huntress, 131 State St.  
LONDON: 14 Great Smith St., Westminster

General Sales Office: 519 First National Bank Building, Chicago

# Westinghouse

## The Electrolytic Lightning Arrester

as developed by this company is now recognized as the coming type of arrester for most applications. Watch competitors follow our lead.

Circular No. 1146 contains a fully illustrated description of Electrolytic Lightning Arresters. Ask our nearest office for a copy.

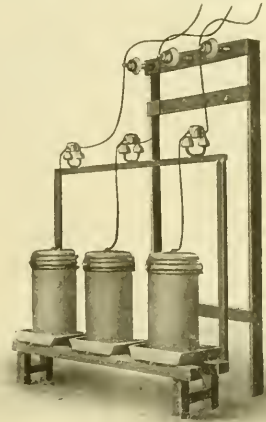

Electrolytic Arresters.

## Westinghouse Electric & Mfg. Co.

Atlanta  
Baltimore  
Boston

Buffalo  
Chicago  
Cincinnati

Cleveland  
Dallas  
Denver

Detroit  
Kansas City  
Los Angeles  
Minneapolis

New Orleans  
New York  
Philadelphia

Pittsburg  
St. Louis  
Salt Lake City

San Francisco  
Seattle  
Syracuse

Canada: Canadian Westinghouse Co., Ltd., Hamilton, Ontario Mexico: G. & O. Braniff & Co., City of Mexico

## Non-Condensing Steam Turbines

—specially designed and improved by us—are being widely used where cooling water is not available for condensing. Under these circumstances there are a number of reasons why our latest type of non-condensing turbine is the best kind of a steam engine to buy. It may be your conditions are just right for our non-condensing turbine. Give us the details of your requirements and we will be glad to show you the economies to be secured by the installation of this type of turbine.

**The Westinghouse Machine Co.**  
Pittsburg, Pa.

## When equipping your cars with air brakes

you must not consider the conditions as they have been, nor altogether as they are, but also as they will be.

## Westinghouse AMM Improved Automatic Air Brakes

are ready to meet every demand that may be made upon them. They are designed for one car operation, or for trains not to exceed five cars, and secure quick recharge, graduated release, quick service and high pressure in emergency, all of these features being essential to the handling of modern electric road traffic.

**Westinghouse Traction Brake Co.**  
Pittsburg, Pa.

## ALPHABETICAL INDEX TO ADVERTISEMENTS.

Advance Lumber Co. ....	Dearborn Drug & Chemical Works .....23	Meyers, Fred J., Mfg. Co. ....26	Shelby Electric Co. ....22
Allis-Chalmers Co. ....	Dossert & Co. ....	Michigan Steel Boat Co. ....	Simmons, John, Co. ....21
Aluminum Co. of America. ....11	Drouvé, G., Co. ....	Miller Anchor Co. ....	Smith, Peter, Heater Co. ....14
American Brake Shoe & Fdry. Co. ....	Eclipse Railway Supply Co. ....10	Model Stoker Co. ....14	Spier Carbon Co. ....
American Electrical Works. ....26	Electric Railway Equipment Co. ....15	Morden Frog & Crossing Wks.16	Standard Brake Shoe Co. ....14
Anderson, Albert & J. M. ....	Electric Ry. Improvement Co. ....26	National Brake & Electric Co. ....2	Standard Motor Truck Co. ....11
Beidler, Francis, & Co. ....21	Electric Service Supplies Co. ....	National Brake Co. ....22	Standard Paint Co. ....26
Armstrong Oiler Co. ....21	Engineers and Contractors. ....14	National Lock Washer Co. ....12	Standard Steel Works Co. ....16
Arnold Company. ....14	Fairbanks, Morse & Co. ....	National Pole Co. ....18	Standard Underground Cable Co. ....
Atha Steel Casting Co. ....23	Ford, Bacon & Davis. ....14	National Tube Co. ....23	Star Brass Works. ....21
Automatic Trolley Guard Co. ....14	Galena-Signal Oil Co. ....13	Naugle Pole & Tie Co. ....18	Stone & Webster Engineering Corporation
Babcock & Wilcox Co. ....11	Garford Co. ....18	New York Switch & Crossing Co. ....	Stuart-Howland Co. ....
Baker, Wm. C., Heating & Supply Co. ....	General Electric Co. ....25	Niles Car & Mfg. Co. ....17	Symington, T. H., Co. ....15
Baldwin Locomotive Works. ....16	Green Engineering Co. ....14	Northern Engineering Works. ....	Telegraph Signal Co. ....22
Barbour-Stockwell Co. ....	Griffin Wheel Co. ....12	Nuttall, R. D., Co. ....	Trolley Supply Co. ....
Barnes, G. H., Hardwood Lumber Co. ....18	Hagy, J. Milton, Waste Wks.11	Ohio Brass Co. ....	U. S. Metal & Mfg. Co. ....13
Beidler, Francis, & Co. ....21	Hale & Kilburn Mfg. Co. ....2	Okonite Co., Ltd. ....18	Van Dorn & Dutton Co. ....14
Bellamy Vestlette Mfg. Co. ....	Hartshorn Co., Stewart. ....12	Pacific Coast Pole Co. ....18	Van Dorn, W. T., Co. ....
Berthold & Jennings. ....	Heine Safety Boiler Co. ....21	Pantasote Co. ....19	Van Valkenburgh, E. C. ....12
Bridgeport Brass Co. ....	Herwood Bros. & Wakefield Co. ....	Patten, Paul B. ....	Wanted and For Sale Cards. ....
Brill, J. G., Co. ....24	Holman, D. F., Ry. Tracklayer Co. ....18	Pay-As-You-Enter Car Co. ....9	.....20, 21
Brown, Harold P. ....13	Humbird Lumber Co., Ltd. ....18	Power Specialty Co. ....12	Watson-Stillman Co. ....21
Brown Hoisting Machy. Co. ....14	Jewett Car Co. ....17	Pressed Steel Car Co. ....	Coupler Co. ....25
Buckeye Engine Co. ....	Johns-Manville, H. W., Co. ....5	Queen & Co. ....19	Watson-Stillman Co. ....21
Burham, Williams & Co. ....16	Kalamazoo Ry. Supply Co. ....5	Rail Joint Co. ....16	Western Electric Co. ....5
Bylesby, H. M., & Co. ....14	Lindsay Bros. Co. ....18	Railway Specialty & Supply Co. ....19	Westinghouse Electric & Mfg. Co. ....3
Central Inspection Bureau. ....14	Lord & Burnham, Inc. ....12	Railway Steel-Spring Co. ....19	Westinghouse Machine Co. ....3
Chase-Shawmut Co. ....15	Lufkin Rule Co. ....26	Register, A. L., & Co. ....14	Westinghouse Traction Brake Co. ....3
Chicago Mica Co. ....19	Lumen Bearing Co. ....10	Robertson, Wm., & Co. ....19	Weston Electrical Instrument Co. ....19
Churchill Cedar Co. ....18	Macallen Co. ....	Roger Ballast Car Co. ....14	Wharton, Wm., Jr., & Co. ....16
Cincinnati Car Co. ....17	McGuire-Cummings Mfg. Co. ....	Rooke Automatic Register Co. ....21	White, J. G., & Co. ....14
Cleveland Frog & Cross. Co. ....16	Marshall, R. W., & Co. ....95	Russell Car & Snow-Plow Co. ....21	Whitmore Mfg. Co. ....19
Collier, Barron G. ....18	Marshall, R. W., & Co. ....95	S-E, Missouri Cypress Co. ....18	Woodbury Carlton Co. ....21
Consolidated Car Fender Co. ....26	McGuire-Cummings Mfg. Co. ....	St. Louis Car Co. ....7	Woodman, R. Mfg. & Supply Co. ....
Consolidated Car-Heating Co. ....14	Marshall, R. W., & Co. ....95	St. Louis Car Wheel Co. ....14	Worcester, C. H., Co. ....18
Contractors' Supply & Equipment Co. ....14	Mathews, J. W., & Co. ....	Sanderson & Porter. ....	
Crane Co. ....14	Mayer, J. W., & Co. ....	Saxton, E. ....14	
Creaghead Engineering Co. ....14	Mead, J. W., & Co. ....	Sheaf & Jastad. ....	
Curtain Supply Co. ....14	Mead, J. W., & Co. ....		
Davis, John, Co. ....13	Mead, J. W., & Co. ....		

## CLASSIFIED LIST OF ADVERTISERS.

Advertising Designs and Plates. Woodbury-Carlton Co., Worcester, Mass.	Badges and Buttons. Electric Service Supplies Co., 200 Plymouth Bldg., Chicago.	Boilers—Continued. Heine Safety Boiler Co., 421 Olive St., St. Louis. Lord & Burnham, Irvington-on-Hudson, N. Y.	Brakes and Brake Parts—Continued. Stephenson, John, Co., Elizabeth, N. J. Wason Mfg. Co., Springfield, Mass. Westinghouse Traction Brake Co., Pittsburg, Pa.
Advertising Service. Van Valkenburgh, E. C., 2117 West One Hundred and Second St., Chicago.	Ballast Cars—(See Cars, Ballast).	Boiler Cleaning Compounds. Dearborn Drug & Chemical Works, Chicago. Johns-Manville, H. W., Co., New York.	Brakeshoes. American Brake Shoe & Fdry. Co., Mahwah, N. J. American Car Co., St. Louis. Barbour-Stockwell Co., Cambridgeport, Mass. Brill, J. G., Co., Philadelphia. Kuhlman, G. C., Car Co., Cleveland. McGuire-Cummings Mfg. Co., Chicago. Marshall, R. W., & Co., 95 Liberty St., New York. St. Louis Car Co., St. Louis. Standard Brake Shoe Co., Aurora, Ill. Stephenson, John, Co., Elizabeth, N. J. Wason Mfg. Co., Springfield, Mass. Wharton, Wm., Jr., & Co., Philadelphia.
Advertising, Street Car. Collier, Barron G., Flat Iron Bldg., New York.	Ball Bearings. Symington, T. H., Co., Baltimore, Md.	Bonds, Rail. Brown, H. P., 120 Liberty St., New York. Chase-Shawmut Co., Newburyport, Mass. Electric Railway Improvement Co., Cleveland, O. Electric Service Supplies Co., 200 Plymouth Bldg., Chicago. General Electric Co., Schenectady, N. Y. Lumen Bearing Co., Buffalo, N. Y. McGuire-Cummings Mfg. Co., Chicago. Marshall, R. W., & Co., 95 Liberty St., New York. Nuttall, R. D., Co., Pittsburg. Ohio Brass Co., Mansfield, O. Symington, T. H., Co., Baltimore, Md. Van Dorn & Dutton Co., Cleveland, O.	Bridge Timbers. Beidler, Francis, & Co., Chicago.
Air Brakes—(See Brakes and Brake Parts).	Bases—(See Trolley Poles and Fittings).	Brackets and Cross Arms. Anderson, Albert & J. M., Mfg. Co., Boston. Creaghead Engineering Co., Cincinnati, O. Electric Railway Equipment Co., Cincinnati, O. Electric Service Supplies Co., 200 Plymouth Bldg., Chicago. Johns-Manville, H. W., Co., New York. Lindsay Bros. Co., Spokane, Wash. Ohio Brass Co., Mansfield, O. Stuart-Howland Co., Boston. Western Electric Co., Chicago.	Brushes, Motor and Dynamo. Electric Service Supplies Co., 200 Plymouth Bldg., Chicago. General Electric Co., Schenectady, N. Y. Spier Carbon Co., St. Marys, Pa.
Air Compressors—(See Compressors, Air).	Bearings. Electric Service Supplies Co., 200 Plymouth Bldg., Chicago. General Electric Co., Schenectady, N. Y. Lumen Bearing Co., Buffalo, N. Y. McGuire-Cummings Mfg. Co., Chicago. Marshall, R. W., & Co., 95 Liberty St., New York. Nuttall, R. D., Co., Pittsburg. Ohio Brass Co., Mansfield, O. Symington, T. H., Co., Baltimore, Md. Van Dorn & Dutton Co., Cleveland, O.	Brumpers, Car. American Car Co., St. Louis. Brill, J. G., Co., Philadelphia. Kuhlman, G. C., Car Co., Cleveland. St. Louis Car Co., St. Louis. Stephenson, John, Co., Elizabeth, N. J. Wason Mfg. Co., Springfield, Mass.	Car Replacers. Electric Service Supplies Co., 200 Plymouth Bldg., Chicago. Fairbanks, Morse & Co., Chicago.
Alloys and Bearing Metals. Brown, H. P., 120 Liberty St., New York. General Electric Co., Schenectady, N. Y. Lumen Bearing Co., Buffalo, N. Y. Ohio Brass Co., Mansfield, O. St. Louis Car Co., St. Louis, Mo.	Bells and Gongs. American Car Co., St. Louis. Brill, J. G., Co., Philadelphia. Electric Service Supplies Co., 1020-24 Filbert St., Phila. Kuhlman, G. C., Car Co., Cleveland. McGuire-Cummings Mfg. Co., Chicago. National Tube Co., Pittsburg, Pa. Ohio Brass Co., Mansfield, O. St. Louis Car Co., St. Louis. Stephenson, John, Co., Elizabeth, N. J. Wason Mfg. Co., Springfield, Western Electric Co., Chicago.	Block System—(See Signals).	
Aluminum Wire, Etc. Aluminum Co. of America, Pittsburg.	Blue Printing Machines. Buckeye Engine Co., Salem, O.	Boilers. Babcock & Wilcox Co., New York. Fairbanks, Morse & Co., Chicago.	
Anchors. Electric Service Supplies Co., 200 Plymouth Bldg., Chicago. Miller Anchor Co., Norwalk, O. Ohio Brass Co., Mansfield, O.	Block System—(See Signals).		
Armatures and Coils, Winding and Repairing. Electric Service Supplies Co., 200 Plymouth Bldg., Chicago. General Electric Co., Schenectady, N. Y. Marshall, R. W., & Co., 95 Liberty St., New York. Stuart-Howland Co., Boston.			
Armature Lifts. Electric Service Supplies Co., 200 Plymouth Bldg., Chicago.			
Asbestos Materials. Johns-Manville, H. W., Co., New York.			
Axles—(See Wheels and Axles).			
Babbitt Metals—(See Alloys and Bearing Metals).			

# WESTERN ELECTRIC

CHICAGO DENVER PITTSBURG SAINT PAUL NEW YORK  
 SAINT LOUIS PITTSBURG COMPANY CINCINNATI ATLANTA  
 SAN FRANCISCO SEATTLE SALT LAKE CITY LOS ANGELES KANSAS CITY PHILADELPHIA

## Arc Lamps



All styles, all sizes, for all standard voltages and every conceivable use.

We make enough arc lamps every day to light a good-sized city.

Send for Bulletin No. 7035-C and let us quote on your next order.

## Uncle Sam Says J-M Asbestos Roofing



is "superior to the others." That's the opinion the United States Government experts reached after a careful investigation and comparison of the various roofings. That is why the largest roofing order ever placed by the Government was awarded to us.

When Government Experts consider J-M Asbestos Roofing

## Superior to Others

isn't it a pretty safe guide to follow?

It is considered the best roofing by people who know, because, being made of Asbestos, it resists fire; will not rot or rust; is not affected by acids, chemical fumes, gases, salt air, heat or cold, and requires no painting. In other words, because it lasts the longest and is the "cheapest-per-year" roofing.

WRITE NEAREST BRANCH FOR CATALOG 302.

## H. W. JOHNS-MANVILLE CO.



NEW YORK  
MILWAUKEE  
CHICAGO  
BOSTON  
PHILADELPHIA  
ST. LOUIS

PITTSBURG  
CLEVELAND  
BUFFALO  
BALTIMORE  
NEW ORLEANS  
KANSAS CITY  
DETROIT

MINNEAPOLIS  
SAN FRANCISCO  
LOS ANGELES  
SEATTLE  
DALLAS  
LONDON 767

THE MAIN FEATURE of this coupler is its great strength and simplicity. In fact, it makes a coupling joint that is as strong as, if not stronger than, the cars themselves. It will be noted that the head has heavy coupling faces, and, with the great width of the link and heavy reinforcing ribs on the outside of the head, lateral breakage due to curvature strains is impossible. The heavy lock and its bearing both at the top and bottom give the strongest kind of a locking device.

Ask for new catalogue of traction devices.

Washburn Steel Castings & Coupler Co.  
MINNEAPOLIS, MINN.



## Washburn "K" Type Traction Coupler

Western Agents:  
TWEEDY, HOOD & FINLEN, 204 Fisher Bldg., Chicago  
Canadian Agent: JOHN TAYLOR, Montreal

15

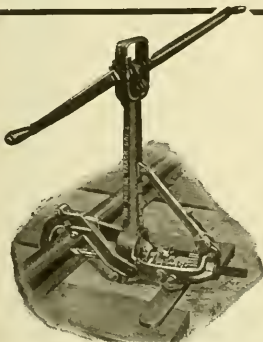

## The Moore Track Drill

does not interfere with traffic!

The shifting of one lever and a few seconds' time takes down the drill—the operation reversed makes it ready for work again.

This is only one of the many strong points about the Moore Track Drill that make it worth buying.

Ask for descriptive catalogue.



Kalamazoo Railway Supply Co. Kalamazoo Michigan

1

## CLASSIFIED LIST OF ADVERTISERS—Continued.

- Car Replacers—Continued.**  
Kalamazoo Railway Supply Co., Kalamazoo, Mich.  
Ohio Brass Co., Mansfield, O.  
U. S. Metal & Mfg. Co., 25 Broad St., New York.
- Car Seats.**  
American Car Co., St. Louis.  
Brill, J. G. Co., Philadelphia.  
Hale & Kilburn Mfg. Co., Philadelphia.  
Heywood Bros. & Wakefield Co., Wakefield, Mass.  
Kuhlman, G. C., Car Co., Cleveland.  
St. Louis Car Co., St. Louis.  
Stephenson, John, Co., Elizabeth, N. J.  
Wason Mfg. Co., Springfield, Mass.
- Car Steps.**  
Electric Service Supplies Co., 200 Plymouth Bldg., Chicago.
- Car Trimmings—(See Trimmings, Car).**
- Cars, Ballast.**  
Rodger Ballast Car Co., Chicago.  
St. Louis Car Co., St. Louis.
- Cars, Dump.**  
Fairbanks, Morse & Co., Chicago.  
Rodger Ballast Car Co., Chicago.  
Russell Car & Snow-Plow Co., Ridgway, Pa.  
St. Louis Car Co., St. Louis.
- Cars, Passenger and Freight.**  
American Car Co., St. Louis.  
Brill, J. G. Co., Philadelphia.  
Cincinnati Car Co., Cincinnati.  
Detroit Carbuilding & Equipment Co., Detroit, Mich.  
Electric Railway Improvement Co., Cleveland, O.  
Fairbanks, Morse & Co., Chicago.  
Jewett Car Co., Newark, O.  
Kuhlman, G. C., Car Co., Cleveland.  
McGuire-Cummings Mfg. Co., Chicago.  
Niles Car & Mfg. Co., Niles, O.  
Pressed Steel Car Co., Pittsburg.  
Rodger Ballast Car Co., Chicago.  
Russell Car & Snow-Plow Co., Ridgway, Pa.  
St. Louis Car Co., St. Louis.  
Standard Motor Truck Co., Pittsburg.  
Stephenson, John, Co., Elizabeth, N. J.  
Wason Mfg. Co., Springfield, Mass.
- Cars, Pay-As-You-Enter.**  
Pay-As-You-Enter Car Co., 26 Cortlandt St., New York.
- Cars, Rebuild.**  
Detroit Carbuilding & Equipment Co., Detroit, Mich.
- Cars, Second-Hand.**  
Detroit Carbuilding & Equipment Co., Detroit, Mich.  
Marshall, R. W. & Co., 95 Liberty St., New York.
- Cars, Steel.**  
Pressed Steel Car Co., Pittsburg.  
St. Louis Car Co., St. Louis.  
Standard Motor Truck Co., Pittsburg.
- Castings, Brass.**  
Star Brass Works, Kalamazoo, Mich.
- Castings, Iron and Steel.**  
American Brake Shoe & Foundry Co., Mahwah, N. J.  
Green Engineering Co., Com'l Nat. Bk. Bldg., Chicago.  
National Brake & Electric Co., Milwaukee.  
Standard Steel Works Co., Philadelphia, Pa.  
Washburn Steel Castings & Coupler Co., Minneapolis.
- Catchers—(See Trolley Retrievers and Catchers).**
- Cattleguards.**  
Fairbanks, Morse & Co., Chicago.
- Circuit-Breakers.**  
Electric Service Supplies Co., 200 Plymouth Bldg., Chicago.  
General Electric Co., Schenectady, N. Y.  
Western Electric Co., Chicago.
- Coal Handling Machinery—(See Conveyors).**
- Coils—(See Armatures and Coils)**
- Commutators and Parts.**  
Electric Service Supplies Co., 1020-24 Filbert St., Phila.  
General Electric Co., Schenectady, N. Y.  
Marshall, R. W. & Co., 95 Liberty St., New York.  
Ohio Brass Co., Mansfield, O.  
Stuart-Howland Co., Boston.
- Compressors, Air.**  
Fairbanks, Morse & Co., Chicago.  
General Electric Co., Schenectady, N. Y.  
National Brake & Electric Co., Milwaukee.  
Westinghouse Traction Brake Co., Pittsburg.
- Concrete Mixers.**  
Contractors' Supply & Equip. Co., Chicago.
- Conduits.**  
Electric Service Supplies Co., 200 Plymouth Bldg., Chicago.  
Western Electric Co., Chicago.
- Connectors, Solderless.**  
Dossert & Co., 242 W. Forty-first St., New York.
- Contractors.**  
Arnold Company, 181 La Salle St., Chicago.  
Bylesby, H. M., Co., Am. Trust Bldg., Chicago.  
Columbia Construction Co., Milwaukee, Wis.  
Creaghead Engineering Co., Cincinnati, O.  
Green Engineering Co., Com'l Nat. Bk. Bldg., Chicago.  
Register, A. L. & Co., 112 Broad St., Philadelphia.  
Sanderson & Porter, 52 William St., New York.  
Saxton, E., 341 Bladensburg Rd., Washington, D. C.  
Sheaff & Jaastad, 88 Broad St., Boston.  
Stone & Webster Engineering Corporation, Boston.  
Whelan, Wm., Jr., & Co., Philadelphia.  
White, J. G., & Co., 49 Exchange Pl., New York.
- Controllers and Attachments.**  
Electric Service Supplies Co., 200 Plymouth Bldg., Chicago.  
General Electric Co., Schenectady, N. Y.  
Johns-Manville, H. W., Co., New York.  
Marshall, R. W. & Co., 95 Liberty St., New York.  
Western Electric Co., Chicago.  
Westinghouse Electric & Mfg. Co., Pittsburg.
- Conveyors and Coal Handling Machinery.**  
Green Engineering Co., Com'l Nat. Bk. Bldg., Chicago.  
Northern Engineering Works, Detroit, Mich.
- Cord, Bell and Trolley.**  
American Car Co., St. Louis.  
Brill, J. G. Co., Philadelphia.  
Electric Service Supplies Co., 1020-24 Filbert St., Phila.  
Kuhlman, G. C., Car Co., Cleveland.  
St. Louis Car Co., St. Louis.  
Stephenson, John, Co., Elizabeth, N. J.  
Stuart-Howland Co., Boston.  
Wason Mfg. Co., Springfield, Mass.
- Couplers, Car.**  
American Car Co., St. Louis.  
Brill, J. G. Co., Philadelphia.  
Kuhlman, G. C., Car Co., Cleveland.  
McGuire-Cummings Mfg. Co., Chicago.  
Ohio Brass Co., Mansfield, O.  
St. Louis Car Co., St. Louis.  
Stephenson, John, Co., Elizabeth, N. J.
- Couplers, Car—Continued.**  
Van Dorn, W. T. Co., Paulina St., Chicago.  
Washburn Steel Castings & Coupler Co., Minneapolis.  
Wason Mfg. Co., Springfield, Mass.
- Coverings, Pipe and Boiler.**  
Johns-Manville, H. W., Co., New York.
- Cranes, Hoists and Lifts.**  
American Car Co., St. Louis.  
Brill, J. G. Co., Philadelphia.  
Brown Hoisting Machinery Co., Cleveland, O.  
Kuhlman, G. C., Car Co., Cleveland.  
Northern Engineering Works, Detroit, Mich.  
Railway Specialty & Supply Co., Chicago.  
Stephenson, John, Co., Elizabeth, N. J.  
Van Dorn & Dutton Co., Cleveland, O.  
Wason Mfg. Co., Springfield, Mass.
- Cross Arms—(See Brackets and Cross Arms).**
- Crossing Gates—(See Gates and Guards).**
- Crossings, Track—(See Switches, Frogs and Crossings).**
- Curtains, Fixtures and Materials.**  
American Car Co., St. Louis.  
Brill, J. G. Co., Philadelphia.  
Curtain Supply Co., 93 Ohio St., Chicago.  
Electric Service Supplies Co., 200 Plymouth Bldg., Chicago.  
Hartshorn Co., Stewart, East Newark, N. J.  
Kuhlman, G. C., Car Co., Cleveland.  
Marshall, R. W. & Co., 95 Liberty St., New York.  
National Lock Washer Co., Newark, N. J.  
Pantaso Co., 11 Broadway, New York.  
St. Louis Car Co., St. Louis.  
Stephenson, John, Co., Elizabeth, N. J.  
Wason Mfg. Co., Springfield, Mass.
- Cylinder Oil.**  
Power Specialty Co., 111 Broadway, New York.
- Derailing Devices.**  
Cleveland Frog & Crossing Co., Cleveland, O.
- Doors and Fixtures.**  
American Car Co., St. Louis.  
Brill, J. G. Co., Philadelphia.  
Kuhlman, G. C., Car Co., Cleveland.  
St. Louis Car Co., St. Louis.  
Stephenson, John, Co., Elizabeth, N. J.  
Wason Mfg. Co., Springfield, Mass.
- Draft Rigging.**  
Van Dorn, W. T. Co., Chicago.  
Washburn Steel Castings & Coupler Co., Minneapolis.
- Drills, Track.**  
Brown, H. P., 120 Liberty St., New York.  
Electric Service Supplies Co., 200 Plymouth Bldg., Chicago.  
Fairbanks, Morse & Co., Chicago.  
Kalamazoo Railway Supply Co., Kalamazoo, Mich.  
Marshall, R. W. & Co., 95 Liberty St., New York.
- Dynamos and Generators.**  
Fairbanks, Morse & Co., Chicago.  
General Electric Co., Schenectady, N. Y.  
National Brake & Electric Co., Milwaukee, Wis.  
Western Electric Co., Chicago.  
Westinghouse Electric & Mfg. Co., Pittsburg, Pa.
- Electric Instruments.**  
Electric Service Supplies Co., 200 Plymouth Bldg., Chicago.  
General Electric Co., Schenectady, N. Y.
- Electrical Instruments—Continued.**  
Hess, Ed.  
Johns-Manville, H. W., Co., New York.  
Queen & Co., Philadelphia.  
Wason Mfg. Co., Springfield, Mass.  
Westinghouse Electric & Mfg. Co., Pittsburg, Pa.  
Weston Electrical Instrument Co., Newark, N. J.
- Electric Railway Supplies, General.**  
Creaghead Engineering Co., Cincinnati, O.  
Electric Service Supplies Co., 200 Plymouth Bldg., Chicago.  
Fairbanks, Morse & Co., Chicago.  
General Electric Co., Schenectady, N. Y.  
Johns-Manville, H. W., Co., New York.  
Marshall, R. W. & Co., 95 Liberty St., New York.  
Ohio Brass Co., Mansfield, O.  
Stuart-Howland Co., Boston.  
Western Electric Co., Chicago.
- Engineers and Contractors.**  
Arnold Company, Chicago.  
Byrd, H. M., & Co., Chicago.  
Ford, Bacon & Davis, New York.  
Register, A. L. & Co., Philadelphia.  
Sanderson & Porter, New York.  
Saxton, E., Washington, D. C.  
Sheaff & Jaastad, Boston.  
Stone & Webster Engineering Corporation, Boston.  
White, J. G., & Co., New York.
- Engines, Gas and Oil.**  
Buckeye Engine Co., Salem, O.  
Fairbanks, Morse & Co., Chicago.  
Westinghouse Machine Co., Pittsburg.
- Engines, Hoisting.**  
Fairbanks, Morse & Co., Chicago.
- Engines, Steam.**  
Buckeye Engine Co., Salem, O.  
Westinghouse Machine Co., Pittsburg.
- Fans, Exhaust and Ventilating.**  
General Electric Co., Schenectady, N. Y.  
Western Electric Co., Chicago.  
Westinghouse Elec. & Mfg. Co., Pittsburg.
- Fare Boxes—(See Electric Railway Supplies).**
- Fare Registers and Register Fittings.**  
Electric Service Supplies Co., 200 Plymouth Bldg., Chicago.  
Rooke Automatic Register Co., Providence, R. I.
- Feed Wire—(See Wire and Cables).**
- Fenders and Guards.**  
Consolidated Car Fender Co., Providence, R. I.  
Eclipse Railway Supply Co., Cleveland, O.  
Electric Service Supplies Co., 1020-24 Filbert St., Phila.  
McGuire-Cummings Mfg. Co., Chicago.  
Marshall, R. W. & Co., 95 Liberty St., New York.
- Flangers, Snow.**  
Kalamazoo Railway Supply Co., Kalamazoo, Mich.  
McGuire-Cummings Mfg. Co., Chicago.  
Ohio Brass Co., Mansfield, O.  
Van Dorn & Dutton Co., Cleveland, O.
- Frogs—(See Switches, Frogs and Crossings).**
- Fuses and Fuse Devices.**  
Chase-Shawmut Co., Newburyport, Mass.  
Electric Service Supplies Co., 200 Plymouth Bldg., Chicago.  
General Electric Co., Schenectady, N. Y.  
Johns-Manville, H. W., Co., New York.



# ST. LOUIS CAR CO. ST. LOUIS - MO.



## St. Louis Car Company's Semi-Convertible Type

The illustration represents one of the cars recently shipped by us to the Houston Electric Company, Houston, Texas.

These cars are of our own design—a practically perfect Semi-Convertible type. Both lower and upper sashes raise into the roof. They move easily and when in the roof pockets are securely fastened, with no possible danger of falling and injuring passengers.

### Our construction of the Semi-Convertible Car is the very best that has yet been devised

These Houston cars are 28' over corner posts and 31' 6" over all. Width over arm rail, 8' 6". They are finished with very handsomely figured mahogany, provided with curtains at each window and each door opening and have the St. Louis Car Company's latest improved "Walkover" seat.

The cars are mounted on St. Louis Car Company's No. 47 Short Wheel Base Truck, which has been adopted as standard in a great many of the larger cities. The channel-iron and steel construction of the "Robertson type" permits the arm rail of the car to be placed very low and adds much to the appearance.

*Photographs, Blue Prints and Specifications will be mailed upon request.*

## CLASSIFIED LIST OF ADVERTISERS—Continued.

- Fuses and Fuse Devices—Continued.**  
Western Electric Co., Chicago.  
Westinghouse Elec. & Manufacturing Co., Pittsburg.
- Gaskets, Bronze.**  
Power Specialty Co., 111 Broadway, New York.
- Gates and Guards.**  
Kalamazoo Railway Supply Co., Kalamazoo, Mich.
- Gear Cases.**  
Electric Service Supplies Co., 200 Plymouth Bldg., Chicago.  
General Electric Co., Schenectady, N. Y.  
Marshall, R. W., & Co., 95 Liberty St., New York.
- Gears and Pinions.**  
Atha Steel Casting Co., Newark, N. J.  
Electric Service Supplies Co., 200 Plymouth Bldg., Chicago.  
General Electric Co., Schenectady, N. Y.  
Marshall, R. W., & Co., 95 Liberty St., New York.  
Nuttall, R. D., Co., Pittsburg.  
Van Dorn & Dutton Co., Cleveland, O.
- Generators—(See Dynamos).**
- Gongs—(See Bells and Gongs).**
- Graphite Paint—(See Paint).**
- Grates, Chain.**  
Green Engineering Co., Com'l Nat. Bk. Bldg., Chicago.
- Grease—(See Lubricants).**
- Grinders.**  
Brown, H. P., 120 Liberty St., New York.
- Ground Connection Clamps.**  
Chase-Shawmut Co., Newburyport, Mass.
- Guy Anchors—(See Anchors).**
- Harps, Trolley—(See Trolley Poles and Fittings).**
- Headlights.**  
Electric Service Supplies Co., 200 Plymouth Bldg., Chicago.  
Fairbanks, Morse & Co., Chicago.  
General Electric Co., Schenectady, N. Y.  
St. Louis Car Co., St. Louis.  
Stuart-Howland Co., Boston.  
Trolley Supply Co., Canton, O.
- Heaters, Car, Electric.**  
Consolidated Car-Heating Co., New York, N. Y.  
Johns-Manville, H. W., Co., New York.
- Heaters, Car, Hot Water, and Stoves.**  
Baker, Wm. C., Heating & Supp. Co., New York.  
McGuire-Cummings Mfg. Co., Chicago.  
Smith, Peter, Heater Co., Detroit, Mich.
- Hoists—(See Cranes, Hoists and Lifts).**
- Hose Bridges.**  
Ohio Brass Co., Mansfield, O.
- Hydraulic Machinery.**  
Watson-Stillman Co., 26 Cortlandt St., New York.
- Inspection.**  
Central Inspection Bureau, 17 State St., New York.
- Inspection Cars, Gasoline.**  
Stover Motor Car Co., Freeport, Ill.
- Instruments, Measuring and Testing—(See Electrical Instruments).**
- Insulating Tapes.**  
General Electric Co., Schenectady, N. Y.  
Johns-Manville, H. W., Co., New York.  
Okonite Co., Ltd., 253 Broadway, New York.  
Western Electric Co., Chicago.
- Insulations and Insulating Material—Continued.**  
Creaghead Engineering Co., Cincinnati, O.  
Electric Railway Equipment Co., Cincinnati, O.  
Electric Service Supplies Co., 200 Plymouth Bldg., Chicago.  
General Electric Co., Schenectady, N. Y.  
Johns-Manville, H. W., Co., New York.  
Macallen Company, Boston.  
Ohio Brass Co., Mansfield, O.  
Okonite Co., Ltd., 253 Broadway, New York.  
Standard Paint Co., 100 William St., New York.  
Stuart-Howland Co., Boston.  
Western Electric Co., Chicago.
- Jacks.**  
American Car Co., St. Louis.  
Brill, J. G., Co., Philadelphia.  
Electric Service Supplies Co., 200 Plymouth Bldg., Chicago.  
Fairbanks, Morse & Co., Chicago.  
Kalamazoo Railway Supply Co., Kalamazoo, Mich.  
Kuhlman, G. C., Car Co., Cleveland.  
Marshall, R. W., & Co., 95 Liberty St., New York.  
Morden, Frog & Crossing Co., Chicago.  
Stephenson, John, Co., Elizabeth, N. J.  
Wason Mfg. Co., Springfield, Mass.  
Watson-Stillman Co., 26 Cortlandt St., New York.
- Joints, Expansion—(See Steam Fittings).**
- Joints, Rail.**  
Rail Joint Co., 29 W. 34th St., New York.
- Journal Boxes.**  
American Car Co., St. Louis.  
Brill, J. G., Co., Philadelphia.  
Kuhlman, G. C., Car Co., Cleveland.  
McGuire-Cummings Mfg. Co., Chicago.  
St. Louis Car Co., St. Louis.  
Stephenson, John, Co., Elizabeth, N. J.  
Symington, T. H., Co., Baltimore, Md.  
Wason Mfg. Co., Springfield, Mass.
- Journal Lubricators—(See Lubricants).**
- Journal Packing, Steel Wool.**  
Robertson, Wm., & Co., Fifth Floor Great Northern Bldg., Chicago.
- Lamps, Arc and Incandescent.**  
Anderson, A. & J. M., Mfg. Co., Boston.  
Electric Service Supplies Co., 200 Plymouth Bldg., Chicago.  
General Electric Co., Schenectady, N. Y.  
Shelby Electric Co., Shelby, O.  
Stuart-Howland Co., Boston.  
Western Electric Co., Chicago.  
Westinghouse Electric & Mfg. Co., Pittsburg, Pa.
- Lamp Sockets.**  
Electric Service Supplies Co., 200 Plymouth Bldg., Chicago.  
General Electric Co., Schenectady, N. Y.  
Johns-Manville, H. W., Co., New York.
- Lantern Globes.**  
Railway Specialty & Supply Co., Chicago.
- Lifts—(See Cranes, Hoists and Lifts).**
- Lightning Arresters.**  
Electric Service Supplies Co., 200 Plymouth Bldg., Chicago.  
General Electric Co., Schenectady, N. Y.  
Stuart-Howland Co., Boston.  
Western Electric Co., Chicago.  
Westinghouse Elec. & Manufacturing Co., Pittsburg.
- Line Material.**  
Anderson, A. & J. M., Mfg. Co., Boston.  
Creaghead Engineering Co., Cincinnati, O.  
Johns-Manville, H. W., Co., New York.  
Electric Ry. Equipment Co., Cincinnati, O.  
Electric Service Supplies Co., 200 Plymouth Bldg., Chicago.
- Line Material—Continued.**  
General Electric Co., Schenectady, N. Y.  
Macallen Co., Boston.  
Marshall, R. W., & Co., 95 Liberty St., New York.  
Stuart-Howland Co., Boston.  
Western Electric Co., Chicago.
- Lock and Nut Washers.**  
National Lock Washer Co., Newark, N. J.
- Lockers, Metal.**  
Electric Service Supplies Co., 200 Plymouth Bldg., Chicago.
- Locomotives.**  
Beiden Locomotive Works, Philadelphia.
- Locomotives, Electric.**  
American Car Co., St. Louis.  
Baldwin Locomotive Works, Philadelphia.  
Brill, J. G. Co., Philadelphia.  
General Electric Co., Schenectady, N. Y.  
Kuhlman, G. C., Car Co., Cleveland.  
McGuire-Cummings Mfg. Co., Chicago.  
Stephenson, John, Co., Elizabeth, N. J.  
Wason Mfg. Co., Springfield, Mass.  
Westinghouse Elec. & Manufacturing Co., Pittsburg.
- Locomotives, Gasoline.**  
Fairbanks, Morse & Co., Chicago.  
Stover Motor Car Co., Freeport, Ill.
- Lubricants.**  
Dearborn Drug & Chemical Works, Chicago.  
Galena-Signal Oil Co., Franklin, Pa.  
Whitmore Mfg. Co., Cleveland, O.
- Lumber.**  
Advance Lumber Co., Cleveland, O.  
Barnes, G. H., Hardwood Lumber Co., St. Louis, Mo.  
Beider, Francis, & Co., Chicago.  
Berthold & Jennings, St. Louis, Mo.  
Churchill Cedar Co., Spokane, Wash.  
Humbird Lumber Co., Sand Point, Idaho.  
Lindsay Bros. Co., Spokane, Wash.  
National Pole Co., Escanaba, Mich.  
Naugle Pole & Tie Co., 226 La Salle St., Chicago.  
Pacific Coast Pole Co., Spokane, Wash.  
S-E. Missouri Cypress Co., Campbell, Mo.  
Westcoast, C. H., Co., Tribune Bldg., Chicago.
- Malleable Iron.**  
St. Louis Car Co., St. Louis.
- Measuring Tapes.**  
Lufkin Rule Co., Saginaw, Mich.
- Meters.**  
Johns-Manville, H. W., Co., New York.  
Queen & Co., Philadelphia.  
Weston Electrical Instrument Co., Newark, N. J.
- Mica, Raw and Manufactured.**  
Chicago Mica Co., Valparaiso, Ind.
- Motor Cars, Gasoline.**  
Stover Motor Car Co., Freeport, Ill.
- Motors, Electric.**  
Fairbanks, Morse & Co., Chicago.  
General Electric Co., Schenectady, N. Y.  
National Brake & Electric Co., Milwaukee.  
Partridge, Arthur S., 425 Olive St., St. Louis, Mo.  
Western Electric Co., Chicago.  
Westinghouse Elec. & Manufacturing Co., Pittsburg.
- Nut Locks.**  
Chase-Shawmut Co., Newburyport, Mass.  
National Lock Washer Co., Newark, N. J.  
Railway Specialty & Supply Co., Chicago.  
St. Louis Car Co., St. Louis.  
U. S. Metals & Mfg. Co., 25 Broad St., New York.
- Nuts and Bolts.**  
National Lock Washer Co., Newark, N. J.  
Railway Specialty & Supply Co., Chicago.
- Oilers.**  
Armstrong Oiler Co., 31st and Chestnut St., Philadelphia.
- Oils—(See Lubricants).**
- Overhead Equipment—(See Electric Railway Supplies).**
- Packings.**  
Electric Service Supplies Co., 200 Plymouth Bldg., Chicago.  
Johns-Manville, H. W., Co., New York.  
Power Specialty Co., 111 Broadway, New York.
- Packing, Steel Wool Journal.**  
Robertson, Wm., & Co., Fifth Floor Great Northern Bldg., Chicago.
- Paints.**  
Standard Paint Co., 100 William St., New York.
- Pay-As-You-Enter Cars.**  
Pay-As-You-Enter Car Co., 26 Cortlandt St., New York.
- Pipe Bends and Fittings—(See Steam Fittings).**
- Poles, Metal.**  
Creaghead Engineering Co., Cincinnati, O.  
Electric Railway Equipment Co., Cincinnati, O.  
Electric Service Supplies Co., 200 Plymouth Bldg., Chicago.
- Poles and Ties, Wood.**  
Advance Lumber Co., Cleveland, O.  
Barnes, G. H., Hardwood Lumber Co., St. Louis, Mo.  
Beider, Francis, & Co., Chicago.  
Berthold & Jennings, St. Louis, Mo.  
Churchill Cedar Co., Spokane, Wash.  
Humbird Lumber Co., Sand Point, Idaho.  
Lindsay Bros. Co., Spokane, Wash.  
National Pole Co., Escanaba, Mich.  
Naugle Pole & Tie Co., 226 La Salle St., Chicago.  
Pacific Coast Pole Co., Spokane, Wash.  
S-E. Missouri Cypress Co., Campbell, Mo.  
Westcoast, C. H., Co., Tribune Bldg., Chicago.
- Punches—(See Ticket Punches).**
- Rail Benders.**  
Electric Service Supplies Co., 200 Plymouth Bldg., Chicago.  
Fairbanks, Morse & Co., Chicago.
- Rail Bonds—(See Bonds, Rail).**
- Rail Bonds, Flexible.**  
Chase-Shawmut Co., Newburyport, Mass.
- Rail Drills—(See Drills, Track).**
- Rail Feed Wire—(See Wire and Cables).**
- Rail Joints and Chairs—(See Joints, Rail).**
- Rails, New.**  
New York Switch & Crossing Co., Hoboken, N. J.  
Wharton, Wm., Jr., & Co., Philadelphia.
- Railway Velocipedes.**  
Fairbanks, Morse & Co., Chicago.  
Kalamazoo Railway Supply Co., Kalamazoo, Mich.
- Registers and Fittings—(See Fare Registers).**
- Relays.**  
Weston Electrical Instrument Co., Newark, N. J.
- Roofing.**  
Johns-Manville, H. W., Co., New York.
- Sand Apparatus.**  
American Car Co., St. Louis.  
Brill, J. G., Co., Philadelphia.  
Electric Service Supplies Co., 200 Plymouth Bldg., Chicago.



***The Conductor is always on the rear platform of the Pay-As-You-Enter Car***

It is the business office of the company, where fares are paid before passengers enter and immediately received for by fare register. ¶ The conductor's constant presence on the platform totally eliminates that large and constantly increasing class of accidents arising from the starting of cars while passengers are in the act of boarding.

¶ Thus, you see, the Pay-As-You-Enter Car works two ways

- it insures the collection of all the revenue to which the company is entitled
- it conserves this revenue by eliminating a prolific source of damage claims

We license manufacturers and railways to build and use the Pay-As-You-Enter Car, the patents on which are owned by

**The Pay-As-You-Enter Car Company**

DUNCAN McDONALD  
President 50 Church Street, New York

THOS. W. CASEY  
Manager

## CLASSIFIED LIST OF ADVERTISERS—Continued.

- Sand Apparatus—Continued.**  
Kuhlman, G. C., Car Co., Cleveland.  
Marshall, R. W., & Co., 95 Liberty St., New York.  
Ohio Brass Co., Mansfield, O.  
St. Louis Car Co., St. Louis.  
Stephenson, John, Co., Elizabeth, N. J.  
Wason Mfg. Co., Springfield, Mass.
- Sash Balances and Fixtures.**  
National Lock Washer Co., Newark, N. J.
- Sash Operating Devices.**  
Drouvé, G. Co., Bridgeport, Conn.  
Lord & Burnham, Irvington-on-Hudson, New York.
- Seats, Car—(See Car Seats).**
- Shade Rollers—(See Curtains, Fixtures and Materials).**
- Signals.**  
Telegraph Signal Co., Rochester, N. Y.
- Signal Supplies.**  
Railway Specialty & Supply Co., Chicago.
- Skylights.**  
Drouvé, G. Co., Bridgeport, Conn.  
Lord & Burnham, Irvington-on-Hudson, New York.
- Snow Plows, Sweepers and Scrapers.**  
American Car Co., St. Louis.  
Brill, J. G. Co., Philadelphia.  
Kalamazoo Railway Supply Co., Kalamazoo, Mich.  
Kuhlman, G. C., Car Co., Cleveland.  
McGuire-Cummings Mfg. Co., Chicago.  
Russell Car & Snow-Plow Co., Ridgway, Pa.  
Stephenson, John, Co., Elizabeth, N. J.  
Wason Mfg. Co., Springfield, Mass.
- Sockets, Waterproof.**  
Johns-Manville, H. W. Co., New York.
- Solder Paste.**  
Chase-Shawmut Co., Newburyport, Mass.
- Springs.**  
American Car Co., St. Louis.  
Brill, J. G. Co., Philadelphia.  
Kuhlman, G. C., Car Co., Cleveland.  
McGuire-Cummings Mfg. Co., Chicago.  
Marshall, R. W., & Co., 95 Liberty St., New York.  
Railway Steel-Spring Co., 11 Broadway, New York.  
St. Louis Car Co., St. Louis.  
Standard Steel Works Co., Philadelphia, Pa.  
Stephenson, John, Co., Elizabeth, N. J.  
Wason Mfg. Co., Springfield, Mass.
- Sprinkling Cars.**  
American Car Co., St. Louis.  
Brill, J. G. Co., Philadelphia.  
Kuhlman, G. C., Car Co., Cleveland.  
McGuire-Cummings Mfg. Co., Chicago.  
Stephenson, John, Co., Elizabeth, N. J.  
Wason Mfg. Co., Springfield, Mass.
- Stage Pockets and Plugs.**  
Chase-Shawmut Co., Newburyport, Mass.
- Steam Fittings, Etc.**  
Crane Co., Chicago.  
Davis, John, Co., Chicago.  
National Tube Co., Philadelphia, Pa.  
Power Specialty Co., 111 Broadway, New York.  
Simmons, John, Co., 110 Centre St., New York.
- Steel Cars.**  
American Car Co., St. Louis.  
Brill, J. G. Co., Philadelphia.  
Kuhlman, G. C., Car Co., Cleveland.  
St. Louis Car Co., St. Louis.  
Stephenson, John, Co., Elizabeth, N. J.  
Wason Mfg. Co., Springfield, Mass.
- Steel Tapes.**  
Lufkin Rule Co., Saginaw.
- Stokers.**  
Babcock & Wilcox Co., 85 Liberty St., New York.  
Green Engineering Co., Com'l Nat. Bk. Bldg., Chicago.  
Model Stoker Co., Dayton, O.  
Westinghouse Machine Co., Pittsburg.
- Superheaters.**  
Power Specialty Co., 111 Broadway, New York.
- Switches, Frogs and Crossings.**  
Barbour-Stockwell Co., Cambridgeport, Mass.  
Cleveland Frog & Crossing Co., Cleveland, O.  
Fairbanks, Morse & Co., Chicago.  
Morden Frog & Crossing Co., Rookery, Chicago.  
New York Switch & Crossing Co., Hoboken, N. J.  
Railway Specialty & Supply Co., Chicago.  
Whitson, Wm., Jr., & Co., Philadelphia.
- Switchboards and Switchboard Instruments.**  
Anderson, A. & J. M., Mfg. Co., Boston.  
Chase-Shawmut Co., Newburyport, Mass.  
General Electric Co., Schenectady, N. Y.  
Western Electric Co., Chicago.  
Westinghouse Electric & Mfg. Co., Pittsburg.  
Weston Electrical Instrument Co., Newark, N. J.
- Tapes and Webbing.**  
Johns-Manville, H. W. Co., New York.  
Okonite Co., Ltd., 253 Broadway, New York.
- Testing Instruments.**  
Queen & Co., Philadelphia.  
Weston Electrical Instrument Co., Newark, N. J.
- Test Lamps, Pocket.**  
Chase-Shawmut Co., Newburyport, Mass.
- Ticket Choppers and Destroyers.**  
Patten, Paul B., Salem, Mass.
- Ticket Punches.**  
Meyers, Fred J., Mfg. Co., Hamilton, O.  
Woodman Mfg. & Sup. Co., Boston.
- Ties and Poles, Wood—(See Poles and Ties).**
- Timber.**  
Beidler, Francis, & Co., Chicago.  
Lindsay Bros. Co., Spokane, Wash.  
S-E Missouri Cypress Co., Campbell, Mo.
- Track Cleaners and Scrapers.**  
American Car Co., St. Louis.  
Brill, J. G. Co., Philadelphia.
- Track Cleaners and Scrapers—Continued.**  
Kalamazoo Railway Supply Co., Kalamazoo, Mich.  
Kuhlman, G. C., Car Co., Cleveland.  
McGuire-Cummings Mfg. Co., Chicago.  
Marshall, R. W., & Co., 95 Liberty St., New York.  
Ohio Brass Co., Mansfield, O.  
Stephenson, John, Co., Elizabeth, N. J.  
Van Dorn & Dutton Co., Cleveland, O.  
Wason Mfg. Co., Springfield, Mass.
- Track Drills—(See Drills, Track).**
- Tracklaying Machinery.**  
Holman, D. F., Ry. Tracklayer Co., 1102 Ellsworth Bldg., Chicago.
- Track Tools.**  
Electric Service Supplies Co., 200 Plymouth Bldg., Chicago.  
Kalamazoo Railway Supply Co., Kalamazoo, Mich.
- Trimmings, Car.**  
American Car Co., St. Louis.  
Brill, J. G. Co., Philadelphia.  
Curtain Supply Co., Park Row Bldg., New York.  
Kuhlman, G. C., Car Co., Cleveland.  
National Lock Washer Co., Newark, N. J.  
St. Louis Car Co., St. Louis.  
Stephenson, John, Co., Elizabeth, N. J.  
Wason Mfg. Co., Springfield, Mass.
- Trolley Guards.**  
Automatic Trolley Guard Co., 391 Elliott Sq., Buffalo, N. Y.  
Electric Service Supplies Co., 200 Plymouth Bldg., Chicago.
- Trolley Poles and Fittings.**  
Garford Company, Elyria, O.  
General Electric Co., Schenectady, N. Y.  
Johns-Manville, H. W. Co., New York.  
Humphrey Trolley & Mfg. Co., 725 Chamber of Commerce Bldg., Detroit, Mich.  
Marshall, R. W., & Co., 95 Liberty St., New York.  
Nuttall, R. D. Co., Pittsburg.  
Star Brass Works, Kalamazoo, Mich.  
Trolley Supply Co., Canton, O.  
Westinghouse Electric & Mfg. Co., Pittsburg, Pa.
- Trolley Retrievers and Catchers.**  
Electric Service Supplies Co., 1020-24 Filbert St., Phila.  
Trolley Supply Co., Canton, O.
- Trolley Wagons.**  
Kalamazoo Railway Supply Co., Kalamazoo, Mich.
- Trolley Wheels—(See Trolley Poles and Fittings).**
- Trolley Wire—(See Wire and Cables).**
- Trucks, Car.**  
American Car Co., St. Louis.  
Baldwin Locomotive Works, Philadelphia.  
Brill, J. G. Co., Philadelphia.  
Kuhlman, G. C., Car Co., Cleveland.  
McGuire-Cummings Mfg. Co., Chicago.  
St. Louis Car Co., St. Louis.  
Standard Motor Truck Co., Pittsburg, Pa.  
Stephenson, John, Co., Elizabeth, N. J.  
Van Dorn & Dutton Co., Cleveland, O.
- Trucks, Car—Continued.**  
Wason Mfg. Co., Springfield, Mass.
- Turbines.**  
General Electric Co., Schenectady, N. Y.  
Westinghouse Machine Co., Pittsburg, Pa.
- Union Couplings.**  
National Tube Co., Pittsburg, Pa.
- Valves—(See Steam Fittings).**
- Varnish.**  
Electric Service Supplies Co., 200 Plymouth Bldg., Chicago.  
Standard Paint Co., 100 William St., New York.
- Ventilators.**  
Drouvé, G. Co., Bridgeport, Conn.  
Lord & Burnham, Irvington-on-Hudson, N. Y.
- Vestlettes.**  
Bellamy Vestlette Mfg. Co., Cleveland, O.
- Waste, Cotton and Wool.**  
Hagy, J. Milton, Waste Wks., Philadelphia, Pa.  
Railway Specialty & Supply Co., Chicago.
- Water Softening Compounds.**  
Dearborn Drug & Chemical Works, Chicago.
- Wheels and Axles.**  
American Car Co., St. Louis.  
Brill, J. G. Co., Philadelphia.  
Griffin Wheel Co., Chicago.  
Kuhlman, G. C., Car Co., Cleveland.  
McGuire-Cummings Mfg. Co., Chicago.  
Marshall, R. W., & Co., 95 Liberty St., New York.  
Railway Steel-Spring Co., New York.  
St. Louis Car Co., St. Louis.  
St. Louis Car Wheel Co., St. Louis.  
Standard Steel Works Co., Philadelphia, Pa.  
Stephenson, John, Co., Elizabeth, N. J.  
Wason Mfg. Co., Springfield, Mass.
- Window Fixtures.**  
Drouvé, G. Co., Bridgeport, Conn.
- Wiping Rags.**  
Hagy, J. Milton, Waste Wks., Philadelphia, Pa.
- Wire, Aluminum.**  
Aluminum Co. of America, Pittsburg, Pa.
- Wire, Insulated.**  
Aluminum Co. of America, Pittsburg, Pa.  
American Electrical Works, Providence, R. I.  
General Electric Co., Schenectady, N. Y.  
Okonite Co., Ltd., 253 Broadway, New York.  
Standard Underground Cable Co., Pittsburg, Pa.  
Stuart-Howland Co., Boston.
- Wire and Cables.**  
Aluminum Co. of America, Pittsburg, Pa.  
American Electrical Works, Providence, R. I.  
Bridgeport Brass Co., Bridgeport, Conn.  
General Electric Co., Schenectady, N. Y.  
Okonite Co., Ltd., 253 Broadway, New York.  
Standard Underground Cable Co., Pittsburg, Pa.

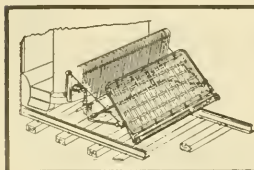

## ECLIPSE Life Guard

Manufactured by the  
ECLIPSE RAILWAY SUPPLY CO.  
Cleveland, Ohio

You buy and scrap 25 per cent less material when you use  
**Ideal Trolley Wheels!**

Unlike the cast wheels you have used in many other important particulars, too. Write for detailed description.

Buffalo **LUMEN BEARING CO.** Toronto

**STANDARD HIGH-SPEED "INTERBOROUGH" DOUBLE TRUCK**

TYPE C-60

**"Solid Forged"**

WITHOUT WELDS

FRAMES ARE MADE FROM ROLLED OPEN-HEARTH STEEL WITHOUT WELDS. ALL WEARING BOLTS ARE TURNED AND CASE HARDENED, AND WEARING HOLES STEEL THIMBLED. M. C. B. STANDARD PRINCIPLES ARE FOLLOWED. WE ARE PREPARED TO BUILD TRUCKS IN ACCORDANCE WITH PURCHASER'S DESIGNS AND SPECIFICATIONS.

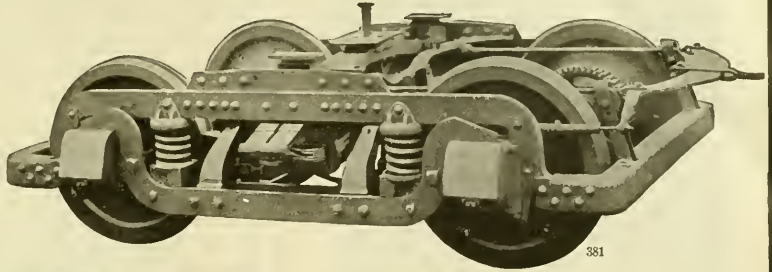

381

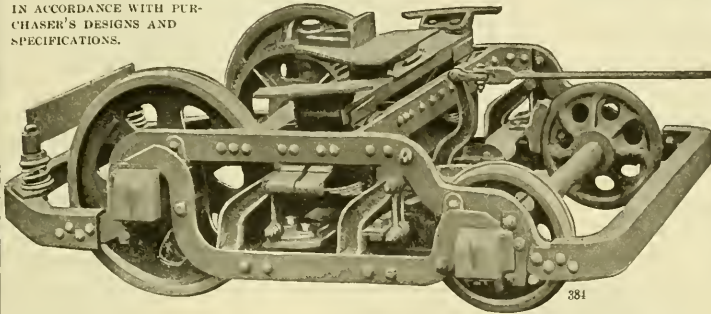

381

**STANDARD  
"MAXIMUM  
TRACTION"  
DOUBLE TRUCK**

**CITY AND SUBURBAN  
TYPE O-45**

OVER TWO HUNDRED OF THESE "MAXIMUM TRACTION" TRUCKS ARE IN SERVICE IN BROOKLYN, NEW YORK, AND ARE PRONOUNCED "HIGHLY SATISFACTORY."

**STANDARD MOTOR TRUCK COMPANY, FRICK BUILDING, PITTSBURGH, PENNSYLVANIA**  
 NEW YORK OFFICE: 170 BROADWAY      WORKS: NEW CASTLE, PA.      CHICAGO OFFICE: FISHER BUILDING

**THE BABCOCK & WILCOX COMPANY**

85 Liberty Street, New York

Babcock & Wilcox ——— Stirling ——— A & T Horizontal ——— Cahall Vertical

**WATER TUBE STEAM BOILERS**

STEAM SUPERHEATERS

Works: Bayonne, N. J.    Barberton, Ohio.

MECHANICAL STOKERS

BRANCH OFFICES:

BOSTON, Delta Bldg.  
 PHILADELPHIA, 110-1112 North American Bldg.  
 SAN FRANCISCO, 63 First Street  
 PITTSBURGH, Farmers Deposit Nat. Bank Bldg.  
 NEW ORLEANS, 343 Baronne St.

DENVER, 410 Seventeenth St.  
 SALT LAKE CITY, 313 Adas Block  
 WASHINGTON, Colorado Building  
 CHICAGO, Marquette Bldg.  
 ATLANTA, GA., 1132 Candler Bldg.

CLEVELAND, 706 New England Bldg.  
 MEXICO CITY, 7 Avenida, Juarez  
 HAVANA, CUBA, 116 1/2 Calle de la Habana  
 LOS ANGELES, 321 Trust Bldg.  
 CINCINNATI, O., Traction Bldg.

Waste for Electric Railway Service

**G E Motor Packing Waste**

Free from dirt and grit. Easy to pack. All long strands. Good absorber. One packing of the journal box will last longer than with the ordinary waste.

**WIPING WASTE**

White and colored sanitary cleaned wiping rags. Samples submitted.

**The J. Milton Hagy Waste Works**  
 433 Spruce St.      INCORPORATED      Philadelphia

**ALUMINUM**

**Railway Feeders**

And all kinds of **Electrical Conductors**

Aluminum Feeders are less than one-half the weight of copper feeders and are of equal conductivity and strength. If insulated wire or cable is required, high grade insulation is guaranteed.

Write for prices and full information.

**Aluminum Company of America**  
 PITTSBURGH, PA.

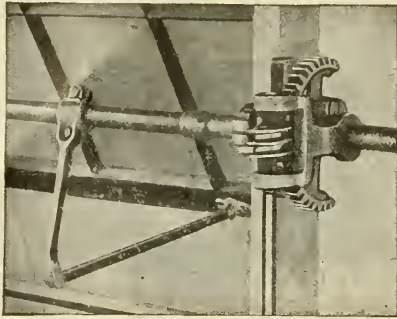

## The Ventilation

of your Shops, Foundries and Car Barns is made especially effective by a speedy, positive and easily manipulated **Sash Operating Apparatus** which automatically locks the sash at any position.

*Let us send you our catalogue.*

**Lord & Burnham Company**  
Irvington-on-Hudson, N. Y.

**W**HEN a salesman calls on you for the purpose of selling you material or supplies, you expect him to show you how and why it is to your advantage to use his goods.

Is there any reason why you should not use as much care in pointing out to your patrons, or those who should be your patrons, the attractions and advantages of your road and your service as does the successful salesman in presenting the strong points of his goods?

The Van Valkenburgh Advertising Service applies the methods of the successful salesman in calling the attention of the public to your commodity—transportation.

Let's get together.



**E. C. Van Valkenburgh**  
Promotional Advertising  
for Electric Railways  
2117 West 102d Street, Chicago

THE RAILWAY SPECIALTY  
AND SUPPLY CO.

## TRACK BOLTS

Great Northern Building  
CHICAGO

**THE NATIONAL LOCK WASHER CO.,** NEWARK, N. J.  
Curtains - Curtain Fixtures - Sash Locks - Sash Balances - Nut Locks  
CHICAGO OFFICE: 419 MONADNOCK BLOCK

## FOSTER SUPERHEATERS

INSURE UNIFORM SUPERHEAT OF TEMPERATURE SPECIFIED.

**POWER SPECIALTY COMPANY**  
111 Broadway, New York

Specify the Genuine Roller. It is that Element that makes a Car Curtain a Success.



Special Car Rollers are made. Brackets are made for all classes of fittings.  
Used all over the world wherever cars are run.

Every Genuine Roller has the Name of Manufacturer

**STEWART HARTSHORN**  
IN SCRIPT ON LABEL

**STEWART HARTSHORN CO.**

Office and Factory, E. NEWARK, N. J.  
NEW YORK, 382 Lafayette St. CHICAGO, 338-344 Wabash Ave.

**FOUNDRIES**  
CHICAGO DETROIT  
DENVER ST. PAUL  
TACOMA BOSTON  
KANSAS CITY  
GENERAL OFFICES  
WESTERN UNION BLDG.  
CHICAGO

**GRIFFIN WHEEL COMPANY**  
CHILLED IRON  
**Car Wheels**  
OF EVERY DESCRIPTION  
FOR ALL CLASSES OF SERVICE  
IRON OR STEEL AXLES. REFITTING A SPECIALTY

# U.S. Metal & Mfg. Co.

City Investing Building, 165 Broadway, New York

Pittsburg, 1509 Arrott Bldg. Chicago, 414 Railway Exchange

## Columbia Lock Nuts

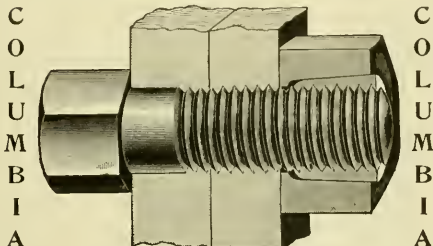

Columbia Lock Nut on Bolt

It is effective and indispensable on locomotives, pitmans, wrists, king bolts, rail joints, fish plates, piston rods, cylinder heads, steam pumps, and, in fact, all kinds of machinery. It is also invaluable on railroad cars, carriages, wagons, automobiles, axles, steam pipes, flanges, etc.

SEND FOR CATALOG AND PRICE LIST

# RAIL BOND Maintenance.

The SEMI-PLASTIC PLUG RAIL BOND is applied on either Girder or T Rail without disturbing the pavement or removing the angle plates.

The condition of the Bond can be determined by a track walker from its appearance.

Its conductivity is 900,000 c. m., which can be maintained at a trifling expense without removing Bond.

Cheaper in first cost than No. 4/0 copper bond and more easily applied.

Write for details.

**HAROLD P. BROWN,**  
120 Liberty Street, New York, N. Y.

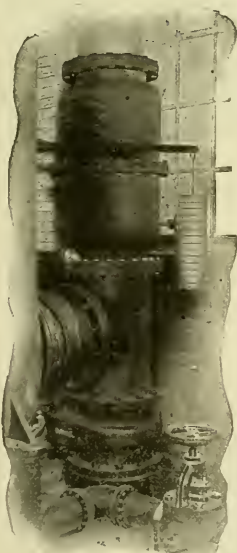

This 14-inch Hochfeldt Eclipse Combination Back Pressure and Relief Valve was installed three years ago in the boiler plant of the Chicago City Railway, located at 77th and Vincennes Road, and is operating with best results.

## THE JOHN DAVIS COMPANY

Halsted, 22nd and Union Sts.  
CHICAGO

W. G. Ruggles Co., Boston  
Central Supply Co., Indianapolis, Ind.  
J. A. Roe & Co., Detroit, Mich.  
Jas. H. Pearson, 121 Centre St., New York

Western Valve Co., St. Louis  
Robert B. Orr Engineering Co., Kansas City, Mo.  
A. M. Lockett Co., New Orleans, La.

# Electric Railway Lubrication

THE same skillful expert supervision given in this service as in steam railway service has produced most satisfactory results. Lower cost of lubrication with better service.

Including both Rolling Stock and Power House Equipment

We are under contract with many of the largest Street and Interurban railways in the country.

We guarantee cost per thousand miles in Street and Electric Railway Service when conditions warrant it.

Write for further particulars.

**Galena-Signal Oil Company**  
FRANKLIN, PENNSYLVANIA

**THE ARNOLD COMPANY**  
 ENGINEERS-CONSTRUCTORS  
 ELECTRICAL - CIVIL - MECHANICAL  
 161 LA SALLE STREET  
 CHICAGO

**H. M. Bylesby & Company**  
 Incorporated  
 ENGINEERS  
 American Trust Bldg., Chicago  
 Design, Construct and Operate  
 Railway, Light, Power and  
 Hydraulic Plants  
 EXAMINATIONS AND  
 REPORTS

**J. G. WHITE & COMPANY**  
 INCORPORATED  
**Engineers, Contractors**  
 43-49 Exchange Place,  
 41-43 Wall Street  
 New York, N. Y.  
 Principal Philippine Office: Manila, P. I.

**Ford, Bacon & Davis,**  
 Engineers,  
 115 BROADWAY,  
 NEW YORK.

**Complete Plants for the Rapid  
 Handling of Material**  
 Every Sort of Hoisting Apparatus  
 BROWN HOISTING MACHINERY CO. Cleveland, Ohio

**VALVES—FITTINGS—STEAM SPECIALTIES**  
**CRANE CO.**  
 CHICAGO  
 ESTABLISHED 1855

**E. SAXTON**  
**CONTRACTOR**  
 SPECIALTIES:  
**CONDUIT ELECTRIC RAILWAYS**  
**TROLLEY LINES**  
 CITY AND SUBURBAN  
**CONDUIT SYSTEMS, Etc.**  
 OFFICE, 841 BLADENSBURG ROAD, WASHINGTON, D. C.  
 Long Distance Telephone, East 887

**A. L. REGISTER & CO.**  
 Engineers and General Contractors—Electric Railways  
 112 North Broad St. PHILADELPHIA, PA. Established 1889

**CENTRAL INSPECTION BUREAU**  
 Inspection of Rails, Ties, Cars, Motors, Bridges, Buildings, Etc.  
 17 STATE STREET - - - - NEW YORK CITY

**LINE MATERIAL**  
 ELECTRIC SUPPLIES FOR RAILWAYS, POWER PLANTS, ETC.  
 THE CREEHEAD ENGINEERING CO., 346 Main Street, Cincinnati, Ohio

**THE CURTAIN SUPPLY CO.**  
 CAR CURTAINS  
 CHICAGO, 85-83 Ohio Street Hudson Terminal, 50 Church St., NEW YORK

**AUTOMATIC TROLLEY GUARD CO.**  
 61-69 Carroll St., Buffalo, N. Y.  
 "IT PUTS THE WHEEL ON THE WIRE" <sup>3</sup>

**HOT WATER HEATERS FOR CARS**  
 THE PETER SMITH HEATER COMPANY, Detroit, Mich.

**GEARS AND PINIONS**  
 FOR ALL TYPES OF MOTORS  
 THE VAN DORN & DUTTON CO., CLEVELAND, OHIO

**RE-ENFORCED SPOKE WHEELS**  
 For City and Suburban Cars  
**ST. LOUIS CAR WHEEL CO., St. Louis, Mo.**

**HART CONVERTIBLE CAR**  
 BALLAST, CONDOLA AND CONSTRUCTION  
 RODGER BALLAST CAR CO., Railway Exchange, CHICAGO

**BRAKESHOES**  
 STANDARD  
 BRAKESHOE COMPANY  
 GEN'L OFFICES & WORKS—AURORA, ILL.—CHICAGO OFFICE 30 RY EXCH.

**ELECTRIC HEATERS** For All Classes of Cars  
 New York Consolidated Car-Heating Co. Chicago

WRITE TO **MODEL STOKER COMPANY** DAYTON OHIO  
 for detailed information about the best  
**AUTOMATIC SMOKELESS FURNACE**

**GREEN TRAVELING LINK GRATES**

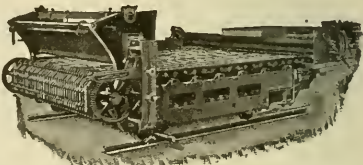

Highest Capacity  
 Highest Efficiency  
 Automatic Smokeless  
 Labor Saving  
 Cheap Fuel

**GREEN ENGINEERING CO.**  
 Main Office: Commercial National Bank Bldg., Chicago, Ill.  
 BRANCH OFFICES: Pittsburgh : St. Louis : St. Paul : Louisville  
 General Foundry Work a Specialty



THE  
**SYMINGTON JOURNAL BOX**  
 IS NOW STANDARD

ON 95 PER CENT OF ALL MODERN ELECTRIC TRUCKS

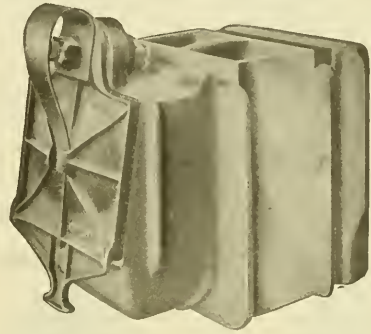
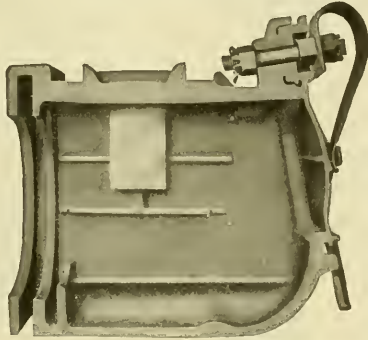

**Special Notice!**

WE ARE PREPARED TO FURNISH AT ONCE

**REPAIR BOXES**

FOR ANY MAKE OF TRUCK IN SERVICE

BALTIMORE  
MD.

**THE T. H. SYMINGTON CO.**

CHICAGO  
ILL.

**TUBULAR POLES**  
 IRON OR STEEL



FOR  
 ELECTRIC RAILWAYS  
 ELECTRIC LIGHTING CO'S  
 SIGNAL )  
 TELEPHONE )  
 TELEGRAPH )  
 TRANSMISSION L I N E S  
 AND CATENARY )  
 SUSPENSION )  
 L I N E S

**ELECTRIC RAILWAY EQUIPMENT CO.**  
 General Office: CINCINNATI-O-U-S-A  
 Shops: READING PA - WHEELING WVA

**STOP THIEF!**

That is what our  
 NEW BOND GUARD DOES



**Why Not Try Some**

WHERE YOU HAVE TROUBLE  
 WITH THEFT OF BONDS?

*At Least Send for Literature*

**CHASE-SHAWMUT CO.**

Newburyport, Mass.

## Baldwin Locomotive Works

BURNHAM, WILLIAMS & CO., PHILADELPHIA, PA., U. S. A.

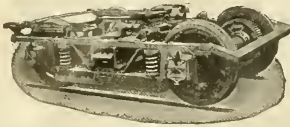

Builders of  
**LOCOMOTIVES**  
of every description  
including  
**ELECTRIC  
LOCOMOTIVES**

**ELECTRIC TRUCKS**

## Standard Steel Works Co.

HARRISON BLDG., PHILA., PA., U. S. A.

New York, N. Y. Cleveland, O. St. Louis, Mo. Denver, Colo.  
Portland, Ore. Richmond, Va. Chicago, Ill. St. Paul, Minn.  
San Francisco, Cal. Seattle, Wash. Winnipeg, Can.

**Solid Forged  
Rolled and Steel Tired Wheels**

Mounted on axles fitted with Motor Gears  
for Electric Railway Service.

**LOCOMOTIVE TIRES RAILWAY SPRINGS  
FORGINGS CASTINGS**



# MORDEN FROG & CROSSING WORKS

Manufacturers of

**STREET RAILWAY SPECIAL TRACK WORK**

Manganese Special Work, Tongue and Split Switches, Mates  
Frogs, Crossings, Switch Stands, Rail Braces, Etc.

823 Commercial National Bank Building, Chicago :: :: Works: Chicago Heights



CONTINUOUS JOINT

Over  
25,000  
miles  
in use



WEBER JOINT

Rolled  
from  
Best Quality  
Steel



WOLHAUPTER JOINT

Catalogs at Agencies  
Baltimore, Md. Portland, Ore.  
Boston, Mass. Seattle, Wash.  
Chicago, Ill. St. Paul, Minn.  
Denver, Colo. St. Louis, Mo.  
Pittsburg, Pa. Troy, N. Y.  
London, Eng. Montreal, Can.

HIGHEST AWARDS—Paris, 1900;  
Buffalo, 1901; St. Louis, 1904

Additional safety and economy in Track Maintenance has been proved by the use of Continuous, Weber and Wolhaupter base-supported rail joints—after ten (10) years' service, having a record of over 25,000 miles in use—the extent of which is evidence of their excellence.

## THE RAIL JOINT COMPANY

General Offices: 29 West 34th Street, New York City  
Makers of Rail Joints for Standard and Special Rail Sections, also  
Girders, Step or Compromise, and Insulating Rail Joints, protected by  
patents in United States and Foreign Countries.

# WHARTON SPECIAL TRACK WORK

**MANGANESE  
STEEL  
TRACK WORK  
IS OUR SPECIALTY**

**OF EVERY DESCRIPTION  
FOR ALL CLASSES OF SERVICE**

**WM. WHARTON JR. & CO.  
INCORPORATED,  
PHILADELPHIA, PA. JENKINTOWN, PA.**

# The Cleveland Frog & Crossing Co.

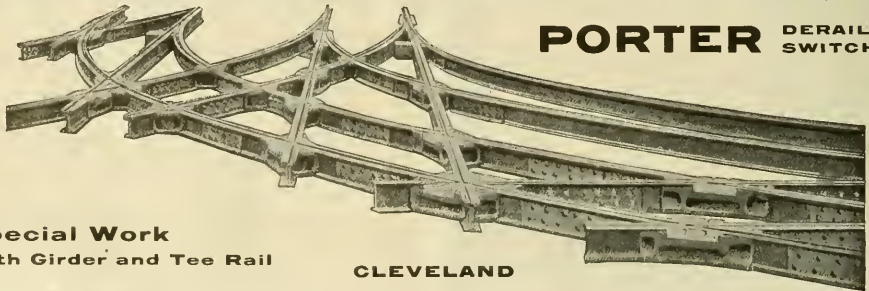

**PORTER DERAILING SWITCHES**

**Special Work  
Both Girder and Tee Rail**

**CLEVELAND**

# FOR SALE. FOR QUICK DELIVERY

## 6 55-ft. Passenger, Baggage and Smoking Car Bodies

Main Compartment 26' 0"  
 Smoking " 10' 6"  
 Baggage " 10' 0"  
 Seating Capacity, 54

## 8 60-ft. Passenger, Baggage and Smoking Car Bodies

Main Compartment 28' 6"  
 Smoking " 11' 0"  
 Baggage " 8' 0"  
 Seating Capacity, 58

## 5 52-ft. Passenger and Smoking Car Bodies — Double End

Seating Capacity, 60

## 3 52-ft. Passenger and Baggage Car Bodies — Double End

Seating Capacity, 56

## 2 50-ft. Express Car Bodies

*Write or wire us for further information.*

# The Jewett Car Co. Newark Ohio

### THE MIGHTY MIDGET

## HOT WATER CAR HEATER

Adapted for Large Electric Cars and Long Distance Lines. Exclusively used on Largest Electric Systems. Ask for Catalog

THE WILLIAM C. BAKER HEATING & SUPPLY CO., 143 LIBERTY STREET NEW YORK

## NILES CARS — THE ELECTRIC PULLMANS

LARGE, FAST INTERURBANS  
 OUR SPECIALTY

## NILES CAR & MFG. COMPANY

WORKS: NILES, OHIO

Sales Office:  
 J. A. HANNA CO., 312 Electric Bldg., Cleveland, O.



## Car Bodies

OF ALL TYPES

## Trucks

TO SUIT

Cincinnati Car Co.  
 CINCINNATI, OHIO



Type "Pay-as-you-enter" Cars. 200 Built for The Public Service Railway Company, New Jersey

CAR ADVERTISING

# Barron & Collier

ALMOST EVERYWHERE  
Flat Iron Building, New York.



**OKONITE FEEDER WIRES FOR POWER TRANSMISSION.**

Whether overhead, underground or submarine, successfully meet the most exacting conditions of modern traction systems. Used by the most prominent Street Railways in the country.

**The Standard for Rubber Insulation**  
Samples and Estimates on application

**THE OKONITE CO. Ltd.,** 253 Broadway, NEW YORK  
GEORGE T. MANSON, Gen'l Supt.; W. H. HODGINS, Secretary.

WILLARD L. CANDEE, H. DURANT CHEEVER, Managers

## The Lindsley Brothers Company

Producers and Shippers of and Manufacturers of

**WESTERN CEDAR POLES** **RED FIR CROSS ARMS**

Eastern Sales Office, Monadnock Bldg., CHICAGO SPOKANE, WASHINGTON

**G. H. BARNES HARDWOOD LUMBER CO.**  
Office and Yard: Main and Warren Sts., ST. LOUIS, MO.  
Ties, Car Oak, Poplar, Ash, Cherry, Plain and Quartered Oak

**TRACKLAYING BY MACHINERY**  
SIMPLE, RAPID AND ECONOMICAL  
D. F. HOLMAN RAILWAY TRACKLAYER CO., 1102 Ellsworth Bldg., Chicago

**POLES and PILING**  
20,000 35s and 40s  
Ready to Ship at Once  
S-E. Missouri Cypress Co., Campbell, Mo.

**Shelby Trolley Poles**  
Made from Cold Drawn Seamless Steel Tubing.  
Immediate delivery all sizes from stock.  
The Garford Company : Elyria, O.

**Idaho Cedar Poles**

---

PACIFIC COAST POLE CO. SPOKANE, WASH.

**Poles and Ties**  
A Selected Stock in Chicago for Rush Shipment  
A Number of Large Yards in the North  
**NAUGLE POLE & TIE CO.**  
CHICAGO OFFICE: 226 LA SALLE STREET

We are Producers and Wholesale Dealers in Western

**CEDAR POLES**

Yards in Washington, Idaho, Montana and British Columbia  
WRITE US FOR DELIVERED PRICES  
**CHURCHILL CEDAR CO.,** Box 1409, Spokane, Wash.

If you want good **POLES** Michigan or Western Cedar  
at the right prices and prompt delivery, write us.  
**NATIONAL POLE COMPANY**  
EVERETT, WASH. ESCANABA, MICH.

**C. H. WORCESTER CO.**

**CEDAR POLES**

PRODUCERS AND WHOLESALERS  
Suite 1710 Tribune Building CHICAGO

**HUMBIRD LUMBER CO., LTD.**

**Cedar Poles and Piling**  
SANDPOINT, IDAHO.

Your gear and pinion cost can be reduced over one-half by lubricating them with

## Whitmore's Gear Protective Composition

We can prove this by roads that are using it. Give us an opportunity to demonstrate the merits of our product.

**The Whitmore Manufacturing Company**  
LUBRICATING ENGINEERS  
Cleveland, Ohio, U. S. A.



Established 1877.



## ALBERT & J. M. ANDERSON MFG. CO.,

Makers of

**ELECTRICAL APPLIANCES:**  
SWITCHES, SWITCHBOARDS,  
TIME SWITCHES, LINE MATERIAL,  
COPPERCASTINGS (75%) CONDUCTIVITY.  
289-293 A ST., BOSTON, MASS., U. S. A.

Branches:

New York, 135 Broadway. Chicago, 175 Dearborn Street.

Agencies:

Boston, Pettigell-Andrews Co. San Francisco, Eccles & Smith Co.  
New York, R. W. Marshall & Co. Atlanta, Newcomer Manry Co.  
St. Louis, J. C. White. Denver, E. M. Messiter.  
Toronto, Ont., H. J. Surtees.



## Pantasote

The National Standard for Car Curtains and Car Upholstery.

### AGOSOTE HEADLINING

The only headlining made in one solid piece. Will not separate, warp or blister. Waterproof and homogeneous.

### THE PANTASOTE COMPANY

707 Fisher Building, Chicago, Ill.

11 Broadway, New York

## Mica Prices Reduced

Compare our prices on Raw Mica and Manufactured Mica with prices you have been paying our competitors

**WHY PAY FANCY PRICES?**

*We do not intend to change or increase our list prices. We do not follow our competitors.*

Chicago Mica Co.

Valparaiso, Ind.

## Queen Testing Sets

"The Recognized Standard"

Voltmeters  
Ammeters  
Switchboard and Portable  
Alternating and Direct Current



Queen Acme Testing Set

U. S. Standard Testing Sets  
Rail Bond Testers  
Galvanometers, etc., etc.  
Electrical Instruments for All Purposes

**QUEEN & CO., Inc., Philadelphia, Pa.**

## WESTON Electrical Instrument Co.

Main Office and Works:

WAVERLY PARK, NEWARK, N. J.



Weston Standard Illuminated Dial Station Voltmeter Model 11

**Illuminated Dial Station Instruments**

SEND FOR NEW CATALOGUE

Berlin—European Weston Electrical Instrument Co., Ritterstrasse, No. 83  
Paris, France—E. H. Cadot, 12 Rue St. Georges  
London—Audrey House, Ely Place, Holborn  
New York Office—74 Cortlandt St.

## Railway Steel-Spring Co.

General Offices: Cortlandt Bldg., 30 Church St., New York

Springs  
Steel-tired Wheels  
Latrobe Motor Wheel Tires

BRANCHES: Chicago, Detroit, Louisville, Mexico City, St. Louis, St. Paul, Washington

Why not cut your packing bill in half?

## STEEL WOOL JOURNAL PACKING

will do this for your road, as it has for many others. It will also save one-third in oil consumption and an appreciable amount of labor and wear. And it prevents hot boxes **positively**.

*If you are open to conviction, send for free sample and test it thoroughly*

**WM. ROBERTSON & COMPANY**

General Office: Great Northern Bldg., CHICAGO  
Factory: 75 S. Jefferson St., BATTLE CREEK, MICH.

# CLASSIFIED ADVERTISEMENTS

Undisplayed advertisements are inserted under this heading at the uniform rate of one cent a word; minimum charge twenty-five cents. Replies directed to this office will be forwarded when required to any address in the United States, Canada or Mexico without extra charge. Advertisements received at the Chicago office by 9 a. m. Thursday will appear in the issue for the same week.

## POSITIONS WANTED.

Wanted—Position as armature winder and mechanic. Ten years' experience. Can furnish good reference. Address "No. 586," care of Electric Railway Review, Chicago.

Want work on right of way, franchises, stock sales, etc. Promoter's right-hand man. Always in harness. Reliable and experienced. Address "No. 585," care of Electric Railway Review, Chicago.

Wanted—To correspond with company needing the services of high-class general manager or general superintendent. Electrical and civil engineer; 17 years' experience with large properties and in construction and operation. Address "No. 568," care of Electric Railway Review, Chicago.

An experienced supply salesman, who also has had thirteen years' operating experience on city lines, desires to form connection with a railway supply house handling either electric or steam supplies or both. Would consider proposition to open sales agency. Address "No. 566," care of Electric Railway Review, Chicago.

## POSITIONS WANTED.

Wanted—Position as superintendent of rolling stock or master mechanic on city or interurban railway. Have satisfactorily handled similar work on large metropolitan properties since horse car days. At liberty now; references exceptional. Address "No. 580," care of Electric Railway Review, Chicago.

Experienced electrical engineer wants position with manufacturing concern or with company operating electric railways. Graduate Purdue University, 1906. Will go anywhere for permanent position. Age 26; married; A No. 1 references as to habits and ability. Address "No. 570," care of Electric Railway Review, Chicago.

Position wanted as auditor and accountant. Sixteen years of steam, electric and general experience; good working knowledge of details of general contracting business; clever buyer; possess ability to organize. Can furnish first-class reference as to character and ability and work accomplished in past; leaving present work because closed; at liberty to accept position, any time. Address "No. 575," care of Electric Railway Review, Chicago.

## POSITIONS OPEN.

General manager wanted for combined electric railway, electric light and gas property, operating 25-mile city and interurban railway located in middle west. Promotion assured for capable man. Must be able to handle relations with public, as well as operate property economically. Address "No. 589," care of Electric Railway Review, Chicago.

## BUSINESS OPPORTUNITIES.

Wanted—To exchange, first mortgage gold bearing 5½ per cent bonds for material for electric railway, issue limited as to amount per mile; right of way held by company in fee simple. Those interested address Chicago Ottumwa & Western Railway, Hamilton, Ia.

Recharging Dry Batteries, the only book ever published giving complete directions of how to prepare chemicals for renewing dry batteries. If you are not more than pleased with this book your dime back. Large electrical catalogue and book postpaid, 10 cents. Adams Electric Co., Dept. E. R., Kewanee, Ill.

## BUSINESS OPPORTUNITIES.

Wanted—Man with some capital and a knowledge of railway track supplies to join the advertiser—a salesman handling locomotive and car supplies—in a general railway supply business. Address "No. 558," care of Electric Railway Review, Chicago.

## BOOKS AND PUBLICATIONS.

Wanted—Copies of the Street Railway Review of April, 1900, May, 1901, and August, 1903. State price and condition. Address "No. 553," care of Electric Railway Review, Chicago.

We want your friends to read the Electric Railway Review. You will do them—and us—a favor by sending their addresses. We will gladly mail free sample copies. Electric Railway Review, 160 Harrison Street, Chicago.

Wanted—Copies of Street Railway Review, January to June, 1906, inclusive, and one copy each January and February, 1906. Also Electric Railway Review for January 5, 1907. State condition and price. Address "No. 552," care of Electric Railway Review, Chicago.

# Interstate Commerce Legislation to Date

is fully covered in our reference pamphlet, including the texts of

( THE INTERSTATE COMMERCE ACT  
THE ELKINS ACT  
THE ACT IN RELATION TO TESTIMONY  
THE EXPEDITION ACT  
THE SHERMAN ANTI-TRUST ACT  
THE SAFETY APPLIANCE ACTS  
THE EMPLOYERS' LIABILITY ACT  
THE HEPBURN ACT )

Difference in type shows the parts expunged from, and the parts added to, the Interstate Commerce and Elkins Acts by the Hepburn Act. ☐ Mailed postpaid for 25 cents in stamps or coin.

Special prices for quantities

The Wilson Company, 160 Harrison Street, Chicago



**R.W. MARSHALL & CO.**  
 50 Church St., New York  
 Second-Hand Machinery and Equipment  
**ELECTRIC RAILWAY MATERIALS**

The Russell Combination Electric Car and Snow-Plow.  
 Remove the noses of your Russell electric combination car and snow-plow and you have an electric locomotive, freight, baggage or express car in one. One investment buys two pieces of equipment. Write us. **RUSSELL CAR & SNOW-PLOW CO.**, Ridgway, Pa. Wendell & MacDuffie, New York; C.A. Ralston, Chicago  
**IS USEFUL ALL THE YEAR ROUND**

**FOR SALE**  
 Baldwin-Westinghouse Electric Trolley Switching Locomotive  
 Weight about 55,000 lbs., gauge 4 ft. 8 1/2 in., 1 motor, 220 volts, diameter of drivers 30 in.  
 Address: "Electric Locomotive" Office of Electric Railway Review 50 Church Street, New York City

**PIPE FITTINGS AND VALVES**  
 FOR THE HEATING AND PLUMBING TRADE  
 TRADE MARK  
**JOHN SIMMONS CO.**  
 104-110 Centre Street, NEW YORK

**FOR SALE: Three Car Bodies and Three Pairs of Double Trucks**  
 with or without electric equipment and air brakes; all new and never used. Compelled to sell, as these cars will not operate over a leased line by reason of their width and length.  
**R. W. MARSHALL & CO., 50 Church St., New York, N. Y.**

**HEINE SAFETY BOILER CO.**  
 421 OLIVE STREET, ST. LOUIS, MO.  
 Manufacturers of WATER TUBE BOILERS

**For Sale** Cards produce results in the Electric Railway Review

**Armstrong Journal Oiler**  
 SAVES OIL SAVES MONEY  
 PREVENTS HOT BOXES



**A Perfect Journal Lubricator**  
 Will last several seasons without renewal, like waste; and can not shake away from the journal. Catalogue and trial sample for the asking.

**Armstrong Oiler Co.**  
 31st and Chestnut Streets - PHILADELPHIA  
**OHIO BRASS COMPANY**  
 MANSFIELD, OHIO Agents West of Pennsylvania

**DESIGNS for ADVERTISING**  **BIRDS EYE VIEWS**

**HALF TONES**  
 Photographing Machinery & Retouching ART PRINTING  
**WOODBURY CARLTON & CO.**  
 WORCESTER, MASS.

Hydraulic Jacks  
 Hydraulic Punches  
 Hydraulic Rail Benders  
 Hydraulic Presses  
 Hydraulic Railroad Tools



Every Tool Thoroughly Guaranteed

**THE WATSON-STILLMAN CO.**  
 50 Church Street, New York City  
 Branch Office: 453 The Rookery, Chicago, Ill.



## SHELBY STREET RAILWAY LAMPS

Filaments double anchored. They stand the knocks and bumps of street railway service. Deliver 50% more light below. We can reduce your lamp bills. Let us tell you about our special lamp for sign and park use. It's a current saver

**THE SHELBY ELECTRIC CO., SHELBY, OHIO**

OFFICES IN ALL PRINCIPAL CITIES

## What Would It Be Worth

to know that your road was positively protected against collisions?

You could easily have the sense of security this knowledge would bring if your road invested in a Telegraph Signal equipment. The installation cost is smaller than you may imagine. One dollar a month per station pays the maintenance—that's mighty cheap safety insurance, isn't it? Ask for the detailed facts, please.

**Telegraph Signal Company, 282 State St., Rochester, N. Y.**



## Many hundreds of roads use Peacock Brakes

as *service brakes* on all cars—because they save time on every trip, and that kind of time means money.

Many other roads use PEACOCK BRAKES as *auxiliary brakes* on heavy cars—because they enable the motorman to maintain the schedule when other brakes fail.

In both services the Peacock Brake is far better than the rest—that's why it is used by so many roads.

## National Brake Co.

888 Ellicott Square  
BUFFALO, N. Y.

Wigmore Bros. Co.  
Pacific Coast Agents  
Los Angeles, Cal.

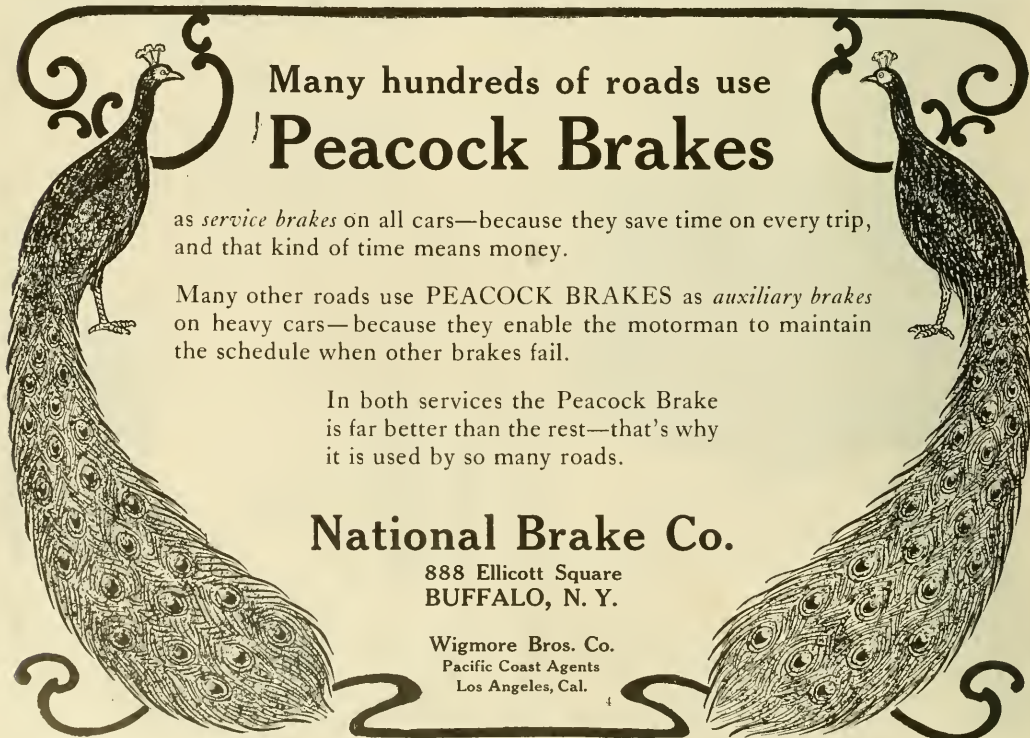



# Electric Railway Review

PUBLISHED EVERY SATURDAY BY THE WILSON COMPANY, CHICAGO

Entered as second-class matter January 5, 1907, at the postoffice at Chicago, Ill., under the act of March 3, 1879.

CHICAGO: 160 Harrison Street  
NEW YORK: 50 Church Street  
CLEVELAND: 1529 Williamson Bldg.

VOL. XIX  
No. 21

CHICAGO, MAY 23, 1908

Whole No.  
265

Subscription: Domestic, \$2.00  
Foreign, 5.00  
Canada, 3.50

The success which attended the offering of \$25,000,000 notes of the Interborough Rapid Transit Company of New York and the announcement of plans of the Public Service Corporation of New Jersey and other companies for financing are signs of awakened interest in the bond market. Idle funds are accumulating rapidly in banks.

The decrease in activity in general business has released so large a volume of money that bankers are finding it difficult now to loan deposits at satisfactory rates of interest. The extent of the increasing volume of idle money in the country is shown by the gradual decline in interest rates, particularly in New York, where money has reached the low rates of  $1\frac{1}{2}$  to 2 per cent on call and  $3\frac{1}{2}$  to 4 per cent on time. Announcement of the plans of larger companies will be followed gradually by the completion of plans of smaller railways for funding floating debt and for raising capital to build extensions which were abandoned on account of the development of acute distress in the business world last October. With the return of public confidence underwriting bankers will buy securities freely. Each day that passes now improves the prospects of sound electric railway properties for raising funds for capital purposes at favorable rates of interest.

One superintendent of equipment attributes his success in obtaining low labor costs for repair work to his following the axiom, "Correct the cause of the trouble and the effect will take care of itself."

**Cause  
and  
Effect.**

These are not the exact words but they convey the correct meaning. The principle in this axiom, of course, is applicable

to any line of work and yet, with the very complicated machines known as electric railway motor cars, it would seem that if the axiom is a good one it could not be applied to any other line of work with more beneficial results than to rolling stock maintenance. It is a quite frequent practice to employ a comparatively large number of men whose duties comprise only the replacing or repairing of parts which have been broken down either accidentally or by continued service. If a little more thorough study and a little bit better application of engineering principles will enable a master mechanic to improve upon the design of or the material in these parts which so frequently need replacing, it is only fair to presume that in this way his existing payroll will remain the same, even though the management considerably increases the number of rolling stock equipments which his same shop must maintain in good operating condition. Results in the shops under the charge of the superintendent earlier referred to illustrate this principle. Five years ago the company operated 185 motor and trailer cars. Today this same company requires for its service 400 cars and all of the motor cars are now equipped with multiple-unit control where, in the earlier days, platform control was used. Even though the total number of equipments has more than doubled and the proportionate number of motor cars has increased in more than a two-to-one ratio, yet the number of men engaged in maintaining and repairing these equipments remains the same. We repeat that the responsible head in charge of this work attributes this result to his practice of teaching the men to ascertain

and repair the causes of defects rather than look only for the cheapest way to renew the parts.

When an important power system installation or modification is carried out under the direction of a firm of consulting engineers, it is the usual practice for all apparatus to be purchased through the organization handling the work as a whole.

**Engineers  
and the  
Purchaser.**

This is the natural outcome of the preparation of plans and specifications in the office of the engineering organization, and the close supervision of the installation of the machinery in the field which the experts retained are expected to give. Repeat orders of standard apparatus parts are, however, often handled through the regular purchasing organization, if the road has one, or if not by the general manager or superintendent acting as purchasing agent. It is an open question if the purchase of supplies cannot sometimes be carried on to advantage through the consulting engineering organization in addition to the purchasing department, in view of the present lack of complete information so often encountered as to the best material or machine for a given purpose. In other words, the purchasing department may need technical co-operation in the buying of certain supplies no less than in securing quotations and recommending acceptances on larger apparatus. The staff of the company may be capable of handling the problem in the best way, but during a period when an experienced firm of engineers is retained there is no doubt that on some occasions their advice would be as valuable in the selection of supplies as it would in the buying of heavy machinery.

The Massachusetts supreme court has declared that the New York New Haven & Hartford Railroad is illegally holding control of trolley lines in Massachusetts, in which it has invested about \$13,000,000.

**Massachusetts  
Electric and  
Steam Roads.**

The effect of this decision is to bring to the front in Massachusetts the problem of trolley line control by steam roads and to demand a prompt determination of the policy of the state in this respect. The number of street railways affected is 16, with \$11,626,200 stock, \$6,360,000 funded debt, \$3,234,004 notes payable and covering altogether 565 miles of track. Fifty-six towns in the state, with an aggregate population of about 240,000, are reached by these lines. The fundamental question involved is the desirability of electric street and interurban railway control by a steam railroad operating in the same territory. In the Berkshire district of Massachusetts it has generally been conceded that the New Haven road's ownership of the trolleys has been of public advantage, resulting in electric service for localities that otherwise could not have supported it for many years. The tendency of the times is toward centralized management of transportation properties. Many of the accepted standards of steam railroads differ radically from those of electric railways, but electrification of the steam roads in certain sections and the march of progress have done much to destroy old-fashioned ideas in each character of service. No steam railroad officials in the country have had better opportunities than those of the New

Haven road to become acquainted with the manner in which the steam road and the trolley system may supplement each other. The Massachusetts legislature should take action upon this question with the least delay consistent with adequate consideration in order that far-reaching plans of the New Haven interests for developing modern transportation facilities in New England may be carried to satisfactory completion.

The revised interstate commerce commission classification of operating expense accounts for electric railways, published in another part of this issue, wisely provides for a maximum of 88 primary accounts. As announced in an earlier issue of the Electric Railway Review, the division of companies has been changed radically from the plan tentatively suggested in Circular No. 20. In accounting for operating expenses, railways will be separated into three classes, and companies with gross annual revenue of less than \$250,000 will be required to keep but 36 primary accounts. The scheme of division in classes according to gross revenue is like that outlined by the New York public service commission, second district, in its classification for electric lighting and gas corporations, and is a fairer recognition of the varying accounting requirements of large and small companies than the plan originally proposed. In preparing a uniform system it is right and just for public service regulating bodies to conform their requirements as closely as possible to a system which, while assuring integrity in accounting, will meet the needs of the practical men to whom the details of application must necessarily be left. In order that such a system of accounting may receive substantially unanimous acceptance, it is essential that there be co-operation between the companies and representatives of the public service commissions. By means of such co-operation the present scheme has been produced. If the details are prepared by similar conference the result should meet with general approval from the companies affected.

Some one has said that few electric railway companies have sufficient detailed knowledge of the life and cost of supplies. This statement probably will apply equally as well to the knowledge of the life and cost of wearing parts of equipments under various conditions of service. There are some good reasons why electric railway companies are not especially well versed in these matters. These reasons may be summarized by saying the expenditure of time and money in keeping records and making tests is hardly justified when there are available the resources of consulting engineers' offices. Generally the data collected by electric railway companies are the results of short tests made on a few cars or machines, and these of special types. Therefore the results are not applicable to electric railways at large, although they are valuable enough for the purpose for which they were collected at the time. The consulting engineer interested in widely scattered properties or the home office of an electric railway syndicate is best able to compile life and cost data which will be valuable as a basis for accurate conclusions made at the time of purchasing supplies. Because of the wider view of the field of operation the consulting engineering organization is frequently in a position to give a valuable opinion as to the fitness of certain supplies for any definite service. The desired result is then obtained, money is saved and the operating company, through the avoidance of needless experimenting and because of closer inspection of quality, is relieved of much unnecessary expense. Also a large consulting engineering organization may find itself able to purchase supplies on a larger scale, dividing them among its clients. Here also a saving will be shown. When the consulting engineer is called upon to advise in the choice of supplies or even buy them, the purchasing depart-

ment of an electric railway still will have work enough to do though its activities may be supplemented with the advice of the engineer.

#### AUTHORITY OF THE INTERSTATE COMMISSION.

In the case now awaiting decision by the interstate commerce commission, involving the 10-cent cash fare charged by the Omaha & Council Bluffs Railway & Bridge Company from Council Bluffs to Omaha, the most important point to be decided touches the authority of the commission to assert jurisdiction over the company.

The Omaha & Council Bluffs Railway & Bridge Company owns a street railway and toll bridge over the Missouri river at Omaha, and a line of street railway beginning at the west end of the bridge in Omaha and extending eastward over the bridge and into Council Bluffs, Ia. The company also owns the stock and bonds of the Omaha & Council Bluffs & Suburban Railway, and owns and operates all the street railway lines in Omaha and in the adjoining municipalities of South Omaha, East Omaha, Florence, Dundee and Benson. The local fare in Council Bluffs or Omaha is 5 cents. The fare from any point in Council Bluffs to any point in Omaha, including the bridge toll, is 10 cents, except for commutation passengers, who receive a 5-cent rate. A toll of 5 cents is paid by foot passengers over the bridge.

It is admitted that the properties concerned are engaged in interstate commerce, but the position of the company is that street railway companies are not railroads within the meaning of the act to regulate commerce. To interpret the term "common carrier," as used in the act, as applicable to street railways, would lead to embarrassments if the commission, in the exercise of its power, attempted to force a street railway to make a connection with a commercial steam railroad and to furnish cars for the transportation of freight. The attitude of members of the commission has been that the act applies in all its phases to both electric and steam railways engaged in interstate transportation of property. The extent of the application of the act is raised definitely in this case and the decision of the commission must take into consideration the vital point of its lawful right of jurisdiction over electric carriers not engaged in freight traffic. It is shown, for instance, that urban interstate street railways may be owned by companies incorporated for the transportation of passengers only, while interurban electric railways may be incorporated under state laws and empowered to carry both passengers and freight. The brief filed by the company before the commission argues with these points for segregation of railways of its class from those which more nearly approach the steam roads in most essential respects except that of the motive power employed. In other instances, where the point of jurisdiction has been brought before the commission the question for decision has been whether the act under which the commission derives its power applied to both steam and electric roads.

In addition to the argument in support of the contention that the commission has not jurisdiction, representatives of the company stated that the evidence did not disclose that either the complainant, the West End Improvement Club of Council Bluffs or its individual members have any interest, directly or indirectly, in having the fare reduced or that they are in any way damaged or inconvenienced by the cash fare. It was shown that 90 per cent of the passengers on the bridge line traveling between the two principal connected cities rode a distance of about five miles for a single fare. The company also submitted that there is no evidence that a reduction in fare would result in increased travel and that no persons living in Council Bluffs refuse to travel on account of the 10-cent fare. Evidence was submitted in relation to the expense of maintenance of the bridge, and to show that it is the custom to charge a 10-cent fare on street

railway lines operating between cities located on opposite sides of the Mississippi and Missouri rivers, in illustration of which there were cited the instances of St. Louis and East St. Louis, St. Paul and Minneapolis and Sioux City and South Sioux City. On two separate bridges connecting Council Bluffs and Omaha, the proprietor steam railways charge 25 cents fare in each instance.

In the hearing of the complaint concerning the 10-cent fare it was shown by the company that the result of a reduction in fares from 10 cents to 5 cents would be a loss in revenue on the bridge line, based upon the number of passengers who paid the higher fare in 1907 of \$102,921. The reduction of fares would therefore be disastrous. The complaint on which the commission has acted appears to be based upon the old theory of a 5-cent fare without scientific investigation of the length or expense or haul or the cost of maintenance and provision for depreciation. The public should be shown in every way possible that a 5-cent fare is not necessarily adequate if provision is to be made for all expenses and if unlimited rides and transfer privileges are bestowed.

#### STANDARDIZATION COMMITTEE MEETING IN PITTSBURG.

The standardization committee of the American Street and Interurban Railway Engineering Association met at the Fort Pitt hotel, Pittsburg, Pa., on May 7, 1908, at 10 o'clock a. m. There were present W. H. Evans, chairman; M. O'Brien, J. M. Larned, H. W. Blake, C. B. Fairchild, Jr., and L. E. Gould; and also by invitation E. Sidney Lewis, Standard Steel Works, Philadelphia, Pa., and F. W. Sargent, American Brake Shoe & Foundry Company, Mahwah, N. J.

The chairman outlined the work for the year as agreed upon at a meeting of the executive committee of the association in New York City on January 30, 1908, when it was decided to take up for the consideration of the committee on standards for this year the subjects of standard height of couplers for city and interurban cars, standard automatic couplers and radial draft rigging for interurban cars, standard height of platforms, standard height of car steps and standard height of bumpers, and such other minor subjects as the committee might decide best.

F. W. Sargent explained in full the drawings which were submitted as standard on brake shoes and brake heads last year, stating that there were no changes whatever in the essential details of the drawings as published in the report of the standardization committee. The drawings simply would supply more explicit detail for the pattern makers to work from, and be a little easier understood. It was understood that these drawings were for the purpose of full-size reproduction in detail, which it is the intention of the committee to have prepared for general circulation.

E. Sidney Lewis advised that there were no changes to suggest in regard to the wheel tread and flanges and other wheel dimensions which were adopted by the committee as standard last year.

The committee will advise the association that it has no changes to suggest in the standards as adopted last year. It will also recommend that the association issue full-size working drawings of all the standards. These should be on sheets of uniform size and lithographed or printed on transparent paper, so that blue prints could be taken from them; these sheets to be for sale by the secretary of the association in connection with such pamphlets or reports of the standardization committee as may contain full explanations of standards as adopted.

Considerable discussion was had regarding the results obtained from sending out data sheets, and just how this work should be handled in order to get the best results. It was considered advisable to have the forthcoming data sheets sent

out, if possible, in connection with the issue of the reprints of the reports of the standardization committee.

The committee was favored with the presence of I. H. Milliken, McConway & Torley Company, Pittsburg, and J. L. Hopper, Washburn Steel Castings & Coupler Company of Minneapolis, Minn. They spoke at some little length regarding automatic couplers, and both agreed that with some slight variations the M. C. B. type of coupler could be made available for interurban car use, both for pulling and pushing, and avoid the trouble previously experienced with M. C. B. couplers, that is, buckling out in pushing around short radius curves. They had no doubt that a satisfactory coupler could be designed for this purpose, which would be thoroughly interchangeable with the so-called M. C. B., or steam road type of coupler.

The committee was unanimously of the opinion that it would be well to send out circular letters to the car builders, coupler companies, step builders and all other manufacturers directly affected, which could give information regarding standard heights of the different parts and any other information bearing upon the subjects considered by the committee this year. In this connection, considerable discussion was had as to the provisions to be made which would prevent interurban cars from passing over city cars on account of the unequal height of the platforms. It was suggested that any plans or devices or information bearing on this subject would be valuable addition to the report of the committee.

Through the courtesy of J. M. Larned, F. Ulenhaut, Jr., and other officials of the Pittsburg Railways Company, the committee was entertained in the evening.

In the second day's sessions the committee discussed the different questions which were shown on the proposed data sheets for this year, and it was decided that it would be well for the committee to take some definite action as to certain dimensions which they would recommend as standards. This, of course, was tentative until the receipt of general information from the data sheets, and until these had been thoroughly discussed. The committee agreed to suggest the following dimensions:

Height of couplers for interurban cars, from top of rail to the center of couplers, 35 inches.

Height of couplers for city cars, from top of rail to the center of couplers, 20 inches.

Height of car steps, from top of rail to first step, 17 inches. From top of first step to top of second step, 14 inches. From top of second step to the top of third step, 10 inches. It is understood that for drop-platform cars the second step of 14 inches will reach the platform, placing the platform 31 inches above the rail, and the third step (from the platform to the floor of the car), 10 inches, placing the floor of the car 41 inches above the rail.

For standard couplers for interurban cars, it was considered that a type of coupler which would be interchangeable with the so-called M. C. B., or steam type of coupler for steam roads, would be the most desirable.

For city cars, owing to the fact that couplers are of different heights, it was considered very difficult to devise an automatic coupler which would successfully operate for these varied conditions; but, if possible, this should be done.

It was decided to call a meeting of the committee at the Clifton hotel, Niagara Falls, Ontario, on Monday, June 29, 1908, at 10 a. m. A delegation is expected, representing the different manufacturers of couplers, car builders and other companies, who will be present for the purpose of giving information bearing on the subjects under consideration by the committee this year.

It was further decided that the committee would meet informally at the same place on Sunday, June 28, 1908, at 2 p. m., to discuss the various data and work of the committee members previous to the regular meeting.

Through the courtesy of J. M. Larned and the Pittsburg Railways Company, the members of the committee and others were given a trolley ride through the manufacturing sections of Pittsburg and to the works of the Westinghouse Electric & Manufacturing Company.

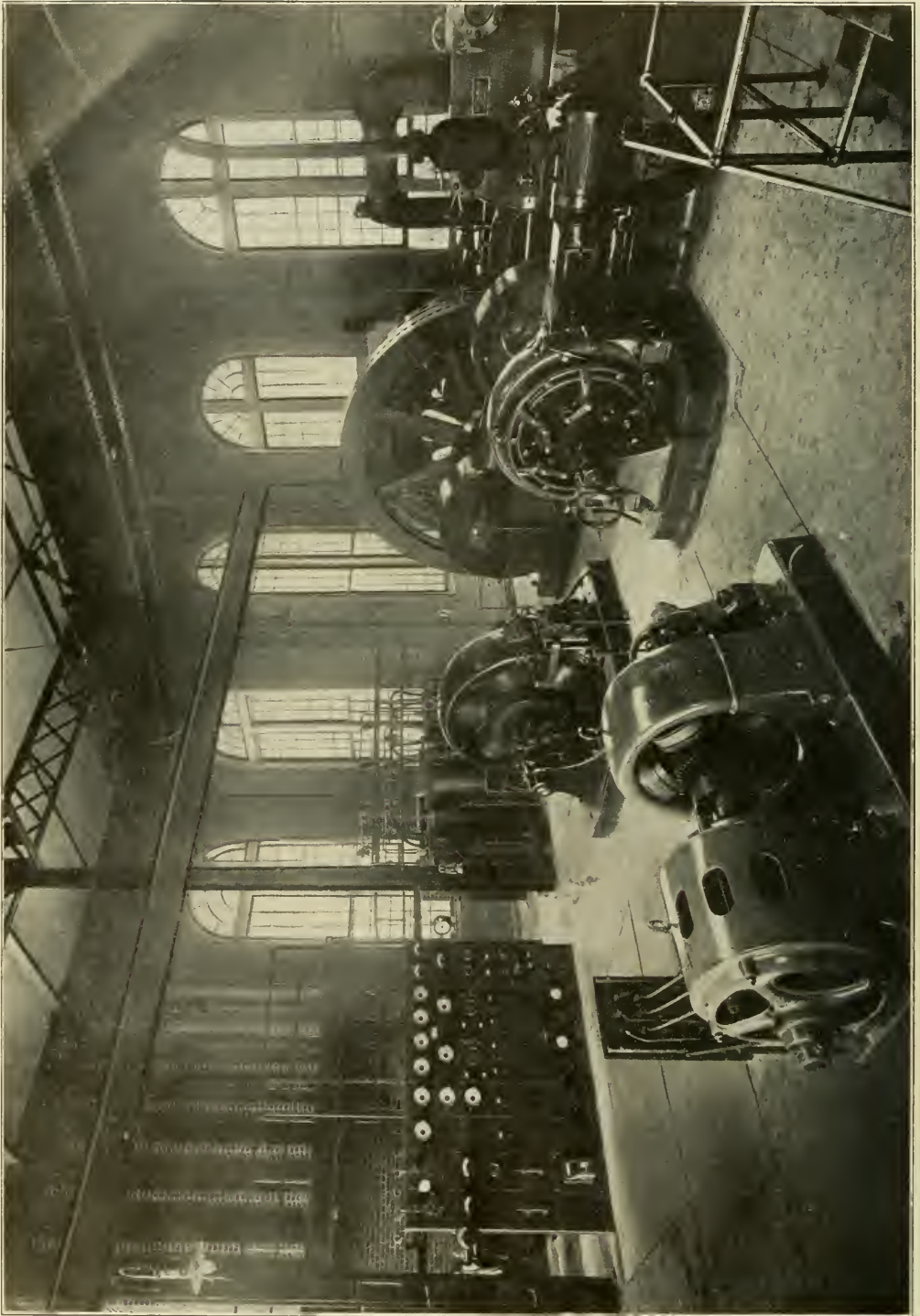

Ben-Hur Route—Interior of Crawfordsville Power Station, Showing One Main Generating Unit, Rotary Converter, Exciters, Transformers and Switchboard.

**THE RECENTLY COMPLETED RAILWAY OF THE INDIANAPOLIS CRAWFORDSVILLE & WESTERN TRACTION COMPANY.**

The Indianapolis Crawfordsville & Western Traction Company, popularly known as the Ben-Hur Route, now has in operation an especially well-built high-speed interurban trolley

The nature of the country traversed by the new line permitted the construction of a remarkably straight roadbed with low grades. There are no curves on the private right of way sharper than 3 degrees and 30 minutes and the maximum grade is 1¼ per cent. The bridges along the route are of substantial design, well constructed and amply strong to gracefully carry the heaviest traffic.

**Track and Roadway.**

There are two steel bridges—one a through high-truss bridge, 150 feet long, over Big Eagle creek, and the other of the same type over White Lick creek, with a span of 108 feet. All other bridges and waterways on the line are constructed of reinforced concrete in accordance with the Kahn system. Most of these concrete structures are of the

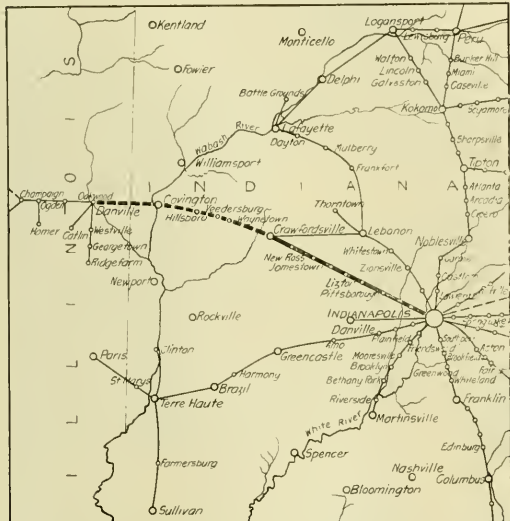

**Ben-Hur Route—Map of Operating and Proposed Lines.**

**Ben-Hur Route—Concrete Barrel Culvert.**

line between Indianapolis and Crawfordsville. The ultimate terminals of this road will be Indianapolis, Ind., and Danville, Ill. The present line is 45.1 miles long, serving the towns of Clermont, Brownsburg, Pittsboro, Raintown, Lizton, Jamestown, New Ross and Linnsburg, located between the terminals. At Indianapolis the cars reach the Traction Terminal

girder or slab type, but in two instances semi-circular arches are employed.

A branch of the Big Four Railroad crosses the new line at grade five miles from Indianapolis. This crossing is protected by an interlocking plant jointly maintained. The only other crossing with a steam road on the high-speed section of

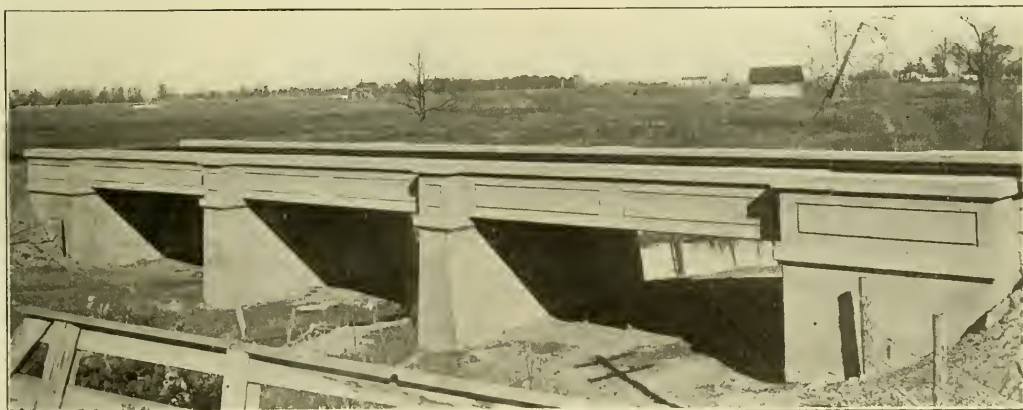

**Ben-Hur Route—Flat Top Ballasted Floor Concrete Bridge.**

station by a run of three miles over the tracks of the Indianapolis Street Railway. Between terminals the route closely parallels that of the Cleveland Cincinnati Chicago & St. Louis Railway. Accompanying illustrations show the general character of the property and illustrate in detail some of its many interesting constructional features.

the line is at New Ross, where the Central Indiana Railroad is intersected.

The interurban track is laid with standard 85-pound T-rails from Indianapolis to Brownsburg, and from Brownsburg to Crawfordsville a 70-pound section is used. The track is all laid to standard gauge on approximately two thousand



eight hundred 6 by 8 inch oak and chestnut ties per mile. The rails are spliced with standard 4-bolt angle bars. All the rail bonds are of 250,000 circular-mil cross section. For half the track soldered bonds were used, supplied by the Lord Electric Company, and for the remainder of the work a 10-inch United States pin-driven terminal bond, manufactured by the American Steel & Wire Company, was used.

**Overhead Line Construction.**

The trolley circuits are fed from a generating station at Crawfordsville through the medium of four substations—one located in the power station and the others spaced approximately 13 miles apart toward Indianapolis. Current is distributed to the outlying substations at a potential of 33,000 volts. The transmission line comprises three No. 4 B. & S. gauge bare copper wires, carried on No. 3026 Thomas 3-piece porcelain insulators, 8 3/8 inches in diameter by 8 1/4 inches high, cemented on malleable iron pins. All three of the transmission wires are carried on a single 10-foot crossarm, placed at the tops of the trolley line poles. The transmission line is

supported from galvanized hangers with 12-inch clinch ears hung from flexible brackets 10 feet long. All of the insulating materials for the direct-current circuits were supplied by the H. W. Johns-Manville Company, while the brackets, ears and overhead fittings were furnished by the Electric Service Supplies Company. The trolley line is fed by a low potential copper feeder, 400,000 circular-mils in section, which is supported on crossarms and glass insulators placed on the poles above the trolley brackets and below the high-tension cross-

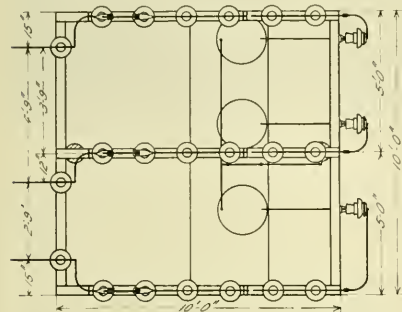

**Ben-Hur Route—Power Station Building.**

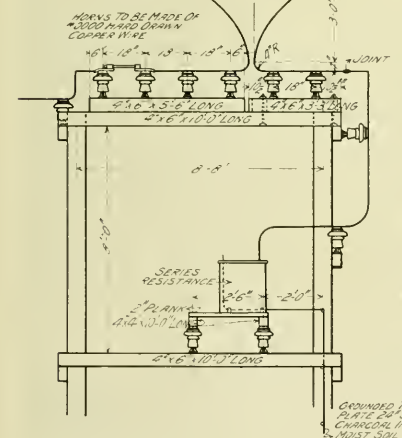

**Ben-Hur Route—Details of Horn Type Arrester for Protection of Transmission Lines.**

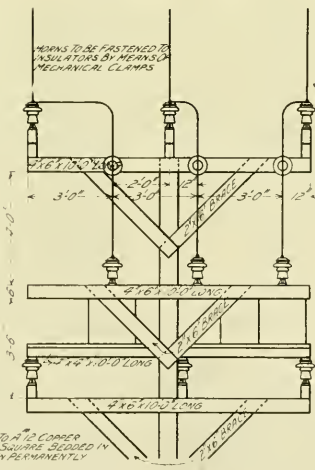

arms. Carried on this same cross-arm are two No. 9 B. W. G. iron wires, which are used for a private telephone system. This telephone line is connected to jack boxes placed on the poles every half mile, and at all sidings, for use in train dispatching. In addition to these boxes telephones are placed in each of the stations, so that all agents of the company can communicate with the main office in Crawfordsville over the company's private telephone system. The direct-current overhead circuits are protected from lightning by Garton pole arresters.

**Generating Station.**

While the electrical apparatus in the generating station and substations is fully protected with lightning arresters, it has been thought advisable to install several horn type arresters for additional protection of the 33,000-volt transmission line. The general design of one of these arresters is illustrated.

The power-generating station is in a fireproof building, constructed of reinforced concrete, brick and steel, located adjacent to Sugar creek in Crawfordsville. Drawings showing plan and sectional views of this building are presented. It will be noted that the building is divided into three parts: a coal bunker, into which coal can be unloaded from hopper bottom cars, the storage capacity being 650 tons; a boiler room, in which are boilers, auxiliaries, and the main steam pipes;

transposed every two miles, so that the wires are given two complete spirals between substations.

An accompanying illustration shows the general dimensions of a line pole and the arrangement of its fittings. The poles, of Missouri cypress, 40 feet long, with 9-inch tops, are spaced 105 feet apart along tangent track. The butts, gains and tops of the poles were brush-treated with carbolineum. In the cities of Indianapolis and Crawfordsville iron poles are used to carry the trolley line.

The trolley line comprises a No. 000 deep-grooved wire,

mission line. The general design of one of these arresters is illustrated.

The power-generating station is in a fireproof building, constructed of reinforced concrete, brick and steel, located adjacent to Sugar creek in Crawfordsville. Drawings showing plan and sectional views of this building are presented. It will be noted that the building is divided into three parts: a coal bunker, into which coal can be unloaded from hopper bottom cars, the storage capacity being 650 tons; a boiler room, in which are boilers, auxiliaries, and the main steam pipes;

and an engine room containing the main units and electrical auxiliary apparatus.

Steam is generated in four Stirling water tube boilers of 3,500 square feet of heating surface each. The boilers are fed by outside center-packed plunger pumps, which obtain their

engines, operating at 107 revolutions per minute under a steam pressure of 150 pounds per square inch and 26 inches of vacuum. Each of these units is provided with a condensing equipment, consisting of Dean jet condensers with direct-acting air pump. All steam and water connections between the



Ben-Hur Route—Substation Building.



Ben-Hur Route—Interior of Substation.

supply by gravity from a Webster open feed water heater, which is filled from the water supply system by piston pattern low-service pumps. There are two pumps of each type, each pair being of ample capacity to take care of the entire amount of water required for all of the boilers.

The furnace gases from the boiler are carried to a Weber reinforced concrete-steel chimney, 8 feet internal diameter and 175 feet

various pieces of apparatus are of the highest grade, and are provided with all of the necessary auxiliary and automatic devices. The live steam piping is designed for a working pres-

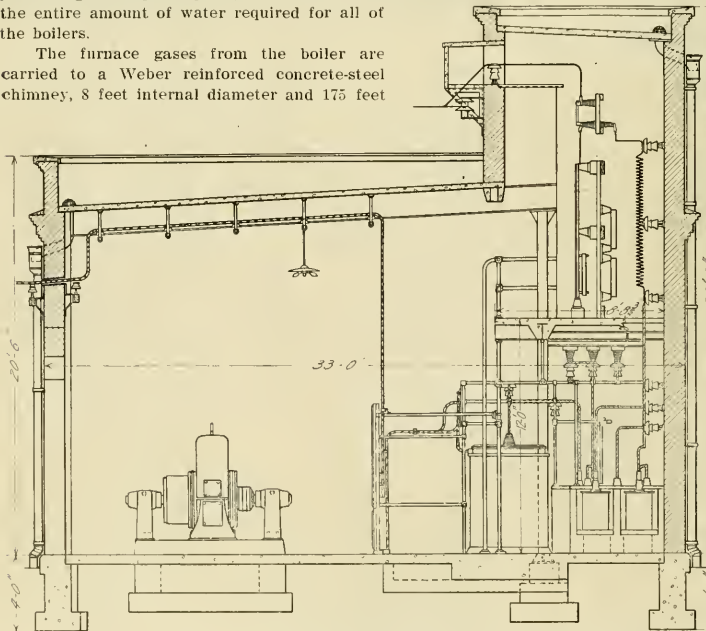

Ben-Hur Route—Sectional Elevation of Substation.

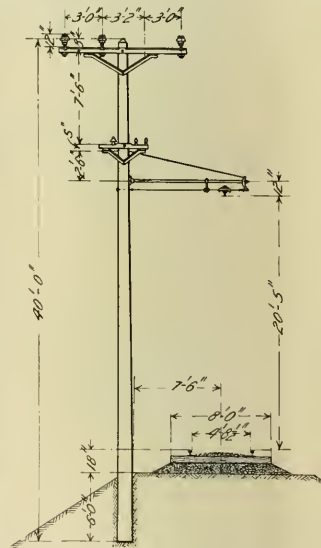

Ben-Hur Route—Pole and Track Dimensions.

high through a large steel smoke flue, placed above the boilers. This chimney and smoke flue is of sufficient size to take care of the probable future requirements of the power station.

In the engine room are two Allis-Chalmers-Bullock 700-kilowatt 25-cycle three-phase 405-volt alternators, direct-connected to Allis-Chalmers 20 and 42 by 42 inch cross-compound

sure of 250 pounds per square inch in order to have a large factor of safety. All high-pressure steam pipes, separators, boiler, drum-heads and receivers are covered with asbestos-sponge felted pipe covering, 1½ inches thick, and low-pressure lines are covered with the same material 1 inch thick. The pipe covering was furnished and applied by the H. W. Johns-



Manville Company. Oil for lubricating the two main engines is obtained from a central gravity oiling system, which includes an overhead gravity tank, receiving tank, Turner oil filter and duplex steam pump.

The current for exciting the rotating fields of the gen-

eration busbars through automatic oil switches, and from the busbars it is delivered to the low potential side of water-cooled raising transformers. After passing through the transformers the power is at a potential of 33,000 volts, and at this potential is fed through oil switches to high-tension busbars,



Ben-Hur Route—Shop and Car House.

erators is obtained from either a 50-kilowatt 120-volt generator, driven by a simple Ideal engine, or from another generator of the same electrical characteristics, but which is driven by an induction motor; the idea being to use the steam-driven exciter generator when starting the plant and then

which are carefully inclosed in brick and concrete compartments in the engine room basement. To these busbars the main automatic oil switch for control of the outgoing lines is connected.

The main power station also includes a 300-kilowatt rotary-



Ben-Hur Route—Interior of Limited Car.

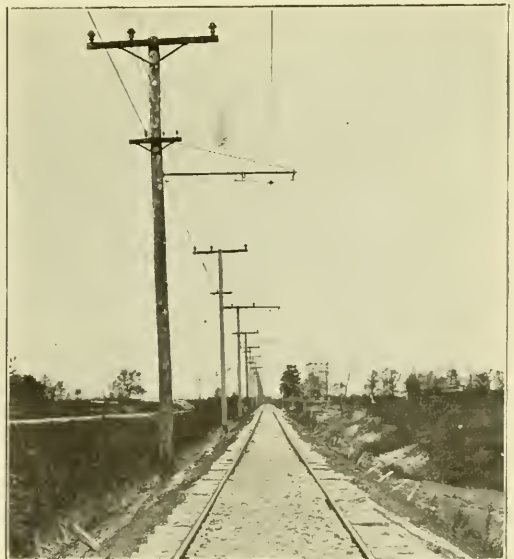

Ben-Hur Route—Track and Overhead.

use the motor-driven machine after the plant is in full operation for the sake of economy. Power for station lighting is also obtained from these units, and the engine-driven machine is used for this purpose at night after the rest of the station is closed down.

The power furnished by the main generators is fed to low-

converter equipment, which is fed directly from the generators at 405 volts, and converts the alternating current at this potential to continuous current at 650 volts for feeding the nearby trolley line.

All the electrical apparatus in the station is controlled from a Monson slate switchboard built by the Western Elec-

tric Company, upon which ITE circuit-breakers, Westinghouse oil switch control handles and instruments are mounted. No high-potential current is carried to the switchboard; the control of the high-potential circuits is accomplished by means of an auxiliary low-potential control system.

In order to protect the electrical machinery in the station from high-potential charges induced by lightning an equipment of 35,000-volt Westinghouse low-equivalent arresters has been installed in a gallery above the switchboard. These ar-

wire tower, transformer switches and rotary converter is presented. The high-tension transmission line is looped into the wire tower of each intermediate substation, so that by means of oil switches the circuits may be opened on either side of the substation. Oil switches are also provided for cutting each substation from the transmission line. The electrical equipment in each includes one 300-kilowatt rotary converter, three 110-kilowatt single-phase oil-insulated transformers, with the necessary switchboard, high-potential re-

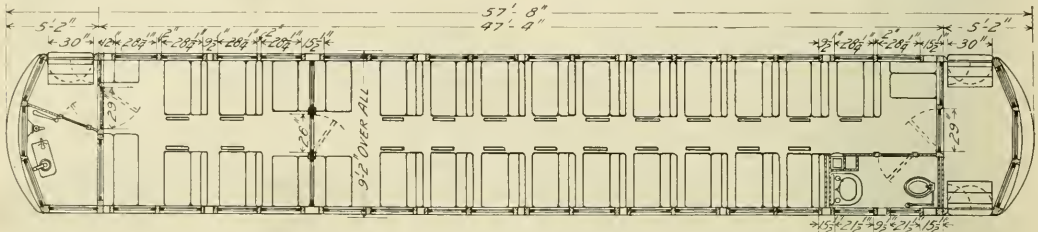

Ben-Hur Route—Dimensions and Seating Arrangement of Limited Cars.

resters are carefully connected to ground and so placed that they are always within view of the station attendant.

The water supply system is unique. When the power station site was chosen it was found that the stage of the water in Sugar creek varied about 17 or 18 feet at different seasons of the year, and in order to place the power station building at a sufficiently high level to be above high water it was found that an excessive lift would be imposed upon the pumps. About a mile up stream from the power station there is a dam across the creek and from this dam a mill race had been built to supply water to a grist mill located on the opposite side of the creek from the power house site. At the low-

mote-control oil switches and lightning arrester equipment; the apparatus all being used for the purpose of transforming the 33,000-volt alternating current to continuous current at 650 volts, at which potential it is fed directly to the low-tension feeder system. Each of the substation buildings is so designed and constructed that a duplicate equipment can be installed whenever the business of the railway shall require it. The buildings are fireproof and of ample size to accommodate the duplicate equipments referred to.

#### Shop and Car House.

A short distance from the power station a car shop has



Ben-Hur Route—Passenger Equipment for Limited Service.

water stage the level of the water in the race at the mill was about 14 feet above the creek. Advantage was taken of this condition and a 30-inch cast-iron flume was built from the mill race, passing under the river and rising to a pumping basin on the power house side. This, of course, caused the water in the pumping basin to stand at a level of about 14 feet above the low-water stage of the creek and solved the difficulty of excessive lift for the pumps.

#### Substations.

The substations, located approximately 13 miles apart, are at New Ross, Pittsboro and Carter. The buildings are substantial fireproof structures of concrete and brick. A vertical section through one of the buildings showing the arrangement of the

been constructed in which are placed all of the necessary woodworking and machine tools required to keep the company's property in repair. Adjacent to the shop a car house has been constructed of galvanized corrugated iron for protecting the rolling stock from the elements.

#### Rolling Stock.

The rolling stock for the new road consists of eight passenger cars and two baggage cars, which were built by the Jewett Car Company, Newark, O. Of the eight passenger cars six are designed for local service and two for limited service. The accompanying floor plan shows the seating arrangement and general dimensions of one of the limited cars.

Each of the passenger cars is 57 feet 8 inches long, 9 feet

2 inches wide, and 9 feet 9 inches high from under side of sills to top of roof, and with equipment weighs 41 tons. The underframing includes 7-inch 15-pound I-beam side sills with wood fillers. The intermediate sills are 4½ by 6 inch pine, reinforced from bolster to bumper with 6-inch 15½-pound I-beams. The center sills are 6-inch I-beams with wood fillers. Between the double floors is a 1½-inch space packed with mineral wool.

The baggage cars are 50 feet long over bumpers, 9 feet wide and 9 feet 6 inches high from under side of sills to top of roof. The underframing consists of two 6-inch I-beam center sills, filled; two 5 by 6-inch plain yellow pine intermediate sills, and two 5 by 8-inch yellow pine side sills reinforced with ½-inch steel plates placed on the outside.

The passenger cars for local service are divided into main, smoking and baggage compartments, while the limited cars have only two compartments, that for baggage being omitted. The limited cars seat 44 passengers in the main compartment and 16 in the smoking compartment. The local cars are provided with seats for 38 people in the main compartment and 16 in the smoking compartment, with the addition of temporary seats in the baggage room.

All car seats are Hale & Kilburn's stationary pattern No. 10 C. E., with single foot rest, mahogany arm rest, and spring edge cushions. The seats are 40 inches long with cushions 18 inches wide and backs 26 inches high. Seats in the main compartments are upholstered in plush, and those in the smoking compartment upholstered in leather.

The passenger cars are all finished in mahogany, with both interior and exterior art glass sashes arched over the windows. The floors are covered with inlaid linoleum, and in addition the limited cars have carpeted aisles and sheet rubber tiling on the floor of the toilet room and platforms.

Each car is provided with a toilet room, finished in white enamel and containing a Duner porcelain water flushed closet; the two limited cars are equipped with porcelain lavatories and plate glass mirrors.

The local cars are heated with Peter Smith hot water heaters and the limited cars with Consolidated electric heaters.

The car bodies are mounted on Baldwin Locomotive Works, M. C. B. type trucks with 7-foot wheel base and 37¼-inch rolled steel wheels. The electrical equipment of each car comprises four Allis-Chalmers-Bullock 75-horsepower railway motors with a gear ratio of 30:52 and Allis-Chalmers controllers. All of the power wiring is inclosed in steel conduit. The baggage cars have the same motor and truck equipment as the passenger cars, in order that all of the equipment shall be uniform and interchangeable. However, the baggage cars are equipped with combined straight and automatic air brakes of the Christensen type, whereas straight air brakes only are installed on the passenger cars.

The special equipment of these cars includes De France air sanders, Cronse-Hinds headlights, Lintern classification and signal lights, Van Dorn couplers and Wilson trolley retrievers.

#### Organization.

The cars are geared to operate at 60 miles per hour on straight and level track and now maintain a scheduled speed of 34 miles per hour in limited service and 25 miles per hour in local service.

The Indianapolis Crawfordsville & Western Traction Company was incorporated in 1903 under the laws of the state of Indiana as the Consolidated Traction Company. The name was changed as above in 1906. Capital stock authorized, \$3,000,000; outstanding, \$1,500,000; transfer agent, Marion Trust Company, Indianapolis. Bonded debt, \$1,500,000 first gold 5s; dated May 21, 1906; due July 1, 1936; interest January and July at Van Norden Trust Company, New York City; Marlon Trust Company, Indianapolis, trustee. Coupon, \$1,000. Authorized, \$3,000,000. Officers: A. A. Barnes, Indianapolis, president; Eli P. Baker, Crawfordsville, vice-president; Oliver P. Ensley,

Indianapolis, treasurer; Edward Hawkins, Indianapolis, secretary. The property is controlled by a board of five managing trustees, consisting of Sterling R. Holt, Indianapolis, chairman; Edward Hawkins, Indianapolis, secretary; A. E. Reynolds and C. N. Van Cleave, Crawfordsville, Ind., and A. M. Hewes, Chicago.

The Moore-Mansfield Construction Company of Indianapolis carried out the contract for grading, construction of bridges, tracklaying and ballasting, and the Electrical Installation Company of Chicago acted as engineer and contractor for the complete construction and equipment of the power station, substations, shop, overhead trolley and transmission lines and rolling stock.

#### ACCOUNTING SYSTEM FOR ELECTRIC LIGHTING COMPANIES.

The report of a committee on a "Uniform System of Accounting for Electric Lighting Companies" was made to the National Electric Light Association at its meeting at Chicago during the present week. In its report the committee says:

The report of the committee on a "Uniform System of Accounting for Electric Light Companies," made to the association at its last meeting, was not adopted by the association, but the committee was continued. The sentiment of the meeting seemed to be that a condensation of the classification of expenses was desirable, and also that some attempt should be made to harmonize the system with that used by the American Street and Interurban Railway Association. Later the association authorized the committee to confer with similar committees of other bodies.

Since the last meeting of the association the public service commissions of New York have completed their organizations and have been preparing a classification of accounts. For the street railways the commissions have adopted the system of the interstate commerce commission, but for the gas and electric light industries they will formulate systems of their own. The accounting committee has kept in touch with this work of the commissions, has tendered its aid and this aid the commissions have been good enough to accept and have consulted the committee on all features of their plan. As the matter now stands both commissions have prepared tentative classification systems, have furnished the forms to the companies and have held public hearings thereon.

The tentative classification prepared by the commission for the first district covers property, income and operating accounts only, whereas the classification prepared by the commission for the second district covers the entire subject of accounting in all its phases.

There is one feature, common to all the recent federal and state legislation, establishing regulatory commissions, to which the accounting committee desires to call the attention of the association. It refers to the provisions forbidding the companies to keep any accounts, records or memoranda other than those prescribed by the commissions. If the purpose of this legislation is to prevent companies from making false reports to the commissions, it would seem to be unnecessary, as it is already unlawful to do so, and any company desiring to make improper reports would not be deterred by the new legislation from so doing. The principal effect would be to embarrass and annoy those companies that might desire information of one kind or another not asked for by the commissions, but which information, owing to local conditions, or even, if you please, to idiosyncrasies of the management, might make that information necessary to the proper administration of its affairs. Governmental accounts cannot be flexible, as they must be made to suit average conditions, nor can they quickly respond to exigencies which may arise locally. Every company occasionally makes special investigations to ascertain some particular cost or to determine the proper policy to pursue in some emergency. For such purposes special accounts are created, which are discontinued after the information sought has been obtained. The interstate commerce commission has recognized this condition.

The accounting committee feels that the association should endeavor to have this prohibitive feature of the legislation eliminated or so modified as will leave the companies at liberty to conduct their affairs according to their needs, and while giving to the governments the fullest information desired, shall equally give to the companies the information which they may require. Surely the interests of the public cannot be adversely affected by leaving to the owner of the property the right to at least inform himself of his own affairs in his own way.

REVISED CLASSIFICATION OF ACCOUNTS FOR ELECTRIC RAILWAYS.

At a conference held last week at the office of the interstate commerce commission, Washington, D. C., a revised classification of accounts of electric railways was prepared. Classifications of operating expenses, operating revenues and construction expenditures were drafted. Provision is made in the classification of operating expenses for three classes of companies, according to the plan of division of gross annual revenue, shown in the following. The text for the accounts is in course of preparation now, and it is proposed by the interstate commerce commission to have the accounts effective as of October 1, 1908.

Prof. H. C. Adams, in charge of statistics and accounts interstate commerce commission has sent the following letter to the various state commissions in the country, accompanied by a list of the proposed accounts:

Letter to State Commissions.

Referring to previous correspondence with this office relative to the adoption of a uniform system of accounting for electric railways I inclose herewith for your information a copy of the proposed classification of accounts, which has been carefully considered by the committees on "Classification" of the American Street and Interurban Railway Association and the American Street and Interurban Railway Accountants' Association, and, as I understand, in all essential particulars, meets with the approval of both these committees, one representing the operating and the other the accounting department of the electric railway corporations.

The text for these accounts will be prepared by a special committee of electric railway accountants which meets in Atlantic City today.

By referring to Accounting Series Circular No. 20, accompanying this letter, you will observe that the inclosed classification is a modification of the accounts appearing in that circular, and your especial attention is called to the following facts:

- (1) The classification of operating expenses provides for three classes of roads, instead of two, as proposed in Circular No. 20, with 26 accounts for the smallest class, 58 accounts for the middle class and 88 accounts for the largest class.
- (2) The primary accounts, "other operations—Dr." and "other operations—Cr." (Nos. 26, 27, 42, 43, 58, 59, 80 and 81) cover not only the proportion of production expenses caused

by another co-ordinate department or departments within the same company (as electric light department, power department, heat department, etc.), but also the proportion of production expenses of jointly produced electric power.

(3) Provision is made for two depreciation accounts, one under maintenance of way and structures and one under maintenance of equipment. It is understood, however, that the order for the use of these accounts is to come from the state commissions and not from the interstate commission in all states where state commissions have jurisdiction over electric lines. In states where state commissions have not been given jurisdiction over electric lines it is probable that the order of the interstate commission relative to the use of depreciation accounts will conform to the action taken by a majority of the state commissions in other states.

In case a state having jurisdiction refrains from requiring that use be made of the depreciation accounts, an order should be issued definitely requiring the carrier to make use of appropriate repair accounts, detailed rules for which will be found in the text to be submitted hereafter.

In reports from interstate carriers to the interstate commission it is understood that, for the present, the order relative to the use of depreciation accounts of the commission of the state in which the major portion of the business of the corporation lies shall control.

(4) These accounts will be made effective by the interstate commerce commission on October 1, 1908, but it is the intention to have the text of classifications issued at the earliest possible date in order that state commissions may make same effective on July 1, 1908, if they so desire. The delay in promulgating the order of the interstate commerce commission is not to be interpreted as changing the date of the fiscal year, but as applicable only to the first year's reports and is adopted at the request of certain of the carriers.

These classifications have been prepared as far as possible in accordance with the wishes of the various state commissions and it is desired that this office be promptly advised of the action of your commission in regard to their adoption, and in case of such adoption the date on which they will be made effective.

You are also respectfully requested to advise this office as soon as convenient of the action of your commission regarding the depreciation accounts above referred to, it being our purpose to be guided in large measure by your action in this matter; but it is suggested that your commission need not delay an expression of its view upon the general question of the adoption of the classification of accounts until you have decided upon the advisability of the order relative to depreciation, that being a matter in no way contingent upon a general agreement with this office on the accounts as a whole.

CLASSIFICATION OF OPERATING EXPENSES OF ELECTRIC RAILWAYS.

Classes of Electric Railways.		Accounts to be kept by rail-ways of grade.
A.	Annual gross revenue.....\$1,000,000 and over	
B.	Annual gross revenue.....\$250,000 to \$1,000,000	
C.	Annual gross revenue.....Under \$250,000	
General Accounts.		
Account.		
I.	Way and structures.	
II.	Equipment.	
III.	Traffic.	
IV.	Conducting transportation.	
V.	General and miscellaneous.	
Primary Accounts.		
I.	Way and structures.	
1.	Superintendence of way and structures.	A B C
	Maintenance of way.....	A B C
	Maintenance of roadway and track.....	B C
2.	Ballast.....	B
3.	Ties.....	A
4.	Rails.....	A
5.	Rail fastenings and joints.....	A
6.	Special work.....	A
7.	Underground construction.....	A
8.	Roadway and track labor.....	A
9.	Paving.....	A
10.	Miscellaneous roadway and track expenses.....	A
11.	Cleaning and sanding track.....	A
12.	Removal of snow, ice and sand.....	A
	Other maintenance of way.....	A
13.	Tunnels.....	B
14.	Elevated structures and foundations.....	A
15.	Bridges, trestles and culverts.....	A
16.	Crossings, fences, cattleguards and signs.....	A
17.	Signals and interlocking system.....	A
18.	Telephone and telegraph system.....	A
19.	Other miscellaneous way expenses.....	A
	Maintenance of electric lines.....	C
20.	Poles and fixtures.....	A B
21.	Underground conduits.....	A B
22.	Transmission system.....	A B
23.	Distribution system.....	A B
	a. Overhead feeders.....	A B
	b. Underground feeders.....	A B
	c. Track bonding.....	A B
	d. Overhead trolley.....	
	e. Third rail.....	
	f. Underground contact rails.....	
24.	Miscellaneous electric line expenses.....	A B
25.	Buildings and structures.....	A B C
	a. Power plants.....	
	b. Substations (including storage battery buildings).....	
	c. Car houses.....	
	d. Shops.....	
	e. General offices.....	
	f. Stations, waiting rooms and platforms.....	
	g. Locks and wharves.....	
	h. Miscellaneous buildings and structures.....	
	i. Miscellaneous expenses.....	
26.	Other operations—Dr.....	A B C
27.	Other operations—Cr.....	A B C
28.	Depreciation of way and structures.....	A B C
II.	Equipment.....	
29.	Superintendence of equipment.....	A B C
	Maintenance of power equipment.....	A B C
30.	Power plant equipment.....	A B
	a. Furnaces and boilers.....	
	b. Steam engines.....	
	c. Hydraulic engines.....	
	d. Gas engines.....	
	e. Electric generators.....	
	f. Other power plant equipment.....	
31.	Substation equipment.....	A B
	Maintenance of cars and locomotives.....	A B C
32.	Passenger and combination cars.....	A
	a. Passenger cars.....	
	b. Combination cars.....	
33.	Freight, express and mail cars.....	A
	a. Freight cars.....	
	b. Express cars.....	
	c. Mail cars.....	
34.	Locomotives.....	A
35.	Service cars.....	A
	a. Work cars.....	
	b. Snow equipment.....	
	Maintenance of electric equipment of cars and locomotives.....	
36.	Electric equipment of cars.....	A B C

Accounts to be kept by rail-ways of grade.

Accounts to be kept by rail-ways of grade.

37. Electric equipment of locomotives.	A
38. Miscellaneous equipment expenses.	B C
39. Shop machinery and tools.	A
40. Shop expenses.	A
41. Horses and vehicles.	A
42. Other miscellaneous equipment expenses.	A
43. Other operations—Dr.	A B C
44. Depreciation of equipment.	A B C
III. Traffic.	
Traffic expenses.	B C
45. Superintendence and solicitation.	A
46. Advertising.	A
47. Miscellaneous traffic expenses.	A
IV. Conducting transportation.	
48. Superintendence of transportation.	A B C
Group I—Power.	
49. Power plant employes.	A B C
a. Boiler house employes.	A
b. Engine house employes.	A
c. Electric employes.	A
d. Miscellaneous power plant employes.	A B C
50. Substation employes.	A B C
51. Fuel for power.	A B C
Other power supplies and expenses.	C
52. Water for power.	A B
53. Lubricants for power.	A B
54. Miscellaneous power plant supplies and ex-penses.	A B
55. Substation supplies and expenses.	A B
56. Power purchased.	A B C
57. Power exchanged—balance.	A B
58. Other operations—Dr.	A B C
59. Other operations—Cr.	A B C
Group II—Operation of Cars.	
60. Conductors, motormen and trainmen.	C
61. Passenger conductors, motormen and train-men.	A B
a. Passenger conductors.	A
b. Passenger motormen.	A
c. Other passenger trainmen.	A
62. Freight and express conductors, motormen and trainmen.	A B
a. Freight and express conductors.	A
b. Freight and express motormen.	A
c. Other freight and express trainmen.	A
63. Miscellaneous transportation expenses.	C
64. Miscellaneous car service employes and ex-penses.	B
65. Miscellaneous car service employes.	A
66. Station employes and expenses.	A B
67. Station employes.	A
68. Car house employes and expenses.	A B
69. Car house employes.	A
70. Signal, interlocking, telephone and telegraph systems.	B
71. Operation of signal and interlocking system.	A
72. Operation of telephone and telegraph system.	A
73. Express and freight collections and delivery.	A B
74. Loss and damage.	A B
75. Other transportation expenses.	A B
V. General and miscellaneous.	
General expenses.	C
Salaries and expenses of general officers and general office clerks.	B
76. Salaries and expenses of general officers.	A
77. Salaries and expenses of general office clerks.	A
78. General office supplies and expenses.	A B
79. Law expenses.	A B
80. Relief department expenses.	A B
81. Pensions.	A B
82. Miscellaneous general expenses.	A B
83. Other operations—Dr.	A B C
84. Other operations—Cr.	A B C
Undistributed Accounts.	
Note.—Carriers are at liberty to distribute items covered by the following accounts, but all reports to the commission must agree with accounts which are prescribed.	
85. Injuries and damages.	A B C
86. Insurance.	A B C
87. Stationery and printing.	A B C
88. Store and stable expenses.	C

85. Store expenses.	A
86. Stable expenses.	A B
87. Rent of tracks and terminals.	A B C
88. Rent of equipment.	A B C

Classification of Operating Revenues of Electric Railways.

I. Revenue from transportation.	General Accounts.
II. Revenue from operations other than transportation.	General Accounts.
Primary Accounts.	
I. Revenue from transportation.	
1. Passenger revenue.	
2. Baggage revenue.	
3. Parlor and chair car revenue.	
4. Mail revenue.	
5. Express revenue.	
6. Milk revenue.	
7. Freight revenue.	
8. Switching revenue.	
9. Miscellaneous transportation revenue.	
II. Revenue from operations other than transportation.	
10. Station and car privileges.	
11. Parcel room receipts.	
12. Storage.	
13. Car service.	
14. Telegraph and telephone service.	
15. Rents of tracks and terminals.	
16. Rents of equipment.	
17. Rents of buildings and other property.	
18. Power.	
a. Sale of power.	
b. Joint electric rent revenue.	
19. Miscellaneous.	

Classification of Expenditures for Road and Equipment of Electric Railways.

General Accounts.	
Account.	
I. Road.	
II. Equipment.	
III. General expenditures.	
Primary Accounts—I. Road.	
1. Engineering and superintendence.	
2. Right of way.	
3. Other land used in electric railway operations.	
4. Grading.	
5. Ballast.	
6. Ties.	
7. Rails, rail fastenings and joints.	
8. Special work.	
9. Underground construction.	
10. Paving.	
11. Tracklaying and surfacing.	
12. Roadway tools.	
13. Tunnels.	
14. Elevated structures and foundations.	
15. Bridges, trestles and culverts.	
16. Crossings, fences, cattleguards and signs.	
17. Interlocking and other signal apparatus.	
18. Telegraph and telephone lines.	
19. Poles and fixtures.	
20. Underground conduits.	
21. Transmission system.	
22. Distribution system.	
23. Power plant buildings.	
24. Substation buildings.	
25. General office buildings.	
26. Shops and car houses.	
27. Stations, waiting rooms and miscellaneous buildings.	
28. Docks and wharves.	
29. Power plant equipment.	
30. Substation equipment.	
31. Shop equipment.	
32. Miscellaneous equipment of stationary plants.	
33. Cost of road purchased.	
II. Equipment.	
34. Cars.	
35. Locomotives.	
36. Electric equipment of cars and locomotives.	
37. Other rail equipment.	
38. Miscellaneous equipment.	
III. General Expenditures.	
39. Law expenses.	
40. Interest and commission.	
41. Injuries and damages.	
42. Taxes.	
43. Miscellaneous.	

American Society of Mechanical Engineers.

The semi-annual meeting of the American Society of Mechanical Engineers will be held in Detroit, Mich., June 23 to 26. An entire session will be devoted to papers on the conveying of materials, when hoisting and conveying machinery including belt conveyors, the use of conveying machinery in cement plants, etc., will be discussed.

Among other subjects which will be taken up by professional papers are: "Clutches," with special reference to automobile clutches, by Henry Souther; "Some Pitot Tube Studies," by Prof. W. B. Gregory of Tulane University, New Orleans, La., and Prof. E. W. Schroder of Cornell University; "Thermal Properties of Superheated Steam," by Prof. R. C. H. Hock of Lehigh University; "Horsepower, Friction Losses and Efficiencies of Gas and Oil Engines," by Prof. Lionel S. Marks of Harvard University; "A Journal Friction Measuring Machine," by Henry Hess of Philadelphia; "A Simple

Method of Cleaning Gas Conduits," by W. D. Mount; "A Rational Method of Checking Conical Pistons for Stress," by Prof. G. H. Shepard of Syracuse University; and "The By-Product Coke Oven," by W. H. Blauvelt.

A lecture on "Contributions of Photography to Our Knowledge of Stellar Evolutions" will be delivered by Prof. John A. Brashear of Allegheny, Pa. The usual receptions will be held and excursions will be made to manufacturing plants, the ship building yards and various points of interest in and around Detroit. Among the excursions planned is one to the University of Michigan, at Ann Arbor. The gas power section of the society will hold a session, and the Society for the Promotion of Engineering Education and the Society of Automobile Engineers will hold meetings in Detroit at the same time. As far as possible, sessions will be arranged so that members interested in subjects treated by the other societies may attend their sessions without missing papers on related subjects read before their own society.



of its 86 towns, and the long stretches of country between. The people have become educated to buy more, see more, desire more and demand more, both necessities and luxuries. In fact, what were formerly considered luxuries are now necessities, and the demand for merchandise has increased to a wonderful extent.

**PRACTICAL MOTOR COIL MAKING—NEW YORK CITY RAILWAY.**

BY H. P. CLARK, MASTER MECHANIC.

"Shall electric railway companies make or buy their motor coils?" is a question often discussed. Aside from any consideration of profit it is the opinion of the writer that all the large electric railway companies should manufacture all

All machines of a certain type are built alike and placed symmetrically in the space allotted to the work. The reel stands are made of iron, securely fastened, thus giving strength to withstand high tension where needed. The stand as illustrated presents a neat appearance and at the same time reduces the fire hazard. Figure 1 shows the reel stand used for heavy work, such as G.E. 57 field coils. Figure 2 shows the details of the tension clamp. The same stand is used for wire field coils with the exception that the fiber is grooved wire field coils with the exception that the fiber is grooved for the wire and well greased with paraffin. These clamps work well and do not injure the insulation of the wire.

Figure 3 shows a stand for two reels as used for light work, such as making armature coils, etc. The same general design is used for all the stands.

As the coils are gathered from the machines they are

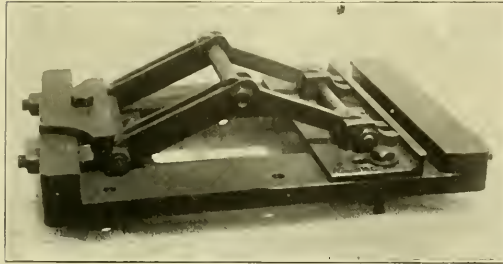

Coil Making—Clark Hot Press.

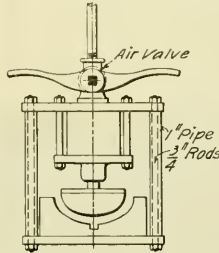

Coil Making—Figure 4.

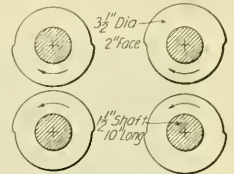

Coil Making—Figure 5—Flattening Rollers.

the various coils required for their motors. Many of them do. The reason for this is explained when the factor of delivery is considered. The development of the electric industry has been so rapid that many roads have several types of motors in service. To carry in stock the large quantities of coils necessary for all the various types of motors would

finished in the kind of hot press shown in the halftone engraving. About 45 seconds is required to press and dry the coils in one of these presses. Six presses are used and one boy can easily operate three of them. For making small coils, such as those for G.E. 1,000 motors, a press operated with compressed air is employed. This device, shown in Figure 4, is very simple and satisfactory. Air at 60 pounds pressure is used for forcing the piston down and a spiral spring inside the cylinder lifts it the instant the pressure is

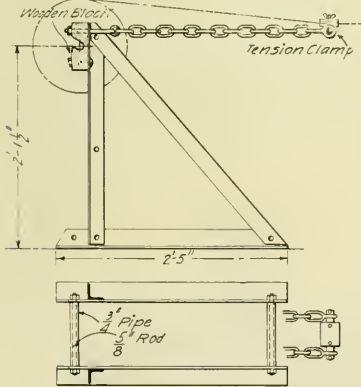

Coil Making—Figure 1—Reel Stand.

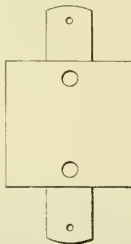

Coil Making—Figure 2—Tension Clamp.

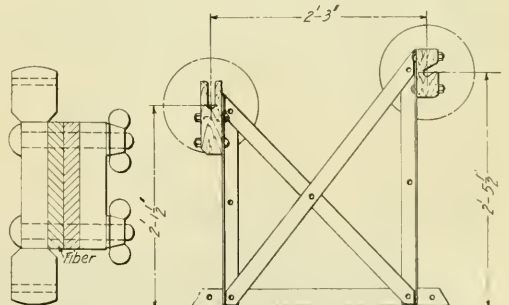

Coil Making—Figure 3—Stand for Two Reels.

mean a very great outlay, with the result that frequently the coils most needed would not be available. Since several types of motors use similar wire the progressive shop manager may readily be prepared for the changing demands if he carries in stock a few kinds of wire and equips his shop with modern appliances for coil work.

In the shops of the New York City Railway Company some interesting methods are used for making coils. The different motors on this system range from the G.E. 800 to the latest type G.E. 210 with commutating poles. Reference to the accompanying illustrations will show how the work is done.

released. As the rod requires no packing the friction of the piston is slight.

The G.E. 1,000 coil has flattened leads. The work of flattening is done by a pair of tool steel rolls, as shown in Figure 5. The rolls or discs are about 3 1/2 inches in diameter with a 2-inch face and are keyed to two shafts. These shafts have a diameter of 1 1/2 inches, are 10 inches long and are driven by suitable gearing with a ratio of 3 to 1. The coil is inserted in the clearance space and is forced out by the rolls. One roll is adjustable. The leads for coils can thus be flattened to any desired thickness and the cotton covering be removed at the same time. The cotton is removed from all

other coils by means of a wood cylinder covered with card cloth.

The devices shown in the accompanying sketches are simple affairs, built from time to time as opportunity offered. The average street railway shop has no elaborate toolroom or corps of experts available for designing or experimenting on improvements. In fact, the shop force generally is overtaxed with the regular routine work and the shop manager often hampered in his efforts to do the work satisfactorily with inadequate facilities. By taking advantage, however, of the opportunities that do come now and then, he will be able to provide at a comparatively low cost shop tools and equipments which will meet all ordinary requirements and find himself, like Diogenes of old, "prepared for anything that may happen."

#### NEW CARS FOR THE CHICAGO LAKE SHORE & SOUTH BEND RAILWAY.

The Chicago Lake Shore & South Bend Railway Company is now receiving from the Niles Car & Manufacturing Com-

pany Central road and hauled as trailers into the terminal station of the steam road at Chicago.

From the general dimensions presented it will be noted that the car bodies are of the regular steam coach width, which is a desirable feature that few interurban railways have been able to obtain. The initial order for these cars included 15 straight passenger coaches, eight combination passenger, smoker and baggage cars and one work car. The general dimensions are as follows:

Length over all.....	57 ft. 2 in.
Length over body.....	47 ft. 4 in.
Width over all.....	10 ft.
Height from floor to top of roof.....	9 ft. 5 in.
Truck centers.....	35 ft. 6 in.
Width of aisle.....	24 in.
Width inside.....	9 ft. 7½ in.

This arrangement for terminal service with a steam trunk line requires that the electric cars conform to the rules of the Master Car Builders' Association as regards height of car, coupler, dimensions of wheel tread and flange, clearance, etc. As the suburban station platforms of the Illinois Central Railroad are elevated to the level of the steam coach floors



High-Speed Interurban Car for the Chicago Lake Shore & South Bend Railway.

pany of Niles, O., 15 substantially built high-speed cars which are attractive in appearance.

The route of this new line was described and a map presented in the Electric Railway Review for May 2, 1908, page 542. The service which this new line will offer will be unique in character. An especially well-built roadbed, equipped for high-voltage single-phase operation, is nearly

as necessary in building the electric cars to increase the height of the side vestibule doorways so that passengers may step from the station platform to the car platform.

The bottom frames of the new cars are of semi-steel construction with double outside sills that have 5/8 by 10 inch steel plates bolted between them. The four center and intermediate sills are built of 6-inch I-beams and extend the full

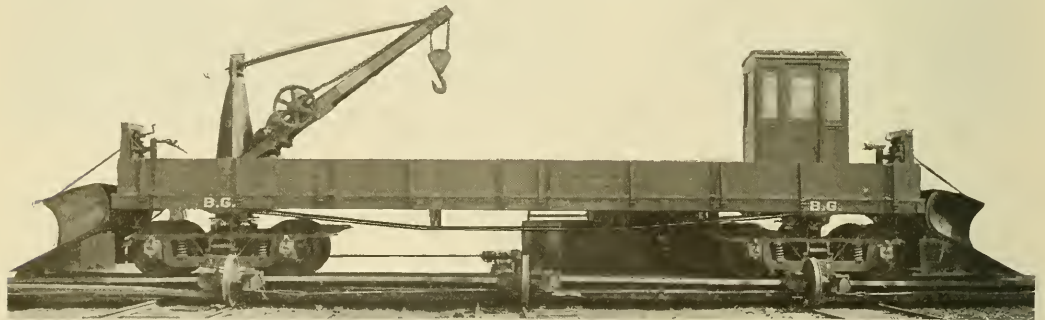

General Utility Car for the Chicago Lake Shore & South Bend Railway.

completed between South Bend, Ind., and Kensington, Ill., on the main line of the Illinois Central Railroad. An arrangement for joint service has been made between the electric road and the Illinois Central so that the electric cars, after traveling over the single-phase portion of the road on their own power, may be attached to regular trains of the Illinois

length of the car from buffer to buffer. The front ends of the cars are fitted with locomotive type pilots so arranged that they will not interfere with the drawbars and hose couplings when the cars are operated in trains. End doors are provided in the vestibules with spring buffers so that passengers may pass from car to car.



The interior of the car body is richly finished in polished dark mahogany. The window panels have the same curvature as the outside of the car and are set off with curved moldings. The main panels are bordered with a neat inlay of colored wood. The ceilings are full Empire style artistically decorated and illuminated with incandescent lamps inclosed in holophane bowls. An individual lamp is also supported over each seat by an artistic bronze bracket. The lower windows and doors are glazed with polished plate and the upper side sashes are glazed with tinted art glass set in copper frames. These Gothic sashes are double, with the interior section arranged to raise for cleaning. This window feature adds greatly to the interior appearance of the car as the curtains are arranged to roll into a neat casing at the bottom of the Gothic sashes similar to that used on Pullman cars. Bevel sash locks and bars with the necessary springs to prevent rattling, manufactured by the O. M. Edwards Company, are fitted to the window sashes. The curtains are of pantasote. Over the vestibule step openings are set self-opening traps, also manufactured by the O. M. Edwards Company.

The straight passenger cars have a seating capacity for 60 persons. The seats, manufactured by Hale & Kilburn, have stationary backs, foot rests, bronze grab and offset handles and arm rests and are upholstered in leather. The cushions are 38 inches long and the seats measure 48 inches from the inside of the car to the outside of the arm rests.

A toilet room is located at the rear of the main passenger compartment. This room has a combination hopper and is finished with a cement floor and white tiled walls. In the front bulkhead of the car is a high-tension switch cabinet lined with asbestos.

The new cars are mounted on Baldwin Locomotive Works Class 90-35 M. C. B. trucks with 7-foot 6-inch wheel base. Each truck was designed for a working center plate load of 35,000 pounds. Standard Steel Works steel wheels, 38 inches in diameter, are mounted on axles 6½ inches in diameter at the center, 7½ inches at the gear seat and 7 inches at the wheel seats. The journals are 5½ by 10 inches, inclosed in Symington journal boxes. Ball-bearing center bearings of Symington manufacture are used on all trucks.

The electrical equipment includes four Westinghouse No. 148 single-phase motors rated at 125 horsepower capacity each and multiple-unit control. The special equipment of the cars includes Peter Smith hot water heaters, Westinghouse automatic air brakes, Peacock hand brakes, Lintern markers and classification lights and Tomlinson couplers. As security against electrical injury the roof is covered with 16-ounce sheet copper well grounded. The exterior of the cars is painted in three shades of maroon with silver lettering. This exterior finish is similar to that of the Chicago & Alton limited trains.

The work car as illustrated is a combination equipment which can be used for construction, wrecking or fighting snow. The underframing is built of heavy steel with end-to-end sills 40 feet long. Sideboards are provided so that loose material may be carried. Mounted over one floor is a 10-foot pillar crane swinging in a 12-foot radius. This crane was built by the Cleveland Crane & Car Company, Cleveland, O. Both ends of the car may, if desired, be equipped with Russell wing plows designed to be raised or lowered by air controlled from the cab mounted over one of the trucks. The electrical and braking equipment is similar to that of the passenger cars.

The cars were designed by the Cleveland Construction Company, which has acted as engineer during the construction of the Chicago Lake Shore & South Bend Railway.

The Milwaukee Northern Railway expects to open its line to Sheboygan, Wis., probably in June. All grading through the swamps between Port Washington and Sheboygan has been completed and all right of way has been secured. Over six miles of track have been laid.

## RECENT ELECTRIC RAILWAY LEGAL DECISIONS.

BY J. L. ROSENBERGER, LL. B., OF THE CHICAGO BAR.

### Anti-Pass Constitution Does Not Prevent Municipalities Giving or Contracting for Free Transportation for Policemen, Etc.

Oklahoma City v. Oklahoma Railway Company, 93 Pacific Reporter, 48.—The supreme court of Oklahoma holds that the provisions of Section 13 of Article IX of the constitution of that state, prohibiting the giving of free passes or transportation, etc., will not prohibit a municipal corporation operating a street railway from furnishing transportation free to its policemen and firemen and United States mail carriers, and half-rate tickets to school children, and free transportation to children under a certain age while traveling with a parent or guardian. Furthermore, municipalities are not prohibited by the provisions of said section of the constitution from granting franchises for street railways with conditions contained therein for the carrying of policemen, firemen, United States mail carriers and children under a certain age free, and for the furnishing of transportation to school children at a reduced fare, and when accepted by the grantee in the franchise are valid. Street railways undertaking and contracting with municipalities by provisions contained in franchises granted by such municipalities, to carry policemen, firemen, United States mail carriers and children under a certain age free, and also to carry school children at half the regular rate, are not absolved therefrom by Section 13, Article IX, of the constitution.

### When Relation of Passenger Terminates—Passenger Carried Beyond Street and Injured Crossing Rough Track.

Melton v. Birmingham Railway Light & Power Company, 45 Southern Reporter, 151.—The supreme court of Alabama says that it thinks there can be no doubt of the soundness of the proposition that the relation of passenger does not terminate when the passenger leaves the car, but continues until he has reasonable opportunity to leave the car and roadway of the company, after the car reaches the station or stopping place to which he is entitled to be carried. This is the generally accepted doctrine.

Nor does the court think that it can be the subject of serious doubt that if the plaintiff, while traveling on one of the defendant's cars on a dark night, signaled the conductor to put her off at a particular street crossing (a regular stopping place), and the conductor understood the signal, but failed to put her off at that crossing, and put her off at a place beyond such crossing, where the company's track was ballasted with slag and was very rough, and that the plaintiff, while attempting to cross the track to go to her home, which was on the side of the track opposite the point where she alighted from the car, fell, and by the fall suffered the injury complained of, this would constitute actionable negligence, entitling the plaintiff to a recovery, unless she was guilty of contributory negligence in making her way across the track, or unless she assumed the risk.

### Risk from Third Rail Assumed by Painters of Structure of Elevated Railroad.

James v. Cranford, 108 New York Supplement, 142.—The supreme court of New York, appellate division, second department, says that the plaintiff, one of 40 or 50 painters, was painting the iron columns and iron girders of the structure of an elevated railroad. The railroad at the time was being worked by power furnished by a third rail permanently placed along the rails. The plaintiff, in common with his fellows, was furnished with a paint brush, a duster and a swab. The swab was made of thin iron and was used to paint places which could not be painted with a brush. A place under and near the third rail required the application of the swab. The plaintiff

knelt and thrust his swab through a narrow space, holding the swab so that about three inches projected above his hand. He testified that he had no difficulty in putting the swab in, and that no part of it came in contact then with the third rail; but, when he was pulling the swab out, he brought one end of it in contact with the girder and the other end with the third rail simultaneously. The place itself was a risk assumed by the servant. And, in any event, as the evidence was clear that the plaintiff understood the peril if, in using this swab, he brought it into simultaneous contact with the third rail and the iron of the structure, the court thinks that he assumed the risk of using this swab in this place. His assumption of risk did not turn upon the extent of his knowledge when he began the work, or of his ignorance of the precise or exact result of such contact or of the fact that the result is technically known as a short-circuit. Probably to a man of his calling it would not have materially affected his work if he had known that such contact would produce a short-circuit, instead of being very dangerous. Surely he was not entitled to absolution because he did not precisely understand the scientific or physical fact resultant from contact or the electrical phenomenon resultant therefrom.

#### Reasonable Care Only is Required of Company as to Passenger on Running Board.

Gregory v. Elmira Water Light & Railroad Company, 83 Northeastern Reporter, 32.—The court of appeals of New York says that the plaintiff, with two companions, boarded an open car running north. All of the seats were occupied, as well as the standing room between the seats and in the aisle. The plaintiff and his companions were able to get upon the running board on the west side and, having done so, filled the place to its utmost capacity. It seemed to have been the practice of the defendant company to allow passengers to ride on the running boards if there was no room in the car. The space between the east rail of the west track and the west rail of the east track was 4 feet. The space in the clear between the two cars involved in this action was 22 inches. The plaintiff was knocked off from the running board, where he was standing, by a southbound closed car striking him on the left shoulder, though no other passenger upon that running board was interfered with in any way.

The trial judge instructed the jury, among other things, that it is the duty of the carrier to use every precaution that human skill and foresight can provide to secure the safety of its passengers. The court holds that, under the circumstances, this was erroneous. It says that there was no qualification of the measure of care which the jury could understand and apply to the case. In other words, the judge stated that the defendant rested under the duty of exercising the "utmost" care. The expression "such precaution as human skill and foresight could suggest" is synonymous with "utmost." The defendant rested only under the obligation to exercise ordinary care.

In this case there was no defect in the roadbed, the rolling stock or in the location of the tracks, 4 feet apart, and the operation of the cars, between which there was a space of 22 inches in the clear. As to the passenger in such a position, where there is no defect in the management or operation of the road save such dangers which are common from the peculiar position occupied by the passenger, the court is of the opinion that the measure of duty on behalf of the carrier is simply to use reasonable care to carry passengers safely under the circumstances. If the court were to apply the rule charged by the court below, that the company was bound to use such precaution as human foresight and skill could suggest—that is, "utmost" care—it would be practically to obliterate the rule that when a passenger voluntarily enters upon this dangerous position he assumes the ordinary risks in this respect. The court does not mean to relax the rule in any other respect except in such cases.

## News of the Week

### St. Louis Tax Ordinance Sustained.

The United States supreme court on May 18 rendered a decision sustaining the right of the city to levy a license tax of one mill per passenger on the street railways of St. Louis in accordance with the ordinance passed on March 25, 1903, as far as constitutional questions are concerned. The decision comes after four years of litigation in the district court at St. Louis, in which the city has twice been defeated in injunction suits brought to prevent the collection of the tax by the St. Louis Transit Company and its successor, the United Railways Company. In accordance with the decision the company will be obliged to pay the city about \$850,000 in back taxes from January 1, 1904, to January 1, 1908, and an annual tax in the future amounting to about \$220,000 on the basis of the present traffic. The ordinance replaced a former ordinance under which the city collected a license tax of \$25 per car. It is stated that the company will apply for a rehearing in the supreme court or renew the case in the lower courts on points not involved in the present case.

### Northwestern Elevated Extension Opened.

The new Evanston extension of the Northwestern Elevated Railroad, Chicago, was opened for regular operation on Saturday, May 16, when through trains were operated on a 10-minute headway from Central street, North Evanston, to the Union loop in Chicago. The first train to make the through trip was an inspection special carrying officials of the Northwestern Elevated Railroad and the Chicago Milwaukee & St. Paul Railway. The extension is over the right of way of the Chicago Milwaukee & St. Paul and connects with the elevated structure by an incline at Wilson avenue. Trains will be run every 10 minutes northbound from 7:08 a. m. to 11:58 p. m., and southbound from 6:20 a. m. to 11:40 p. m., and an hourly service will be operated at night. Cars will be run on an express schedule from Wilson avenue to the loop. The Evanston suburban service of the Chicago Milwaukee & St. Paul has been discontinued. The new cars used for the Evanston service were described and illustrated in the Electric Railway Review of April 25, 1908, page 500.

### Strike in Cleveland.

The controversy between the officials of the Municipal Traction Company and its motormen and conductors, because of the company's refusal to abide by the agreement of the Cleveland Electric Railway to increase the wage scale two cents an hour, came to a crisis on Friday night, when the men voted to declare a strike effective at 5 a. m. on Saturday morning. Since that time the street cars in Cleveland have been running irregularly, manned by non-union men, and the city has been the scene of numerous riots, in which many persons have been injured and several cars have been wrecked.

As reported in last week's issue E. S. Meyer and S. H. Tolles were appointed on Tuesday, May 12, as arbitrators to settle the points of difference. These men were to select a third arbitrator. Mr. Tolles, the company's representative, was out of the city and would not return until Friday. In the meantime the officials of the company continued to discharge old employes of the Cleveland Electric Railway on charges of dishonesty or breach of discipline and to fill their places with non-union men. Angered by these tactics and by what they termed the dilatory attitude of the company toward the arbitration, because Mr. Tolles had not been notified of his appointment, the officers of the union on Thursday sent a letter to Mr. du Pont demanding that no more men be discharged or placed on the extra list and that conditions existing prior to April 27 be maintained pending the decision of the arbitrators. Mr. du Pont refused and on Friday night the strike meeting was held.

The old Forest City employes, who were not affected by the Cleveland Electric agreement, refused to strike, and these, together with others who refused to strike and the non-union men employed within the past few days, furnished sufficient men to operate the cars on an irregular schedule during the day. Little attempt has been made all week to operate cars at night. Many riots occurred in all parts of the city on Saturday and Sunday and the operation of the cars was hindered in every possible way by the strikers and their sympathizers. Feed wires were cut, obstructions were placed on the tracks and the men operating the cars were assaulted and dragged from the cars. Policemen were stationed on every car during the evening and wire screens were placed across the front of the platform to protect the motormen. Three cars were wrecked on Sunday and conflicts between the police and the

strikers were numerous. On Monday and Tuesday disturbances became more frequent. Several cars were wrecked with dynamite, injuring many of the passengers, and several men were shot during attacks on the cars by the rioters.

Interurban cars were allowed to enter the city unmolested, but not to receive passengers within the city limits. Very few passengers were carried by any of the cars on account of the danger of attack, and although bus lines have been established, most of the people have had to walk. The steam roads increased their suburban service and handled large numbers of people who have ordinarily used the street cars.

The state board of arbitration has been active from the start in attempting to bring about a settlement of the strike by arbitration and several conferences have been held with representatives of the union and of the company. Mr. du Pont refused to talk arbitration until the rioting was stopped. Conditions were better on Wednesday and both sides agreed to arbitrate. The principal point of difficulty has been in regard to the terms of reinstatement of the strikers. Mr. du Pont agreed to take all of the men back, but as new men, thereby giving preference in the matter of runs to the non-union men who have been employed recently. The union men insisted on being restored to their old runs. On Wednesday night it was believed that a settlement would be reached within a few hours.

#### Decision of Arbitrators on Pittsburg Wage Reduction.

The arbitrators appointed to settle the controversy between the Pittsburg Railways Company and its conductors and motormen announced a decision on May 14, by which the company is authorized to reduce wages one-half cent per hour, dating from May 9, 1908, to April 30, 1909. The present scale is 25, 26 and 27 cents per hour, according to length of service, which represents an increase of 33½ per cent since January 1, 1902. On May 1 the company proposed to reduce wages one cent an hour on the grounds that its earnings had been decreased by the general business depression. After a controversy the question was left to an arbitration committee composed of M. K. McMullin, representing the company; Calvin Wyatt, representing the employes, and Judge J. J. Miller, chosen by the first two. The decision of the committee is as follows:

"The majority of arbitrators after a careful consideration of all the evidence, having especially in view the fact that in the last five months there has been a deficit of \$292,549 in car fares, compared with the five months of the year previous; that the wages of conductors and motormen were raised two cents per hour one year ago based on the prosperous condition then existing; that the reduction in the number of cars in present operation, and consequent decrease in the amount of wages paid, does not decrease the expenses of operation in proportion to the deficit; believing further that the exorbitant cost of living at present is on a fictitious basis and will decrease before the present business conditions obtain their standing of a year ago, we are of the opinion that in all fairness some modification should be made in the demand of both sides. We therefore split the difference of contention into one-half and fix the rate of reduction at one-half cent per hour. This to control from May 9, 1908, to April 30, 1909."

#### Settlement of Chicago Labor Controversy.

The threatened strike of the motormen and conductors employed by the Chicago Railways Company because the company refused to discharge 20 men who had resigned from the union, was averted on Thursday of this week when the 20 men who had caused the trouble returned to the union and paid their dues, after having failed to secure an injunction restraining the union from striking. As reported in last week's issue the men voted an May 10 by a large majority to strike unless the company enforced the "closed shop" principle. Eight of the former union members immediately applied for an injunction to restrain the union from threatening a strike in the effort to force their discharge. The union filed a demurrer and the case was heard on Tuesday of this week before Judge Walker of the Cook county circuit court, who denied the petition for an injunction.

The court said that the union has already voted to strike and that no threats of violence or other intimidation have been made, and that while the plaintiffs are guaranteed by the constitution the personal liberty to dispose of their labor as they see fit, yet the defendants have the same right and the right to refuse to work. Having this right and choosing to exercise it, it would be absurd to claim that they may not present to the company their reason for doing so. If an injunction such as this could be sustained any two or three men in a union, whether having joined from good motives or bad, could obtain an injunction restraining the rest of the union from quitting work.

Representatives of the union held a conference with President Roach on Wednesday and asked for the discharge of the

20 men. It was finally decided to submit the question to the executive committee of the board of directors on Monday. On Thursday the men who had withdrawn from the union secured reinstatement and the controversy was ended.

#### Transit Affairs in New York.

The New York public service commission of the first district held a hearing on May 13 in regard to the recommendations of Bion J. Arnold of Chicago that the subway cars be provided with two additional side doors at each end, which were included in an exhaustive report submitted to the commission in February. [An abstract of the report was published in the Electric Railway Review of February 29, 1908, page 262.] Frank Hedley, general manager of the Interborough Rapid Transit Company, and Mr. Arnold were the principal witnesses. Mr. Hedley agreed with Mr. Arnold that the cost of transforming a steel car would be about \$2,000, but thought that the cost of changing the wooden cars would be about \$2,200, instead of \$1,800, as estimated by Mr. Arnold. He thought that the result would be an unsatisfactory piece of work and that the increase of weight, 3,300 pounds for wooden or composite cars and 1,200 for steel cars, would make operation more costly and less speedy. Mr. Hedley also had doubts as to whether the New York public would take readily to the plan and said that the present type of cars was best suited for the present conditions of the subway, on account of the curved platforms.

The appellate division of the supreme court on May 15 granted the public service commission an order extending for three years from October 15, 1908, the time in which the construction of several subway routes in Manhattan may be started under the original authorization given to the old rapid transit commission. The routes referred to are the Third avenue, Seventh and Eighth avenues, Lexington avenue, White Plains, Jerome avenue, Girard avenue, Thirty-fourth street and Fourteenth street routes.

Representatives of a large number of civic organizations of Staten Island appeared before the public service commission on May 15 to urge that the plans for the Fourth avenue subway be modified so that the route may be extended under the Narrows to Staten Island.

The new subway terminal station for trolley cars at the Manhattan end of the Williamsburg bridge was opened on May 19 for regular service. Hitherto the cars crossing the bridge from the Brooklyn side have been run into a series of surface switches, and in the rush hours there has been congestion and confusion. Now the cars will be run into a subway terminal station which has been equipped with eight loops. Separate platforms, entrances and exits have been built for each loop. The incoming and outgoing passengers will be separated, and confusion in the loading and unloading of cars will thus be avoided. It is expected that elevated trains will be operated across the bridge by July 1.

William Bradley, the contractor for the section of the Brooklyn bridge loop subway just north of the Brooklyn discone, has been ordered by the public service commission to discontinue all work except excavation until the detailed plans for the new Municipal building are completed.

Samuel Lea, third vice-president of the Pennsylvania Railroad, has written a letter to Comptroller Metz supporting the contention of John B. McDonald that there is no need for the proposed Broadway-Lexington avenue subway and urging that the requirements of the city at the present time would be better met by the construction of a branch of the present subway from Forty-second street south under Seventh avenue, serving the Pennsylvania and Long Island railroad terminals.

Comptroller Metz presented to the board of estimate on May 16 a report on the city's financial condition which shows that the total borrowing capacity of the city at present under the constitutional debt limitation, based on 10 per cent of the assessed valuation, is only \$1,443,725, so that no subway contracts can be let until after July 1, when the debt limit will be increased by the increased valuation of real estate.

**Machinery Club of New York.**—The Machinery Club of New York formally opened the club rooms, which occupy the twenty-first and twenty-second floors of the Fulton Terminal building at 50 Church street, New York, on the afternoon of Thursday, May 21.

**Consolidation Bill Reported.**—The committee on street railways of the Massachusetts senate has reported a bill authorizing the purchase of the Bennington & North Adams Street Railway of Hoosic Falls, N. Y., by the Berkshire Street Railway of Pittsfield Mass.

**Railroad Club of New York.**—On May 18 the rooms of the Railroad Club of New York, on the twenty-first and twenty-second floors of the Cortlandt street building of the Hudson Terminals, were formally opened. The officers of the club are: E. H. Gary, president; F. D. Underwood, vice-president; C. W.

King, secretary and treasurer. On the house committee are: W. G. McAdoo, W. G. Oakman, W. H. Marshall, F. B. Jennings and W. G. Besler. The board of governors includes William H. Barnum, Anthony N. Brady, C. A. Coffin, E. C. Converse, R. W. De Forest, F. H. Fisk, Clarence H. Kelsey, George R. Sheldon and Cornelius Vanderbilt.

**Brotherhood of Locomotive Engineers Admits Motormen.**—At the annual convention of the Brotherhood of Locomotive Engineers, held in Columbus, it was voted to admit to membership the motormen operating electrically drawn trains on steam railways. It was also voted that engineers in Cuba be admitted to the brotherhood.

**American Institute of Electrical Engineers, Chicago Section.**—It is announced that a meeting of the Chicago Section of the American Institute of Electrical Engineers will be held in the rooms of the Western Society of Engineers in the Monadnock block on Friday evening, May 22. The paper of the evening will be "Water Power Development of Michigan," by F. E. Greenman of Grand Rapids, Mich.

**Suit to Enjoin Operation of Interurban Cars in Milwaukee.**—Residents of Wells street, Milwaukee, Wis., have filed a suit in the circuit court asking an injunction restraining the Milwaukee Light Heat & Traction Company from operating interurban cars over the tracks of the Milwaukee Electric Railway & Light Company on that street, claiming that the company has no franchise for the operation of interurban cars.

**Car Cleaning Order in McKeesport.**—The board of health of McKeesport, Pa., has notified the Highland Grove Traction Company, the Pittsburg Railways Company and the West Penn Railways Company, the three companies operating in McKeesport, that hereafter they will be required to comply with a new regulation of the board that all cars must be dusted and cleaned with a damp cloth daily and must be fumigated and washed with soap and hot water weekly.

**Ottawa Employees Ask Wage Arbitration.**—The motormen and conductors of the Ottawa (Ont.) Electric Railway have applied to the department of labor for an arbitration of their demand for an increase of wages, which has been refused by the company. The men are asking for 22 cents an hour for the first year's service and 23 cents an hour thereafter, with an additional 2 cents an hour for Sunday work. The present scale is 17½, 18½ and 19½ cents an hour, according to length of service, with 2 cents additional on Sunday.

**Strike in Wilmington, Del.**—Employees of the Wilmington City Railway, who have recently organized a branch of the Amalgamated Association of Street and Electric Railway Employees, declared a strike on May 17 because the company refused to reinstate five conductors and motormen who were discharged when they became officers of the new union. The company was able to maintain its schedule on Sunday, but the strikers have made preparations for a boycott and several scenes of disorder have resulted. It is stated that the underlying cause of the strike is the reduction of wages from 18½ to 16½ cents an hour, which went into effect on April 1.

**Accidents in New York.**—According to the reports compiled by the New York public service commission of the first district, there were in April 4,707 accidents upon the street railways, subways and elevated roads within its jurisdiction. This shows a steady increase since the beginning of the year. In January there were 3,921 accidents, in February 3,951 and in March 4,353. The accidents specified in April were 138 car collisions, 929 persons and vehicles struck by cars, 562 persons injured while boarding cars, and 544 while alighting. Contact with electric rails or wires accounted for 36 accidents. Altogether there were 2,836 persons injured. Of these, 1,671 were passengers, 662 persons not passengers and 503 employes. These figures also show an increase. Of the persons injured in April, 30 died.

**New England Street Railway Club.**—The regular monthly meeting of the New England Street Railway Club will be held in the Electrical Engineering building of the Worcester Polytechnic Institute, Worcester, Mass., on Tuesday evening, May 26. On invitation of the Worcester Polytechnic Institute, the members of the club will be given an opportunity to inspect the new laboratory building and equipment, particularly that portion which is devoted to railway work. Some experimental demonstrations of high-voltage apparatus will be given. Previous to the inspection of the laboratory building the club will be favored with an address by Albert S. Richey, professor of electric railway engineering. Through the courtesy of the Boston Elevated Railway, the Boston & Worcester Street Railway and the Worcester Consolidated Street Railway, the party will be taken from Boston to Worcester and return. Special cars will be provided by the Boston & Worcester Street Railway.

# Traffic and Transportation

## Commission's Order Provides Excessive Number of Seats.

At a hearing before Commissioner Maltbie of the New York public service commission, first district, some of the inspectors of the commission reported that the order issued some time ago calling for a stated increase in the number of cars run on the Eighth avenue line had been obeyed, and that, as a consequence, there were in operation on Sundays, rainy days, and other times when the traffic was light, more cars than were necessary to provide a seat for every passenger.

The subject of the service in this line will be reopened, and it is probable that a more elastic order will be issued.

## Orders of the New York Public Service Commission, Second District.

The New York public service commission, second district, announces that it has ordered the Black River Traction Company, Watertown, N. Y., to put in force by June 1 a rate of fare not to exceed five cents per passenger for transportation from Watertown to Glen Park. The new rate is to continue for at least three years, with leave to the company or any person interested to apply for a modification at any time. The company has been charging a 10-cent fare.

The commission has ordered the Port Jervis (N. Y.) Electric Light Power Gas & Railroad Company to repair its equipment and supply appliances to secure reasonably the safety and comfort of passengers on its lines. The repairs, changes and improvements are to be completed, subject to the approval of the commission, within three months. The company is required to present within 20 days its plans and specifications for the improvements.

## Further Discontinuance of Transfers in New York.

Judge Lacombe of the United States circuit court, New York, heard arguments on May 15 on the petition of Frederick W. Whitridge, as receiver of the Union Railway Company, to abolish the transfer system in operation between the Union road, the Yonkers Railroad and the Westchester Electric Railroad. The reason given for this, besides the unprofitableness, the lines of each company.

The petition states that the Union Railway Company is under no contract or obligation to exchange transfers with the other two roads and that to continue to do so is inimical to its interests. "The abolition of the transfers may cause considerable public inconvenience," the petition says, "but the public has the power to avoid it."

In pursuance of the plan to discontinue the present transfer system it is found necessary to discontinue certain joint operations now carried on between the three roads.

The petition states further that it is proposed to discontinue the sale of transfer tickets with the Manhattan Elevated road. The reason given for this, besides the unprofitableness, is the opportunity such transfers give for fraud in the purchase and sale of transfers by individuals.

Judge Lacombe was inclined to sympathize with the efforts of Mr. Whitridge to do away with transfer abuses, and he told of a trip he took from Third avenue and One Hundred and Twenty-ninth street by transfer to Mount Vernon, thence to Yonkers by transfer, and back to Williamsbridge still on a transfer—a ride of more than 18 miles for five cents.

## Union Elevated Loop Decision.

In a decision in connection with the suit brought by the Metropolitan West Side Elevated Railway of Chicago against the Northwestern Elevated Railroad, Judge Carpenter of the Cook county circuit court said concerning the lease between the owner and lessee companies of the Union Elevated loop: "I am satisfied that the document is a lease and contains an express covenant on the part of the operating railroads. And so long as the proportion of cars on the loop to be operated by one of the companies depends on the facts shown by the monthly reports of each, it is difficult to see what the board of managers, as arbitrators, have to do with that proposition."

"The construction of the loop was a great burden on the rights of the people. It interferes with traffic; it destroys the light in offices and stores along the right of way; the noise and rumbling of the cars are a great nuisance. In the interest of the public, however, all these must be borne, the evil consequences having been reduced to a minimum by the city council requiring all the companies to operate on this single loop."

The court sustained the position of the Metropolitan road in holding that "while no complaint is made that the board of managers, as at present constituted, is disqualified to undertake the administrative work of the loop property, as between

the Northwestern road as lessor and any one of the operative companies, the president of the Northwestern road is not a proper member of the board of managers."

The effect of the decision is to refer the original question concerning the proportion of the loop service to be allowed each company for a further hearing.

#### Impossibility of Maintaining Schedules at Charlestown, Mass.

The Massachusetts railroad commission has made a reply to the petition of the Charlestown Improvement Association for additional service on surface lines of the Boston Elevated Railway in Charlestown. An abstract of the reply follows:

"By reason of the frequent opening of the draw span of the Charlestown bridge, the operation of trains at grade at the crossing of the Boston & Maine Railroad near Sullivan square, and congested highway traffic at the 'rush hours' on Main street, delays in surface-car operation are unavoidable. The unsatisfactory conditions are not due to an insufficient number of cars, but the impossibility under present physical conditions of maintaining schedules.

"The installation of an additional line would tend, in the opinion of the board, to further congest the traffic. The surface-car traffic tables furnished by the company are convincing upon this point. A so-called belt line, if installed, might possibly be operated without being subject to bridge and grade crossing delays, but in order so to do, cars on the belt line would be obliged, near City and Sullivan squares, to make a crossover against traffic, reversing trolley poles and stalling cars. To undertake to do this at points as congested as these are with frequent car service and heavy teaming, would further disarrange existing schedules. The only feasible way by which a belt line, properly so termed, could be successfully operated would be by the acquisition of new locations by the company near City and Sullivan squares, involving grants of location and the construction of special work for trackage.

"The board is unable to recommend this action to the company, in view of the situation as a whole, and especially in view of the service as at present rendered.

"It is hoped that the completion of the Washington street subway with a consequent rearrangement of operation may relieve the situation. In the meantime the board will exercise a careful oversight of conditions within the Charlestown district, and recommends to the company that earnest endeavor be constantly made to minimize, so far as possible, surface car delays in that area; but it must be realized that physical conditions now cause many unavoidable delays, for which neither the residents of Charlestown nor the company are primarily responsible."

**Appeal Against Philadelphia Transfer Change.**—The United Business Men's Association of Philadelphia will appeal to city councils against the decision of the Philadelphia Rapid Transit Company to require a cash fare for every transfer.

**Steam Lines Withold Facilities from Winona Road.**—H. S. Dickey, general superintendent of the Winona Interurban Railway, Winona Lake, Ind., has filed petitions with the Indiana railroad commission asking that the commission compel the Cleveland Cincinnati Chicago & St. Louis Railway and the Pittsburg Ft. Wayne & Chicago Railway to interchange traffic with the Winona Interurban road. Mr. Dickey states that the two steam roads have entered into an agreement not to exchange business with the Winona road. He says that the Cleveland Cincinnati Chicago & St. Louis road has served notice that it will refuse to deliver any cars to the Winona company to be switched to industries on the Winona line. The Pittsburg Ft. Wayne & Chicago road, Mr. Dickey says, has refused to deliver cars to the connecting tracks between the railroad and the interurban line at Winona Lake.

**Through Trips Between Chicago and Indianapolis.**—The Indiana Union Traction Company, Anderson, Ind., has completed arrangements with the Chicago Cincinnati & Louisville Railroad to sell through tickets between Chicago and Indianapolis. Arrangements have been made for two connections daily in each direction. Trains of the Indiana Union Traction Company will leave Indianapolis at 11:30 a. m. and 11:30 p. m., running as through special trains to Peru. Connection will be made with the steam road at Peru. Passengers on the electric cars will have a convenient method of transfer, as the tracks of the steam and electric lines will adjoin. For the night run to Chicago a sleeper will be on the track at Peru and can be occupied after 9 o'clock if travelers desire to leave Indianapolis on an earlier traction train than the one which makes close connection. The rate for a berth will be \$1.00 less than the regular berth rate on through steam roads from Indianapolis. F. D. Norviel, general passenger and freight agent of the Indiana Union Traction Company, who has completed the arrangements for the through trips between Indianapolis and Chicago, announces that similar through service is in process of arrangement with the Wabash Railroad and the Toledo St. Louis & Western Railroad.

# Construction News

## FRANCHISES.

**Ballston Spa, N. Y.**—The Schenectady Railway Company has secured permission from the board of trustees to lay tracks across Bath street.

**Brooklyn, N. Y.**—The Brooklyn Rapid Transit Company has applied to the board of estimate for a franchise to lay tracks on the triangle at Flatbush, Fourth and Atlantic avenues where the Long Island Railroad station and subway terminal are located.

**Cheyenne, Wyo.**—It is stated that S. G. Griffin and Daniel Hewitt of Colorado Springs, Colo., the latter president of the Interstate Railway & Improvement Company, will make application for a franchise to build a 5-mile electric line through Cheyenne and on to Ft. Russell. The franchise also calls for electric lighting. It is intended to complete the line by August of this year.

**Colorado Springs, Colo.**—Henry J. Arnold of this city, representing western capitalists, has applied to the city council for a franchise to build an electric line from the Chicago Milwaukee & St. Paul station west to Excelsior Springs, one mile. This line will care for the increasing summer tourist travel from Colorado Springs to Excelsior Springs, which heretofore has been served only by bus lines.

**Elk Lick, Pa.**—The Pennsylvania & Maryland Street Railway Company has filed notice of an extension of route from Broadway and Grant street, Meyersdale, to Garrett, and about 1,000 feet beyond Garrett to a connection with an existing line of the company. C. H. Jennings, Jennings, Md., is president.

**La Crosse, Wis.**—The La Crosse City Railway Company has asked for an extension of one year's time in which to complete the proposed extension of the Market street line. Under the former franchise the work was to be completed in 1908 under penalty of \$1,000.

## RECENT INCORPORATIONS.

**Arizona Southern Railway.**—Incorporated under the laws of Minnesota to build a steam or electric railroad in Arizona. Capital stock, \$50,000. Incorporators: Cleve Van Dyke, Warren, Ariz.; T. A. England, Alexandria, Minn.; Arthur A. Van Dyke, St. Paul, Minn.

**Geneva Railway Securities Company.**—Incorporated as a holding company to take over the securities held by the Geneva Waterloo Seneca Falls & Cayuga Lake Traction Company, which operates a 17½-mile interurban line connecting the towns named. Capital stock, \$567,000. Incorporators: Walter G. Merritt, New York; David B. Henney, Hartford, Conn.; James A. McNelis, Brooklyn, N. Y.

**Oklahoma El Reno & Shawnee Rapid Transit Company.**—Incorporated in Oklahoma to construct a line from El Reno to Shawnee by way of Oklahoma City at an estimated cost of \$20,000 per mile. Capital stock, \$1,500,000. Incorporators: A. Huber, J. A. Niblo, W. M. Sawyer, S. L. Niblo, Oklahoma City; Charles E. Davis, Lugert, Okla.

**Rapid Transit Company, Yazoo City, Miss.**—Incorporated in Mississippi with a capital stock of \$10,000. Incorporators: T. F. Davis, W. A. Henry, Jr., and others.

**Vicksburg Traction Company, Vicksburg, Miss.**—Incorporated in Mississippi to operate an electric railway in Vicksburg. Capital stock, \$10,000. Incorporators: S. S. Bullis, J. W. Cassell, and others of Vicksburg, Miss.

## TRACK AND ROADWAY.

**Ardmore Street Railway, Pittsburg, Pa.**—It is announced that this company's double-track line from Wilkensburg to the Westinghouse works at East Pittsburg, Pa., will be opened about June 1. The car house and power plant are located in about the middle of the line. Power will be furnished for lighting. William Finn is president and H. P. Haas, vice-president.

**Boise Valley Railway, Boise, Idaho.**—It is reported that construction has been started on an extension of the Boise-Nampa line to Meridian, Idaho. (Noted February 8.)

**Burlington-Bonaparte Interurban Railway, Burlington, Ia.**—E. E. Egan, secretary, is now engaged in making right of way contracts and adjusting preliminary details for the proposed line from Burlington to Bonaparte, Ia., 40 miles. Surveys have been completed by the Wallace-Coates Engineering Company, Chicago. (Noted February 8.)

**Burlington Interurban Railroad.**—This company has been organized to build an electric railway from Hudson to Greeley, Colo. Fred Olson of St. Paul, Minn., and J. Fletcher, John Clug and Ray Watson of Eaton, Colo., are interested.

**Denver (Colo.) City Tramway.**—On May 15 this company began operating over 10 miles of new city tracks, which makes a total of 22 miles constructed under the franchise granted on May 15, 1906. The new lines are as follows: From Sixteenth and Arapahoe streets to the city limits at Globeville, where connection will be made with the Denver & Interurban Railway; an extension of the West Forty-fourth avenue line from Gallup avenue to Lakeside; on Eighteenth street from the Union depot to Welton street.

**Edgefield & Augusta Electric Railway, Edgefield, S. C.**—This company is being organized to build an electric railway from Edgefield to Augusta, Ga., and a committee has been appointed to solicit stock subscriptions.

**Illinois Traction Company, Champaign, Ill.**—President W. B. McKinley has received from the United States war department a letter stating that the company will not be required to make any changes in its plans for the bridge across the Mississippi river. Since the plans were approved at a hearing on June 20, 1907, several protests have been made against the plans on the grounds that the bridge would obstruct navigation. The engineers of the war department have investigated the matter and report the objections unfounded.

**Indianapolis & South Bend Traction Company, Indianapolis, Ind.**—It is planned to begin grading in a few days on the line from Logansport to Burlington, Ind., 20 miles. Surveys are now being made. It is hoped to complete the line from Logansport as far as Frankfort this year. J. Shafer, chief engineer. (Noted April 4.)

**Kansas City & Bonner Springs Railway, Kansas City, Mo.**—This company has begun operating cars from Bonner Springs to the Bonner Portland Cement Company plant, about 1½ miles, and will soon operate over an extension to Forest Lake. The line connects with the Metropolitan Street Railway at Eighteenth street and Minnesota avenue in Kansas City. Kan. Park Williamson of Edwardsville, Kan., is chief engineer.

**Kansas-Colorado Power & Railroad Company.**—A meeting of about 400 delegates from towns on the Arkansas river, Colorado, was held at La Junta, Colo. on May 14 to hear a proposition made by A. B. Hult, representing the Northern Electrical Manufacturing Company of Madison, Wis., relative to the organization of a company to build power plants, transmission lines and an electric railroad from Canyon City, Colo., to Dodge City and Scott City, Kan., connecting the principal towns in the Arkansas Valley. A committee of 13 was appointed to perfect the organization and incorporation of the Kansas-Colorado Power & Railroad Company, with a capital stock of \$3,500,000, to be increased later to \$15,000,000. It is proposed to build a large power plant on the Arkansas river near Canyon City to be used in connection with an extensive irrigation system, and to provide power for commercial purposes. The Northern Electrical Manufacturing Company proposes to do the preliminary work, and make surveys and estimates and to contract for the construction of the power plant, transmission lines and railroad for mortgages on land in the territory covered by the project. The committee is as follows: Alva Adams, Pueblo; Andrew McClellan, Pueblo; S. H. Atwater, Canyon City; F. D. Pastorius, Colorado Springs; J. N. Beaty, Manzanola; J. A. Lockhart, Rocky Ford; Robert W. Patterson, La Junta; Donald McIntosh, Las Animas; W. C. Gould, Lamar; A. H. Warner, Garden City, Kan.; Fred Humphreys, Syracuse, Kan.; W. O. Bourne, Scott City, Kan., and Andrew Russell, Dodge City, Kan.

**Marquette Negaunce & Ishpeming Interurban Railway, Marquette, Mich.**—J. W. Barber, secretary, writes that contracts will be let this month for grading the line from Marquette to Negaunce, Mich., 14 miles. Charles Cumming is chief engineer. (Noted May 9.)

**Milwaukee & Fox River Valley Railroad, Fond du Lac, Wis.**—The Wisconsin railroad commission held a hearing last week on the application of this company for a certificate granting permission for the construction of the proposed line from Appleton, Kaukauna and Fond du Lac, via Chilton, Plymouth and Cedarburg to Milwaukee, Wis. The application was opposed by the Milwaukee Electric Railway & Light Company and the Milwaukee Northern Railway. The latter company objects to the line from Cedarburg to Milwaukee. J. M. Saemann of Sheboygan is president. (Noted May 9.)

**Minnesota Construction Company, Minneapolis, Minn.**—This company has been organized, with a capital stock of \$100,000, to build an electric railway from Minneapolis to Medicine Lake, Minn., which is to be extended later to Montevideo,

via Wayzata, Long Lake, Stubbs Bay and Winsted. It is proposed to build the line in 6-mile sections and right of way has been obtained for the first section. Officers: President, John Blichfeldt; vice-president, Major Lonstaff; secretary and treasurer, W. W. Bardwell.

**Nashville Interurban Railway, Nashville, Tenn.**—Construction work on the line from Nashville to Franklin, Tenn., 20 miles, which was suspended in January, was resumed a few days ago and a force of 200 men is employed in grading and tracklaying. About 12 miles of grading was completed last year. It is expected to have the line in operation by October 1. H. H. Mayberry, president.

**Northern Traction Company, Hibbing, Minn.**—R. F. Berdie, president, writes that this company proposes to build an electric railway from Hibbing to Eveleth, Minn., 33 miles, via Chisholm, Buhl, Spina, Mt. Iron and Virginia. Grading has been completed from Hibbing to Chisholm, three miles, and one mile of track has been laid.

**Oregon Interurban Railway, Oregon, Mo.**—We are advised that this company will receive sealed bids up to 6 o'clock p. m. on Wednesday, June 10, 1908, for the construction of 4½ miles of railroad from Oregon to Forest City, Mo. The approximate quantities follow: 60,000 cubic yards of excavation; 47,000 cubic yards of embankment; 62,600 feet of timber and lumber; 2,060 lineal feet of piling, 16 to 35 feet long; 405 tons of 56-pound relay steel rails; 13,000 ties; one steel bridge, 60-foot span; 4½ miles of tracklaying. Specifications, contract, blank proposals, profile and plans can be seen at office of the company. Bids will be received on any one or more items of above; also on the road complete. The board of directors reserves the right to reject any and all bids. B. F. Morgan, Oregon, Mo., president; George Custer, Marysville, Mo., engineer. (Noted May 16.)

**Pacific Traction Company, Tacoma, Wash.**—It is reported that this company is planning to extend its American Lake line to the encampment grounds on the other side of the lake this summer. E. J. Felt, vice-president and manager.

**Redlands & Yucaipa Electric Railway, Redlands, Cal.**—This company is arranging to begin construction immediately on its proposed line connecting Redlands, Yucaipa and Oak Glen, Cal., about 22 miles long. It is proposed to erect a power station and repair shop at Redlands. Amusement parks will be operated at Cherry Croft and Oak Glen. Officers: J. M. Neeland, Los Angeles, president; C. S. Chesnut, Redlands, vice-president; C. D. Meyers, Redlands, secretary; M. N. Newmark, Los Angeles, treasurer; W. D. Larrabee, Redlands, general manager. (Noted May 2.)

**Rochester Corning & Elmira Traction Company, Rochester, N. Y.**—W. C. Gray, chief engineer, 27 Church street, Rochester, writes that grading has been completed from Conesus Lake to Groveland, seven miles, on the proposed line from Rochester to Elmira, N. Y., 120 miles. Grading is in progress from Rochester to Lakeville, 27 miles. The overhead construction will be of the catenary type, for single-phase operation. The Rochester & Southern Construction Company has the general contract. The road will be double-track, laid with 70-pound rails, and will be built according to steam railroad standards. Otto F. Lieders is president; George A. Engert, general manager and treasurer, and S. Feuerstein, electrical and mechanical engineer. (Noted May 2.)

**Rochester Scottsville & Caledonia Electric Railroad, Rochester, N. Y.**—David C. Salyers of Scottsville, N. Y., president, has announced that all the right of way and franchises have been secured for the proposed line from Rochester to Portage Falls, N. Y., 52 miles, and that the contract for a considerable part of the construction work will be let in the near future. The route includes Scottsville, Caledonia, Le Roy, Pavilion and Castle. Branches from Pavilion to Warsaw, 12 miles, and from Le Roy to Batavia, 10 miles, are also contemplated. The road will be built for high-speed service, on private right of way, and will be laid with 70-pound rails. Le Grand Brown is chief engineer. (Noted December 7, 1907.)

**Rome & Osceola Railroad.**—Surveys have been made and right of way has been secured for a line to be operated by either steam or electric power from Rome to Osceola, N. Y., 25 miles. The capital stock is \$500,000. Officers: W. Pierrepont White of Utica, N. Y., president; Clifford Lewis, Jr., of Utica, chief engineer.

**Stebenville & East Liverpool Railway & Light Company, Stebenville, O.**—In order to complete the extension from East Liverpool to Midland and Vanport, Pa., this company is reported to have increased its construction force from 200 to 1,200 men. J. C. Rothery, general manager.

**Terre Haute Robinson Olney & Southwestern Railway, Robinson, Ill.**—A contract has been let to Charles B. Duffy

of St. Louis, Mo., for the construction of the proposed electric railway from the Wabash river on the boundary line of Illinois and Indiana to Mt. Vernon, Ind. (Noted April 25.)

**Texas Traction Company, Dallas, Tex.**—The overhead construction on the line from Dallas to Sherman, Tex., has been completed between McKinney and Sherman. (Noted May 9.)

**Tropico, Cal.**—It is proposed to build an electric railway from Tropico to Burbank, Cal., and a committee has been appointed to secure subscriptions and right of way.

**Twin City & Lake Superior Railway, Minneapolis, Minn.**—Smith & Jones of Minneapolis have been awarded a contract for clearing and grading for about 30 miles south of the Minnesota-Wisconsin state line near Foxboro on the line from Minneapolis and St. Paul to Duluth and Superior, Wis., 129 miles. Last year grading was completed from Minneapolis to Sunrise, Minn., 38½ miles. Work under the new contract is to be started at once. E. W. Farnham is president and J. H. Thomas is chief engineer, both with headquarters in the Railway building, Minneapolis. (Noted February 1.)

**Wabash Valley Traction Company, Clinton, Ind.**—D. C. Johnson, president, writes that preliminary work in connection with the proposed line from Danville, Ill., to Terre Haute, Ind., is now being carried on and subscriptions to the stock are being secured. It is hoped to incorporate in about 10 days. (Noted April 18.)

**York (Pa.) Railways Company.**—This company is said to be considering an extension from the Country club road to Richland avenue, York, Pa. David Young, Jr., general manager.

#### POWER HOUSES AND SUBSTATIONS.

**Brownsville Masontown & Smithfield Street Railway, Masontown, Pa.**—A power plant for the operation of this company's proposed 120-mile system of interurban railroads connecting Morgantown, W. Va., and Pittsburg, Pa., will be built at West Masontown, 1½ miles west of Masontown on the Monongahela river. This location is about the central point in the system where cheap fuel and water rights are available. It is intended to have the line completed within a year. W. J. Sheldon, McKeesport, Pa., is president.

**Escanaba Electric Street Railway, Escanaba, Mich.**—On and after July 1 this company will receive power for the operation of its electric railway lines from the hydro-electric power plant of the Escanaba Pulp & Electric Company at Flatrock, Mich., the machinery for which is now being installed. The plant will cost approximately \$80,000 and will have an output of 1,200 horsepower. (Noted April 18.)

**Guadalajara, Mexico.**—The Compañía de Tranvías Luz y Fuerza de Guadalajara, which operates the lighting and street railway systems of this city, expects to enlarge its generating stations at La Junta and Juanacatlan, state of Jalisco. It is stated that the present single-phase lines will be equipped for three-phase operation. Comal Corres, general manager, Guadalajara.

**Mississippi River & Electric Power Company, Monticello, Minn.**—Permission has been granted by the war department for the construction by this company of two dams on the Mississippi river, one at Monticello and another at Clearwater, Minn. The company owns right of way on both sides of the river from Monticello to the southern limits of St. Cloud, Minn., and in addition to furnishing power for lighting purposes is empowered by its charter to construct and operate electric railroads.

**Salisbury & Spencer Railway, Salisbury, N. C.**—A substation will be built jointly by this company and the Southern Power Company, which has just secured entrance into Salisbury, to cost approximately \$20,000. H. W. Frund, general manager, Salisbury.

**United Railroads of San Francisco.**—This company has contracted with the General Electric Company for a Curtis steam turbine direct connected to a 5,000-kilowatt General Electric three-phase 13,200-volt generator to be installed in the North Beach power house. The capacity of the boiler plant also may be increased.

**West Penn Railways, Pittsburg, Pa.**—This company is building a substation at New Salem Junction, Pa., which will be equipped with two 300-kilowatt 60-cycle motor-generator sets and transformers for transforming and converting current from 22,000 volts, three-phase, to 650 volts, direct current. The company also is rebuilding its storage battery plant at Uniontown and has ordered a 3,250-kilowatt Westinghouse turbo-generator set for installation in the main power station at Connellsville, Pa. It is stated that new coal bunkers and the enlargement of the coal-handling machinery are contemplated.

## Personal Mention

Mr. H. C. Allen has been appointed general passenger and freight agent of the Erie Traction Company, Erie, Pa.

Mr. G. W. Mulks, heretofore secretary and auditor of the Los Angeles Interurban and Pacific Electric Railway companies, has resigned.

Mr. H. C. Young, formerly general passenger agent of the Lake Shore Electric Railway, Cleveland, O., has been appointed passenger agent for the Cedar Point Resort Company, operating a pleasure resort near Sandusky, O.

Mr. Bury Irwin Dasent, for the past three and one-half years publicity agent for the Portland Railway Light & Power Company at Portland, Ore., has resigned to become manager of the publicity bureau recently organized to promote the interests of the city of Albany, Ore.

Mr. D. H. Fitts has been appointed general freight agent of the Springfield & Xenia Railway at Springfield, O., succeeding Mr. W. E. Green, resigned. Mr. Fitts has been with the company for a number of years, having started work as motorman.

Mr. L. M. Golliday has been appointed train dispatcher of the southern division of the Public Service Railway at Camden, N. J. Mr. Golliday has had 12 years' experience on steam roads and the interurban lines of Ohio and the middle west, having resigned from the Columbus Delaware & Marion Railway at Columbus, O., to accept his present position.

Mr. D. W. Pontius of Riverside, Cal., has been appointed traffic manager of the Los Angeles-Pacific Railway, effective on May 1, succeeding Mr. F. A. Short, who has been assigned to other duties. Mr. Pontius has been in the service of the Southern Pacific Company for the past 17 years and for the past year has been the company's commercial agent at Riverside.

Mr. A. T. Clark, heretofore assistant to the superintendent of shops of the United Railways & Electric Company, Baltimore, Md., has been appointed acting superintendent of shops, effective on May 9, 1908, succeeding Mr. H. H. Adams, resigned, as noted in the Electric Railway Review for May 16. Mr. H. A. Leonhauser, formerly general foreman of car houses, has been appointed assistant to Mr. Clark.

Mr. A. Sickler was elected vice-president of the Philadelphia & Easton Electric Railway of Doylestown, Pa., at the annual meeting of the company held last week. Mr. J. C. Lugar, general manager and purchasing agent, was elected treasurer of the company, succeeding Mr. J. S. Rawson, who was elected a director. Mr. W. S. Chambers was elected secretary and Mr. David P. Ayars was re-elected president.

Mr. Williston Fish, who has been connected with the law department of the Chicago Union Traction Company since 1899, has been appointed assistant to the president of the Chicago Railways Company. Mr. Fish took a prominent part in the readjustment of the affairs of the Chicago Union Traction Company during the period of its reorganization into the Chicago Railways Company. He is a graduate of West Point.

Mr. N. C. Draper, formerly vice-president and general manager of the Eastern Wisconsin Railway & Light Company, Fond du Lac, Wis., has resigned, effective on June 1, to become district manager of the Zanesville division of the Ohio Electric Railway, with headquarters at Zanesville, O. Mr. Draper has been at Fond du Lac since November, 1895, having previously been connected with the Cleveland office of the Westinghouse Electric & Manufacturing Company. Practically all of his business life has been spent in the installation and equipment of various large electric plants and railway properties throughout the country, and he is therefore particularly well fitted to assume his new duties, comprising the management of 20 miles of city and 65 miles of interurban line in the Zanesville district of the Ohio Electric Railway. The appointment is effective on June 15.

According to press dispatches the Oklahoma legislature has passed a bill to empower the state labor commissioner to fix the scale of wages of labor employed in the various industries in the state. The measure only awaits the signature of Governor Haskell to become a law. When business is dull wages may be reduced, but when an improvement in conditions takes place they must, under the law, be advanced. Every owner, lessee or operator of any industry is required to make a full report annually to the labor commissioner of the condition, earnings, ownership, etc., of the property.

# Financial News

**Detroit Flint & Saginaw Railway, Detroit, Mich.**—The Detroit (Mich.) Trust Company, trustee under a mortgage given by the Detroit Flint & Saginaw Railway on December 1, 1903, has foreclosed the mortgage. The decree of foreclosure was signed by Charles H. Wisner, judge of the circuit court of Genesee county, and the sale of the road ordered. The date of the sale has been set by the trustee for June 18, 1908. The Detroit Flint & Saginaw Railway Company was incorporated for the purpose of building an electric railway from Saginaw to Flint, but only part of the road has been built. Eleven miles of road extending out of Saginaw are operated by the trust company as receiver. The company has a power plant at Bridgeport, Mich., where the car house is also located. The general offices are in Saginaw. The property offered for sale consists of the physical property and the franchises for the construction of the balance of the right of way from the present terminus through the townships of Bridgeport, Frankenthum, Birch Run, Vienna, Mt. Morris, Genesee, Burton and Flint; also franchises granted by the villages of Mt. Morris and Clio and by the city of Flint. If the road were completed as projected the total mileage would be about 35 miles, serving a population of about 112,000 people. The receiver's report shows that for the year ended November 20, 1907, the road earned above operating expenses, and exclusive of fixed charges, \$7,777.93, with the 11 miles of track and two passenger cars. During the five months ended April 20, 1907, the increase in gross earnings over the corresponding period of the previous year was 7.75 per cent.

**Odessa & Middletown Railway, Odessa, Del.**—The property of this company was bought at foreclosure sale by H. R. Bringhurst for \$8,100. The road is four miles in length. The property was sold at Wilmington, Del., on May 6 under foreclosure of the mortgage securing an issue of \$50,000 bonds.

**Rochester (N. Y.) Railway & Light Company.**—The New York public service commission, second district, has approved the issue of \$1,474,000 of 5 per cent consolidated mortgage bonds. The proceeds will provide for indebtedness.—Gross earnings of the Rochester Railway in the quarter ended March 31, 1908, were \$597,216, as compared with \$561,758 in the corresponding quarter of the previous year. Operating ex-

penses were \$411,890, as compared with \$358,486; net earnings were \$185,326, as compared with \$203,272. On account of a reduction in other income and an increase in fixed charges the surplus for the 1908 quarter was \$67,452, as compared with \$105,908 in the preceding year.

**Scioto Valley Traction Company, Columbus, O.**—Gross earnings in the year ended March 31, 1908, were \$360,035, an increase of \$26,000 over the preceding year; operating expenses and taxes were \$204,239. The deductions from income were \$101,316. During the year the company disbursed \$7,000 on account of accident claims and \$24,000 for maintenance of way and structures.

**Toledo (O.) Railways & Light Company.**—The committee which has been formed to effect a readjustment of the affairs of this company will include the following: Norman B. Ream and C. Ledyard Blair of New York; Myron T. Herrick, president of the Society of Savings; John Sherwin, president of the First National Bank; H. P. McIntosh, president of the Guardian Savings & Trust Company; J. R. Nutt, secretary of the Citizens' Savings & Trust Company, Cleveland, O., and William B. Hale, Chicago.

**Vicksburg (Miss.) Railway & Light Company.**—S. S. Bullis writes as follows: "There will be no change in the properties here and no new line built. On May 4 the property of the Vicksburg Railway & Light Company was sold at receiver's sale to me. I am forming two companies—the Vicksburg Lighting Company, to take over the lighting department, and the Vicksburg Traction Company, to operate the street railway."

**Washington Traction Company, Springfield, O.**—The property of this company was purchased at receiver's sale at Springfield, O., on May 11 by George W. Baker of Washington Court House for \$36,667.

**Wetzel & Tyler Railway, New Martinsville, W. Va.**—H. W. McCoy of Sistersville, W. Va., has purchased the property of this company at judicial sale for \$15,644.

## Dividends Declared.

Citizens' Traction Company, Pittsburg, 3 per cent.  
Columbus (O.) Railway, common, quarterly, 1¼ per cent.  
Kansas City (Mo.) Railway & Light Company, preferred, quarterly, 1¼ per cent.

## ELECTRIC RAILWAY EARNINGS.

	Gross earnings.	Operating expenses.	Net earnings.	Total charges.	Surplus.
Seattle (Wash.) Electric Company, February, 1908.....	346,126.71	240,385.50	105,741.21	55,890.23	49,850.98
Seattle (Wash.) Electric Company, February, 1907.....	288,165.08	177,282.57	110,882.51	43,140.14	67,742.37
Seattle (Wash.) Electric Co., March 1, 1907, to Feb. 29, 1908..	4,234,142.55	2,771,707.27	1,462,435.28	621,226.45	841,208.83
Seattle (Wash.) Electric Co., March 1, 1906, to Feb. 28, 1907..	3,345,275.30	1,995,104.83	1,350,170.47	495,363.14	854,807.33
Savannah (Ga.) Electric Company, February, 1908.....	47,318.44	39,388.29	4,300.15	12,514.64	*8,184.49
Savannah (Ga.) Electric Company, February, 1907.....	43,947.29	38,223.21	15,724.08	11,334.82	4,389.26
Savannah (Ga.) Electric Co., March 1, 1907, to Feb. 29, 1908..	603,049.87	435,427.87	167,622.00	146,094.96	21,527.04
Savannah (Ga.) Electric Co., March 1, 1906, to Feb. 28, 1907..	605,165.21	376,771.87	228,393.34	135,674.66	82,718.68
Galveston-Houston (Tex.) Electric Company, February, 1908..	74,714.83	52,252.67	22,462.16	13,804.88	8,657.28
Galveston-Houston (Tex.) Electric Company, February, 1907..	68,715.48	46,448.99	22,266.49	12,187.50	10,078.99
Galveston-Houston (Tex.) Electric Company, March 1, 1907, to February 29, 1908.....	1,061,866.27	667,315.37	394,550.90	157,569.53	236,981.37
Galveston-Houston (Tex.) Electric Company, March 1, 1906, to February 28, 1907.....	930,847.75	581,821.60	349,026.15	143,232.63	205,793.52
Puget Sound Elec. Railway, Tacoma, Wash., February, 1908..	117,501.64	86,001.45	31,500.19	31,042.83	457.36
Puget Sound Elec. Railway, Tacoma, Wash., February, 1907..	105,775.37	75,122.79	30,652.58	26,361.77	4,290.81
Puget Sound Electric Railway, Tacoma, Wash., March 1, 1907, to February 29, 1908.....	1,691,470.26	1,109,828.14	581,642.12	357,929.83	223,712.29
Puget Sound Electric Railway, Tacoma, Wash., March 1, 1906, to February 28, 1907.....	1,396,837.56	935,981.76	460,855.80	282,288.68	178,567.12
Birmingham (Ala.) Railway Light & Power Co., March, 1908..	177,003.00	112,686.00	64,317.00	41,822.00	22,495.00
Birmingham (Ala.) Railway Light & Power Company, January 1, 1908, to March 31, 1908.....	522,090.00	348,337.00	173,753.00	127,043.00	46,710.00
Detroit (Mich.) United Railways, March, 1908.....	*533,788.00	338,294.00	195,494.00	134,714.00	60,780.00
Detroit (Mich.) United Railways, March, 1907.....	*553,680.00	347,973.00	205,707.00	131,251.00	74,456.00
Detroit (Mich.) United Railways, January 1, 1908, to March 31, 1908.....	*1,518,308.00	1,009,813.00	508,495.00	405,883.00	102,612.00
Detroit (Mich.) United Railways, January 1, 1907, to March 31, 1907.....	*1,539,605.00	1,017,008.00	522,597.00	377,715.00	144,882.00
Knoxville Railroad & Light Company, March, 1908.....	46,521.00	23,251.00	22,270.00	11,623.00	11,647.00
Knoxville Railroad & Light Company, March, 1907.....	48,669.00	26,652.00	22,017.00	10,269.00	11,748.00
Knoxville Railroad & Light Company, January 1, 1908, to March 31, 1908.....	128,017.00	73,346.00	54,671.00	34,468.00	20,203.00
Knoxville Railroad & Light Company, January 1, 1907, to March 31, 1907.....	133,862.00	77,604.00	56,258.00	30,421.00	25,837.00
Utica & Mohawk Valley Railway, January 1, 1908, to March 31, 1908.....	236,056.00	153,861.00	86,519.00	81,613.00	4,906.00
Utica & Mohawk Valley Railway, January 1, 1907, to March 31, 1907.....	239,294.00	150,959.00	85,754.00	79,870.00	5,884.00

\*Including other income.



# Manufactures and Supplies

## ROLLING STOCK.

New York City Railway has ordered one special construction car from Smith & Wallace, Woburn, Mass.

Third Avenue Railroad, New York City, has contracted with The J. G. Brill Company for 50 double-truck cars.

Chambersburg, Greencastle & Waynesboro Street Railway, Waynesboro, Pa., has ordered two double-truck suburban cars from The J. G. Brill Company.

Municipal Traction Company, Cleveland, O., advises us that specifications have not yet been completed for the 100 pay-as-you-enter cars which it has been authorized to purchase.

Lehigh Valley Transit Company, Allentown, Pa., as reported in our issue of April 18, placed an order during the latter part of March with The J. G. Brill Company for four 14-bench open cars for delivery in May. The dimensions of these cars are as follows:

Seating capacity.....56	Height over roof boards.....
Weight.....27,000 lb.	.....8 ft. 4 1/2 in.
Wheel base.....6 ft.	Bottom of sill to trolley
Length of body.....34 ft.	base.....9 ft. 2 1/2 in.
Over dashers.....43 ft.	Track to trolley base.....
Over all.....44 ft. 8 in.	.....12 ft. 1/2 in.
Width over posts.....8 ft. 8 in.	Body.....Wood
Over all.....9 ft.	Underframe.....
	.....Wood, steel plated

## Special Equipment.

Brakes.....Peacock	Motors.....Westinghouse
Curtain fixtures.....Acme	Seats.....Walkover
Destination signs.....Hunter	Trucks.....St. Louis
Gongs.....Dedenda	Hangers.....Noiseless (Brill).
Interior finish.....Ash	

## SHOPS AND BUILDINGS.

New York City Railway.—The receivers for the New York City Railway have obtained a permit from the building department of New York City to remove their steel and corrugated iron car barn at One Hundred and Forty-sixth street and Lenox avenue to the site of the old car barn at Fourth avenue and Thirty-third street. The Lenox avenue barn is 145 feet wide and 280 feet long and it is estimated it will cost \$10,000 to rebuild the barn on the new site.

## POWER HOUSES AND SUBSTATIONS.

Aurora Elgin & Chicago Railroad, Chicago, Ill.—We are advised that E. F. Gould, electrical engineer, Wheaton, is preparing specifications for a rotary converter and battery substation to be erected at Elgin. The electrical apparatus has been purchased. The new installation will take the place of a power station which originally furnished current for the Elgin city lines.

Vera Cruz Electric Light Power & Traction Company, Vera Cruz, Mexico.—Arrangements to provide current for electric traction, in addition to the power and lighting service now furnished the city of Vera Cruz, have been completed by this company. A large extension to the present power plant at Vera Cruz to care for the additional load is about completed and there are being installed six 470-kilowatt alternating-current generators to be operated by Diesel oil engines. Current for lighting and railway service will be distributed throughout the city by the underground system. Two Westinghouse 120-kilowatt motor generator sets will transform a part of the alternating current to direct current for use in connection with the railway service. Storage batteries will be used and a 30-panel switchboard complete with all instruments, battery regulators, switches, etc., for the control of the generators, power and lighting feeders, motor generator sets, battery, railway feeders, etc., has been ordered. Eleven Westinghouse double motor equipments, including motors, controllers and auxiliary apparatus, will comprise the electrical equipment of the cars. It is stated that this will be the first installation of the size in Mexico employing oil engines for operating the generating equipment. The electrical apparatus for the railway service was supplied through G. & O. Braniff & Co., Mexico City. The road heretofore has been operated by horsepower.

## TRADE NOTES.

Herbert C. Petty was elected on May 13 a director of the Crocker-Wheeler Company, Ampere, N. J., manufacturer of electric dynamos and motors. Mr. Petty accepted a position in the sales division of the company in January, 1903, and has

advanced rapidly to the position of contract manager. The present honor conferred upon him is a recognition of the esteem and confidence which he commands among the stockholders of the company.

Twedy, Hood & Finley, Incorporated, Fisher building, Chicago, has recently been appointed sales agent for the Roofbestos Manufacturing Company of St. Louis, Mo., manufacturers of prepared roofing for train sheds, freight houses, depots, etc.

William A. Pitcher, for the past two years eastern railroad representative of S. F. Bowser & Co., Ft. Wayne, Ind., was one of the number who lost their lives in the burning of the Aveline hotel at Ft. Wayne on Sunday morning, May 3. The company feels keenly the loss of Mr. Pitcher and his many friends among the railroad fraternity will regret to hear of his sudden death. He was 48 years of age. His successor has not yet been appointed.

Vacuum Impregnating Manufacturing Company, 50 Church street, New York, has installed at 146 Throop street, Chicago, an up-to-date vacuum drying and impregnating plant and is now prepared to treat all types of field and magnet coils by this system. An interesting feature to electric railways of this system is the rejuvenation of old coils. The company states that old coils, unless dead short circuited, can be successfully reinsulated at a comparatively slight expense and replaced in service.

Allis-Chalmers Company, Milwaukee, Wis., has made shipments during the past week of a number of turbo-generator units aggregating 9,500 kilowatts in capacity, normal rating. These include one 1,000-kilowatt units for the Athens Electric Railways, Athens, Ga.; two 1,500-kilowatt units for the Youngstown (O.) Sheet & Tube Company; one 1,500-kilowatt units for the city of Jacksonville, Fla.; two units, a 500 and a 1,000 kilowatt, for the Celluloid Company, Newark, N. J.; one 1,500 kilowatt machine for the Tremont & Suffolk Mills, at Lowell, Mass., and a 1,000-kilowatt machine for the Nairn Linoleum Company, Kearney, N. J.

## ADVERTISING LITERATURE.

(Mention of the Electric Railway Review will assure prompt attention to requests for publications listed here.)

H. W. Johns-Manville Company, 100 William Street, New York.—A neat folder calling attention to the advantages of Keystone hair insulator for sound deadening and weather-proofing purposes; also a small folder describing the fire extinguisher sold by this company.

Twedy, Hood & Finley, Incorporated, Fisher Building, Chicago.—An attractive folder calling attention to the railway supplies handled by this company. Also a folder describing "Roofbestos," a composition suitable for factories, railway depots and sheds, engine and boiler houses, buildings, etc.

Topping Brothers, 122 Chambers Street, New York City.—Burrows ball bearing jacks are the subject of a pamphlet. These jacks are specially designed for railway use and are made in 25 styles. The railroad tools made by the company also include a car inspector's cone bearing jack, portable tool grinder, a track drill and a brake beam clamp.

Expanded Metal & Corrugated Bar Company, St. Louis, Mo.—The first volume of a series of bulletins on designing methods for reinforced concrete construction has been issued, including general principles of design for buildings. It is intended that each issue will be devoted to a particular type of structure and the problems relating thereto will be discussed, methods of analysis given and illustrations showing detailed designs. These pamphlets have perforated backs for convenience in filing. A pamphlet descriptive of an economy unit frame for accurately locating and holding the main reinforcing bars in position has also been issued.

General Electric Company, Schenectady, N. Y.—Bulletin No. 4582 describes the GE-205 commutating pole railway motor. This motor is especially adapted for operation on heavy grades or with equipments geared for high-speed work which have also to start and stop frequently as in city services. An extensive description of the mechanical and electrical details of the apparatus is given in the bulletin. Under the heading of "rating" several pages are devoted to the proper selection of railway motors for various services, and a table is given showing schedule speeds under different conditions. Characteristic curves of different motors and dimension diagrams are included. Bulletin No. 4587 describes a new type of resistance unit for rheostats, fixed resistances, laboratory use, etc., which has recently been put on the market. Under the title, "Two Aids to Better Service," a neat folder, No. 3654, has been issued calling attention to some of the reasons why the GE luminous arc headlight has been adopted.

## COMBINATION PLATFORM GATE AND TRAP.

The accompanying illustration exhibits the detail dimensions of a combination platform gate and trap door, used on the city cars at Oakland, Cal.

The various parts are so connected that when the trap is

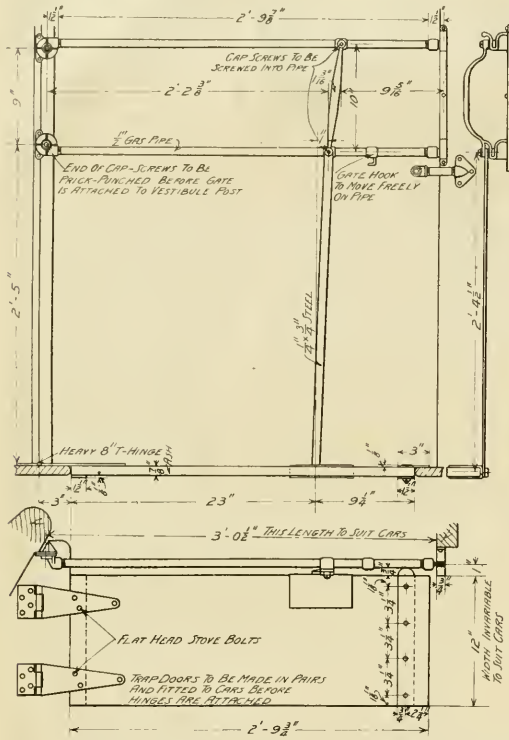

Platform Trap and Gate Used at Oakland, Cal.

raised the gate folds with it closely against the end bulkhead. With the trap closed the gate is fastened securely in place so that it forms a substantial barrier which will prevent anyone being crowded off the blind side of the platform.

## NEW CRANE PIPE MACHINE.

The Crane Company, Chicago, recently has placed on the market a new pipe cutting and threading tool designed to meet the demand for a low-priced machine, operated by hand or power, for high-class service. All parts have been designed to withstand any strains that such a pipe cutting and threading machine may be subjected to, and simplicity of operation, adjustment and arrangement has been carried out to the minutest detail. The capacity is for pipes from  $\frac{1}{8}$  to 2 inches in diameter.

This tool possesses many features which increase output and facilitate ease of operation, the gripping, threading, cutting off and adjustment having been so arranged that no unnecessary operations are required.

The frame is one casting, having bed and stand in one piece, eliminating the use of light legs and giving greatest rigidity with minimum weight and floor space.

The die head is bolted to a movable carriage, with ample travel. Upon the die head are the dies, pipe guides and cutting-off tool. The dies are of the improved adjustable type, made collapsible, and are similar to those supplied in Crane hand die stocks. The dies are carried in suitable frames, sliding in guides, the frames being moved by a screw operated by a hand wheel. The dies are set to gauge by a simple locking device, which allows any number of pieces of pipe of the same size to be threaded without any further adjustment. These dies have four cutting edges and will give good service on either steel or wrought-iron pipe. Dies are made inter-

changeable and the one die of a set may be replaced if broken, thus reducing the repair bill to the minimum. Dies, when not in use on machine, may be used in a hand stock. Change in size of dies may be made very quickly.

The gripping chuck is of the quick gripping type, rapid in action and powerful. The pipe may be released or gripped by the throwing of a lever without stopping the machine. The chuck is adjustable to the different sizes of pipe within range of the machine without moving or altering the jaws, which are of tool steel carried in steel holders and are removable for grinding or replacing.

The rear end of the spindle contains a universal centering chuck, compact in design and readily adjusted to the various sizes of pipe.

Oil is supplied by a small tank supported on a swivel joint above the die head. A second small tank is placed in the

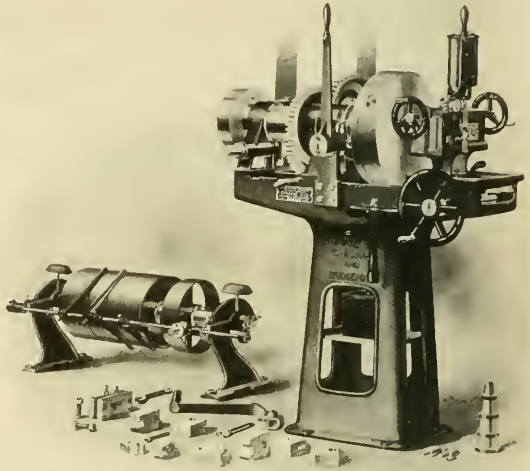

New Crane Pipe Machine.

frame, and to this the oil from the dies returns, the supply being controlled by a pet cock.

One pulley is necessary to drive. Three changes of speed are obtained by gears which are shifted by a lever placed on the frame. All machines are supplied with necessary crank for hand operation.

Bolt dies  $\frac{1}{4}$  to  $1\frac{1}{2}$  inches can be furnished if desired. All necessary pipe gauge blanks, wrenches, etc., are supplied with the machine. The principal dimensions are: Countershaft pulley, 9 $\frac{3}{4}$  inches in diameter by  $3\frac{1}{2}$  inches face; countershaft speed, 200 revolutions per minute; floor space, 14 by 23 inches. The weight is 700 pounds.

## LAST YEAR'S TURBINE BUSINESS.

Retrospective of the development during the past year of the steam turbine, the accompanying figures, reported by the Westinghouse Machine Company, are interesting as tending to controvert the general impression that the turbine business suffered heavily during the year. Although one month's business in 1906 still holds the record at 62,100 kilowatts, the year 1907 was marked by an average demand quite as large. As late as July orders for 34,750 kilowatts were taken during that month as compared with 25,750 for July, 1906, which is a particularly gratifying showing. For the first nine months of each year the demand for turbines was as follows: 1907, 158,550 kilowatts, and for 1906, 152,400 kilowatts, or, taking the middle six months of the year, from April to September inclusive, thus excluding the usual midwinter activity, as well as the late depression, the average per month is as follows: 1907, 15,833 kilowatts; 1906, 14,365 kilowatts. Thus it is apparent that up to the period immediately preceding the depression of October the demand for turbine equipment shows a steady increase. It is interesting to note in this connection the ultimate results of commercial activity of the past few years. Had the business of the company kept on increasing at the same rate as prevailed during 1904 and 1906, the year 1910 would have been marked by an annual output of 1,912,000 kilowatts, or the rate of 160,000 kilowatts per month.

# Dearborn Water Purifying Reagents

Increase the efficiency and the years of service of steam boilers by keeping them in good condition internally. Gallon sample of the water required for analysis before preparing treatment.

## Dearborn Drug & Chemical Works

ROBT. F. CARR, PRESIDENT

299 BROADWAY, NEW YORK POSTAL TELEGRAPH BLDG., CHICAGO

YOU CAN SAVE REPAIR BILLS BY USE OF

# MANGANESE STEEL GEARS and PINIONS

MADE ONLY BY ATHA STEEL CASTING CO., NEWARK, N. J.

# ASK THE PRACTICAL MAN

He'll tell you about

## *"Kewanee" Unions Octagon Pattern*



"Satisfactory?"—"Of course! They NEVER leak."  
 "Satisfactory?"—"Of course! They require no gasket."  
 "Satisfactory?"—"Of course! They have brass to iron thread connection and NEVER corrode."  
 "Satisfactory?"—"Of course! They can be disconnected and reconnected indefinitely without injury."  
 "Satisfactory?"—"Of course! They outlast several ordinary unions."  
 "Satisfactory?"—"Of course! They are economical for the consumer."  
 "Satisfactory?"—"Of course! They are absolutely guaranteed by the manufacturer."

# NATIONAL TUBE COMPANY

General Sales Offices, Frick Bldg., PITTSBURG, PA.

### DISTRICT SALES OFFICES

New York, N. Y. Hudson Terminal Bldg.  
 Chicago, Ill. Commercial Nat. Bank Bldg.  
 Pittsburg, Pa. Frick Bldg.  
 Philadelphia, Pa. Pennsylvania Bldg.

St. Louis, Mo. Third Nat. Bank Bldg.  
 San Francisco, Cal. Crocker Bldg.  
 Portland, Ore. Wells Fargo Bldg.  
 Salt Lake City, Utah. Dooly Bldg.

Denver, Colo. Majestic Bldg.  
 New Orleans, La. Maison Blanche.  
 Atlanta, Ga. Candler Bldg.  
 Seattle, Wash. Alaska Bldg.

# THE J. G. BRILL COMPANY, PHILADELPHIA, PA.

AMERICAN CAR COMPANY, ST. LOUIS, MO.  
 G. C. KUHLMAN CAR COMPANY, CLEVELAND, OHIO  
 JOHN STEPHENSON COMPANY, ELIZABETH, N. J.  
 WASON MANUFACTURING CO. SPRINGFIELD, MASS.

MAIN OFFICE: PHILADELPHIA, PA.  
 LONDON OFFICE: 110 CANNON ST. E. C.  
 PACIFIC COAST AGENTS: PIERSON  
 ROEDING & CO., SAN FRANCISCO.  
 AUSTRALIAN AGENTS: NOYES  
 BROTHERS, SYDNEY. CABLES:  
 "BRILL," PHILA., "AXLES" LONDON.

*CARS TRUCKS SEATS RATTAN SPRINGS SPECIALTIES SUPPLIES*

## LARGEST EARNING CAPACITY

For service in cities and towns, where an entirely open car with side entrances is desirable during warm weather, no better car can be found than the Brill Convertible. Unquestionably the entirely open car is the most popular summer type and the Brill Convertible overcomes the two drawbacks of the ordinary car--no protection in bad weather and the necessity for a double equipment of cars--and provides exactly what is wanted for every day in the year. Climatic conditions, of whatever kind, are no bar to the use of the Brill Convertible Car; it is equally successful in the Northern States with their arctic winters as in the Gulf States with their tropical summers. The flexible metal panels slide into the roof pockets just as easily as the sashes, therefore any one can operate them. The Brill Convertible Car is the most practical solution of the question of how to always secure the largest amount of traffic.

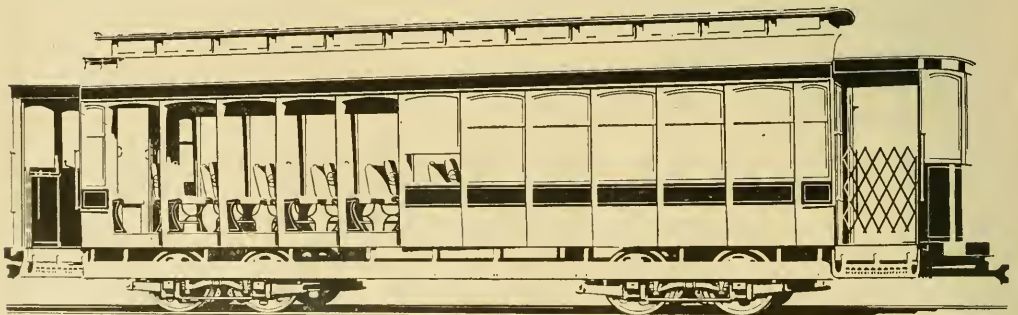

*THE BRILL CONVERTIBLE CAR (PATENTED)*

# General Electric Company

## Auxiliary Contactor Equipments for Cylinder Controllers

increase economy of operation and decrease maintenance cost

Prevent controller blow-ups with attendant accidents; eliminate all serious arcing from car platform both in controller and circuit breakers.

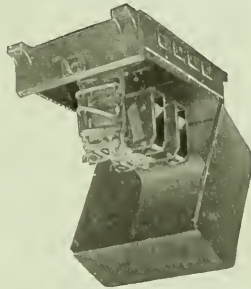

Contactors Assembled in Iron Box.

The contactors are normally operated by attachments in the controllers and are also automatically opened on overload.

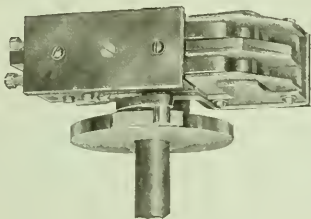

Auxiliary Attachment for K-28 Controller.

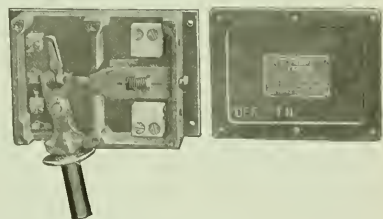

MU-3-A Tripping Switch

The engineer of a large traction company writes:

"Last year we installed contactors on all of our two-motor cars. This was done to avoid flashing of controllers, which caused us many accidents upon this class of car. Since the installation of these controllers we have had no controller flashing."

These auxiliary contactor equipments are built in suitable sizes for all cylinder type railway controllers

Chicago Office:  
Monadnock Bldg.

Principal Office:  
Schenectady, N. Y.

Sales Offices in  
All Large Cities

# AMERICAN ELECTRICAL WORKS

PROVIDENCE, R. I.

## BARE AND INSULATED ELECTRIC WIRE

New York Office, 26 Cortlandt St. Chicago Office, 135 Adams St.  
MONTREAL BRANCH: Eugene F. Phillips Electrical Works, Limited.



Wherever absolute accuracy is demanded  
the best steel measuring tapes  
to use are those made by

**THE LUFKIN RULE CO.**  
SAGINAW, MICH., U. S. A.

New York  
London, England  
Windsor, Canada

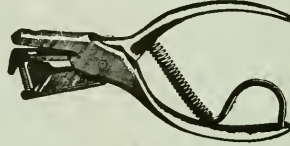

The Fred. J. Meyers  
Mfg. Co. Hamilton, O.

Largest Manufacturer in the World of  
TICKET and CONDUCTORS'  
**PUNCHES**

Send for catalog of 75 different  
styles of punches  
with 1000 different dies.  
Write for special prices.



## Black Baking Varnish

—especially adapted for insulating street railway motors. Possesses the same high insulative efficiency as P. & B. Clear Baking Varnish. Repels water, oil and dirt, and is non-corrosive. Bakes to a smooth, tough, lustrous, flexible coat, possessing great strength.

Write for interesting booklet.

**The Standard Paint Co.** 100 William Street  
NEW YORK, N. Y. 2  
Chicago St. Louis Kansas City Boston Philadelphia New Orleans

## "Not an Experiment"

The **Providence Fender**  
is the **Children's Fender**.  
It is equally as effective in  
saving a child, and the  
person who has stumbled,  
as it is in saving those  
who are on their feet.

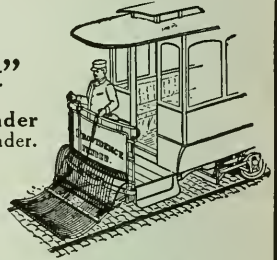

**CONSOLIDATED CAR FENDER COMPANY**

Office and Factory: PROVIDENCE, R. I.  
Branch Office: 110 E. Twenty-third St., New York  
European Agents: Comptoire d'Electricite, 6, Rue Boudreau, Paris, France

# You can lease a Portable Bonding Car

and do bonding and rebonding by the modern methods of

## Electric Brazing and Copper Welding

at an approximate labor cost of installation of *12 cents per bond.*

No other method within reaching distance of this cost can produce results equal to or even approaching ours for perfect conductivity and long life.

*Proof is yours for the asking.*

**THE ELECTRIC RAILWAY  
IMPROVEMENT COMPANY**  
6005 Carnegie Avenue CLEVELAND, OHIO



# Electric Railway Review

PUBLISHED EVERY SATURDAY.

FORMERLY THE STREET RAILWAY REVIEW.

THE WILSON COMPANY, CHICAGO.

CHICAGO: 160 Harrison Street  
NEW YORK: 50 Church Street  
CLEVELAND: 1529 Williamson Bldg.

Vol. XIX  
No. 22

CHICAGO, MAY 30, 1908

Whole No.  
295

Subscription: Domestic, \$2.00  
Foreign, 5.00  
Canada, 3.50

## Electric Railway Journal

first appears June 6—a consolidation of  
**ELECTRIC RAILWAY REVIEW**  
and **STREET RAILWAY JOURNAL**

**T**HIS union of the two big, strong papers of the electric railway industry into one journal having the combined strength, prestige, influence and circulation of the two produces a paper which, with respect to the field it covers, will be beyond question the strongest in the world.

To the advertiser the consolidation means that he can now use one paper having the combined circulation of the two with the absolute assurance that he will thereby reach every buyer and everyone who influences the purchase of supplies and equipment for street and interurban railways. He can use a space big enough in the **ELECTRIC RAILWAY JOURNAL** to insure profitable results, and do this without increasing the amount he would have had to pay for small space in the two constituent papers, because the present **STREET RAILWAY JOURNAL** rates will obtain in the **ELECTRIC RAILWAY JOURNAL**.

No matter what you have that electric railways need, it will pay you to advertise in the

## ELECTRIC RAILWAY JOURNAL

239 WEST 39TH STREET, NEW YORK

# A Big Reduction in Cost of Repairs

**Repairs Less Frequent    Repairs Made Quicker    Repairs at Less Expense**

Lyon Sheet Steel Gear Cases have been proven to be less expensive to maintain than malleable cases.

Repairs are less frequent, due to the fact that sheet steel will not break or crack as will malleable iron.

When repairs are necessary, Sheet Steel Gear Cases can be more quickly repaired, as they can be handled in pits or repair shops by one man, since they weigh from 50 to 75 pounds less than malleable cases.

If a Lyon Case is struck by a cobble stone or other object, it does not break, but simply bends and can be easily reformed with a hammer, at practically no expense. We are glad to send sample gear cases on trial. Give us the motor ratio and the size of motor and allow us to send samples on trial.

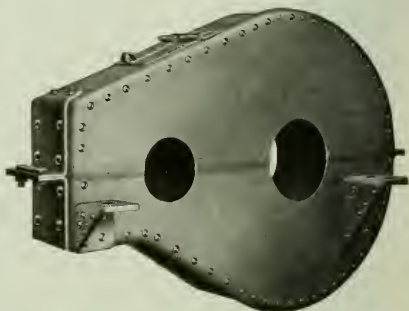

Patented May, 1905, and December, 1906

## ELECTRIC SERVICE SUPPLIES Co.

Railway Material & Electrical Supplies

MAYER & ENGLUND DEPT.  
PHILADELPHIA

NEW YORK

GARTON-DANIELS DEPT.  
KEOKUK

PITTSBURG

PORTER & BERG DEPT.  
CHICAGO

SAINT LOUIS

ATLANTA

# National Air Compressors

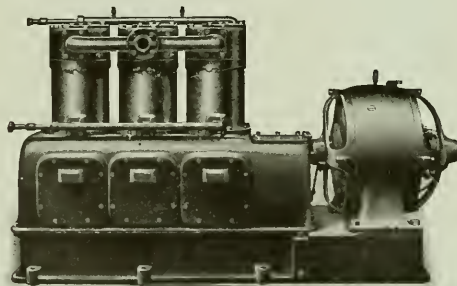

33C

100 cu. ft. Type "3VS" Air Compressor.

These Compressors are especially adapted for service in car shops and barns, where compressed air is used, for various industrial operations, as well as for blowing dust and other accumulations out of car motors, controllers and seats.

Either direct or alternating current motors can be furnished for operating same.

Automatic starters which start and stop the Compressors and keep the air supply within the desired range of pressures are furnished with each Compressor.

Type "3VS" Compressors are built in capacities of 50, 100, 150 and 225 cu. ft. of free air per minute.

Write for Bulletin 84-F

## National Brake & Electric Company

MILWAUKEE, WIS., U. S. A.

NEW YORK: 111 Broadway

SAN FRANCISCO, CAL.: W. F. McKenny, 69-71 First St.

PHILADELPHIA: W. H. Goble, 1722 Westmoreland St.

BOSTON: F. E. Huntress, 131 State St.

LONDON: 14 Great Smith St., Westminster

General Sales Office: 519 First National Bank Building, Chicago



# Westinghouse

## Suction Gas Producers

are approved by  
The National Board of  
Fire Underwriters

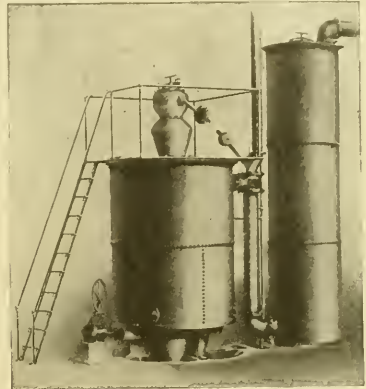

The complete equipment is shown in the illustration. These producers can be operated continuously, ashes being removed whenever convenient without interfering with the gas output or disturbing the fuel bed. A marked characteristic of these equipments is their simplicity.

Our nearest office will give full particulars.

## The Westinghouse Machine Co.

Steam Turbines, Steam Engines, Gas Engines, Gas Producers, Storage Batteries and The Roney Stoker

New York, 165 Broadway  
Boston, 131 State Street  
Atlanta, Candler Building  
St. Louis, Chemical Building

Pittsburg, Westinghouse Building  
Cleveland, New England Building  
Chicago, 171 La Salle Street  
Cincinnati, Traction Building

Philadelphia, North American Building  
Denver, McPhee Building  
San Francisco, Hunt, Mirk & Co.

## The Electrolytic Lightning Arrester

as developed by this company is now recognized as the coming type of arrester for most applications. Watch competitors follow our lead.

Circular No. 1146 contains a fully illustrated description of Electrolytic Lightning Arresters.

Ask our nearest office for a copy.

### Westinghouse Electric & Mfg. Co.

Atlanta	Cincinnati	Kansas City	New York	Salt Lake City
Baltimore	Cleveland	Los Angeles	Philadelphia	San Francisco
Boston	Dallas	Minneapolis	Pittsburg	Seattle
Buffalo	Denver	New Orleans	St. Louis	Syracuse
Chicago	Detroit	Mexico: G. & O. Braniff & Co.,	City of Mexico	

Canada: Canadian Westinghouse Co., Ltd., Hamilton, Ont.

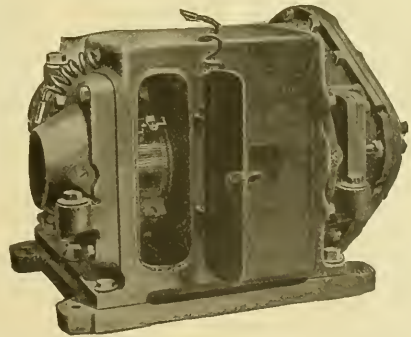

The liberally proportioned crankshaft of Westinghouse Motor-Driven Air Compressors for Air Brake Equipments is not only supported at its ends by the crank-case heads, but is also provided with a support at its center. This center bearing adds 50% to the wearing surfaces, and greatly increases the strength of the shaft.

Full particulars in Catalogue T-2002.

### Westinghouse Traction Brake Co.

Pittsburg, Pa.

## ALPHABETICAL INDEX TO ADVERTISEMENTS.

Advance Lumber Co. ....15	Dearborn Drug & Chemical Works .....23	Meyers, Fred J., Mfg. Co. ....	Sheibly Electric Co. ....22
Allis-Chalmers Co. ....11	Dossert & Co. ....23	Michigan Steel Boat Co. ....	Simmons, John, Co. ....21
American Brake Shoe & Fdry. Co. ....13	Drouvé, G., Co. ....13	Miller Anchor Co. ....	Smith, Peter, Heater Co. ....14
American Electrical Works. ....	Eclipse Railway Supply Co. ....10	Model Stoker Co. ....14	Speer Carbon Co. ....14
Anderson, Albert & J. M., Mfg. Co. ....19	Electric Railway Equipment Co. ....15	Morden Frog & Crossing Wks. ....	Standard Brake Shoe Co. ....14
Armstrong Oiler Co. ....	Electric Ry. Improvement Co.26	National Brake & Electric Co.2	Standard Motor Truck Co. ....11
Arnold Company ....13	Electric Service Supplies Co.2	National Brake Co. ....22	Standard Paint Co. ....14
Atha Steel Casting Co. ....24	Engineers and Contractors.16	National Lock Washer Co.26	Standard Steel Works Co. ....16
Automatic Trolley Guard Co.11	Fairbanks, Morse & Co. ....	National Pole Co. ....18	Standard Underground Cable Co. ....10
Babcock & Wilcox Co. ....11	Ford, Bacon & Davis. ....	National Tube Co. ....23	Star Brass Works. ....21
Baker, Wm. C., Heating & Supply Co. ....17	Galena-Signal Oil Co. ....13	Naugle Pole & Tie Co. ....18	Stone & Webster Engineering Corporation ....
Baldwin Locomotive Works.16	Garford Co. ....18	New York Switch & Crossing Co. ....16	Stuart-Howland Co. ....
Barbour-Stockwell Co. ....	General Electric Co. ....25	Niles Car & Mfg. Co. ....17	Synnington, T. H., Co. ....15
Barnes, G. H., Hardwood Lumber Co. ....18	Green Engineering Co. ....	Northern Engineering Works. ....	Telegraph Signal Co. ....21
Beidler, Francis, & Co. ....18	Griffin Wheel Co. ....14	Nuttall, R. D., Co. ....	Trolley Supply Co. ....21
Bellamy Vestlette Mfg. Co. ....	Hagy, J. Milton, Waste Wks.11	Ohio Brass Co. ....5	U. S. Metal & Mfg. Co. ....
Berthold & Jennings. ....18	Hale & Kilburn Mfg. Co. ....	Okonite Co., Ltd. ....	Van Dorn & Dutton Co. ....14
Bridgeport Brass Co. ....	Hartshorn Co., Stewart. ....	Pacific Coast Pole Co. ....18	Van Dorn, W. T., Co. ....16
Brill, J. G., Co. ....24	Heine Safety Boiler Co. ....18	Patten, Paul B. ....	Van Valkenburgh, E. C. ....26
Brown, Harold P. ....	Heywood Bros. & Wakefield Co. ....	Pay-As-You-Enter Car Co. ....9	Wanted and For Sale Cards. ....20
Brown Hoisting Machy. Co. ....14	Holman, D. F., Ry. Tracklayer Co. ....	Power Specialty Co. ....	Washington Steel Castings & Copper Co. ....19
Buckeye Engine Co. ....	Humbird Lumber Co., Ltd. ....	Pressed Steel Car Co. ....	Watson-Stillman Co. ....21
Burnham, Williams & Co. ....16	Jewett Car Co. ....17	Queen & Co. ....19	Western Electric Co. ....5
Bylesby, H. M., & Co. ....14	Johns-Manville, H. W., Co. ....5	Rail Joint Co. ....16	Westinghouse Electric & Mfg. Co. ....3
Central Inspection Bureau. ....14	Kalamazoo Ry. Supply Co. ....26	Railway Specialty & Supply Co. ....	Westinghouse Machine Co. ....3
Chase-Shawmut Co. ....15	Lindsay Bros. Co. ....18	Railway Steel-Spring Co. ....14	Westinghouse Traction Brake Co. ....3
Chicago Mica Co. ....19	Lord & Burnham Co. ....20	Register, A. J., & Co. ....14	Western Electrical Instrument Co. ....19
Churchill Cedar Co. ....18	Lufkin Rule Co. ....26	Robertson, Wm., & Co. ....19	Wharton, Wm., Jr., & Co. ....16
Cincinnati Car Co. ....	Lumen Bearing Co. ....20	Roger Ballast Car Co. ....14	White, J. G., & Co. ....14
Cleveland Frog & Cross. Co. ....	Macallen Co. ....	Rooke Automatic Register Co.22	Whitmore Mfg. Co. ....19
Collier, Barron G. ....	McGuire-Cummings Mfg. Co.17	Russell Car & Snow-Plow Co.20	Woodbury Carlton Co. ....
Consolidated Car Fender Co.14	Marshall, R. W., & Co. ....20	S-E. Missouri Cypress Co. ....18	Woodman, R., Mfg. & Supply Co. ....
Consolidated Car-Heating Co.26	McGuire-Cummings Mfg. Co.17	St. Louis Car Wheel Co. ....14	Worcester, C. H., Co. ....18
Contractors' Supply & Equipment Co. ....14	Marshall, R. W., & Co. ....20	Saxon, E. ....	
Crane Co. ....		Sheaff & Jastad. ....	
Creagehead Engineering Co.14			
Curtain Supply Co. ....14			
Davis, John, Co. ....			

## CLASSIFIED LIST OF ADVERTISERS.

Advertising Designs and Plates. Woodbury-Carlton Co., Worcester, Mass.	Badges and Buttons. Electric Service Supplies Co., 200 Plymouth Bldg., Chicago.	Boilers—Continued. Heine Safety Boiler Co., 421 Olive St., St. Louis. Lord & Burnham, Irvington-on-Hudson, N. Y.	Brakes and Brake Parts—Continued. Stephenson, John, Co., Elizabeth, N. J. Wason Mfg. Co., Springfield, Mass. Westinghouse Traction Brake Co., Pittsburg, Pa.
Advertising Service. Van Valkenburgh, E. C., 2117 West One Hundred and Second St., Chicago.	Ballast Cars—(See Cars, Ballast).	Boiler Cleaning Compounds. Dearborn Drug & Chemical Works, Chicago. Johns-Manville, H. W., Co., New York.	Brakeshoes. American Brake Shoe & Fdry. Co., Mahwah, N. J. American Car Co., St. Louis. Barbour-Stockwell Co., Cambridgeport, Mass. Brill, J. G., Co., Philadelphia. Kuhlman, G. C., Car Co., Cleveland. McGuire-Cummings Mfg. Co., Chicago. Marshall, R. W., & Co., 95 Liberty St., New York. St. Louis Car Co., St. Louis. Standard Brake Shoe Co., Aurora, Ill. Stephenson, John, Co., Elizabeth, N. J. Wason Mfg. Co., Springfield, Mass. Wharton, Wm., Jr., & Co., Philadelphia.
Advertising, Street Car. Collier, Barron G., Flat Iron Bldg., New York.	Ball Bearings. Symington, T. H., Co., Baltimore, Md.	Bonds, Rail. Brown, H. P., 120 Liberty St., New York. Chase-Shawmut Co., Newburyport, Mass. Electric Railway Improvement Co., Cleveland, O. Electric Service Supplies Co., 200 Plymouth Bldg., Chicago. General Electric Co., Schenectady, N. Y. Johns-Manville, H. W., Co., New York. Ohio Brass Co., Mansfield, O.	Brake Timbers. Beidler, Francis, & Co., Chicago.
Air Brakes—(See Brakes and Brake Parts).	Bases—(See Trolley Poles and Fittings).	Belts and Cross Arms. Anderson, Albert & J. M., Mfg. Co., Boston. Creagehead Engineering Co., Cincinnati, O. Electric Railway Equipment Co., Cincinnati, O. Electric Service Supplies Co., 200 Plymouth Bldg., Chicago. Johns-Manville, H. W., Co., New York. Lindsay Bros. Co., Spokane, Wash. Ohio Brass Co., Mansfield, O. Stuart-Howland Co., Boston. Western Electric Co., Chicago.	Brushes, Motor and Dynamo. Electric Service Supplies Co., 200 Plymouth Bldg., Chicago. General Electric Co., Schenectady, N. Y. Speer Carbon Co., St. Marys, Pa.
Air Compressors—(See Compressors, Air).	Bearings. Electric Service Supplies Co., 200 Plymouth Bldg., Chicago. General Electric Co., Schenectady, N. Y. Lumen Bearing Co., Buffalo, N. Y. McGuire-Cummings Mfg. Co., Chicago. Marshall, R. W., & Co., 95 Liberty St., New York. Nuttall, R. D., Co., Pittsburg, Ohio Brass Co., Mansfield, O. Symington, T. H., Co., Baltimore, Md. Van Dorn & Dutton Co., Cleveland, O.	Block System—(See Signals).	Bumpers, Car. American Car Co., St. Louis. Brill, J. G., Co., Philadelphia. Kuhlman, G. C., Car Co., Cleveland. St. Louis Car Co., St. Louis. Stephenson, John, Co., Elizabeth, N. J. Wason Mfg. Co., Springfield, Mass.
Alloys and Bearing Metals. Brown, H. P., 120 Liberty St., New York. General Electric Co., Schenectady, N. Y. Lumen Bearing Co., Buffalo, N. Y. Ohio Brass Co., Mansfield, O. St. Louis Car Co., St. Louis, Mo.	Bells and Gongs. American Car Co., St. Louis. Brill, J. G., Co., Philadelphia. Electric Service Supplies Co., 1023-24 Filbert St., Phila. Kuhlman, G. C., Car Co., Cleveland. McGuire-Cummings Mfg. Co., Chicago. National Tube Co., Pittsburg, Pa. Ohio Brass Co., Mansfield, O. St. Louis Car Co., St. Louis. Stephenson, John, Co., Elizabeth, N. J. Wason Mfg. Co., Springfield, Mass. Western Electric Co., Chicago.	Blue Printing Machines. Buckeye Engine Co., Salem, O.	Car Replacers. National Brake & Electric Co., Milwaukee.
Aluminum Wire, Etc. Aluminum Co. of America, Pittsburg.	Boilers. Babcock & Wilcox Co., New York. Fairbanks, Morse & Co., Chicago.		
Anchors. Electric Service Supplies Co., 200 Plymouth Bldg., Chicago. Miller Anchor Co., Norwalk, O. Ohio Brass Co., Mansfield, O.			
Armatures and Coils, Winding and Repeating. Electric Service Supplies Co., 200 Plymouth Bldg., Chicago. General Electric Co., Schenectady, N. Y. Marshall, R. W., & Co., 95 Liberty St., New York. Stuart-Howland Co., Boston.			
Armature Lifts. Electric Service Supplies Co., 200 Plymouth Bldg., Chicago.			
Asbestos Materials. Johns-Manville, H. W., Co., New York.			
Axles—(See Wheels and Axles).			
Babbitt Metals—(See Alloys and Bearing Metals).			

# WESTERN ELECTRIC

CHICAGO DENVER COMPANY SAINT PAUL NEW YORK  
 SAINT LOUIS PITTSBURG CINCINNATI ATLANTA  
 SAN FRANCISCO SEATTLE SALT LAKE CITY LOS ANGELES KANSAS CITY PHILADELPHIA

## A. C. GENERATORS

From your standpoint as the user, the three most important features of A. C. Generators to be considered are Heating, Regulation and Efficiency. The

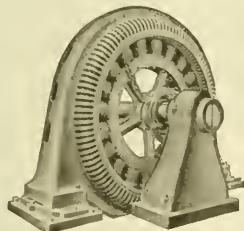

heating is kept low by a generous and especially well ventilated design of those parts in which heat is developed. Perfect regulation is obtained by so proportioning the parts as to reduce to the lowest

possible value the quantities which tend most strongly against good regulation.

### Western Electric A. C. Generators

will give you the highest average or all-day efficiency.

Send for a copy of our Catalogue  
 No. 5210-C on Alternators

## FOR FIREPROOFING ELECTRIC CARS



ASBESTOS WOOD is without an equal. It is applied as a fireproof protection under the car floor to protect the wood-work from fire caused by short circuits in the wiring of motors, controllers and rheostats.

## ASBESTOS WOOD

is an absolutely fireproof material which can be worked with ordinary woodworking tools. Is highly efficient as an electrical insulation; has approximately the same tensile strength as wood and is permanent and durable. Can be used in innumerable ways in Power Stations, Car Barns and Shops.

Write Nearest Branch for Booklet.

## H. W. JOHNS-MANVILLE CO.



NEW YORK  
 MILWAUKEE  
 CHICAGO  
 BOSTON  
 PHILADELPHIA  
 ST. LOUIS

PITTSBURG  
 CLEVELAND  
 BUFFALO  
 DETROIT  
 BALTIMORE  
 NEW ORLEANS  
 KANSAS CITY

MINNEAPOLIS  
 SAN FRANCISCO  
 LOS ANGELES  
 SEATTLE  
 OALLS  
 LONDON

819

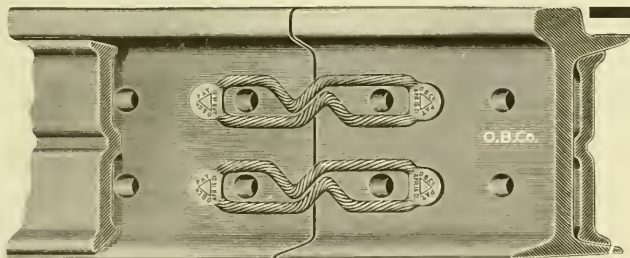

## There Are No JOINTS

—IN—

## “All Wire” Bonds

### “All Wire” Compressed Terminal Rail Bonds

☛The “ONE PIECE” construction of “All Wire” Bonds ELIMINATES the internal resistance caused by joining bond terminals to the body by welding or other processes.

☛The body and terminals of “ALL WIRE” BONDS are formed from ONE CONTINUOUS PIECE of flexible copper cable and the uniform conductivity throughout the ENTIRE bond EQUALS that of pure drawn copper.

☛The strands are not bent at acute angles; vibratory stresses are evenly distributed throughout the bond so that a maximum durability is obtained.

See Catalogue No. 7, Pages 173-222, for Bonds and Bonding Tools

# THE OHIO BRASS COMPANY

Main Office—MANSFIELD, OHIO, U. S. A.—Works

NEW YORK 32 Cortlandt Street  
 BURT GELLATLY, 223 Fourth Avenue, PITTSBURG

ST. LOUIS 10 North 4th Street

CHICAGO—277 Dearborn Street

PIERSON, ROEDING & CO., SAN FRANCISCO, LOS ANGELES, SEATTLE

## CLASSIFIED LIST OF ADVERTISERS—Continued.

- Car Replacers—Continued.**  
Kalamazoo Railway Supply Co., Kalamazoo, Mich.  
Ohio Brass Co., Mansfield, O.  
U. S. Metal & Mfg. Co., 25 Broad St., New York.
- Car Seats.**  
American Car Co., St. Louis.  
Brill, J. G., Co., Philadelphia.  
Hale & Kilburn Mfg. Co., Philadelphia.  
Heywood Bros. & Wakefield Co., Wakefield, Mass.  
Kuhlman, G. C., Car Co., Cleveland.  
St. Louis Car Co., St. Louis.  
Stephenson, John, Co., Elizabeth, N. J.  
Wason Mfg. Co., Springfield, Mass.
- Car Steps.**  
Electric Service Supplies Co., 200 Plymouth Bldg., Chicago.
- Car Trimmings—(See Trimmings, Car).**
- Cars, Ballast.**  
Rodger Ballast Car Co., Chicago.  
St. Louis Car Co., St. Louis.
- Cars, Dump.**  
Fairbanks, Morse & Co., Chicago.  
Rodger Ballast Car Co., Chicago.  
Russell Car & Snow-Plow Co., Ridgway, Pa.  
St. Louis Car Co., St. Louis.
- Cars, Passenger and Freight.**  
American Car Co., St. Louis.  
Brill, J. G., Co., Philadelphia.  
Cincinnati Car Co., Cincinnati.  
Detroit Carbuilding & Equipment Co., Detroit, Mich.  
Electric Railway Improvement Co., Cleveland, O.  
Fairbanks, Morse & Co., Chicago.  
Jewett Car Co., Newark, O.  
Kuhlman, G. C., Car Co., Cleveland.  
McGuire-Cummings Mfg. Co., Chicago.  
Niles Car & Mfg. Co., Niles, O.  
Pressed Steel Car Co., Pittsburg.  
Rodger Ballast Car Co., Chicago.  
Russell Car & Snow-Plow Co., Ridgway, Pa.  
St. Louis Car Co., St. Louis.  
Standard Motor Truck Co., Pittsburg.  
Stephenson, John, Co., Elizabeth, N. J.  
Wason Mfg. Co., Springfield, Mass.
- Cars, Pay-As-You-Enter.**  
Pay-As-You-Enter Car Co., 26 Cortlandt St., New York.
- Cars, Rebuilt.**  
Detroit Carbuilding & Equipment Co., Detroit, Mich.
- Cars, Second-Hand.**  
Detroit Carbuilding & Equipment Co., Detroit, Mich.  
Marshall, R. W., & Co., 95 Liberty St., New York.
- Cars, Steel.**  
Pressed Steel Car Co., Pittsburg.  
St. Louis Car Co., St. Louis.  
Standard Motor Truck Co., Pittsburg.
- Castings, Brass.**  
Star Brass Works, Kalamazoo, Mich.
- Castings, Iron and Steel.**  
American Brake Shoe & Foundry Co., Mahwah, N. J.  
Green Engineering Co., Com'l Nat. Bk. Bldg., Chicago.  
National Brake & Electric Co., Milwaukee.  
Standard Steel Works Co., Philadelphia, Pa.  
Washburn Steel Castings & Coupler Co., Minneapolis.
- Catchers—(See Trolley Retrievers and Catchers).**
- Cattleguards.**  
Fairbanks, Morse & Co., Chicago.
- Circuit-Breakers.**  
Electric Service Supplies Co., 200 Plymouth Bldg., Chicago.  
General Electric Co., Schenectady, N. Y.  
Western Electric Co., Chicago.
- Coal Handling Machinery—(See Conveyors).**
- Coils—(See Armatures and Coils).**
- Commutators and Parts.**  
Electric Service Supplies Co., 1020-24 Filbert St., Phila.  
General Electric Co., Schenectady, N. Y.  
Marshall, R. W., & Co., 95 Liberty St., New York.  
Ohio Brass Co., Mansfield, O.  
Stuart-Howland Co., Boston.
- Compressors, Air.**  
Fairbanks, Morse & Co., Chicago.  
General Electric Co., Schenectady, N. Y.  
National Brake & Electric Co., Milwaukee.  
Westinghouse Traction Brake Co., Pittsburg.
- Concrete Mixers.**  
Contractors' Supply & Equip. Co., Chicago.
- Conduits.**  
Electric Service Supplies Co., 200 Plymouth Bldg., Chicago.  
Western Electric Co., Chicago.
- Connectors, Solderless.**  
Dossert & Co., 242 W. Forty-first St., New York.
- Contractors.**  
Arnold Company, 181 La Salle St., Chicago.  
Byllesby, H. M., Co., Am. Trust Bldg., Chicago.  
Columbia Construction Co., Milwaukee, Wis.  
Craghead Engineering Co., Cincinnati, O.  
Green Engineering Co., Com'l Nat. Bk. Bldg., Chicago.  
Register, A. L., & Co., 112 N. Broad St., Philadelphia.  
Sanderson & Porter, 22 William St., New York.  
Saxton, E., 841 Bladensburg Rd., Washington, D. C.  
Sheaff & Jaastad, 88 Broad St., Boston.  
Stone & Webster Engineering Corporation, Boston.  
Wharton, Wm., Jr., & Co., Philadelphia.  
White, J. G., & Co., 49 Exchange Pl., New York.
- Controllers and Attachments.**  
Electric Service Supplies Co., 200 Plymouth Bldg., Chicago.  
General Electric Co., Schenectady, N. Y.  
Johns-Manville, H. W., Co., New York.  
Marshall, R. W., & Co., 95 Liberty St., New York.  
Western Electric Co., Chicago.  
Westinghouse Electric & Mfg. Co., Pittsburg.
- Conveyors and Coal Handling Machinery.**  
Green Engineering Co., Com'l Nat. Bk. Bldg., Chicago.  
Northern Engineering Works, Detroit, Mich.
- Cord, Bell and Trolley.**  
American Car Co., St. Louis.  
Brill, J. G., Co., Philadelphia.  
Electric Service Supplies Co., 1020-24 Filbert St., Phila.  
Kuhlman, G. C., Car Co., Cleveland.  
St. Louis Car Co., St. Louis.  
Stephenson, John, Co., Elizabeth, N. J.  
Stuart-Howland Co., Boston.  
Wason Mfg. Co., Springfield, Mass.
- Couplers, Car.**  
American Car Co., St. Louis.  
Brill, J. G., Co., Philadelphia.  
Kuhlman, G. C., Car Co., Cleveland.  
McGuire-Cummings Mfg. Co., Chicago.  
Ohio Brass Co., Mansfield, O.  
St. Louis Car Co., St. Louis.  
Stephenson, John, Co., Elizabeth, N. J.
- Couplers, Car—Continued.**  
Van Dorn, W. T., Co., Paulina St., Chicago.  
Washburn Steel Castings & Coupler Co., Minneapolis.  
Wason Mfg. Co., Springfield, Mass.
- Coverings, Pipe and Boiler.**  
Johns-Manville, H. W., Co., New York.
- Cranes, Hoists and Lifts.**  
American Car Co., St. Louis.  
Brill, J. G., Co., Philadelphia.  
Brown Hoisting Machinery Co., Cleveland, O.  
Kuhlman, G. C., Car Co., Cleveland.  
Northern Engineering Works, Detroit, Mich.  
Railway Specialty & Supply Co., Chicago.  
Stephenson, John, Co., Elizabeth, N. J.  
Van Dorn & Dutton Co., Cleveland, O.  
Wason Mfg. Co., Springfield, Mass.
- Cross Arms—(See Brackets and Cross Arms).**
- Crossing Gates—(See Gates and Guards).**
- Crossings, Track—(See Switches, Frogs and Crossings).**
- Curtains, Fixtures and Materials.**  
American Car Co., St. Louis.  
Brill, J. G., Co., Philadelphia.  
Curtain Supply Co., 95 Ohio St., Chicago.  
Electric Service Supplies Co., 200 Plymouth Bldg., Chicago.  
Hartshorn Co., Stewart, East Newark, N. J.  
Kuhlman, G. C., Car Co., Cleveland.  
Marshall, R. W., & Co., 95 Liberty St., New York.  
National Lock Washer Co., Newark, N. J.  
Pantastote Co., 11 Broadway, New York.  
St. Louis Car Co., St. Louis.  
Stephenson, John, Co., Elizabeth, N. J.  
Wason Mfg. Co., Springfield, Mass.
- Cylinder Oil.**  
Power Specialty Co., 111 Broadway, New York.
- Derailing Devices.**  
Cleveland Frog & Crossing Co., Cleveland, O.
- Doors and Fixtures.**  
American Car Co., St. Louis.  
Brill, J. G., Co., Philadelphia.  
Kuhlman, G. C., Car Co., Cleveland.  
St. Louis Car Co., St. Louis.  
Stephenson, John, Co., Elizabeth, N. J.  
Wason Mfg. Co., Springfield, Mass.
- Draft Rigging.**  
Van Dorn, W. T., Co., Chicago.  
Washburn Steel Castings & Coupler Co., Minneapolis.
- Drills, Track.**  
Brown, H. P., 120 Liberty St., New York.  
Electric Service Supplies Co., 200 Plymouth Bldg., Chicago.  
Fairbanks, Morse & Co., Chicago.  
Kalamazoo Railway Supply Co., Kalamazoo, Mich.  
Marshall, R. W., & Co., 95 Liberty St., New York.
- Dynamo and Generators.**  
Fairbanks, Morse & Co., Chicago.  
General Electric Co., Schenectady, N. Y.  
National Brake & Electric Co., Milwaukee, Wis.  
Western Electric Co., Chicago.  
Westinghouse Electric & Mfg. Co., Pittsburg, Pa.
- Electric Instruments.**  
Electric Service Supplies Co., 200 Plymouth Bldg., Chicago.  
General Electric Co., Schenectady, N. Y.
- Electric Instruments—Continued.**  
Johns-Manville, H. W., Co., New York.  
Queen & Co., Philadelphia.  
Western Electric Co., Chicago.  
Westinghouse Electric & Mfg. Co., Pittsburg, Pa.  
Weston Electrical Instrument Co., Newark, N. J.
- Electric Railway Supplies, General.**  
Craghead Engineering Co., Cincinnati, O.  
Electric Service Supplies Co., 200 Plymouth Bldg., Chicago.  
Fairbanks, Morse & Co., Chicago.  
General Electric Co., Schenectady, N. Y.  
Johns-Manville, H. W., Co., New York.  
Marshall, R. W., & Co., 95 Liberty St., New York.  
Ohio Brass Co., Mansfield, O.  
Stuart-Howland Co., Boston.  
Western Electric Co., Chicago.
- Engineers and Contractors.**  
Arnold Company, Chicago.  
Byllesby, H. M., & Co., Chicago.  
Ford, Bacon & Davis, New York.  
Register, A. L., & Co., Philadelphia.  
Sanderson & Porter, New York.  
Saxton, E., Washington, D. C.  
Sheaff & Jaastad, Boston.  
Stone & Webster Engineering Corporation, Boston.  
White, J. G., & Co., New York.
- Engines, Gas and Oil.**  
Buckeye Engine Co., Salem, O.  
Fairbanks, Morse & Co., Chicago.  
Westinghouse Machine Co., Pittsburg.
- Engines, Hoisting.**  
Fairbanks, Morse & Co., Chicago.
- Engines, Steam.**  
Buckeye Engine Co., Salem, O.  
Westinghouse Machine Co., Pittsburg.
- Fans, Exhaust and Ventilating.**  
General Electric Co., Schenectady, N. Y.  
Western Electric Co., Chicago.  
Westinghouse Elec. & Mfg. Co., Pittsburg.
- Fare Boxes—(See Electric Railway Supplies).**
- Fare Registers and Register Fittings.**  
Electric Service Supplies Co., 200 Plymouth Bldg., Chicago.  
Rooke Automatic Register Co., Providence, R. I.
- Feed Wire—(See Wire and Cables).**
- Fenders and Guards.**  
Consolidated Car Fender Co., Providence, R. I.  
Eclipse Railway Supply Co., Cleveland, O.  
Electric Service Supplies Co., 1020-24 Filbert St., Phila.  
McGuire-Cummings Mfg. Co., Chicago.  
Marshall, R. W., & Co., 95 Liberty St., New York.
- Flangers, Snow.**  
Kalamazoo Railway Supply Co., Kalamazoo, Mich.  
McGuire-Cummings Mfg. Co., Chicago.  
Ohio Brass Co., Mansfield, O.  
Van Dorn & Dutton Co., Cleveland, O.
- Frogs—(See Switches, Frogs and Crossings).**
- Fuses and Fuse Devices.**  
Chase-Shawmutt Co., Newburyport, Mass.  
Electric Service Supplies Co., 200 Plymouth Bldg., Chicago.  
General Electric Co., Schenectady, N. Y.  
Johns-Manville, H. W., Co., New York.

# ST. LOUIS CAR CO. ST. LOUIS - MO.

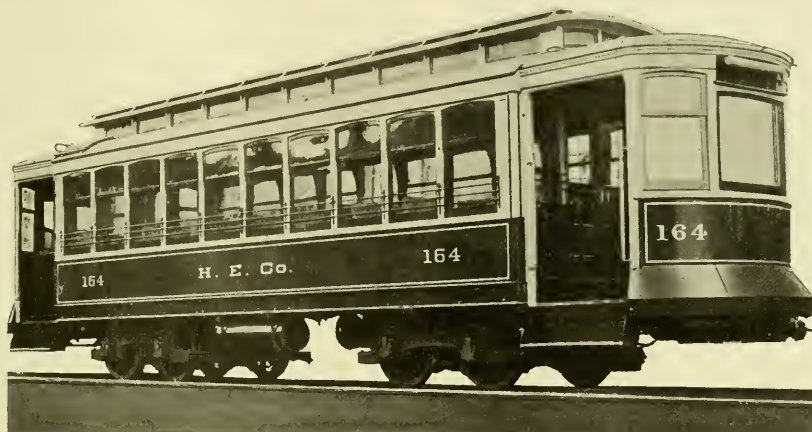

## St. Louis Car Company's Semi-Convertible Type

The illustration represents one of the cars recently shipped by us to the Houston Electric Company, Houston, Texas.

These cars are of our own design - a practically perfect Semi-Convertible type. Both lower and upper sashes raise into the roof. They move easily and when in the roof pockets are securely fastened, with no possible danger of falling and injuring passengers.

### Our construction of the Semi-Convertible Car is the very best that has yet been devised

These Houston cars are 28' over corner posts and 31' 6" over all. Width over arm rail, 8' 6". They are finished with very handsomely figured mahogany, provided with curtains at each window and each door opening and have the St. Louis Car Company's latest improved "Walkover" seat.

The cars are mounted on St. Louis Car Company's No. 47 Short Wheel Base Truck, which has been adopted as standard in a great many of the larger cities. The channel-iron and steel construction of the "Robertson type" permits the arm rail of the car to be placed very low and adds much to the appearance.

*Photographs, Blue Prints and Specifications will be mailed upon request.*

## CLASSIFIED LIST OF ADVERTISERS—Continued.

- Fuses and Fuse Devices—Continued.**  
Western Electric Co., Chicago.  
Westinghouse Elec. & Manufacturing Co., Pittsburg.
- Gaskets, Bronze.**  
Power Specialty Co., 111 Broadway, New York.
- Gates and Guards.**  
Kalamazoo Railway Supply Co., Kalamazoo, Mich.
- Gear Cases.**  
Electric Service Supplies Co., 200 Plymouth Bldg., Chicago.  
General Electric Co., Schenectady, N. Y.  
Marshall, R. W., & Co., 95 Liberty St., New York.
- Gears and Pinions.**  
Atlas Steel Casting Co., Newark, N. J.  
Electric Service Supplies Co., 200 Plymouth Bldg., Chicago.  
General Electric Co., Schenectady, N. Y.  
Marshall, R. W., & Co., 95 Liberty St., New York.  
Nuttall, R. D., Co., Pittsburg.  
Van Dorn & Dutton Co., Cleveland, O.
- Generators—(See Dynamos).**
- Gongs—(See Bells and Gongs).**
- Graphite Paint—(See Paint).**
- Grates, Chain.**  
Green Engineering Co., Com'l Nat. Bk. Bldg., Chicago.
- Grease—(See Lubricants).**
- Grinders.**  
Brown, H. P., 120 Liberty St., New York.
- Ground Connection Clamps.**  
Chase-Shawmut Co., Newburyport, Mass.
- Guy Anchors—(See Anchors).**
- Harps, Trolley—(See Trolley Poles and Fittings).**
- Headlights.**  
Electric Service Supplies Co., 200 Plymouth Bldg., Chicago.  
Fairbanks, Morse & Co., Chicago.  
General Electric Co., Schenectady, N. Y.  
St. Louis Car Co., St. Louis.  
Stuart-Howland Co., Boston.  
Trolley Supply Co., Canton, O.
- Heaters, Car, Electric.**  
Consolidated Car-Heating Co., New York, N. Y.  
Johns-Manville, H. W., Co., New York.
- Heaters, Car, Hot Water, and Stoves.**  
Baker, Wm. C., Heating & Sup. Co., New York.  
McGuire-Cummings Mfg. Co., Chicago.  
Smith, Peter, Heater Co., Detroit, Mich.
- Hoists—(See Cranes, Hoists and Lifts).**
- Hose Bridges.**  
Ohio Brass Co., Mansfield, O.
- Hydraulic Machinery.**  
Watson-Stillman Co., 26 Cortlandt St., New York.
- Inspection.**  
Central Inspection Bureau, 17 State St., New York.
- Inspection Cars, Gasoline.**  
Stover Motor Car Co., Freeport, Ill.
- Instruments, Measuring and Testing—(See Electrical Instruments).**
- Insulating Tapes.**  
General Electric Co., Schenectady, N. Y.  
Johns-Manville, H. W., Co., New York.  
Okonite Co., Ltd., 253 Broadway, New York.  
Western Electric Co., Chicago.
- Insulations and Insulating Material—Continued.**  
Creaghead Engineering Co., Cincinnati, O.  
Electric Railway Equipment Co., Cincinnati, O.  
Electric Service Supplies Co., 200 Plymouth Bldg., Chicago.  
General Electric Co., Schenectady, N. Y.  
Johns-Manville, H. W., Co., New York.  
Macallen Company, Boston.  
Ohio Brass Co., Mansfield, O.  
Okonite Co., Ltd., 253 Broadway, New York.  
Standard Paint Co., 100 William St., New York.  
Stuart-Howland Co., Boston.  
Western Electric Co., Chicago.
- Jacks.**  
American Car Co., St. Louis.  
Brill, J. G., Co., Philadelphia.  
Electric Service Supplies Co., 200 Plymouth Bldg., Chicago.  
Fairbanks, Morse & Co., Chicago.  
Kalamazoo Railway Supply Co., Kalamazoo, Mich.  
Kuhlman, G. C., Car Co., Cleveland.  
Marshall, R. W., & Co., 95 Liberty St., New York.  
Morden Frog & Crossing Co., Chicago.  
Stephenson, John, Co., Elizabeth, N. J.  
Wason Mfg. Co., Springfield, Mass.  
Watson-Stillman Co., 26 Cortlandt St., New York.
- Joints, Expansion—(See Steam Fittings).**
- Joints, Rail.**  
Rail Joint Co., 29 W. 34th St., New York.
- Journal Boxes.**  
American Car Co., St. Louis.  
Brill, J. G., Co., Philadelphia.  
Kuhlman, G. C., Car Co., Cleveland.  
McGuire-Cummings Mfg. Co., Chicago.  
St. Louis Car Co., St. Louis.  
Stephenson, John, Co., Elizabeth, N. J.  
Symington, T. H., Co., Baltimore, Md.  
Wason Mfg. Co., Springfield, Mass.
- Journal Lubricators—(See Lubricants).**
- Journal Packing, Steel Wool.**  
Robertson, Wm., & Co., Fifth Floor Great Northern Bldg., Chicago.
- Lamps, Arc and Incandescent.**  
Anderson, A. & J. M., Mfg. Co., Boston.  
Electric Service Supplies Co., 200 Plymouth Bldg., Chicago.  
General Electric Co., Schenectady, N. Y.  
Johns-Manville, H. W., Co., New York.
- Lamp Sockets.**  
Electric Service Supplies Co., 200 Plymouth Bldg., Chicago.  
General Electric Co., Schenectady, N. Y.  
Johns-Manville, H. W., Co., New York.
- Lantern Globes.**  
Railway Specialty & Supply Co., Chicago.
- Lifts—(See Cranes, Hoists and Lifts).**
- Lightning Arresters.**  
Electric Service Supplies Co., 200 Plymouth Bldg., Chicago.  
General Electric Co., Schenectady, N. Y.  
Stuart-Howland Co., Boston.  
Western Electric Co., Chicago.  
Westinghouse Elec. & Manufacturing Co., Pittsburg.
- Line Material.**  
Anderson, A. & J. M., Mfg. Co., Boston.  
Creaghead Engineering Co., Cincinnati, O.  
Johns-Manville, H. W., Co., New York.  
Electric Ry. Equipment Co., Cincinnati, O.  
Electric Service Supplies Co., 200 Plymouth Bldg., Chicago.
- Line Material—Continued.**  
General Electric Co., Schenectady, N. Y.  
Macallen, Co., Boston.  
Marshall, R. W., & Co., 95 Liberty St., New York.  
Stuart-Howland Co., Boston.  
Western Electric Co., Chicago.
- Lock and Nut Washers.**  
National Lock Washer Co., Newark, N. J.
- Lockers, Metal.**  
Electric Service Supplies Co., 200 Plymouth Bldg., Chicago.
- Locomotives.**  
Baldwin Locomotive Works, Philadelphia.
- Locomotives, Electric.**  
American Car Co., St. Louis.  
Baldwin Locomotive Works, Philadelphia.  
Brill, J. G., Co., Philadelphia.  
General Electric Co., Schenectady, N. Y.  
Kuhlman, G. C., Car Co., Cleveland.  
McGuire-Cummings Mfg. Co., Chicago.  
Stephenson, John, Co., Elizabeth, N. J.  
Wason Mfg. Co., Springfield, Mass.  
Westinghouse Elec. & Manufacturing Co., Pittsburg.
- Locomotives, Gasoline.**  
Fairbanks, Morse & Co., Chicago.  
Stover Motor Car Co., Freeport, Ill.
- Lubricants.**  
Dearborn Drug & Chemical Works, Chicago.  
Galena-Signal Oil Co., Franklin, Pa.  
Whitmore Mfg. Co., Cleveland, O.
- Lumber.**  
Advance Lumber Co., Cleveland, O.  
Barnes, G. H., Hardwood Lumber Co., St. Louis, Mo.  
Beldier, Francis, & Co., Chicago.  
Berthold & Jennings, St. Louis.  
Lindsay Bros. Co., Spokane, Wash.  
Humbird Lumber Co., Sand Point, Idaho.  
Lindsay Bros. Co., Spokane, Wash.  
National Pole Co., Escanaba, Mich.  
Nangle Pole & Tie Co., 226 La Salle St., Chicago.  
Pacific Coast Pole Co., Spokane, Wash.  
S-E Missouri Cypress Co., Campbell, Mo.  
Worcester, C. H., Co., Tribune Bldg., Chicago.
- Malleable Iron.**  
St. Louis Car Co., St. Louis.
- Measuring Tapes.**  
Lufkin Rule Co., Saginaw, Mich.
- Meters.**  
Johns-Manville, H. W., Co., New York.  
Queen & Co., Philadelphia.  
Weston Electrical Instrument Co., Newark, N. J.
- Mica, Raw and Manufactured.**  
Chicago Mica Co., Valparaiso, Ind.
- Motor Cars, Gasoline.**  
Stover Motor Car Co., Freeport, Ill.
- Motors, Electric.**  
Fairbanks, Morse & Co., Chicago.  
General Electric Co., Schenectady, N. Y.  
National Brake & Electric Co., Milwaukee.  
Partridge, Arthur S., 425 Olive St., St. Louis, Mo.  
Western Electric Co., Chicago.  
Westinghouse Elec. & Manufacturing Co., Pittsburg.
- Nut Locks.**  
Chase-Shawmut Co., Newburyport, Mass.  
National Lock Washer Co., Newark, N. J.  
Railway Specialty & Supply Co., Chicago.  
St. Louis Car Co., St. Louis.  
U. S. Metal & Mfg. Co., 25 Broad St., New York.
- Nuts and Bolts.**  
National Lock Washer Co., Newark, N. J.  
Railway Specialty & Supply Co., Chicago.
- Oilers.**  
Armstrong Oil Co., 31st and Chestnut St., Philadelphia.
- Oils—(See Lubricants).**
- Overhead Equipment—(See Electric Railway Supplies).**
- Packings.**  
Electric Service Supplies Co., 200 Plymouth Bldg., Chicago.  
Johns-Manville, H. W., Co., New York.  
Power Specialty Co., 111 Broadway, New York.
- Packing, Steel Wool Journal.**  
Robertson, Wm., & Co., Fifth Floor Great Northern Bldg., Chicago.
- Paints.**  
Standard Paint Co., 100 William St., New York.
- Pay-As-You-Enter Cars.**  
Pay-As-You-Enter Car Co., 26 Cortlandt St., New York.
- Pipe Bends and Fittings—(See Steam Fittings).**
- Poles, Metal.**  
Creaghead Engineering Co., Cincinnati, O.  
Electric Railway Equipment Co., Cincinnati, O.  
Electric Service Supplies Co., 200 Plymouth Bldg., Chicago.
- Poles and Ties, Wood.**  
Advance Lumber Co., Cleveland, O.  
Barnes, G. H., Hardwood Lumber Co., St. Louis, Mo.  
Beldier, Francis, & Co., Chicago.  
Berthold & Jennings, St. Louis.  
Churchill Cedar Co., Spokane, Wash.  
Humbird Lumber Co., Sand Point, Idaho.  
Lindsay Bros. Co., Spokane, Wash.  
National Pole Co., Escanaba, Mich.  
Nangle Pole & Tie Co., 226 La Salle St., Chicago.  
Pacific Coast Pole Co., Spokane, Wash.  
S-E Missouri Cypress Co., Campbell, Mo.  
Worcester, C. H., Co., Tribune Bldg., Chicago.
- Punches—(See Ticket Punches).**
- Rail Benders.**  
Electric Service Supplies Co., 200 Plymouth Bldg., Chicago.  
Fairbanks, Morse & Co., Chicago.
- Rail Bonds—(See Bonds, Rail).**
- Rail Bonds, Flexible.**  
Chase-Shawmut Co., Newburyport, Mass.
- Rail Drills—(See Drills, Track).**
- Rail Feed Wire—(See Wire and Cables).**
- Rail Joints and Chairs—(See Joints, Rail).**
- Rails, New.**  
New York Switch & Crossing Co., Hoboken, N. J.  
Wharton, Wm., Jr., & Co., Philadelphia.
- Railway Velocipedes.**  
Fairbanks, Morse & Co., Chicago.  
Kalamazoo Railway Supply Co., Kalamazoo, Mich.
- Registers and Fittings—(See Fare Registers).**
- Relays.**  
Weston Electrical Instrument Co., Newark, N. J.
- Roofing.**  
Johns-Manville, H. W., Co., New York.
- Sand Apparatus.**  
American Car Co., St. Louis.  
Brill, J. G., Co., Philadelphia.  
Electric Service Supplies Co., 200 Plymouth Bldg., Chicago.

# Pay-As-You-Enter Cars

*are simple  
in plan and  
operation:*

Passengers enter by way of the rear platform **only**, and directly under the eye of the conductor—no chance for accidents here through starting while passengers are in the act of boarding. And the company gets all the nickels, too.



Passengers leave by way of the front platform, directly under the eye of the motor-man, who has sole control of the exit door. And that means no accidents at the front end.

Pay-As-You-Enter Car operation means more nickels, fewer accidents, and closer adherence to schedules.

We license manufacturers and railways to build and use the Pay-As-You-Enter Car, the patents on which are owned by

## The Pay-As-You-Enter Car Company

DUNCAN McDONALD  
President

50 Church Street, New York

THOS. W. CASEY  
Manager

## CLASSIFIED LIST OF ADVERTISERS—Continued.

- Sand Apparatus—Continued.**  
Kuhlman, G. C., Car Co., Cleveland.  
Marshall, R. W., & Co., 95 Liberty St., New York.  
Ohio Brass Co., Mansfield, O.  
St. Louis Car Co., St. Louis.  
Stephenson, John, Co., Elizabeth, N. J.  
Wason Mfg. Co., Springfield, Mass.
- Sash Balances and Fixtures.**  
National Lock Washer Co., Newark, N. J.
- Sash Operating Devices.**  
Drouvé, G., Co., Bridgeport, Conn.  
Lord & Burnham, Irvington-on-Hudson, New York.
- Seats, Car—(See Car Seats).**
- Shade Rollers—(See Curtains, Fixtures and Materials).**
- Signals.**  
Telegraph Signal Co., Rochester, N. Y.
- Signal Supplies.**  
Railway Specialty & Supply Co., Chicago.
- Skylights.**  
Drouvé, G., Co., Bridgeport, Conn.  
Lord & Burnham, Irvington-on-Hudson, New York.
- Snow Plows, Sweepers and Scrapers.**  
American Car Co., St. Louis.  
Brill, J. G., Co., Philadelphia.  
Kalamazoo Railway Supply Co., Kalamazoo, Mich.  
Kuhlman, G. C., Car Co., Cleveland.  
McGuire-Cummings Mfg. Co., Chicago.  
Russell Car & Snow-Plow Co., Ridgway, Pa.  
Stephenson, John, Co., Elizabeth, N. J.  
Wason Mfg. Co., Springfield, Mass.
- Sockets, Waterproof.**  
Johns-Manville, H. W., Co., New York.
- Solder Paste.**  
Chase-Shawmut Co., Newburyport, Mass.
- Springs.**  
American Car Co., St. Louis.  
Brill, J. G., Co., Philadelphia.  
Kuhlman, G. C., Car Co., Cleveland.  
McGuire-Cummings Mfg. Co., Chicago.  
Marshall, R. W., & Co., 95 Liberty St., New York.  
Railway Steel-Spring Co., 71 Broadway, New York.  
St. Louis Car Co., St. Louis.  
Standard Steel Works Co., Philadelphia, Pa.  
Stephenson, John, Co., Elizabeth, N. J.  
Wason Mfg. Co., Springfield, Mass.
- Sprinkling Cars.**  
American Car Co., St. Louis.  
Brill, J. G., Co., Philadelphia.  
Kuhlman, G. C., Car Co., Cleveland.  
McGuire-Cummings Mfg. Co., Chicago.  
Stephenson, John, Co., Elizabeth, N. J.  
Wason Mfg. Co., Springfield, Mass.
- Stage Pockets and Plugs.**  
Chase-Shawmut Co., Newburyport, Mass.
- Steam Fittings, Etc.**  
Crane Co., Chicago.  
Davis, John, Co., Chicago.  
National Tube Co., Pittsburg, Pa.
- Power Specialty Co., 111 Broadway, New York.**  
Simmons, John, Co., 110 Centre St., New York.
- Steel Cars.**  
American Car Co., St. Louis.  
Brill, J. G., Co., Philadelphia.  
Kuhlman, G. C., Car Co., Cleveland.  
St. Louis Car Co., St. Louis.  
Stephenson, John, Co., Elizabeth, N. J.  
Wason Mfg. Co., Springfield, Mass.
- Steel Tapes.**  
Lufkin Rule Co., Saginaw, Mich.
- Stokers.**  
Babcock & Wilcox Co., 85 Liberty St., New York.  
Green Engineering Co., Com'l Nat. Bk. Bldg., Chicago.  
Model Stoker Co., Dayton, O.  
Westinghouse Machine Co., Pittsburg.
- Superheaters.**  
Power Specialty Co., 111 Broadway, New York.
- Switches, Frogs and Crossings.**  
Barbour-Stockwell Co., Cambridgeport, Mass.  
Cleveland Frog & Crossing Co., Cleveland, O.  
Fairbanks, Morse & Co., Chicago.  
Morden Frog & Crossing Co., Rookery, Chicago.  
New York Switch & Crossing Co., Hoboken, N. J.  
Railway Specialty & Supply Co., Chicago.  
Wharton, Wm., Jr., & Co., Philadelphia.
- Switchboards and Switchboard Instruments.**  
Anderson, A. & J. M., Mfg. Co., Boston.  
Chase-Shawmut Co., Newburyport, Mass.  
General Electric Co., Schenectady, N. Y.  
Western Electric Co., Chicago.  
Westinghouse Electric & Mfg. Co., Pittsburg.  
Weston Electrical Instrument Co., Newark, N. J.
- Tapes and Webbing.**  
Johns-Manville, H. W., Co., New York.  
Okonite Co., Ltd., 253 Broadway, New York.
- Testing Instruments.**  
Queen & Co., Philadelphia.  
Weston Electrical Instrument Co., Newark, N. J.
- Test Lamps, Pocket.**  
Chase-Shawmut Co., Newburyport, Mass.
- Ticket Choppers and Destroyers.**  
Pattin, Paul B., Salem, Mass.
- Ticket Punches.**  
Meyers, Fred J., Mfg. Co., Hamilton, O.  
Woodman Mfg. & Sup. Co., Boston.
- Ties and Poles, Wood—(See Poles and Ties).**
- Timber.**  
Beidler, Francis, & Co., Chicago.  
Lindsay Bros. Co., Spokane, Wash.  
S-E. Missouri Cypress Co., Campbell, Mo.
- Track Cleaners and Scrapers.**  
American Car Co., St. Louis.  
Brill, J. G., Co., Philadelphia.
- Track Cleaners and Scrapers—Continued.**  
Kalamazoo Railway Supply Co., Kalamazoo, Mich.  
Kuhlman, G. C., Car Co., Cleveland.  
McGuire-Cummings Mfg. Co., Chicago.  
Marshall, R. W., & Co., 95 Liberty St., New York.  
Ohio Brass Co., Mansfield, O.  
Stephenson, John, Co., Elizabeth, N. J.  
Van Dorn & Dutton Co., Cleveland, O.  
Wason Mfg. Co., Springfield, Mass.
- Track Drills—(See Drills, Track).**
- Tracklaying Machinery.**  
Holman, D. P., Ry. Tracklayer Co., 1192 Ellsworth Bldg., Chicago.
- Track Tools.**  
Electric Service Supplies Co., 200 Plymouth Bldg., Chicago.  
Kalamazoo Railway Supply Co., Kalamazoo, Mich.
- Trimmings, Car.**  
American Car Co., St. Louis.  
Brill, J. G., Co., Philadelphia.  
Curtain Supply Co., Park Row Bldg., New York.  
Kuhlman, G. C., Car Co., Cleveland.  
National Lock Washer Co., Newark, N. J.  
St. Louis Car Co., St. Louis.  
Stephenson, John, Co., Elizabeth, N. J.  
Wason Mfg. Co., Springfield, Mass.
- Trolley Guards.**  
Automatic Trolley Guard Co., 351 Ellicott Sq., Buffalo, N. Y.  
Electric Service Supplies Co., 200 Plymouth Bldg., Chicago.
- Trolley Poles and Fittings.**  
Garford Company, Elyria, O.  
General Electric Co., Schenectady, N. Y.  
Johns-Manville, H. W., Co., New York.  
Humphrey Trolley & Mfg. Co., 725 Chamber of Commerce Bldg., Detroit, Mich.  
Marshall, R. W., & Co., 95 Liberty St., New York.  
Nuttall, R. D., Co., Pittsburg.  
Star Brass Works, Kalamazoo, Mich.  
Trolley Supply Co., Canton, O.  
Westinghouse Electric & Mfg. Co., Pittsburg, Pa.
- Trolley Retrievers and Catchers.**  
Electric Service Supplies Co., 1020-24 Filbert St., Phila.  
Trolley Supply Co., Canton, O.
- Trolley Wagons.**  
Kalamazoo Railway Supply Co., Kalamazoo, Mich.
- Trolley Wheels—(See Trolley Poles and Fittings).**
- Trolley Wire—(See Wire and Cables).**
- Trucks, Car.**  
American Car Co., St. Louis.  
Baldwin Locomotive Works, Philadelphia.  
Brill, J. G., Co., Philadelphia.  
Kuhlman, G. C., Car Co., Cleveland.  
McGuire-Cummings Mfg. Co., Chicago.  
St. Louis Car Co., St. Louis.  
Standard Motor Truck Co., Pittsburg, Pa.  
Stephenson, John, Co., Elizabeth, N. J.  
Van Dorn & Dutton Co., Cleveland, O.
- Trucks, Car—Continued.**  
Wason Mfg. Co., Springfield, Mass.
- Turbines.**  
General Electric Co., Schenectady, N. Y.  
Westinghouse Machine Co., Pittsburg, Pa.
- Union Couplings.**  
National Tube Co., Pittsburg, Pa.
- Valves—(See Steam Fittings).**
- Varnish.**  
Electric Service Supplies Co., 200 Plymouth Bldg., Chicago.  
Standard Paint Co., 100 William St., New York.
- Ventilators.**  
Drouvé, G., Co., Bridgeport, Conn.  
Lord & Burnham, Irvington-on-Hudson, N. Y.
- Vestlettes.**  
Bellamy Vestlette Mfg. Co., Cleveland, O.
- Waste, Cotton and Wool.**  
Hagy, J. Milton, Waste Wks., Philadelphia, Pa.  
Railway Specialty & Supply Co., Chicago.
- Water Softening Compounds.**  
Dearborn Drug & Chemical Works, Chicago.
- Wheels and Axles.**  
American Car Co., St. Louis.  
Brill, J. G., Co., Philadelphia.  
Griffin Wheel Co., Chicago.  
Kuhlman, G. C., Car Co., Cleveland.  
McGuire-Cummings Mfg. Co., Chicago.  
Marshall, R. W., & Co., 95 Liberty St., New York.  
Railway Steel-Spring Co., New York.  
St. Louis Car Co., St. Louis.  
St. Louis Car Wheel Co., St. Louis.  
Standard Steel Works Co., Philadelphia, Pa.  
Stephenson, John, Co., Elizabeth, N. J.  
Wason Mfg. Co., Springfield, Mass.
- Window Fixtures.**  
Drouvé, G., Co., Bridgeport, Conn.
- Wiping Rags.**  
Hagy, J. Milton, Waste Wks., Philadelphia, Pa.
- Wire, Aluminum.**  
Aluminum Co. of America, Pittsburg, Pa.
- Wire, Insulated.**  
Aluminum Co. of America, Pittsburg, Pa.  
American Electrical Works, Providence, R. I.  
General Electric Co., Schenectady, N. Y.  
Okonite Co., Ltd., 253 Broadway, New York.  
Standard Underground Cable Co., Pittsburg, Pa.  
Stuart-Howland Co., Boston.
- Wire and Cables.**  
Aluminum Co. of America, Pittsburg, Pa.  
American Electrical Works, Providence, R. I.  
Bridgeport Brass Co., Bridgeport, Conn.  
General Electric Co., Schenectady, N. Y.  
Okonite Co., Ltd., 253 Broadway, New York.  
Standard Underground Cable Co., Pittsburg, Pa.

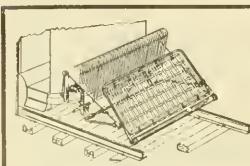

## ECLIPSE Life Guard

Manufactured by the  
ECLIPSE RAILWAY SUPPLY CO.  
Cleveland, Ohio



## TROLLEY WIRE, BARE COPPER CABLES WEATHERPROOF WIRE AND CABLES

RUBBER COVERED CABLES AND LEAD COVERED UNDERGROUND CABLES  
FOR ANY SERVICE. WRITE US FOR SPECIAL PRICES AT THIS TIME  
STANDARD UNDERGROUND CABLE CO.  
Pittsburg New York Boston St. Louis San Francisco Chicago  
Philadelphia Los Angeles Atlanta



# STANDARD HIGH-SPEED "INTERBOROUGH" DOUBLE TRUCK

TYPE C-60

**"Solid Forged"**

WITHOUT WELDS

FRAMES ARE MADE FROM ROLLED OPEN-HEARTH STEEL WITHOUT WELDS. ALL WEARING BOLTS ARE TURNED AND CASE HARDENED, AND WEARING HOLES STEEL THIMBLED. M. C. B. STANDARD PRINCIPLES ARE FOLLOWED. WE ARE PREPARED TO BUILD TRUCKS IN ACCORDANCE WITH PURCHASER'S DESIGNS AND SPECIFICATIONS.

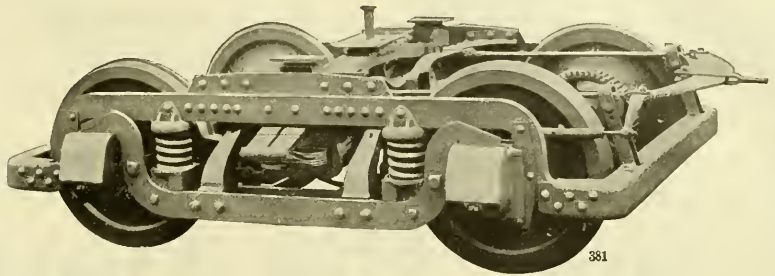

381

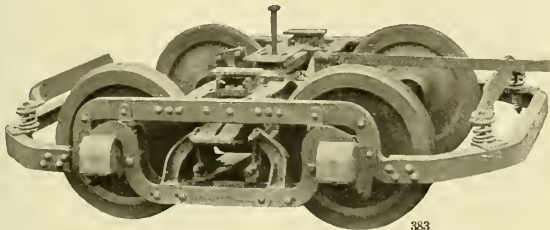

383

STANDARD  
**"SHORT WHEEL BASE"**  
 CITY AND SUBURBAN  
 DOUBLE TRUCK  
 TYPE O-50

STANDARD MOTOR TRUCK COMPANY, FRICK BUILDING, PITTSBURGH, PENNSYLVANIA  
 NEW YORK OFFICE: 170 BROADWAY      WORKS: NEW CASTLE, PA.      CHICAGO OFFICE: FISHER BUILDING

## THE BABCOCK & WILCOX COMPANY

85 Liberty Street, New York

Babcock & Wilcox — Stirling — A & T Horizontal — Cahall Vertical

# WATER TUBE STEAM BOILERS

STEAM SUPERHEATERS

Works: Bayonne, N. J.    Barberton, Ohio.

MECHANICAL STOKERS

BRANCH OFFICES:

Boston, Delta Bldg.  
 PHILADELPHIA, 1110-1112 North American Bldg.  
 SAN FRANCISCO, 63 First Street  
 PITTSBURGH, Farmers Deposit Nat. Bank Bldg.  
 NEW ORLEANS, 343 Baronne St.

DENVER, 410 Seventeenth St.  
 SALT LAKE CITY, 313 Atlas Block  
 WASHINGTON, Colorado Building  
 CHICAGO, Marquette Bldg.  
 ATLANTA, GA., 1132 Candler Bldg.

CLEVELAND, 706 New England Bldg.  
 MEXICO CITY, 7 Avenida, Juarez  
 HAVANA, CUBA, 116½ Calle de la Habana  
 LOS ANGELES, 321 Trust Bldg.  
 CINCINNATI, O., Traction Bldg.

## G E Motor Packing Waste

It is free from dirt and grit, holds the oil better and is easier to pack than ordinary waste.

One packing of the journal box will last longer than with other waste. Used by leading traction companies and electric motor manufacturers.

All grades of white and colored wiping waste, also sanitary cleaned wiping rags. Samples submitted.

**The J. Milton Hagy Waste Works**  
 433 Spruce St.      INCORPORATED      Philadelphia

# ALUMINUM

## Railway Feeders

And all kinds of **Electrical Conductors**

Aluminum Feeders are less than one-half the weight of copper feeders and are of equal conductivity and strength. If insulated wire or cable is required, high grade insulation is guaranteed.

Write for prices and full information.

**Aluminum Company of America**

PITTSBURGH, PA.

*Put into practice the principles  
laid down in this book*

# “The Motorman and His Duties”

*and the result will be better, safer  
and more economical operation!*

¶ Electric railway companies can well afford to place copies of this book in the hands of motormen and shopmen.

¶ Its purpose is to familiarize the reader with the operation of electric railway cars. It explains in simple language, devoid of mathematics and technicalities, many points not generally understood by the average employe who has to do with the operation or care of electric railway rolling stock. Such knowledge cannot fail to make his services more valuable to his company and more satisfactory to himself, and it will also better fit him for promotion.

The revised, enlarged and improved sixth edition is now ready. Two hundred pages; 138 illustrations; three folding sheets of multiple-unit car wiring diagrams; cloth binding.

Price, \$1.50 per copy, prepaid

Send for 16-page descriptive pamphlet

**The Wilson Company** 160 Harrison Street  
Chicago

# THE LOVELL Window Operator

is constructed on the straight push-and-pull principle

- working through a rack and pinion
- actuated by a chain- or cable-controlled wheel.

It is the simplest, strongest device and most positive in action of the many we know about.

Any length of sash in one run up to 500 feet instantly opened or closed at one station, and the most distant windows operate in unison with those nearest. A boy can do the trick as well as a man.

To reduce drafts in case of fire and to insure perfect ventilation at all times, nothing is quite so efficient as the Lovell Window Operator.

*Made only by*

## The G. Drouvé Co.

Bridgeport, Conn., U. S. A.

Western Office: 40 Dearborn Street, Chicago

1



The M. C. B. Christie Flanged Steel Back Brake Shoe for use on wheels with 3-inch tread and over.

## Why Use Steel Back Brake Shoes?

Because our M. C. B. Christie type steel back shoes are stronger, safer and wear longer than others.

That means the maximum of useful wear, because the shoes can be worn thin. They scrap at about 20% of their weight. Many of the antiquated combined brake heads and shoes scrap at 50%.

Steel back brake shoes of our make are the only absolutely safe shoes for heavy and high-speed equipment. They are made both flanged and unflanged and for both wide and narrow treads.

We can show you how to eliminate brake shoe troubles and save brake shoe money. Just write our nearest office.

## Electric Railway Lubrication

THE same skillful expert supervision given in this service as in steam railway service has produced most satisfactory results. Lower cost of lubrication with better service.

We are under contract with many of the largest Street and Interurban railways in the country.

We guarantee cost per thousand miles in Street and Electric Railway Service when conditions warrant it.

Including both Rolling Stock and Power House Equipment

Write for further particulars.

Galena-Signal Oil Company  
FRANKLIN, PENNSYLVANIA

## American Brake Shoe & Foundry Company

Mahwah, N. J.

170 Broadway  
New York

Western Union Bldg.  
Chicago

9

**THE ARNOLD COMPANY**  
ENGINEERS—CONSTRUCTORS  
ELECTRICAL—CIVIL—MECHANICAL  
181 LA SALLE STREET  
CHICAGO

**H. M. Byllesby & Company**  
Incorporated  
ENGINEERS  
Americo Trust Bldg., Chicago

Design, Construct and Operate  
Railway, Light, Power and  
Hydraulic Plants

EXAMINATIONS AND  
REPORTS

**J. G. WHITE & COMPANY**  
INCORPORATED

**Engineers, Contractors**

43-49 Exchange Place,  
41-43 Wall Street

**New York, N. Y.**

Principal Philippine Office: Manila, P. I.

**Complete Plants for the Rapid  
Handling of Material**

Every Sort of Hoisting Apparatus

**BROWN HOISTING MACHINERY CO.** Cleveland, Ohio

**VALVES—FITTINGS—STEAM SPECIALTIES**

**CRANE CO.**

CHICAGO

ESTABLISHED 1855



**“Not an  
Experiment”**

The Providence Fender  
is the Children's Fender.  
It is equally as effective in  
saving a child, and the  
person who has stumbled,  
as it is in saving those  
who are on their feet.

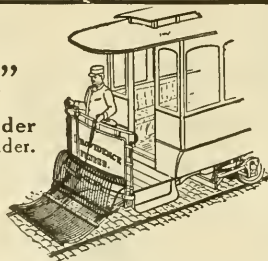

**CONSOLIDATED CAR FENDER COMPANY**

Office and Factory: PROVIDENCE, R. I.  
Branch Office: 110 E. Twenty-third St., New York  
European Agents: Comptoir d'Electricite, 6, Rue Boudreau, Paris, France

**A. L. REGISTER & CO.**

Engineers and General Contractors—Electric Railways  
112 North Broad St. PHILADELPHIA, PA. Established 1889

**CENTRAL INSPECTION BUREAU**

Inspection of Rails, Ties, Cars, Motors, Bridges, Buildings, Etc.  
17 STATE STREET - - - NEW YORK CITY

**LINE MATERIAL**

ELECTRIC SUPPLIES FOR RAILWAYS, POWER PLANTS, ETC.  
THE CREGHEAD ENGINEERING CO., 346 Main Street, Cincinnati, Ohio

**THE CURTAIN SUPPLY CO.**

CAR CURTAINS  
CHICAGO, 85-93 Ohio Street Hudson Terminal, 50 Church St., NEW YORK

**AUTOMATIC TROLLEY GUARD CO.**

61-69 Carroll St., Buffalo, N. Y. <sup>3</sup>  
“IT PUTS THE WHEEL ON THE WIRE”

**HOT WATER HEATERS FOR CARS**

THE PETER SMITH HEATER COMPANY, Detroit, Mich.

**GEARS AND PINIONS**

FOR ALL TYPES OF MOTORS

THE VAN DORN & DUTTON CO., CLEVELAND, OHIO

**RE-ENFORCED SPOKE WHEELS**

For City and Suburban Cars

ST. LOUIS CAR WHEEL CO., St. Louis, Mo.

**HART CONVERTIBLE BALLAST, CONCRETE AND CONSTRUCTION CAR**

RODGER BALLAST CAR CO., Railway Exchange, CHICAGO

**BRAKESHOOES**  
STANDARD  
BRAKESHOE COMPANY  
GEN'L OFFICES & WORKS - AURORA, ILL.; CHICAGO OFFICE 315 IVY EXCH.

SPRINGS—TIRES—STEEL-TIRED WHEELS

**RAILWAY STEEL-SPRING CO.**

General Offices: Cortlandt Bldg., 30 Church St., New York

WRITE TO **MODEL STOKER COMPANY** DAYTON OHIO

for detailed information about the best  
**AUTOMATIC SMOKELESS FURNACE**

**GRIFFIN WHEEL CO.**

CHILLED IRON CAR WHEELS IRON OR STEEL AXLES

**SMITH CONCRETE MIXER**

does the work better, quicker, cheaper and lasts longer.  
**CONTRACTORS' SUPPLY & EQUIPMENT COMPANY**  
Old Colony Building, Chicago 170 Broadway, New York 9

INSULATING  
VARNISHES  
(BAKING; AIR-DRYING)  
COMPOUNDS  
TAPE

**P&B**

Possess the  
Highest Insula-  
tive Efficiency.

The Standard Paint Co.  
100 William St.  
New York.

# Baltimore Center and Side Bearings

## FOR ELECTRIC TRUCKS

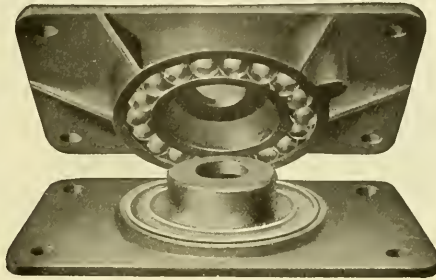

**Impossible  
to Clog  
Balls**

**No  
Lubrication  
Necessary**

**SAVES:** { FLANGE WEAR  
RAIL WEAR  
TRUCK REPAIRS

**DURABILITY:** { PROVEN  
UNDER  
HEAVIEST  
LOADS

BALTIMORE  
MD.

**THE T. H. SYMINGTON CO.**

CHICAGO  
ILL.

# TUBULAR POLES IRON OR STEEL



FOR  
ELECTRIC RAILWAYS  
ELECTRIC LIGHTING CO'S  
SIGNAL  
TELEPHONE (SER  
TELEGRAPH) (VICE  
TRANSMISSION  
LINE  
AND  
CATENARY  
SUSPENSION  
LINE

**ELECTRIC RAILWAY EQUIPMENT CO.**  
General Office: CINCINNATI O-U.S.A  
Shops: READING PA - WHEELING WVA

# STOP THIEF!

That is what our  
NEW BOND GUARD DOES



## Why Not Try Some

WHERE YOU HAVE TROUBLE  
WITH THEFT OF BONDS?  
*At Least Send for Literature*

**CHASE-SHAWMUT CO.**  
Newburyport, Mass.

### Baldwin Locomotive Works

BURNHAM, WILLIAMS & CO., PHILADELPHIA, PA., U. S. A.

Builders of  
**LOCOMOTIVES**  
of every description  
including  
**ELECTRIC  
LOCOMOTIVES**

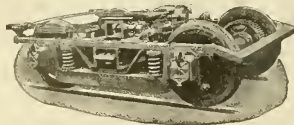

**ELECTRIC TRUCKS**

### Standard Steel Works Co.

HARRISON BLDG., PHILA., PA., U. S. A.

New York, N. Y. Cleveland, O. St. Louis, Mo. Denver, Colo.  
Portland, Ore. Richmond, Va. Chicago, Ill. St. Paul, Minn.  
San Francisco, Cal. Seattle, Wash. Winnipeg, Can

**Solid Forged  
Rolled and Steel Tired Wheels**

Mounted on axles fitted with Motor Gears  
for Electric Railway Service.

**LOCOMOTIVE TIRES RAILWAY SPRINGS  
FORGINGS CASTINGS**



For CABLE, ELECTRIC and  
ELEVATED CARS

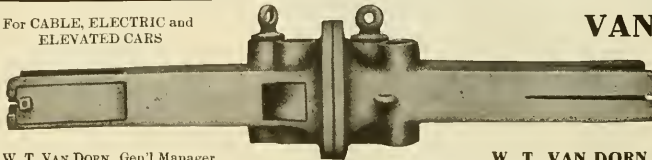

No. 5

W. T. VAN DORN, Gen'l Manager.

### VAN DORN AUTOMATIC COUPLERS

The records go farther than talk.  
Look up the records.  
Send for booklet of information on Couplings.

W. T. VAN DORN COMPANY, 1076 S. Paulina Street, CHICAGO



CONTINUOUS JOINT

Over  
**25,000**  
miles  
in use



WEBER JOINT

Rolled  
from  
Best Quality  
Steel



WOLHAUPTER JOINT

Catalogs at Agencies  
Baltimore, Md. Portland, Ore.  
Boston, Mass. Seattle, Wash.  
Chicago, Ill. St. Paul, Minn.  
Denver, Colo. St. Louis, Mo.  
Pittsburg, Pa. Troy, N. Y.  
London, Eng. Montreal, Can.

HIGHEST AWARDS—Paris, 1900;  
Buffalo, 1901; St. Louis, 1904

Additional safety and economy in Track Maintenance has been proved by the use of Continuous, Weber and Wolhaupter base-supported rail joints—after ten (10) years' service, having a record of over 25,000 miles in use—the extent of which is evidence of their excellence.

### THE RAIL JOINT COMPANY

General Offices: 29 West 34th Street, New York City  
Makers of Rail Joints for Standard and Special Rail Sections, also Girders, Steps or Compromise, and Insulating Rail Joints, protected by patents in United States and Foreign Countries.

# WHARTON SPECIAL TRACK WORK

OF EVERY DESCRIPTION  
FOR ALL CLASSES OF SERVICE

**MANGANESE  
STEEL  
TRACK WORK  
IS OUR SPECIALTY**

**WM. WHARTON JR. & CO.**  
INCORPORATED,  
PHILADELPHIA, PA. JENKINTOWN, PA.

**Avoid  
Accidents**

By Using  
This  
Switch

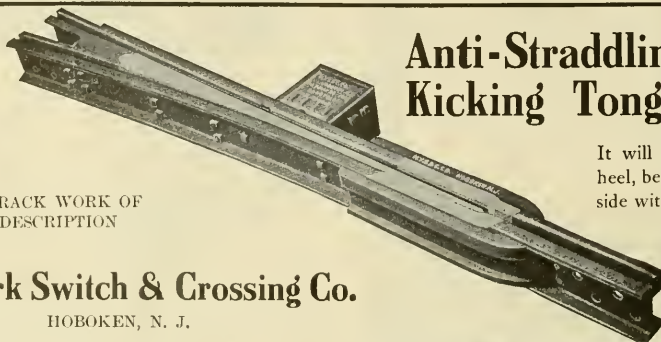

### Anti-Straddling or Anti- Kicking Tongue Switch

It will not drive down at the heel, because it is held to either side with a spring tension and firmly down on its bed. A car can not straddle this tongue.

SPECIAL TRACK WORK OF  
EVERY DESCRIPTION

**New York Switch & Crossing Co.**

HOBOKEN, N. J.

**WRITE FOR SPECIAL  
CIRCULAR**

# FOR SALE. FOR QUICK DELIVERY

## 6 55-ft. Passenger, Baggage and Smoking Car Bodies

Main Compartment 26' 0"  
 Smoking " 10' 6"  
 Baggage " 10' 0"  
 Seating Capacity, 54

## 8 60-ft. Passenger, Baggage and Smoking Car Bodies

Main Compartment 28' 6"  
 Smoking " 11' 0"  
 Baggage " 8' 0"  
 Seating Capacity, 58

## 5 52-ft. Passenger and Smoking Car Bodies — Double End

Seating Capacity, 60

## 3 52-ft. Passenger and Baggage Car Bodies — Double End

Seating Capacity, 56

## 2 50-ft. Express Car Bodies

*Write or wire us for further information.*

**The Jewett Car Co.** Newark Ohio

**THE MIGHTY MIDGET**

## HOT WATER CAR HEATER

Adapted for Large Electric Cars and Long Distance Lines. Exclusively used on Largest Electric Systems. Ask for Catalog

**THE WILLIAM C. BAKER HEATING & SUPPLY CO.,** 143 LIBERTY STREET NEW YORK



## NILES CARS — THE ELECTRIC PULLMANS

LARGE, FAST INTERURBANS  
 OUR SPECIALTY

## NILES CAR & MFG. COMPANY

WORKS: NILES, OHIO

Sales Office:  
 J. A. HANNA CO., 312 Electric Bldg., Cleveland, O.

# McGUIRE-CUMMINGS MFG. Co.

CHICAGO



SPRINKLERS, CARS,  
 TRUCKS AND RAIL-  
 WAY EQUIPMENT

**The Lindsley Brothers Company**  
 Producers and Shippers of and Manufacturers of  
**WESTERN CEDAR POLES** **RED FIR CROSS ARMS**  
 Eastern Sales Office, Monadnock Bldg., CHICAGO SPOKANE, WASHINGTON

**Poles and Ties**  
 A Selected Stock in Chicago for Rush Shipment  
 A Number of Large Yards in the North  
**NAUGLE POLE & TIE CO.**  
 CHICAGO OFFICE: 226 LA SALLE STREET

Red **Cedar Poles** White  
 Prompt deliveries at right prices.  
**NATIONAL POLE COMPANY**  
 EVERETT, WASH. ESCANABA, MICH.

**C. H. WORCESTER CO.**  
**CEDAR POLES**  
 PRODUCERS AND WHOLESALERS  
 Suite 1710 Tribune Building CHICAGO

**Idaho Cedar Poles**  
 PACIFIC COAST POLE CO. SPOKANE, WASH.

**Shelby Trolley Poles**  
 Made from Cold Drawn Seamless Steel Tubing.  
 Immediate delivery all sizes from stock.  
**The Garford Company : Elyria, O.**

We are Producers and Wholesale Dealers in Western  
**CEDAR POLES**  
 Yards in Washington, Idaho, Montana  
 and British Columbia  
 WRITE US FOR DELIVERED PRICES  
**CHURCHILL CEDAR CO.,** Box 1409, Spokane, Wash.

<b>WHITE CEDAR</b>	<b>P O L E S</b>	Large Stock 14 to 65 ft. Prompt Shipment
<b>P O L E S</b>		
<b>YARDS:</b> Menominee, Mich. Escanaba, Mich. Superior, Wis. Deer River, Minn.		<b>FRANCIS BEIDLER &amp; CO.</b> Chicago, Ill.

**BERTHOLD & JENNINGS**  
 LUMBERMENS BLDG. SAINT LOUIS, MO.

**TIMBERS**  
 L. L. Pine, Oak

**POLES**  
 Cedar, Cypress, Chestnut

**TIES**  
 Oak, Cypress, Chestnut

**HEINE SAFETY BOILER CO.**  
 421 OLIVE STREET, ST. LOUIS, MO.  
 Manufacturers of WATER TUBE BOILERS

**G. H. BARNES HARDWOOD LUMBER CO.**  
 Office and Yard: Main and Warren Sts., ST. LOUIS, MO.  
 Ties, Car Oak, Poplar, Ash, Cherry, Plain and Quartered Oak

**POLES and PILING** 20,000 35s and 40s, Ready to Ship at Once  
 S-E. MISSOURI CYPRESS CO., CAMPBELL, MO.

<b>POLES and TIES</b>	We have a nice selected stock of <b>Chestnut Poles</b> White and Common <b>OAK and CHESTNUT TIES</b>	<b>The Advance Lumber Co.</b> 1313 Rockefeller Building <b>CLEVELAND OHIO</b>
-----------------------	---	---



One road reports gear cases packed with

## Whitmore's Gear Protective Composition

car in continuous operation one year and one week, no further applications made, absolutely no wear on either gears or pinions. These results are what cause our competitors to make false statements about the use of our goods. Try it and be convinced.

**The Whitmore Manufacturing Company**  
LUBRICATING ENGINEERS  
Cleveland, Ohio, U. S. A.



Established 1877.



## ALBERT & J. M. ANDERSON MFG. CO.,

Makers of

**ELECTRICAL APPLIANCES:**  
SWITCHES, SWITCHBOARDS,  
TIME SWITCHES, LINE MATERIAL,  
COPPER CASTINGS (75%) CONDUCTIVITY.  
289-293 A ST., BOSTON, MASS., U. S. A.

Branches: New York, 135 Broadway. Chicago, 175 Dearborn Street.

Agencies:

Boston, Pettingell-Andrews Co. San Francisco, Eccles & Smith Co.  
New York, R. W. Marshall & Co. Atlanta, Newcomer-Murry Co.  
St. Louis, J. C. White. Denver, E. M. Messiter.  
Toronto, Ont., H. J. Surtees.



## Queen Testing Sets

"The Recognized Standard"

Voltmeters  
Ammeters  
Switchboard and Portable  
Alternating and Direct Current



Queen Acme Testing Set

U. S. Standard Testing Sets  
Rail Bond Testers  
Galvanometers, etc., etc.  
Electrical Instruments for All Purposes

**QUEEN & CO., Inc., Philadelphia, Pa.**

## Mica Prices Reduced

Compare our prices on Raw Mica and Manufactured Mica with prices you have been paying our competitors

**WHY PAY  
FANCY  
PRICES?**

*We do not intend to change or increase our list prices.  
We do not follow our competitors.*

Chicago Mica Co.

Valparaiso, Ind.

## STEEL WOOL JOURNAL PACKING

- saves one-half the packing
- saves one-third the oil
- saves labor and wear
- prevents hot boxes **positively**

No other packing you ever heard of can do these things!

*Send today for free sample*

**WM. ROBERTSON & COMPANY**

General Office: Great Northern Bldg., CHICAGO  
Factory: 75 S. JEFFERSON ST., BATTLE CREEK, MICH.

9

## WESTON Standard Portable Direct-Reading



Voltmeters  
Millivoltmeters  
Voltammeters  
Ammeters  
Milliammeters  
Ohmmeters  
Ground Detectors  
and Circuit Testers

OUR STATION VOLTMETERS and AMMETERS are unsurpassed in point of extreme accuracy and lowest consumption of energy.

**WESTON ELECTRICAL INSTRUMENT CO.**

Main Office and Works: Waverly Park, Newark, N. J.

London Branch: Audrey House, Ely Place, Holborn, Paris, France: E. H. Cadiot, 12, Rue St. Georges. New York Office: 74 Cortlandt St. Berlin: European Weston Electrical Instrument Co., Ritterstrasse, No. 88.

## Washburn "K" Type Traction Coupler

Complete with Draft Rigging

Simple  
Strong  
Durable



This device is composed of the "K" head—a heavy cast steel extension made in any length—and the "K" pivoted draft box spindle type. Made also in a heavier coupler and with the regulation 6 1/4 x 8 M. C. B. draft spring.

*Ask for new catalogue of traction devices.*

**Washburn Steel Castings & Coupler Co., Minneapolis, Minn.**

Western Agents: Tweedy, Hood & Finlen, 2014 Fisher Bldg., Chicago

Canadian Agent: John Taylor, Montreal

# CLASSIFIED ADVERTISEMENTS

Undisplayed advertisements are inserted under this heading at the uniform rate of one cent a word; minimum charge twenty-five cents. Replies directed to this office will be forwarded when required to any address in the United States, Canada or Mexico without extra charge. Advertisements received at the Chicago office by 9 a. m. Thursday will appear in the issue for the same week.

## POSITIONS WANTED.

Wanted—Position as armature winder and mechanic. Ten years' experience. Can furnish good reference. Address "No. 586," care of Electric Railway Review, Chicago.

Want work on right of way, franchises, stock sales, etc. Promotor's right-hand man. Always in harness. Reliable and experienced. Address "No. 588," care of Electric Railway Review, Chicago.

Wanted—To correspond with company needing the services of high-class general manager or general superintendent. Electrical and civil engineer; 17 years' experience with large properties and in construction and operation. Address "No. 563," care of Electric Railway Review, Chicago.

An experienced supply salesman, who also has had thirteen years' operating experience on city lines, desires to form connection with a railway supply house handling either electric or steam supplies or both. Would consider proposition to open sales agency. Address "No. 566," care of Electric Railway Review, Chicago.

## POSITIONS WANTED.

Wanted—Position as superintendent of rolling stock or master mechanic on city or interurban railway. Have satisfactorily handled similar work on large metropolitan properties since horse car days. At liberty now; references exceptional. Address "No. 580," care of Electric Railway Review, Chicago.

Experienced electrical engineer wants position with manufacturing concern or with company operating electric railways. Graduate Purdue University, 1905. Will go anywhere for permanent position. Age 26; married; A No. 1 references as to habits and ability. Address "No. 570," care of Electric Railway Review, Chicago.

Position wanted as auditor and accountant. Sixteen years of steam, electric and general experience; good working knowledge of details of general contracting business; clever buyer; possess ability to organize. Can furnish first-class reference as to character and ability and work accomplished in past; leaving present work because closed; at liberty to accept position any time. Address "No. 575," care of Electric Railway Review, Chicago.

## POSITIONS OPEN.

General manager wanted for combined electric railway, electric light and gas property, operating 25-mile city and interurban railway located in middle west. Promotion assured for capable man. Must be able to handle relations with public, as well as operate property economically. Address "No. 589," care of Electric Railway Review, Chicago.

## BUSINESS OPPORTUNITIES.

Wanted—Man with some capital and a knowledge of railway track supplies to join the advertiser—a salesman handling locomotive and car supplies—in a general railway supply business. Address "No. 583," care of Electric Railway Review, Chicago.

## BOOKS AND PUBLICATIONS.

Wanted—Copies of the Street Railway Review of April, 1900, May, 1901, and August, 1903. State price and condition. Address "No. 587," care of Electric Railway Review, Chicago.

We want your friends to read the Electric Railway Review. You will do them—and us—a favor by sending their addresses. We will gladly mail free sample copies. Electric Railway Review, 160 Harrison Street, Chicago.

## BUSINESS OPPORTUNITIES

Wanted—To exchange, first mortgage gold bearing 5 1/2 per cent bonds for material for electric railway, issue limited as to amount per mile; right of way held by company in fee simple. Those interested address Chicago Ottumwa & Western Railway, Hamilton, Ia.

Recharging Dry Batteries, the only book ever published giving complete directions of how to prepare chemicals for renewing dry batteries. If you are not more than pleased with this book your dime back. Large electrical catalogue and book postpaid, 10 cents. Adams Electric Co., Dept. E. R., Kewanee, Ill.

Wanted—Copies of Street Railway Review, January to June, 1906, inclusive, and one copy each January and February, 1907. Also Electric Railway Review for January 5, 1907. State condition and price. Address "No. 582," care of Electric Railway Review, Chicago.

**R. W. MARSHALL & CO.**  
50 Church St., New York  
Second-Hand Machinery and Equipment  
**ELECTRIC RAILWAY MATERIALS**

**The Russell Combination Electric Car and Snow-Plow**  
Remove the noses of your Russell electric combination car and snow-plow and you have an electric locomotive, freight, baggage or express car in one. One investment buys two pieces of equipment. Write us.  
**RUSSELL CAR & SNOW-PLOW CO.,** Ridgway, Pa.  
Wendell & MacDuffie, New York; C. A. Ralston, Chicago  
**IS USEFUL ALL THE YEAR ROUND**

**FOR SALE**  
Baldwin-Westinghouse Electric  
Trolley Switching Locomotive  
Weight about 55,000 lbs., gauge 4 ft. 8 1/2 in., 4 motors, 220 volts, diameter of drivers 30 in.  
Address "Electric Locomotive"  
Office of Electric Railway Review  
50 Church Street, New York City

## FOR SALE: Three Car Bodies and Three Pairs of Double Trucks

with or without electric equipment and air brakes; all new and never used. Compelled to sell, as these cars will not operate over a leased line by reason of their width and length.

**R. W. MARSHALL & CO., 50 Church St., New York, N. Y.**

The soft steel flanges of the  
**Ideal Trolley Wheel**  
have an absolutely uniform thickness that insures *perfect balance*. And perfect balance means high mileage.

Buffalo **LUMEN BEARING CO. Toronto**

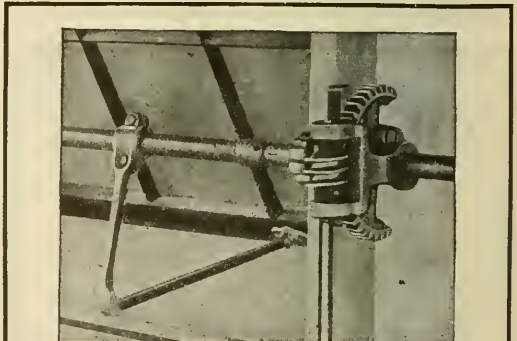

## The Ventilation

of your Shops, Foundries and Car Barns is made especially effective by a speedy, positive and easily manipulated **Sash Operating Apparatus** which automatically locks the sash at any position.

Let us send you our catalogue.

**Lord & Burnham Company**  
Irvington-on-Hudson, N. Y.

## Send Us Your Book List

We publish a number of standard works on railway and allied subjects, both electric and steam. We sell all that are in print. Write us.

**The Wilson Company** 160 Harrison Street  
CHICAGO

## THE NATIONAL LOCK WASHER CO., NEWARK, N. J.

Curtains — Curtain Fixtures — Sash Locks — Sash Balances — Nut Locks

CHICAGO OFFICE: 419 MONADNOCK BLOCK

## Equip your line with the Telegraph Signal System

—then your dispatcher will be in constant touch with every car and train on the line

—with the result that accidents will be prevented, traffic facilitated and schedules adhered to more closely



Write us for the facts

### Telegraph Signal Company

282 State Street - Rochester, N. Y.



## The Knutson Trolley Retriever



—most successfully used by high-speed electric railways because it is a *real* retriever—not a mere catcher with a misleading name.

And there is a mighty big difference between the Knutson and all others! Better investigate fully *before* you spend your money.

Write us for facts or send for a sample lot to test on your road at our expense.

### The Trolley Supply Co.

Canton, Ohio

10

## Hydraulic Railroad Tools

- 400 Types of Hydraulic Jacks.
- 50 Types of Hydraulic Punches.
- 10 Types of Hydraulic Rail Benders.
- 15 Types of Crank Pin Presses.
- 40 Types of Wheel Presses.
- Dozens of other hydraulic tools you need. Every tool guaranteed.

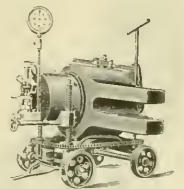

Send for Railroad Catalogue.

### THE WATSON-STILLMAN CO.

50 Church Street, New York City  
Branch Office: 453 The Rookery, Chicago, Ill.

1

**PIPE FITTINGS  
AND VALVES**  
FOR THE  
HEATING AND PLUMBING TRADE

TRADE  MARK

**JOHN SIMMONS CO.**  
104-110 Centre Street, NEW YORK



## SHELBY STREET RAILWAY LAMPS

Built to withstand vibration. 50% more light below the lamp. No additional current required. We make a special current-saving lamp for park use. Write for prices

**THE SHELBY ELECTRIC CO., Shelby, O.**

Passengers soon become accustomed to the

## Rooke Automatic Fare Collector

and make it a point to have their nickels ready.

They like the plan—all honest conductors like it—and its use puts every nickel collected into the company's treasury.

**Rooke Automatic Register Company**  
Providence, Rhode Island

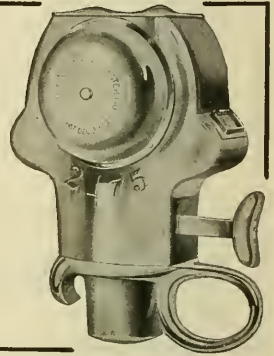

## Peacock Brakes

are made in different sizes  
to fit cars of various sizes

Each size takes up slack faster than any other chain brake, gives greater braking power than any other chain brake, is less likely to get out of order than any other chain brake, is less expensive than most other chain brakes.

Furthermore, the Peacock Brake is the only chain brake that will control any electric car on any grade where cars operate. And you don't need to keep repair parts in stock. We keep them, but never had a call for them.

We'll send you a pair for trial, at our own expense, if you say the word.

## National Brake Co.

888 Ellicott Square  
BUFFALO, N. Y.

Wigmore Bros. Co.  
Pacific Coast Agents  
Los Angeles, Cal.



# Electric Railway Review

PUBLISHED EVERY SATURDAY BY THE WILSON COMPANY, CHICAGO

Entered as second-class matter January 5, 1907, at the postoffice at Chicago, Ill., under the act of March 3, 1879.

CHICAGO: 160 Harrison Street  
NEW YORK: 50 Church Street  
CLEVELAND: 1529 Williamson Bldg.

VOL. XIX  
No. 22

CHICAGO, MAY 30, 1908

Whole No.  
286

Subscription: Domestic, \$2.00  
Foreign, 5.00  
Canada, 3.50

By reason of the consolidation of the Electric Railway Review and the Street Railway Journal, which becomes effective on June 1, this issue completes Volume 19 of the Electric Railway Review. The first issue of the "Electric Railway Journal" will be that of June 6. For the convenience of those who wish to bind their copies of the Electric Railway Review a comprehensive subject index of the articles comprising this volume from January 1, 1908, to date has been prepared. Copies of this index will be forwarded to subscribers upon request addressed to the Electric Railway Journal at the Chicago office in the Old Colony building or at the principal office, 239 West Thirty-ninth street, New York.

**Belt**  
**Lines and**  
**Congestion.**

Belt line service occupies a valuable place in many cities where the conditions favor the handling of traffic by long looped routes, but a case sometimes arises where the introduction of belt line movements works a real hardship in the facility of taking care of the through business. An instance of this occurred in Boston recently in connection with a petition to the railroad commission for additional surface cars in the Charlestown district. The petitioners claimed that the present facilities were inadequate, causing long and vexatious delays and suggested as a remedy the establishment of a belt line with cars operating on a maximum headway of 10 minutes. The board on investigating the area in question found that it was served by both the surface and elevated trains of the Boston elevated, and that if the short-time headway called for in the schedules could be properly maintained, the accommodations would be reasonable. The unsatisfactory conditions were not due to an insufficient number of cars, but to physical obstacles beyond the company's control. From a study of traffic tables the board concluded that the installation of an additional line would tend to further congest the travel. If a belt line were installed to handle the situation it might be possible to operate it without its being subject to bridge and grade crossing delays, but in order to do so it would disarrange existing schedules. Cases of this kind illustrate the need of thorough analysis before establishing new routes to meet an apparent demand for additional facilities. On general principles the value of a belt line service in a district served by irregular headways would not be questioned, but local conditions exert modifying influences upon the advisability of changes.

**Vigilance**  
**in**  
**Discipline.**

Again we repeat the statement that the increase in traffic which the electric railways are pleased to meet throws greater responsibility upon the operating departments. The load, of course, falls upon the shoulders of the superintendent of transportation and indirectly on his assistants and train crews. Under ordinary conditions the operating of cars according to well-tried schedules requires no more vigilance than the ordinary thought needed to observe the rules of the road. However, when it becomes

necessary that changes in existing schedules be made, resulting either from demands for increased service or from a reduction to accommodate decreasing traffic, then the responsibility of direction and enforcement of discipline must become greater. Variations in schedules may require changes in long-established meeting points. The dangers of so-called lapses of memory aided by force of habit assert themselves and call for constant vigilance at such times. A thoroughly carried out system of demerits or other method of disciplining shows itself to be of greatest value when schedules are being changed. A recent instance where a change in a long existing schedule was replaced by a shorter headway with varied meeting points resulted in a misunderstanding on the part of the train crews and was attended by a disastrous head-on collision. In this case the trainmen of the two cars which collided, a limited and a local, were endeavoring to follow a new and faster schedule. In so doing the men either forgot a meeting point or misinterpreted their orders with the disastrous results so well advertised by the daily papers. The dispatching system has received much attention of late and in most cases the methods conform to well-tried principles; yet even with a most perfect dispatching system extreme vigilance on the part of the men higher up will only prevent a laxity which sooner or later may result in disaster. With the opening of summer the traffic to amusement resorts and the usual excursion business will require a variation in schedules in many instances and it is at this time that, in a spirit of constructive criticism, we suggest the dangers that may follow a relaxation in watchfulness by those responsible for the operation of electric interurban cars.

**Oil**  
**Engine**  
**Testing.**

The use of oil engines of various types in moderate capacity power plants is much more general than the running of economy tests upon this form of prime mover. In very small installations it doubtless does not pay to test the equipment except by the results of service operation, but if the cost of power is an important

part of the total running expenses much can be learned from a test that cannot be determined in any other way. It is a mistake to assume that the making of a test on an internal combustion engine is a complex and expensive matter. All the essential data to enable the performance of an engine to be judged and adjusted can be secured with few instruments and small trouble compared with the burdens of making a test of equal thoroughness upon a steam plant of the same size. The physical quantities concerned in the operation of an oil engine are readily measured, even in units as large as 500 horsepower. The test record should give the principal dimensions of the engine, the various temperatures, pressures, speeds, cooling water quantities, calorific value of the fuel burned, composition of the exhaust gases and cylinder power as deduced from carefully taken indicator cards. If the engine is direct connected to a generator and the unit has been purchased on a combined efficiency specification, it may not be necessary to measure the brake horsepower of the engine, but in single engine testing the measurement of brake horsepower is perhaps the most satisfactory course, for it enables the mechanical efficiency

and the service economy of the engine to be closely ascertained without the uncertainty of an estimate. The latter performance can of course be secured on the kilowatt-hour basis, but unless the efficiency of the generator at various loads is known the exact part played by the engine in the performance of the set must in some degree be estimated instead of experimentally measured. Summing up these statements the point to be remembered is that it is far easier to test an engine using oil than a steam plant and the returns are just as great.

---

All managers of electric railways should appreciate that keen competition exists in most cities between the street railways and the local cab drivers and owners. The competition is most severe at railroad stations and the cabs undoubtedly carry a large number of strangers each year who have no information concerning the facilities offered by the local traction company. As a rule no attempt is made to advertise local trolley service to steam railway passengers either before they reach their destinations or at or near the railway stations. The managers of electric railways are likely to ignore this subject in the belief that the travelers who can afford to use carriages will do so anyway, regardless of the trolley facilities. Further thought than that belief indicates is justified. The traveling public, entering a city on a steam road, should be impressed with the advantages of electric railway service, its promptness and low cost. If electric railway companies post clear maps of the system, with the timetables or at least the headways of the most important lines in conspicuous places in railroad stations the investment would be slight and it should yield a large return. A slight consideration would probably induce the steam railway companies to grant the privilege of posting maps of this character. The use of illuminated signs showing the car routes leading to principal points would assist strangers. It might be possible to arrange with news agents on the trains or with the railroad advertising agencies to distribute inexpensive folders as trains approach the more important terminals. Observation has shown that the average traveler will patronize the local trolley service in preference to a carriage costing 10 to 20 times as much if he can only be made acquainted on arriving at a strange city with the fact that the street railway will transport him quickly to his point of destination. If the electric railway lines pass the principal hotels the fact ought to be advertised plainly, so that the new arrival may have an opportunity to select at once which means of transit he will take. In fare per passenger the electric road is so much more desirable than its competitors that a little energetic advertising will save many fares that are now lost.

---

#### GAS ENGINES AND THEIR RATING.

For many years internal combustion engines have given reliable service in handling small loads. Recently, however, the desire for increased economy in electric power plant operation has brought about a widespread study of the gas engine and gas producer problems with a view to the use of large units. The results have been wonderful. During a short period the size of gas engines which can be relied upon for driving electric generators has increased from units of 100 horsepower or less to engines with ample capacity to operate 5,000-kilowatt electric generators.

One of the best indications that the gas engine is sure to become a favored prime mover is because no engineering society of any prominence now neglects to appoint committees to study the problem or have papers presented to it written by those particularly interested in gas engine development. At the convention of the National Electric Light Association, Chicago, on May 19, 20, 21 and 22, a committee of three mem-

bers presented a printed report comprising 172 pages, descriptive of and discussing the recent advancements in the gas engine field. The conclusions of this committee are especially valuable at this time.

Because of the high thermal efficiency of the combined gas engine and producer it is held that advancement in this field must come rapidly and therefore power users can well afford to study the problem. While the relative efficiency of a steam plant with engines and turbines and a combined gas producer and gas engine plant cannot be set down in definite figures it can, nevertheless, be safely stated that the gas engine plant has the advantage in economy of operation. Conditions under which the larger gas engines are now operating and the varied design of the units do not yet make it possible to obtain any authoritative figures as to operating costs and maintenance. The committee, however, says: "There should be available within the next year information as regards the operating expenses of large gas engines that will enable comparisons to be made with the operating expenses of steam engines or turbines."

The enormous growth of the gas engine business is made apparent when it is stated that there are today installed and building in this country alone at least 300,000 horsepower in large units. The committee in its report holds the opinion that this enormous investment indicates an assurance on the part of the operator that the gas engine is a reliable prime mover. "Large engines have been used long enough to demonstrate that continuous service is assured and that the design today is well enough established to convert commercial gases, practically of all kinds, into power by the selection of the best types and arrangements to suit the individual installation. The mechanical features have been, from time to time, materially simplified, and continuous operation can be expected with no more attention than that given to steam engines of equal capacity."

It is recommended by the committee that the capacity rating for gas engines should be standardized and expressed in a manner that will give some definite relation as to the actual power produced. This might be expressed in piston displacement or in some convenient form of measuring the maximum power developed under prescribed conditions. The rated capacity should bear an approximately fixed ratio to the maximum capacity, which should determine the uniform percentage of overload. This standard rating should be based on the character of the gas to be used, as the capacity of the engine depends upon the character and the thermal value of the gas used.

The most important part of any committee report is the set of recommendations or conclusions. The conclusions of this committee asking for a standardizing of the rating of engines should not be tabled. Those within whose province it is to handle these matters will render the electric railway industry a great service by furthering the work of formulating rules for the standard rating of gas engines.

---

#### PAINTING POLES NEAR SWITCHES.

To the Editors:

In reading the issue of the Electric Railway Review for May 16 we are somewhat interested in the editorial regarding painting trolley poles near switches, on page 587, and, although the scheme outlined in your article is apparently a very good one, we have one here in the east that can beat it as to practicability and slight expense for maintenance. The scheme is as follows:

Start about five poles away from the switch or sharp curve or any point on the road where it is desired to call the motorman's attention to the fact that care or caution should be exercised, and put a narrow circular stripe around the pole on a level with the motorman's eye. Stripes should be at an angle similar to the marking of a barber pole. For



### DOUBLE-FLOW STEAM TURBINES OF THE PITTSBURG RAILWAYS COMPANY.

The initial installation of any new and important type of machinery always possesses peculiar interest to those concerned in the progress of the art. And for this reason a

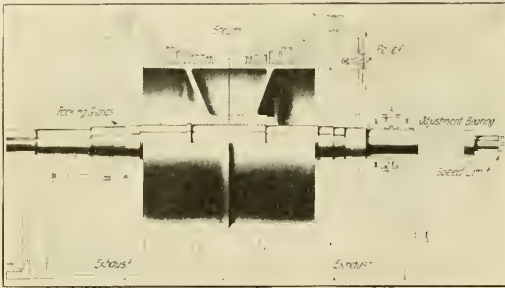

Westinghouse Double-Flow Turbines—Figure 1.

description of recent extensions at the Brunot island power plant, incorporating the new Westinghouse double-flow turbine, will be of interest.

The Brunot island station not only serves most of the rail-

erected parallel with the present boiler plant, and will contain six 400-horsepower Babcock & Wilcox water tube boilers, all equipped with Westinghouse new model Roney mechanical stokers. The boilers will be arranged in pairs, discharging into eight independent stacks 7 feet internal diameter and 250 feet high.

An interesting feature in the Brunot island plant is the fact that turbines driving 11,000-volt three-phase alternators are in electrical parallel with two-phase 6,600-volt engine-driven units. The turbine equipment consists of one 3,000-kilowatt and three 5,000-kilowatt double-flow units. The smaller unit has been in successful operation nearly one year; the larger units are in course of erection. Each turbine is connected by a short and direct exhaust duct to an Alberger condenser of the "centrifugal jet" type.

Each unit rests upon reinforced concrete plates supported entirely by six reinforced concrete columns, thus giving ample space around the condenser, which could have been placed entirely within the turbine foundations had this been necessary. The concrete employed to construct a foundation for one of the 1,500-kilowatt cross-compound engine units would be sufficient to build the four foundations required by the 18,000-kilowatt capacity double-flow turbines.

#### Double-Flow Turbines.

The most interesting feature of this plant is the double-flow turbine installation. The following description deals with these particular machines in considerable detail, inasmuch as

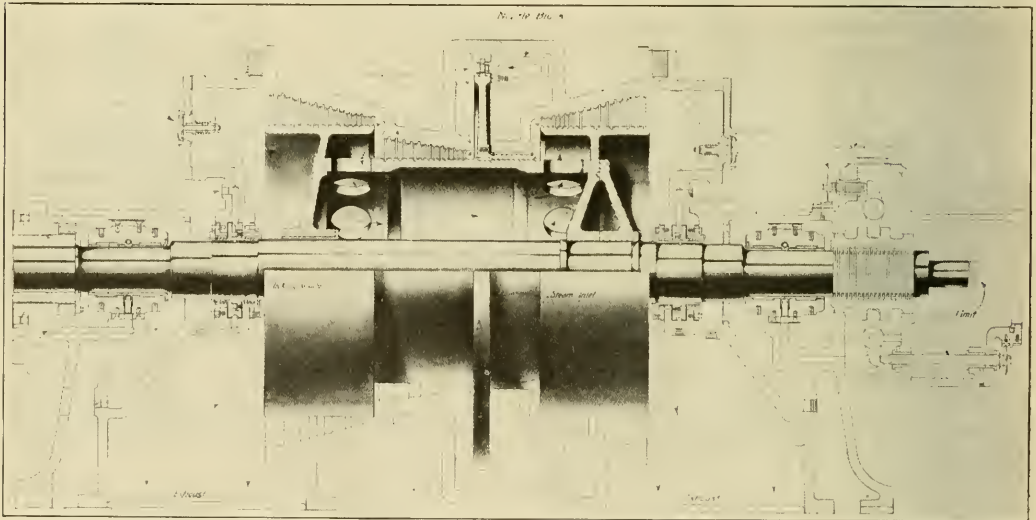

Westinghouse Double-Flow Turbines—Figure 2—Showing Arrangement of Actual Unit with Impulse Blades.

way system in Pittsburg and Allegheny, but also a large part of the lighting for the same territory. And owing to the extraordinary increase in the demand for power, it was found necessary to increase the plant capacity considerably beyond original estimates. In the present building, room had already been provided for three additional 1,500-kilowatt cross-compound condensing engines, but as the necessary extension far exceeded these provisions, steam turbines were adopted, with the result that instead of 4,500 kilowatts, a total of 18,000 kilowatts capacity has been installed, with still sufficient room for an additional turbine. In other words, the space originally provided for 4,500 kilowatts in engine-driven machinery accommodates 23,000 kilowatts.

For this large extension a new boiler house is being

this turbine has not been described to any extent by the technical press:

The double-flow principle, as embodied in these large machines, is essentially a modern development brought about entirely by consideration of mechanical construction. It is not by any means unprecedented—in fact, the original Parsons turbine, constructed in 1880, was of the simple double-flow type. In modern hydraulic work, the double-flow principle is very largely employed to produce a rotor running in perfect axial equilibrium. In small machines, however, the advantages of the double-flow principle are not as pre-eminent as in the large, principally because of the absence of the necessity therefor from a mechanical standpoint, and by reason of the fact that the economy of two small machines is not likely to



be as good as one of twice the capacity. In turbines of very large size, however, where proportions exist more favorable to the attainment of high economy, the latter advantage does not obtain.

The double-flow turbine may thus be regarded as the result of an insistent demand for turbine-generating units of

illustration that since the two elements are identical, and the steam flows through them in opposite directions, the axial thrust of the steam on the blades, due to the difference of pressure between the inlet and outlet of each element, will be exactly the same in both sections. Therefore, perfect steam balance under all conditions of pressure, vacuum and load, is

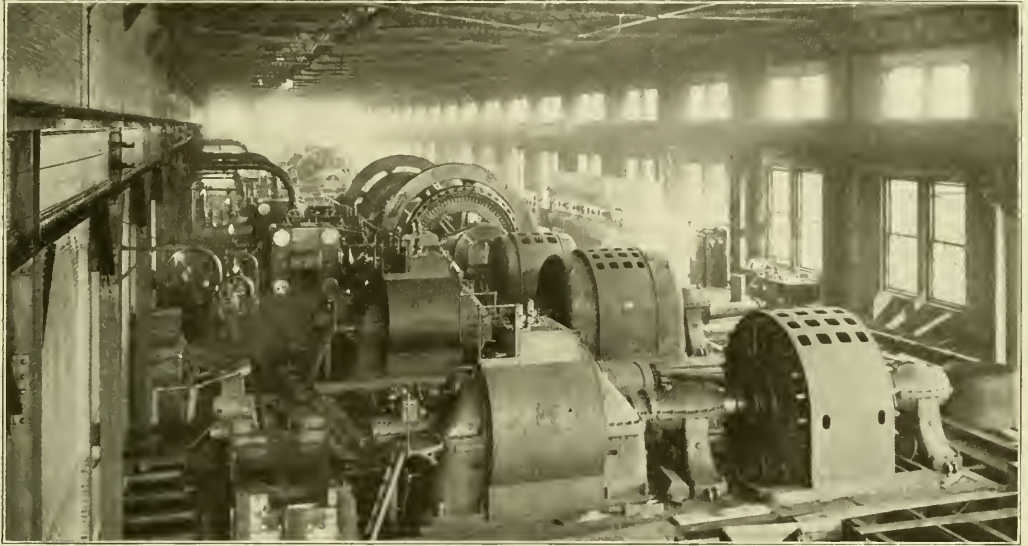

Westinghouse Double-Flow Turbines—Interior of Brunot Island Station of the Pittsburg Railways Company, Showing Turbines During Erection.

larger capacity at high speeds. For the large machines, the advantages of the combined impulse and reaction principle of steam expansion, together with the double-flow construction, are so important that the practical result, as embodied in the machine under description, is most fortunate. The Parsons and the double-flow type are practically upon the same basis

obtained without the use of dummy or balance pistons. As these low-pressure turbines are designed to utilize all the exhaust steam from a non-condensing reciprocating engine, it is possible to tie the engine and turbine together electrically, thus making the use of a governor on the low-pressure turbine unnecessary. With the exception that, as mentioned, the gov-

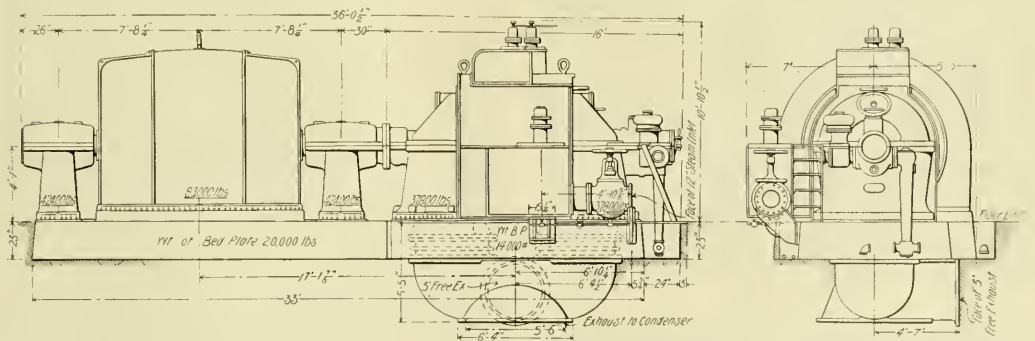

Westinghouse Double-Flow Turbines—Side and End Elevation of Turbine for Brunot Island Power Station.

as regards economy. The advantages of the double-flow construction will probably be most clearly understood by first considering the low pressure double-flow turbine shown in Figure 1. Here we have a turbine of the simplest possible construction, consisting entirely of two identical Parsons turbines placed end to end, taking steam at the center and exhausting at both ends. It will be evident by an examination of the

error may often be omitted from the low-pressure turbine, it is practically identical with the high-pressure double-flow turbine. In fact, the high-pressure machine is directly evolved from the low pressure by the simple addition of a high-pressure impulse element mounted at the center of the rotor, this simple element serving in a capacity closely analogous to the high-pressure cylinder of a triple-expansion reciprocating

engine. Figure 2 represents the final step in the evolution of the present complete high-pressure machine.

Steam enters the turbine through a flanged opening in the lower half of the casing, from which it is piped directly to nozzle blocks. For convenience in illustrating the nozzle block is shown at the top, whereas it may be located at any point in the periphery nearest the inlet. Expanding in suitable nozzles, the steam impinges upon the impulse blades, enters the impulse wheel chamber, and is distributed evenly around the casing so as to enter the intermediate Parsons section of the turbine around the entire periphery of the rotor. As in the single-flow turbine, the steam then divides along two separate paths, one-half entering the left-hand section of low-pressure blading, the other passing through the interior of the rotor shell, which forms the connecting passage to the remaining low-pressure section of blading at the right-hand end of the turbine. Discharging from the last rows of low-pressure blading, the steam passes into the exhaust connections and to the condenser in the normal manner.

As the same pressure exists on both sides of the impulse wheel disc, this is not subjected to any end thrust and requires no balancing. The difference of pressure between the inlet and outlet of the intermediate section is accurately balanced by a dummy piston of moderate dimensions, located between the impulse wheel and the right-hand low-pressure section. And since the thrusts in the low-pressure sections are in opposite directions and therefore balanced, the entire turbine runs in equilibrium under all conditions of vacuum, pressure and load. It is, of course, necessary to provide means for accurately fixing the axial position of the rotor, and for this purpose an adjustment bearing on the right hand of the shaft is, as usual, fitted. It consists of a number of collars turned in the shaft, into which fit corresponding brass rings fixed in the adjustment blocks. The upper and lower halves of the adjustment bearing may be moved by means of micrometer screws, as shown, thus permitting the axial position of the rotor to be accurately known at all times.

#### Rotor.

Referring again to Figure 2 it will be seen that the rotor consists of five cast-steel members mounted on a through shaft. The shaft carries its load at one-third distance from the points of support, thus permitting a lighter shaft than required for distributed loading and practically eliminating the possibility of deflection. These are firmly pressed on the shaft and locked to prevent movement. To the opposite end of the rotor is fitted a bronze bushing surrounding the shaft, permitting it to move axially without appreciable resistance under any differential expansion of shaft and rotor body.

The impulse element consists of a flanged cast-steel disc forced on to the rotor body with a pressed fit and securely keyed. The flange at the base is grooved and forms the dummy or balance piston for the intermediate Parsons section. The nozzle block is an independent casting, separate from the turbine cylinder. Receiving steam from the governor valve, this restricts high pressure and high temperature to a comparatively small casting which is free to expand and contract with changes of temperature and may easily be designed with ample strength.

#### Parsons Element.

Except for the division of the low-pressure section, this part of the turbine is identical with the single-flow construction, consisting of a series of rows of moving and stationary blades, increasing in height to allow for the increased volume of the steam. In the Parsons section, it will be recalled the velocities from stage to stage remain practically constant. The blades are inserted in grooves cut in the spindle and cylinder body, and are securely held in place by calking the soft spacers, or distance pieces inserted in the grooves between the blades. The diameters of the low-pressure section are chosen so as to permit the same size blades being used

in both intermediate and low-pressure sections, thus simplifying the blading considerably.

#### Governing.

Essentially the same system of governing is used in the double-flow as has become familiar in the single-flow design; namely, the "puff" or "gust" system, comprising a constant number of admissions per minute with a variable duration of admission according to the load. This refinement of the purely throttling method is distinctly different from the principle of governing by adding nozzle after nozzle, all at maximum pressure, as the load increases. The type of governor controlling the double-flow turbine is of the sensitive fly-ball type, differing only in minor details from the standard governor for single-flow machines. Its most important feature is that all parts are kept constantly in motion so as to avoid "friction of rest" and prevent sluggish action, which would otherwise ensue after running a considerable period at constant load. A small relay steam piston does the actual work of moving the turbine valves, thus relieving the governor of practically all work except moving a small pilot valve. For convenience in synchronizing and in distribution of alternating-current load, the governor is fitted with a small motor and weight, by which the governor spring tension may be controlled from a distance—usually from the switchboard.

#### PLATFORM GATE FOR PAY-AS-YOU-ENTER CARS.

Harry M. Sloan, general manager of the Calumet Electric Street Railway of Chicago, has applied for patents on two forms of gate for use in connection with the pay-as-you-enter method of fare collection which are designed to facilitate the operation of the pay-as-you-enter system and to prevent platform accidents.

The first form, which is illustrated in the accompanying drawing, consists of a pair of gates, opening outward and

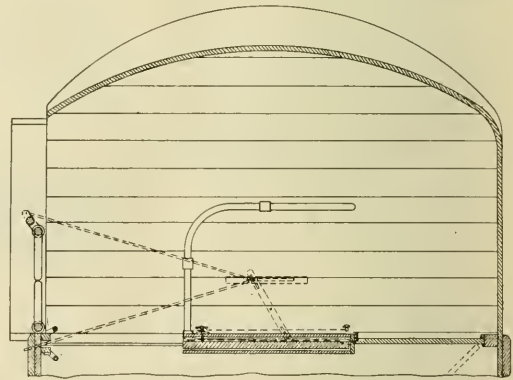

Double Platform Gate for Pay-As-You-Enter Car.

closing the exit side of the platform step, which may be operated either by a foot crank or by a lever. This gate could be readily adopted for use on the present type of pay-as-you-enter car used in Chicago, New York and Buffalo. The object of the gate is to direct passengers boarding the car to the entrance side of the platform and, as the gate will be closed until the car stops, to prevent passengers, especially ladies, from getting off before the car comes to a stop.

Mr. Sloan has also applied for a patent on a single gate, opening inward and closing the platform exit. This would serve the same purpose as the double gate as regards passengers boarding or leaving the car and when opened would completely separate the entrance and exit sides of the platform.

### TOLEDO MEETING OF THE CENTRAL ELECTRIC RAILWAY ASSOCIATION.

The regular bi-monthly meeting of the Central Electric Railway Association was held at the Boody house, Toledo, O., on Tuesday of this week. President F. D. Carpenter presided and about 75 members were in attendance.

#### Committee on Rules.

After reading the minutes of the March meeting the committee on "Uniform Rules" was called on for a report. The committee reported that it had drafted a set of rules which met with the approval of the Indiana railroad commission and that copies of these rules had been sent to all electric roads in Indiana for their criticisms. At some later date a conference with the railroad commissioners will be held, at which the criticisms received will be considered and final action taken on the adoption of the rules as standard. The report was received and the committee continued.

#### Committee on Claims.

The committee on "Claims" appointed at the March meeting made the following recommendations, which were adopted by the association:

That cards be printed, for the use of the various companies, showing the name, residence and a short personal description of each claimant, together with the name of his attorney and attending physician; where the amount of the claim is \$100 or over and in other cases if there should be any reason to think that they should be reported; the claim departments of the various companies to forward these cards to the secretary of the Central Electric Railway Association, to be kept on file in his office, in this way having a complete record of all the important claimants against all of the companies of the association.

When a claim is made against any company about which information is desired, the company against which the claim is made will at once communicate with the secretary of the Central Electric Railway Association, asking for information regarding the particular claimant. If there is any record of the claimant on file, then the secretary will immediately notify the inquiring company of whom to make additional inquiry for specific information.

In filing reports of cases, should the secretary find that he has more than one report upon a particular person with the same or similar name, even though inquiry has not been made regarding this person, he will immediately notify each company making report upon the same person, thus giving each company that has any record regarding the claimant the benefit of the information that he has a claim against whatever companies have reported. This will, in effect, make the secretary's office a clearing house for information regarding claimants, and the more complete his records can be made the more benefit it will be for all parties concerned.

We further recommend that this plan be enlarged upon by permitting other companies that may desire, which are not members of the Central Electric Railway Association, to become associate members for the purpose of reporting and securing information regarding claims and claimants. A small fee should be paid by the associate members to cover express incident to this work.

We would further recommend that the claim department of each company, as soon as possible, make report to the secretary upon cards to be furnished by him of all claimants since January 1, 1907, and that the secretary be instructed to provide a sufficient number of cards and filing cases for this purpose.

#### Committee on Interchangeable Mileage Books.

The committee appointed to report on a new form of interchangeable coupon mileage book presented a form of contract covering the settlement between roads and the conditions of sale and use of a new book containing 1,000 miles of coupons to be sold at \$17.50 or 1 $\frac{3}{4}$  cents per mile. The territory of the association now includes 8,800 miles of inter-urban roads, which if they subscribe to the contract presented would honor the book on any regular passenger car. The new book will be good for bearer or bearer and party. It will be limited to one year from date of sale. All detachments of coupons will be subject to local regulations of the road on which used as well as all local bridge and terminal arbitrations.

No detachment will be made for less than five miles or for half-fare tickets. No portion of the mileage strip will be honored if detached from the cover. If baggage is checked for more than one person no more baggage will be checked until the passage coupons with baggage strip detached are all used up. Redemption of the unused portion of the ticket will be made on the basis of two cents per mile for the part used. When two or more persons ride on one ticket the conductor will detach one strip for the total mileage and indorse on the back thereof the place from and to and the number of passengers.

The association adopted the recommendation of the committee for the issuance of the new book to take the place of the old Central Electric mileage book and continued the committee with instructions to co-operate with the chairman of the Traffic Association in deciding on the details of the style and color of mileage strip and cover to be used.

#### Insulation of High-Tension Transmission Lines.

A paper on "Insulation of High-Tension Transmission Lines," by Francis S. Denneen of the Ohio Brass Company, Mansfield, O., was read by abstract. This paper will be found elsewhere in this issue.

G. H. Kelsay (Indiana Union Traction Company) asked Mr. Denneen if he would specify the same insulator where iron pins, crossarms or poles are used as for wood pins and poles. He had had some trouble with porcelain insulators puncturing under the wire and discharge through the core to the pin. With wood pins this discharge continues until the pin, the crossarm or the pole is burned away, thus showing up the defect to an inspector. He asked if a puncture occurred with a metal pin what visible evidence of failure might be expected.

Mr. Denneen replied that punctures with porcelain insulators were rare failures and that with iron pins the discharge would probably be so heavy that the heat generated would burst the insulator or at least crack off a piece large enough to be detected. The usual result of a heavy discharge is to run down the outside and shatter the insulator. He explained the cause of punctures by stating that the dielectric material, of which the insulator was composed, had a certain resistance to sudden rises of potential or, in other words, a capacity to resist blows. Its resistance to slower rises of potential was much greater. When the wave of current had a sharp peak the dielectric could not adjust itself quick enough to prevent breakdown but when the rise of potential was slow failure occurred by flashing over.

A member called attention to the fact that while with Y connections and grounded neutrals the failure of one insulator would cause heavy discharge to ground, with delta connections the failure of one insulator would not result in a ground but only in increasing the static discharge from insulators of the other two wires.

#### Afternoon Session—Merit System of Discipline.

The first paper of the afternoon session was on "The Merit System of Discipline," by Frank Hardy, division superintendent Ft. Wayne & Wabash Valley Traction Company, Huntington, Ind. An abstract of this paper will be found in another column.

L. K. Burge, superintendent Lake Shore Electric, asked how much time was required to keep up employees' records in the complete form outlined in the paper.

Mr. Hardy replied that while it required some additional clerical work and the time of the officers sitting on the merit board, the results more than justified the expenditure of time and money. The work of the board has been systematized and no time is spent in discussions of hypothetical cases. The board considers only statements of facts and its records are kept by a simple code indicating the nature of the offense or meritorious act and the number of points awarded. Meetings of the board seldom last over two hours and the minutes

are recorded in full by a stenographer who acts as secretary. About 250 employes are now working under the system. When a case is presented against an employe he does not appear before the board in person; appeals from the decisions of the board are made in writing and all communications are submitted in writing to be made part of the record of the case.

W. R. W. Griffin, general superintendent Rochester (N. Y.) Railway Company, described the working of the merit system on his road which employs 1,100 men, all members of the union. The system has been in effect more than three years and in that time a very complete schedule of specific penalties for specific acts has been worked up. All reports of infractions of the rules are made to the superintendent of transportation who passes on them and determines the number of demerits. A letter is sent to the employe who has been given demerits and he is required to acknowledge receipt of it on an acknowledgment stub attached. He is allowed 10 days in which to file notice of appeal in writing. If an appeal is filed the company makes a complete investigation of all of the facts, and sustains or rejects the appeal on the evidence. All cases of appeals are handled through the business agent of the union and not directly with employes. Only cases involving discharge as a penalty are ever carried beyond the superintendent of transportation to the general superintendent and notice of discharge is sent through the executive board of the union. All records are kept in minute detail and every paper having any bearing on a case is entered in the file covering the record of the employe involved. For these files large envelopes in vertical filing cases are used. An abstract of all records is also kept in a loose leaf ledger. At the end of each month a bulletin is posted giving the number and causes of all merits and demerits earned during that month but without details which would identify any employe. At the end of every six months all accounts are balanced. If not more than five demerits have been charged against him in that time the employe is given a clean record, which carries with it 15 merit marks, cancelling as many demerits which may have been carried over from the previous six months. A total of 60 demerits is cause for discharge. Some of the older employes now have as high as 250 merits to their credit. The men watch their records closely and apparently make an earnest effort to have a clean record. No money prizes are given for good records. The schedule of penalties has been printed in pamphlet form, to be pasted in the men's rule books so that they have before them a constant reminder of the result of disobedience. The system of keeping the records requires the services of one clerk and an assistant but there is a decided saving in the time of the officers of the company, who are never involved in the settlement of disputes.

Mr. Hardy said that when the system was introduced on the Ft. Wayne & Wabash Valley the men did not seem to take much interest in it for the first two or three months, but after a few demerit marks had been given they began to evince a keen interest, and now every man asks to examine his record on an average of about every three weeks. The essential thing to remember in putting such a system into effect is that the officers must be constantly on the lookout not only for violations of the rules but for meritorious acts as well.

#### Standardization Committee.

The "Standardization" committee held a meeting at Toledo on May 26, at which were present R. C. Taylor, Fred Heckler, M. Baxter; and absent Mr. Gibbs, Mr. Townsend and Mr. Clark. It was the opinion of the members present that this committee should be enlarged, as it has been difficult in the past to get a majority of the committee together and in consequence the work of the committee during the current year has not been as effective as it should have been. The committee therefore suggested that the following members be added: Ira Schofield, Toledo & Western Railway;

W. C. Ralston, Cleveland Southwestern & Columbus Railway; Lee Jacques, Ft. Wayne & Wabash Valley Traction Company; H. D. Murdock, Indianapolis & Louisville Traction Company.

In order to facilitate the work of this committee it was further decided to hold regular meetings on the third Wednesday of each month alternately at the nearest accessible location to the cities at which the various members of the committee are located.

It is urged on the managers to see that their subordinates interested in this work attend every one of these meetings, as the work accomplished in the past and the still greater work to do is of sufficient importance to warrant the most earnest and persistent work on the part of all the members of the committee.

It was further decided by the members of the committee present that the next subjects for consideration and recommendation should be:

- (a) Standard height of drawbar for interurban cars.
- (b) Standard form of car coupler.

These two subjects require also the settlement of standard height of car floor and standard height of bumper.

The committee has in its possession and has examined drawings submitted by the McConway & Torley Company, Pittsburg; W. T. Van Dorn Company, Chicago; the Ohio Brass Company and the Edwin C. Washburn Company, Minneapolis.

There is also a modification of the M. C. B. coupler being developed by Mr. Gibbs, one of the members of the committee, and it has been decided before making definite recommendations as to a standard form of car coupler for interurban cars to issue a data sheet to the members of the association to be filled in and sent to the committee. It is hoped that a ready and prompt response will be made to these inquiries. When this information has been received and tabulated an opportunity will be given the manufacturers to present the merits of their couplers to the committee. It is the wish of the members of the committee present to solicit the hearty cooperation of the members of the association in its work, which is of such far-reaching importance to the association.

The report of the committee was received and approved, the president announcing that he would formally appoint the new members suggested. In commenting on the work before the "Standardization" committee, President Carpenter laid particular stress on the need of standardization of those parts and dimensions affecting interchange of equipment. He pointed out that the steam roads had standardized their equipment to such an extent that a car of one road could be run over any other road and he thought it was only a question of a short time before the interurban lines would have to arrange to haul through passengers in trailers which could be turned over from one road to another at connecting points.

The papers by John F. Ohmer, president of the Ohmer Fare Register Company, Dayton, O., on "Tickets as a Fare Medium for Street and Interurban Railway Traffic," and by H. E. Vordermark, auditor of the Ft. Wayne & Wabash Valley Traction Company of Ft. Wayne, Ind., on "Employees' Mutual Benefit Association," were read but not discussed. Abstracts of both are printed in another column.

It was announced that the following roads had subscribed to the agreement of the Central Electric Traffic Association, effective on June 1: Western Ohio Railway, Columbus Delaware & Marion Railway, Columbus Marion & Bucyrus Railway, Indiana Union Traction Company, Chicago South Bend & Northern Indiana Railway, Ft. Wayne & Wabash Valley Traction Company, Ft. Wayne & Springfield Railway.

The following new members were elected: Charles H. Hubbell, acting auditor Toledo & Chicago Interurban Railway Company; A. J. Purinton, general manager Toledo & Chicago Interurban Railway Company; George S. Henry, traffic manager Indianapolis & Cincinnati Traction Company; G. F. Faber, general superintendent Western Ohio Railway Company; W. K.

Morley, general manager Grand Rapids Grand Haven & Muskegon Railway Company; E. B. Lincoln, general manager Muncie & Portland Traction Company; Stanley W. Midgeley, Curtain Supply Company, Chicago; Charles E. Sawtelle, Tool Steel Motor Gear & Pinion Company, Cincinnati, O.; T. J. Hayden, Rand-McNally Company, Chicago; A. E. Dunclose, Massachusetts Chemical Company, Chicago.

The next meeting will be held in Indianapolis on September 21.

#### EMPLOYEES' MUTUAL BENEFIT ASSOCIATION OF THE FT. WAYNE & WABASH VALLEY TRACTION COMPANY.\*

BY H. E. VORDERMARK, AUDITOR.

The idea of a relief department or a mutual benefit association among employes is not a new one, as such organizations have been in existence for a score or more of years on various railway systems, particularly the Pennsylvania and the Baltimore & Ohio.

Their first organization was induced by the necessity of some relief for the unfortunate employe whose ability to earn his usual wages had been temporarily interfered with because of accident or illness. The old and still much used method of providing such relief by "passing around the hat" is not only embarrassing to the employe for whom the solicitation is made, but a very great burden upon his friends, who feel from sheer necessity the call to take upon themselves the burden of collecting funds for the need of their sick friend and those dependent upon him. Not only does the burden of taking up a collection for the relief of those needing it fall upon their friends, but the more or less frequent contributions are gathered from the few who are charitably inclined, so that the tendency is to cause them to have to decline the aid from time to time that they would like to give, with the result that this method of providing relief becomes more and more of a failure and the one in need actually suffers.

Having observed for nine years the beneficial advantages of the relief department of the Pennsylvania Railroad, and being convinced as to its practicability and usefulness, the general manager of the Ft. Wayne & Wabash Valley Traction Company introduced the subject at one of the meetings of its Officers' Association, the result being that a committee of three of the Officers' Association, of which the writer was chairman, was appointed to study the various forms of relief departments and benefit associations in operation not only on steam railroad properties, but also on electric properties, and to formulate recommendations looking to the establishment of such an association on the lines of the Ft. Wayne & Wabash Valley Traction Company.

The committee collected data from every street railway company in the United States and Canada who had an organization of this kind among their employes, also from the Pennsylvania Railroad and the Baltimore & Ohio Railroad. We found a great variation, not only in monthly dues to be paid and benefits to be derived, but also as to the method of collecting dues and management of the association. The result of the study of this committee was to unanimously recommend such an organization, and in order to start it a charter paper was gotten up, as follows:

"Whereas, the employes of the Ft. Wayne & Wabash Valley Traction Company are about to organize an Employees' Mutual Benefit Association, the object of which shall be the relief of its members in case of sickness, injury or disability, and in case of death the payment of definite amounts to beneficiaries and also to promote social relations and good-fellowship among its members; and

"Whereas, the Ft. Wayne & Wabash Valley Traction Company, to further the interests of said Employees' Mutual Benefit Association, has set aside the sum of \$ . . . . . as voluntary contributions toward this cause, and does propose to further aid the same from time to time as it may become necessary, and also further proposes to have its officers and accountants devote such time, at the expense of the company, as may be necessary to conduct the business of said Employees' Mutual Benefit Association without further expense to the association; and

"Whereas, it is proposed that prior to a definite organization a full list of 200 employes shall have subscribed to the constitution and agreements attached hereto and thereby become charter members of this organization;

"Therefore, we, the undersigned officers and employes of the Ft. Wayne & Wabash Valley Traction Company, hereby

\*Paper read before the Central Electric Railway Association at Toledo, O., May 26, 1908.

subscribe our several individual names, as charter members, for the purpose of organizing the Employees' Mutual Benefit Association of the Ft. Wayne & Wabash Valley Traction Company, and upon the signature of 200 of such officers and employes to have it understood and known that we are thereafter organized as members of the Employees' Mutual Benefit Association of the Ft. Wayne & Wabash Valley Traction Company, and agree to abide by the constitution and by-laws appended hereto and made part of this proposal."

This paper was started for signature among the employes about June 1, 1907, and the date of October 1 was fixed for the time of closing the charter paper and starting the association. At this time 340 names had been signed to the charter paper and the association thus fairly launched.

The management of the affairs of the association was vested in a board of trustees, which consisted of a chairman and six members. The president of the association shall be chairman of the board of trustees and appoint three members of the board from the Officers' Association of the Ft. Wayne & Wabash Valley Traction Company. The other three members of the board are chosen annually in the month of November, by ballot, to serve one year from the first day of January next succeeding, and are elected from the members of the relief association.

The general manager of the company is ex-officio president of the association, and our present board consists of a conductor representing the Ft. Wayne city division, a motorman representing the interurban division and a motorman representing the Lafayette division in addition to the general manager and three members of the Officers' Association. It is proposed to increase this board to 11, giving additional departments additional representation on the board.

After a great deal of study on the part of the committee in reference to dues and benefits, it was deemed advisable to be conservative in this respect, the result being the dues were fixed at 50 cents per month, with benefits of 75 cents for each day, when disabled by accident, limiting the period of disablement to 120 days in any one year, and 50 cents for each day when disabled by sickness, after the first seven days, and for a period not exceeding 120 days in any one year, a payment of \$100 to person or persons designated in application for membership to receive the same, in case of death. These dues are paid in advance and are deducted from the last pay check of each month, so that there is not the embarrassment or trouble of making collections from the men, as is usual in such cases.

The membership is limited to employes of the Ft. Wayne & Wabash Valley Traction Company over 16 years of age and under 45 years of age, both inclusive, who shall have been in the service of said company for at least one month.

The entire management of the association is in the hands of the board of trustees, which meets regularly on the second Monday of each month, and whose officers are a president, vice-president, treasurer and secretary.

No meetings of the members of the association itself are deemed advisable, on account of the membership being so widely scattered along the lines of the Ft. Wayne & Wabash Valley Traction Company, over 200 miles in extent, and not only being impracticable, but such meetings were deemed inadvisable.

It is the intention of the company that every cent that is paid into the association on account of dues shall be expended on account of relief in sick, accident and death benefits, so there are no charges made against the association for clerical services, printing and supplies, or wages of men who have been relieved to attend meetings of the trustees.

In addition to this relief work, and in connection with the association, reading, card and pool rooms have been established at division points—at Ft. Wayne, Huntington, Logansport and Lafayette—to which rooms all of the members of the association are cordially invited and welcomed, and which are always occupied and seemingly appreciated.

In addition to monthly magazines, which are subscribed for by the company, a library has been started, which at the present time consists of about 260 volumes.

The association having been started October last has been in effect but about eight months and its membership has increased from 340 to 500 members, and the association has paid out in the eight months of operation about \$900 for sick, accident and death benefits.

We are pleased to submit for your consideration some forms of blanks which are in use in connection with this association as follows: Preliminary notice of application for membership; application for membership; notice of rejection; notice of election to membership; member's certificate book, containing constitution and by-laws of the association; preliminary notice of disablement; disablement notice; certificate of attending physician; return to duty card; data for death benefit; release on account of death benefit.

## INSULATION OF HIGH-TENSION TRANSMISSION LINES.\*

BY FRANCIS S. DENNEEN, OHIO BRASS COMPANY.

The general problem of high-tension line insulation is too broad and complex to permit a thorough and exhaustive treatment within the limited scope of this discussion. The effort, therefore, will be to touch on those points of particular moment in the selection of line insulators, and to discuss briefly the performance of insulators in service and the elements to be considered in the design.

About 18 years ago the first alternating-current power transmission line in the United States was put in operation, the voltage being 3,000, and a small glass insulator about three inches in diameter and 4 inches high, made along the lines of the present standard type deep-groove telegraph insulator, served for carrying the wires. At the time much comment was made by engineers, who stated that the line could not possibly operate with this insulation. However, it continued in successful service for more than six years with practically no insulator troubles. During the ensuing six or seven years, line voltages were gradually increased, and in 1897 we had transmissions in the United States operating at 16,000 volts, and up to this time glass was used almost exclusively for the insulation. Some porcelain insulators were used, but these were made by the so-called dry process, in which the clay, but slightly moistened, is pressed to shape in iron or steel moulds, after which it is glazed and subjected to the firing process. These insulators gave trouble because they punctured quite readily, and it was then realized that the major part of the insulation was being offered by the glaze, the body portion having comparatively small insulating value on the higher voltages.

Investigation showed that this early porcelain was porous and would absorb moisture very rapidly at points where the glaze was removed. A close study of the subject disclosed the fact that the body was not sufficiently dense and vitrified. The pieces were then made by the "wet process," which will be described briefly hereafter. By this method of manufacture and with the proper mix of the materials making up the porcelain body, it was possible to produce porcelain of great mechanical and electrical strength, the body being dense and homogeneous and highly vitrified. As the operating voltages increased, it was found necessary to make the insulators with two or more shells glazed or cemented together, in order to keep the thickness of the parts within limits which would permit making the body sufficiently dense and at the same time prevent excessive manufacturing losses from cracking and other causes. With the increasing line voltages numerous designs, more or less complicated, were introduced and tried out, but most of these early types have been entirely discarded and replaced by simpler ones, designed to meet the operating requirements and yet in such a way as to permit economical manufacture.

At the present time glass and porcelain are the only materials used commercially for the insulation of high-tension lines, and the former is fast becoming limited to use on lines where the pressure does not exceed 10,000 to 15,000 volts. In the earlier years of electric power transmission, the difficulty and expense of manufacturing porcelain of the requisite electrical strength caused glass to be used almost exclusively. The great improvement in the methods of porcelain manufacture for this work, however, has entirely changed the situation, and today very few engineers are willing to risk using glass at voltages above the limits just named.

Perhaps the greatest advantage offered by porcelain is its mechanical strength. These porcelain pieces are made so that they are not under any internal stresses, and a shell of moderate weight will stand a great deal of abuse without breaking. In order to get a fairly clear idea of the nature of the porcelain which is used for high-tension insulator work, it might be well at this point to give a brief description of the various processes involved in the manufacture of this ware.

**Manufacture of Porcelain Insulators.**

The exact composition of the porcelain body is closely guarded by the manufacturers, but in general it consists of special clays with feldspar and ground flint in proportions which have been determined by experiment to give the most satisfactory results. This mixture is ground very fine in the presence of water to obtain a thorough mixture, after which the excess water is removed by means of filter presses. The "clay," as it is called, is then worked in kneading machinery until a uniformly plastic mass is obtained. By means of a large press the clay is forced into a continuous cylindrical piece about 6 inches in diameter. This piece is cut up into

suitable lengths and stored until needed.

The moist clay is placed in a revolvable mold, which forms the outer surface of the piece, and the inner contour is given by a steel knife or profile, as it is called, attached to the lever used in forcing the clay into the mold as it revolves. The molds are made from plaster of paris, and as soon as the piece has been formed the mold containing it is removed from the revolving table and placed in the "hot room," where it is kept at about 125 degrees F. for several hours. The porous plaster mold rapidly absorbs the moisture from the formed piece of clay, and the clay at the same time shrinks very rapidly, this shrinkage being such that the mold has to be about 15 per cent larger than the finished article desired. After the piece has dried a few hours, it is removed from the mold and placed in a drying rack, where it remains for several days, until all moisture has been dried out. The piece is then dipped in a liquid glaze, after which it is placed in the kiln to be burned. The surfaces upon which the pieces rest in burning are left unglazed, for otherwise these surfaces would stick to the surface supporting them during the burning process. On being removed from the kiln, the pieces are carefully inspected for mechanical defects of any sort, and any having checks or cracks or showing mechanical defects in any way affecting the insulator are thrown out. All parts are then subjected to a severe electrical test. If the insulators are single-piece, this test may be more than twice the rated line voltage.

Pieces from various parts of the kiln are broken and carefully tested for absorption. This is to insure against the possibility of any ware going out which is not thoroughly vitrified. The final check on this, of course, is the electrical test given later. The parts which have passed inspection and electrical test are then assembled with the best obtainable grade of neat Portland cement, and the assembled insulator is allowed to set undisturbed for several days. The insulators are once more placed in the testing racks, and subjected to an assembled test voltage of at least double the rated line voltage, and this serves as a final check on the electrical value of the insulator. The insulators are then sent to the storerooms, or shipping rooms, and every one is subjected to a final inspection for mechanical defects before it is packed.

The glaze of a porcelain insulator is a very important feature, not because it is depended upon for actual insulation, but because it serves to give the porcelain body a surface which will be non-hygroscopic and absolutely smooth, so as not to retain dust or moisture readily. White glaze was first used for porcelain insulators, but it was found that these were too attractive as targets for the hunter and the small boy, and a dark brown has now become standard with most users.

**Action of an Insulator Under Stress.**

Before discussing the theory of insulator design and the performance of an insulator in service, it would be well to devote a few moments to a brief study of the action of an insulator or dielectric when subject to electrical stress. The study must not be limited to the insulator alone, for it should involve a consideration of all of the effects of electrical tension upon the dielectric near the conductors. With an insulator, air is always a dielectric in combination with glass or porcelain or other insulating materials. When a difference of electrical potential exists, a condition of strain is produced in the surrounding media and this is called the electrostatic field. This electrostatic field is produced by applying electrical stress to the insulating medium. When subject to electrical tension all dielectrics, including air, glass, porcelain, wood, etc., have produced in them a displacement in the molecular structure which, if the applied potential is carried to a sufficiently high value, results in a disruptive breakdown of the material. Before a difference of potential can exist, current must flow into the dielectric, and if the potential is not raised to a value which will cause rupture, current will flow from the dielectric whenever the tension is reduced or removed, and a path formed for this current to flow in.

All dielectrics are capable of receiving strain to a certain point without rupture, and solids such as glass and porcelain possess this feature to a greater extent than air or gases. Generally, whenever the potential is brought to a sufficiently high value, there is a structural failure of the dielectric, solids failing by mechanical rupture and gases by a change in the molecular state, which partially destroys their insulating qualities and makes them semi-conducting. An insulator under heavy load may show brush discharge, which is an indication that while the insulator remains intact, the dielectric surrounding it (the air) has broken down. The dielectric strength of air plays an important part in the design of an insulator, for it is well known that under ordinary temperatures and pressures, this value is much below that of most solid insulating materials.

With the foregoing facts in mind, let us consider the

\*Abstract of paper read before the Central Electric Railway Association at Toledo, O., May 26, 1908.

effect of an electrical charge on a few elementary forms of insulators. In Figure 1 is shown a thin plate or disc of insulating material such as glass, having on each face a small terminal connected to a source of E. M. F. Starting with a low potential, only current to charge this small condenser will flow, but as the potential is raised the air in the vicinity of the electrodes breaks down, producing a brush discharge, which has the effect of increasing the size of the electrodes. As the tension is further increased, the zone of ionized or broken-down air spreads over the surface of the plate and finally streamers form across the surface, aiding in breaking down the air further from the electrodes. If the voltage is sufficiently increased, this process continues until the streamers unite around the edges, forming a short-circuit, or puncture of the plate occurs. It must be borne in mind that this is not the result of surface leakage but of breaking down of the film of air next to the insulator. Once the air has become ruptured, the spreading of the streamers will be affected to a certain degree by the shape and dimensions of the solid dielectric.

In Figure 2, for instance, if the potential is carried sufficiently high, the air within the chamber breaks down and

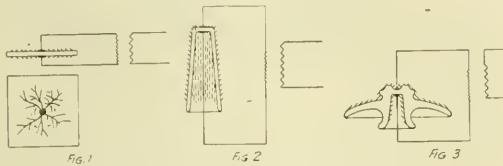

High-Tension Insulators—Figures 1, 2 and 3.

the effect is the same as if the chamber were filled with a conducting fluid.

In Figure 3 appears an insulator head and under such a test the streamers would start at first the same as in Figure 1, but upon reaching the downward projection they are forced away from the streamers on the top surface until a point is reached where the electro-static field is no longer strong enough to break down the air, and the streamers die out and further rupture of the air adjacent to the insulator ceases.

With these points in mind it is a comparatively simple matter to follow out in detail the action of a regular insulator under varying load conditions. Surface insulation has little to do with insulator performance and the actual leakage over the insulator will be inappreciable unless the surface is covered with dust or water or some other foreign substance. Under high potentials, the wet surface should be considered as a conductor, while the dry surface should be regarded only in relation to the electro-static effects described. (Mr. M. H. Gerry, Jr., discussed this feature in detail in a paper presented at the Electrical Congress at St. Louis in 1904.)

Let us now consider the action of an ordinary insulator under varying service conditions. Assume that the one appearing in Figure 4 is operating at its normal line voltage and that all surfaces are dry and clean. If properly designed for this voltage, the electro-static field about the different shells will be too weak to break down the air, hence no brush discharge or "static" will be in evidence. Let the potential be increased and as the electro-static field becomes more intense the air fails and brush discharge is seen around the different shells near the conductors, and at the cemented portions. As the potential is raised, streamers form, further increasing the zone of ruptured air until the air near the shells becomes sufficiently conducting that an arc forms from shell to shell and finally from the pin to the wire, the arc straightening out to nearly the shortest distance between them, but around the edges of the shells. This, of course, assumes that the insulator is sufficiently strong to withstand the flashing-over voltage without puncturing.

Let us now study the same insulator under heavy rain-storm conditions. The entire top surface at once becomes wet and the potential of the line is immediately carried to the outer rim of this piece. Some of the rain beats against the lower shells, wetting them, not only where it strikes but on the under surface of the upper shells, due to spattering, the amount of surface so acted upon depending upon the force and angularity with which the rain is driven and upon the design of the shells. Under a severe storm it is quite possible for practically all of the insulator surfaces to become wet and conducting, except possibly the under surface of the center or bottom shell. If the insulator is properly mounted with respect to the crossarm, and the center shell is correctly formed, this inner surface will remain dry. In the meantime, the line potential has followed the wet surfaces of the insu-

lator until it has reached the bottom edge E of the center shell, so that the full line potential is now being carried by the center shell alone.

The insulator can now fail in either of two ways: (a) by rupture of the air film adjacent to the inner surface, because of the intense electro-static field, resulting in an arc from the shell to the pin, or (b) by puncture of the shell itself. In case of the formation of an arc, the actual current flowing would be of low value, because of the high resistance of the thin film of pure water forming the conducting surface over the insulator, and this would at once result in a drying action due to the heat from the current. As this drying process continues, the resistance becomes too high to permit maintaining the arc, and the discharge between line and pin ceases. It is interesting to note that the drying action is maximum at the neck of the smallest shell, for here the current density is highest and therefore the heating effect is greatest.

From the foregoing it is evident that the behavior of an insulator under severe weather conditions is of chief concern, and its ability to maintain dry surface under the most trying conditions is a direct measure of its value as an insulator.

The contour of the different pieces has much to do with the wetting of the shells in a storm. The shape of a shell may be such as to deflect the air currents, thereby carrying the rain up into recesses which would otherwise be dry. The flare of the skirt portion of the shells also plays an important part. Referring to Figure 4, the second shell B is flared or curved outward at the bottom, and in a driving rain the drops will be deflected against the underside of the top portion, as shown by the arrows, because of the curved surface. The third shell, C, however, is straight, and as the arrows indicate, the rain drops are deflected downward so that the shell above is not spattered.

There are other features which enter into the question of design, however, which make the curved shell particularly advantageous, and it is therefore necessary to regard these different points of merit of the two types carefully in making a choice for any particular design. With a given diameter and height, maximum sparking distances between the rim and shell of the adjacent parts can be obtained by using the curved type of shell, but there is a point where this advantage is lost because of spattering the other shells, as already described.

Protection from Lightning.

Of considerable importance in connection with the selection of insulators is the question of disturbances from lightning. The scope of this paper is too limited to any more than

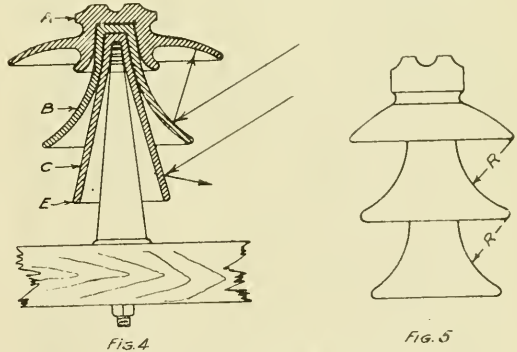

High-Tension Insulators—Figures 4 and 5.

touch upon this subject, but in passing, it might be well to call attention to the necessity of considering lightning as one of the things to be provided against in determining upon the line insulation. By lightning we mean not only the electrical disturbance produced by atmospheric electricity in discharging from cloud to cloud or from cloud to ground, but also the numerous internal disturbances, such as surges, producing extreme potential rises, within the transmission system itself, independent of atmospheric electrical disturbances.

The pressure of the total electric circuit may gradually rise by an electric charge accumulating in the circuit until the pressure between the line and the ground is greatly in excess of the normal potential between two conductors or between any one conductor and the ground. Such a rise in pressure may be due to the collection of a static charge from rain or snow carried by the wind across the line. It could

also be due to electro-static induction from a passing cloud, that is, a charged cloud passing over the transmission line. In explanation, as a positively charged cloud passes over the line, the ground underneath has a corresponding negative charge, and if the line were not insulated from the ground it also would be negatively charged, but at a potential slightly above that of the ground. Being thoroughly insulated, however, it may have practically the cloud potential. As a positively charged thunder cloud approaches the transmission line, the positive charge of the line against the ground rises until a discharge takes place from the ground to the line charging the line negatively. As the cloud recedes, the line remains negatively charged, this charge being bound by the positive charge of the cloud, and when the cloud recedes or discharges to the ground this bound charge is released and discharge then takes place from line to ground. If the transmission line is not protected by efficient lightning arresters or shielded by grounded wires, the insulation is bound to be subjected to such severe strains as just described. If the discharge between line and ground takes place across an insulator, it is quite possible that the line current will follow, resulting in a complete shattering of the insulator, with the consequent service interruption.

Lightning troubles are not so marked on lines operating at voltages below 30,000, undoubtedly because the insulation of these lines does not need to be nearly so perfect as for operating voltages of 50,000 or 60,000. With the moderate insulation required for 30,000 volts or less, the loss of a static charge from the line would be rapid and this charge would not be built up to excessive values before arcing around the insulator would produce relief in the line. At the same time the line potential would not be high enough to cause the line current to follow when discharge from line to pin occurs. Numerous methods have been devised and tried out for protecting the high-tension lines against atmospheric electrical disturbances, among which are included various types of lightning arresters and different schemes for shielding the lines by means of lightning rods on the poles and wires strung parallel to the lines and grounded at frequent intervals. This subject has been given considerable thought and study during the past two or three years, and from various reports submitted by those who have carefully watched the operation of the different devices it would seem that the use of grounded wires placed above the transmission lines greatly minimize insulator troubles from lightning. (Note.—In the May, 1908,

#### Insulator Pins.

The question of insulator pins has long been an unsettled one, many engineers still maintaining that nothing but the wood pin should be used, while others insist upon a metal pin. For low-voltage lines, where the insulators are small and the spans comparatively short, bringing light mechanical loads upon the pins, a good quality locust or oak pin thoroughly treated with oil or paraffine meets all requirements cheaply and effectively. It must, of course, be remembered that to get satisfactory service from a wood insulator pin the design of the insulator itself must be such as to insure against burning the pin from brush discharge or leakage. For insulators of the larger type, where the pin must extend a considerable distance above the crossarm, thereby placing a more severe load upon the pin, and where this load is further increased because of the use of longer spans, a metal pin should by all means be employed.

Many advocates of the wood pin hold that the electro-static stress placed upon the insulator when used with an iron pin is much greater than it would be if a wood pin were used. This means that the insulator would be more liable to break down or flash over under excessive voltage variations than if mounted upon a wood pin. It is quite true that the wood pin possesses, for a time, certain insulating qualities, but this is not of any considerable value with the higher voltages, say 23,000 and more, particularly after the pin has become old and to a certain extent coated over with dust.

A thoroughly insulating pin would indeed be ideal, for with it the thickness of the dielectric would be considerably increased, thereby greatly decreasing the strength of the electro-static field about the insulator, hence increasing the factor of safety. This would mean that the air adjacent to the insulator would not become ionized, and there would be no brush discharge. However, such a pin cannot at the present time be made, because of the mechanical difficulties involved. Unfortunately we have no suitable insulating material of sufficient mechanical strength to meet this class of service.

The transmission line has in many cases been hampered by the desire of the engineer to introduce some more or less new and original ideas, putting, as it were, his personal stamp upon the line. It is, of course, true that in the early days of porcelain insulator manufacture the maker did only what the engineer desired, but as soon as the demand for insulators

warranted, the manufacturer at once placed himself in a position to design insulating devices and equipped himself with everything necessary for the study of insulation problems. The result is that today the modern high-tension insulator factory, because of its experience and facilities for investigation, is far better equipped to design insulators for a given service than the average engineer who has had but little experience in this class of work.

In drawing the specifications for insulators, points often come up which make a proposition unnecessarily difficult and expensive for both the purchaser and the manufacturer, and this condition could often be prevented if the manufacturer were given a full understanding of the actual requirements and not hampered by more or less foolish specifications which the engineer, when he drew them up, knew could not be met.

The following suggestions to aid in drawing insulator specifications are being offered with an idea of making them cover all general insulator requirements. These specifications are made so that they can be commercially met by the manufacturer and at the same time insulators made in strict accordance with them should fulfill the requirements perfectly under all ordinary conditions.

#### Suggestions for Insulator Specifications.

Insulators should be made of a grade of dense porcelain best suited for high-tension insulators and the burning should be so done as to insure thorough vitrification of the pieces without overfiring.

The porcelain body should be practically non-absorbent and pieces broken from any insulator should not show an absorption in excess of one-tenth of 1 per cent. The absorption test should be made by thoroughly drying the pieces in an oven before the first weighing; they should then be immersed in water for 48 hours, after which all surfaces should be carefully dried and a second weighing made. The increase in weight expressed as a percentage of the original weight will show the absorption.

All insulators should be given a dark-brown glaze (or other color required) on all exposed surfaces. Those surfaces which are cemented together and those upon which the insulator rests in burning not to be glazed. The pinhole should be left unglazed if the insulator is to be cemented to an iron pin.

All cemented joints should be carefully made with neat Portland cement of the best quality and the assembly should be so done as to leave no hollow spaces or voids between the cemented surfaces. In assembling, the cement should be mixed only as needed and in the portions of 80 per cent cement and 20 per cent water, and no cement which has been mixed for more than 30 minutes should be used. The assembling should be so done as to bring all of the various parts in correct alignment.

All parts should be carefully inspected as they come from the kilns and any which are chipped or cracked, particularly at the surface where the cells are cemented together, should be discarded. Badly warped or distorted pieces and those having checks of appreciable depth at any points on the surface should be rejected.

All parts should be tested for one minute at full line potential except in cases where the design of the piece will not permit reaching this voltage without flashing over. In such cases the test voltage should be within 5,000 volts of the flash-over value.

Each assembled insulator should be tested to at least double the full line voltage for a period of not less than three minutes.

The insulator should be capable of withstanding a rain test at twice the operating voltage for a period of 10 minutes without flashing over or injury to the insulator, the precipitation being at the rate of 1 1/4 inches in five minutes and directed against the insulator in a fine spray at 45 degrees.

All insulators to be operated at 23,000 volts or more should be tested with at least one kilowatt of available generator capacity for each insulator under test.

In conclusion, it is urged that the policy be a liberal one when it comes to the expenditures of the transmission line. As a general thing, no expense or trouble is spared in making the power-plant equipment complete, and in fully safeguarding this equipment. On the other hand, the transmission line, which in the event of failure for any cause makes the power-house entirely useless until the line trouble is corrected, is often provided for last, the expense being cut down to the lowest possible figure. Such a system is bound to have line troubles, causing heavy expense for repairs and losses due to interrupted service. These losses could be almost entirely prevented by the use of better insulators and proper line protection at the outset, and the cost of this insurance would be less in amount than the total for losses due to interruptions during a few months of operation.



## TICKETS AS A FARE MEDIUM FOR STREET AND INTER-URBAN RAILWAY TRAFFIC.\*

BY JOHN F. OHMER, PRESIDENT OHMER FARE REGISTER COMPANY,  
DAYTON, O.

There is probably no commodity so popular and so well and universally known as the card or scrap of paper commonly called a railway ticket. It is used by millions of people in every civilized country in the world. It is made in a plurality of forms and printed on paper of all colors. It is used more extensively in England and on the continent of Europe, perhaps, than in our own country.

In 1906 the Grosse Berliner Strassenbahn of Berlin, Germany, disposed of 480,000,000 tickets, and one of the omnibus companies of London disposed of 500,000,000 tickets in the same year. The ticket is applied in dozens of ways; it has as many designations and differentiated values. For city properties we have 5-cent tickets, 6 tickets for 25 cents, 11 for 50 cents and 25 for \$1.00; school



Tickets as a Fare Medium—Aluminum Ticket Used in Cleveland.

tickets, employes' tickets, workmen's tickets, trip and time passes and all kinds of transfers, the latest innovation being Mayor Tom's aluminum slug, sold for three cents each by the Municipal Traction Company of Cleveland, O.

For interurban properties many city forms are used, besides a multiple of tickets, good to and from all stations, comprising the round-trip tickets, excursion tickets, special tickets, half-fare tickets, coupon tickets, mileage and commutation and a variety of forms of duplexes, some forms of all of which are adopted by companies for the convenience and accommodation of the public and to subservise the companies' interests. Is it to be wondered that the heads of certain auditors and passenger agents are fast turning gray?

A man lays down 50 cents and receives for his money a transportation ticket; the presumption is that he paid the company 50 cents for the ticket. As a matter of fact he paid for his ride and the company accepts the money and gives its promise to transport the bearer in one of its cars to the agreed destination, as evidenced by the ticket. In other words, the company issues its note to bearer. By that transaction the company becomes a debtor and the public a creditor to the extent of the money paid, and the company must deliver the goods or redeem its obligation by refunding the money it receives. It makes no difference whether the deposit be for a 3-cent ride or a dollar ride; whether it be for a ticket sold by station agents or by a conductor or whether it be for one part of a duplex ticket or for a transfer. The obligation of the company must be paid and it can have no assurance of the liquidation of its indebtedness until the promissory note is canceled. The company may, in reality, pay its obligation to the original creditor, but does it by so doing always cancel its liability, its note, its promise to pay? That is the vital question, and it is to that important feature, primarily, that I desire to direct your attention.

While it is true that by the issuing of a ticket the company receives its money in advance for the ride, it is likewise true that the credit issued is, in most cases, transferable and negotiable and thereby subject to use by a plurality of people and, under most conditions, a plurality of times. The loss and damage to the railway company, because of its great number of credits for miscellaneous amounts distributed through so many agencies and to thousand of creditors, can scarcely be computed. That the amount is enormous there can be no doubt. Neither can it be doubted that the extent of loss varies with the extent of operation and the various weak channels and avenues opened to encourage manipulation.

### Transfers.

Beginning possibly with the lowest denomination of credits issued by railway companies, I will take up first the ordinary transfer used on practically all city properties. Although the usual form of transfer is issued with a limitation and the opportunities presented are less in number and are restricted as compared to those offered by the unlimited ticket, all managers know of the common practice of manipulating the

transfers, both by the traveling public and by the conductors. It is carried on to such an extent that it is costing many companies millions of dollars. It is also well known that conductors substitute 2½-cent or 4-cent tickets for 5-cent cash fares. Too often the busy manager does not consider the question sufficiently to realize that 100 substitutions of 2½-cent tickets for 5-cent cash fares mean a loss of \$2.50, and, when told that his conductors are making no separate record of the \$2.50 collections and the \$5.00 collections, but are recording both together as a collection, with the option of accounting for either class to suit their convenience, a searchlight seems to be turned upon the subject, revealing actual conditions which astound the manager.

The conductor on an interurban line takes in exchange for a ride the ticket fare medium, but does the acceptance of that ticket cancel the obligation of the company? The conductor issues one part of the duplex ticket to a passenger from whom he receives a cash fare; the passenger accepts the ticket as evidence of payment; in other words, a receipt for money paid. But, with the issuing of that ticket, does not the company issue its credit for the ride, limited perhaps to one day? Nevertheless the credit is made unconsciously possibly by most managements from the presumption that the issuing of a duplex ticket is merely a receipt to the passenger for his money.

### Duplex Tickets.

Another passenger procures the company's credit in the form of a 50-cent ticket for a ride to destination. In exchange for the ride the passenger pays to the company's conductor the credit or promise of a ride issued to him by the company, but does the acceptance of that ticket by the conductor cancel the company's obligation? Although the conductor is instructed to punch the ticket upon receipt for the purpose of cancellation, does it necessarily follow that he will punch it or that the ticket is canceled even after being punched? So long as the ticket is not canceled is he not aware of the company's obligation extended by that ticket, and appreciating its value, is he not aware that advantage can be taken of the company by transferring it and retransferring the same obligation, which is good until properly canceled or redeemed? Is he not also aware that the company's obligation, made when he issued a cash duplex receipt for a cash fare paid, goes with the receipt issued and that, until canceled by limitation, it has intrinsic value subject to resale? And, encouraged by the large number of patrons who would rather see the company victimized than otherwise, is he not subject to and does he not very often yield to temptations offered for the furtherance of his own interests? He finds it profitable to shave the company's credits.

All these are questions too well known to require further comment, but the remedy for this defective operation is the all-absorbing topic, and we all are looking for any prescription to guarantee a better operation or at least to curb the chances of manipulation, if not entirely to effect a cure.

The practice of using discarded duplex tickets the second and often the third time is as well known as the practice of canceling different values on the same sequel, the company thereby sustaining the loss for the difference. If the use of the duplex ticket is for the purpose of auditing the receipts paid the conductor, then why the necessity through that medium of permitting the conductor to extend the company's credit and thereby continuing its liability? If a man gives a receipt for cash paid to him for services rendered he would be foolish to give a receipt that would in the least possible manner render him liable to perform the services the second time. Much less likely then would he authorize his agents to bind him for further performance other than that for which receipt is given.

Steam railroads take the precaution in all large cities to compel passengers to present tickets to gatekeepers for cancellation before passing out to the train, but the punching of a ticket by the gatekeeper does not cancel that ticket; if it did it could not be used by the passenger, and if it can be used by the passenger today it can likewise be used by another passenger tomorrow. It is possible, however, that the passenger on the second trip would circumvent the gatekeeper and board the train without passing through the gate or it may be possible for him to procure a low-rate ticket for presentation to the gatekeeper to insure his access to the train. While the gatekeeper's mission, if properly carried out, is a great safeguard, at the same time it does not insure to the company by any means that the same ticket cannot be used the second time or oftener, the extent of the manipulation being limited to the desires of an unscrupulous conductor and his correspondents.

In my estimation the fault is generally with the ticket. Whatever advantage is to be derived by the employment of the gatekeeper is limited to the large and terminal stations only and the application of this system would be confined to

\*Paper read before the Central Electric Railway Association at Toledo, O., May 26, 1908.

very few interurban properties. It therefore behooves managements of interurban properties to provide themselves with the best opportunities offered for surrounding the sale and use of tickets with the greatest possible protection. For this important part of the operation the most efficient protection is none too good.

The tickets used on interurban roads particularly should be printed with the shortest limitation and it will be found profitable to have them devised to be self-canceling by the first use of the ticket. Inasmuch as the ticket itself carries with it the company's credit to the extent of its value, it is analogous to the use of a government certificate for \$1.00, which, on its face, reads as follows: "This certifies that there has been deposited in the treasury of the United States of America one silver dollar, payable to bearer on demand." The certificate itself has only a circulating value, while its real worth is in the redemption feature; but so long as it is in circulation it has the value of a dollar's worth of silver back of it, which amount is made payable to bearer on demand. Likewise with a railroad ticket it constitutes a certificate for the amount deposited, and on its face it subscribes to perform its service to the holder thereof and is worth the amount deposited in exchange for its issue. I, therefore, contend that credits in the nature of transportation tickets, issued by railroad companies, are as valuable as the amount of money deposited against the issue of each, save and except the discount required for its negotiation. It is, therefore, of the utmost importance that upon receipt of tickets paid to him in exchange for rides, the conductor should charge himself and thereby credit the company for the cancellation of its obligation made by the issue of the ticket. The mere fact of a conductor charging himself with the receipt of a ticket irrespective of its value does not in any sense cancel the company's obligation made at the time the ticket was issued. It may, however, if the conductor charges himself by registering for a ticket, have the effect of discharging the company's obligation for the value of some form of ticket; but while the conductor receives a ticket which carries an obligation on the part of the company to the value of a dollar, he may, with the substitution of a 5-cent or 10-cent value ticket, release his responsibility to the charge of a ticket and still retain for subsequent use the company's larger obligation, and this process makes it easy, by the continued liability, for the company to unjustly pay its obligation the second or third time or oftener. The opportunities presented are so many and varied by the use and common practice of railway tickets that the unscrupulous conductor has his choice in many ways for manipulation without much fear of being detected.

As the rapid development of interurban properties and the expediency of making traffic arrangements for through traffic over several lines necessitates the sale of through tickets by all companies in the traffic compact, each company, by permitting the sale of tickets and by retailing its credits through the medium of tickets, further jeopardizes its interests by authorizing the agents of other companies to increase its obligations.

#### Standardization of Tickets.

One of the most important subjects which has been discussed and is now under discussion is the standardization of operation. It appears to me that to standardize the form of tickets as much as practicable and to prescribe a standardization for their use is opportune; and, while uniform or standard tickets would be desirable themselves, it must necessarily be more desirable if some standard application should be adopted for the use and auditing of all tickets, surrounded with the best possible safeguards, whereby all companies in the traffic arrangement would be placed on an equal basis, thereby insuring equity to all parties in interest.

#### Transfers.

The transfer has come to stay and while the best authorities agree that its use stimulates traffic, at the same time it is admitted that, by reason of abuse, it is causing much trouble and anxiety on the part of the managements. The loss for which it is responsible is something appalling. From a careful canvass among some of the larger city officials I am informed that there are issued from 25 to 30 per cent more transfers than the number collected. This great difference is caused primarily by the fact that conductors are usually informed that the transfer has no value, and with that understanding they issue it indiscriminately, either singly or in bunches, it being a matter of indifference usually whether any or all of the transfers issued are ever taken up by the company. No greater error was ever advocated than the managers' edict which proclaims that the transfer has no value, and it is because of this error that the losses, in a great measure, are sustained. Transfers, being numbered consecutively, enable the conductor to report as to the number he issues, and whether he issues them singly or in bunches is

immaterial so far as making up his record is concerned. If an inaccessible record could be made of each transfer issued, by registering the issue of the transfer, it would, in my opinion, reduce very largely the excess transfers issued and reduce the chances of manipulation accordingly.

#### City Tickets.

A ticket issued by the company for 2½ cents means a credit of 2½ cents, and 100 2½-cent tickets means a credit of \$2.50. The enormous number of 2½-cent tickets and 4½-cent tickets issued by many of our city properties means thousands of multiples of 2½ cents and \$2.50, 4½ cents and \$4.16%, so that in the aggregate the extension of credit through the medium of tickets is something enormous. Unless the collection of each ticket is properly audited, to a certain extent the credit is merely extended to the conductor with an opportunity to shave the company to suit his inclination; likewise with the transfer, which carries with it a limited credit, and unless it, too, is properly recorded it may subserve its purpose to the conductor for manipulation.

The remedy, then, is to devise ways and means for the conductor to record each collection by itself, and specifically under its own value; until this is done there can be no hope of obtaining the best results.

If a workman is receiving for his services 22 cents per hour for certain hours of the day and 33 cents for certain other hours of the day, he would not, under any circumstances, permit his employer simply to add up the number of hours of service rendered and make settlement for so much per hour at the option of his employer. He would demand that a separate record be kept of each class of time and settlement made accordingly.

Your employes are paid on a graded scale; some are paid 22 cents per hour, some are paid 25 cents and others are paid 27 cents per hour. Suppose the total number of hours for all employes numbered 10,000 hours and your paymaster was instructed to use his own discretion in designating the number of hours and the pay for each; would the employe be satisfied or accept any such auditing of his credits?

#### Fares in Cleveland.

The first practical operation by municipal ownership in this country is probably that of the Municipal Traction Company of Cleveland, O. This company, immediately after taking over the property from the Cleveland Electric Railway Company, elected to charge a straight 3-cent fare and simultaneously issued a perforated aluminum disc about the size of a nickel. These discs are sold for the regulation price of three cents and I am informed that 3,000,000 of these discs are to be provided and issued to the public in the city of Cleveland. These discs have no limits as to time. If the statement that 3,000,000 of them are to be issued is true, after they are put in circulation the company will then have issued its credit for \$90,000. It is reported that these discs are to be in common circulation as a medium of exchange for bread or beer. While the issue of these discs or coupons of a similar nature may make it more convenient for the payment of fares on Cleveland cars, I doubt the expediency of the adoption of the innovation for no other reason than the fact that the discs can be so easily counterfeited and with such a degree of perfection that it would be impossible to detect the counterfeited discs from the company's authorized issue. The company ultimately may find it expensive to redeem its credits, authorized and unauthorized.

#### Collections.

The ordinary practice which has prevailed for years provides to the conductor limited means whereby he is obliged to combine with his registrations different denominations of fares. His 5-cent fares, his 3-cent fares, his tickets of various values and sometimes his transfers are registered together. Does that operation charge him with the collections according to the value of each or does it charge him with just so many collections irrespective of the value; does that operation audit his debits to the company, and does it audit his work in advance for the auditing department? Acting as agent for the company the conductor should, on receipt of his company's credits, charge himself for each particular credit received. Operating under the system of registering different values together, is the conductor wholly to blame if in making returns he gives a collection of some kind for each collection with which he has charged himself? Has he been given competent means under such circumstances for making the proper charges and audits which will conform to the collections made by him? And has he been given the means whereby he can best subserve the company's interests and at the same time protect his own integrity? Many successful managers have long since realized the fallacy of the old-time operation and are now appreciating the subject after giving it a careful diag-

nosis. Only recently the general manager of one of the largest properties in New England, at a meeting of his district managers and superintendents, made the statement that "with the ordinary operation the companies themselves are fast manufacturing thieves."

On the other hand and in equity, no honorably disposed conductor will object to charging himself properly, by making a separate record for each value collected by him for the company, and if he has any knowledge of business and appreciation of justice he will prefer doing it for his own protection.

**Interurban Tickets.**

Obviously the greater the number of tickets the greater the distribution of the company's credits and the more clerical work is involved in properly accounting for them. The best companies are curtailing their forms and numbers to the minimum. Where tickets must be issued they should, as previously stated, be issued as much as possible with a limitation, and the shorter the limit the better. They should be self-canceling. Attached to each ticket and each coupon of a ticket should be a passenger's receipt with the same consecutive number thereon and printed clearly to indicate its purpose. For example, I submit the following:

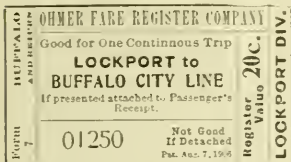

The consecutive number on the ticket and on the passenger's receipt is the same. Upon presentation of this ticket the conductor must detach the receipt and return the same to passenger to insure his ride to destination and the conductor must register the ticket as 20 cents. With that operation the collected ticket would not only be canceled, but the conductor would charge himself for the value of the ticket, viz., 20 cents, and he immediately establishes an audit for the cashier and auditing department for that collection. The same application can be made for all I-way and round-trip tickets.



Tickets as a Fare Medium—Interurban Ticket with Passenger's Receipt.

each fare paid is a great guarantee and subserves its purpose to the company in a way that no secret or private record could possibly subserv. Besides, the direct registration or indication does not make a draft on the company's credits as with the issuing of a duplex.

Prof. Charles William Eliot, president of Harvard University, in a recent public address, referred to the acts of public officials as follows:

"Publicity is the cure for many evils. Entire publicity is the greatest guarantee of official honesty. The smallest acts of the public official should be open to examination by every citizen."

I can conceive of no more pertinent application of this injunction than to the thousands of conductors acting in the capacity of official agents for railroad companies in the collection of the company's cash and credits.

I have referred to the enormous collections of tickets made by the Grosse Berliner Strassenbahn of Berlin, and to one of the several omnibus companies in London. In this connection it might be pertinent to observe that in Great Britain and on the continent of Europe, in the Latin American countries and largely in the Oriental countries the general system of issuing tickets for fares paid prevails on all city properties, even for fares collected in small amounts. For instance, the T. Tilling, Limited, Omnibus Company collects fares and issues a ticket receipt for each fare collected in denominations as follows: 1<sup>st</sup> d., 1<sup>1</sup>/<sub>2</sub> d., 2<sup>d</sup>, 2<sup>1</sup>/<sub>2</sub> d., 3d. In many cases the system prevails because of the city or country regulation which compels the giving of a receipt for each fare paid. The prevailing use of this system, with the opportunities for manipulation, the enormous cost of tickets and the great amount of clerical work involved in accounting for them are causing the management much anxiety, and a better system for operation has for a long time been sought by the managers of the great properties in the old world. The introduction into Europe of the multiple Obmergraph promises to completely revolutionize the prevailing system of operation. I have, for some time, co-operated with the managements of a number of the largest companies in Great Britain and on the

continent of Europe, and only recently have I devised a new form of tickets and prescribed specifications for a new system of operation for nine companies.

In Germany the fares range from 5 to 35 pfennig; in France and Belgium from 5 to 30 centimes, and in Great Britain from 1<sup>1</sup>/<sub>2</sub> d to 1 shilling.

I have in my office now the fare schedules and samples of tickets and copies of specifications showing the present modus operandi of what is probably the largest electric railway corporation in the world—that of the London United Underground Electric Railways. This company operates the Baker Street Waterloo Railway, Great Northern Piccadilly & Brompton Railway and the Charing Cross Euston & Hampstead Railway. Its actual paid up capital is \$110,000,000. The fares collected range from one penny in multiples up to a shilling and the number of revenue passengers figures into the millions daily. Just what success I may have in solving the perplexing problem of the fare collection service of the London Underground remains to be seen, but suffice it to say that I feel highly honored in having referred to me the working out of a solution for the greatest electric properties in the world.

I believe in placing confidence in mankind—in fully crediting integrity until it is found guilty. Eliminate suspicion by removing the causes which produce it. Accord to every employe the means to do his work right and in a businesslike way, equally fair to him as it is to the employer, and the causes for suspicion will, in a great measure, be removed. We must continue struggling after the remote ideal of perfection, even though we never expect to obtain it. We would be unhappy if we did obtain it, for the greatest joy in all things is the working for it. Let us continue to strive onward, always mindful of the injunction, "Fatherhood of God and brotherhood of man," and success will be ours.

**THE MERIT SYSTEM OF DISCIPLINE.\***

BY FRANK HARDY, DIVISION SUPERINTENDENT FT. WAYNE & WABASH VALLEY TRACTION COMPANY, HUNTINGTON, IND.

The merit system consists of a debit and credit account with each employe, kept in a book ruled for that purpose or in alphabetical files. An employe's violation of rules is charged against him by a certain number of demerit marks, the number depending upon the seriousness of the offense. As an offset against these demerit marks, he is entitled to receive a certain number of merit marks for acts performed which would be considered worthy of recognition by the company, or for a clear record for one month, and at the end of six months a cash prize is given to the motorman and conductor having the best record. Employes are allowed to examine their record at any time. When an employe's demerits exceed his merits by 100, he is discharged.

The objects of the merit system are, first, to avoid a loss of wages by persons employed and suffering to those dependent on their earnings; second, to stimulate and encourage employes in the faithful and intelligent performance of their duties.

The Ft. Wayne & Wabash Valley Traction Company has a list of violations of rules and the number of demerits imposed; also a list of meritorious acts with number of merits given for each.† This list is posted on all bulletin boards. Employes are notified when they receive merit or demerit marks on a blank form used for this purpose, giving date, time, number of charge, number of merits or demerits given, and, if necessary, a letter is written calling attention to the offense and the course the employe should have followed. When an employe receives merit and demerit marks a form is posted on all bulletin boards, which shows that an employe has received so many marks for a certain offense.

We have a merit board or court of inquiry, which meets once a week, composed of the general manager, superintendent of transportation and all local superintendents. The work of the board is to investigate, produce evidence and pass judgment on all violations of rules or meritorious acts. The minutes of the meetings of the board are kept as a part of the records of the merit system.

Our reason for having a code list of violations and meritorious acts is that when a notice is posted on bulletin boards that an employe has received marks for a violation no one but the man disciplined knows who is guilty. The employe who received marks will not be humiliated before the other employes, but each man will know that some employe has received marks and the reason therefor. This will not only

\*Abstract of paper read before the Central Electric Railway Association at Toledo, O., May 26, 1908.

†See Electric Railway Review, February 15, 1908, page 215.

discipline the employe who received marks, but benefit all employes by warning them of the offense and causing them to guard against a repetition of it. If the company makes a new rule for the guidance of employes, attention can be called to the fact very quickly by showing and imposing demerit marks on its violation. If the list of merits and demerits is always before an employe it will aid him in his work by showing him right from wrong and will provide an incentive to do right.

The merit board meets on each Monday to act on all cases of the preceding week.

The advantage of the merit board is very evident. Many times a high official insists on hiring employes, being afraid to risk the judgment of the lower officials in hiring men. He will place this employe under a petty official, perhaps tyrannical, or partial, at least. If the lower official makes a grave mistake in discipline and the higher official corrects his mistake, the lower official loses prestige with the employe and discipline has been destroyed instead of created. How often the general manager believes that the motorman, conductor or other employe is right yet cannot take their side of the case openly, for if he does the superintendent completely loses control of the men and all cases of discipline would then be appealed to the general manager over the head of the superintendent. With the merit board this is overcome, as all employes are permitted to show, in writing, why they should not receive marks or ask the merit board to reconsider if they are not satisfied with the ruling.

Another advantage of the merit board is that the men on all divisions receive identically the same treatment. Many times a superintendent brings to notice violations on other divisions or on his own division which the men on other divisions are overlooking. In this way the service on each division receives the benefit of the experience, knowledge and the attention of the superintendents of all divisions, which it would not receive if they did not have a common cause in the merit board.

Some other advantages of the merit system are that it is fair and just both to employes and company; points out the right from wrong; is an incentive to do right; picks out the good men from the bad, and if handled carefully will defeat the idea of unionism, for unionism comes from the agitation of wrongs, real and imaginary. If men believe that they are receiving just treatment, that their record is what they make it and that their services are appreciated it is hard to produce ill-feeling or friction between employer and employe. The system teaches trainmen to be courteous, accommodating and careful and creates a better feeling between officers and employes. Under the old system if a man is to be disciplined, he is generally excused for a certain length of time. This means so many dollars to this man and his family. It is true that this will touch his feelings, but in nine cases out of ten he is farther away from the management and his feelings for the company is an ill-feeling. If this same man does a meritorious act and saves the company hundreds of dollars, the company cannot reward him by giving him a hundred dollars. All they can do is to thank him. In other words, under the old methods of discipline the employe gives dollars for thanks, which is not a fair exchange. Under the merit system the employe gets merits for thanks and demerits for discipline, which is a fair exchange.

The problem of discipline is an old one, probably because of this is due the fact that it is often considered lightly. Very few operating officers can say that they are absolutely satisfied with their method of discipline. Under the old method men were handled with varied success owing to the fact that some superintendents gave discipline much thought and careful attention as to details while others paid little attention to the subject. The same is true of the merit system. If it is put in use and then expected to run itself without a thought or without careful supervision and attention it will fail. Most cases of failure can be traced to the fact that it has not had proper attention, and that discipline has been administered by an individual instead of a merit board.

This system was first tried on the Interurban Division of the Ft. Wayne & Wabash Valley, being put into effect on May 1, 1907. It proved such a success that it was adopted for all of the city systems on January 15, 1908, after which date all train and car men on all divisions were subject to this system of control.

The Superintendents' Association was formed on December 30, 1907, and when the merit and demerit system was adopted last January, it was decided to have the Superintendents' Association form the merit board for passing on all cases subject to merits and demerits.

It is announced that the extension of the Toledo Postoria & Findlay Railway from Pemberville to Toledo, O., will be opened for operation on June 1, completing a through line from Findlay.

## THE CAPACITY OF THE NEW YORK SUBWAY.

Bion J. Arnold, consulting engineer, Chicago, has submitted to the New York public service commission for the first district a report on "The Capacity of the New York Subway," which is the fourth in a series of reports made by Mr. Arnold on the subway of the Interborough Rapid Transit Company, as the result of a comprehensive investigation designed to point out methods of improving the present service and to recommend changes to be made in future subways. The preceding reports have been published in the issues of the Electric Railway Review of December 7, 1907, page 892, February 29, 1908, page 262, and March 21, 1908, page 355.

The present report analyzes the fundamental design of the subway, points out how further increase in its capacity can be obtained and directs attention to certain fundamental defects or omissions in the present subway which should be avoided in future subways. In discussing the limitations of the subway Mr. Arnold says:

A study of the present subway will reveal the fact that one of its fundamental defects, as far as its capacity is concerned, is that it fails to carry sufficient passengers upon a fixed 5-cent fare to justify the large investment which was finally found necessary to produce this splendid means of transportation. The total investment required to build and equip the subway as it exists today amounts to approximately \$75,000,000, of which \$50,000,000 may be charged to the cost of the permanent way and \$25,000,000 to the cost of equipment. Should it be contended that these figures include an excessive construction profit it is but fair to state that it is quite probable, in fact almost certain, that were the subway to be constructed now the open cut method of construction would not be allowed and thus the actual cost of reproducing the present subway would be increased by a greater amount than is represented by any amount which may be included in the above figures as a construction profit.

In 1907 the subway carried 182,000,000 passengers and during the present year it may possibly carry 200,000,000 passengers, resulting in an annual income of \$10,000,000. Thus the gross income per annum from passenger traffic will be equal to only about 13 per cent on the actual investment, as compared with surface and elevated railway systems, many of which take in an amount equivalent to 20 to 25 per cent of the costs necessary to reproduce them.

For the last two years the operating expenses of the subway have amounted to an average of approximately 45 per cent of the gross receipts. On this basis the annual operating expenses, with a gross income of \$10,000,000, will amount to \$4,500,000, leaving \$5,500,000 to be applied toward the payment of interest, depreciation, taxes, sinking fund and profit. This amount is only 7.33 per cent upon the above investment of \$75,000,000, and it is thus apparent that the present subway, which is now overloaded, is not built in such a way as to furnish sufficient capacity; with the conditions under which it has to operate, to produce financial results consistent with the investment.

### Recommendations.

The improvements suggested in the report may be summarized as follows:

(1) The changes required in the present subway to increase its capacity from 30 trains an hour to 40 trains an hour, with a marked increase in its earning capacity, should be carried out; that is, the block signal system should be improved, a speed control system developed and the cars altered, all in accordance with recommendations made in Reports Nos. 1, 2 and 3.

(2) The Ninety-sixth street alterations should include not only the removal of the crossovers as already approved by the commission but also the altering of the station itself to provide a local track upon a lower level, allowing the four tracks upon the present level to be used by the express trains.

(3) A shuttle train service for the South Ferry station should be provided at once and a comprehensive study should be made of a plan for a double-decked station at this point which would not only give all South Ferry passengers a station on the main line, thus eliminating the shuttle train service, but also allow all trains to run through to Brooklyn.

(4) The braking of the trains at the stations should be improved so as to save the five seconds which is now often lost by lack of skill in stopping the trains.

(5) One car should be added to the rear of each local train during rush hours and the public should be encouraged to use this extra car upon the local trains, which, although not reaching the platforms, could be used for through travel

with the idea of adding even more cars to the trains if the public can be educated to take advantage of this increased accommodation.

(6) A series of braking tests showing the distance required to stop a train by means of the emergency stop from full speed should be made in order to secure reliable data for planning the block signal systems for future subways.

(7) The manufacturers of block signal systems should be encouraged to develop a traveling caution signal to supplement the present fixed caution signal, as this signal could be installed to advantage not only in the present subway but in future subways.

(8) If future subways are to be built and operated independently of the present one the plans should be made with the idea of using multiple side door cars 18 inches wider than the present car, thus adding at once 25 per cent to the capacity of each car and increasing the possible carrying capacity of such subways without proportionately increasing their first cost.

(9) In order that future subways shall not only pay a fair return on their investment but also allow for a satisfactory depreciation reserve, it is essential that such subways be located where there is sufficient density of traffic to justify their being built and at the same time they should be so designed as to handle the volume of traffic which must be passed through them during rush-hour periods in order to make them self-sustaining.

(10) All future trunk line subways should be designed with stations on the reservoir principle, that is, with double tracks in each station for each main line track. This can best be accomplished by not only double-decking the stations, but also double-decking the subways between stations and by this method secure the carrying capacity necessary to justify the occupancy of the street and at the same time produce a property which will justify its cost. Where a cross-town subway is to be provided for the stations should be triple-decked.

#### ENGINEERING FEATURES OF THE WASHINGTON STREET TUNNEL, BOSTON.

In the early part of the year 1909 it is expected that a new rapid transit double-track tunnel will be in operation under Washington street, Boston, the most important business thoroughfare in New England. The changes in the transportation facilities of the city which the operation of this new tunnel will inaugurate have already been outlined in the *Electric Railway Review*. The most striking feature will be the withdrawal of elevated trains from the original subway under Tremont street, their transfer to the Washington street tunnel and the replacement of the surface car service in the Tremont street subway which was withdrawn upon the opening of the Boston Elevated Railway Company's train service in June, 1901.

The Washington street tunnel is much more favorably designed with reference to the operation of train service than the original subway, and besides being far less encumbered with curves and grades, it will accommodate 8-car trains at its station platforms, against a maximum capacity per subway platform of five elevated cars per track. On account of the narrowness of the thoroughfare under which the Washington street tunnel is built, the construction problems encountered by the Boston transit commission in the prosecution of the work under the direction of Howard A. Carson, chief engineer, present special interest to the expert in the field of urban rapid transit.

The Washington street tunnel extends from a point in Ash street, south end, opposite Nassau street, to the incline for elevated trains in the north end, between Haymarket square and the North station. The total length is about 6,100 feet. The construction work required the division of the tunnel into 11 sections, and stations are located at Boylston and Essex streets, Winter and Summer streets, Milk street, State street and at Union-Friend street. Of the whole length of the tunnel about 50 per cent is straight, 33 per cent has a curvature of about 5,000 feet radius, 2 per cent 1,800 feet radius, and 15 per cent 500 feet radius. Of the whole length of the tunnel 40 per cent is level, 7 per cent has a grade of less than 1 per cent, 22 per cent about 2 per cent grade, 13 per cent between 3 and 4 per cent grade, and 18 per cent of 5 per cent

grade. The latter is mainly at the inclined approaches, by which the elevated trains now in operation on the elevated structure in Boston will descend and ascend in connection with their movements in the tunnel. The lowest point in the tunnel is about 52 feet below the level of the elevated structure at the North station.

The tunnel structure in Washington street is in no place far removed from the abutting building lines. On account of the narrowness and irregularity of the street and the frequency of the station platforms, the cross section of the tunnel varies every few feet, and the design was a special problem throughout. Extensive removals of gas, water, sewer pipes, electric and pneumatic services were required. Most of the earth from the pavement to the tunnel bottom had to be taken out. The work was carried on with so little disturbance to traffic of any kind that many citizens of Boston are still unaware that a new tunnel has been built and is now being finished for service under the city's most congested street. The paved surface has been replaced little by little with heavy plank laid flush with the original surface of the paving, and supported on timbers, most of the daytime work being done under this bridging. Cars have not been diverted from the street during the day except in case of emergency, and at all times space has been left for the passage of the fire department.

The general method of doing the work has been underpinning of buildings where necessary, building side walls in narrow trenches one at a time, building new sewers, placing interior posts, in trench if any are required, putting on the roof, digging out the core and completing the invert. South of Kneeland street the tunnel is wholly under private land and the supporting of present and future buildings was met by a heavy roof of steel beams and concrete, carried by reinforced concrete side walls and steel posts in line between the tracks. North of Kneeland street the narrowness of the cut obliged the use of staggered station platforms as near the street as possible, and at these platforms the roof is built of steel girders with concrete arches between. Where there are no platforms, and where a considerable portion of the tunnel is deep, without platforms, the covering is an arch with tie rods. In all parts of the work the contingency has been provided for that the pressure of the earth may be removed on either side of the tunnel while a heavy load is being carried on top and a pressure is being exerted on the other side; a provision not usually necessary in other cities.

Work was begun October 6, 1904, on the southerly incline of the tunnel and at the present time part of the tunnel is being ballasted for tracklaying and the side walls and stations are being tiled and finished. Extensive changes in the platform and track arrangements north of the Union-Friend station are still to be completed, but the major portion of the tunnel is practically finished and ready for the Boston Elevated Railway Company, its lessor, to install tracks and electrical equipment. Plans for the latter are now being worked out by the company.

The Indiana Union Traction Company has begun extensive improvements at Mounds Park, near Anderson, Ind. Howard Witt of Anderson has been engaged as amusement manager. A contract has been let to the Ingersoll Amusement Company of Pittsburg to install a scenic railway. A large "figure eight" and other attractions will also be added. The park season will open on May 29 with a band concert.

The Union Loop Protective Association of Chicago recently exhibited at its offices a model of a proposed elevated station designed by Charles K. Mohler, which the association seeks to have the elevated roads adopt for the loop. The station is composed largely of prismatic glass for stairways, platforms and canopy roofs, in order to avoid the darkness in the streets occupied by the loop structure, which is frequently complained of by property owners.

A 4,000-GALLON WATER CAR.

saddle in which rests a 4,000-gallon capacity steel tank. One of the illustrations exhibits the detail dimensions of the tank framing and floor structure of the car.

During the past year the Oakland Traction Company, Oakland, Cal., built at its shops the water tank car shown in

The steel tank comprises a 3/4-inch steel shell 5 feet 4 1/2



Oakland Traction Water Car—View of Car in Yards.

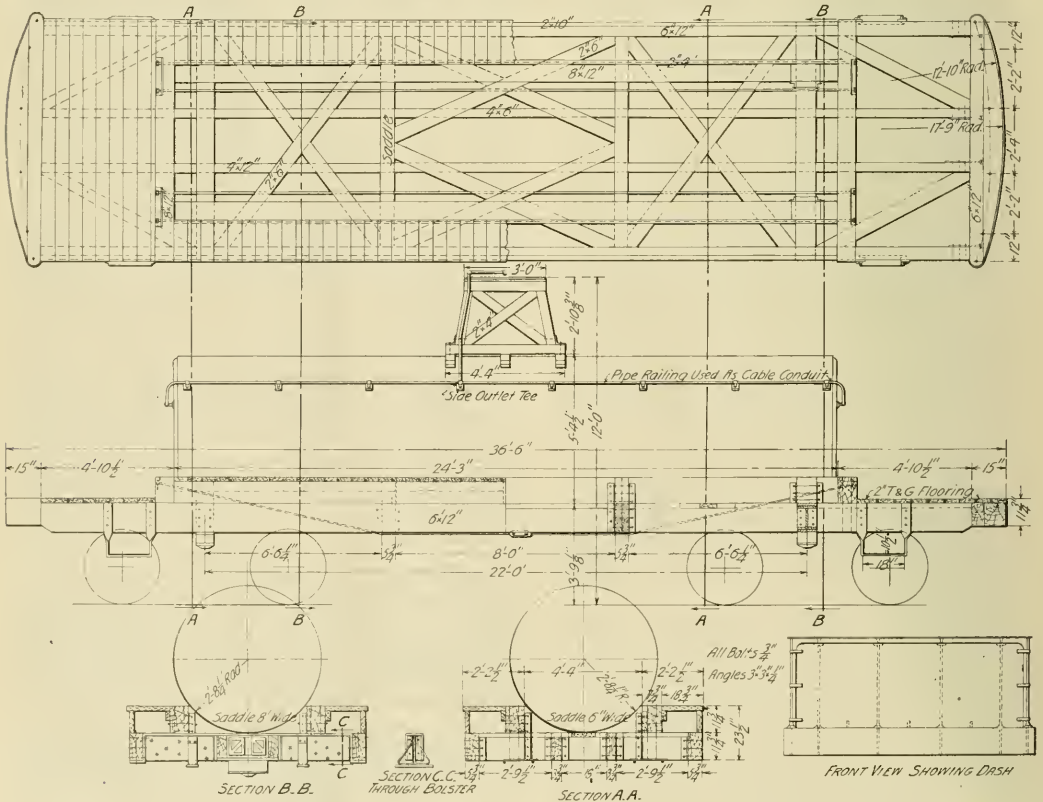

Oakland Traction Water Car—Floor Plan, Sectional Elevation and Cross Sections, Showing Details and Dimensions.

the accompanying illustration. This car, which is 36 feet 6 inches in diameter and 24 feet long. This steel tank rests in continuous saddles so that the load is evenly distributed

over the sills. The interior of the tank is divided by three vertical bulkheads and a horizontal surge plate of steel  $\frac{3}{4}$  inch thick.

It will be noted by reference to the halftone engraving that the car is electrically equipped, being provided with a trolley stand mounted on a framework tower supported by the tank. The cable from the trolley base passes into the pipe hand railing along the side of the tank, which serves as a cable conduit. Each end of the car is provided with a platform controller as well as air brake and hand brake control. The air reservoir is carried on one end of the platform. Four GE-1,000 35-horsepower motors are included in the electrical equipment.

#### TESTING AN OIL BURNING ENGINE.

The methods followed in a test recently made on a 500-horsepower Diesel engine illustrate the readiness with which the essential test data can be secured with an oil engine unit. In this test a belted generator had to be used as a load, and the resulting efficiency records were obtained on the kilowatt hour basis, including the losses in the mechanical transmission as well as in the generator.

The revolutions of the engine were taken with a counter, the speed variations being followed by a tachometer. The temperature of the exhaust gases, which varied from 695 degrees F. at 522 estimated brake horsepower to 372 degrees at 152 brake horsepower, was measured by mercury-nitrogen thermometers. The exhaust pipes were water-jacketed, but near the cylinders a rib of metal was left in each, uniting the inner pipe to the outer. These ribs were bored to take oil cups, and the thermometers introduced there. On the third cylinder of the engine an open tube was used, with a small stuffing box for the thermometer. Very little difference was found between the readings by these separate methods. The cooling water for the cylinder jackets, exhaust pipes and air compressors used in this type of engine was measured by a single meter, about half a pound being required per indicated horsepower per minute. The temperatures of this supply varied from 122 degrees at maximum load to 104 degrees at minimum output, with an initial temperature of 47, all readily measured with standard feed water thermometers. The conditions of the test did not permit of the separate measurement of the quantity of cooling water supplied to each jacket, so that the heat absorbed from the exhaust pipe gases could not be ascertained. This is a minor figure, however. Attempts were made to measure the discharge from the jacket waste pipes by small vessels placed on scales, but the results were not satisfactory.

In the test, the mean effective pressures were calculated from indicator diagrams taken at intervals of 15 minutes by indicators with external springs. The piston diameter of these was measured, and found to be practically correct. The springs were tested by dead weights, and the necessary corrections made in the mean pressures calculated from the diagrams.

The terminal efficiency of the engine figured from 42 to 47 per cent, and the consumption of crude oil of 18,000 British terminal units per pound per estimated brake horsepower hour was .449 pounds at 522 brake horsepower; .484 pounds at 249 brake horsepower, and .568 pounds at 152 brake horsepower. The friction losses were obtained by making electrical measurements of the power absorbed by the loaded generator, and deducting the power absorbed by the compressors used in forcing air into the engine cylinders at the compression stroke. The CR losses were obtained directly at one-quarter load, and estimated for the larger outputs. The iron and friction losses of the generator were obtained by running it as a motor without the belt, the field current being adjusted to give normal speed, the voltage at which the current was supplied being the full normal potential generated by the ma-

chine. These losses at full load were about 23 kilowatts. The engine and belt friction losses varied from 134 horsepower at quarter load to 149 horsepower at full output. This difference was probably due to a change in adjustment required by the failure of a belt during the tests.

The oil used was weighed and chemically analyzed. The calculated calorific power was 18,823 British terminal units per pound. The exhaust gases were analyzed by an Orsat apparatus, the samples being taken directly into the measuring tube by a pipe connected with the three exhaust pipes, in which a current was maintained by a water pump. At full load these gases showed 81.9 per cent nitrogen, 10.4 per cent oxygen, 0.1 per cent CO, and 7.6 per cent CO<sub>2</sub>. At half load the oxygen increased and the CO<sub>2</sub> decreased about 50 per cent, there being no CO under full load.

Practically the only outside expert knowledge required in a test like this is in connection with the chemical analysis of the fuel, and the cost for a calorific determination on that basis, including the analysis, accurate to one per cent at least, should not exceed \$15. Any company operating with an oil engine of one or two hundred horsepower up ought to own the necessary indicators and thermometers for regular observation of the machine's performance, as well as a flue gas analyzing apparatus. Only by close test and service analysis can the high economy of the internal combustion engine be kept at its best.

#### ANNUAL MEETING OKLAHOMA ASSOCIATION.

The second annual convention of the Oklahoma Electric Light, Railway and Gas Association was held at Guthrie, Okla., on May 25, 26 and 27, with a large number of delegates in attendance. The meeting was called to order by President F. H. Tidnam, after which the following programme was presented.

##### MONDAY.

"Necessity of Public Service Utilities," Gov. Charles N. Haskell.

Address of welcome, Mayor C. M. Barnes.

Response, R. N. Gascho.

President's annual address.

Minutes of the last convention.

"Light and Illumination," C. M. Jansky.

##### Street Railways.

"Construction in Oklahoma," Charles W. Ford, general superintendent Oklahoma Railway, Oklahoma City.

"Operating," O. W. Weddle, superintendent Shawnee-Tecumseh Traction Company, Shawnee.

Practical question box, conducted by R. P. Sauerhering.

Demonstration and explanation by exhibitors.

##### TUESDAY.

"Installation, Maintenance, Testing, Care of Meters," R. P. Sauerhering.

"Economic Operation of Small Plants," R. N. Gascho.

"Feasibility of Pay-As-You-Enter Cars," William Busby.

##### Gas.

"Light and Heat," R. O. Deming.

"Distribution," H. C. Nelson.

##### Power.

"Small Motors," F. W. Caldwell.

"Large Motors," Galen Crow.

##### Fuel.

"Coal," H. H. Stephens.

"Oil and Gas," Ed J. Reynolds.

Answers to question box.

Grand rejuvenation and smoker, Sons of Jove.

##### WEDNESDAY.

"Commercial Relations Between the Central Station and the Customer," Fred J. Bedford.

"Relation Between the Public Service Utilities and the Public," Hon. H. M. Scales.

The meeting concluded with a closed session for active members only and the election of officers. Afterward the members were given a trolley ride over the city of Guthrie and an air dome entertainment in the evening ended the convention.

SINGLE AND DOUBLE CRANE CARS AT BALTIMORE.

The two crane cars shown in the accompanying illustra-

that it also may be used for hauling track materials. The electrical equipment, designed for double-end operation, comprises four Westinghouse No. 49 motors and a 24-foot capacity air compressor with its governor set to maintain 85 pounds pressure on the tanks. Extra large tank capacity is carried so that there may be an ample supply of air for operating the cranes.

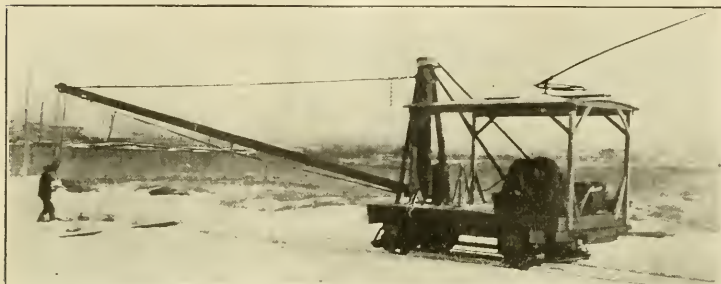

Baltimore Crane Cars—Boom 35 Feet Long, Lifting Capacity 2,000 Pounds.

The smaller crane car has a boom 25 feet long and a mast with anchors designed so that a load of 2,000 pounds may be lifted at the end of this boom, when swung at right angles to the track. The mast is 10 feet high and is built directly on a steel frame carried on two axles spaced nine feet apart. To each axle is geared a Westinghouse No. 3 motor and on the platform of the car is a hoist-

tions were built at the shops of the United Railways & Electric Company, Baltimore, and are put to various uses on that system. It will be noted that one of these cars is provided with two cranes of short reach; the other has a single boom of long reach.

ing drum geared to a 12-A motor. This car is found very useful in handling 60-foot rails, as well as other forms of

An illustration reproduced from a line drawing exhibits the general dimensions of the crane car which is provided with two booms. Each of these booms is eight feet long and carries on an inclined strut an air cylinder with a stroke of about three feet. On 85-pound pressure in the cylinder each crane has a lifting capacity of 2,000 pounds, for which loading the swinging booms were designed. The crane posts are made of 8-inch pipe and the braces are hydraulic tubing inclosing 1-inch rods, this combination being designed to take both compression and tension stresses, according to the working position of the boom.

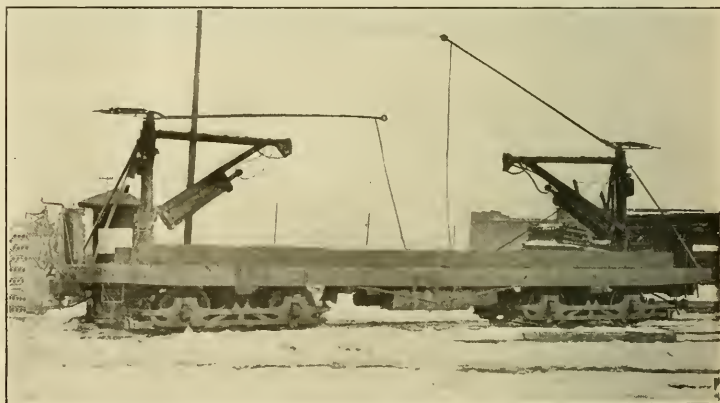

Baltimore Crane Cars—Work Car with Two 2,000-Pound Cranes.

The car body is 41 feet long over all and 8 feet 3 inches wide. With the two cranes, one

heavy construction material which it is desirable to handle.

About 20 persons are said to have been injured in a rear-end collision of three trolley cars on the Brooklyn bridge, New York, on May 22. The three cars were wrecked and

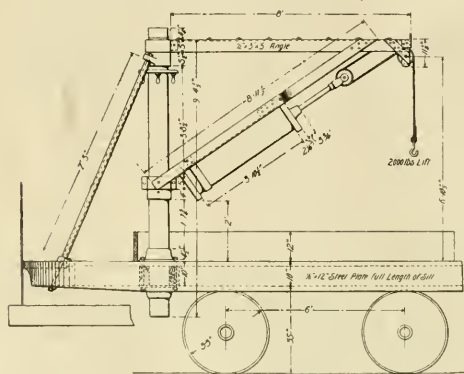

Baltimore Crane Cars—General Dimensions of Car with Two Booms.

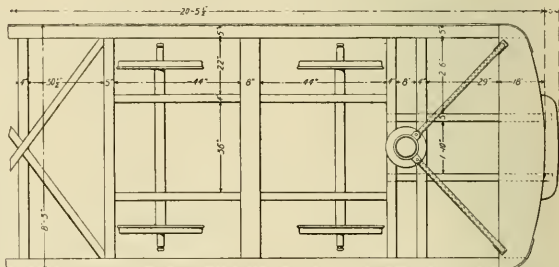

on either end of this car, it is easily possible to handle rails and special track work. The car is built with low sides so

traffic was delayed for about an hour. Slippery rails are said to have been the cause.



## COMBINATION RAILWAY, TELEPHONE AND LIGHTING POLES.

Paul Spencer presented before the National Electric Light Association, at Chicago on May 19, specifications for line construction on poles jointly used. He said in part with regard to railway attachments as follows:

Where the railway construction is of a type in which the trolley wire is supported by spans attached to two separate lines of poles, and these two lines of poles are to be used for the attachments of the lighting, railway and telephone companies, it is always preferable that the lighting, power and railway lines should be carried on one line of poles, and that the telephone lines should be carried on the other line of poles.

Where the railway attachments and the telephone attachments are carried on one and the same line of poles, the railway feeders and attachments shall occupy a position on the pole below that occupied by the telephone crossarms. If the poles carry also lighting and power attachments, these shall occupy the upper position on the pole and above the telephone attachments.

Where span wires and brackets for supporting or holding trolley and guard wires are attached to poles jointly used, the attachment shall be made as follows:

The span wires and supporting brackets may be attached to the pole at a height convenient for the railway operation.

The span wires and brackets may be attached to the pole by bolts passing through the pole.

Every span wire and bracket supporting trolley wires shall be effectually insulated from the railway potential.

The railway feeders on poles jointly used shall be carried on crossarms located on the pole approximately at the point of attachment of the supporting trolley span or bracket.

Where telephone attachments are located above such feeders, a horizontal distance of not less than 24 inches shall be maintained between the pole pins on the crossarms carrying the railway feeders.

On poles carrying railway attachments the lowest telephone crossarm shall be at least two feet above any part of the brackets or span wires supporting the trolley wire and shall also be above the nearest railway crossarm by a distance not less than 40 inches.

Signal boxes, switches, cutouts and similar railway apparatus may be installed on the pole at the point necessary for convenient operation, provided that they shall not be installed in such a manner as to interfere with the employees of either company in climbing the pole or to prevent the installation of vertical runs. When located below telephone lines or attachments, they shall be of a type in which all live parts are covered and protected from accidental contact.

Railway signal line wires, run on jointly used poles and below telephone attachments, shall be installed so as to provide a climbing space through them of not less than 24 inches.

Connecting wires to such railway apparatus, run down the pole, shall be insulated and shall be attached to the street side of the pole, and maintained at a distance of not less than five inches from the surface of the pole.

Whenever poles used by the railway company are too low to permit, under the terms of this specification, the attachment thereto by the telephone company of crossarms for carrying their wires, the telephone attachments which may be made shall consist only of twisted pairs, or a single telephone cable.

Where only one such twisted pair is used, it may be carried on an insulator on the top of the pole, or on a side bracket.

Where more than one twisted pair is carried along the line of poles, the pairs shall be bunched together throughout their length and attached at or near the top of the poles. In no case shall the pairs so carried exceed ten in number.

Where the telephone cable is attached to such poles it shall not exceed 1½ inches diameter, and shall be placed at or near the top of the pole.

The attachment of twisted pairs or of telephone cable, as above, shall be so made as not to restrict the proper use of the pole by the railway company, and the railway company may use its standard methods of construction in installing its feeders, span wires, brackets, switches and any other appliances on such poles.

Excepting where otherwise specified, every electric light and railway line wire and connecting wire shall be covered with at least a standard triple-braided weatherproofed insulation.

The Gary & Interurban Railway began operating on May 20 the first section of its street railway line in Gary, Ind., about 2½ miles long, extending from the Calumet river to the steel mills.

## News of the Week

### Transit Affairs in New York.

A. W. McLimont, electrical engineer of the public service commission, has submitted a report on the work done by the New York City Railway in overhauling its summer cars. Mr. McLimont says that the receivers of the company have been quick to respond to suggestions made by the commission's inspectors, that the work is progressing favorably and that the cars are being put into the best condition possible.

The commission issued an order on May 22 to the Interborough Rapid Transit Company to begin work on the contemplated rearrangement of the subway tracks between Ninety-sixth street and One Hundred and Third street, which is expected to relieve much of the congestion between these points by eliminating the necessity of crossing the express trains over the local tracks.

Governor Hughes has signed the Frawley bill, which gives the public service commission and the board of estimate authority to open negotiations for acquiring for the city the Belmont or Steinway tunnel under the East river at Forty-second street. In a memorandum the governor says that this is a power which the city should possess, but that whether it should be exercised depends on the terms that can be made.

The Robinson bill, making general amendments to the rapid transit law designed to facilitate subway building in New York by offering more attractive inducements to private capital, died on May 24 with the expiration of the 30-day period without receiving the governor's signature. The salient feature of the bill is the provision for the sale of the franchise to construct and operate subways, with a reservation to the city of the right to purchase at the expiration of a fixed period, not to exceed 50 years. The governor made public a 1,200-word statement, giving his reasons for vetoing the bill. He said that the plan proposed by the bill is illusory and injurious, because, although it did not necessarily prevent construction by the city, if the bill became a law its practical effect would be that no construction at public expense would be undertaken until every available means to secure construction by private capital had been exhausted.

The governor also vetoed the fare bill, which provided for a 5-cent fare to Coney Island unless the public service commission authorized a higher rate of fare. The governor's failure to approve the bill was due to his conviction that the public service commission has ample power to regulate the fare.

### New York Traction Investigation Concluded.

The New York public service commission of the first district closed on May 21 the investigation of the affairs of the traction companies of the city, which was started on July 18 last, but which was interrupted in October. Since then William M. Ivins, the special counsel, has had a large staff of experts examining the books of the various railroad companies of the city and the result was read into the minutes. These reports comprise more than a thousand pages of type-written matter and as Mr. Ivins explained to the commission they really make up a history of the various companies from the time of their inception until the present day. The data presented to the commission by Mr. Ivins went into every detail of the financial reorganizations of the different companies until they were merged into the Metropolitan system, which was in turn gathered into the Interborough system. In presenting the reports to the commission Mr. Ivins said:

"I believe that the objects for which the resolution of July 18 was passed have now been practically attained. Your chairman, as sitting commissioner, initiated an investigation of the operating condition, condition of rolling stock and other equipment and train service, of the entire transportation system of the city, and these matters have since been taken up and the work carried on by different members of the commission with practical results of great promise.

"The history of the Metropolitan Street Railway Company, the New York City Railway Company and the Metropolitan Securities Company has been investigated as exhaustively as the functions of the commission require, or permit, for the purposes for which it was created. Once the Metropolitan Street Railway system went into the hands of the receivers all financial investigation became of interest only as bearing upon questions of cost of construction, operation and maintenance and as looking to the future financial reorganization of the system. Thenceforward the commission could issue its orders only to the receivers, who in turn could only act in conformity with the general or particular instructions of the United States circuit court. \* \* \*

"When, however, these matters shall all have been judi-

cially settled and the issue of new securities shall come up for authorization the commission will not only have before it all proceedings of the court and its agents but may then profitably conduct any new or further investigation to enable it to determine its own duties in the premises.

"The enforcement of the criminal law for wrongdoing in the past, once the facts in the case were disclosed by the commission, was outside of the scope of the commission, and the investigation into the matter of the criminal responsibility, if any, for past practices has been in the hands of the grand jury and the state courts since November last."

#### Cleveland Strike.

Efforts to settle the strike of the employes of the Municipal Traction Company of Cleveland by arbitration have thus far proved fruitless and the city is still hampered by a greatly disturbed street car service, although most of the violence has been stopped. On Thursday of last week representatives of the union and President A. B. du Pont of the Municipal Traction Company agreed to submit to arbitration the principal cause of the controversy, the agreement of the Cleveland Electric Railway to increase wages two cents an hour in the event of a renewal of its franchises, but could not agree on the status of the men in case of a settlement. Mr. du Pont insisted on the strikers returning to work as new men.

Arthur E. Stearns was appointed to represent the company and Elroy M. Avery to represent the strikers. These men were to appoint a third arbitrator. Several conferences were held on Friday and Saturday in the effort to agree on the terms of arbitration and the third man to be selected. G. K. Shurtleff was named on Friday, but was unable to serve.

Mr. du Pont steadfastly refused to restore the strikers to their positions pending arbitration and maintained that the men who had remained with the company as strikebreakers had superior rights. On Saturday it was agreed to submit the question of seniority to the men. On Saturday night and Sunday morning the strikers voted to return to work as new men, temporarily surrendering their seniority rights, which were to be decided upon by the board of arbitration before taking up the labor agreement. Mr. du Pont agreed to abide by this agreement, provided the Municipal Traction Company employes agreed, but on Monday they took a vote and refused to submit their seniority rights to arbitration. This action opened up the entire question except as to the labor agreement, and at latest reports negotiations were still in progress. Several cars were dynamited on Thursday and Friday and several people were injured by the violence of the strikers and their sympathizers, but since the negotiations have reached a favorable stage disturbances have been rare, although the service has been very irregular, especially in the suburbs. Twelve men were arrested on Monday, charged with having been implicated in the wrecking.

Representatives of the strikers have been circulating a petition, under the provisions of the new Schmidt law, asking that the security franchise to the Cleveland Electric Railway, under which the Municipal Traction Company is operating, be submitted to a referendum vote of the people. Petitions containing 24,000 names were submitted to the city council on Monday night, but no action was taken. An ordinance was introduced changing the fare provision of the ordinance from six tickets for a quarter to seven, but it was tabled.

**Wage Increases in Pennsylvania.**—The Beaver Valley Traction Company of Beaver Falls, Pa., has increased the wages of its conductors and motormen to 20, 21 and 22 cents an hour for the first, second, third and succeeding years, respectively. The Washington & Canonsburg Railway has also increased its wage scale to 19½, 20½ and 21½ cents an hour.

**American Association Bulletins.**—Bernard V. Swenson, secretary of the American Street and Interurban Railway Association, 29 West Thirty-ninth street, New York, is issuing to member companies a supplement to Bulletin No. 101, entitled "Confidential Information Concerning Wages of Conductors and Motormen," which contains some valuable figures regarding the cost of platform labor; also Bulletin No. 103, entitled "Confidential Information Concerning the Relation Between Operating Expenses and Gross Receipts on a Percentage Basis for Interurban Lines."

**Accident in Philadelphia.**—A serious accident occurred in Philadelphia on May 24, when two crowded cars of the Philadelphia Rapid Transit Company collided on a steep grade. Forty-five persons were injured sufficiently to be taken to hospitals, three were killed and five more are said to have been fatally injured. The accident was caused by a northbound car on the Germantown avenue line near Chestnut Hill leaving the track while going down a steep grade and swinging over to the southbound track, where it collided with a car ascending the hill.

# Traffic and Transportation

## Fare Contracts with Municipalities Upheld by Indiana Commission.

In decisions upon cases concerning the Indiana Union Traction Company and the Indianapolis Columbus & Southern Traction Company, the Indiana railroad commission holds that an ordinance granting the right to an interurban road to operate on city or town streets and fixing the fare for service in the municipal territory constitutes a contract when acted upon by the company, and that such a contract is entitled to the protection furnished by the United States constitution and cannot be impaired by subsequent legislative enactments.

In April last complaint was made to the commission that a passenger was charged 10 cents by the Indiana Union Traction Company for passage on its limited interurban car between Fortville and Ingalls, a distance of 2.84 miles. At the same time complaint was made by another passenger that he had been charged 10 cents for passage on the Indianapolis Columbus & Southern Traction Company between Station No. 68, Short's Road and Seymour, a distance of 2.5 miles.

The facts in the complaints were submitted to the carriers interested and their counsel filed briefs with the commission, which presented questions for consideration as follows:

"Does the act approved February 25, 1907, establishing a maximum passenger fare of 2 cents per mile, apply to interurban railroads? If the act does apply to interurban lines, may they not charge an excess fare for service on their limited cars, which are better equipped, more convenient and make better time, than their local cars? Ingalls, Fortville and Seymour are each incorporated, and the traction companies operate on their streets. When their respective franchises were granted the traction company in each instance was given permission to charge 5 cents for a single passenger fare within the corporate limits. These franchises were granted and accepted prior to the enactment of the maximum rate law above mentioned."

"It is claimed," the commission says in its opinion, "that in the first case the Indiana Union Traction Company could charge 5 cents for its service in Ingalls, 5 cents for its service in Fortville and 5 cents for its service between these towns and yet be within the provisions of the maximum rate law, and it is likewise contended that the Indianapolis Columbus & Southern Traction Company could charge 5 cents for its service in the city of Seymour and a like sum for its service between Seymour and stop No. 68."

The commission found as to the first two propositions that it was not necessary at this time to express its views in this investigation, and therefore left the question open for further consideration, if occasion should require. The commission's decision was on the third point.

"The rule declared by the supreme court of the United States," the commission says, "which is the final authority on this question, seems to be uniform and to cover the questions raised by the third proposition above stated, and to decide the same in favor of the contention of the interurban lines. By these decisions we are bound and cheerfully abide, not only because they state the law, but are, as applied to this inquiry, seemingly fair and just.

"The commission being of the opinion stated as to the law applicable to this inquiry it results in our holding as we do that there was no violation of the law in the cases under investigation."

The opinion was written by Commissioner C. V. McAdams.

**Petition for Trolley and Freight Franchise in Massachusetts.**—The Springfield & Eastern Street Railway of Palmer, Mass., has filed a petition with the Massachusetts railroad commission for permission to take a trolley express and freight business in and through the town of Palmer. This petition is substantially an appeal from the decision of the selectmen of Palmer that it would be against the wishes of the residents of that town to grant a franchise for this privilege for more than five years.

**Richmond Transfer Ordinance Enjoined.**—On petition of the Central Trust Company of New York the United States district court at Richmond, Va., has issued a temporary injunction restraining the city authorities and the Virginia Passenger & Power Company from putting into effect the universal transfer ordinance recently passed by the council. All parties are directed to appear on June 29 to show cause why the injunction should not be made permanent. The trust company states that the effect of the proposed increase of transfers would be to greatly decrease the receipts, which are at present insufficient to pay fixed charges.

# Construction News

## FRANCHISES.

**Atlantic City, N. J.**—John L. Clawson, receiver of the Atlantic City & Suburban Traction Company of Pleasantville, N. J., has made a proposal to the property owners of Atlantic City that if the city will grant him franchises for electric lines in Pacific and Arctic avenues he will build an electric line to Philadelphia.

**Faribault, Minn.**—An ordinance has been passed granting to the Minneapolis St. Paul Rochester & Dubuque Traction Company a 25-year franchise for entrance to Faribault. An extension will be built from Faribault to Shieldsville through Roberts, French and Shieldsville lakes.

**Flat Rock, Mich.**—The town council has granted a franchise to the Toledo Ottawa Beach & Northern Railway Company for the operation of its proposed extension to Detroit through the village of Flat Rock. It is stated that a private right of way will be donated by the village if the northerly route serving Flat Rock is chosen by the company in preference to the other, which would pass some distance south of the village.

**Martinez, Cal.**—A. W. Malthy and Joseph Naphaly have been granted permission by the board of county supervisors to construct and operate an electric railway through the Alameda and Contra Costa tunnel.

**Paducah, Ky.**—The Paducah & Cairo Interurban Railway Company has been granted a franchise to build its line in Paducah. The line will extend from Paducah to East Cairo, Ky., where it will connect with ferry boats operating between East Cairo and Cairo, Ill.

**Portland, Ore.**—The United Railways Company has been granted a franchise for its proposed extension from Portland to Hillsboro by way of Mt. Calvary cemetery. A condition of the franchise prohibits the operation of any cars on the system until the line has been completed to Hillsboro and Mt. Calvary.

**Wilmington, Del.**—A franchise has been granted to the People's Railway Company for an electric line on Church street from Seventh to Fourth streets, affording connection with the boats of the Wilmington Steamboat Company. (Noted March 21.)

**Sacramento, Cal.**—W. T. Garrett of San Francisco has applied for a franchise to build an electric railway around Oak Park, six miles long.

## RECENT INCORPORATIONS.

**Charleston & Casey Traction Company, Charleston, Ill.**—Incorporated in Illinois to construct an electric railroad from Charleston, Coles county, to Casey, Clark county, Illinois.

**Kokomo Frankfort & Terre Haute Traction Company, Kokomo, Ind.**—Incorporated in Indiana to build an electric railway 104 miles long, serving the towns of Kokomo, Frankfort, Crawfordsville, Rockville, Rosedale, Burlington and Terre Haute. It will parallel the Chicago Cincinnati & Louisville from Kokomo to Frankfort and from Frankfort to Terre Haute will parallel the Vandalia. Capital stock, \$100,000. Incorporators: W. H. Eikenberry, W. F. Newby, Russiaville; Oliver Gard, James Kent, Frankfort; M. W. Eikenberry, J. C. Dewees, E. B. Swift, R. H. Cross, Kokomo; A. E. Alter, Forest, Ind. (Noted April 11.)

**Myersdale Construction & Equipment Company, Pittsburg, Pa.**—Incorporated in Pennsylvania to construct, maintain and operate electric railways. Capital stock, \$100,000. Incorporators: H. D. Brenn, W. A. Wood, Pittsburg; W. W. Staud, Bellevue, Pa.

**Parkersburg Bridge Company.**—Incorporated to build a bridge over the Ohio river between Parkersburg, W. Va., and Belpre, O. After the bridge has been completed the company intends to start preliminary work on the construction of a system of interurban railways which will connect Pittsburg, Pa., and Cincinnati, O., the first section being from Pomeroy to Gallipolis, Collville and Columbus by way of Logan and Lancaster, O. Application has been made to the government to build the bridge and work will be started as soon as permission is obtained. Capital stock, \$400,000. Incorporators: Jason H. Brooks, Joseph G. Lee, Samuel C. Williams, Charles Newell and James Newell of East Liverpool, O.

**Union Traction Company.**—Incorporated in West Virginia to build an electric railway from a point on the dividing line between Wetzel and Marshall counties to New Martinsville,

Brooklyn, Paden City and Sistersville and from there to St. Mary's in Pleasant county. Capital stock, \$150,000, of which \$50,000 has been paid in. Incorporators: H. W. McCoy, G. E. Work, S. G. Messer, R. Broadwater, Sistersville; J. D. Morgan, E. L. Robinson, New Martinsville, W. Va.

## TRACK AND ROADWAY.

**British Columbia Electric Railway, Vancouver, B. C.**—This company is receiving bids for the construction of the first section of its proposed Westminster-Chilliwack electric line. This section is 12 miles long and will connect Westminster and Cloverdale. R. H. Sperling, general manager, Vancouver, B. C. (Noted March 14.)

**Canadian Valley Railway, Mutual, Okla.**—E. O. McCann, secretary of this company, which proposes to build 150 miles of interurban lines connecting Ft. Supply, Woodward, Mutual, Seiling, Canton, Geary, El Reno and Oklahoma City, states that construction work will be started this fall. The road was incorporated in April with a capital stock of \$2,000,000. Thomas Martin, president; E. O. McCann, secretary; L. A. Foster, treasurer, Mutual, Okla. (Noted May 16.)

**Cherokee Belt & Interurban Railway, Tulsa, Okla.**—This company is making preliminary surveys for its proposed line connecting Skiatook, Collinsville, Claremore and Prior Creek, Okla., a distance of 45 miles, and construction work is expected to be started about October 1. The company was recently incorporated with a capital stock of \$500,000. Officers: President, E. Batchman, St. Louis; vice-president and general manager, F. E. Montel, Kansas City, Mo.; secretary, J. R. Caudley, Collinsville; treasurer, E. Pease, Collinsville; superintendent, Arthur E. Leap, Collinsville.

**Chicago South Bend & Northern Indiana Railway, South Bend, Ind.**—The contract for ballasting and laying track for this company's extension from South Bend to La Porte, Ind., has been let to the St. John Engineering Company of Chicago, Ill. Samuel Riddle, general manager, South Bend.

**Cleveland Southwestern & Columbus Railway, Cleveland, O.**—The Cleveland Construction Company has just placed a large force of men at work on the 15-mile section of this road between Ashland and Mansfield, O., with the expectation of having it completed in time to care for the Fourth of July traffic. When this section has been completed the company will proceed to build from Mansfield to Mt. Vernon. C. N. Wilcoxon, general manager, Cleveland. (Noted February 22.)

**Indianapolis Cloverdale & Terre Haute Traction Company, Indianapolis, Ind.**—We are officially advised that E. M. Bowman, president, has secured 30 miles of right of way and the franchises at Mooresville and Cloverdale, Ind., for the proposed line from Indianapolis to Terre Haute, Ind., and that surveys were started on May 25. Harry C. Sandusky, consulting engineer, 413 State Life building, Indianapolis, is chief engineer. (Noted April 25.)

**Indianapolis Frankfort Delphi & Chicago Traction Company, Frankfort, Ind.**—W. H. Cohee, vice-president and general manager, writes that this company proposes to build an electric railway from Frankfort to Hammond, Ind., 120 miles, via Delphi, Monticello, Monon, Rensselaer and Cedar Lake. Surveys have been completed from Frankfort to Delphi, 27 miles, and contracts for all work and materials for this section are to be let about June 20. The company has water power rights at Pyrmont, Ind., which will develop power for the road from Frankfort to Delphi as well as for commercial purposes, also on the Tippecanoe river at Monticello, which will furnish power for the line to Chicago. Seventy-pound rails will be used and curves and grades are light. Officers: Abe S. Straus, 181 La Salle street, Chicago, president; Bert Willis, Frankfort, secretary, and Charles E. Hyman, Chicago, treasurer; J. R. Brown, Frankfort, chief engineer. (Noted May 9.)

**Iowa Railroad, Eldora, Ia.**—George Welsby Scott, consulting engineer, Chicago, Ill., has started final surveys for this proposed interurban electric line, which will connect Waterloo, Cedar Falls, Fredsville, Dike, Lincoln, Grundy Center, Eldora, Hubbard, Garden City, Story City, Ames, Boone, Moingona, Perry, Kelley, Huxley, Ankeny and Des Moines, Ia. The overhead trolley system will be used and power for commercial purposes will be furnished to the towns en route. The power plant and repair shops will be located at Eldora. Andrew Stevenson, first vice-president and general manager, 1211 Association building, Chicago, Ill. (Noted April 18.)

**Joplin & Pittsburg Railway, Pittsburg, Kan.**—The contract for erecting poles and wiring between Joplin, Mo., and Pittsburg, Kan., has been awarded to the Smith, Hurst & Allen Company of Philadelphia. A. L. Register & Co. of Philadelphia have the general contract.

**Long Island Railroad, Brooklyn, N. Y.**—This company is making preliminary surveys for the proposed electric railway loop to connect Hempstead, Freeport, Uniondale and Roosevelt, about five miles. Two-thirds of the right of way for the line has been offered to the company provided construction is started in the near future. The road will pass north from Freeport east of the New York & Long Island Traction line, will give railroad facilities to Roosevelt and Uniondale, not at present served, and will enable the company to abolish the terminal at Hempstead, permitting through train service from and to New York. It will also afford direct communication with Long Beach. J. H. Savage, chief engineer Long Island Railroad, Jamaica, N. Y.

**New York, N. Y.**—The New York public service commission of the first district on May 22 awarded contracts for five of the six sections of the Brooklyn Fourth avenue subway as follows: Contract No. 2, extending from Willoughby street to Ashland place, William Bradley—railroad work, \$3,436,019; pipe galleries, \$58,695; total, \$3,494,714. Contract No. 3, extending from Ashland place to Sackett street, William Bradley—railroad work, \$3,392,091.50; pipe galleries, \$208,135; total, \$3,600,226.50. Contract No. 4, extending from Sackett street to Tenth street, E. E. Smith Contracting Company—railroad work, \$2,283,553.30; pipe galleries, \$206,672; total, \$2,490,205.30; Contract No. 5, extending from Tenth street to Twenty-seventh street, The Tide Water Building Company and Thomas B. Bryson—railroad work, \$1,945,640.50; pipe galleries, \$251,076; total \$2,196,716.50. Contract No. 6, extending from Twenty-seventh street to Forty-third street, E. E. Smith Contracting Company—railroad work, \$2,808,982.80; pipe galleries, \$173,665; total, \$2,982,647.80. This amounts to \$14,764,510 for the five sections, or \$13,866,267 for railroad work and \$898,243 for pipe galleries. In every case the contract was awarded to the lowest bidder. Contract was not let for the first section. The awards must be approved by the board of estimate.

**Seattle-Tacoma Short Line, Seattle, Wash.**—This company has awarded contracts for the construction of its proposed 30-mile line from Seattle to Tacoma to A. D. McInnes of Seattle. The company was incorporated last fall with a capital stock of \$6,000,000 to construct a double-track line between the two cities. Merle J. Wightman, American Bank building, Seattle, is general manager. (Noted October 19, 1907.)

**Seattle (Wash.) Electric Company.**—Construction work has been started on the extension to Alki Point.

**Southern Traction Company, Belleville, Ill.**—This company, which is building an electric railway from East St. Louis to Belleville, Ill., has filed notice of an increase of capital stock from \$2,500 to \$1,500,000.

**South Morgantown Traction Company, Morgantown, W. Va.**—The contract for the construction of the 2-mile extension of this line has been awarded to Frank Alfery of Morgantown. Estimated cost, \$60,000. C. D. Willey, general manager, Morgantown.

#### POWER HOUSES AND SUBSTATIONS.

**Cleveland Southwestern & Columbus Railway, Cleveland, O.**—Three substations are now under construction by this company and a portable substation has been completed in readiness for the operation of the extension of this line from Ashland to Mansfield, O., which it is expected will be completed by July 4.

**Portland Railway Light & Power Company, Portland, Ore.**—Construction will be started at once by this company on a new substation at Northern Hill, near St. Johns. The station will be built so that it can be enlarged at any time and when completed will serve the Swift packing plant. F. G. Sykar, Portland, Ore., general manager light and power.

**United Railroads of San Francisco.**—Contracts have been let by this company for additional power equipment for installation in its North Beach power house to cost approximately \$375,000. The equipment will consist of a Curtis steam turbine direct connected to a 5,000-kilowatt General Electric three-phase 13,200-volt generator, and a new boiler of 3,000 horsepower capacity. A part of the equipment has been received and the remainder is expected in time to have the installation completed inside of two months. (Noted May 23.)

**Valley Power Company.**—It is stated that this company, recently incorporated in Oregon to build an electric railway from West Woodburn through Monitor to Scott Mills and on to Willhoit Springs, and the Wenatchee Canal Company, operating in the Wenatchee valley west of Spokane has ordered machinery to equip a 4,000-horsepower plant to be built on the Wenatchee river, four miles above Cashmere, Wash. Power will be generated for the operation of the proposed electric lines and for irrigating purposes. Frank Robertson, Portland, Oregon, is interested. (Noted May 9.)

## Personal Mention

Mr. A. R. McLean has been appointed superintendent of the Freeport (Ill.) Railway Light & Power Company. For the past seven years Mr. McLean has been engaged in street railway and interurban secret service work.

Mr. Clarence Coburne, until recently train dispatcher for the Norfolk & Atlantic Terminal Company at Norfolk, Va., has been appointed superintendent of the Berkley division of the Norfolk & Portsmouth Traction Company, effective at once, succeeding Mr. W. E. Davis, resigned.

Mr. Benjamin E. Tilton, whose resignation as engineer of maintenance of way of the Cleveland Electric Railway was announced in the Electric Railway Review of May 16, has been appointed to a similar position with the Rochester Railway Company at Rochester, N. Y., effective at once.

Mr. D. H. Herflicker has been appointed assistant division superintendent for the southern division of the Public Service Railway with headquarters at Camden, N. J. Mr. Herflicker formerly held similar positions with the Scranton Railway, Scranton, Pa., and the electric lines of Wilmington, Del.

Mr. R. B. Stichter, whose election as president of the Southwestern Electrical & Gas Association was noted in the Electric Railway Review of May 16, page 597, is not connected with the Dallas Securities Company, as stated, but is general manager of the J. F. Strickland Company of Dallas, Tex., which manages electric and gas properties in Bonham, Cleburne, Dublin, Hillsboro, Sherman and Waxahachie, Tex.

Mr. John Mellor, for a number of years master mechanic of the Putnam line of the Connecticut Company, has been appointed master mechanic of the Norwich, New London and Putnam lines of the company with headquarters at Willimantic, Conn. Mr. John Humphrey, who has been superintendent of overhead work on the Putnam line, has been appointed line superintendent of the Norwich, New London and Putnam lines, also with headquarters at Willimantic. By this arrangement all the lines in eastern Connecticut, including the line to Willimantic, will be under the supervision of Mr. Mellor and Mr. Humphrey.

Mr. Elmer M. White has been appointed auditor of the Coney Island & Brooklyn Railroad, Brooklyn, N. Y., effective on May 21. The duties of auditor of the company heretofore have been combined with those of the secretary and treasurer, Mr. D. B. Cannon, who will now be enabled to devote his attention to other important work. Mr. White has been engaged in the accounting departments of street railways for over 20 years, his more recent work having been with the Birmingham Railway Light & Power Company, where he was first assistant treasurer and secretary and later treasurer and auditor at Birmingham, Ala. He resigned last November to go to New York, since which time he has been engaged as consulting auditor in making special reports on a number of properties from the physical and operating as well as from the financial standpoint. Mr. White is secretary and treasurer of the American Street and Interurban Railway Accountants' Association, having held this position since January, 1904.

#### OBITUARY.

I. R. Rosenberger, the first president and one of the organizers of the Easton & Doylestown Street Railway, Easton, Pa., is dead.

William P. Boardman died recently at De Smet, S. D. Mr. Boardman superintended the construction of the old New York & Harlem Railway, one of the first street railways in America, which connected the Bowery, at that time the commercial center of New York, with Harlem, then a small suburban village. During the war he served as an engineer in the army.

#### America's Coal Lands.

As shown by a new coal area map of the United States geological survey there are about 327,000 square miles of what may be termed the more easily mined coal fields, with an estimated content available for future use of nearly 2,000,000,000,000 tons. With the maintenance of the rate of increase of coal production that has held for the past 50 years, the supply of easily available coal will, according to Director Smith of the geological survey, be exhausted before the middle of the next century. Long before the point of exhaustion is reached, the cost will have become, to most people, prohibitive.

# Financial News

**Brooklyn Rapid Transit Company.**—The New York Stock Exchange has listed \$1,375,000 additional first refunding mortgage convertible 4 per cent bonds, making the total listed \$32,557,000.

**California Gas & Electric Corporation, San Francisco, Cal.**—Under the original plan providing for exchange of the general mortgage and collateral trust 5 per cent bonds for unifying and refunding mortgage 5 per cent bonds, the date for deposit was limited to May 1. The time has now been extended to July 1.

**Camden & Trenton Railway, Camden, N. J.**—The receiver says: "The Camden & Trenton Railway does not receive enough money from the Trenton & New Brunswick Railroad to pay, and the contract should be canceled and a new agreement entered into. The Camden & Trenton road runs through a territory that is very well built up, with a large population at both ends of the line. There is no reason why it should not earn \$200,000 within one year after the track is put in good condition, one dangerous bridge removed, a few bad curves eliminated and the power improved. The following year it should earn at least 10 per cent in addition. If this work is done and the expense of operation kept to 65 per cent, there would be left for interest and taxes the second year \$77,000."

**Chicago Consolidated Traction Company.**—Notice has been given to holders of bonds of the Cicero & Proviso Street Railway, the Ogden Street Railway, the Chicago & Jefferson Urban Transit Company and the North Side Electric Street Railway that the Chicago Railways Company is prepared to buy the coupons due on May 1, 1908, on the understanding that the coupons are to be kept alive as the absolute property of the Chicago Railways Company.

**International Railway System, Buffalo, N. Y.**—Gross earnings for the quarter ended March 31, 1908, were \$1,157,628 as compared with \$1,173,170 in the corresponding quarter of the previous year. Expenses were \$759,486 as compared with \$764,830. Net earnings were \$398,142 as compared with \$408,340. The surplus, after deduction of fixed charges, was \$65,730 as compared with \$113,825.

**Menominee & Marinette Light & Traction Co., Menominee, Mich.**—This company will increase its capital stock from \$560,000 to \$1,000,000 to provide funds for additions.

**Metropolitan West Side Elevated Railway, Chicago, Ill.**—The Farwell Trust Company and N. W. Halsey & Co. of Chicago have purchased \$1,250,000 of the authorized \$5,000,000 of extension and terminal first mortgage 4 per cent bonds. The

proceeds will be used to provide for equipment notes and loans maturing on June 1.

**Northern Texas Traction Company, Fort Worth, Tex.**—Lee, Higginson & Co. and Estabrook & Co. of Boston are offering at 97½ and interest, yielding 7 per cent interest, \$500,000 of 3-year 6 per cent notes dated May 1, 1908. A letter from Stone & Webster, general managers, says regarding the property: "The proceeds of the \$500,000 notes will pay off all existing floating debt, representing the cost of permanent extensions, additions and improvements, and will leave a substantial cash balance in the treasury. All the authorized mortgage bonds are now outstanding, and no further mortgage can be placed upon the property of the company without equally securing these notes."

**Rochester-Corning-Elmira Traction Company.**—The New York public service commission, second district, has approved the issue of \$3,880,000 stock, making a total of \$4,000,000 outstanding, and \$1,210,000 of 30-year 5 per cent bonds secured by a mortgage which the commission would limit to \$6,000,000, but which the company wished to make \$8,000,000. The company has constructed and equipped the proposed double-track electric road from Rochester to Elmira. The commission has stipulated that no bonds shall be sold at less than 85 per cent of par. The bonds may be issued from time to time in installments of not more than \$1,000,000 each and only upon the entry of an order additional to the general order authorizing such issue, upon proof upon the first application that the capital stock has been subscribed by responsible parties and upon each other application showing for what purpose the proceeds of the bonds are to be used in the construction and completion of the work and the disposition made of the proceeds of previous issues of securities.

**Seattle (Wash.) Electric Company.**—A circular issued by Lee, Higginson & Co. of Boston offers for sale \$2,500,000 of consolidated and refunding mortgage sinking fund 5 per cent bonds at 93½ and interest.

**Toledo Ann Arbor & Detroit Railroad, Toledo, O.**—Judge Lockwood of Monroe, Mich., has ordered the sale of this property under foreclosure to meet claims of contractors and others. The company is at present operated by receivers, Willis Baldwin of Monroe, Mich., and R. H. Burgom of Fremont, O.

**Underground Electric Railways, London.**—Speyer & Co. of New York have made the following announcement: "Cable advices received from London state that the plan of readjustment of the Underground Electric Railways Company of London has been unanimously carried by the stockholders. It is understood that about 94 per cent of the notes have already been deposited and the success of the plan is assured."

## ELECTRIC RAILWAY EARNINGS.

	Gross earnings.	Operating expenses.	Net earnings.	Total charges.	Surplus.
Ft. Wayne & Wabash Valley Traction Company, Ft. Wayne, Ind., March, 1908.....	\$ 97,759.92	\$ 58,256.23	\$ 39,503.69		
Ft. Wayne & Wabash Valley Traction Company, Ft. Wayne, Ind., March, 1907.....	92,500.22	58,844.24	33,655.98		
Ft. Wayne & Wabash Valley Traction Company, Ft. Wayne, Ind., January 1, 1908, to March 31, 1908.....	298,235.38	172,433.33	125,802.05		
Ft. Wayne & Wabash Valley Traction Company, Ft. Wayne, Ind., January 1, 1907, to March 31, 1907.....	267,018.46	165,909.67	101,108.79		
Norfolk & Portsmouth Traction Co., Norfolk, Va., March, 1908.....	138,791.58	88,060.56	50,731.02		
Norfolk & Portsmouth Traction Co., Norfolk, Va., March, 1907.....	161,339.12	106,029.52	55,309.60		
Norfolk & Portsmouth Traction Company, Norfolk, Va., January 1, 1908, to March 31, 1908.....	415,451.90	274,961.01	140,490.89		
Norfolk & Portsmouth Traction Company, Norfolk, Va., January 1, 1907, to March 31, 1907.....	441,916.69	293,970.66	147,946.03		
American Railways Company, Philadelphia, Pa., subsidiary companies, April, 1908.....	214,239.33				
American Railways Company, Philadelphia, Pa., subsidiary companies, April, 1907.....	223,081.91				
American Railways Company, Philadelphia, Pa., subsidiary companies, July 1, 1907, to April 30, 1908.....	2,395,283.14				
American Railways Company, Philadelphia, Pa., subsidiary companies, July 1, 1906, to April 30, 1907.....	2,344,748.31				
United Railways Company of St. Louis, April, 1908.....	\$65,691.00	570,663.00	295,028.00	232,274.00	62,754.00
United Railways Company of St. Louis, April, 1907.....	884,923.00	583,039.00	301,884.00	230,892.00	70,992.00
United Railways Company of St. Louis, January 1, 1908, to April 30, 1908.....	3,327,451.00	2,203,696.00	1,123,755.00	932,437.00	191,318.00
United Railways Company of St. Louis, January 1, 1907, to April 30, 1907.....	3,379,085.00	2,305,634.00	1,073,451.00	924,627.00	148,824.00
Aurora Elgin & Chicago Railroad, April, 1908.....	97,933.56	57,377.88	40,555.68	28,330.40	12,225.28
Aurora Elgin & Chicago Railroad, April, 1907.....	101,198.26	58,493.63	42,704.63	27,587.71	15,116.92
Aurora Elgin & Chicago Rd., July 1, 1907, to April 30, 1908.....	1,156,466.86	641,509.36	514,957.50	277,722.67	237,234.83
Aurora Elgin & Chicago Rd., July 1, 1906, to April 30, 1907.....	1,080,253.91	591,016.07	489,237.84	264,897.27	224,340.57

# Manufactures and Supplies

## ROLLING STOCK.

**Aurora Elgin & Chicago Railroad**, Chicago, is in the market for 25 sets of double trucks.

**Seattle Electric Company**, Seattle, Wash., expects to purchase 20 cars in the near future.

**Walla Walla Valley Traction Company**, Walla Walla, Wash., has ordered two cars from the St. Louis Car Company.

**Utica & Mohawk Valley Railway**, Utica, N. Y., has ordered four large interurban cars from the Cincinnati Car Company.

**Omaha & Council Bluffs Street Railway**, Omaha, Neb., has ordered 10 double-truck cars. We understand the order was placed with a St. Louis builder.

**Pittsburg Railways Company**, Pittsburg, is reported to have ordered about 200 pay-as-you-enter cars for installation on its lines. This item has not been officially verified.

**Lake Erie & Youngstown Railway**, Youngstown, O., it is stated, is making an investigation of gasoline-electric cars with a view to purchasing rolling-stock of this type for equipping its road. J. H. Ruhlman is president, at Youngstown.

**Commissioner of Bridges**, James W. Stevenson, will sell at auction on June 2 at Brooklyn, N. Y., 92 passenger cars, consisting of 72 coaches equipped with cable grip and vacuum brake and 20 motor cars equipped with four 62½-horsepower motors and vacuum brake.

**Portland Railway Light & Power Company**, Portland, Ore., as reported in our issue of May 2, has placed an order with the American Car Company for 25 passenger cars of the pay-as-you-enter type. The order was placed on April 21 and will be equipped with two G.E.-58 motors and Brill 27-El trucks. The principal dimensions are as follows:

Wheel base—	Length over all—
20 cars.....4 ft.	20 cars.....45 ft.
5 cars.....6 ft.	5 cars.....47 ft. 10 in.
Length of body—	Width over all—
20 cars.....28 ft. 8 in.	20 cars.....8 ft. 3 in.
5 cars.....31 ft. 6 in.	5 cars.....8 ft. 9 in.
Over vestibule—	Height track to trolley
20 cars.....43 ft. 8 in.	base .....11 ft. 10 in.
5 cars.....46 ft. 6 in.	Body and underframe..Wood

## SHOPS AND BUILDINGS.

**Third Avenue Railroad**, New York City.—Plans have been filed by A. S. Hedman, architect for F. W. Whitridge, receiver, for remodeling the 2-story shops in East Sixty-fifth street.

**Oklahoma City El Reno & Shawnee Rapid Transit Railway**, Oklahoma City, Okla.—It is reported that this road will build a new car barn and power plants at this point. Charles A. Huber, president, Oklahoma City.

**Conestoga Traction Company**, Lancaster, Pa.—It is reported that this road has completed plans for the erection of a new car house to be of brick and steel construction and having dimensions of 117 by 400 feet.

**Springfield Consolidated Railway**, Springfield, Ill.—This company has filed plans with the building commissioner of Springfield for a new depot to be built at that point on Monroe street between Eighth and Ninth streets. The building will cost approximately \$5,000 and will have a main waiting room 40 by 60 feet.

**Utah Light & Railway**, Salt Lake City, Utah.—Erection of the car barns and other necessary buildings, for which plans were approved some time ago, will be commenced at an early date, according to a statement credited to General Manager J. S. Wells. The car barns will be one story in height, 430 by 230 feet with space for 16 tracks accommodating 144 cars. The buildings will be located on the block between Fifth and Sixth South streets and Sixth and Seventh East streets. A 2-story clubhouse, 140 by 160 feet, for the use of the employes, will also be built. The total expenditure at this point is estimated at \$600,000.

## TRADE NOTES.

**Heath & Milligan Manufacturing Company**, Chicago, which has been in the hands of a receiver since the latter part of January, has negotiations under way for transferring its stock and other assets to the National Lead Company and other creditors. F. W. Rockwell, general manager of the National

Lead Company, it is stated, will become president of the reorganized corporation, which will continue to do business under the present name.

**American Railway Appliance Company**, Wilmington, Del., has been incorporated in the state of Delaware with a capital of \$1,000,000. The incorporators are: F. M. Shive, S. E. Roberson, Harry W. Davis.

**Henry Floy**, consulting engineer, New York, announces that on the occasion of the tenth anniversary of entering upon his independent business career, he is removing to new offices at 1409 City Investing building, 165 Broadway.

**Allis-Chalmers Company**, Milwaukee, Wis., has opened an office at 319-320 First National Bank building, Birmingham, Ala., in charge of Seldon Jones as district manager. Inquiries regarding the machinery manufactured by the company will receive prompt attention at that address.

## NEW OFFICE BUILDING AND WAREHOUSE OF FAIRBANKS, MORSE & CO.

The general offices and sales departments of Fairbanks, Morse & Co. were moved in April from Franklin and Monroe streets to the corner of Wabash avenue and Eldredge place, Chicago, where the company is now comfortably settled in its new location. The new office building is a 7-story structure, with basement, fronting 165 feet on Eldredge place and 43 feet on Wabash avenue. This is the home office of the company.

The first floor will be used in displaying samples of the miscellaneous lines manufactured and sold, including Fairbanks-Morse gas and gasoline engines, electric dynamos and motors, steam and power pumping machinery, Fairbanks scales, Eclipse windmills, together with their other lines of pumps and general machinery supplies. On the second floor are located the various sales managers and departments which handle the territory of the Chicago house, including the machinery sales department, scale department, and order department. The foreign department, electrical department and billing department are on the third floor. The fourth floor is given up to the administrative officers of the company, with private offices for the president, first vice-president, second vice-president, secretary, treasurer, bookkeeping department, credit department and office of the president of Fairbanks-Morse Manufacturing Company. A general assembly room is also provided for on this floor.

On the fifth floor are located the purchasing department, windmill department and the general supply department. The sixth floor is occupied entirely by the railroad and construction departments. The seventh floor is devoted to the advertising department and is also used for the storage of stationery supplies, catalogues and other printed matter. The fact that this company publishes over a hundred different catalogues and pamphlets descriptive of their various lines, some of these in editions of several hundred thousand copies, makes it necessary to use a great part of the floor space for storing such advertising matter. Power for the elevators, pumping and lighting throughout the building is furnished by two 80-horsepower Fairbanks-Morse vertical multi-cylinder gas engines, each unit direct connected to a 50-kilowatt Fairbanks-Morse direct-current generator. These engines, located in the basement of the building, combine all the good features which are generally recognized as being necessary in the construction of a thoroughly modern gas engine. It is stated by the company that competent engineers who have seen this plant have expressed the opinion that it is the most modern and the smoothest running gas engine installation in Chicago. This will be open to visitors and parties interested in gas power are invited to call and inspect the plant. The engines operate on natural gas. The heating of the building is accomplished by means of two low-pressure Titusville boilers, each 48 inches by 16 feet and provided with the latest design of smoke-consuming devices.

The new warehouse is a 5-story brick structure, 100 by 100 feet, with track facilities on Sangamon street and an alley on the opposite side, with wagon shed. The main entrance is on Nineteenth street. The warehouse capacity has been very much increased, as it is the intention of the company to carry a much larger stock than heretofore, which will enable them to make shipments promptly and otherwise handle their fast growing business to better advantage. The company also reports that its branch houses at Denver, Omaha and San Francisco have recently been moved into the new buildings and that its Los Angeles house will move into a new building within a few months. The steadily increasing business during the past few years has made necessary the extension of its office and warehouse facilities.

## The Boilers Will be Out of Service a Much Shorter Time for Washing

thereby requiring very much less labor, to say nothing of the saving in fuel and the increased efficiency of the boilers, if the incrusting solids and other deleterious salts in the water are acted upon by *Dearborn Compounds* and their injurious properties destroyed. Send us gallon sample of your feed water for analysis.

### Dearborn Drug & Chemical Works

R.C.B.T. F. CARR, PRESIDENT

299 BROADWAY, NEW YORK      POSTAL TELEGRAPH BLDG., CHICAGO

## Titan Gears and Pinions

WILL OUTWEAR FIVE ORDINARY CUT TOOTH GEARS AND PINIONS. "TITAN" GEARS AND PINIONS MADE OF MANGANESE STEEL.

ATHA STEEL CASTING CO., Newark, N. J.

## Mechanical and Purchasing Departments

### SATISFIED WITH "KEWANEE" UNIONS

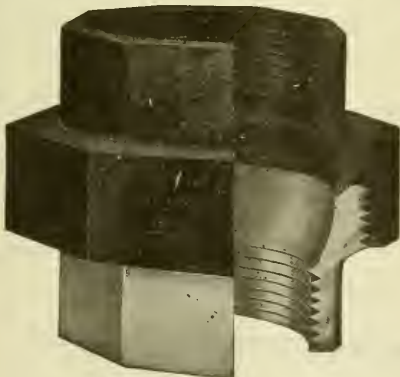

OCTAGON PATTERN

The mechanical men are satisfied because—

The thread connection is brass to iron and cannot corrode. The seat is also brass to iron and makes a tight joint without use of a gasket.

The construction is so simple—only three parts—no inserted pieces to loosen and cause leaks.

The form is octagon and common wrench will make or break connections.

The material and workmanship are the very best.

The test with compressed air under water before shipment insures perfection of each union.

The purchasing department is satisfied because—

The "Kewanee" outlasts any other union by reason of the brass to iron thread connection—disconnection and reconnection can be made indefinitely without injury. Therefore outlasts several ordinary unions.

The large brass end has a very substantial scrap value.

The cost, therefore, in the long run is considerably less than any other gasketless union.

## NATIONAL TUBE COMPANY

General Sales Offices, Frick Bldg., Pittsburgh, Pa.

### DISTRICT SALES OFFICES

New York, N. Y. Hudson Terminal Bldg.  
Chicago, Ill. Commercial Nat. Bank Bldg.  
Pittsburgh, Pa. Frick Bldg.  
Philadelphia, Pa. Pennsylvania Bldg.

St. Louis, Mo. Third Nat. Bank Bldg.  
San Francisco, Cal. Crocker Bldg.  
Portland, Ore. Wells Fargo Bldg.  
Salt Lake City, Utah. Dooly Bldg.

Denver, Colo. Majestic Bldg.  
New Orleans, La. Maison Blanche.  
Atlanta, Ga. Candler Bldg.  
Seattle, Wash. Alaska Bldg.

## THE J. G. BRILL COMPANY, PHILADELPHIA, PA.

AMERICAN CAR COMPANY, ST. LOUIS, MO.  
 G. C. KUHLMAN CAR COMPANY, CLEVELAND, OHIO  
 JOHN STEPHENSON COMPANY, ELIZABETH, N. J.  
 WASON MANUFACTURING CO. SPRINGFIELD, MASS.

MAIN OFFICE: PHILADELPHIA, PA.  
 LONDON OFFICE: 110 CANNON ST. E. C.  
 PACIFIC COAST AGENTS: PIERSON  
 ROEDING & CO., SAN FRANCISCO.  
 AUSTRALIAN AGENTS: NOYES  
 BROTHERS, SYDNEY. CABLES:  
 "BRILL," PHILA., "AXLES" LONDON.

*CARS TRUCKS SEATS RATTAN SPRINGS SPECIALTIES SUPPLIES*

## LARGEST EARNING CAPACITY

For service in cities and towns, where an entirely open car with side entrances is desirable during warm weather, no better car can be found than the Brill Convertible. Unquestionably the entirely open car is the most popular summer type and the Brill Convertible overcomes the two drawbacks of the ordinary car--no protection in bad weather and the necessity for a double equipment of cars--and provides exactly what is wanted for every day in the year. Climatic conditions, of whatever kind, are no bar to the use of the Brill Convertible Car; it is equally successful in the Northern States with their arctic winters as in the Gulf States with their tropical summers. The flexible metal panels slide into the roof pockets just as easily as the sashes, therefore any one can operate them. The Brill Convertible Car is the most practical solution of the question of how to always secure the largest amount of traffic.

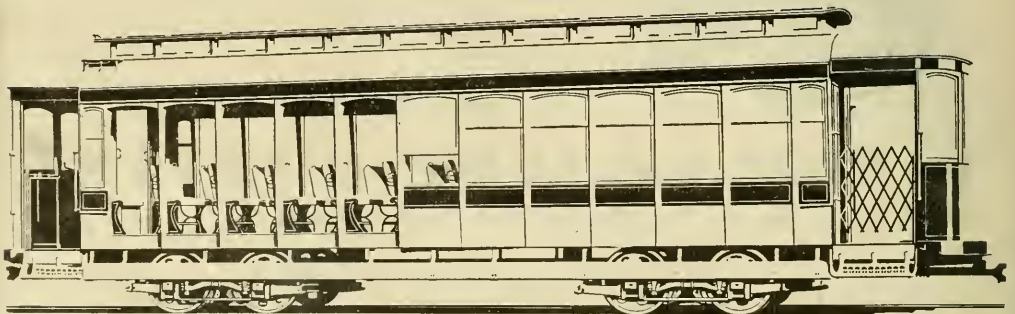

*THE BRILL CONVERTIBLE CAR (PATENTED)*



# General Electric Company

## Catenary Line Material



FIGURE 1

An effective method of anchoring the line is shown in Figure 1—both messenger and trolley wires are held secure by means of anchor hangers with bridle guying to the bracket. The guying is in the plane of the messenger and trolley wires, making impossible any pocket in which a trolley might catch.

Various devices used in catenary work are illustrated in Figure 2. They are giving notable satisfaction in a large number of installations, one of which operates over 240 miles.

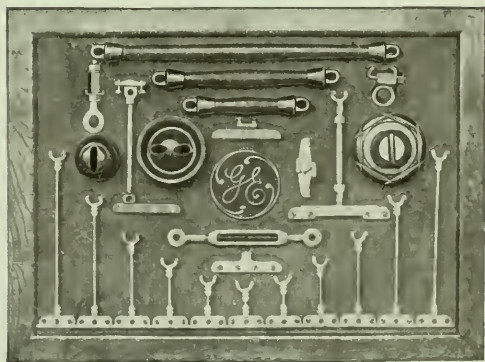

FIGURE 2

Chicago Office:  
Monadnock Bldg.

Principal Office:  
Schenectady, N. Y.

Sales Offices in  
all large cities

**FOR EVERY KIND OF MEASURING**

there's a reliable and absolutely accurate steel tape made by

**THE LUFKIN RULE CO.**  
SAGINAW, MICH., U. S. A.

New York  
London, England  
Windsor, Canada



**E. C. Van Valkenburgh**

Promotional Advertising  
for Electric Railways

2117 West 102d Street : Chicago

*A well-laid plan and Van Valkenburgh Advertising Service will make your advertising successful.*

**CONSOLIDATED CAR-HEATING COMPANY**

NEW YORK

CHICAGO

Office and Station  
Heaters

**ELECTRIC HEATERS**  
For All Classes of Cars

Independent  
Vestibule Heaters

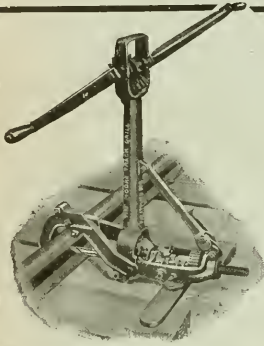

**The Moore Track Drill**

does not interfere with traffic!

The shifting of one lever and a few seconds' time takes down the drill—the operation reversed makes it ready for work again.

This is only one of the many strong points about the Moore Track Drill that make it worth buying.

*Ask for descriptive catalogue.*



**Kalamazoo Railway Supply Co.** Kalamazoo Michigan

**A Portable Bonding Car**

that will save a sum equal to its cost in six months' work. It does perfect bonding and rebonding by modern methods—

**Electric Brazing**  
AND  
**Copper Welding**



*Our definition of perfect bonding is:*

An amalgamation of rail and bond possessing greatest conductivity and longest life, produced at least cost.

*May we tell you more bonding facts?*

**THE ELECTRIC RAILWAY IMPROVEMENT COMPANY**

6005 Carnegie Ave. - - - CLEVELAND, OHIO













CARNEGIE LIBRARY OF PITTSBURGH  
3 1812 04298 4881

