

7-26-91

Vol. 56

No. 144

Friday
July 26, 1991

federal register

United States
Government
Printing Office

SUPERINTENDENT
OF DOCUMENTS
Washington, DC 20402

OFFICIAL BUSINESS
Penalty for private use, \$300

SECOND CLASS NEWSPAPER

Postage and Fees Paid
U.S. Government Printing Office
(ISSN 0097-6326)

*****5-DIGIT 48106

A FR SERIA300S NOV 91 R
SERIALS PROCESSING
UNIV MICROFILMS INTL
300 N ZEEB RD
ANN ARBOR MI 48106

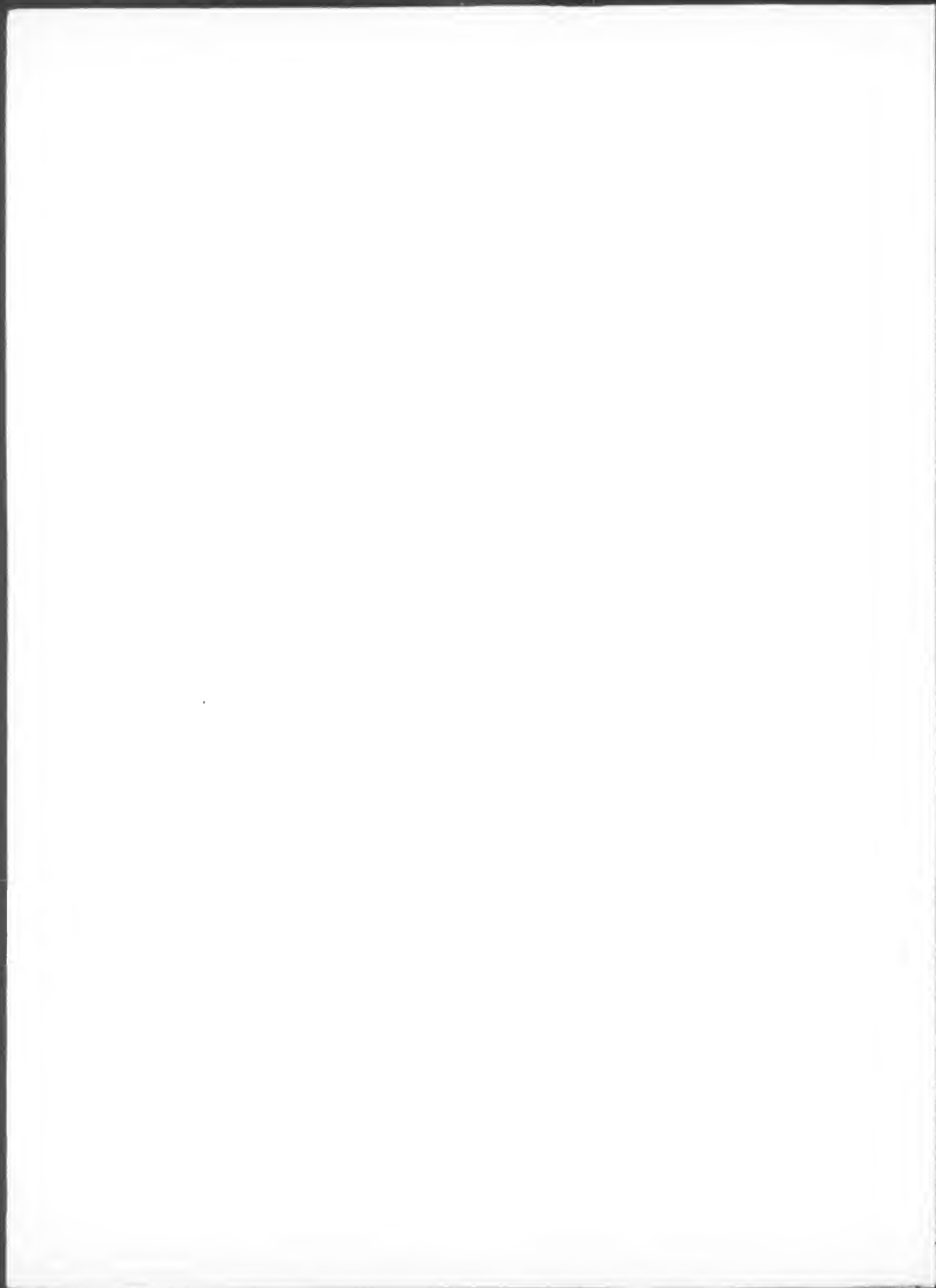

7-26-91
Vol. 56 No. 144
Pages 34141-35798

Friday
July 26, 1991

Legislative Register



FEDERAL REGISTER Published daily, Monday through Friday, (not published on Saturdays, Sundays, or on official holidays), by the Office of the Federal Register, National Archives and Records Administration, Washington, DC 20408, under the Federal Register Act (49 Stat. 500, as amended; 44 U.S.C. Ch. 15) and the regulations of the Administrative Committee of the Federal Register (1 CFR Ch. I). Distribution is made only by the Superintendent of Documents, U.S. Government Printing Office, Washington, DC 20402.

The **Federal Register** provides a uniform system for making available to the public regulations and legal notices issued by Federal agencies. These include Presidential proclamations and Executive Orders and Federal agency documents having general applicability and legal effect, documents required to be published by act of Congress and other Federal agency documents of public interest. Documents are on file for public inspection in the Office of the Federal Register the day before they are published, unless earlier filing is requested by the issuing agency.

The seal of the National Archives and Records Administration authenticates this issue of the **Federal Register** as the official serial publication established under the Federal Register Act. 44 U.S.C. 1507 provides that the contents of the **Federal Register** shall be judicially noticed.

The **Federal Register** will be furnished by mail to subscribers for \$340 per year in paper form; \$195 per year in microfiche form; or \$37,500 per year for the magnetic tape. Six-month subscriptions are also available at one-half the annual rate. The charge for individual copies in paper or microfiche form is \$1.50 for each issue, or \$1.50 for each group of pages as actually bound, or \$175.00 per magnetic tape. Remit check or money order, made payable to the Superintendent of Documents, U.S. Government Printing Office, Washington, DC 20402, or charge to your GPO Deposit Account or VISA or Mastercard.

There are no restrictions on the republication of material appearing in the **Federal Register**.

How To Cite This Publication: Use the volume number and the page number. Example: 56 FR 12345.

SUBSCRIPTIONS AND COPIES

PUBLIC

Subscriptions:

| | |
|------------------------------------|--------------|
| Paper or fiche | 202-783-3238 |
| Magnetic tapes | 275-0186 |
| Problems with public subscriptions | 275-3054 |

Single copies/back copies:

| | |
|------------------------------------|----------|
| Paper or fiche | 783-3238 |
| Magnetic tapes | 275-0186 |
| Problems with public single copies | 275-3050 |

FEDERAL AGENCIES

Subscriptions:

| | |
|--|----------|
| Paper or fiche | 523-5240 |
| Magnetic tapes | 275-0186 |
| Problems with Federal agency subscriptions | 523-5243 |

For other telephone numbers, see the Reader Aids section at the end of this issue.

Contents

Federal Register

Vol. 58, No. 144

Friday, July 28, 1991

Acquired Immune Deficiency Syndrome, National Commission

See National Commission on Acquired Immune Deficiency Syndrome

Agriculture Department

See Animal and Plant Health Inspection Service; Soil Conservation Service

Alcohol, Drug Abuse, and Mental Health Administration

NOTICES

Federal agency urine drug testing; certified laboratories meeting minimum standards, list
Suspensions, 34205

Animal and Plant Health Inspection Service

RULES

Interstate transportation of animals and animal products (quarantine):

Brucellosis in cattle and bison—
State and area classifications, 34141

Swine health protection:

Treated garbage, feeding and licensing; State lists, 34142

NOTICES

Endangered and threatened species:
Genetically engineered organisms; field test permits—
Potatoes, etc., 34168

Architectural and Transportation Barriers Compliance Board

RULES

Americans with Disabilities Act; implementation:
Accessibility guidelines—
Buildings and facilities, 35408

Blind and Other Severely Handicapped, Committee for Purchase From

See Committee for Purchase From the Blind and Other Severely Handicapped

Children and Families Administration

NOTICES

Agency information collection activities under OMB review, 34205

Commerce Department

See also Foreign-Trade Zones Board; International Trade Administration

NOTICES

Agency information collection activities under OMB review, 34169, 34170
(5 documents)

Committee for Purchase From the Blind and Other Severely Handicapped

NOTICES

Procurement list; additions and deletions, 34186, 34189
(2 documents)

Conservation and Renewable Energy Office

NOTICES

Consumer product test procedures; waiver petitions:
Armstrong Air Conditioning, Inc., 34200

Customs Service

RULES

Vessels in foreign and domestic trades:
Tonnage tax and light money payment exemption list—
Luxembourg, 34149

Defense Department

NOTICES

Agency information collection activities under OMB review, 34189

Drug Enforcement Administration

NOTICES

Applications, hearings, determinations, etc.:

Max's Distributors Corp., 34217

Sundry, Vincent A., D.O., 34218

Education Department

NOTICES

Administrative Law Judges Office hearings:

Claim compromises—
Minnesota Education Department; correction, 34243—
35405

Grants and cooperative agreements; availability, etc.:
Institutional quality control project; participation deadline and selection criteria revision, 35790

Meetings:

National Assessment Governing Board, 34189

Employment and Training Administration

NOTICES

Adjustment assistance:

CAC Microcircuits, Inc., 34221

Carborundum Abrasives Co. et al., 34222

Cooper Industries, Inc., 34224

F-Dyne Electronics, Inc., 34224

Rockwell International Corp., 34225

Tektronix, Inc., 34222

Federal-State unemployment compensation program:

Extended benefit periods—

Vermont, 34223

West Virginia, 34223

Employment Standards Administration

NOTICES

Minimum wages for Federal and federally-assisted construction; general wage determination decisions, 34220

Energy Department

See also Conservation and Renewable Energy Office; Federal Energy Regulatory Commission

PROPOSED RULES

Workplace substance abuse programs at DOE facilities
Hearing; cancellation, 35798

NOTICES

Atomic energy agreements; subsequent arrangements, 34191
(4 documents)

Floodplain and wetlands protection; environmental review determinations; availability, etc.:
Gunnison, CO; uranium mill tailings cleanup, 34190
Natural gas exportation and importation:
Puget Sound Power & Light Co., 34202

Environmental Protection Agency

PROPOSED RULES

Hazardous waste:

Identification and listing—

Coke by-products production, recovery, and refining, 35758

Superfund program:

Toxic chemical release reporting; community right-to-know—

Sulfuric acid, 34156

NOTICES

Clean Air Act:

Best available control technology "top-down" process; proposed settlement, 34202

Environmental statements; availability, etc.:

Agency statement—

Comment availability, 34203

Agency statements—

Weekly receipts, 34202

Equal Employment Opportunity Commission

RULES

American with Disabilities Act; implementation:

Reporting and recordkeeping requirements, 35753

Americans with Disabilities Act; implementation:

Equal employment for individuals with disabilities, 35726

Farm Credit Administration

NOTICES

Meetings; Sunshine Act, 34241

Federal Aviation Administration

RULES

Airworthiness directives:

Aerospatiale, 34142, 34143

(2 documents)

Beech, 34144

E.I. DuPont de Nemours & Co., 34146

Restricted areas, 34148

Transition areas, 34147

PROPOSED RULES

Transition areas, 34155

(2 documents)

Federal Communications Commission

RULES

Radio services, special:

Private operational-fixed microwave service—

Government and non-government fixed service;

frequency bands 932-935 MHz and 941-944 MHz

usage, 34149

PROPOSED RULES

Common carrier services:

Interstate special access service; expanded

interconnection, 34159

Radio broadcasting, television broadcasting, and cable

television services; political programming policies;

reasonable access, 34162

Federal Deposit Insurance Corporation

NOTICES

Meetings; Sunshine Act, 34241

Federal Energy Regulatory Commission

NOTICES

Electric rate, small power production, and interlocking directorate filings, etc.:

Washington Water Power Co. et al., 34192

Natural gas certificate filings:

Northwest Pipeline Corp. et al., 34193

Trunkline Gas Co. et al., 34197

Organization, functions, and authority delegations:

Name or address filings change; procedures, 34199

Applications, hearings, determinations, etc.:

Interstate Natural Gas Pipeline Rate Design, 34199

Federal Maritime Commission

NOTICES

Agreements filed, etc., 34204

Federal Reserve System

NOTICES

Applications, hearings, determinations, etc.:

Garwin Bancorporation, 34204

Midland Financial Corp., 34205

Fish and Wildlife Service

RULES

Endangered and threatened species:

Tennessee yellow-eyed grass, 34151

PROPOSED RULES

Endangered and threatened species:

Sensitive joint-vetch, 34162

NOTICES

Environmental statements; availability, etc.:

Stone Lakes National Wildlife Refuge, CA, 34215

Marine mammals:

Incidental taking; authorized letters, etc.—

Shell Western E & P Inc.; walruses and polar bears,

34215

Food and Drug Administration

NOTICES

Biological products:

Export applications—

Human T-Lymphotropic Virus, Type I (HTLV-I), 34205

Human drugs:

Export applications—

Kenacort A-10 and A-40, 34206

Foreign-Trade Zones Board

NOTICES

Applications, hearings, determinations, etc.:

Flite Technology, Inc.; machinery components

manufacturing plant, 34171

New York—

CPS Corp.; ink manufacturing plant, 34171

North Carolina—

IBM information processing equipment plant, 34172,

34173

(2 documents)

Health and Human Services Department

See Alcohol, Drug Abuse, and Mental Health Administration; Children and Families Administration; Food and Drug Administration; Indian Health Service; National Institutes of Health; Public Health Service

Health Resources and Services Administration

See Public Health Service

Housing and Urban Development Department**NOTICES**

Grants and cooperative agreements; availability, etc.:
Facilities to assist homeless—
Excess and surplus Federal property, 34208

Indian Affairs Bureau**RULES**

Indian school equalization program:
Administrative funds for agency and area education
offices, 35794

Indian Health Service**NOTICES**

Grants and cooperative agreements; availability, etc.:
American Indians/Alaska Natives—
Tribal management technical assistance workshops,
34206

Interior Department

See Fish and Wildlife Service; Indian Affairs Bureau; Land
Management Bureau; Reclamation Bureau

International Trade Administration**NOTICES****Antidumping:**

Oil country tubular goods from Taiwan, 34173
Roller chain, other than bicycle, from Japan, 34174
Television receivers, monochrome and color, from Japan,
34177-34180
(2 documents)

Export trade certificates of review, 34185

Applications, hearings, determinations, etc.:

Research Foundation of SUNY et al., 34186
University of—
California et al., 34187, 34188
(2 documents)
Yale University, 34188

Interstate Commerce Commission**NOTICES****Motor carriers:**

Compensated intercorporate hauling operations, 34216

Railroad operation, acquisition, construction, etc.:

Central Properties, Inc., 34216

Railroad services abandonment:

CSX Transportation, Inc., 34216

Justice Department

See also Drug Enforcement Administration

RULES

Americans with Disabilities Act; implementation:

Nondiscrimination on basis of disability—
Public accommodations and commercial facilities, 35544
State and local government services, 35694

NOTICES

Pollution control; consent judgments:

Phenix City, AL, et al., 34217

Labor Department

See also Employment and Training Administration;

Employment Standards Administration

NOTICES

Agency information collection activities under OMB review,
34219

Land Management Bureau**NOTICES**

Environmental statements; availability, etc.:
Riverside County, CA, 34211

Meetings:

Bakerfield District Grazing Advisory Board, 34212
Canon City District Advisory Council, 34212

Realty actions; sales, leases, etc.:

California; correction, 34213

Resource management plans, etc.:

Big Horn County, MT, 34213
Dixie Resource Area, UT, 34213

National Commission on Acquired Immune Deficiency Syndrome**NOTICES**

Meetings, 34225

National Institutes of Health**NOTICES****Meetings:**

National Cancer Institute, 34207

Nuclear Regulatory Commission**NOTICES**

Abnormal occurrence reports:

Periodic reports to Congress, 34225

Environmental statements; availability, etc.:

Nuclear Fuel Services, Inc., 34226

Public Health Service

See also Alcohol, Drug Abuse, and Mental Health
Administration; Food and Drug Administration; Indian
Health Service; National Institutes of Health

NOTICES

Organization, functions, and authority delegations:

National Institutes of Health, 34207

Reclamation Bureau**NOTICES**

Realty actions; sales, leases, etc.:

Arizona, 34214

Resolution Trust Corporation**NOTICES**

Meetings; Sunshine Act, 34241

Securities and Exchange Commission**NOTICES**

Options price reporting authority; amendments, 34231

Self-regulatory organizations; proposed rule changes:

Chicago Board Options Exchange, Inc., 34231

Options Clearing Corp., 34232

Applications, hearings, determinations, etc.:

Public utility holding company filings, 34235

SMA Life Assurance Co. et al., 34233

Soil Conservation Service**NOTICES**

Environmental statements; availability, etc.:

Chunky River Watershed, MS, 34169

Susquehanna River Basin Commission**NOTICES**

Project review filing and monitoring fee schedule, 34235

Transportation Department

See also Federal Aviation Administration

NOTICES

Aviation proceedings:

Hearings, etc.—

Advantage Airlines, 34237

Island Express, 34237

U.S.-Italy service case, 34238

(2 documents)

Meetings:

Conferences in Ocean Shipping Advisory Commission,
34238**Treasury Department**See Customs Service

Separate Parts in This Issue**Part II**Architectural and Transportation Barriers Compliance
Board, 35408**Part III**

Department of Justice, 35544

Part IV

Department of Justice, 35694

Part V

Equal Employment Opportunity Commission, 35726

Part VI

Environmental Protection Agency, 35758

Part VII

Department of Education, 35790

Part VIII

Department of the Interior, Indian Affairs Bureau, 35794

Part IXDepartment of Energy, 35798

Reader Aids

Additional information, including a list of public laws, telephone numbers, and finding aids, appears in the Reader Aids section at the end of this issue.

CFR PARTS AFFECTED IN THIS ISSUE

A cumulative list of the parts affected this month can be found in the Reader Aids section at the end of this issue.

9 CFR

78..... 34141
166..... 34142

10 CFR**Proposed Rules:**

707..... 35798

14 CFR

39 (4 documents)...34142-
34146
71..... 34147
73..... 34148

Proposed Rules:

71 (2 documents)..... 34155

19 CFR

4..... 34149

25 CFR

39..... 35794

28 CFR

35..... 35694
36..... 35544

29 CFR

1602..... 35753
1627..... 35753
1630..... 35726

36 CFR

1191..... 35408

40 CFR**Proposed Rules:**

261..... 35758
271..... 35758
302..... 35758
372..... 34156

47 CFR

22..... 34149
94..... 34149

Proposed Rules:

61..... 34159
69..... 34159
73..... 34162
76..... 34162

50 CFR

17..... 34151

Proposed Rules:

17..... 34162

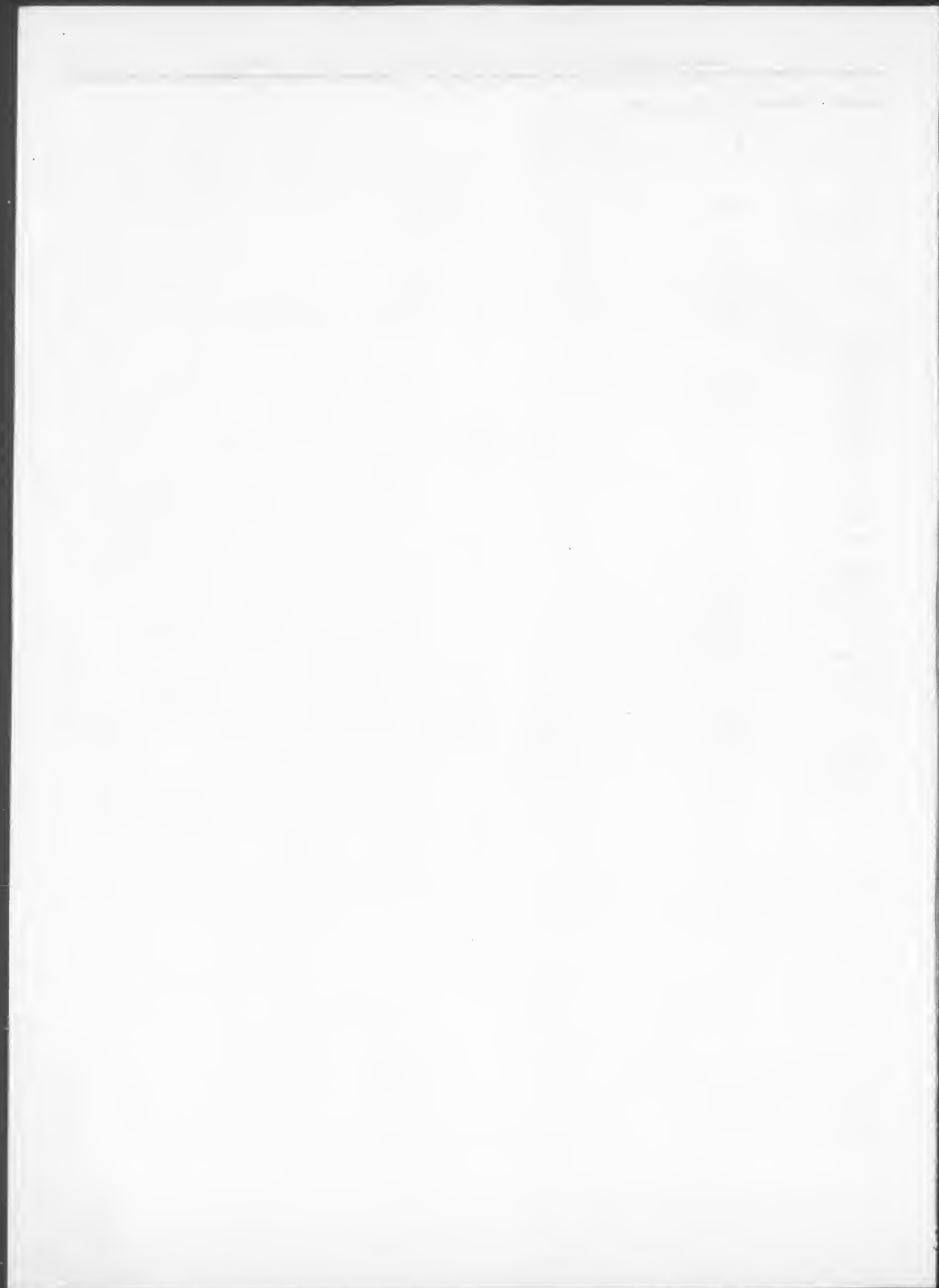

Rules and Regulations

Federal Register

Vol. 56, No. 144

Friday, July 26, 1991

This section of the FEDERAL REGISTER contains regulatory documents having general applicability and legal effect, most of which are keyed to and codified in the Code of Federal Regulations, which is published under 50 titles pursuant to 44 U.S.C. 1510. The Code of Federal Regulations is sold by the Superintendent of Documents. Prices of new books are listed in the first FEDERAL REGISTER issue of each week.

DEPARTMENT OF AGRICULTURE

Animal and Plant Health Inspection Service

9 CFR Part 78

[Docket No. 91-103]

Brucellosis in Cattle; State and Area Classifications

AGENCY: Animal and Plant Health Inspection Service, USDA.

ACTION: Affirmation of interim rule.

SUMMARY: We are affirming without change an interim rule that amended the brucellosis regulations concerning the interstate movement of cattle by changing the classification of Indiana from Class Free to Class A. We have determined that Indiana no longer meets the standards for Class Free status, but meets the standards for Class A status. The rule affirmed by this action imposed certain restrictions on the interstate movement of cattle from Indiana.

EFFECTIVE DATE: August 26, 1991.

FOR FURTHER INFORMATION CONTACT: Dr. John D. Kopec, Senior Staff Veterinarian, Cattle Diseases and Surveillance Staff, VS, APHIS, USDA, room 729, Federal Building, 6505 Belcrest Road, Hyattsville, MD 20782, 301-436-8188.

SUPPLEMENTARY INFORMATION:

Background

In an interim rule effective April 23, 1991, and published in the *Federal Register* on April 29, 1991 (56 FR 19545-19547, Docket Number 90-216), we amended the brucellosis regulations in 9 CFR part 78 that provide a system for classifying States or portions of States according to the rate of brucella infection present, and the general effectiveness of a brucellosis control and eradication program. We removed

Indiana from the list of Class Free States or areas in § 78.41(a) and added it to the list of Class A States or areas in § 78.41(b).

Comments on the interim rule were required to be received on or before June 28, 1991. We did not receive any comments. The facts presented in the interim rule still provide a basis for this rule.

Executive Order 12291 and Regulatory Flexibility Act

We are issuing this rule in conformance with Executive Order 12291, and we have determined that it is not a "major rule." Based on information compiled by the Department, we have determined that this rule will have an effect on the economy of less than \$100 million; will not cause a major increase in costs or prices for consumers, individual industries, Federal, State, or local government agencies, or geographic regions; and will not cause a significant adverse effect on competition, employment, investment, productivity, innovation, or on the ability of United States-based enterprises to compete with foreign-based enterprises in domestic or export markets.

For this action, the Office of Management and Budget has waived the review process required by Executive Order 12291.

Cattle moved interstate are moved for slaughter, for use as breeding stock, or for feeding. Changing the brucellosis status of Indiana from Class Free to Class A increases certain testing and other requirements governing the interstate movement of cattle from Indiana. However, testing requirements for cattle moved interstate for immediate slaughter or to quarantined feedlots are not affected by this change. Cattle from certified brucellosis free herds are not affected by this change.

The group affected by this action will be herd owners in Indiana, as well as buyers and importers of Indiana cattle.

There are an estimated 37,000 cattle herds in Indiana that potentially would be affected by this rule, 98 percent of which are owned by small entities. Most of these herds are not certified-free. Test-eligible cattle offered for sale from other than certified-free herds must have a negative test under Class A status

regulations. Based on experience, we estimate that approximately 47,000 test-eligible cattle will be tested annually. The average cost of testing cattle for brucellosis is approximately \$7.00 per animal. If the total cost of testing is equally distributed among all herds in Indiana, this classification change would cost less than \$9 per herd. Therefore, we have determined that changing Indiana's brucellosis status will not significantly affect market patterns.

Under these circumstances, the Administrator of the Animal and Plant Health Inspection Service has determined that this action will not have a significant economic impact on a substantial number of small entities.

Paperwork Reduction Act

This rule contains no new information collection or recordkeeping requirements under the Paperwork Reduction Act of 1980 (44 U.S.C. 3501 *et seq.*).

Executive Order 12372

This program/activity is listed in the Catalog of Federal Domestic Assistance under No. 10.025 and is subject to Executive Order 12372, which requires intergovernmental consultation with State and local officials. (See 7 CFR part 3015, subpart V.)

List of Subjects in 9 CFR Part 78

Animal diseases, Brucellosis, Cattle, Hogs, Quarantine, Transportation.

PART 78—BRUCELLOSIS

Accordingly, we are adopting as a final rule, without change, the interim rule amending 9 CFR 78.41 (a) and (b) that was published at 56 FR 19545-19547 on April 29, 1991.

Authority: 21 U.S.C. 111-114a-1, 114g, 115, 117, 120, 121, 123-126, 134b, 134f; 7 CFR 2.17, 2.51, and 371.2(d).

Done in Washington, DC, this 23rd day of July 1991.

James W. Glosser,
Administrator, Animal and Plant Health Inspection Service.

[FR Doc. 91-17775 Filed 7-25-91; 8:45 am]

BILLING CODE 3410-01-M

9 CFR Part 166**[Docket No. 91-070]****Swine Health Inspection****AGENCY:** Animal and Plant Health Inspection Service, USDA.**ACTION:** Affirmation of interim rule.

SUMMARY: We are affirming without change an interim rule that amended that Swine Health Protection regulations by: (1) Removing Delaware, Maryland, and Texas from the list of States that have primary enforcement responsibility under the Swine Health Protection Act, and (2) adding Maryland and Texas to the list of States that do not have primary enforcement responsibility under the Swine Health Protection Act but, under cooperative agreements with the Animal and Plant Health Inspection Service, issue licenses to persons desiring to operate a treatment facility for garbage that is to be treated and fed to swine. We took these actions at the request of Delaware, Maryland, and Texas, and pursuant to the Swine Health Protection Act. These actions will help ensure that requirements under the Swine Health Protection Act for the feeding of garbage to swine are enforced in Delaware, Maryland, and Texas, thereby helping to prevent the dissemination of certain swine diseases.

EFFECTIVE DATE: August 26, 1991.

FOR FURTHER INFORMATION CONTACT: Dr. Delorias M. Lenard, Veterinary Medical Officer, Swine Diseases Staff, VS, APHIS, USDA, room 736-A, Federal Building, 6505 Belcrest Road, Hyattsville, MD 20782, 301-436-7767.

SUPPLEMENTARY INFORMATION:**Background**

In an interim rule published in the *Federal Register* and effective February 25, 1991 (56 FR 7554-7555, Docket Number 90-120), we amended the Swine Health Protection regulations in 9 CFR part 166 by (1) removing Delaware, Maryland, and Texas from the list of States that have primary enforcement responsibility under the Swine Health Protection Act, and (2) adding Maryland and Texas to the list of States that do not have primary enforcement responsibility under the Swine Health Protection Act but, under cooperative agreements with the Animal and Plant Health Inspection Service, issue licenses to persons desiring to operate a treatment facility for garbage that is to be treated and fed to swine.

Comments on the interim rule were required to be received on or before

April 26, 1991. We did not receive any comments. The facts presented in the interim rule still provide a basis for this rule.

Executive Order 12291 and Regulatory Flexibility Act

We are issuing that rule in conformance with Executive Order 12291, and we have determined that it is not a "major rule." Based on information compiled by the Department, we have determined that this rule will have an effect on the economy of less than \$100 million; will not cause a major increase in costs or prices for consumers, individual industries, Federal, State, or local government agencies, or geographic regions; and will not cause a significant adverse effect on competition, employment, investment, productivity, innovation, or on the ability of United States-based enterprises to compete with foreign-based enterprises in domestic or export markets.

For this action, the Office of Management and Budget has waived its review process required by Executive Order 12291.

Almost all persons who operate facilities for the treatment of garbage to be fed to swine or who allow the feeding of garbage to swine are considered small entities.

Delaware has no licensed garbage feeders; therefore, removing Delaware from the list of States that have primary enforcement responsibility under the Act will have no impact on any small entities in that State.

Maryland has one licensed garbage feeder and Texas has approximately 440, but these entities should experience no economic impact as a result of this action. The Maryland and Texas law regarding the feeding of garbage to swine is essentially identical to Federal law, and the switch from State to Federal primary enforcement responsibility in Maryland and Texas has had no significant economic impact on the business operations of garbage feeders in those States.

The change in enforcement responsibility resulted in an increase in the level of enforcement activity in Delaware, Maryland, and Texas. However, a review of our records indicates that the switch from State to Federal primary enforcement responsibility has resulted in no appreciable change in the number of garbage feeding violations encountered in these States.

Under these circumstances, the Administrator of the Animal and Plant Health Inspection Service has determined that this action will not have

a significant economic impact on a substantial number of small entities.

Paperwork Reduction Act

This rule contains no new information collection or recordkeeping requirements under the Paperwork Reduction Act of 1980 (44 U.S.C. 3501 *et seq.*).

Executive Order 12372

This program/activity is listed in the Catalog of Federal Domestic Assistance under No. 10.025 and is subject to Executive Order 12372, which requires intergovernmental consultation with State and local officials. (See 7 CFR part 3015, subpart V.)

List of Subjects in 9 CFR Part 166

African swine fever, Animal disease, Foot-and-mouth disease, Garbage, Hog cholera, Hogs, Reporting and recordkeeping requirements, Swine vesicular disease, Vesicular exanthema of swine.

PART 166—SWINE HEALTH PROTECTION

Accordingly, we are adopting as a final rule, without change, the interim rule amending 9 CFR 166.15 that was published at 56 FR 7554-7555 on February 25, 1991.

Authority: 7 U.S.C. 3802, 3803, 3804, 3808, 3809, 3811; 7 CFR 2.17, 2.51, and 371.2(d).

Done in Washington, DC, this 23rd day of July 1991.

James W. Glosser,

Administrator, Animal and Plant Health Inspection Service.

[FR Doc. 91-17774 Filed 7-25-91; 8:45 am]

BILLING CODE 3410-34-M**DEPARTMENT OF TRANSPORTATION****Federal Aviation Administration****14 CFR Part 39**

[Docket No. 90-NM-293-AD; Amdt. 39-7085; AD 91-09-16 R1]

Airworthiness Directives; Aerospatiale Model ATR42-300 and ATR42-320 Series Airplanes

AGENCY: Federal Aviation Administration (FAA), DOT.

ACTION: Final rule.

SUMMARY: This amendment rescinds Airworthiness Directive (AD) 91-09-16, Amendment 39-6985, applicable to certain Aerospatiale Model ATR42-300 and ATR42-320 series airplanes, which requires the installation of a reinforcing plate on Stringer 14 at Frame 25. This

installation is intended to prevent damage due to potential fatigue identified in the area of Frame 25 in the main landing gear bay area. Since issuance of that AD, the FAA has been advised that the addressed unsafe condition applies to the area at Stringer 15 rather than Stringer 14.

EFFECTIVE DATE: July 26, 1991.

FOR FURTHER INFORMATION CONTACT:

Mr. Woodford Boyce, Standardization Branch, ANM-113; telephone (206) 227-2137. Mailing address: FAA, Northwest Mountain Region, Transport Airplane Directorate, 1601 Lind Avenue SW., Renton, Washington 98055-4056.

SUPPLEMENTARY INFORMATION: On April 16, 1991, the FAA issued AD 91-09-16, Amendment 39-6985 (56 FR 19254, April 26, 1991), applicable to certain Aerospatiale Model ATR42-300 and ATR42-320 series airplanes, which requires the installation of a reinforcing plate on Stringer 14 at Frame 25. That action was prompted by fatigue testing conducted by the manufacturer which identified fatigue damage in the landing gear bay area in line with Frame 25. This condition, if not corrected, could result in collapse of the main landing gear.

Since issuance of that AD, the manufacturer has advised the FAA that the addressed unsafe condition applies to the area of Frame 25 at Stringer 15, rather than at Stringer 14, as was cited in the AD. The reinforcement plate should be installed at Stringer 15, rather than Stringer 14.

Since an unsafe condition does not exist in regard to Stringer 14, the FAA has determined that it is necessary to rescind AD 91-09-16 in order to prevent operators from performing an unnecessary modification of Stringer 14. The FAA intends to follow this action with additional rulemaking action to address the unsafe condition as it relates to Stringer 15.

Since this action rescinds an unnecessary modification, it has no adverse economic impact and imposes no additional burden on any person. Therefore, notice and public procedures hereon are unnecessary and the rescission may be made effective upon publication in the *Federal Register*.

The Rescission

Accordingly, pursuant to the authority delegated to me by the Administrator, the Federal Aviation Administration amends 14 CFR part 39 of the Federal Aviation Regulations as follows:

PART 39—[AMENDED]

1. The authority citation for part 39 continues to read as follows:

Authority: 49 U.S.C. 1354(a), 1421 and 1423; 49 U.S.C. 106(g) (Revised Pub. L. 97-449, January 12, 1983); and 14 CFR 11.89.

§ 39.13 [Amended]

2. Section 39.13 is amended by removing Amendment 39-6985 as follows:

91-09-16 R1 Aerospatiale. Amendment 39-6985 as rescinded by Amendment 39-7085. Docket No. 90-NM-293-AD.

Applicability: Model ATR42-300 and ATR42-320 series airplanes, Serial Numbers 3 through 151, certificated in any category.

This amendment (39-7085, AD 91-09-16 R1) is effective July 26, 1991.

Issued in Renton, Washington, on July 10, 1991.

Darrell M. Pederson,

Acting Manager, Transport Airplane Directorate, Aircraft Certification Service.

[FR Doc. 91-17767 Filed 7-25-91; 8:45 am]

BILLING CODE 4910-13-M

14 CFR Part 39

[Docket No. 91-NM-29-AD; Amendment 39-7088; AD 91-15-23]

Airworthiness Directives; Aerospatiale Model Nord 262A Series Airplanes

AGENCY: Federal Aviation Administration (FAA), DOT.

ACTION: Final rule.

SUMMARY: This amendment adopts a new airworthiness directive (AD), applicable to all Aerospatiale Model Nord 262A series airplanes, which requires repetitive visual and eddy current inspections to detect corrosion and damage to the fuselage skin panel junctions, and repair, if necessary. This amendment is prompted by reports of corrosion found on in-service airplanes in the fuselage skin panel lap joints. This condition, if not corrected, could result in reduced structural integrity of the fuselage.

EFFECTIVE DATE: August 26, 1991.

ADDRESSES: The applicable service information may be obtained from Aerospatiale, 316 Route de Bayonne, 31060 Toulouse, Cedex 03, France. This information may be examined at the FAA, Northwest Mountain Region, Transport Airplane Directorate, 1601 Lind Avenue SW., Renton, Washington.

FOR FURTHER INFORMATION CONTACT: Mr. Greg Holt, Standardization Branch, ANM-113; telephone (206) 227-2140. Mailing address: FAA, Northwest Mountain Region, Transport Airplane Directorate, 1601 Lind Avenue SW., Renton, Washington 98055-4056.

SUPPLEMENTARY INFORMATION: A proposal to amend part 39 of the Federal Aviation Regulations to include a new

airworthiness directive, applicable to certain Aerospatiale Model Nord 262A series airplanes, which requires repetitive visual and eddy current inspections to detect corrosion and damage to the fuselage skin panel junctions, and repair, if necessary, was published in the *Federal Register* on March 21, 1991 (56 FR 11972).

Interested persons have been afforded an opportunity to participate in the making of this amendment. No comments were received in response to the proposal.

Since issuance of the notice, Aerospatiale has issued Revision 1 to N262-Fregate Service Bulletin 53-34, dated March 24, 1991, which clarifies the procedures for inspection of fuselage skin panel junctions. Aerospatiale has also issued Revision 1 to N262-Fregate Service Bulletin 53-35, dated March 24, 1991, which specifies additional reference materials, and provides additional clarification to accomplish the procedures for preventive and curative measures to be applied at the fuselage skin panel junctions. The FAA has revised the final rule to reflect the latest revisions of these service bulletins as the appropriate source of service information.

After careful review of the available data, the FAA has determined that air safety and the public interest require the adoption of the rule as proposed with the changes previously described. The FAA has determined that these changes will neither significantly increase the economic burden on any operator, nor increase the scope of the AD.

It is estimated that 14 airplanes of U.S. registry would be affected by this AD, that it would take approximately 30 manhours per airplane to accomplish the required actions, and that the average labor cost would be \$55 per manhour. Based on these figures, the total cost impact of the AD on U.S. operators is estimated to be \$23,100.

The regulations adopted herein will not have substantial direct effects on the States, on the relationship between the national government and the States, or on the distribution of power and responsibilities among the various levels of government. Therefore, in accordance with Executive Order 12812, it is determined that this final rule does not have sufficient federalism implications to warrant the preparation of a Federalism Assessment.

For the reasons discussed above, I certify that this action: (1) Is not a "major rule" under Executive Order 12291; (2) is not a "significant rule" under DOT Regulatory Policies and Procedures (44 FR 11034, February 26,

1979); and (3) will not have a significant economic impact, positive or negative, on a substantial number of small entities under the criteria of the Regulatory Flexibility Act. A final evaluation has been prepared for this action and is contained in the rules docket. A copy of it may be obtained from the Rules Docket.

List of Subjects in 14 CFR Part 39

Air transportation, Aircraft, Aviation safety, Safety.

Adoption of the Amendment

Accordingly, pursuant to the authority delegated to me by the Administrator, the Federal Aviation Administration amends 14 CFR part 39 of the Federal Aviation Regulations as follows:

PART 39—[AMENDED]

1. The authority citation for Part 39 continues to read as follows:

Authority: 49 U.S.C. 1354(a), 1421 and 1423; 49 U.S.C. 106(g) (Revised Pub. L. 97-449, January 12, 1983); and 14 CFR 11.89.

§ 39.13 [Amended]

2. Section 39.13 is amended by adding the following new airworthiness directive:

91-15-23. *Aerospatiale*: Amendment 39-7088. Docket No. 91-NM-29-AD

Applicability: Model Nord 262A series airplanes, certificated in any category.

Compliance: Required as indicated, unless previously accomplished.

To prevent reduced structural integrity of the fuselage, accomplish the following:

A. For airplanes which are 20 years old or more since new as of the effective date of this AD: Within 2 years after the effective date of this AD, perform internal and external detailed visual inspections and a low frequency eddy current inspection of the fuselage skin panel junctions, in accordance with *Aerospatiale* N262-Fregate Service Bulletin 53-34, Revision 1, dated March 24, 1991.

B. For airplanes which are less than 20 years old since new as of the effective date of this AD: Within 4 years after the effective date of this AD, perform internal and external detailed visual inspections and a low frequency eddy current inspection of the fuselage skin panel junctions, in accordance with *Aerospatiale* N262-Fregate Service Bulletin 53-34, Revision 1, dated March 24, 1991.

C. If no corrosion is found as a result of the inspections required by paragraph A. or B. of this AD, accomplish the following:

1. At intervals not to exceed one year, perform an external visual inspection of the fuselage from Frame N to Frame 27, in accordance with *Aerospatiale* N262-Fregate Service Bulletin 53-34, Revision 1, dated March 24, 1991.

2. At intervals not to exceed 2 years, perform an internal visual inspection from Frame N to Frame 27, in accordance with

Aerospatiale N262-Fregate Service Bulletin 53-34, Revision 1, dated March 24, 1991.

3. At intervals not to exceed 6 years, accomplish the following:

a. Non-Pressurized Area: Perform internal and external detailed visual inspections of the circumferential and longitudinal skin panel junction from Frame N to Frame J and from Frame 21 to Frame 27, in accordance with the Accomplishment Instructions, paragraph 2C(3)A of *Aerospatiale* N262-Fregate Service Bulletin 53-34, Revision 1, dated March 24, 1991.

b. Pressurized Area: Perform internal and external detailed visual inspections of the circumferential and longitudinal fuselage skin panel junctions in accordance with the Accomplishment Instructions, paragraph 2C(3)A of *Aerospatiale* N262-Fregate Service Bulletin 53-34, Revision 1, dated March 24, 1991.

D. If corrosion is found as a result of the inspections required by paragraph A., B., or C. of this AD, and the corrosion depth is equal to or less than 30 microns, accomplish one of the following:

1. Perform external visual inspections at intervals not to exceed one year, and low frequency eddy current inspections at intervals not to exceed 2 years, in accordance with *Aerospatiale* N262-Fregate Service Bulletin 53-34, Revision 1, dated March 24, 1991; or

2. Prior to further flight, repair in accordance with Scheme No. 1 (Preventative Measure Procedure without Removal of Panels) specified in *Aerospatiale* N262-Fregate Service Bulletin 53-35, Revision 1, dated March 24, 1991. Thereafter, repeat the visual and low frequency eddy current inspections at intervals not to exceed 6 years, in accordance with *Aerospatiale* N262-Fregate Service Bulletin 53-34, Revision 1, dated March 24, 1991; or

3. Prior to further flight, repair in accordance with Scheme No. 2 (Curative Measures Procedures with Removal of Panels) specified in *Aerospatiale* N262-Fregate Service Bulletin 53-35, Revision 1, dated March 24, 1991. This constitutes terminating action for the repetitive inspections of that area required by this AD.

E. If corrosion is found as a result of the inspections required by paragraph A., B., or C. of this AD, and the corrosion depth is more than 30 microns but less than or equal to 100 microns, accomplish one of the following:

1. Prior to further flight, repair in accordance with Scheme No. 1 (Preventative Measure Procedure without Removal of Panels) specified in *Aerospatiale* N262-Fregate Service Bulletin 53-35, Revision 1, dated March 24, 1991. Thereafter, repeat the visual and low frequency eddy current inspections at intervals not to exceed 2 years, in accordance with *Aerospatiale* N262-Fregate Service Bulletin 53-34, Revision 1, dated March 24, 1991.

2. Prior to further flight, repair in accordance with Scheme No. 2 (Curative Measures Procedures with Removal of Panels) specified in *Aerospatiale* N262-Fregate Service Bulletin 53-35, Revision 1, dated March 24, 1991. This constitutes terminating action for the repetitive inspections for that area required by this AD.

F. If corrosion is found as a result of the inspections required by paragraph A., B., or C. of this AD, and the corrosion depth is more than 100 microns, prior to further flight, repair in accordance with Scheme No. 2 (Curative Measures Procedures with Removal of Panels) specified in *Aerospatiale* N262-Fregate Service Bulletin 53-35, Revision 1, dated March 24, 1991. This constitutes terminating action for the repetitive inspections of that area required by this AD.

G. An alternative method of compliance or adjustment of the compliance time, which provides an acceptable level of safety, may be used when approved by the Manager, Standardization Branch, ANM-113, FAA, Transport Airplane Directorate.

Note: The request should be forwarded through an FAA Principal Maintenance Inspector, who may concur or comment and then send it to the Manager, Standardization Branch, ANM-113.

H. Special flight permits may be issued in accordance with FAR 21.197 and 21.199 to operate airplanes to a base in order to comply with the requirements of this AD.

All persons affected by this directive who have not already received the appropriate service documents from the manufacturer may obtain copies upon request to *Aerospatiale*, 316 Route de Bayonne, 31060 Toulouse, Cedex 03, France. These documents may be examined at the FAA, Northwest Mountain Region, Transport Airplane Directorate, 1601 Lind Avenue SW., Renton, Washington.

This amendment (39-7088, AD 91-15-23) becomes effective August 26, 1991.

Issued in Renton, Washington, on July 12, 1991.

Darrell M. Pederson,
Acting Manager, Transport Airplane
Directorate, Aircraft Certification Service.
[FR Doc. 91-17769 Filed 7-25-91; 8:45 am]

BILLING CODE 4910-13-M

14 CFR Part 39

[Docket No. 91-CE-08-AD; Amendment 39-7084; AD 91-15-20]

Airworthiness Directives; Beech Models 95-C55, C55A, D55, D55A, E55, E55A, 58, and 58A Airplanes

AGENCY: Federal Aviation Administration (FAA), DOT.

ACTION: Final rule.

SUMMARY: This amendment adopts a new airworthiness directive (AD) that is applicable to certain Beech Models 95-C55, C55A, D55, D55A, E55, E55A, 58, and 58A airplanes. This action requires periodic inspections for cracks in the engine mounts. There have been reports of cracked engine mounts on the affected airplanes. The actions specified by this AD are intended to detect cracked engine mounts and prevent severe engine vibration and possible

separation of the engine from the airplane.

DATES: Effective September 3, 1991. The incorporation by reference of certain publications listed in the regulations is approved by the Director of the Federal Register as of September 3, 1991.

ADDRESSES: Beech Service Bulletin No. 2362, Revision 1, dated February 1991, and Beech Kit 58-9007-1S that are discussed in this AD may be obtained from the Beech Aircraft Corporation, P.O. Box 85, Wichita, Kansas 67201-0085. The service information may be examined at the FAA, Central Region, Office of the Assistant Chief Counsel, room 1558, 601 E. 12th Street, Kansas City, Missouri 64106.

FOR FURTHER INFORMATION CONTACT: Mr. Larry Engler, Aerospace Engineer, Wichita Aircraft Certification Office, FAA, 1801 Airport Road, Mid-Continent Airport, Wichita, Kansas 67209; telephone (316) 946-4409.

SUPPLEMENTARY INFORMATION: A proposal to amend part 39 of the Federal Aviation Regulations to include an AD that is applicable to certain Beech Models 95-C55, C55A, D55, D55A, E55, E55A, 58, and 58A airplanes was published in the Federal Register on March 14, 1991 (56 FR 10837). The action proposed inspections of each engine mount for cracks, and, if found cracked, either installation of Beech Kit 58-9007-1S or replacement with a new engine installation of Beech Kit 58-9007-1S or replacement with a new engine mount (part number 96-910010-67) in accordance with the instructions in Beech Service Bulletin (SB) No. 2362, Revision 1, dated February 1991.

Interested persons have been afforded an opportunity to participate in the making of this amendment. Due consideration has been given to the one comment received.

The commenter stated that the initial compliance time of 100 hours time-in-service (TIS) is contrary to Beech SB No. 2362, which specifies the inspection when the airplane accumulates 600 hours TIS, and that service history on engine mount cracking does not support the 100-hour TIS requirement. The FAA has evaluated the initial compliance time and has determined that the 100-hour TIS compliance time should be changed to read "upon the accumulation of 600 hours TIS or within the next 100 hours TIS after the effective date, whichever occurs later". This concurs with the instructions in Beech SB 2362, and does not inadvertently ground airplanes that have accumulated over 600 hours TIS.

Paragraph (a) of the proposed AD would require both visual and dye

penetrant inspections. The commenter stated that this too was contrary to Beech SB 2362, which requires only a visual inspection and specifies that the dye penetrant inspection is optional to confirm cracks. The FAA concurs that only the visual inspection should be required and has revised the AD accordingly. Since the FAA has no way of enforcing optional inspections, the AD is currently written does not require dye penetrant inspections.

The commenter recommended that paragraph (a)(2)(ii) of the AD read " * * * replace the cracked engine mount * * * instead of " * * * remove and replace the cracked engine mount * * * " because the engine mount was already removed. The FAA concurs since paragraph (a)(2) already requires the removal of the engine mount.

The FAA has determined that air safety and the public interest require the adoption of the rule as proposed except for the remarks discussed above and minor editorial corrections. These comments and minor corrections will not change the intent of the AD nor add any additional burden upon the public than was already proposed.

It is estimated that 2,812 airplanes in the U.S. registry will be affected by this AD, that it will take approximately 4 hours per airplane to accomplish the required action, and that the average labor rate is approximately \$55 an hour. Based on these figures, the total cost impact of the AD on U.S. operators is estimated to be \$618,640.

The regulations adopted herein will not have substantial direct effects on the States, on the relationship between the national government and the States, or on the distribution of power and responsibilities among the various levels of government. Therefore, in accordance with Executive Order 12612, it is determined that this final rule does not have sufficient federalism implications to warrant the preparation of a Federalism Assessment.

For the reasons discussed above, I certify that this action: (1) Is not a "major rule" under Executive Order 12291; (2) is not a "significant rule" under DOT Regulatory Policies and Procedures (44 FR 11034 February 26, 1979); and (3) will not have a significant economic impact, positive or negative, on a substantial number of small entities under the criteria of the Regulatory Flexibility Act. A copy of the final evaluation prepared for this action is contained in the Rules Docket. A copy of it may be obtained by contacting the Rules Docket at the location provided under the caption "ADDRESSES".

List of Subjects in 14 CFR Part 39

Air transportation, Aircraft, Aviation safety, Incorporation by reference, Safety.

Adoption of the Amendment

Accordingly, pursuant to the authority delegated to me by the Administrator, the Federal Aviation Administration amends 14 CFR part 39 of the Federal Aviation Regulations as follows:

PART 39—[AMENDED]

1. The authority citation for part 39 continues to read as follows:

Authority: 49 U.S.C. 1354(a), 1421 and 1423; 49 U.S.C. 106(g); and 14 CFR 11.89.

§ 39.13 [Amended]

2. Section 39.13 is amended by adding the following new AD:

AD 91-15-20 Beech: Amendment 39-7084; Docket No. 91-CE-08-AD.

Applicability: Models 95-C55, 95-C55A, D55, D55A, E55, and E55A airplanes (serial number (S/N) TC350, and S/N TE-1 through TE-1201), and Models 58 and 58A airplanes (S/N TH-1 through TH-1610), certificated in any category.

Compliance: Required as indicated, unless already accomplished.

To prevent severe engine vibration and possible separation of the engine from the airplane caused by cracked engine mounts, accomplish the following:

(a) Upon the accumulation of 600 hours time-in-service (TIS) or within 100 hours TIS after the effective date of this AD, whichever occurs later, inspect each engine mount in accordance with the instructions in Beech Service Bulletin (SB) No. 2362, Revision 1, dated February 1991.

(1) If no cracks are found, repeat the inspection on each engine mount thereafter at intervals not to exceed 100 hours TIS.

(2) If a crack is found on an engine mount, prior to further flight, remove the engine from the affected engine mount, remove the mount from the airplane, and magnetic particle inspect the engine mount to determine the length of the crack in accordance with the instructions in Beech SB No. 2362, Revision 1, dated February 1991.

(i) If the length of the crack is .52 inches (true) or less, repair and reinforce the engine mount using Beech Kit 58-9007-1S in accordance with the instructions in Beech SB 2362, Revision 1, dated February 1991.

(ii) If the length of the crack is greater than .52 inches (true), replace the cracked engine mount with a part number (P/N) 96-910010-67 engine mount in accordance with the instructions in Beech SB No. 2362, Revision 1, dated February 1991.

(3) The repetitive inspections specified in paragraph (a)(1) of this AD may be terminated on an engine mount that has been repaired and reinforced with Beech Kit 58-9007-1S or if a P/N 96-910010-67 engine mount has been installed.

(b) Special flight permits may be issued in accordance with FAR 21.197 and 21.199 to

operate airplanes to a location where the requirements of this AD can be accomplished.

(c) An alternative method of compliance or adjustment of the initial or repetitive compliance times that provides an equivalent level of safety may be approved by the Manager, Wichita Aircraft Certification Office, FAA, 1801 Airport Road, Mid-Continent Airport, Wichita, Kansas 67209. The request should be forwarded through an appropriate FAA Maintenance Inspector, who may add comments and then send it to the Manager, Wichita Aircraft Certification Office.

(d) The inspections, modifications, and replacements required by this AD shall be done in accordance with Beech Service Bulletin No. 2362, Revision 1, dated February 1991. This incorporation by reference was approved by the Director of the Federal Register in accordance with 5 U.S.C. 552(a) and 1 CFR part 51. Copies may be obtained from the Beech Aircraft Corporation, P.O. Box 85, Wichita, Kansas 67201-0085. Copies may be inspected at the FAA, Central Region, Office of the Assistant Chief Counsel, room 1558, 901 E. 12th Street, Kansas City, Missouri, or at the Office of the Federal Register, 1100 L Street, NW., room 8401, Washington, DC.

This amendment becomes effective on September 3, 1991.

Issued in Kansas City, Missouri, on July 10, 1991.

Barry D. Clements,
Manager, Small Airplane Directorate,
Aircraft Certification Service.

[FR Doc. 91-17768 Filed 7-25-91; 8:45 am]

BILLING CODE 4910-13-M

14 CFR Part 39

[Docket No. 91-ANE-21; Amendment 39-7079]

Airworthiness Directives; E.I. DuPont de Nemours & Co., TSO-C116 Crewmember Protective Breathing Equipment Model 4566M37B-042N

AGENCY: Federal Aviation Administration (FAA), DOT.

ACTION: Final rule, request for comments.

SUMMARY: This amendment adopts a new airworthiness directive (AD), applicable to E.I. DuPont de Nemours & Co. TSO-C116 Crewmember Protective Breathing Equipment (CPBE) Model 4566M37B-042N, which requires modification to the DuPont CPBE Model 4566M37B-042N. This amendment is prompted by field service reports indicating that the Velcro strips affixed to the barrier pouch become attached to the Nomex felt bracket liner rendering the pouch difficult to remove from the bracket. This condition, if not corrected, could result in the failure of a

crewmember to remove the pouch from the bracket in case of a fire.

DATES: Effective August 15, 1991.

Comments must be received no later than August 26, 1991.

The incorporation by reference of certain publications listed in the regulations is approved by the Director of the Federal Register as of August 15, 1991.

ADDRESSES: Submit comments in duplicate to the FAA, New England Region, Office of the Assistant Chief Counsel, Attention: Rules Docket No. 91-ANE-21, 12 New England Executive Park, Burlington, Massachusetts 01803-5299, or deliver in duplicate to room 311 at the above address.

Comments may be inspected at the above location between the hours of 8 a.m. and 4:30 p.m., Monday through Friday, except federal holidays.

The applicable service information may be obtained from E.I. DuPont de Nemours & Co., P.O. Box 791, 505 Blue Ball Road Elkton, MD 21921. This information may be examined at the FAA, New England Region, Office of the Assistant Chief Counsel, 12 New England Executive Park, Burlington, Massachusetts.

FOR FURTHER INFORMATION CONTACT: Mr. D. Kramer, Aerospace Engineer, Systems and Equipment Branch, ANE-173, New York Aircraft Certification Office, Engine and Propeller Directorate, Aircraft Certification Service, FAA, New England Region, 181 South Franklin Avenue, room 202, Valley Stream, New York 11581-1145; telephone (516) 791-6427.

SUPPLEMENTARY INFORMATION: This amendment is prompted by field service reports and manufacturer tests which indicate that the Velcro strips affixed to the barrier pouch become attached to the Nomex felt bracket liner rendering the pouch difficult to remove from the bracket. This condition, if not corrected, could result in the failure of a crewmember to remove the pouch from the bracket in case of a fire.

The FAA has reviewed and approved the technical contents of E.I. DuPont de Nemours & Co. Service Bulletin 002, dated February 5, 1991, which provides instructions for modification of the existing pouch by removal of the Velcro strips and shims, and replacement with new left and right side spacers.

Since this situation is likely to exist or develop on other CPBE of the same TSO approved design, this AD requires modification of the DuPont CPBE, Model 4566M37B-042N, in accordance with the service bulletin previously described.

Since this condition may result in failure of a crewmember to remove the

CPBE needed to fight a fire and/or function in a smoked filled environment there is a need to complete CPBE modification with minimum delay. Since a situation exists that requires immediate adoption of this regulation, it is found that notice and public procedure hereon are impracticable, and good cause exists for making this amendment effective in less than 30 days.

Although this action is in the form of a final rule, which involves an emergency and, thus, was not preceded by notice and public procedure, interested persons are invited to submit such written data, views, or arguments as they may desire regarding this AD. Communications should identify the docket number and be submitted to the FAA, New England Region, Office of the Assistant Chief Counsel, Attention: Rules Docket No. 91-ANE-21, 12 New England Executive Park, Burlington, Massachusetts 01803-5299. All communications received by the deadline date indicated above will be considered by the Administrator, and the AD may be changed in light of the comments received.

The regulations adopted herein will not have substantial direct effects on the States, on the relationship between the national government and the States, or on the distribution of power and responsibilities among the various levels of government. Therefore, in accordance with Executive Order 12612, it is determined that this final rule does not have sufficient federalism implications to warrant the preparation of a Federalism Assessment.

The FAA has determined that this regulation is an emergency regulation and that it is not considered to be major under Executive Order 12291. It is impracticable for the agency to follow the procedures of Order 12291 with respect to this rule since the rule must be issued immediately to correct an unsafe condition in aircraft. It has been determined further that this action involves an emergency regulation under DOT Regulatory Policies and Procedures (44 FR 11034, February 26, 1979). If it is determined that this emergency regulation otherwise would be significant under DOT Regulatory Policies and Procedures, a final regulatory evaluation will be prepared and placed in the Rules Docket (otherwise, an evaluation is not required). A copy of it, if filed, may be obtained from the Rules Docket.

List of Subjects in 14 CFR Part 39

Air transportation, Aircraft, Aviation safety, Incorporation by reference, and Safety.

Adoption of the Amendment

Accordingly, pursuant to the authority delegated to me by the Administrator, the Federal Aviation Administration (FAA) amends 14 CFR part 39 of the Federal Aviation Regulations (FAR) as follows:

PART 39—[AMENDED]

1. The authority citation for part 39 continues to read as follows:

Authority: 49 U.S.C. 1354(a), 1421 and 1423; 49 U.S.C. 106(g) (Revised Pub. L. 97-449, January 12, 1983); and 14 CFR 11.89.

§ 39.13 [Amended]

2. Section 39.13 is amended by adding the following new airworthiness directive (AD):

91-15-15 E.I. DuPont de Nemours & Company; (Amendment 39-7079, Docket No. 91-ANE-21.)

Applicability: E.I. DuPont de Nemours & Co., TSO-C116 Crewmember Protective Breathing Equipment Model 4566M37B-042N, with serial numbers below S/N V9100000, installed on, but not limited to transport category aircraft.

Compliance: Required as indicated, unless previously accomplished.

To prevent the failure of a crewmember to remove the pouch from the bracket in case of a fire, accomplish the following:

(a) Remove the Velcro Strips and insert new left and right spacers in accordance with Paragraph 2, Procedure Instructions, of E.I. DuPont de Nemours & Co., Service Bulletin 002, dated February 5, 1991.

(b) Aircraft may be ferried in accordance with the provisions of FAR 21.197 and 21.199 to a base where the AD can be accomplished.

(c) Upon submission of substantiating data by an owner or operator through an FAA Inspector (maintenance, avionics, or operations, as appropriate), and alternate method of compliance with the requirements of this AD or adjustments to the compliance specified in this AD may be approved by the Manager, New York Aircraft Certification Office, 181 South Franklin Ave., Valley Stream, New York, 11581-1145.

(d) The modifications shall be done in accordance with the following E.I. DuPont de Nemours & Co. Service Bulletin No. 002:

| Page No. | Issue | Date |
|----------|----------|-------------------|
| 1-5 | Original | February 5, 1991. |

This incorporation by reference was approved by the Director of the Federal Register in accordance with 5 U.S.C. 552(a) and 1 CFR part 51. Copies may be obtained from E.I. DuPont de Nemours & Co., P.O. Box 791, 505 Blue Ball Road, Elkton, Maryland 21921. Copies may be inspected at the FAA, New England Region, Office of the Assistant Chief Counsel, room 311, 12 New England Executive Park, Burlington, Massachusetts, or New York Aircraft Certification Office, 181 South Franklin Ave., Valley Stream, New

York, or at the Office of the Federal Register, 1100 L Street NW., room 8401, Washington, DC.

This agreement (39-7079, AD 91-15-15) becomes effective August 15, 1991.

Issued in Burlington, Massachusetts, on July 3, 1991.

Jack A. Sain,

Manager, Engine and Propeller Directorate, Aircraft Certification Service.

[FR Doc. 91-17735 Filed 7-25-91; 8:45 am]

BILLING CODE 4910-13-M

14 CFR Part 71

[Airspace Docket No. 91-AGL-5]

Transition Area Establishment; Harbor Springs, MI

AGENCY: Federal Aviation Administration (FAA), DOT.

ACTION: Final rule.

SUMMARY: The nature of this action is to establish the Harbor Springs, MI, transition area. A VOR-A Standard Instrument Approach Procedure (SIAP) has been developed to serve Harbor Springs Airport. The SIAP is predicated on the Pellston VORTAC. This action lowers the base of controlled airspace from 1200 to 700 feet above the surface in the vicinity of the airport. The intended effect is to ensure segregation of the aircraft using approach procedures in instrument conditions from other aircraft operating under visual weather conditions in controlled airspace. Concurrent with the SIAP publication, the operating status of the airport will change from visual flight rules (VFR) to instrument flight rules (IFR).

EFFECTIVE DATE: 0901 u.t.c., September 19, 1991.

FOR FURTHER INFORMATION CONTACT: Angeline Perri, Air Traffic Division, System Management Branch, Airspace Section, Federal Aviation Administration, 2300 East Devon Avenue, Des Plaines, Illinois 60018, telephone (312) 694-7571.

SUPPLEMENTARY INFORMATION:

History

On Friday, June 7, 1991, the Federal Aviation Administration (FAA) proposed to amend part 71 of the Federal Aviation Regulations (14 CFR part 71) to establish a transition area airspace near Harbor Springs, MI (58 FR 26355).

Interested parties were invited to participate in this rulemaking proceeding by submitting written comments on the proposal to the FAA. No comments objecting to the proposal were received.

Except for editorial changes, this amendment is the same as that proposed in the notice. Section 71.181 of part 71 of the Federal Aviation Regulations was republished in Handbook 7400.6G dated September 4, 1990.

The Rule

This amendment to part 71 of the Federal Aviation Regulations establishes a transition area airspace near Harbor Springs, MI. The transition area is being established to accommodate a new VOR-A SIAP to Harbor Springs Airport, Harbor Springs, MI. This action lowers the base of controlled airspace from 1200 to 700 feet above the surface in the vicinity of Harbor Springs Airport. Concurrent with the SIAP publication the operating status of the airport will change from VFR to IFR.

The development of a new SIAP requires that the FAA alter the designated airspace to insure that the procedure will be contained within controlled airspace. The minimum descent altitude for this procedure may be established below the floor of the 700-foot controlled airspace.

Aeronautical maps and charts will reflect the defined area which will enable other aircraft to circumnavigate the area in order to comply with applicable visual flight rule requirements.

The FAA has determined that this regulation only involves an established body of technical regulations for which frequent and routine amendments are necessary to keep them operationally current. It, therefore—(1) is not a "major rule" under Executive Order 12291; (2) is not a "significant rule" under DOT Regulatory Policies and Procedures (44 FR 11034; February 26, 1979); and (3) does not warrant preparation of a regulatory evaluation as the anticipated impact is so minimal. Since this is a routine matter that will only affect air traffic procedures and air navigation, it is certified that this rule when promulgated, will not have a significant economic impact on a substantial number of small entities under the criteria of the Regulatory Flexibility Act.

List of Subjects in 14 CFR Part 71

Aviation Safety, Transaction areas.

Adoption of the Amendment

Accordingly, pursuant to the authority delegated to me, part 71 of the Federal Aviation Regulations (14 CFR part 71) is amended, as follows:

PART 71—[AMENDED]

1. The authority citation for part 71 continues to read as follows:

Authority: 49 U.S.C. 1348(a), 1354(a), 1510; Executive Order 10854; 49 U.S.C. 106(g) (Revised Pub. L. 97-449, January 12, 1983); 14 CFR 11.69.

§ 71.181 [Amended]

2. Section 71.181 is amended as follows:

Harbor Springs, MI [New]

That airspace extending upward from 700 feet above the surface within a 6.7-mile radius of the Harbor Springs Airport (lat. 45°25'29"N., long. 84°54'34"W.); excluding that airspace within the Pellston, MI, control zone and transition area.

Issued in Des Plaines, Illinois on July 18, 1991.

Teddy W. Burcham,

Manager, Air Traffic Division.

[FR Doc. 91-17770 Filed 7-25-91; 8:45 am]

BILLING CODE 4910-13-M

14 CFR Part 73

[Airspace Docket No. 90-ANM-10]

Establishment of Temporary Restricted Area R-3203D Boise, ID

AGENCY: Federal Aviation Administration (FAA), DOT.

ACTION: Final rule.

SUMMARY: This action establishes temporary Restricted Area R-3203D Boise, ID, for the period August 3-17, 1991. The temporary restricted area is established adjacent to an existing Restricted Area R-3203A Boise, ID, to provide essential ground maneuvering space to meet Idaho National Guard annual training requirements.

EFFECTIVE DATE: August 3, 1991.

FOR FURTHER INFORMATION CONTACT: Ken McElroy, Military Operations Program Office (ATM-420), Office of Air Traffic System Management, Federal Aviation Administration, 800 Independence Avenue, SW., Washington, DC 20591; telephone: (202) 287-7888.

SUPPLEMENTARY INFORMATION:**History**

On June 7, 1991, the FAA proposed to amend part 73 of the Federal Aviation Regulations (14 CFR part 73) to establish temporary Restricted Area R-3203D Boise, ID, for the period August 3-17, 1991 (56 FR 26356). Interested parties were invited to participate in this rulemaking proceeding by submitting written comments on the proposal to the FAA. No comments objecting to the

proposal were received. Except for editorial changes, this amendment is the same as that proposed in the notice. Section 73.32 of part 73 of the Federal Aviation Regulations was republished in Handbook 7400.8C dated September 4, 1990.

The Rule

This amendment to part 73 of the Federal Aviation Regulations establishes temporary Restricted Area R-3203D Boise, ID, adjacent to the existing Restricted Area R-3203A, in order to provide additional ground maneuvering space needed by the Idaho Army National Guard in conducting its annual training program. The restricted area will be in effect only for the period August 3-17, 1991. All artillery firing will be directed into the existing Artillery Impact Area located approximately in the center of Restricted Area R-3203A. The temporary restricted area is needed to provide protected airspace to contain the projectiles during flight between the surface firing point and entry into the existing Restricted Area R-3203A.

The FAA has determined that this regulation only involves an established body of technical regulations for which frequent and routine amendments are necessary to keep them operationally current. It, therefore—(1) is not a "major rule" under Executive Order 12291; (2) is not a "significant rule" under DOT Regulatory Policies and Procedures (44 FR 11034; February 26, 1979); and (3) does not warrant preparation of a regulatory evaluation as the anticipated impact is so minimal. Since this is a routine matter that will only affect air traffic procedures and air navigation, it is certified that this rule will not have a significant economic impact on a substantial number of small entities under the criteria of the Regulatory Flexibility Act.

In consideration of the need to allow the Idaho National Guard to use the subject area for their August 3-17 training mission and the safety need to restrict the operation of aircraft through this area during that time period, the FAA finds good cause, pursuant to 5 U.S.C. 553(d), for making this amendment effective in less than 30 days in order to promote the safe and efficient handling of air traffic in the area.

Environmental Review

The temporary restricted area will be in effect only from August 3 to August 17, 1991. The temporary restricted area will prohibit the flight of nonparticipating aircraft through the area, but will not direct nonparticipating aircraft to operate in any set or

established route outside the restricted area. The National Guard Bureau and the Idaho National Guard (Guard) completed a Final Environmental Impact Statement on the Orchard Training Area Facilities and examined the environmental effects associated with the type of activity taking place within the restricted area. The National Guard determined that none of the impacts of the actions occurring within the restricted area will significantly affect the environment. Finding that the firing points in the temporary restricted area will be farther from nesting areas, that the projectiles will be fired into existing artillery impact areas, and that noise impacts will be no greater than that currently caused by the existing firing points inside the restricted area, the National Guard determined that all of the possible environmental impacts of the temporary restricted area were addressed in the Final Environmental Impact Statement.

On the basis of the environmental documentation developed by the National Guard, and the FAA's review of the ATC procedures in effect in the area before and after adoption of the temporary restricted area, the FAA finds that there will be no significant impact on the environment as a result of this action.

List of Subjects in 14 CFR Part 73

Aviation safety, Restricted areas.

Adoption of the Amendment

Accordingly, pursuant to the authority delegated to me, part 73 of the Federal Aviation Regulations (14 CFR part 73) is amended, as follows:

PART 73—SPECIAL USE AIRSPACE

1. The authority citation for part 73 continues to read as follows:

Authority: 49 U.S.C. App. 1348(a), 1354(a), 1510, 1522; Executive Order 10854; 49 U.S.C. 106(g) (Revised Pub. L. 97-449, January 12, 1983); 14 CFR 11.69.

§ 73.32 [Amended]

2. Section 73.32 is amended as follows:

R-3203D Boise, ID [New]

Boundaries. Beginning at lat. 43°14'00"N., long. 116°16'30"W.; to lat. 43°17'51"N., long. 116°16'25"W.; to lat. 43°19'02"N., long. 116°14'45"W.; to lat. 43°19'02"N., long. 116°06'36"W.; to lat. 43°15'39"N., long. 116°00'39"W.; to lat. 43°15'00"N., long. 116°01'00"W.; to lat. 43°17'00"N., long. 116°05'00"W.; to lat. 43°17'00"N., long. 116°12'00"W.; thence to point of beginning.

Altitude. Surface to 10,000 feet MSL.

Times of use. As scheduled by NOTAM 24 hours in advance for the period August 3-17,

1991, only. Restricted area is terminated after 2359 hours local time on August 17, 1991.

Controlling agency. FAA, Salt Lake City ARTCC.

Using agency. Army National Guard, Orchard, ID.

Issued in Washington, DC, on July 22, 1991.

Jerry W. Ball,

Acting Manager, Airspace-Rules and Aeronautical Information Division.

[FR Doc. 91-17771 Filed 7-25-91; 8:45 am]

BILLING CODE 4910-13-M

DEPARTMENT OF THE TREASURY

U.S. Customs Service

19 CFR Part 4

[T.D. 91-63]

Addition of Luxembourg to the List of Nations Entitled to Special Tonnage Tax Exemption

AGENCY: U.S. Customs Service, Department of the Treasury.

ACTION: Final rule.

SUMMARY: Pursuant to information provided by the Department of State, the Customs Service has found that Luxembourg does not impose discriminating duties of tonnage or imposes upon vessels belonging to citizens of the U.S., and that, accordingly, vessels of Luxembourg are exempt from special tonnage taxes and light money in ports of the United States. This amendment adds Luxembourg to the list of nations whose vessels are exempt from the payment of any higher tonnage duties than are applicable to vessels of the U.S. and from the payment of light money.

EFFECTIVE DATE: The reciprocal privileges for vessels registered in the Luxembourg became effective on January 1, 1991. This amendment is effective July 26, 1991.

FOR FURTHER INFORMATION CONTACT: Barbara E. Whiting, Carrier Rulings Branch, (202-566-5706).

SUPPLEMENTARY INFORMATION:

Background

Generally, the United States imposes regular and special tonnage taxes, and a duty of a specified amount per ton, called "light money", on all foreign vessels which enter United States ports (46 U.S.C. App. 121, 128). However, vessels of a foreign nation may be exempted from the payment of special tonnage taxes and light money upon presentation of satisfactory proof that no discriminatory duties of tonnage or impost are imposed by that foreign

nation on U.S. vessels or their cargoes (46 U.S.C. App. 141).

Section 4.22, Customs Regulations (19 CFR 4.22), lists those nations whose vessels have been found to be exempt from the payment of any higher tonnage duties than are applicable to vessels of the U.S. and from the payment of light money. The authority to amend this section of the Customs Regulations has been delegated to the Chief, Regulations and Disclosure Law Branch.

Finding

On the basis of the information received from the Department of State regarding the absence of discriminatory duties of tonnage or impost imposed on U.S. vessels in the ports of Luxembourg, the Customs Service has determined that vessels of Luxembourg are exempt from the payment of the special tonnage tax and light money, effective January 1, 1991, and that the Customs Regulations should be amended accordingly.

Inapplicability of Public Notice and Delayed Effective Date Requirements, the Regulatory Flexibility Act and Executive Order 12291

Because this amendment merely implements a statutory requirement and confers a benefit upon the public, pursuant to 5 U.S.C. 553(b)(3)(B), notice and public procedure thereon are unnecessary; further, for the same reason, good cause exists for dispensing with a delayed effective date under 5 U.S.C. 553(d) (1) and (3). Since this document is not subject to the notice and public procedure requirements of 5 U.S.C. 553, it is not subject to the provisions of the Regulatory Flexibility Act (5 U.S.C. 601 *et seq.*). This amendment does not meet the criteria for a "major rule" as defined in E.O. 12291. Accordingly, a regulatory impact analysis is not required.

Drafting Information

The principal author of this document was Peter T. Lynch, Regulations and Disclosure Law Branch, Office of Regulations and Rulings, U.S. Customs Service. However, personnel from other offices participated in its development.

List of Subjects in 19 CFR Part 4

Customs duties and inspection, Cargo vessels, Maritime carriers, Vessels.

Amendment to the Regulations

Accordingly, part 4 of the Customs Regulations (19 CFR part 4) is amended as follows:

PART 4—VESSELS IN FOREIGN AND DOMESTIC TRADES

1. The authority for part 4 continues to read as follows:

Authority: 5 U.S.C. 301; 19 U.S.C. 66, 1624; and 46 U.S.C. App. 3;

* * * * *
 § 4.22 also issued under 46 U.S.C. App. 121, 128, 141;
 * * * * *

§ 4.22 [Amended]

2. Section 4.22 is amended by inserting "Luxembourg" in appropriate alphabetical order.

Dated: July 18, 1991.

Kathryn C. Peterson,
 Chief, Regulations and Disclosure Law Branch.

[FR Doc. 91-17659 Filed 7-25-91; 8:45 am]

BILLING CODE 4820-02-M

FEDERAL COMMUNICATIONS COMMISSION

47 CFR Parts 22 and 94

[GEN Docket 82-243; FCC 91-191]

Service and Technical Rules for Government and Non-Government Fixed Service Usage of the Frequency Bands 932-935 MHz and 941-944 MHz

AGENCY: Federal Communications Commission.

ACTION: Final rule.

SUMMARY: This action amends parts 22 and 94 of the Commission's Rules to limit the number of applications a party can file in the 900 MHz Government/Non-government fixed service for point-to-multipoint channels in a particular market and also maintains existing lottery procedures for these channels. The Third Report and Order portion of this document was initiated by the Fourth Notice of Proposed Rule Making in this proceeding which, in turn, was in response to a petition for reconsideration filed by the Utilities Telecommunications Council; the Memorandum Opinion and Order portion was initiated by a petition for reconsideration filed by Mr. Dennis C. Brown and Mr. Robert H. Schwaninger, Jr. The effect of the Third Report and Order is to preclude parties from filing multiple applications for the purpose of increasing their chances in any lottery held to select licensees, and the effect of the Memorandum Opinion and Order is to keep the lottery procedure as equitable as possible.

EFFECTIVE DATE: August 30, 1991.

FOR FURTHER INFORMATION CONTACT: Tom Mooring (202) 653-8114.

SUPPLEMENTARY INFORMATION: This is a summary of the Commission's Third Report and Order/Memorandum Opinion and Order adopted June 17, 1991, and released July 16, 1991. The full text of Commission decisions are available for inspection and copying during regular business hours in the FCC Dockets Branch (room 239), 1919 M Street NW., Washington, DC. The complete text of this decision may also be purchased from the Commission's duplication contractor, Downtown Copy Center, (202) 452-1422, 1114 21st Street NW., Washington, DC 20036.

Summary of Third Report and Order/Memorandum Opinion and Order

1. In November 1984, the Commission adopted a First Report and Order in this proceeding (50 FR 4650; February 1, 1985) that allocated the 932-935/941-944 MHz bands for a co-primary Government and Non-government fixed service. This item was followed by a February 1989 Second Report and Order (54 FR 10326; March 13, 1989) that designated the 932-932.5/941/941.5 MHz bands for point-to-multipoint use and a March 1990 Memorandum Opinion and Order (55 FR 10481; March 21, 1990) that clarified the frequency assignment and coordination procedures to be used. A reconsideration petition to the Memorandum Opinion and Order was filed by Dennis C. Brown and Robert H. Schwaninger, Jr. (Brown and Schwaninger).

2. In October 1990, the Commission adopted a Fourth Notice of Proposed Rule Making (Fourth Notice, 55 FR 42736; October 23, 1990) that proposed rules to limit the number of applications a party can file for point-to-multipoint channels in a geographic area. Specifically, the Commission proposed that common carrier (part 22) applicants be prohibited from identifying the same base station in multiple applications and that private radio (part 94) applicants be limited to one channel or channel pair within a 25-mile radius of each master station. The Commission also proposed, however, that an applicant having a legitimate need for more than a single point-to-multipoint channel or channel pair in a particular market should not be precluded from applying for multiple facilities. Further, the Commission stated that the differing nature of point-to-multipoint uses under parts 22 and 94 of the Commission's Rules requires separate rules for each service.

3. Commenting parties generally agreed with the proposals in the Fourth Notice, but some contended that the

proposed rules favored private users while other contended that the proposed rules favored common carriers. Based on a review of the record in this proceeding, the Commission adopts the proposed rules with minor amendment. The Commission believes that the legitimate needs of point-to-multipoint users will exceed the number of available channels in many areas. Therefore, allowing multiple applications to be filed for the same point-to-multipoint requirement would add to the number of applications that could not be granted, would place a large administrative burden on the Commission, and would result in inefficiencies and delayed service to the public. More importantly, permitting multiple applications for these channels would also unfairly provide an advantage to fee-exempt entities and applicants with substantial financial resources. Therefore, the Commission finds that the filing of multiple applications by applicants solely to improve their chances of receiving a channel in a lottery should be prohibited.

4. The Commission also finds that the proposed rules do not generally favor one group of applicants over another. The technical parameters associated with part 94 operations are designed to provide licensees with service areas of approximately 25 miles, within which they can serve many remote sites. Part 22 operations, on the other hand, are generally designed to serve a limited number of designated base stations. However, the Commission finds that the rules proposed for part 94 applicants require some modification so that the proposed prohibition of multiple applications will not be frustrated. To eliminate part 94 multiple applications that are not adequately justified would necessitate review by Commission staff of all such applications prior to a lottery. The Commission finds that such a process would complicate and delay the lottery process in order to provide a limited number of eligible users increased flexibilities. Therefore, during the initial filing period, part 94 applicants will not be permitted to apply for stations within 25 miles of each other. However, these applicants will be allowed to file for additional stations during subsequent phases of licensing consistent with existing policies governing the assignment of frequencies.

5. Several commenters also requested that the Commission clarify how an application for a license under either part 22 or part 94 will be affected by applications/operations in other bands. Specifically, they asked whether

applications for point-to-multipoint channels in the 932-932.5/941-941.5 MHz bands will be considered separately from applications for the 928/952 MHz point-to-multipoint channels, and whether an entity holding an existing 928/952 MHz license will be required to provide a full justification when applying for a 932-932.5/941-941.5 MHz station at the time transmitter site or in the same area.

6. The Commission finds that, consistent with current policy, applications in other bands will be taken into consideration when an application for the 932-932.5/941-941.5 MHz bands is processed. This does not mean that the Commission will not consider and grant, if appropriate, an application that is filed to upgrade an existing operation. However, it is important that the appropriate justification for such an application be included.

7. Commenters also inquired as to whether an applicant can apply under both part 22 and part 94 for use of point-to-multipoint channels in the same area for different communications needs. The Commission will consider only those applications for the same type of service, *i.e.*, common carrier or private, when evaluating whether an application is duplicative. Entities having requirements for both common carrier and private systems will be permitted to apply for channels under both parts 22 and 94.

8. In April 1990, Brown and Schwaninger filed the reconsideration petition referenced in paragraph 1, *supra*. In this filing, Brown and Schwaninger suggested that the Commission should not conduct a nationwide lottery to award point-to-multipoint licenses in the 932-932.5 MHz and 941-941.5 MHz bands and proposed, instead, that the Commission use a computerized frequency assignment method that would begin at a randomly selected corner of the contiguous United States and generate assignments to satisfy applications for stations in each geographical area. This program also would identify cases in which applications are mutually exclusive. Brown and Schwaninger further proposed that applicants not be permitted to specify a desired frequency and that mutual exclusivity be defined as multiple applications for the same site selected for frequency assignment by the computer program.

9. The Commission has carefully evaluated Brown and Schwaninger's computer program to determine whether it could be of assistance in assigning the 932-932.5 and 941-941.5 MHz bands

more efficiently and equitably. It does not appear that their program would be more spectrally efficient than the Commission's proposed method of making assignments. Further, the Commission believes that Brown and Schwaninger's proposal is such a major change from the current assignment process and from the method proposed in the Fourth Notice that a full proceeding, including an adequate notice and comment period, would be required before the Commission could adopt their proposal. The Commission believes that this would unnecessarily delay implementation of service on the 932/941 MHz point-to-multipoint frequencies. Therefore, the Commission will assign point-to-multipoint channels as set forth in the Memorandum Opinion and Order and is denying Brown and Schwaninger's petition for partial reconsideration.

Ordering Clauses

10. Authority for this rule making is contained in sections 4(i), 303(c), 303(f), 303(g), and 303(r) of the Communications Act of 1934, as amended, 47 U.S.C. sections 154(i), 303(c), 303(f), 303(g) and 303(r).

11. Accordingly, *it is Ordered*, That parts 22 and 94 of the Commission's Rules, 47 CFR parts 22 and 94, are amended as specified in the Rule Changes, below, effective August 30, 1991. *It is Further Ordered*, That the petition for reconsideration filed by Mr. Dennis C. Brown and Mr. Robert H. Schwaninger, Jr. is Denied.

12. *It is Further Ordered*, That this proceeding is terminated.

List of Subjects

47 CFR Part 22

Communications common carriers; radio.

47 CFR Part 94

Private operational-fixed microwave service, Radio.

Rule Changes

13. Parts 22 and 94 of title 47 of the Code of Federal Regulations are amended as follows:

PART 22—PUBLIC MOBILE SERVICES

14. The authority citation in part 22 continues to read:

Authority: 47 U.S.C. 154, 303, unless otherwise noted.

15. Section 22.501 is amended by revising paragraph (g)(1) introductory text to read as follows:

§ 22.501 Frequencies.

* * * * *

(g)(1) The frequencies listed in this paragraph are available for control stations utilized within a multiple address system that requires the use of at least four simultaneously operated base stations operated on the same frequency assignment. These frequencies will be assigned only when there are four or more control station, on the same frequency listed on the application for license. For purpose of this four base station limitation, base stations proposed to be controlled in the 932-932.5/941-941.5 MHz bands in any multiple address control application filed pursuant to this paragraph cannot be listed in, or counted towards, the four base requirement of any other pending application for the 932-932.5/941-941.5 MHz bands. The frequencies may be used in paired or unpaired configurations. When paired, the higher frequency will be used by the control/relay station, and the lower frequency will be used by the control station.

PART 94—PRIVATE OPERATIONAL-FIXED MICROWAVE SERVICE

16. The authority citation for part 94 continues to read:

Authority: Secs. 4, 303, 48 Stat., as amended, 1066, 1082; 47 U.S.C. 154, 303, unless otherwise noted.

17. Section 94.15 is amended by revising paragraph (g) to read as follows:

§ 94.15 Policy governing the assignment of frequencies.

(g) Except as provided in paragraph (h) of this section, applicants requiring multiple transmit frequencies employed on separate paths from a single station location will not normally be authorized more than four of the transmit frequencies available in the band. Further, master and remote stations using frequencies listed in § 94.65(a)(1) of this part will not normally be authorized more than four (12.5 kHz) frequencies or frequency pairs. During the initial filing window for the 932-932.5/941-941.5 MHz bands:

(1) An applicant may not apply for a frequency or frequency pair within a 25 mile radius of any location for which it has concurrently applied;

(2) Further, no party may have an ownership interest, direct or indirect, in two or more pending applications proposing sites within 25 miles of each other.

18. In § 94.73, the table in paragraph (a) is amended by removing footnote one, redesignating footnotes 2 through 8

as 1 through 7, and revising the first sentence in redesignated footnote two to read as follows:

§ 94.73 Power limitations.

(a) * * *

* For multiple address operations, see § 94.65(a)(1)(v). * * *

Federal Communications Commission.

William F. Caton,

Acting Secretary.

[FR Doc. 91-17421 Filed 7-25-91; 8:45 am]

BILLING CODE 6712-01-M

DEPARTMENT OF THE INTERIOR

Fish and Wildlife Service

50 CFR Part 17

RIN 1018-AB52

Endangered and Threatened Wildlife and Plants; Endangered Status for the Plant *Xyris tennesseensis* (Tennessee Yellow-Eyed Grass)

AGENCY: Fish and Wildlife Service, Interior.

ACTION: Final rule.

SUMMARY: The Service determines a plant, *Xyris tennesseensis* (Tennessee yellow-eyed grass), to be an endangered species under the authority contained in the Endangered Species Act (Act) of 1973, as amended. *Xyris tennesseensis* is currently believed extant at only seven sites—five in Tennessee and one each in Alabama and Georgia. All sites occupy less than an acre in area. Three populations have been lost and four of the remaining populations have declined in recent years from habitat modification associated with agricultural and silvicultural uses, road construction/maintenance, over-collecting and succession. This action will extend the Act's protection to *Xyris tennesseensis*.

EFFECTIVE DATE: August 26, 1991.

ADDRESSES: The complete file for this rule is available for public inspection, by appointment, during normal business hours at the Jackson, Mississippi, Field Office, U.S. Fish and Wildlife Service, 6578 Dogwood View Parkway, suite A, Jackson, Mississippi 39213.

FOR FURTHER INFORMATION CONTACT: Cary Norquist at the above address (601/965-4900 or FTS 490-4900).

SUPPLEMENTARY INFORMATION:

Background

Xyris tennesseensis, a species of yellow-eyed grass in the family

Xyridaceae, is a perennial which ranges from 7 to 10 decimeters (2.3 to 3.3 feet) in height. Plants typically occur in clumps where they arise from fleshy bulbous bases. Leaves are basal, the outermost scale-like, the larger ones linear, twisted, deep green and 14 to 45 centimeters (cm) (5.5 to 17.7 inches) long. The inflorescence consists of brown conelike spikes, 1 to 1.5 cm (0.4 to 0.6 inch) in length, which occur singly at the tips of long slender stalks from 30 to 70 cm (12 to 28 inches) long. The flowers, which are pale yellow in color and 4.5 millimeters (mm) (0.2 inch) long, unfold in the late morning and wither by mid-afternoon. Fruits are thin walled capsules containing numerous seeds 0.5 to 0.6 mm (0.02 inch) in length. Flowering occurs from August through September (Kral 1978, 1983, 1990).

Xyris tennesseensis superficially resembles *X. torta*, one of the few xyrids with which it is sympatric. However, *X. torta* differs in its strongly ribbed leaves and more curved and ciliate (rather than lacerate) lateral sepals. Taxonomically, *Xyris tennesseensis* is closest to the *X. difformis* complex. In that complex, the leaves are flatter than fanlike, bases are non-bulbous and their seed sculpture is different (Kral 1983, 1990).

Kral (1978) described *X. tennesseensis* during the course of a study on Xyridaceae, based on an examination of a 1945 specimen (identified as *Xyris caroliniana*) from Lewis County, Tennessee, and more recent collections from that County and northwest Georgia. Extensive surveys were conducted for this species during the 1988 and 1989 field seasons (Kral 1990). Three of the original sites no longer supported populations of this *Xyris* and only one new population was located. Currently, only seven populations are known to be extant, consisting of five sites in Lewis County, Tennessee, and one site each in Bartow County, Georgia, and Franklin County, Alabama. These isolated remnants are located over three different physiographic provinces, the Cumberland Plateau of Alabama, the Western Highland Rim of Tennessee and the Valley and Ridge Province of Georgia (Kral 1990).

Xyris tennesseensis occurs in seep-slopes, springy meadows or on the banks of gravelly shallows of small streams. As with all *Xyris*, the habitat is open or thinly wooded and the soils are moist to wet year-round. However, this species differs from other *Xyris* in being found in areas where calcareous rocks are at or near the soil surface. Thus, its soils are circumneutral to basic instead of acidic. Common associates include ferns and fern allies such as *Osmunda*,

Thelypteris palustris and *Lycopodium appressum*; grasses such as *Leersia oryzoides*, *Panicum* and *Andropogon*; and sedges such as *Scirpus atrovirens*, *Eleocharis*, *Cyperus*, *Rhynchospora caduca* and *R. capitellata*. *Juncus* is common with *J. brachycephalus* being a constant associate. Dominant dicots are *Phlox glaberrima*, *Lysimachia lanceolata*, *Solidago patula*, *Rudbeckia fulgida umbrosa*, *Eupatorium perfoliatum* and *Parnassia grandiflora* (in Tennessee). Woody vegetation on the border of seeps or along streambanks include *Alnus*, *Salix*, *Sambucus*, *Cornus*, and *Cephalanthus*. The surrounding forest consist of upland species common to the oak-hickory, oak-pine or oak-juniper type (Kral 1983, 1990).

Population size ranges from a few dozen plants at one site to thousands of individuals at two sites. Most sites support populations of a few hundred plants and each site occupies less than an acre in area. Most populations are located on private land; however, plants extend onto State maintained highway right-of-way in Alabama and onto National Park Service land (Natchez Trace Parkway) in Lewis County, Tennessee.

Of 10 historically known populations, 3 populations have been lost and 4 of the remaining are declining from threats associated with highway construction/right-of-way maintenance; modification or destruction of habitat for agricultural usage; over-collecting; or the encroachment of woody plants.

Federal actions involving *Xyris tennesseensis* began with the December 15, 1980, publication of a notice of review for native plants in the Federal Register (45 FR 82460). *Xyris tennesseensis* was included in this notice as a category 1 species. Category 1 comprises taxa for which the Service presently has sufficient biological information to support their being proposed to be listed as endangered or threatened species. On November 28, 1983, the Service published a supplement to the notice of review for native plants in the Federal Register (48 FR 53640); the plant notice was again revised on September 27, 1985 (50 FR 39526) and on February 21, 1990 (55 FR 6184). *Xyris tennesseensis* was included as a category 2 species in the 1983 supplement and the revised notices. Category 2 species are those for which listing as endangered or threatened species may be warranted but for which substantial data on biological vulnerability and threats are not currently known or on file to support a proposed rule. The Service contracted a status survey for this species in 1988.

Field surveys were conducted during 1988 and 1989. A final report was received and approved by the Service in the spring of 1990. This report (Kral 1990) and other information support the listing. The data demonstrate a limited distribution and continuing threats to the species. On February 15, 1991, the Service published a proposal (56 FR 6341) to list *Xyris tennesseensis* as an endangered species.

Summary of Comments and Recommendations

In the February 15, 1991, proposed rule and associated notifications, all interested parties were requested to submit factual reports or information that might contribute to the development of a final rule. Appropriate Federal and State agencies, county governments, scientific organizations, and other interested parties were contacted and requested to comment. Newspaper notices, inviting public comment, were published in the *Daily Tribune News*, Cartersville, Georgia, on February 28, 1991; the *Lewis County Herald*, Hohenwald, Tennessee, on February 28, 1991; and the *Franklin County Times*, Russellville, Alabama, on March 3, 1991.

Two comments were received, including one from a Federal agency (Tennessee Valley Authority) and one from an individual. Both were in support of the proposal.

Summary of Factors Affecting the Species

After a thorough review and consideration of all information available, the Service has determined that *Xyris tennesseensis* should be classified as an endangered species. Procedures found at section 4(a)(1) of the Endangered Species Act (16 U.S.C. 1531 *et seq.*) and regulations (50 CFR part 424) promulgated to implement the listing provisions of the Act were followed. A species may be determined to be an endangered or threatened species due to one or more of the five factors described in section 4(a)(1). These factors and their application to *Xyris tennesseensis* Kral (Tennessee yellow-eyed grass) are as follows:

A. *The present or threatened destruction, modification, or curtailment of its habitat or range.* *Xyris tennesseensis* has been and continues to be threatened by the destruction or adverse modification of its habitat. In surveying potential habitat for additional populations, Kral (1990) noted that similar habitat had been impacted or lost due to agricultural or silvicultural practices. Many of the larger stream bottoms, which were once seep

meadows and springs, have been dammed for ponds, drained and converted to pasture or row-crops; or developed for housing. A site in Gordon County, Georgia, that once supported a population of this *Xyris* is now a soybean field (Kral 1990). Other areas surveyed had been adversely affected by timber operations. As discussed in the "Background" section of this rule, this *Xyris* is dependent on small, clean, spring-fed headwater streams or associated seeps. Timbering upslope leads to increased erosion, deposition into the seeps and water quality degradation of the watershed (Kral 1990). Heavy equipment, in association with logging, would damage individual plants and drain the habitat if operated directly in the seeps.

Habitat for the Alabama population has been disturbed by timbering and gravel quarrying (for use in the adjacent highway). Since 1982, the number of plants at this site have significantly declined (from 100's to less than 100) due to these disturbances and the use of herbicides in right-of-way maintenance. Highway construction caused the destruction of a second population in Georgia (Bartow County). Three other populations are located near roads and are potentially threatened by road improvement measures.

B. *Overutilization for commercial, recreational, scientific, or educational purposes.* This species is not known to be in commercial trade. Over-collecting (presumably for scientific purposes) has resulted in a significant decline for one population in Tennessee (Kral 1990).

C. *Disease or predation.* None apparent.

D. *The inadequacy of existing regulatory mechanisms.* This *Xyris* is considered endangered in all the States where it occurs; however, it is currently afforded legal protection in only one State (Tennessee). Tennessee legislation (Rare Plant Protection and Conservation Act of 1985) prohibits taking without the permission of the landowner and regulates commercial sale and export. Plants which are listed, or proposed for listing in Georgia, automatically come under the protection provided by the Wildflower Preservation Act of 1973 (T. Patrick, Georgia Heritage Program, pers. comm., 1990). This legislation prohibits taking of plants from public lands (without a permit) and regulates the sale and transport of plants within the State. Neither of these statutes provide protection against habitat destruction, which is the principal threat. The Tennessee Department of Conservation and Tennessee Nature Conservancy have several voluntary protection agreements with landowners. These

agreements, while very useful in protecting the plants, have no legal authority. The Act would strengthen existing protection, provide additional protection and encourage active management for *Xyris tennesseensis* (see "Available Conservation Measures").

E. *Other natural or manmade factors affecting its continued existence.* This species is vulnerable due to the small number of populations, the limited amount of area each population occupies and its specialized habitat requirements (see "Background" section). *Xyris tennesseensis* occurs in habitat which is "open" and is vulnerable to overcrowding and shade associated with woody plant encroachment. Furthermore, open wet areas are essential for successful germination (Kral 1988). In Lewis County, Tennessee, one population has been lost and a second is declining from the increased competition with succession (Kral 1990). While succession is a slow and natural process, it poses a threat to this species due to the small number of populations and limited amount of suitable habitat remaining. Proper management planning is needed to address this aspect of the species' biology.

This species is vulnerable to diversion of seep or ground water. Kral (1990) noted that water tables are dropping throughout the area, resulting in the loss of many of the seeps and springheads.

The Service has carefully assessed the best scientific and commercial information available regarding the past, present, and future threats faced by this species in determining to make this rule final. Based on this evaluation, the preferred action is to list *Xyris tennesseensis* as endangered. Only seven populations remain (each occupies less than an acre of area, four have declined, and all are in need of long-term management; thus, a classification of endangered is appropriate. An endangered species, as defined by the Act, is threatened with extinction throughout all or a significant portion of its range. Critical habitat is not being designated for reasons discussed in the following section.

Critical Habitat

Section 4(a)(3) of the Act, as amended, requires that, to the maximum extent prudent and determinable, the Secretary designate critical habitat at the time a species is determined to be endangered or threatened. The Service finds that designation of critical habitat is not presently prudent for this species. As discussed under Factor B in the Summary of Factors Affecting the

Species, *Xyris tennesseensis* has been impacted by over-collecting and publicity surrounding its listing could exacerbate the threat of taking. Taking is an activity difficult to enforce against and only regulated by the Act with respect to plants in cases of (1) removal and reduction to possession of endangered plants from lands under Federal jurisdiction, or their malicious damage or destruction on such lands; and (2) removal, cutting, digging up, or damaging or destroying in knowing violation of any State law or regulation, including State criminal trespass law. Publication of critical habitat descriptions and maps would make *Xyris tennesseensis* more vulnerable and increase enforcement problems. All involved parties, including State and Federal agencies and principal landowners, have been notified of the location and importance of protecting this species' habitat. Protection of this species' habitat will be addressed through the recovery process and through the Section 7 jeopardy standard. Therefore, it would not now be prudent to determine critical habitat for *Xyris tennesseensis*.

Available Conservation Measures

Conservation measures provided to species listed as endangered or threatened under the Endangered Species Act include recognition, recovery actions, requirements for Federal protection, and prohibitions against certain practices. Recognition through listing encourages and results in conservation actions by Federal, State, and private agencies, groups, and individuals. The Endangered Species Act provides for possible land acquisition and cooperation with the States and requires that recovery actions be carried out for all listed species. The protection required of Federal agencies and the prohibitions against certain activities involving listed plants are discussed, in part, below.

Section 7(a) of the Act, as amended, requires Federal agencies to evaluate their actions with respect to any species that is proposed or listed as endangered or threatened and with respect to its critical habitat, if any is being designated. Regulations implementing this interagency cooperation provision of the Act are codified at 50 CFR part 402. Section 7(a)(2) requires Federal agencies to ensure that activities they authorize, fund, or carry out are not likely to jeopardize the continued existence of such a species or to destroy or adversely modify its critical habitat. If a Federal action may affect a listed species or its critical habitat, the

responsible Federal agency must enter into formal consultation with the Service.

A portion of one population extends onto National Park Service (NPS) land. The Tennessee Department of Conservation has an agreement with NPS to protect this population. The Environmental Protection Agency will consider this species relative to pesticide (herbicide) registration. The Federal Highway Administration will consider this species in relation to those highway maintenance projects which are federally funded. Currently, no activities to be authorized, funded, or carried out by Federal agencies that would affect *Xyris tennesseensis* are anticipated.

The act and its implementing regulations found at 50 CFR 17.61, 17.62, and 17.63 set forth a series of general prohibitions and exceptions that apply to all endangered plants. All trade prohibitions of section 9(a)(2) of the Act, implemented by 50 CFR 17.61, will apply. These prohibitions, in part, make it illegal for any person subject to the jurisdiction of the United States to import or export, transport in interstate or foreign commerce in the course of a commercial activity, sell or offer for sale this species in interstate or foreign commerce, or to remove and reduce to possession the species from areas under Federal jurisdiction. In addition, for endangered plants, the 1988 amendments (Pub. L. 100-478) to the Act prohibit the malicious damage or destruction on Federal lands and the removal, cutting, digging up, or damaging or destroying of endangered plants in knowing violation of any state law or regulation, including State

criminal trespass law. Certain exceptions apply to agents of the Service and State conservation agencies. The Act and 50 CFR 17.62 and 17.63 also provide for the issuance of permits to carry out otherwise prohibited activities involving endangered species under certain circumstances.

It is anticipated that few trade permits would ever be sought or issued because the species is not common in cultivation or in the wild. Requests for copies of the regulations on listed plants and inquiries regarding prohibitions and permits may be addressed to the Office of Management Authority, U.S. Fish and Wildlife Service, 4401 N. Fairfax Drive, room 432, Arlington, Virginia 22203 (703/358-2104).

National Environmental Policy Act

The Fish and Wildlife Service has determined that an Environmental Assessment, as defined under the authority of the National Environmental Policy Act of 1969, need not be prepared in connection with regulations adopted pursuant to section 4(a) of the Endangered Species Act of 1973, as amended. A notice outlining the Service's reasons for this determination was published in the *Federal Register* on October 25, 1983 (48 FR 49244).

References Cited

Kral, R. 1978. A new species of *Xyris* (sect. *Xyris*) from Tennessee and northwestern Georgia. *Rhodora* 80 (823): 444-447.
 Kral, R. 1983. *Xyris tennesseensis*. In: A report on some rare, threatened, or endangered forest-related vascular plants of the South, Vol. 1:166-169. USDA Forest Service, Technical Publication R8-TP 2.

Kral, R. 1988. A preliminary report on *Xyris tennesseensis*. Unpublished report submitted to U.S. Fish and Wildlife Service, Jackson, Mississippi. 6 pp.
 Kral, R. 1990. A status report on *Xyris tennesseensis*. Unpublished report submitted to U.S. Fish and Wildlife Service, Jackson, Mississippi. 22 pp.

Author

The primary author of this final rule is Cary Norquist (see ADDRESSES section) 601/965-4900 or FTS 490-4900.

List of Subjects in 50 CFR Part 17

Endangered and threatened species, Exports, Imports, Reporting and recordkeeping requirements, and Transportation.

Regulation Promulgation

PART 17—[AMENDED]

Accordingly, part 17, subchapter B of chapter I, title 50 of the Code of Federal Regulations, is amended as set forth below:

1. The authority citation for part 17 continues to read as follows:

Authority: 16 U.S.C. 1361-1407; 16 U.S.C. 1531-1544; 16 U.S.C. 4201-4245; Pub. L. 99-625, 100 Stat. 3500; unless otherwise noted.

2. Amend § 17.12(h) by adding in alphabetical order the family Xyridaceae, and the following entry to the List of Endangered and Threatened Plants:

§ 17.12 Endangered and threatened plants.

* * * * *
 (h) * * *

| Species | | Historic range | Status | When listed | Critical habitat | Special rules |
|--------------------------------------|----------------------------------|--------------------------|--------|-------------|------------------|---------------|
| Scientific name | Common name | | | | | |
| Xyridaceae—Yellow-eyed grass family: | | | | | | |
| <i>Xyris tennesseensis</i> | Tennessee yellow-eyed grass..... | U.S.A. (AL, GA, TN)..... | E | 430 | NA | NA |

Dated: June 26, 1991.
 Richard N. Smith,
 Acting Director, Fish and Wildlife Service.
 [FR Doc. 91-17759 Filed 7-25-91; 8:45 am]
 BILLING CODE 4310-65-M

Proposed Rules

Federal Register

Vol. 56, No. 144

Friday, July 26, 1991

This section of the FEDERAL REGISTER contains notices to the public of the proposed issuance of rules and regulations. The purpose of these notices is to give interested persons an opportunity to participate in the rule making prior to the adoption of the final rules.

DEPARTMENT OF TRANSPORTATION

Federal Aviation Administration

14 CFR Part 71

[Airspace Docket No. 91-ASO-17]

Proposed Establishment of Transition Area, Port Gibson, MS

AGENCY: Federal Aviation Administration (FAA), DOT.

ACTION: Correction to notice of proposed rulemaking.

SUMMARY: Airspace Docket No. 91-ASO-14 was erroneously assigned to the subject notice of proposed rulemaking published in the Federal Register on July 8, 1991, Volume 56, page 30883. The correct Airspace Docket No. for the Proposed Establishment of the Port Gibson, MS, Transition Area is 91-ASO-17.

Issued in East Point, Georgia, on July 17, 1991.

Don Cass,

Acting Manager, Air Traffic Div., Southern Region.

[FR Doc. 91-17772 Filed 7-25-91; 8:45 am]

BILLING CODE 4910-13-M

14 CFR Part 71

[Airspace Docket No. 91-ANM-10]

Proposed Establishment of Transition Area; Sun River, OR

AGENCY: Federal Aviation Administration (FAA), DOT.

ACTION: Notice of proposed rulemaking.

SUMMARY: This notice proposes to establish a transition area to provide controlled airspace for the new VHF Omnidirectional Range/Distance Measuring Equipment (VOR/DME) approach to the Sun River Airport, Sun River, Oregon. The transition area would segregate aircraft operating in visual flight rules (VFR) conditions from those operating under instrument flight rules (IFR). The area would be depicted

on aeronautical charts to provide references for pilots.

DATES: Comments must be received on or before September 3, 1991.

ADDRESSES: Send comments on the proposal to: Federal Aviation Administration, Docket No. 91-ANM-10, 1601 Lind Avenue, SW., Renton, WA 98055-4056.

The official docket may be examined at the same address.

An informal docket may also be examined during normal business hours at the address listed above.

FOR FURTHER INFORMATION CONTACT:

Robert L. Brown, ANM-535, Federal Aviation Administration, Docket No. 91-ANM-10, 1601 Lind Avenue SW., Renton, WA 98055-4056, telephone: (206) 227-2535.

SUPPLEMENTARY INFORMATION:

Comments Invited

Interested parties are invited to participate in this proposed rulemaking by submitting such written data, views, or arguments as they may desire. Comments that provide the factual basis supporting the views and suggestions presented are particularly helpful in developing reasoned regulatory decisions on the proposal. Comments are specifically invited on the overall regulatory, aeronautical, economic, environmental, and energy aspects of the proposal. Communications should identify the airspace docket and be submitted to the address listed above. Commenters wishing the FAA to acknowledge receipt of their comments on this notice must submit with those comments a self-addressed, stamped postcard on which the following statement is made: "Comments to Airspace Docket No. 91-ANM-10." The postcard will be date/time stamped and returned to the commenter. All communications received before the specified closing date for comments will be considered before taking action on the proposed rule. The proposal contained in this notice may be changed in the light of comments received. All comments submitted will be available for examination at the Federal Aviation Administration, 1601 Lind Avenue SW., Renton, Washington 98055-4056 both before and after the closing date for comments. A report summarizing each substantive public contact with FAA personnel concerned with this rulemaking will be filed in the docket.

Availability of NPRM's

Any person may obtain a copy of this Notice of Proposed Rulemaking (NPRM) by submitting a request to the Federal Aviation Administration, 1601 Lind Avenue SW., Renton, Washington 98055-4056. Communications must identify the notice number of this NPRM. Persons interested in being placed on a mailing list for future NPRM's should also request a copy of Advisory Circular No. 11-2 which describes the application procedure.

The Proposal

The FAA proposes an amendment to § 71.181 of part 71 of the Federal Aviation Regulations (14 CFR part 71) to provide controlled airspace for instrument flight rules procedures for the new VOR/DME approach to the Sun River Airport. The intent is to segregate aircraft operating in visual flight rules conditions from those operating under instrument flight rules. The area would be depicted on appropriate aeronautical charts so that pilots may circumnavigate the area or comply with instrument flight rules procedures. Section 71.181 of part 71 of the Federal Aviation Regulations was republished in Handbook 7400.6G dated September 4, 1990.

The FAA has determined that this proposed regulation only involves an established body of technical regulations for which frequent and routine amendments are necessary to keep them operationally current. It, therefore—(1) is not a "major rule" under Executive Order 12291; (2) is not a "significant rule" under DOT Regulatory Policies and Procedures (44 FR 11034; February 26, 1979); and (3) does not warrant preparation of a regulatory evaluation as the anticipated impact is so minimal. Since this is a routine matter that will only affect air traffic procedures and air navigation, it is certified that this rule, if promulgated, will not have a significant economic impact, positive or negative, on a substantial number of small entities under the criteria of the Regulatory Flexibility Act.

List of Subjects in 14 CFR Part 71

Aviation safety, Transition areas.

The Proposed Amendment

Accordingly, pursuant to the authority delegated to me, the Federal Aviation Administration proposes to amend part 71 of the Federal Aviation Regulations (14 CFR part 71) as follows:

PART 71—DESIGNATION OF FEDERAL AIRWAYS, AREA LOW ROUTES, CONTROLLED AIRSPACE, AND REPORTING POINTS

1. The authority citation for part 71 continues to read as follows:

Authority: 49 U.S.C. 1348(a), 1354(a), 1510; Executive Order 10854; 49 U.S.C. 106(g) (Revised Pub. L. 97-449, January 12, 1983); 14 CFR 11.69.

§ 71.181 [Amended]

2. Section 71.181 is amended as follows:

Sun River, Oregon [New]. That airspace extending upward from 700 feet above the surface within a 7-mile radius of the Sun River, OR Airport (lat. 43°52'30" N., Long. 121°27'08" W.), and within 4 miles each side of the Redmond, OR VORTAC (lat. 44°15'11" N., long. 121°18'09" W.) 197° radial extending from the 7-mile radius to 10 miles north of the Sun River Airport.

Issued in Seattle, Washington, on June 26, 1991.

Helen M. Parke,

Assistant Manager, Air Traffic Division.

[FR Doc. 91-17773 Filed 7-25-91; 8:45 am]

BILLING CODE 4910-13-01

ENVIRONMENTAL PROTECTION AGENCY

40 CFR Part 372

[OPTS-400057; FRL-3928-4]

Sulfuric Acid; Toxic Chemical Release Reporting; Community Right-To-Know

AGENCY: Environmental Protection Agency (EPA).

ACTION: Proposed rule.

SUMMARY: EPA is granting a petition to modify the listing for sulfuric acid on the list of toxic chemicals subject to section 313 of the Emergency Planning and Community Right-to-Know Act of 1986 (EPCRA). Specifically, EPA is proposing to delete nonaerosol forms of sulfuric acid from the list of toxic chemicals subject to section 313. The proposal to delete non-aerosol forms of sulfuric acid is based on EPA's review of the available data on health and environmental effects of sulfuric acid. EPA has concluded that these forms of sulfuric acid cannot reasonably be anticipated to cause adverse effects to

human health or the environment under normal exposure scenarios.

DATES: Written comments must be submitted on or before September 24, 1991.

ADDRESSES: Written comments must be submitted in triplicate to: OTS Docket Clerk, TSCA Public Docket Office (TS-793), Environmental Protection Agency, Rm. NE-G004, 401 M St., SW., Washington, DC 20460, Attention: Docket Control Number OPTS-400057.

FOR FURTHER INFORMATION CONTACT: Maria J. Doa, Petitions Coordinator, Emergency Planning and Community Right-to-Know Information Hotline, Environmental Protection Agency, Mail Stop OS-120, 401 M St., SW., Washington, DC 20460, Toll free: 800-535-0202, Toll number: 703-920-9877.

SUPPLEMENTARY INFORMATION:

I. Introduction

A. Statutory Authority

This proposal is issued under sections 313(d) and (e)(1) of the Emergency Planning and Community Right-to-Know Act of 1986 (Pub. L. 99-499). EPCRA is also referred to as title III of the Superfund Amendments and Reauthorization Act of 1986.

B. Background

Section 313 of EPCRA requires certain facilities manufacturing, processing or otherwise using toxic chemicals to report their environmental releases of such chemicals annually. Beginning with the 1991 reporting year, such facilities also must report pollution prevention and recycling data for such chemicals, pursuant to section 7 of the Pollution Prevention Act (section 6007 of the Omnibus Budget Reconciliation Act of 1990, Pub. L. 101-506). Section 313 establishes an initial list of toxic chemicals that is comprised of more than 300 chemicals and 20 chemical categories. Any person may petition EPA to add chemicals to or delete chemicals from the list.

EPA issued a statement of petition policy and guidance in the *Federal Register* of February 4, 1987 (52 FR 3479), to provide guidance regarding the recommended content and format for submitting petitions. EPA must respond to petitions within 180 days either by initiating a rulemaking or by publishing an explanation of why the petition is denied. On May 23, 1991 (56 FR 23703), EPA published guidance regarding the recommended content of petitions to delete individual members of the section 313 metal compound categories.

II. Description of Petition

On December 24, 1990, EPA received a petition from the Environmental Policy Center on behalf of American Cyanamid to qualify the listing of sulfuric acid by requiring release reporting only for sulfuric acid aerosols and deleting other forms of sulfuric acid from the list of chemicals under section 313. At the request of the submitter, the statutory timeframe for response was suspended for 21 days. The present statutory deadline for EPA's response is July 13, 1991. American Cyanamid maintains that non-aerosol forms of sulfuric acid do not meet the statutory criteria for acute, chronic, or environmental effects under normal exposure scenarios. For the purposes of this proposal, EPA considers the term aerosol to cover any generation of airborne sulfuric acid, whether in the form of aerosols (including mists, vapors, gas, or fog) and without regard to particle size.

III. EPA's Technical Review of Sulfuric Acid

The technical review of the petition to delete sulfuric acid includes an analysis of the chemistry, health and environmental effects, production and use, environmental release, and exposure hazards known for the substance.

A. Chemistry

Sulfuric acid is a clear, colorless, odorless, oily liquid. In addition to being a strong acid, sulfuric acid is a strong oxidizing agent and therefore extremely corrosive. Sulfuric acid is very reactive with a variety of organic compounds. It is known to be flammable on contact with various organic materials such as chlorates, carbides, fulminates and picrates. Contact of sulfuric acid with metals can be explosive and produces sulfur dioxide and hydrogen gas. Sulfuric acid has a strong affinity for water, and will abstract it from air and organic materials with evolution of heat.

The method of manufacture is known as the contact process. This method essentially involves combustion of elemental sulfur, yielding sulfur dioxide, which is catalytically converted to sulfur trioxide. Reaction of the latter substance with water provides sulfuric acid with evolution of heat.

B. Toxicological Evaluation

Information on the health and environmental effects of sulfuric acid was obtained from the following sources: a 1984 EPA document entitled *Health Effects Assessment for Sulfuric Acid*, a 1989 EPA document entitled *An Acid Aerosols Issue Paper; Health*

Effects and Aerometrics, a 1987 EPA document entitled *Drinking Water Criteria Document for Sulfate*, studies found in the literature, and studies submitted by the petitioner.

Toxicological data on sulfuric acid were reviewed for evidence indicating acute and chronic toxicity, carcinogenicity, mutagenicity, reproductive toxicity, developmental toxicity, and environmental effects.

1. *Acute toxicity.* Sulfuric acid is a strongly acidic, corrosive substance, and is acutely toxic to all human tissue. The extent of tissue damage is dependent upon concentration and duration of exposure, and can range from a mild, transient irritation, to corrosion, chemical burn, and, in extreme and isolated cases, death. In 10 percent concentration, mild corneal injury was produced in rabbits; while a 1 percent solution failed to produce permanent ocular damage in rabbits, and was only slightly to non-irritating upon dermal exposure after 48 hours.

Reported cases of toxicity from ingested sulfuric acid were of an unusual origin, from either suicide attempts or accidental ingestion of sulfuric acid-containing products. Although toxicity in these cases is often severe, exposures of this type do not occur during normal use of sulfuric acid.

2. *Chronic toxicity.* Limited data on long-term human exposure to sulfuric acid with respect to occupational settings are available. Recent studies suggest that sulfuric acid aerosols at levels as low as 0.02 to 0.04 mg/m³ may cause significant effects on lung function in humans. Effects noted include increased risk of chronic bronchitis in smokers and reduced tracheobronchial clearance rate. Other studies suggest that sulfuric acid at concentrations as low as 0.04 mg/m³ may act synergistically with copollutants such as ozone, NO₂, and metal particulates in causing decreased pulmonary diffusing capacity and bronchial hypersensitivity. These effects are presumably attributable to the acidic and oxidative properties of sulfuric acid, and are therefore pH and concentration dependent. It should be noted that ambient atmospheric concentrations of sulfuric acid are typically 100 to 1,000-fold lower than concentrations known to have significant adverse effects.

The health effects of mixtures of sulfuric acid in aerosols is an area of toxicology which, to date, has not been thoroughly explored. However, environmental acid aerosol mixtures have been the subject of many epidemiological studies and have been implicated in causing and exacerbating a variety of respiratory ailments.

EPA has recently proposed to set a maximum contaminant level goal (MCLG) of 400 to 500 mg/liter of sulfate ions in drinking water (40 CFR part 141). The only adverse effects noted from exposure to higher levels (630 to 1,150 mg/liter) of sulfate are diarrhea and dehydration; infants being more sensitive than adults.

3. *Carcinogenicity.* Several epidemiological studies have suggested an association between occupational exposure to sulfuric acid aerosols and respiratory cancers such as laryngeal cancer. Several animal studies failed to show any relationship between exposure to sulfuric acid aerosols and respiratory cancers. There are no human or animal data indicating that solution forms of sulfuric acid are carcinogenic.

4. *Mutagenicity.* There is no evidence to conclude that sulfuric acid may reasonably be anticipated to cause heritable genetic mutations. Only one study was found which examined mutagenicity of sulfuric acid; it reported that sulfuric acid was not mutagenic to bacteria when tested at 0.002 to 0.005 percent concentrations.

5. *Reproductive and developmental toxicity.* Pertinent data regarding reproductive dysfunctions or developmental disorders could not be located in the literature. Consequently, there is no basis on which to conclude that sulfuric acid may reasonably be expected to cause serious or irreversible reproductive and/or developmental effects.

6. *Environmental effects.* Adverse environmental effects from sulfuric acid result from acidification. Available data indicate that the lethality of sulfuric acid to fresh water organisms occurs at pH 5 or lower. Egg laying ceased at pH 5, and the viability of eggs in one study was reduced by 50 percent at pH 6.5. Studies have shown that soil acidification below pH 5.5 results in large increases in liberated aluminum ions with a corresponding reduction in soil nitrification: soil nitrate (a plant nutrient) decreases, while soil ammonia (a plant toxicant) increases. Thus, although potential ecotoxicity from sulfate ions is negligible, prolonged exposure of terrestrial or aquatic environments to acidic conditions can be expected to produce adverse effects by releasing toxic cations, e.g., metals. Once mobilized, these materials can produce indirect toxicological effects.

C. Use, Release, and Exposure

1. *Production and use.* Sulfuric acid is the largest volume industrial chemical produced in the United States and in the world. The United States produced over 79 billion pounds of sulfuric acid in 1989.

Industrial utilization of sulfuric acid in the United States is estimated to be 84.8 billion pounds in 1991.

2. *Release and exposure.* The principal pathways for the release of sulfuric acid to the environment include air emissions, wastewater discharges, and underground injection of dilute solutions. The latter process constitutes the major method of disposal for this chemical.

It is estimated that 85 percent of the sulfuric acid present in the atmosphere worldwide results from the oxidation of SO₂ followed by reaction with atmospheric water. The presence of SO₂ in the atmosphere is largely due to coal burning and oil refining. It is estimated that direct sulfuric acid emissions from the manufacture and processing of sulfuric acid account for less than 5 percent of atmospheric sulfuric acid.

Under Clean Air Act regulations in 40 CFR part 60 subpart H, EPA regulates sulfuric acid air releases from sulfuric acid production in relation to the amount of acid manufactured; there is allowed to be no more than 0.075 Kg of sulfuric acid released per metric ton produced. Under the Clean Water Act, parameters such as pH may be subject to both technology-based and water quality-based limitations. The technology-based limitations are either derived from nationally applicable effluent guidelines or pretreatment standards (many of which limit pH to a range of 8.0 to 9.0) or are based on (1) The permit writer's "Best Professional Judgement" if there is no applicable guideline for a direct discharge or (2) local pretreatment requirements. Water quality based limitations generally would be established to ensure that applicable water quality standards are attained and maintained. Dischargers are typically subject to monitoring provisions under which permittees are to report discharges of controlled parameters.

Release of sulfuric acid solutions at or above pH 6 is not expected to result in adverse environmental effects. Under this section 313 reporting guidance, acid solutions with a pH of 6 or greater are considered by EPA as neutral, and as a result facilities are to report releases of these solutions to surface waters as zero.

In the case of underground injection, regulations promulgated under the Underground Injection Control (UIC) Program of the Safe Drinking Water Act (SDWA) specify that deep industrial waste disposal occurs in either Class I or Class V Wells. The standards, requirements and the permitting process for the design, operation, monitoring,

and closure of Class I Wells were designed to prevent contamination of underground sources of drinking water (USDW).

In addition to controls under the SDWA, regulations issued under the Resource Conservation and Recovery Act (RCRA) (40 CFR part 148) allow underground injection into a Class I Well of aqueous wastes with a pH of 2 or less only if the waste is the subject of a successful "no migration" petition. This petition must demonstrate that there will be no migration of hazardous constituents for as long as the waste remains hazardous. The petition must also show that the injected fluid will not migrate within 10,000 years. There is currently no evidence which indicates that underground injection of sulfuric acid by Class I Wells would result in adverse environmental effects.

Injection of hazardous waste into shallow injection wells is prohibited under RCRA section 3020 and the UIC program of the SDWA (40 CFR 144.13). The disposal of nonhazardous industrial waste, such as treated sulfuric acid, into shallow injection wells is the subject of the Agency's current Class V rulemaking proceedings. In the interim, such wells are still subject to the prohibition in section 1422 of the SDWA against any injection which may endanger a drinking water source, as defined in section 1421(d)(2).

Total on-site land releases into surface impoundments of sulfuric acid during 1988 was 5,348,114 pounds, or 2.8 percent of all on-site releases. Total off-site land releases during 1988 were 14,625,618 pounds, or 13.2 percent of all off-site releases. Regulations promulgated under RCRA at 40 CFR 261.22 provide that aqueous wastes that exhibit a pH of less than or equal to 2 are hazardous wastes. Land disposal of such wastes may take place only after pH adjustment above 2 or a successful "no migration" petition.

IV. Precedents for Modified Listings

There are precedents for qualified chemical listings under EPCRA section 313. The original list established by Congress contained a number of qualified listings including: aluminum (fume or dust), ammonium nitrate (solution), asbestos (friable), yellow or white phosphorus, vanadium (fume or dust), and zinc (fume or dust). Also, EPA recently qualified the aluminum oxide listing by exempting non-fibrous forms of aluminum oxide from the reporting requirements so that only fibrous aluminum oxide is subject to reporting (40 CFR part 372). EPA found that there was no evidence that non-fibrous forms of aluminum oxide cause adverse

human health or environmental effects as specified under section 313. The decision to retain fibrous forms of aluminum oxide was based on evidence that exposure to fibrous forms of this chemical can reasonably be anticipated to cause cancer in humans.

V. Rationale for Proposed Modification of the Sulfuric Acid Listing

Sulfuric acid aerosols meet the toxicity criteria of section 313(d)(2). EPA's decision to delete non-aerosol forms of sulfuric acid is based on the Agency's evaluation of sulfuric acid's toxicity and the levels of sulfuric acid exposure to which humans and the environment may be subject. The non-aerosol forms of sulfuric acid are acutely toxic at a low pH; however, there is no information to indicate that non-aerosol forms of sulfuric acid present a health or environmental risk under ordinary exposure scenarios. The Agency believes that there is no evidence that non-aerosol sulfuric acid releases cause adverse effects to human health or the environment under ordinary exposure scenarios. The substance's toxic properties are dependent upon concentration and duration of exposure. Only under aberrant conditions of exposure (i.e., spills onto the skin, deliberate ingestion) do solutions of sulfuric acid pose a potentially serious health hazard.

EPA does not believe that non-aerosol forms of sulfuric acid meet the statutory criteria of section 313(d)(2)(A) regarding acute human health effects; specifically, that the "chemical is known to cause or can reasonably be anticipated to cause significant adverse human health effects at concentration levels that are reasonably likely to exist beyond facility boundaries as a result of continuous or frequently recurring releases." EPA's review of the toxicity and exposure information indicates that although sulfuric acid is acutely toxic it is unlikely that persons will be exposed to acutely toxic concentration levels beyond facility boundaries as "a result of continuous or frequently recurring releases."

Also, EPA does not believe that non-aerosol forms of sulfuric acid meet the chronic toxicity listing criteria in section (d)(2)(B) because the chemical in its non-aerosol forms is not known to cause nor can reasonably be anticipated to cause chronic health effects. The environmental listing criteria also are not met because the non-aerosol forms of sulfuric acid are not known to cause nor can be reasonably anticipated to cause a significant adverse effect on the environment of sufficient seriousness to warrant release reporting.

Additionally, other statutory mechanisms exist by which information on spills of sulfuric acid will be made available to the public. For example, sulfuric acid is a hazardous substance under the Comprehensive Environmental Response, Compensation, and Liability Act of 1980 (CERCLA).

Releases of 1,000 pounds or more of sulfuric acid must be reported to the National Response Center under CERCLA section 103. CERCLA section 103 requires that the person in charge of a facility or vessel immediately report a release of a reportable quantity or more of sulfuric acid (other than a federally permitted release) to the National Response Center. This section also provides a reduced reporting requirement for releases determined to be "continuous" and "stable in quantity and rate" (July 24, 1990, 55 FR 30166). Releases of 1,000 pounds or more also must be reported to State and local authorities under EPCRA section 304. EPCRA section 304 requires the owner or operator of a facility to immediately report to the State emergency response commission and the local emergency planning committee when there is a release of a CERCLA hazardous substance requiring a report under CERCLA section 103(a) or when there is a release of one pound or more of a non-CERCLA Extremely Hazardous Substance (EHS). This section does not apply to any release which results in exposure to persons solely within the site on which a facility is located.

Deleting non-aerosol forms of sulfuric acid from the section 313 list will not result in any significant reduction in the information now available to the public concerning spills of sulfuric acid. Since reporting of spills under section 313 is only required to be submitted to EPA as part of an overall annual release number, no direct and immediate notice to the public of such an accidental release or spill of sulfuric acid is available through section 313 reports or through the Toxics Release Inventory (TRI) data base, i.e., only annual release figures are available.

In addition, data on storage of sulfuric acid for emergency planning purposes are already being collected at the local level. Under sections 311 and 312 of EPCRA, facilities are required to submit lists and inventories of chemicals on-site to local emergency planning committees to help them plan for emergencies and inform the public about the types of chemicals being handled in their communities.

Therefore, EPA proposes to modify the listing for sulfuric acid by deleting

non-aerosol forms of sulfuric acid. EPA's proposal to delete non-aerosol forms of sulfuric acid from the section 313 list is not meant to suggest that the Agency considers sulfuric acid to be a "safe" chemical. Rather, this proposed action reflects the fact that non-aerosol forms of the chemical do not meet the toxicity criteria set forth in section 313.

Currently, most facilities base their threshold determinations for reporting under section 313 on the amounts of sulfuric acid in solution form manufactured, processed, or otherwise used. For purposes of threshold determinations of sulfuric acid (acid aerosols) for reporting under section 313, a facility should consider any generation of airborne sulfuric acid as manufacture, whether in the form of aerosols (including mists, vapors, gas, or fog) and without regard to particle size. The quantity of airborne sulfuric acid manufactured, not the amount released, would be compared with the 25,000 pound threshold. Generation of airborne sulfuric acid is expected to occur from, but is not limited to: production or processing of sulfur trioxide (SO₂), due to the extremely rapid reaction of sulfur trioxide with atmospheric water within the process or facility, production or processing of solutions of sulfuric acid, and volatilization or vaporization of sulfuric acid from manufacture or processing.

VI. Rulemaking Record

The record supporting this decision is contained in docket control number OPTS-400057. All documents, including an index of the docket, are available to the public in the TSCA Public Docket Office from 8 a.m. to noon and 1 p.m. to 4 p.m., Monday through Friday, excluding legal holidays. The TSCA Public Docket Office is located at EPA Headquarters, rm. NE-G004, 401 M St., SW., Washington, DC 20460.

VII. Request for Public Comment

EPA requests comment on this proposal to delete non-aerosol forms of sulfuric acid from the listing of toxic chemicals under EPCRA section 313. All comments must be submitted on or before September 24, 1991.

VIII. Regulatory Assessment Requirements

A. Executive Order 12291

Under Executive Order 12291, EPA must judge whether a rule is "major" and therefore, requires a Regulatory Impact Analysis. EPA has determined that this is not a "major rule" because it will not have an effect on the economy of \$100 million or more.

This proposed rule would decrease the impact of the section 313 reporting requirements on covered facilities and would result in cost-savings to industry, EPA, and the States. Therefore, this is a minor rule under Executive Order 12291.

This proposed rule was submitted to the Office of Management and Budget (OMB) under Executive Order 12291.

The current number of sites reporting releases of sulfuric acid is 5,347. Of these, 2,772 reported for sulfuric acid but reported no releases in aerosol form. Thus under the proposed rule these sites would no longer report. Also, the economic analysis estimated that of the 2,575 reporting sites that reported air releases, 1,069 to 2,128 sites would no longer be required to report depending on their treatment efficiency of stack emissions because they would no longer meet the threshold for reporting. Thus the decrease in the number of reporting sites attributable to the rulemaking is estimated at between 3,841 (2,772 + 1,069) and 4,900 (2,772 + 2,128). The estimated cost savings to industry changing the listing is estimated at \$1,267 per year per reporting facility that no longer is required to report. The cost saving to EPA is \$72 per facility per report. The lower bound estimate of the total annual savings for industry and EPA from the partial delisting of sulfuric acid is \$5,143,099. The upper bound estimate is \$6,561,100 in savings annually.

B. Regulatory Flexibility Act

Under the Regulatory Flexibility Act of 1980, the Agency must conduct a small business analysis to determine whether a substantial number of small entities will be significantly affected by a proposed rule. Because the proposed rule results in cost savings to facilities, the Agency certifies that small entities will not be significantly affected by the proposed rule.

C. Paperwork Reduction Act

This proposed rule does not have any information collection requirements under the provisions of the Paperwork Reduction Act of 1980, 44 U.S.C. 3501 et seq.

List of Subjects in 40 CFR Part 372

Chemicals, Community right-to-know, Environmental protection, Reporting and recordkeeping requirements, Toxic chemicals.

Dated: July 15, 1991.

Victor J. Kimm,

Acting Assistant Administrator, Office of Pesticides and Toxic Substances.

Therefore, it is proposed that 40 CFR part 372 be amended as follows:

1. The authority citation for part 372 would continue to read as follows:

Authority: 42 U.S.C. 11013 and 11028.

§ 372.65 [Amended]

2. In § 372.65(a) and (b) are amended by changing the entry for sulfuric acid to read "Sulfuric acid (acid aerosols)" under paragraph (a) and for CAS number entry 7664-93-9 under paragraph (b).

[FR Doc. 91-17596 Filed 7-25-91; 8:45 am]

BILLING CODE 6560-50-F

FEDERAL COMMUNICATIONS COMMISSION

47 CFR Parts 61 and 69

[CC Docket No. 91-141; FCC 91-159]

Expanded Interconnection With Local Telephone Company Facilities

AGENCY: Federal Communications Commission.

ACTION: Proposed rule.

SUMMARY: The Commission initiated a notice of proposed rulemaking and notice of inquiry to consider removing barriers that currently impede the development of greater competition in the provision of interstate access transmission facilities. In light of changing technological and market conditions, the Commission proposes to require that the Tier 1 local telephone companies offer expanded opportunities for interconnection with their networks for the provision of interstate special access service. The Commission also begins an inquiry into expanded interconnection for the provision of interstate switched transport service.

DATES: Comments are to be filed by August 6, 1991, and replies are to be filed by September 5, 1991.

ADDRESSES: Federal Communications Commission, 1919 M Street, NW., Washington, DC 20554.

FOR FURTHER INFORMATION CONTACT: Douglas Slotten (202) 632-9342, or Claudia Pabo (202) 632-4047, Policy and Program Planning Division, Common Carrier Bureau.

SUPPLEMENTARY INFORMATION: The collection of information contained in this proposed rule has been submitted to the Office of Management and Budget for review under section 3504(h) of the Paperwork Reduction Act (44 U.S.C. 3504(h)). Copies of this submission may be purchased from the Commission's copy contractor, Downtown Copy Center (202) 452-1422, 1114 21st St.,

NW., Washington, DC 20036. Persons wishing to comment on this collection of information should direct their comments to Jonas Neihardt (202) 395-4814, Office of Management and Budget, Room 3235 NEOB, Washington, DC 20503. A copy of any comments filed with the Office of Management and Budget should also be sent to the following address at the Commission: Federal Communications Commission, Office of Managing Director, Paperwork Reduction Project (3060-0298), Washington, DC 20554. For further information contact Judy Boley, 202-632-7513.

OMB Number: 3060-0298.

Title: Part 61—Tariffs (Other than Tariff Review Plan); Part 69—Access Charges.

Action: Proposed revision.

Respondents: Businesses or other for-profit.

Frequency of Response: On occasion.

Estimated Annual Burden: 1015 respondents; 2.67 responses per respondent; 258.13 hours per response; 696,950 hours total annual burden.

Needs and Uses: In this rulemaking, the Commission proposes requiring additional cost support and creation of a new price cap sub-index for services used by interconnecting parties to ensure that LECs offer expanded interconnection services at just, reasonable, and non-discriminatory rates. If this proposal is adopted, the additional cost support and the new price cap sub-index would be used by regulators to evaluate the lawfulness of the rates for expanded interconnection services.

Summary of Notice of Proposed Rulemaking and Notice of Inquiry

This is a summary of the commission's notice of proposed rulemaking and notice of inquiry in CC Docket No. 91-141, adopted May 9, 1991, released June 8, 1991. The full text of this Commission decision is available for inspection and copying during normal business hours in the FCC Dockets Branch (room 239), 1919 M Street, NW., Washington, DC. The complete text of this decision may also be purchased from the Commission's copy contractors, Downtown Copy Center, 1114 21st Street, NW., Washington, DC 20037, (202) 452-1422.

In major metropolitan areas, competitive access providers (CAPS) currently compete with the local exchange carriers (LECs) in the provision of special access connections between customer premises and interexchange carrier points of presence (POPs). The Commission's current special access rate structure, however,

effectively precludes CAPs or other interested parties from interconnecting with a local exchange carrier (LEC) to provide a portion of a special access line with the LEC providing the remainder. In light of recent technological and economic changes, the Commission tentatively concludes that expanded opportunities for third-party interconnection with LEC facilities for the provision of interstate special access services, with its likely increase in competition, will produce significant benefits for consumers that will outweigh any potential costs. The Commission invites interested persons to comment on this conclusion.

The Commission tentatively concludes that it should establish minimum criteria for the implementation of expanded interconnection for interstate special access. The Commission states that these minimum criteria can be met by either physical or virtual collocation arrangements as each carrier chooses. In proposing to allow the LECs to satisfy their interconnection obligations through virtual collocation meeting the minimum requirements proposed here, the Commission hopes to achieve the major benefits of physical collocation while still permitting the LECs a viable choice between physical and virtual collocation.

The Commission tentatively concludes that an interconnecting party must be willing to interconnect its facilities with those of the LEC within one-eighth mile of a LEC central office in order to qualify for expanded interconnection. The Commission also tentatively concludes that an interconnecting party should have the ability to monitor and control its own circuits terminating in the LEC central office under virtual collocation arrangements. Additionally, the Commission tentatively concludes that under a virtual collocation approach, a LEC should be under an obligation reasonably to make available central office electronic equipment designated by the interconnector. The Commission invites comment on the proposed minimum terms and conditions for interconnection. The Commission also seeks comments on whether it should specify additional minimum interconnection criteria for either physical or virtual collocation. The Commission also asks for comment on the requirements that should apply to LECs implementing expanded interconnection on a voluntary basis. In addition, the Commission requests that parties address the use of these standards to govern the interconnection with LEC facilities of transmission

systems using non-fiber optic technology.

Finally, the Commission seeks comment on the treatment of proprietary equipment protocols used by interconnection equipment the LECs use to meet the needs of interconnecting parties. The Commission proposes that expanded interconnection for interstate special access be made available to all third parties, regardless of their possible classification as interexchange carriers (IXCs), end users, or CAPs, for example. The Commission also tentatively concludes that its proposed expanded interconnection rules should apply to all Tier 1 LECs (those with annual regulated revenues of over \$100 million annually). The Commission seeks comment on these proposals.

The Commission tentatively concludes that it should adopt a new special access rate structure to accommodate expanded interconnection for interstate special access, and it seeks comment on alternatives for restructuring special access recurring charges to reflect virtual and physical collocation. Although the Commission tentatively concludes that changes in the current rate structure for non-recurring charges are not necessary, the Commission requests that interested parties address this issue. In addition, the Commission seeks comment on the pricing of central office equipment and the recovery of maintenance costs for central office equipment dedicated to serving interconnecting parties under a virtual collocation approach.

Under physical collocation, the LEC would also impose rental charges for the use of central office, vaulting, and riser space, as well as associated support services by interconnecting parties. The Commission requests that interested parties address the benefits and drawbacks of using tariffs or individual contracts for defining the lease rates and terms as well as the proper regulatory classification of such offerings under the Communications Act.

State plans for expanded interconnection include an element that is sometimes described as a "contribution" element to be paid to the LEC by interconnecting parties. Such a mechanism could be used with either physical or virtual collocation. While the Commission states that the need for a contribution element is unclear, particularly in the context of interstate special access, it invites interested parties to comment on whether such an element is necessary to alleviate any hardships caused by changes resulting from expanded interconnection.

The Commission proposes that the LECs be required to implement expanded interconnection for DS1 and DS3 services as soon as possible after adoption of an order in this proceeding. In the case of other special access services, the Commission proposes to allow the LECs to implement the new rate structure changes for each of the four price cap special access service categories upon receipt of a request for expanded interconnection for the provision of one or more services in the category.

The Commission observes that, with the advent of competition, the LECs may need added rate structure flexibility to compete for special access traffic. At the same time, the Commission may wish to proscribe certain possible forms of competitive response by the LECs on the ground that they do not represent fair competition. Accordingly, the Commission believes that it may be appropriate to consider whether to establish new guidelines for review of LEC rate structure responses to competition, such as volume discounts, or distance-sensitive pricing of connection charges, channel termination charges, or their equivalents. The Commission also seeks comment on whether guidelines should be developed for review of any LEC proposals to increase channel termination charges for the connection from the customer premise to the end office and to reduce rates for the connection between the LEC end office and the IXC POP or other customer designated termination point.

Although price cap standards for rate review generally provide necessary protection, the Commission tentatively concludes that the initial charges for rate elements implementing expanded interconnection for the provision of special access by price cap LECs should be subject to special scrutiny insofar as they apply to interconnecting parties, many of whom are the LEC's competitors. The Commission tentatively concludes that the initial rates for the new elements to be paid by interconnecting parties should be reviewed not only under the existing price cap rules, but also pursuant to additional standards adopted in this proceeding. The Commission tentatively concludes that the price cap LECs should be required to justify the initial rate levels tariff elements implementing expanded interconnection used by their competitors, whether deemed new or restructured services under price caps. In particular, the Commission proposed that the LECs be required to describe how they determined the direct costs of providing expanded interconnection

service and explain the overhead loadings used in rate development. In addition, the Commission proposes to require justification of the initial price level of any "contribution" element. The Commission also proposes to apply this level of scrutiny, insofar as feasible, to price cap LECs that voluntarily offer expanded interconnection for the provision of interstate special access. At the same time, the Commission invites interested parties to consider options for providing the protections necessary in these circumstances through pricing regulation.

The Commission proposes that ongoing changes in special access rates for price cap carriers be subject to a price ceiling for a separate subindex of the services used by interconnecting parties, i.e., connection charges and special central office service charges. The Commission proposes that pricing flexibility for this rate element group be limited to annual increases of two percent relative to the percentage change in the price cap index for the special access service basket. Under this proposal, the connection and special central office service charges would also be included in the four special access service groups for purposes of applying the banding restrictions applicable to those groupings. The Commission proposes that the price of any "contribution" element be set at a specified level, and thereafter subject to change only through further order or recalculation pursuant to a prescribed formula. The Commission does not propose to change the rate bands applicable to the LECs' DS1 or DS3 offerings at this time. The Commission seeks comment on these proposals. The Commission seeks comment on the proper standards for review of the initial prices and subsequent price changes for the rate elements implementing expanded interconnection offered by rate of return LECs.

The Commission tentatively concludes that increased competition in the provision of interstate special access services will not have significant undesirable collateral effects. The Commission believes that authorizing expanded interconnection for interstate special access will not have adverse separations effects on the states. The Commission does not anticipate that expanded special access competition will have an adverse effect on rates for other LEC services, either. The Commission also noted state concerns that expanded interstate access competition would deprive states of authority over the development of

intrastate access competition. The Commission invited interested parties to comment on these issues.

Summary of Notice of Inquiry

As a second step in the Commission's initiative to remove barriers to entry, thereby fostering the development of competition in the provision of interstate access facilities and services, the Commission instituted a notice of inquiry concerning the competitive provision of interstate switched transport service. This action will permit the Commission to gather additional information before determining whether to proceed with a proposal for expanded interconnection to permit the competitive provision of interstate switched transport service.

The Commission generally notes that parties should assume that the requirements for expanded interconnection for the provision of switched transport would parallel those for special access, and seeks comment on these issues.

The Commission notes that if expanded interconnection were to be adopted for switched transport, CAPs presumably would charge a cost-based flat rate for dedicated transport that could be more attractive to high-volume interstate access users than the current usage-based LEC switched transport rates. The Commission seeks comment on possible LEC responses to CAP flat rate pricing in the event of expanded interconnection for the provision of this service. The Commission also seeks comment on the need for a contribution element in connection with expanded interconnection for switched transport.

In addition, the Commission requests that interested parties address the possible effects of expanded interstate switched transport interconnection on universal service as a result of jurisdictional cost shifts, the ability of the states to enforce their own regulations, and subsidy issues. The Commission specifically seeks comment on the areas in which subsidies are perceived to exist, the magnitude of such subsidies, and the potential effect of increased access competition on these subsidies.

Ex Parte Rules

1. This is a non-restricted notice and comment rulemaking proceeding. See generally § 1.1206(a) of the Commission's rules, 47 CFR 1.1206(a), for rules governing permissible *ex parte* contacts.

Regulatory Flexibility Requirements

2. Pursuant to the Regulatory Flexibility Act, the Commission certifies that the proposals made in this proceeding will not have a significant economic impact on a substantial number of small entities, and that the Regulatory Flexibility Act is, therefore, not applicable to this proceeding.

Ordering Clauses

3. Accordingly, *it is ordered*, That Notice is hereby given of the proposed regulatory changes in interconnection for the provision of interstate special access described above, and that comment is invited on these proposals.

4. *It is further ordered*, That a notice of inquiry is instituted concerning the regulatory changes in interconnection for the provision of interstate switched transport described above, and that comment is invited on these proposals.¹

5. *It is further ordered*, That the Petition for Rulemaking filed by MFS is granted to the extent indicated herein. The Petition for Declaratory Ruling filed by Teleport is also granted to the extent indicated herein.

List of Subjects in 47 CFR Part 61 and 69

Communications common carriers, Reporting and recordkeeping requirements, Telephone.

Federal Communications Commission.

William F. Caton,
Acting Secretary.

[FR Doc. 91-17826 Filed 7-25-91; 8:45 am]

BILLING CODE 6712-01-M

47 CFR Parts 73 and 76

[MM Docket No. 91-168, DA 91-907]

Radio Broadcast and Television Broadcast Services; Codification of the Commission's Political Programming Policies

AGENCY: Federal Communications Commission.

ACTION: Proposed rule; extension of comment period.

SUMMARY: This action extends the time for filing comments and reply comments to the notice of proposed rule making (notice) in MM Docket No. 91-168, 56 FR 30526 (July 3, 1991). The notice seeks comment on a variety of issues concerning political programming

¹ These actions are taken pursuant to sections 1, 4(i) and (j), 201-205, 218, 220, and 403 of the Communications Act as amended, 47 U.S.C. 151, 154 (i) & (j), 201-205, 218, 220, and 403.

obligations under the Communications Act. The National Association of Broadcasters and other interested parties requested the extension of time. Based on the complexity of the matters raised in the notice in this proceeding, we find the requested extension of time warranted.

DATES: Comments are now due on August 9, 1991, and reply comments are now due on August 23, 1991.

ADDRESSES: Federal Communications Commission, Washington, DC 20554.

FOR FURTHER INFORMATION CONTACT: Milton O. Gross, Mass Media Bureau, (202) 632-7586.

SUPPLEMENTARY INFORMATION:**Order**

Adopted: July 18, 1991.

Released: July 19, 1991.

By the Chief, Mass Media Bureau:

1. The National Association of Broadcasters and other interested parties request an extension of the time within which to file comments in the above captioned proceeding.¹ Comments are now scheduled to be filed on July 26, 1991, and reply comments are scheduled to be filed on August 14, 1991. Based on the complexity of the matters raised in the notice in this proceeding, the petitioners request that the time for filing comments be extended until August 9, 1991, and the reply comment date be extended until August 23, 1991.

2. Petitioners have shown good cause for this brief extension of time that will prolong the comment period in this proceeding by only 9 days. See 47 CFR 1.46.

3. Accordingly, *It Is Ordered*, That, Pursuant to authority delegated to the Chief, Mass Media Bureau in 47 CFR 0.283, the time for filing comments and reply comments in this proceeding are extended to August 9, 1991, and August 23, 1991, respectively.

Federal Communications Commission.

Roy J. Stewart,

Chief, Mass Media Bureau.

[FR Doc. 91-17766 Filed 7-25-91; 8:45 am]

BILLING CODE 6712-01-M

¹ In addition to the National Association of Broadcasters, the parties joining this request are: Allbritton Communications Company; American Family Broadcast Group, Inc.; Association of Independent Television Stations; CBS, Inc.; the Law Firm of Dow Lohnes & Albertson; the Law Firm of Fisher Wayland Cooper & Leader; the Law Firm of Fletcher Heald & Hildreth; Fox Television Stations, Inc.; and National Broadcasting Company, Inc.

DEPARTMENT OF THE INTERIOR**Fish and Wildlife Service****50 CFR Part 17**

RIN 1018-AB66

Endangered and Threatened Wildlife and Plants; Proposal To List the Sensitive Joint-Vetch (*Aeschynomene virginica*) as a Threatened Species

AGENCY: Fish and Wildlife Service, Interior.

ACTION: Proposed rule.

SUMMARY: *Aeschynomene virginica* is an annual legume that can grow up to six feet tall and has yellow, pea-type flowers growing in racemes on short lateral branches. It requires the unique growing conditions occurring along segments of river systems that are close enough to the coast to be influenced by tidal action, yet far enough upstream to consist of fresh or slightly brackish water. The present distribution of *A. virginica* includes New Jersey (two populations), Maryland (one population), Virginia (six populations) and North Carolina (two populations). The joint-vetch has been extirpated from Pennsylvania and Delaware. Habitat alteration is the primary threat to the species' continued existence. Many of the sites where the species occurred historically have been dredged, filled or bulkheaded. Extant sites are potentially threatened by a proposed highway expansion and a proposed electricity generating plant in New Jersey, by several proposed residential developments and water supply projects in Virginia, as well as by other factors related to increased population growth, including road construction, commercial development, water pollution, and bank erosion from motorboat traffic.

DATES: Comments from all interested parties must be received by September 24, 1991. Public hearing requests must be received by September 9, 1991.

ADDRESSES: Comments and materials concerning this proposal should be sent to the Annapolis Field Office, U.S. Fish and Wildlife Service, 1825 Virginia Street, Annapolis, MD 21401. Comments and materials received will be available for public inspection, by appointment, during normal business hours at the above address.

FOR FURTHER INFORMATION CONTACT: Ms. Judy Jacobs at the above address, telephone (301) 269-5448.

SUPPLEMENTARY INFORMATION:

Background

A rare and specialized ecological community type occurs a short distance upstream of where certain rivers in the coastal plain of the eastern United States meet the sea. Referred to as freshwater tidal marshes, these communities are close enough to the coast to be influenced by tidal fluctuations, yet far enough upstream to consist of fresh or only slightly brackish water. Plants that grow in this environment are subjected to a cycle of twice-daily flooding that most plants cannot tolerate. The sensitive joint-vetch (*Aeschynomene virginica*) is a plant of such freshwater tidal communities.

A. virginica is an annual legume (family Fabaceae) that attains a height of 1 to 2 meters (3-6 feet) in a single growing season. The stems are single, sometimes branching near the top. Leaves are even-pinnate, 2-12 centimeters (0.8-4.8 inches) long, with entire, gland-dotted leaflets. The irregular, legume-type flowers are about 1 cm (0.4 inch) across, yellow, streaked with red, and grow in racemes (elongated inflorescences with stalked flowers). The fruit is a loment with 6-10 segments, turning dark brown when ripe. Flowering begins late July and continues through September. Fruits are produced simultaneously from July to late October. Some observations indicate that seedlings may germinate only in "flotsam" (plant material) that has been deposited on the riverbank (Bruederle and Davison 1984).

Aeschynomene virginica has been confused with other members of the genus, particularly *A. indica*, which is an introduced, weedy species, common in wet agricultural areas from North Carolina to Florida, west to Texas and Arkansas. Another introduced member of this genus, *A. rudis*, has also been confused with *A. virginica*. This confusion has resulted in references to *virginica* in numerous week science publications (e.g. Boyette *et al.* 1979; Hackett and Murray 1986). The situation was clarified by Carulli and Fairbrothers (1988), who showed the three species to be distinguishable based on electrophoretic analysis of allozyme variation. Previous studies had also indicated the morphological distinctiveness of *A. virginica*. In her monograph of the genus, Rudd (1955) distinguishes *A. virginica* from *A. indica* based on the sizes of the fruit stipes and the flowers. Numerous other authors, including Fernald (1939), Gleason and Cronquist (1963) and Radford *et al.*

(1964) have recognized the taxonomic validity of *A. virginica*. The recently published *Vascular Flora of the Southeastern United States: Volume 3* (Isley 1990) clearly distinguishes these three species of *Aeschynomene*.

At present, the sensitive joint-vetch is extant in New Jersey, Maryland, Virginia and North Carolina. The plant's status in North Carolina merits special comment. During the mid-1980's, status survey work in North Carolina (Leonard 1985) revealed that the species was no longer extant at any of the five historic localities. Potential visible causes of population loss included commercial and housing developments, realignment of a highway, habitat conversion to a public beach, and competition from weedy species. In the course of survey work, six new occurrences of *A. virginica* were found, two in or adjacent to cornfields and the remainder in roadside ditches. These new populations, however, have not proven to be stable. Three disappeared the year following their discovery, and another population has since disappeared. As of the summer of 1990, *A. virginica* is known to be extant in North Carolina only in two ditches connected to Lake Mattamuskeet, in Hyde County. Intensive fieldwork in North Carolina's estuarine freshwater tidal marshes during the 1990 field season revealed no new joint-vetch populations (*A. Weakley*, North Carolina Heritage Program, pers. comm., 1990).

The currently known distribution of the species is as follows: New Jersey: one small population (+ 50 individuals) on Wading Creek in Burlington County and one large population (+ 2000 on the Manumuskin River in Cumberland County. The latter site, representing one of the few remaining examples of pristine freshwater tidal marsh habitat in the State and containing the largest known viable *Aeschynomene virginica* population, has been acquired by The Nature Conservancy. New Jersey historic records for *A. virginica* occur in Atlantic, Camden, Cape May, and Salem Counties. Additional potential habitat along the Mullica and Murice River Systems remains to be checked for the presence of jointvetch populations. Maryland: one population of about 200 individuals on Manokin Creek, in Somerset County; historic records from Anne Arundel, Calvert, Charles, Prince Georges and Wicomico Counties. All historic records have been recently field-checked. North Carolina: As Stated above, *A. virginica* was known as of the summer of 1990 from two ditches in Hyde County. The plant also occurred historically in Beaufort and Craven Counties. Virginia: This is the stronghold

of the species' current distribution. It occurs in six populations along four major river systems, as follows: (1) A population of about 40 individuals along the Potomac River in Stafford County; (2) an extensive population consisting of seven sub-populations along approximately 25 miles of the Rappahannock River in King George, Essex, Richmond and Westmoreland Counties; (3) a large population consisting of five sub-populations along an approximate 15-mile stretch of the Mattaponi River, a tributary of the York in Kind and Queen and King William Counties; (4) five subpopulations along a 15-mile section of the Pamunkey River, another tributary of the York (King William and New Kent Counties); (5) a population of about 50 plants on the Chickahominy River, a tributary of the James River, in Charles City and James City Counties; and (6) a tiny population of some eight plants along the mainstem of the James River, in Charles City County. The species is apparently extirpated from its type locality further downstream on the Rappahannock in Middlesex County. Historic records also exist for Prince George and Surry Counties, along the James River. The historic range of the species also included Delaware, (New Castle County), where it was last observed in 1899, and Pennsylvania (Delaware County), where it was last seen in 1891.

Federal government actions on this species began on December 15, 1980, when the Service published in the Federal Register a revised Notice of Review for Native Plants (45 FR 82480). *Aeschynomene virginica* was included in that notice as Category 2 species. Category 2 includes those taxa for which proposing to list as endangered or threatened species is possibly appropriate, but for which substantial data on biological vulnerability and threats are not currently available to support proposed rules. On November 28, 1983, the Service published in the Federal Register a supplement to the Notice of Review for Native Plants (48 FR 53640); updated plant notices have been published on September 27, 1985 (50 FR 39526) and February 21, 1990 (55 FR 6184). *A. virginica* was included in these revisions as a Category 2 species.

In 1985 the Service contracted with The Nature Conservancy's Eastern Regional Office to conduct status survey work on *A. virginica* and several other Federal candidate species. Their report (Rawinski and Cassin 1986) indicated that sufficient information did not exist at that time to support listing *A. virginica* as endangered or threatened. They recommended retention of this species in Category 2. Since this report

was submitted, four known occurrences of the species in North Carolina have disappeared, taxonomic uncertainties have been resolved, further surveys of potential habitat have been conducted, and threats to the species' continued existence have intensified sufficiently to support a listing as threatened.

Summary of Factors Affecting the Species

Section 4(a)(1) of the Endangered Species Act (16 U.S.C. 1531 *et seq.*) and regulations (50 CFR part 424) promulgated to implement the listing provisions of the Act set forth the procedures for adding species to the Federal lists. A species may be determined to be an endangered or threatened species due to one or more of the five factors described in section 4(a)(1). These factors and their application to *Aeschynomene virginica* (L.) B.S.P. (sensitive joint-vetch) are as follows:

A. The Present or Threatened Destruction, Modification, or Curtailment of Its Habitat or Range

The extirpation of the sensitive joint-vetch from Delaware and Pennsylvania and its elimination from many sites in other states can be directly attributed to anthropogenic habitat destruction. Many of the marshes where it occurred historically have been dredged and/or filled and the riverbanks bulkheaded or stabilized with riprap. This is most evident in historic locations around Philadelphia (Bruederle and Davison 1984). Other sources of potential or actual habitat destruction include impoundments and water withdrawal projects, road construction, commercial and residential development, and resultant pollution and sedimentation.

The remaining stronghold of *A. virginica* is in Virginia, along the relatively narrow band of freshwater tidal sections of several river systems on the coastal plain. These river sections are quite pristine, given their proximity to the major metropolitan areas of Washington, D.C. and Richmond, Virginia. As the suburbs associated with these cities expand, the impacts to these river sections from residential and commercial development, shoreline stabilization activities, point and non-point source discharges, recreational use, water development projects, and sedimentation from building and road construction, are all expected to increase greatly.

Certain of these factors are known to be harmful to *Aeschynomene virginica*; others require further study to determine their effects. Shoreline stabilization, as in placement of riprap, can destroy the

species' habitat directly. Increased motorboat traffic is known to be detrimental to freshwater tidal systems (A.E. Schuyler, Philadelphia Academy of Natural Sciences, pers. comm., 1989). In addition to direct toxic effects from fuel leaks, the wave action from boat wakes can rapidly erode the mudflats and banks where the joint-vetch grows. Along narrower river sections, the wake from a single boat may affect both shorelines simultaneously.

Sedimentation could affect *A. virginica* by inhibiting germination, smothering seedlings and/or promoting the invasion of weedy species. Sipple (1990) notes that sedimentation of the Patuxent River in Maryland has allowed the common reed (*Phragmites australis*) to extend its range, displacing much of the wild rice (*Zizania aquatica*) that occurred historically along this river. Establishment of *Phragmites* or other invasive species could be especially detrimental to *A. virginica*, which has evolved to thrive in an environment with little competition from other plants.

Two specific projects could threaten New Jersey's large population of *A. virginica*. One is the extension of a major highway, which is proposed to cross the Manumuskin River in the vicinity of the population. The plants and their habitat could be destroyed directly, during the construction process, or indirectly, through input of sediments, road salt, or petrochemicals. The other project is a coal-powered electric generating facility, proposed to be located less than a mile upstream from the population. There is concern that the disposal of by-products from this facility could degrade the plants' habitat.

Maryland's one known joint-vetch population is located along Manokin Creek, adjacent to a major highway. In addition to being vulnerable to various pollutants associated with the road, the population is flanked by invasive weeds, including *Phragmites australis* and multiflora rose (*Rosa multiflora*).

In Virginia, most of the potential threats facing *Aeschynomene virginica* and its habitat are associated with population growth. Within the Chesapeake Bay watershed, Virginia's population is projected to increase by 32% by the year 2020, a rate nearly twice that predicted for Maryland (19%) and four times that for Pennsylvania (8%) (Year 2020 Panel 1988). In areas local to the occurrence of *Aeschynomene virginica*, growth rates may be even greater. Over the past ten years the human population of King William County near the Mattaponi River joint-vetch population has grown more than 60 per cent (Oberg 1990), and this growth rate is projected to continue.

Residential development associated with this population increase is becoming evident. In early 1991, a 200-acre subdivision was completed in eastern King and Queen County. This development includes a boat launch and pier on the Mattaponi. In the western part of the county, efforts are underway to secure the necessary zoning for a 500-acre development, which would include river access, an 18-hole golf course and other amenities. Without careful planning, such developments are likely incompatible with the continued existence of *Aeschynomene virginica*. The plants' habitat can be destroyed by the construction of piers and dredging of boat slips or other recreational purposes. Additionally, water quality degradation in streams harboring *A. virginica* can result from uncontrolled runoff of pesticides, fertilizers, and other chemicals used on golf courses, lawns and gardens. Increased sewage effluent in the area may result in increased nutrient loading or pollution of local stream systems.

Development pressures of great magnitude are also found close to the Washington, DC area. In 1987, a 1000-acre development was proposed on the Widewater Peninsula, a finger of land in Stafford County, Virginia, that harbors the sole known Potomac River occurrence of *Aeschynomene virginica*. The original proposal called for over 3150 dwellings, a conference center, golf course, air strip, stores, offices, a 1000-slip marina and industrial uses. This proposal required a rezoning, which was rejected. However, several alternative planned developments have been proposed, and the current intended land use of this area is for relatively high intensity waterfront development, which, without careful planning, may not be compatible with the continued existence of *A. virginica*.

In addition to expanded residential development, the population increase in Virginia will be accompanied by an increased demand for potable water. Tidal freshwater river systems are the source of freshwater in closest proximity to coastal communities and the obvious choice for obtaining this necessary commodity. The construction of Walker's Dam has already eliminated the tidal influence on a significant portion of the Chickahominy River, perhaps destroying joint-vetch habitat in the process.

Currently, the Newport News Waterworks projects a water deficit of 35 million gallons per day (mgd) by the year 2040. The utility is beginning to evaluate numerous water supply options, three of which could potentially

affect *A. virginica* habitat. First is the withdrawal of 40 mgd from the James River above Richmond. A second alternative would involve a pump over from the Pamunkey and Chickahominy Rivers (a 40 mgd withdrawal rate is proposed for each river). A third alternative calls for a maximum 75 mgd withdrawal from the Mattaponi River (B. Gladden, TNC, Charlottesville, VA, pers. comm., 1991).

Spotsylvania County has projected that it will need to increase its capacity to provide potable water by 1995. The County has applied for a permit to withdraw some 8.2 mgd from Po Creek (a tributary of the Mattaponi River). Stafford and Spotsylvania Counties and the City of Fredericksburg are also discussing a 24 mgd withdrawal from the Rappahannock River at Fredericksburg.

Hanover County, Virginia, proposes to begin operating a reservoir for public water supply to the Mechanicsville-Chickahominy area by the end of this century. The reservoir would be created by constructing a cross-stream impoundment on Crump Creek, a tributary to the Pamunkey River. The implementation of this proposal would include a 25 mgd withdrawal from the Pamunkey River.

The effects of these proposed water supply projects on *A. virginica* are very likely to be detrimental and clearly need to be evaluated, both on a local and a regional basis. The withdrawal of large amounts of freshwater could raise the salinity of the marsh systems occupied by the joint-vech, possibly beyond the species' tolerance limits. Certain other key plant and animal species in this community type could also succumb, with unknown impacts to the system as a whole. Salinity changes might also promote the invasion of weedy plant species that could readily out-compete the joint-vech.

B. Overutilization for Commercial, Recreational, Scientific, or Educational Purposes

A. virginica has not been a target for collection, since it grows in a specialized habitat and would not survive under normal garden conditions. The plant has been collected in the past for scientific study. The increased visibility of the species as a result of the publication of this proposed rule might increase the perceived value of specimens to collectors.

C. Disease or Predation

Observations in North Carolina have indicated severe depredation of seeds by tobacco budworms and corn earworms (Leonard 1985). It is unlikely

that these predators would prove to be a problem in other populations throughout the species' range, as they would not occur in typical wetland habitat.

D. The Inadequacy of Existing Regulatory Mechanisms

The sensitive joint-vech is listed as endangered by the States of Maryland, New Jersey, and North Carolina, but is afforded no legal protection in Virginia. The Maryland Threatened and Endangered Species regulations (COMAR 08.03.08) prohibit taking of endangered plant species from State property except by special permit, and further prohibit taking from private property without the written permission of the landowner. However, these regulations do not prohibit alteration of the habitat in which these species occur. Protection of habitat is afforded *Aeschynomene* under Maryland's Critical Areas legislation. COMAR 14.15.09 prohibits any activity that may adversely affect any endangered or threatened species or its habitat within 100 feet of the upper limit to a tidal wetland. The joint-vech is afforded legal protection in North Carolina by North Carolina general statutes § 106-202.122, 106-202.19 (CUN.SUP.1985), which prohibit interstate trade without a permit, prohibit taking without written permission of landowners, and provide for monitoring and management of state-listed species. However, this legislation provides no habitat protection for listed species. In Virginia, the State with the greatest number of populations of *A. virginica*, there is no protection. Even if the species were listed under Virginia's Endangered Plant and Insect Species Act (title 3.1, chapter 39), it would be protected from take, but destruction or alteration of its habitat would be unregulated. In these States, listing under the Endangered Species Act would provide additional protection particularly for the habitat of *A. virginica*. In New Jersey, numerous laws pertain to the protection of endangered plants. The New Jersey Endangered Plant Species List Act (NJ SA 13:1B-15.151-158) merely provides for the creation of a list of rare plants and offers no protection from take or habitat alteration. However, other State laws provide substantial protection. One New Jersey population occurs within the area protected by the Pinelands Protection Act (NJ AC 7:50-8.24), which prohibits any development that would adversely affect the survival of any local population of an endangered or threatened species. The regulations governing the Coastal Area Facility Review Act (N.J.S.A. 13:19-1 *et seq.*) state that habitat for endangered and

threatened species on Federal or State lists or under active consideration for inclusion on either list will be considered "special areas". Development in these areas is prohibited unless it can be shown that the rare species' habitat would not be adversely affected. The population protected under the Pinelands legislation also falls within the area covered by this Act. The New Jersey Freshwater Wetlands Protection Act (N.J.S.A. 13:9B-1 *et seq.*) prohibits regulated activities from jeopardizing threatened or endangered species or adversely modifying their historic or documented habitat, but this protection extends only to Federally listed plants. Therefore, Federal listing would activate this law on behalf of New Jersey's other known (and much larger) population of *A. virginica*.

E. Other Natural or Manmade Factors Affecting Its Continued Existence

Whether due to causes mentioned under Factor A or to other as yet unidentified threats, the extent of *Aeschynomene virginica* along river systems in Virginia is contracting. On both the Rappahannock and the James Rivers, *Aeschynomene virginica* was collected historically some 10 miles further upstream and downstream than it is currently known to exist. It remains on only one section of the Chickahominy River, where it once had a much broader distribution, as noted from historical collections (T. Wieboldt, VPI&SU Herbarium, pers. comm., 1990).

The Service has carefully assessed the best scientific and commercial information available regarding the past, present, and future threats faced by this species in determining to propose this rule. Based on this evaluation, the preferred action is to list *Aeschynomene virginica* as threatened. The species is not in immediate danger of extinction, due primarily to its current distribution along six river systems in Virginia. However, the best available data indicate that it qualifies as a threatened species, based on the projected outlook for human population increase and associated commercial and suburban development, demand for water, and increased human use along these river systems. Increased development has proven to be detrimental to *A. virginica* and its specialized habitat, as indicated by the species' extirpation from two States and numerous counties in the States where it is yet extant.

Critical Habitat

Section 4(a)(3) of the Act as amended, requires that, to the maximum extent

prudent and determinable, the Secretary propose critical habitat at the time the species is proposed to be endangered or threatened. The Service finds that designation of critical habitat is not prudent for this species at this time. As discussed under Factor B in the Summary of Factors Affecting the Species, *Aeschynomene virginica* is threatened by taking, an activity difficult to enforce against and only regulated by the Act with respect to plants in cases of (1) removal and reduction to possession of listed plants from lands under Federal jurisdiction, or their malicious damage or destruction on such lands; and (2) removal, cutting, digging up, or damaging or destroying in knowing violation of any State law or regulation, including State criminal trespass law. Such provisions are difficult to enforce, and publication of critical habitat descriptions and maps would make the joint-vech more vulnerable and increase enforcement problems. All involved parties and principal landowners have been notified of the location and importance of protecting this species' habitat. Protection of this species' habitat will be addressed through the recovery possess and through the section 7 jeopardy standard. Therefore, it would not now be prudent to determine critical habitat for this species.

Available Conservation Measures

Conservation measures provided to species listed as endangered or threatened under the Endangered Species Act include recognition, recovery actions, requirements for Federal protection, and prohibitions against certain practices. Recognition through listing encourages and results in conservation action by Federal, State, and private agencies, groups, and individuals. The Endangered Species Act provides for possible land acquisition and cooperation with the States and requires that recovery actions be carried out for all listed species. The protection required of Federal agencies and the prohibitions against certain activities involving listed plants are discussed, in part, below.

Section 7(a) of the Act, as amended, requires Federal agencies to evaluate their actions with respect to any species that is proposed or listed as endangered or threatened. Regulations implementing this interagency cooperation provision of the Act are codified at 50 CFR part 402. Section 7(a)(4) requires Federal agencies to confer informally with the Service on any action that is likely to jeopardize the continued existence of a proposed species or result in destruction or adverse modification of proposed

critical habitat. If a species is listed subsequently, section 7(a)(2) requires Federal agencies to ensure that activities they authorize, fund, or carry out are not likely to jeopardize the continued existence of such a species or to destroy or adversely modify its critical habitat. If a Federal action may affect a listed species or its critical habitat, the responsible Federal agency must enter into formal consultation with the Service. Because *A. virginica* occurs in wetland habitat, many projects potentially affecting it would be within the permitting authority of the U.S. Army Corps of Engineers. The water supply and development projects mentioned under Factor A are among such projects.

The listing of this plant also brings sections 5 and 6 of the Endangered Species Act into full effect on its behalf. Section 5 authorizes the acquisition of lands for the purpose of conserving endangered and threatened species. Pursuant to section 6, the Service may grant funds to affected states for management actions aiding the protection and recovery of the species.

Listing sensitive joint-vech as threatened provides for development of a recovery plan. Such a plan will bring together State, Federal, and private efforts for conservation of the species. The plan will establish an administrative framework, sanctioned by the Act, for agencies to coordinate activities and cooperate with each other in conservation efforts. The plan will also set recovery priorities and estimate the cost of various studies or other tasks necessary to accomplish them. It will assign appropriate functions to each agency and a time frame within which to complete them. It may also identify specific areas that need to be monitored and possibly managed for the conservation of the species.

The Act and its implementing regulations found at 50 CFR 17.71 and 17.72 set forth a series of general prohibitions and exceptions that apply to all threatened plants. All trade prohibitions of section 9(a)(2) of the Act, implemented by 50 CFR 17.71 apply. These prohibitions, in part, make it illegal for any person subject to the jurisdiction of the United States to import or export, transport in interstate or foreign commerce in the course of a commercial activity, sell or offer for sale this species in interstate or foreign commerce, or to remove and reduce to possession the species from areas under Federal jurisdiction. Seeds from cultivated specimens of threatened plant species are exempt from these prohibitions provided that a statement

of "cultivated origin" appears on their containers. In addition, for listed plants, the 1988 amendments (Pub. L. 100-478) to the Act prohibit the malicious damage or destruction on Federal lands and the removal, cutting, digging up, or damaging or destroying of listed plants in knowing violation of any State law or regulation, including State criminal trespass law. Certain exceptions apply to agents of the Service and State conservation agencies. The Act and 50 CFR 17.72 also provide for the issuance of permits to carry out otherwise prohibited activities involving threatened species under certain circumstances.

It is anticipated that few trade permits would ever be sought or issued because the species is not common in cultivation or in the wild. Requests for copies of the regulations on plants and inquiries regarding them may be addressed to the Office of Management Authority, U.S. Fish and Wildlife Service, room 432, 4401 N. Fairfax Dr., Arlington, VA 22203-3507, (703/358-2104).

Public Comments Solicited

The Service intends that any final action resulting from this proposal will be as accurate and as effective as possible. Therefore, comments or suggestions from the public, other concerned governmental agencies, the scientific community, industry, or any other interested party concerning this proposed rule are hereby solicited. Comments particularly are sought concerning:

- (1) Biological, commercial trade, or other relevant data concerning any threat (or lack thereof) to this species;
- (2) The location of any additional populations of this species and the reasons why any habitat should or should not be determined to be critical habitat as provided by section 4 of the Act;
- (3) Additional information concerning the range, distribution, and population size of this species; and
- (4) Current or planned activities in the subject area and their possible impacts on this species.

Final promulgation of the regulation on this species will take into consideration the comments and any additional information received by the Service, and such communications may lead to a final regulation that differs from this proposal.

The Endangered Species Act provides for a public hearing on this proposal, if requested. Requests must be received within 45 days of the date of publication of the proposal. Such requests must be made in writing and addressed to the

Annapolis Field Office (see ADDRESSES section).

National Environmental Policy Act

The Fish and Wildlife Service has determined that an Environmental Assessment, as defined under the authority of the National Environmental Policy Act of 1969, need not be prepared in connection with regulations adopted pursuant to section 4(a) of the Endangered Species Act of 1973, as amended. A notice outlining the Service's reasons for this determination was published in the Federal Register on October 25, 1983 (48 FR 49244).

References Cited

Boyette, C.D., G.E. Templeton and R.J. Smith, Jr. 1979. Control of winged water-primrose and northern jointvetch with fungal pathogens. *Weed Sci.* 27(5):497-501.

Bruderle, L.P., and S.E. Davison. 1984. Draft Stewardship Abstract—*Aeschynomene virginica*. The Nature Conservancy, Arlington, Virginia, 6 pp.

Carulli, J.P., and D.E. Fairbrothers. 1988. Allozyme variation in three eastern United States species of *Aeschynomene* (Fabaceae), including the rare *A. virginica*. *Systemic Botany* 13 (4):559-66.

Fernald, M.L. 1939. *Aeschynomene virginica* (L.) BSP and *A. hispida* [A. *indica*]. *Rhodora* 41:466-7.

Gleason, H.A., and A. Cronquist. 1963. *Manual of the Vascular Plants of Northeastern United States and Adjacent Canada*. New York: D. Van Nostrand Co. 810 pp.

Hackett, N., and D.S. Murray. 1986. Northern jointvetch. IN: WEED ID GUIDE. Southern Weed Science Society. Champaign, IL.

Isley, D. 1990. *Vascular Flora of the Southeastern United States. Volume 3, Part 2 Leguminosae (Fabaceae)* Chapel Hill, NC: UNC Press, p. 186.

Kartesz, J.T., and R. Kartesz. 1980. A Synonymized Checklist of the Vascular Flora of the U.S., Canada and Greenland. Chapel Hill, NC: UNC Pres. 500 pp.

Leonard, S. W. 1985. Status report on *Aeschynomene virginica* in North Carolina. Unpub. rept. To The Nature Conservancy, Boston, MA, 6+ pp.

Oberg, M. 1990. Commuting is worth the price for privacy. *Richmond Times-Dispatch*, 12/9/90, Real Estate Section.

Radford, A. E., H.E. Ahles and C. R. Bell. 1968. *Manual of the Vascular Flora of the Carolinas*. Chapel Hill, NC: UNC Press, 1183 pp.

Rawinski, T., and Cassin. 1986. Range-wide Status Survey for *Aeschynomene virginica*. Report to Region 5, U.S.F.W.S. from The Nature Conservancy, Eastern Regional Office, March 26, 1986.

Rudd, V.E. 1955. The American species of *Aeschynomene*. *Contr. U.S. Natl. Herb.* 32(1): 1-172.

Sipple, W. S. 1990. Exploring Maryland's freshwater tidal wetlands. *Atlantic Naturalist*, 40: 2-18.

Year 2020 Panel. 1988. Population Growth and Development in the Chesapeake Bay Watershed to the Year 2020. Report to the Chesapeake Executive Council, in compliance with Chesapeake Bay Agreement of 1987. Council on the Environment, Richmond, VA.

Author

The primary author of this proposed rule is Judy Jacobs, Annapolis Field Office, U.S. Fish and Wildlife Service, 1825 Virginia Street, Annapolis, Maryland 21401 (301) 269-5448.

List of Subjects in 50 CFR Part 17

Endangered and threatened species, Exports, Imports, Reporting and recordkeeping requirements, and Transportation.

Proposed Regulation Promulgation

PART 17—[AMENDED]

Accordingly, it is hereby proposed to amend part 17, subchapter B of chapter 1, title 50 of the Code of Federal Regulations, as set forth below:

1. The authority citation for part 17 continues to read as follows:

Authority: 16 U.S.C. 1361-1407; 16 U.S.C. 1531-1544; 16 U.S.C. 4201-4245; Public Law 99-625, 100 Stat. 3500, unless otherwise noted.

2. It is proposed to amend § 17.12(h) by adding the following, in alphabetical order under the family Fabaceae to the List of Endangered and Threatened Plants:

§ 17.12 Endangered and threatened plants.

* * * * *

(h) * * *

| Species | | Historic range | Status | When listed | Critical habitat | Special rules |
|-------------------------------------|----------------------------|-------------------------------------|--------|-------------|------------------|---------------|
| Scientific name | Common name | | | | | |
| Fabaceae—Bean family: | | | | | | |
| <i>Aeschynomene virginica</i> | Sensitive joint-vetch..... | U.S.A (DE, MD, NC, NJ, PA, VA)..... | T | . | NA | NA. |

Dated: July 2, 1991.
 Richard N. Smith,
 Acting, Director, Fish and Wildlife Service.
 [FR Doc. 91-17760 Filed 7-25-91; 8:45 am]
 BILLING CODE 4310-55-M

Notices

Federal Register

Vol. 56, No. 144

Friday, July 26, 1991

This section of the FEDERAL REGISTER contains documents other than rules or proposed rules that are applicable to the public. Notices of hearings and investigations, committee meetings, agency decisions and rulings, delegations of authority, filing of petitions and applications and agency statements of organization and functions are examples of documents appearing in this section.

DEPARTMENT OF AGRICULTURE

Animal and Plant Health Inspection Service

[Docket No. 91-107]

Availability of Environmental Assessments and Findings of No Significant Impact Relative to Issuance of Permits to Field Test Genetically Engineered Organisms

AGENCY: Animal and Plant Health Inspection Service, USDA.

ACTION: Notice.

SUMMARY: We are advising the public that five environmental assessments and findings of no significant impact have been prepared by the Animal and Plant Health Inspection Service relative to the issuance of permits to allow the field testing of genetically engineered organisms. The assessments provide a basis for the conclusion that the field testing of these genetically engineered organisms will not present a risk of the introduction or dissemination of a plant pest and will not have a significant

impact on the quality of the human environment. Based on these findings of no significant impact, the Animal and Plant Health Inspection Service has determined that environmental impact statements need not be prepared.

ADDRESSES: Copies of the environmental assessments and findings of no significant impact are available for public inspection at USDA, room 1141, South Building, 14th Street and Independence Avenue, SW., Washington, DC, between 8 a.m. and 4:30 p.m., Monday through Friday, except holidays.

FOR FURTHER INFORMATION CONTACT: Mary Petrie, Program Specialist, Biotechnology Permits, Biotechnology, Biologics, and Environmental Protection, Animal and Plant Health Inspection Service, U.S. Department of Agriculture, room 850, Federal Building, 6505 Belcrest Road, Hyattsville, MD 20782, (301) 436-7612. For copies of the environmental assessments and findings of no significant impact, write Clayton Givens at this same address. The documents should be requested under the permit numbers listed below.

SUPPLEMENTARY INFORMATION: The regulations in 7 CFR part 340 regulate the introduction (importation, interstate movement, and release into the environment) of genetically engineered organisms and products that are plant pests or that there is reason to believe are plant pests (regulated articles). A permit must be obtained before a regulated article can be introduced into

the United States. The regulations set forth procedures for obtaining a limited permit for the importation or interstate movement of a regulated article and for obtaining a permit for the release into the environment of a regulated article. The Animal and Plant Health Inspection Service (APHIS) has stated that it would prepare an environmental assessment and, when necessary, an environment impact statement before issuing a permit for the release into the environment of a regulated article (see 52 FR 22906).

In the course of reviewing the permit applications, APHIS assessed the impact on the environment of releasing the organisms under the conditions described in the permit applications. APHIS concluded that the issuance of the permits listed below will not present a risk of plant pest introduction or dissemination and will not have a significant impact on the quality of the human environment.

The environmental assessments and findings of no significant impact, which are based on data submitted by the applicants as well as a review of other relevant literature, provide the public with documentation of APHIS' review and analysis of the environmental impacts associated with conducting the field tests.

Environmental assessments and findings of no significant impact have been prepared by APHIS relative to the issuance of the following permits to allow the field testing of genetically engineered organisms:

| Permit Number | Permittee | Date Issued | Organism | Field Test Location |
|--|--|-------------|--|----------------------------|
| 91-094-01 (renewal of 90-032-01 issued on 05-08-90). | Monsanto Agricultural Company..... | 06-25-91 | Potato plants genetically engineered to express the viral coat proteins from potato virus X (PVX), potato virus Y (PVY), and/or potato leaf roll virus (PLRV). | Benton County, Washington. |
| 91-105-01 | Pioneer Hi-Bred International, Incorporated. | 06-27-91 | Corn plants genetically to express a phosphinothricin bialaphos herbicide tolerance gene and two marker genes. | Polk County, Iowa. |
| 91-100-01 | Ciba-Geigy Biotechnology Research .. | 06-28-91 | Corn plants genetically engineered to express two marker genes .. | Molokai, Hawaii. |
| 91-129-01 | Holden's Foundation Seeds, Incorporated. | 07-01-91 | Corn plants genetically engineered to express a phosphinothricin-N-acetyltransferase (PAT) gene to confer tolerance to the herbicide glufosinate. | Iowa County, Iowa. |
| 91-115-01 | U.S. Department of Agriculture, Agricultural Research Service. | 07-08-91 | Tobacco plants genetically engineered to express the beet curly top virus (BCTV) capsid protein and two marker genes. | Benton County, Washington. |

The environmental assessments and findings of no significant impact have been prepared in accordance with: (1) The National Environmental Policy Act of 1969 (NEPA) (42 U.S.C. 4331 *et seq.*),

(2) Regulations of the Council on Environmental Quality for Implementing the Procedural Provisions of NEPA (40 CFR parts 1500-1509), (3) USDA Regulations Implementing NEPA (7 CFR

part 1b), and (4) APHIS Guidelines Implementing NEPA (44 FR 50381-50384, August 28, 1979, and 44 FR 51272-51274, August 31, 1979).

Done in Washington, DC, this 23rd day of July 1991.

James W. Glosser,

Administrator, Animal and Plant Health Inspection Service.

[FR Doc. 91-17776 Filed 7-25-91; 8:45 am]

BILLING CODE 3410-34-M

Soil Conservation Service

Chunky River Watershed, MS

AGENCY: Soil Conservation Service, U.S.D.A.

ACTION: Notice of a finding of no significant impact.

SUMMARY: Pursuant to section 102(2)(C) of the National Environmental Policy Act of 1969; the Council on Environmental Quality Guidelines (40 CFR part 1500); and the Soil Conservation Service Guidelines (7 CFR part 650); the Soil Conservation Service, U. S. Department of Agriculture, gives notice that an environmental impact statement is not being prepared for Chunky River Watershed, Newton and Neshoba Counties, Mississippi.

FOR FURTHER INFORMATION CONTACT: L. Pete Heard, State Conservationist, Soil Conservation Service, suite 1321, A.H. McCoy Federal Building, 100 West Capitol Street, Jackson, Mississippi 39269, telephone 601-965-5205.

SUPPLEMENTARY INFORMATION: The environmental assessment of this federally assisted action indicates that the project will not cause significant local, regional, or national impacts on the environment. As a result of these findings, L. Pete Heard, State Conservationist, has determined that the preparation and review of an environmental impact statement are not needed for this project.

The project concerns a supplemental plan for the purpose of reducing flood damages to urban areas along Newton Creek and its Tributary No. 2. The planned works of improvement consist of 0.8 mile of channel modifications which includes channel enlargement.

The Notice of a Finding of No Significant Impact (FONSI) has been forwarded to the Environmental Protection Agency and to various Federal, State, and local agencies and interested parties. A limited number of copies of the FONSI are available to fill single copy requests at the above address. Basic data developed during the environmental assessment are on file and may be reviewed by contacting L. Pete Heard.

No administrative action on implementation of the proposal will be

taken until 30 days after the date of this publication in the **Federal Register**.

"(This activity is listed in the Catalog of Federal Domestic Assistance under No. 10.904—Watershed Protection and Flood Prevention and is subject to the provisions of Executive Order 12372 which requires intergovernmental consultation with State and local officials.)"

Dated: July 18, 1991.

L. Pete Heard,

State Conservationist

[FR Doc. 91-17727 Filed 7-25-91; 8:45 am]

BILLING CODE 3410-16-M

DEPARTMENT OF COMMERCE

Agency Form Under Review by the Office of Management and Budget (OMB)

DOC has submitted to OMB for clearance the following proposal for collection of information under the provisions of the Paperwork Reduction Act (44 U.S.C. chapter 35).

Agency: International Trade Administration.

Title: Foreign Buyer Program: Application, Exhibitor Data, and Evaluation.

Form Numbers: Agency—ITA-426P, OMB—0625-0151.

Type of Request: Extension of the expiration date of a currently approved collection.

Burden: 7,330 respondents; 1,335 reporting hours.

Average Hours Per Response: ITA-4014P—10 minutes; ITA-4015P—10 minutes; ITA-4102P—3 hours, 10 minutes.

Needs and Uses: The International Trade Administration (ITA) runs the Foreign Buyer Program (FBP) to encourage foreign buyers to attend selected domestic trade shows in high export potential industries and to facilitate contact between U.S. exhibitors and foreign visitors. The application is the vehicle used by a potential show organizer to provide (1) his experience, (2) ability to meet the special conditions of the Foreign Buyer Program and (3) information about the domestic trade show such as number of U.S. exhibitors and percentage of net exhibit space occupied by U.S. companies vis-a-vis non-U.S. exhibitors. The exhibitor data form is completed by U.S. exhibitors participating in a FBP domestic trade show and used to list the firm and its product in an Export Interest Directory which is distributed worldwide for use by Foreign Commercial Officers in recruiting delegations of foreign buyers to attend

the show. The exhibitor evaluation is sent to U.S. exhibitors after the show to determine the results of ITA's efforts to bring together foreign buyers and U.S. firms.

Affected Public: Businesses or other for profit; small businesses or organizations.

Frequency: On occasion; annually.
Respondent's Obligation: Required to obtain or retain a benefit.

OMB Desk Officer: Marshall Mills, 395-7340.

Copies of the above information collection proposal can be obtained by calling or writing DOC Clearance Officer, Edward Michals, (202) 377-3271, Department of Commerce, room 5327, 14th and Constitution Avenue NW., Washington, DC 20230.

Written comments and recommendations for the proposed information collection should be sent to Marshall Mills, OMB Desk Officer, room 3208 New Executive Office Building, Washington, DC 20503.

Dated: July 22, 1991.

Edward Michals,

Departmental Clearance Officer, Office of Management and Organization.

[FR Doc. 91-17750 Filed 7-25-91; 8:45 am]

BILLING CODE 3510-CW-M

Agency Form Under Review by the Office of Management and Budget (OMB)

DOC has submitted to OMB for clearance the following proposal for collection of information under the provisions of the Paperwork Reduction Act (44 U.S.C. chapter 35).

Agency: International Trade Administration.

Title: Marketing Data Form.

Form Numbers: Agency—ITA-466P; OMB—0625-0047.

Type of Request: Extension of the expiration date of a currently approved collection.

Burden: 2,300 respondents; 1,725 reporting hours.

Average Hours per Response: 45 minutes.

Needs and Uses: The Marketing Data Form (MDF) is sent to participants along with other materials necessary to participate in an ITA trade exhibition, trade mission or Matchmaker. The MDF provides information necessary to produce export promotion brochures and directories and to arrange appointments and prospect calls on behalf of the participants with key prospective buyers, agents,

distributors or government officials. Specific information is also requested in terms of the participants' objectives regarding agents, distributors, joint prospective agents, e.g., physical facilities, technical capabilities, financial strength, staff, representation of complementary lines, etc.

Affected Public: Businesses or other for profit; small businesses or organizations.

Frequency: On Occasion.

Respondent's Obligation: Required to obtain or retain a benefit.

OMB Desk Officer: Marshall Mills, 395-7340.

Copies of the above information collection proposal can be obtained by calling or writing DOC Clearance Officer, Edward Michals, (202) 377-3271, Department of Commerce, room 5327, 14th and Constitution Avenue NW., Washington, DC 20230.

Written comments and recommendations for the proposed information collection should be sent to Marshall Mills, OMB Desk Officer, room 3208, New Executive Office Building, Washington, DC 20503.

Dated: July 22, 1991.

Edward Michals,

Departmental Clearance Officer, Office of Management and Organization.

[FR Doc. 91-17751 Filed 7-25-91; 8:45 am]

BILLING CODE 3510-CN-M

Agency Form Under Review by the Office of Management and Budget (OMB)

DOC has submitted to OMB for clearance the following proposal for collection of information under the provisions of the Paperwork Reduction Act (44 U.S.C. Chapter 35).

Agency: International Trade Administration.

Title: COMMERCIAL NEWS USA/Export Product Promotion.

Form Numbers: Agency—ITA-4063P, OMB-0625-0061.

Type of Request: Extension of the expiration date of a currently approved collection.

Burden: 2,200 respondents; 917 reporting hours.

Average Hours Per Response: 25 minutes.

Needs and Uses: The International Trade Administration (ITA) publishes the COMMERCIAL NEWS USA (CNUSA) which promotes U.S. products available for export in overseas markets. The application form is the vehicle used (1) by U.S. manufacturers, service firms, and

publishers of trade and technical literature to provide information on products which they want promoted overseas; (2) to determine if the products meet program criteria, and (3) to request results of each company's publicity in CNUSA one year after publication.

Affected Public: Businesses or other for profit; small businesses or organizations.

Frequency: On Occasion.

Respondent's Obligation: Required to obtain or retain a benefit.

OMB Desk Officer: Marshall Mills, 395-7340.

Copies of the above information collection proposal can be obtained by calling or writing DOC Clearance Officer, Edward Michals, (202) 377-3271, Department of Commerce, room 5327, 14th and Constitution Avenue NW., Washington, DC 20230.

Written comments and recommendations for the proposed information collection should be sent to Marshall Mills, OMB Desk Officer, room 3208 New Executive Office Building, Washington, DC 20503.

Dated: July 22, 1991.

Edward Michals,

Departmental Clearance Officer, Office of Management and Organization.

[FR Doc. 91-17752 Filed 7-25-91; 8:45 am]

BILLING CODE 3510-CW-M

Agency Information Collection Under Review by the Office of Management and Budget (OMB)

DOC has submitted to OMB for clearance the following proposal for collection of information under the provisions of the Paperwork Reduction Act (44 U.S.C. chapter 35).

Agency: Patent and Trademark Office.

Title: Trademark Processing.

Form Number: OMB Number: 0651-0009.

Type of Request: Extension.

Burden: 116,000 respondents; 29,000 reporting hours. Average time is 15 minutes.

Needs and Uses: Information provided by individuals and corporations is used by the Patent and Trademark Office to determine eligibility for trademark/service mark registration. The registration of a mark provides certain benefits to the holder. It allows access to the Federal court system and serves as public notice of the registrant's rights under trademark law.

Affected Public: Businesses, industries, and small businesses.

Frequency: On Occasion.

Respondent's Obligation: Required to obtain a benefit.

OMB Desk Officer: Maya A. Bernstein 395-3785.

Copies of the above information collection proposal can be obtained by calling or writing DOC Clearance Officer, Edward Michals (202) 377-3271, Department of Commerce, room 5327, 14th and Constitution Avenue NW., Washington, DC 20230.

Written comments and recommendations for the proposed information collection should be sent to Maya A. Bernstein, OMB Desk Officer, room 3235, New Executive Office Building, Washington, DC 20503.

Dated: July 22, 1991.

Edward Michals,

Departmental Clearance Officer, Office of Management and Organization.

[FR Doc. 91-17753 Filed 7-25-91; 8:45 am]

BILLING CODE 3510-CW-M

Agency Form Under Review by the Office of Management and Budget (OMB)

DOC has submitted to OMB for clearance the following proposal for collection of information under the provisions of the Paperwork Reduction Act (44 U.S.C. chapter 35).

Agency: Bureau of Economic Analysis.

Title: Benchmark Survey of Selected Services Transactions With Unaffiliated Foreign Persons—1991.

Form Number: Agency—BE-20; OMB—0608-0058.

Type of Request: Reinstatement of a previously approved collection for which approval has expired.

Burden: 1,000 respondents; 13,200 reporting hours.

Average Hours per Response: 13.2 hours.

Needs and Uses: This survey will obtain universe data on transactions in selected services between U.S. and unaffiliated foreign persons in 1991. The data from the survey will provide benchmarks for deriving current universe estimates of such transactions from sample data collected in subsequent years. The information gathered is needed to support U.S. trade policy initiatives, including trade negotiations, and to compile the U.S. balance of payments and the national income and product accounts.

Affected Public: Businesses, government agencies, or other institutions engaging in international transactions in the covered services.

Frequency: Quinquennial.

Respondent's Obligation: Mandatory.

OMB Desk Officer: Marshall Mills, 395-7340.

Copies of the above information collection proposal can be obtained by calling or writing DOC Clearance Officer, Edward Michals (202) 377-3271, Department of Commerce, room H5327, 14th Street and Constitution Avenue NW., Washington, DC 20230.

Written comments and recommendations for the proposed information collection should be sent to Marshall Mills, OMB Desk Officer, room 3208, New Executive Office Building, Washington, DC 20503.

Dated: July 23, 1991.

Edward Michals,

Departmental Clearance Officer, Office of Management and Organization.

[FR Doc. 91-17754 Filed 7-25-91; 8:45 am]

BILLING CODE 3510-CW-M

Foreign-Trade Zones Board

[Order No. 528]

Resolution and Order Approving With Restriction the Application of the Canaveral Port Authority for a Special-Purpose Subzone at the Machinery Components Manufacturing Facility of Flite Technology, Inc., in Cocoa, FL

Proceedings of the Foreign-Trade Zones Board, Washington, DC

Resolution and Order

Pursuant to the authority granted in the Foreign-Trade Zones Act of June 18, 1934, as amended (19 U.S.C. 81a-81u), the Foreign-Trade Zones Board (the Board) adopts the following Resolution and Order:

The Board, having considered the matter, hereby orders:

After consideration of the application of the Canaveral Port Authority, grantee of FTZ 136, filed with the Foreign-Trade Zones Board (the Board) on June 19, 1990, requesting special-purpose subzone status for the machinery components manufacturing plant or Flite Technology, Inc., located in Cocoa, Florida, the Board, finding that the requirements of the Foreign-Trade Zones Act, as amended, and the FTZ Board's regulations would be satisfied, and that the proposal would be in the public interest if full zone benefits were approved for export manufacturing only, approves the application subject to the restriction requiring Flite Technology to elect privileged-foreign status on all merchandise admitted to the subzone.

The Secretary of Commerce, as Chairman and Executive Officer of the Board, is hereby authorized to issue a grant of authority and appropriate Board Order.

Grant of Authority To Establish a Foreign-Trade Subzone in Cocoa, Florida

Whereas, By an Act of Congress approved June 18, 1934, an Act "To provide for the establishment, operation, and maintenance of foreign-trade zones in ports of entry of the United States, to expedite and encourage foreign commerce, and for other purposes," as amended (19 U.S.C. 81a-81u) (the Act), the Foreign-Trade Zones Board (the Board) is authorized and empowered to grant to corporations the privilege of establishing, operating, and maintaining foreign-trade zones in or adjacent to ports of entry under the jurisdiction of the United States;

Whereas, The Board's regulations (15 CFR 400.304) provide for the establishment of special-purpose subzones when existing zone facilities cannot serve the specific use involved, and where a significant public benefit will result;

Whereas, The Canaveral Port Authority, Grantee of Foreign-Trade Zone No. 136, has made application (filed June 19, 1990, FTZ Docket 23-90, 55 FR 26224, 06-27-90) in due and proper form to the Board for authority to establish a special-purpose subzone at the Flite Technology, Inc., plant in Cocoa, Florida;

Whereas, Notice of said application has been given and published, and full opportunity has been afforded all interested parties to be heard; and,

Whereas, The Board has found that the requirements of the Act and the Board's regulations would be satisfied and that the proposal would be in the public interest if approval were given subject to the restriction in the resolution accompanying this action;

Now, therefore, In accordance with the application filed June 19, 1990, the Board hereby authorizes the establishment of a subzone at the Flite Technology, Inc., plant in Cocoa, Florida, designated on the records of the Board as Foreign-Trade Subzone 136A, at the location mentioned above and more particularly described on the maps and drawings accompanying the application, said grant of authority being subject to the provisions and restrictions of the Act and the regulations issued thereunder, to the restriction in the resolution accompanying this action, and also to the following express conditions and limitations:

Activation of the subzone shall be commenced within a reasonable time from the date of issuance of the grant, and prior thereto, any necessary permits shall be obtained from Federal, State, and municipal authorities.

Officers and employees of the United States shall have free and unrestricted access to and throughout the foreign-trade subzone in the performance of their official duties.

The grant shall not be construed to relieve responsible parties from liability for injury or damage to the person or property of others occasioned by the construction, operation, or maintenance of said subzone, and in no event shall the United States be liable therefor.

The grant is further subject to settlement locally by the District Director of Customs and the Army District Engineer with the Grantee regarding compliance with their respective requirements for the protection of the revenue of the United States and the installation of suitable facilities.

In witness whereof, The Foreign-Trade Zones Board has caused its name to be signed and its seal to be affixed hereto by its Chairman and Executive Officer or his delegate at Washington, DC, this 19th day of July 1991, pursuant to Order of the Board.

Attest:

John J. Da Ponte, Jr.,
Executive Secretary.

Eric I. Garfinkel,

Assistant Secretary of Commerce for Import Administration, Chairman, Committee of Alternates Foreign-Trade Zones Board.

[FR Doc. 91-17805 Filed 7-25-91; 8:45 am]

BILLING CODE 3510-DS-M

[Docket 39-91]

Application for Extension for Subzone 23B, CPS Corp. (Formerly Greater Buffalo Press) Ink Plant, Chautauqua County, NY

An application has been submitted to the Foreign-Trade Zones Board (the Board) by the County of Erie, New York, grantee of Foreign-Trade Zone 23, requesting an extension of authority for Subzone 23B at the ink manufacturing plant of CPS Corporation (CPS) located in the town of Dunkirk, Chautauqua County, New York. (CPS is the former ink manufacturing division of Greater Buffalo Press, Inc. (GBP)). The application was formally filed on July 2, 1991.

Subzone 23B was approved with restrictions in 1986 (Board Order 332, 51 FR 18468, 5/20/86). The approval covered an existing plant in Sheridan, New York, and the Dunkirk site to which the plant was to be relocated (this occurred in 1988). The authorization was for a five-year period from activation (to 8-25-91), subject to extension. Approval

was also subject to restrictions requiring the election of privileged foreign status (19 CFR 146.41) on pigments used in the production of ink sold to domestic printing plants not affiliated with GBP and on ink produced in excess of 21 million pounds annually.

In August 1989, Sullivan Graphics, Inc. purchased both the ink manufacturing (CPS) and printing divisions of GBP. In December 1989, Sullivan sold the ink manufacturing division to INX International, Inc. which operates CPS as a subsidiary corporation.

The grantee, on behalf of CPS, now requests an indefinite extension of authority and removal of the restriction regarding production levels. Now that the Dunkirk plant is active, CPS has closed the Sheridan facility and has not included it in its extension request. Also, there is no request for removal of the restriction limiting shipments to affiliated plants. Of the nine original plants authorized to receive shipments of ink made under full zone benefits, there remain seven in operation (operated by Sullivan Graphics), these are the plants to which shipments would continue.

The CPS ink facility consists of an ink production plant on Middle Road and a warehouse on Rt. 5, in the Town of Dunkirk. The plant produces color inks primarily for Sullivan Graphics's high-speed comic and commercial newspaper supplement printing operations in the U.S. and Canada. It sources pigments from abroad.

Zone procedures exempt CPS from Customs duty payments on pigments and related chemicals used in ink that is reexported. On sales to Sullivan Graphics's domestic plants (6 of the 7 noted above), CPS can choose the duty rate that applies to ink (1.8%). Most foreign pigments used by CPS have a duty rate of 20 percent. The application indicates that the savings will continue to help maintain CPS's competitiveness with Canadian production.

In accordance with the Board's regulations, an examiners committee has been appointed to investigate the application and report to the Board. The committee consists of: Dennis Puccinelli, (Chairman), Foreign-Trade Zones Staff, U.S. Department of Commerce, Washington, DC 20230; Victor G. Weeren, Assistant Regional Commissioner, U.S. Customs Service, Northeast Region, suite 801, 10 Causeway Street, Boston, Massachusetts 02222-1056; and Colonel Hugh F. Boyd III, District Engineer, U.S. Army Engineer District Buffalo, 1776 Niagara Street, Buffalo, New York 14207-3199.

The FTZ Board plans to temporarily extend subzone status for CPS subject to the restrictions of Board Order 332 for a period of six months, during which this review would be concluded.

Comments concerning the application are invited in writing from interested parties. They should be addressed to the Board's Executive Secretary at the address below and postmarked on or before September 9, 1991.

A copy of the application and accompanying exhibits will be available during this time for public inspection at the following location: Office of the Executive Secretary, Foreign-Trade Zones Board, U.S. Department of Commerce, room 3716, 14th and Pennsylvania Avenue NW., Washington, DC 20230.

Dated: July 19, 1991.

John J. Da Ponte, Jr.,
Executive Secretary.

[FR Doc. 91-17606 Filed 7-25-91; 8:45 am]

BILLING CODE 3510-05-M

[Docket No. 41-91]

Application for Expansion for Subzone 57A, IBM Information Processing Equipment Plant, Charlotte, NC

An application has been submitted to the Foreign-Trade Zones Board (the Board) by the North Carolina Department of Economic and Community Development (NCDECD), grantee of FTZ Subzone 57A, at the information processing equipment manufacturing plant of International Business Machines Corporation (IBM), located in Charlotte, North Carolina, requesting to expand the subzone and the scope of manufacturing authority. The application was submitted pursuant to the provisions of the Foreign-Trade Zones Act, as amended (19 U.S.C. 81a-81u), and regulations of the Board (15 CFR part 400). It was formally filed on July 8, 1991.

Subzone 57A was approved in 1986 for the manufacture of printers, electronic banking equipment and electronic assemblies (Board Order 323, 51 FR 3356, 1/27/86). It was activated under subzone procedures during 1987, and is seeking this expansion authority prior to reactivation. The plant (4,500 employees) is used to produce a wider range of information processing equipment and components, and IBM requests that its subzone authority be extended to include the new activity, as well as planned activity. The plant's produce lines now include printed circuit boards, electronic logic cards, special-purpose information processing equipment for the financial industry, bar

code readers, modems, microcode loaded diskettes, and physical and chemical analysis computers.

Foreign materials account for some 18 percent of the value of the finished equipment and components including monitors, keyboards, cathode ray tubes, dot matrix printers, magnetic disk drives, power supplies, modems, testers, magnetic disks and diskettes, resistors, capacitors, transistors, printed circuits, switching apparatus and connectors, electronic integrated circuits, wire and cable, insulators and fittings, fuses, certain articles of plastic and rubber, fasteners, hangars, screws, bolts, and bearings. Certain components and subassemblies produced at the Charlotte plant are shipped to other IBM plants, and some 25 percent of the finished equipment is exported.

Zone procedures would exempt IBM from Customs duty payments on foreign parts that are used in production for export. On its domestic sales, it would be able to choose the duty rates that apply to finished products (0.0 to 10.0 percent, averaging 4.9 percent). The duty rates on the foreign components range from 0.0 to 14.0 percent. The application indicates that the savings will help improve the plant's international competitiveness.

The application also requests authority to expand the subzone to include sites 2, 3, and 4) in the Charlotte area which perform contract services for IBM related to manufacturing at its Charlotte plant: *Site 2* (4 acres)—warehousing, testing and pre-assembly facility operated by Atlantic Design Company, 5020 W.T. Harris Boulevard, Mecklenburg County, 4 miles north of Charlotte; *Site 3* (23 acres)—warehousing, testing and assembly/manufacturing facility operated by Taltronics Corporation, 404 Armour Street, Davidson, Mecklenburg County, some 14 miles north of Charlotte; and, *Site 4* (18 acres)—warehousing, testing, and production-related facility operated by Atlantic Design Company, 5601 Wilkinson Boulevard, Charlotte, north of the Douglas Municipal Airport.

In accordance with the Board's regulations, an examiners committee has been appointed to investigate the application and report to the Board. The committee consists of: Dennis Puccinelli (Chairman), Foreign-Trade Zones Staff, U.S. Department of Commerce, Washington, DC 20230; Howard Cooperman, Regional Director, Inspection and Control, U.S. Customs Service, Southeast Region, 909 SE. First Avenue, Miami, Florida 33131-2595; and

Colonel W. Scott Tulloch, District Engineer, U.S. Army Engineer District Wilmington, P.O. Box 1890, Wilmington, NC 28402-1890.

Comments concerning the proposed subzone are invited in writing from interested parties. They should be addressed to the Board's Executive Secretary at the address below and postmarked on or before September 12, 1991.

A copy of the application is available for public inspection at each of the following locations:

Office of the Port Director, U.S. Customs Service, P.O. Box 19369, 1825 Crossbeam Road, Charlotte, NC 28219.

Office of the Executive Secretary, Foreign-Trade Zones Board, U.S. Department of Commerce, 14th & Pennsylvania Avenue, NW, room 3716, Washington, DC 20230.

Dated: July 19, 1991.

John J. Da Ponte, Jr.,

Executive Secretary.

[FR Doc. 91-17807 Filed 7-25-91; 8:45 am]

BILLING CODE 3510-DS-M

[Docket 40-91]

Application for Subzone, IBM Information Processing Equipment Plant, Raleigh/Durham, NC

An application has been submitted to the Foreign-Trade Zones Board (the Board) by the Triangle J Council of Governments, grantee of FTZ 93, requesting special-purpose subzone status for the information processing equipment manufacturing complex of International Business Machines Corporation (IBM) in the Raleigh/Durham, North Carolina, area. The application was submitted pursuant to the provisions of the Foreign-Trade Zones Act, as amended (19 U.S.C. 81a-81u), and the regulations of the board (15 CFR part 400). It was formally filed on July 8, 1991.

IBM is an international producer and distributor of information processing equipment and systems with annual sales of some \$63 billion.

The proposed subzone involves a main manufacturing facility and five related facilities (total, 807 acres): *Site 1* (688 acres)—main manufacturing and distribution, Research Triangle Park (RTP), southeast of Durham in Durham County; *Site 2* (15 acres)—remanufacturing and storage, IBM Building 646, South Miami Boulevard, RTP; *Site 3* (18 acres)—raw material storage, IBM Buildings 644 and 654, Alexander and Wreck Drives, RTP; *Site 4* (15 acres)—manufacturing and administration, 2520 Yonkers Road, IBM Building 802, Raleigh; *Site 5* (10 acres)—

research and development, 3808 Six Forks Road, IBM Building 051, Raleigh; *Site 6* (61 acres)—finished product storage, operated by Triangle North American under contract to IBM, Tri-Center Buildings III/IV, V and VI, Tricenter Boulevard and Northeast Creek Parkway, RTP.

The facilities employ 13,000 persons and are used primarily for the research and manufacture of IBM's Communications System Line of Business Products, including Personal System/1 and Personal System/2 computers, communications controllers and multiplexers, modems, token-ring networks, supermarket and retail store systems, harsh environment computers, special project computers, display and monitors, ASCII terminals, Entry systems monitors, and miscellaneous parts. Up to 40 percent of the components for these products are sourced abroad including hard and floppy disk drive units, printed circuit boards and assemblies, monitors, mouse units, keyboards, cathode ray tubes, dot matrix printers, power supplies, parts and assemblies for automatic banking machines, electric motors, generators, transformers, resistors, transistors, switching apparatus, electronic integrated circuits and microassemblies, magnetic disks and diskettes, wire and cable, insulators and fittings, optical fibers, lasers, fans, battery packs, fasteners, hangers, screws, bolts, valves, bushings, bearings, and certain articles of plastic and rubber. Certain components produced at the Raleigh/Durham plants are shipped to other IBM plants, and some 12 percent of the finished computer equipment is exported.

Zone procedures would exempt IMB from Customs duty payments on foreign parts that are used in production for export. On its domestic sales, it would be able to choose the duty rates that apply to finished products (0.0 to 10.0 percent, averaging 4.9 percent). The duty rates on foreign components range from 0.0 to 14.0 percent. The application indicates that savings from zone procedures will help improve the international competitiveness of the company's U.S. plants.

In accordance with the Board's regulations, an examiners committee has been appointed to investigate the application and report to the Board. The committee consists of: Dennis Puccinelli (Chairman), Foreign-Trade Zones Staff, U.S. Department of Commerce, Washington, DC 20230; Howard Cooperman, Regional Director, Inspection and Control, U.S. Customs Service, Southeast Region, 909 SE. First Avenue, Miami, Florida, 33131-2595; and

Colonel W. Scott Tulloch, District Engineer, U.S. Army Engineer District Wilmington, P.O. Box 1890, Wilmington, NC 28402-1890.

Comments concerning the proposed subzone are invited in writing from interested parties. They should be addressed to the Board's Executive Secretary at the address below and postmarked on or before September 12, 1991.

A copy of the application is available for public inspection at each of the following locations:

Office of the District Director, U.S. Department of Commerce, 203 Federal Building, 324 W. Market Street, P.O. Box 1950, Greensboro, NC 27402.

Office of the Executive Secretary, Foreign-Trade Zones Board, U.S. Department of Commerce, 14th & Pennsylvania Avenue, NW, room 3716, Washington, DC 20230.

Dated: July 19, 1991.

John J. Da Ponte, Jr.,

Executive Secretary.

[FR Doc. 91-7808 Filed 7-25-91; 8:45 am]

BILLING CODE 3510-DS-M

International Trade Administration

[A-583-505]

Oil Country Tubular Goods From Taiwan; Determination Not To Revoke Antidumping Duty Order

AGENCY: International Trade Administration/Import Administration, Department of Commerce.

ACTION: Determination not to revoke antidumping duty order.

SUMMARY: The Department of Commerce is notifying the public of its determination not to revoke the antidumping duty order on oil country tubular goods from Taiwan.

EFFECTIVE DATE: July 26, 1991.

FOR FURTHER INFORMATION CONTACT: Barbara Victor or Thomas Futtnar, Office of Antidumping Compliance, Import Administration, International Trade Administration, U.S. Department of Commerce, 14th Street and Constitution Avenue NW., Washington, DC 20230; telephone (202) 377-3814.

SUPPLEMENTARY INFORMATION:

Background

On June 8, 1991, the Department of Commerce (the Department) published in the *Federal Register* (56 FR 26052) its intent to revoke the antidumping duty order on oil country tubular goods from Taiwan (51 FR 22098, June 18, 1986). The Department may revoke an order if the Secretary concludes that the order is no

longer of interest to interested parties. We did not receive a request for administrative review of the order for the last four consecutive annual anniversary months and, therefore, published a notice of intent to revoke the order pursuant to 19 CFR 353.25(d)(4).

On June 18, 1991, the Lone Star Steel Company and CF&I Steel Corporation, the petitioners, objected to our intent to revoke the order. On June 24, 1991, North Star Steel Company, a domestic producer, also objected to our intent to revoke. Therefore, we no longer intend to revoke the order.

Dated: July 19, 1991.

Roland L. MacDonald,

Acting Deputy Assistant Secretary for Compliance.

[FR Doc. 91-17809 Filed 7-25-91; 8:45 am]

BILLING CODE 3510-DS-M

[A-588-028]

Roller Chain, Other Than Bicycle, From Japan; Preliminary Results of Antidumping Duty Administrative Reviews

AGENCY: International Trade Administration/Import Administration, Department of Commerce.

ACTION: Notice of preliminary results of antidumping duty administrative reviews.

SUMMARY: In response to requests from interested parties, the Department of Commerce has conducted administrative reviews of the antidumping duty order on roller chain, other than bicycle, from Japan. The reviews cover nine manufacturer/trading companies of the subject merchandise to the United States and the periods April 1, 1983 through March 31, 1984 and April 1, 1984 through March 31, 1985. We preliminarily determine dumping margins to range from 0.02 percent to 8.70 percent for the period April 1, 1983 through March 31, 1984 and 0.33 percent to 9.01 percent for the period April 1, 1984 through March 31, 1985. We invite interested parties to comment on these preliminary results.

EFFECTIVE DATE: July 26, 1991.

FOR FURTHER INFORMATION CONTACT: Randall Edwards, Kelly Parkhill, or Michael Rollin, Office of Countervailing Compliance, International Trade Administration, U.S. Department of Commerce, Washington, DC 20230; telephone: (202) 377-2786.

SUPPLEMENTARY INFORMATION:

Background

On April 12, 1973, a dumping finding with respect to roller chain, other than bicycle, from Japan was published in the *Federal Register*, as Treasury Decision 73-100 (38 FR 9226). On August 12, 1985, the Department of Commerce (the Department) published in the *Federal Register* (50 FR 32556), a notice outlining the procedures for requesting administrative reviews of this and other findings and orders covering periods between 1983 and 1985. The Department received timely requests from the petitioner and/or respondents concerned with the roller chain findings and initiated reviews on July 9, 1986 (51 FR 24883). Since that time, the petitioner and several respondents have withdrawn some of their requests for review. The remaining companies covered by this notice of preliminary results of administrative reviews for the periods April 1, 1983 through March 31, 1984 and April 1, 1984 through March 31, 1985, are: Caddy Corporation of America (Caddy); Hitachi Metals Techno, Ltd. and Hitachi Maxco, Ltd. (Hitachi); Izumi Chain Manufacturing Co., Ltd. (Izumi); Kaga Kogyo K.K. (Kaga); Kaga/APC; Pulton Chain Co., Inc. (Pulton); Pulton/HIC; Pulton/I&OC; and Takasago RK Excel Co., Ltd. (Takasago). The Department has now conducted these reviews in accordance with section 751 of the Tariff Act of 1930, as amended ("the Tariff Act").

Scope of Review

Imports covered by these reviews are shipments of roller chain, other than bicycle, from Japan. The term "roller chain, other than bicycle" as used in these reviews includes chain, with or without attachments, whether or not plated or coated, and whether or not manufactured to American or British standards, which is used for power transmission and/or conveyance. Such chain consists of a series of alternately assembled roller links and pin links in which the pins articulate inside the bushings and the rollers are free to turn on the bushings. Pins and bushings are press fit in their respective link plates. Chain may be single strand, having one row of roller links, or multiple strand, having more than one row of roller links. The center plates are located between the strands of roller links. Such chain may be either single or double pitch and may be used as power transmission or conveyor chain.

The reviews also cover leaf chain, which consists of a series of link plates alternately assembled with pins in such a way that the joint is free to articulate between adjoining pitchers. The reviews

further cover chain model numbers 25 and 35. From 1983 through 1985, roller chain, other than bicycle, was classified under item numbers ranging from 652.1300 through 652.3800 of the Tariff Schedules of the United States Annotated (TSUSA). This product is currently classified under item numbers 7315.11.00 through 7315.12.00 of the Harmonized Tariff Schedule (HTS). The TSUSA and HTS categories are provided for convenience and customs purposes. The written description remains dispositive.

These reviews cover the above nine manufacturers/exporters of roller chain, other than bicycle, from Japan to the United States for the periods April 1, 1983 through March 31, 1984 and April 1, 1984 through March 31, 1985.

Preliminary Results of Reviews

The Department calculated a foreign market value (FMV) based on packed, delivered prices to unrelated wholesalers and original equipment manufacturers in Japan, in accordance with section 773(a)(1)(A) of the Tariff Act. In consideration of the significant volume of home market sales, the format in which the data were submitted, the age of these reviews, and the ability of the respondents to collect supplemental information we calculated a single annual FMV for each model on a weighted-average basis, in accordance with section 777A of the Tariff Act. To ensure the representativeness of the annual weighted-average FMV for each model, we compared the monthly weighted-average home market price (and in some cases each home market sale) during the period of review with the annual weighted-average home market price for that model, and determined that the prices for each model did not vary meaningfully from the annual weighted-average. Therefore, the Department considered the annual weighted-average FMV to be representative of the transactions under consideration, and it was used throughout these reviews.

A. Caddy Corporation of America

Caddy Corporation has requested a review of a one-time sale of Tsubakimoto chain to Caddy Corporation of America. The company claims that its Japanese subsidiary, Caddy Japan, was incorrectly listed as the seller/exporter for dumping duty deposit purposes. According to the company, the Department should have treated this transaction as a sale by Tsubakimoto.

The Department has determined that Tsubakimoto knew that the chain it sold Caddy Corporation was to be

incorporated into a food tray conveyor system in the United States.

Tsubakimoto sold the chain to Rockaway Trading Company (Far East) Ltd. (Caddy Corporation's related trading company) which exported the chain directly to Caddy Corporation of America. Since Tsubakimoto knew at the time of the sale that its chain was destined for export to the United States, the sale should be treated as a sale by Tsubakimoto, not a sale by Caddy Corporation. The order on roller chain from Japan was revoked with regard to Tsubakimoto effective September 1, 1983 (54 33259, August 14, 1989). As such, we preliminarily determine that this sale by Tsubakimoto to Caddy Corporation was subsequent to the revocation and thus not subject to this administrative review.

B. Hitachi Metals Techno, Ltd. and Hitachi Maxco, Ltd.

United States Price

As provided for in section 772(b) of the Tariff Act, we used purchase price to represent the United States price for certain sales by Hitachi because the merchandise was sold to unrelated parties prior to importation into the United States. For all other sales, where the merchandise was sold to unrelated purchasers after importation into the United States, we used exporter's sales price (ESP), as provided for in section 772(c) of the Tariff Act.

We calculated the purchase price and ESP based on packed, duty paid, delivered prices to unrelated purchasers in the United States. For purchase price and ESP transactions, we made deductions, where appropriate, for foreign brokerage, wharfage, ocean freight, marine insurance, U.S. duty, U.S. freight and brokerage. We disagreed with Hitachi's calculation methodology of using gross unit prices to determine these expenses. Where appropriate, we recalculated the above expenses using unit prices adjusted for discounts.

For ESP transactions, in accordance with section 772(e)(2) of the Tariff Act, we made additional deductions, where appropriate, for credit expenses and indirect selling expenses. We also recalculated the above expenses using unit prices adjusted for discounts.

Foreign Market Value

In accordance with section 773(a)(1)(A) of the Tariff Act, we calculated the FMV based on packed prices to unrelated customers in Japan.

For comparisons involving ESP sales, we added U.S. commissions to the FMV and subtracted home market indirect

selling expenses up to the amount of the U.S. commission.

For comparisons involving ESP sales, we deducted home market indirect selling expenses. This deduction for indirect selling expenses was capped by the amount of indirect selling expenses and commissions incurred in the U.S. market, in accordance with 19 CFR 353.56.

In instances where there were no sales of identical or similar merchandise in the home market, we used constructed value with which to compare merchandise sold in the United States. We used cost of manufacturing information furnished by Hitachi and added the statutory 10 percent minimum for selling, general and administrative costs and the statutory 8 percent minimum for profit as defined in section 773(e)(1)(B) of the Tariff Act. For those sales where we could not construct a value, we have used the weighted-average margin calculated for Hitachi for the appropriate review period as the best information available.

C. Izumi Chain Manufacturing Co., Ltd.

Izumi provided an inadequate questionnaire response, and subsequently declined to respond to the supplemental questionnaire and deficiency letter, or to participate further in the reviews. The deficiencies in Izumi's responses effectively preclude our ability to calculate margins using Izumi's submitted data.

The Department used the best information available in accordance with section 776(c) of the Tariff Act. Consistent with our past practice and policy, when a respondent fails or refuses to respond, we use the higher of (a) the highest calculated rate for any firm with shipments during the period of review, or (b) that firm's own last rate. Izumi's own last rate was 0 percent, and was published on May 13, 1987 (52 FR 18004). Accordingly, as best information available, the Department used the highest rate calculated for another firm with shipments during the period.

For the 1983-1984 review period, we used the 8.70 percent rate from Kaga Kogyo, as BIA. For the 1984-1985 review period, we used the 9.01 percent rate from Takasago, as BIA.

D. Kaga Kogyo K.K. and Kaga/APC

United States Price

In calculating United States price, the Department used purchase price as defined in section 772(b) of the Tariff Act. Kaga made sales during the review period to APC, an unrelated Japanese trading company. As provided under section 772(b) of the Tariff Act, we used

purchase price for all sales to APC because Kaga knew at the time of the sale to APC that the ultimate destination of the merchandise was the United States.

We made deductions, where appropriate, for foreign inland freight, packing and credit expenses. We recalculated foreign inland freight and packing expenses using other data submitted by respondent as the best information available because Kaga did not provide sufficient information to support its allocation methodology, and because no other information was available.

Foreign Market Value

In accordance with section 773(a)(1)(A) of the Tariff Act, we calculated the foreign market value based on packed prices to unrelated customers in Japan. We made deductions to the foreign market value for inland freight expenses. We also made circumstance of sale adjustments, where appropriate, for differences in credit and adjusted for differences in packing in accordance with 19 CFR 353.56.

For sales that could not be matched with an FMV, as best information available, we used a weighted-average margin calculated for Kaga for the appropriate review period.

E. Pulton Chain Co., Inc., Pulton/HIC, and Pulton/I&OC of Japan Co., Ltd.

United States Price

In calculating United States price, the Department used purchase price as defined in section 772(b) of the Tariff Act. Purchase price was based on the packed, delivered prices to unrelated purchasers in the United States. Pulton also made sales during the review period to HIC and I&OC, unrelated Japanese trading companies. As provided under section 772(b) of the Tariff Act, we used purchase price for all sales to HIC and I&OC because Pulton knew at the time of the sale to the Japanese trading company that the ultimate destination of the merchandise was the United States. We made deductions, where appropriate, for brokerage and handling, foreign inland freight, ocean freight, and marine insurance. We recalculated foreign inland freight expense using data submitted by Pulton as the best information available because Pulton did not provide sufficient information to support its allocation methodology.

Foreign Market Value

In accordance with section 773(a)(1)(A) of the Tariff Act, we

calculated the FMV based on packed, delivered prices to unrelated customers in Japan. We made deductions to the FMV for inland freight. We also made circumstances of sale adjustments, where appropriate, for differences in credit and adjusted for differences in packing.

In instances where there were no sales of identical merchandise in the home market with which to compare merchandise sold to the United States, we calculated a weighted-average FMV for sales of identical chain to unrelated companies in third countries because we had no information to enable us to determine whether other models sold in the home market were sufficiently similar to permit comparison, and because of the age of the reviews, we had insufficient information available to calculate constructed value. We made deductions to the FMV for brokerage and handling, inland freight and marine insurance. We also made circumstance of sale adjustments, where appropriate, for differences in credit and adjusted for differences in packing.

For those products sold in the United States for which there were no identical matches using third country sales and for which Pulton was able to provide cost of production data, we calculated FMV based on constructed value as provided for in section 773(e) of the Tariff Act. Constructed value includes the cost of materials and fabrication of the merchandise, plus general expenses, profit and packing. For material, direct labor and overhead, the Department used the respondent's data. Some of these figures were adjusted using respondent's data to coincide with sales value information submitted on a per foot basis. Actual selling, general and administrative costs were used because these amounts exceeded the statutory minimum of 10 percent as defined in section 773(e)(1)(B) of the Tariff Act. For profit, we used the statutory minimum of 8 percent as defined in section 773(e)(1)(B) of the Tariff Act. We added the respondent's per unit amount of packing recalculated on a per foot basis to arrive at total constructed value.

For the remaining products in which third country sales or constructed value could not be used, we used as best information available a weighted average margin calculated for Pulton for the appropriate review period.

We did not review Pulton/HIC in the 1984/85 review period because HIC withdrew its request for review and

there was no request by the petitioner to review such sales from this period.

F. Takasago RK Excel Co., Ltd.

United States Price

In calculating United States price, the Department used purchase price was defined in section 772(b) of the Tariff Act. Purchase price was based on the packed, delivered, prices to unrelated purchasers in the United States. Takasago also made sales during the review period to Central Industries and Hitachi, unrelated Japanese trading companies. As provided under section 772(b) of the Tariff Act, we used Takasago's price to Central and Hitachi as purchase price because Takasago knew at the time of the sale to these Japanese trading companies that the ultimate destination of the merchandise was the United States. We reallocated foreign inland freight and insurance expenses using data submitted by the respondent as the best information available because respondent did not provide sufficient information to support its calculation methodology. Allocation percentages for these expenses were calculated by dividing total freight and insurance expenses by total sales. These expenses were then deducted from the U.S. price.

Takasago failed to provide packing expenses for each U.S. sale made during the review periods. From the narrative description in Takasago's response, we determined that there was a cost differential between packing expenses for products sold in the United States and in the home market. Therefore, we determined packing expense from a cost of production information sheet submitted by Takasago regarding packing expenses for certain chain exported to the United States. Where we had no packing expense information for certain types of chain, we determined a weighted-average packing expense from the cost of production information as the best information available and deducted the expense from the U.S. price.

Foreign Market Value

In accordance with section 773(a)(1)(A) of the Tariff Act, we calculated the FMV based on packed delivered prices to unrelated customers in the home market. We corrected foreign inland freight and insurance expenses using data submitted by the respondent as the best information available because respondent did not provide sufficient information to support its calculation methodology. Allocation percentages for these expenses were calculated by dividing total freight and

insurance expenses by total sales. These expenses were then deducted from the home market price. Further, Takasago failed to provide the Department with sufficient information about packing expenses it incurred on home market sales. The Department, therefore, made no deductions for packing expenses in the home market.

We added U.S. commissions to the FMV and subtracted home market indirect selling expenses up to the amount of the U.S. commission.

In instances where there were no sales of identical or similar merchandise in the home market with which to compare merchandise sold in the United States, we used the following hierarchy to calculate FMV: (1) The domestic price list used by domestic sellers of Takasago chain, with appropriate adjustments; (2) constructed value; and (3) the weighted-average dumping margin calculated for this company during the appropriate period of review as the best information available.

Currency Conversion

In accordance with 19 CFR 353.60, we used the official exchange rate in effect on the appropriate dates for determining FMV. All currency conversions were made at the rates certified by the Federal Reserve Bank.

Preliminary Results of the Review

As a result of our review, we preliminarily determine the margins to be:

| Manufacturer/exporter | Margin percent | |
|--|-------------------|-------------------|
| | 04/01/83-03/31/84 | 04/01/84-03/31/85 |
| Caddy Corporation of America | NA | ¹ NA |
| Hitachi Metals Techno, Ltd. and Hitachi Maxco, Ltd. | 2.01 | 7.67 |
| Izumi Chain Manufacturing Co. | 8.70 | 9.01 |
| Kaga Kogyo K.K. | 8.70 | .41 |
| Kaga/APC | 8.70 | .41 |
| Pulton Chain Co., Inc. | 0.02 | .29 |
| Pulton/HIC | 0.02 | NA |
| Pulton/I&OC | 0.02 | .29 |
| Takasago RK Excel Co., Ltd. | 1.46 | 9.01 |

¹ Caddy's one-time sale is actually a sale by Tsubakimoto, a company for which the effective date of revocation of the antidumping order was prior to these review periods.

The Department will issue appraisal instructions concerning each manufacturer/exporter directly to the Customs Service upon completion of these administrative reviews.

Because the Department has already

completed and published the final results of reviews for subsequent, intervening review periods, the dumping margins determined in these reviews will have no impact on the current cash deposit rates. As provided by section 751(a)(1) of the Tariff Act, the Customs Service shall continue to require a cash deposit based on each firm's most recent administrative review period. For any future entries of this merchandise from a new producer and/or exporter, not covered in these or prior administrative reviews, and who is unrelated to any previously reviewed firms, a cash deposit of estimated antidumping duties, equal to the highest non-BIA rate for any firm with shipments during the most recently completed review period, shall be required.

Public Comment

Parties to the proceeding may request disclosure within five days and interested parties may request a hearing no later than ten days after the date of publication of this notice. Interested parties may submit written arguments in case briefs on these preliminary results within 30 days of the date of publication. Rebuttal briefs, limited to arguments raised in case briefs, may be submitted no later than seven days after the time limit for filing the case brief. Any hearing, if requested, will be held seven days after the scheduled date for submission of rebuttal briefs. Copies of case briefs and rebuttal briefs must be served on interested parties in accordance with 19 CFR 353.38(e).

Representatives of parties to the proceeding may request disclosure of proprietary information under administrative protective order no later than ten days after the representative's client or employer becomes a party to the proceeding, but in no event later than the date the case briefs, under 19 CFR 353.38(c), are due.

The Department will publish the final results of this administrative review, including the results of its analysis of issues raised in any case or rebuttal brief or at a hearing.

This administrative review and notice are in accordance with section 751(a)(1) of the Tariff Act (19 U.S.C. 1675(a)(1)) and 19 CFR 353.22.

Dated: July 19, 1991.

Eric I. Garfinkel,

Assistant Secretary for Import Administration.

[FR Doc. 91-17810 Filed 7-25-91; 8:45 am]

BILLING CODE 3510-05-M

[A-588-015]

Television Receivers, Monochrome and Color, From Japan; Final Results of Antidumping Duty Administrative Reviews

AGENCY: Import Administration/ International Trade Administration, Department of Commerce.

ACTION: Notice of final results of antidumping duty administrative reviews.

SUMMARY: On April 3, 1991, and April 16, 1991, the Department of Commerce published the preliminary results of its administrative reviews of the antidumping finding on television receivers, monochrome and color, from Japan. The reviews cover one manufacturer/exporter of this merchandise to the United States, Matsushita Electric Industrial Company, Ltd., and the periods August 19, 1983 through March 31, 1984, April 1, 1984 through February 28, 1985, and March 1, 1985 through February 28, 1986.

We gave interested parties an opportunity to comment on our preliminary results. No public hearing was held.

After analyzing the comments received, we have determined not to revise the preliminary results of these reviews. The final margins are 1.71 percent, 1.47 percent, and 11.52 percent, respectively.

EFFECTIVE DATE: July 26, 1991.

FOR FURTHER INFORMATION CONTACT: David S. Levy or Melissa G. Skinner, Office of Antidumping Compliance, International Trade Administration, U.S. Department of Commerce, Washington, DC 20230; telephone: (202) 377-3601, or 377-4851, respectively.

SUPPLEMENTARY INFORMATION:

Background

On April 3, 1991, and April 16, 1991, the Department of Commerce (the Department) published in the Federal Register (56 FR 13620 and 56 FR 15328) the preliminary results of its administrative reviews of the antidumping finding on television receivers, monochrome and color, from Japan (36 FR 4597, March 10, 1971). We now have completed these administrative reviews in accordance with section 751 of the Tariff Act of 1930 (the Tariff Act).

Scope of the Reviews

Imports covered by the reviews are shipments of television receivers, monochrome and color, from Japan. Television receivers include, but are not limited to, units known as projection

television, receiver monitors, and kits (containing all parts necessary to receive a broadcast television signal and produce a video image). Not included are certain monitors not capable of receiving a broadcast signal, certain combination units, and certain subassemblies not containing the components essential for receiving a broadcast television signal and producing a video image. During the review periods, television receivers, monochrome and color, were classifiable under item numbers 684.9230, 684.9232, 684.9234, 684.9236, 684.9238, 684.9240, 684.9245, 684.9246, 684.9248, 684.9250, 684.9252, 684.9253, 684.9255, 684.9256, 684.9258, 684.9262, 684.9263, and 684.9655 of the Tariff Schedules of the United States Annotated (TSUSA). This merchandise is currently classifiable under item numbers 8528.10.80 and 8528.20.00 of the Harmonized Tariff Schedule (HTS). The TSUSA and HTS item numbers are provided for convenience and Customs purposes only. The written description remains dispositive.

These reviews cover one manufacturer/exporter to the United States of Japanese televisions, Matsushita Electric Industrial Company, Ltd. (Matsushita), and the periods August 19, 1983 through March 31, 1984, April 1, 1984 through February 28, 1985, and March 1, 1985 through February 28, 1986.

Analysis of Comments Received

We invited interested parties to comment on the preliminary results. We received case briefs and rebuttal comments from Zenith Electronics Corporation (Zenith), and Matsushita. Although Matsushita has originally requested that a public hearing be held on the preliminary results of these reviews, the requests were subsequently withdrawn and no hearing was held.

Comment 1: Zenith states that the Department unlawfully treated Japanese commodity taxes rebated or not collected by reason of exportation of the merchandise. According to Zenith, the Department added the full amount of the commodity tax to United States Price (USP), and made a circumstance-of-sale (COS) adjustment to foreign market value (FMV) for the difference between the Japanese and U.S. commodity taxes. Zenith argues that the Court of International Trade (CIT), in *Zenith Electronics Corp. v. United States*, 755 F. Supp. 397 (1990) (as clarified by the Court Order dated February 20, 1991), ruled that the Department must cap the amount of commodity tax added to USP at the amount of tax included in FMV,

and that the Department is forbidden from neutralizing the commodity tax adjustment to USP by making a COS adjustment to FMV for differences in commodity taxes.

Matsushita responds that Zenith's comments are irrelevant because they do not address the calculations actually made by the Department, and that the Department's treatment of commodity taxes is in accordance with law because it properly ensures that dumping margins are not artificially influenced by differences between the Japanese and U.S. commodity taxes.

Department's Position: We do not agree with the CIT in *Zenith*, but have not had an opportunity to appeal the issue on its merits. We agree that the amount of commodity tax forgiven by reason of the exportation of televisions to the United States must be added to USP under the statute and may not exceed the amount included in the home market price. However, because we believe that dumping margins should be neither inflated nor deflated by differences between the Japanese commodity taxes and constructed commodity taxes applied to USP, we do not agree with the CIT's position on adjustments for differences in commodity taxes. After calculating the commodity tax and adding it to USP, we make an adjustment to FMV for the difference in commodity taxes by deducting the Japanese commodity tax from FMV and replacing it with the constructed U.S. commodity tax. This method ensures that the amount of commodity tax added to USP does not exceed the amount of commodity tax included in the home market price, and that dumping margins are not artificially influenced by differences in commodity taxes. See our response to Comment 22 in *Television Receivers, Monochrome and Color, From Japan; Final Results of Antidumping Duty Administrative Reviews* (56 FR 5396, 5397, February 11, 1991).

Comment 2: Zenith argues that the Department failed to account for the savings realized by Matsushita as a result of delayed payment of home market discounts, rebates, and selling expense accounts payable. According to Zenith, if Matsushita does not disburse funds immediately after incurring an obligation to pay a particular expense, it earns interest income on those funds until it actually pays for the expense. As a result, Zenith argues that the true measure of Matsushita's selling expenses is not the amount paid by Matsushita, but the amount of the payment less the savings realized by delayed payment of the expense.

Accordingly, Zenith argues that the Department should reduce Matsushita's home market selling expenses by the amount of any interest earnable as a result of delayed payment of those expenses.

Matsushita responds that the Department has repeatedly considered, and rejected, this argument. Matsushita asserts that the antidumping law and regulations require that adjustments to price must be measured by a respondent's actual expenses. Moreover, Matsushita argues that its actual interest expenses, as reported in its questionnaire responses, already reflect the savings realized by delayed payment of selling expenses because these interest expenses would be higher if the company paid its outstanding obligations on a more current basis.

Department's Position: We disagree with Zenith. We avoid imputing expenses or costs when a company quantifies and documents its actual expenses, and when the company's quantification accurately reflects the expense to the seller. Since we determined that Matsushita accurately quantified its home market selling expenses, and that Matsushita's claims accurately reflected those expenses, we have not reduced them by the amount of any savings realized as a result of delayed payment. See our response to Comment 2 in *Television Receivers, Monochrome and Color, From Japan; Final Results of Antidumping Duty Administrative Review* (54 FR 13918, April 6, 1989).

Comment 3: Zenith argues that the Department should deduct antidumping-related legal expenses from exporter's sales price (ESP). According to Zenith, these expenses are selling expenses because they are incurred as a result of a respondent's selling the merchandise under review in the United States at prices below FMV. Moreover, Zenith argues that there is no basis for retaining legal expenses incurred as a result of an antidumping proceeding in ESP when all other legal expenses incurred by a foreign company's U.S. subsidiary are deducted from ESP.

Matsushita responds that the Department has repeatedly ruled that legal expenses incurred as a result of an antidumping proceeding are not selling expenses, and that the CIT, in *Daewoo Electronics Co. v. United States*, 712 F. Supp. 931, 974 (1989), upheld the Department's position on the grounds that the deduction of antidumping-related legal expenses from ESP would create artificial dumping margins.

Department's Position: We disagree with Zenith. As we have stated in

previous reviews of this finding, we do not consider legal expenses incurred in defending against an allegation of dumping to be expenses incurred in selling the merchandise in the United States. As a result, we have not deducted these expenses from ESP in these final results. See our response to Comment 4 in *Television Receivers, Monochrome and Color, From Japan; Final Results of Antidumping Duty Administrative Review* (54 FR 13919, April 6, 1989).

Comment 4: Zenith argues that the Department should deduct payments of estimated antidumping duties, and any expenses related to such payments, from USP. According to Zenith, these items should be deducted from USP along with the estimated ordinary duties paid, because the statute specifically requires that "United States import duties" be deducted from USP.

Matsushita replies that estimated antidumping duty payments are not actual expenses, but provisional deposits. Moreover, Matsushita notes that both the Department and the CIT previously have rejected Zenith's arguments on this issue.

Department's Position: We disagree with Zenith. As we have stated in previous reviews of this finding, we believe that using estimated amounts of antidumping duties in our calculations would result in inaccurate margins. In addition, we do not consider payments of estimated antidumping duties to be expenses related to the sales under review. As a result, we have not deducted them from USP in these final results. See our response to Comment 5 in *Television Receivers, Monochrome and Color, From Japan; Final Results of Antidumping Duty Administrative Review* (54 FR 13919, April 6, 1989).

Comment 5: Zenith contends that the Department erroneously offset the full amount of commissions in the United States with home market indirect selling expenses. According to Zenith, commissions compensate the recipient for both direct and indirect selling expenses incurred on behalf of the respondent. As a result, Zenith argues that offsetting the full amount of the commission provides excessive compensation for the indirect selling expenses contained therein. Additionally, because FMV has already been adjusted for direct selling expenses, Zenith claims that an offset for the full amount of the commission negates the deduction from USP of the direct expense portion of the commission.

Matsushita responds that the statute clearly states that the Department

should include the total amount of commissions paid in the ESP offset cap, and that there is no legal or factual basis for dividing commissions into direct and indirect expenses.

Department's Position: We disagree with Zenith. When commissions are paid in one market but not in the other, 19 CFR 353.56(b)(1) requires us to offset the commission with other selling expenses incurred in the other market. We do not interpret our regulations as requiring us to limit the offset to a specific portion of the expenses of the commissionaire. As a result, we have offset the full amount of the U.S. commissions in these final results. See our response to Comment 6 in Television Receivers, Monochrome and Color, From Japan; Final Results of Antidumping Duty Administrative Review (54 FR 13919, April 6, 1989).

Comment 6: Zenith asserts that the Department may have improperly used home market indirect expenses that are not selling expenses as an offset to U.S. indirect selling expenses. Zenith states that the Department should require an affirmative demonstration from Matsushita that all home market indirect expenses that it claimed as ESP offsets are actually selling expenses, and not general and administrative expenses.

Matsushita responds that it has already described the nature of the home market indirect expenses that it claimed as an ESP offset as well as their relationship to the selling of televisions in Japan, and that the Department has verified the accuracy of Matsushita's submissions on numerous occasions.

Department's Position: We disagree with Zenith. As we have stated in previous reviews of this case, the pool of indirect selling expenses in the home market should include those expenses that are similar to the expenses incurred by the U.S. subsidiary, whose function it is to sell the merchandise. We do not interpret our regulations as requiring that indirect selling expenses in the home market be limited to selling expenses in sales offices, and as excluding general and administrative expenses incurred by those offices. As a result, we believe it was appropriate for Matsushita to include certain general expenses associated with selling televisions in its home market indirect selling expense claim. Moreover, we verified the accuracy of Matsushita's questionnaire responses. Therefore, we believe that Matsushita did not overstate its home market indirect selling expenses, and we have used all these expenses in calculating the ESP offset for these final results. See our response to Comment 3 in Television Receivers, Monochrome and Color,

From Japan; Final Results of Antidumping Duty Administrative Review (54 FR 13919, April 6, 1989).

Comment 7: Zenith contends that the Department erroneously excluded discounts, rebates, and the commodity tax from its constructed value (CV) calculations. According to Zenith, these items must be included among the "general expenses" component of CV because the statute requires that those general expenses encompass what is usually reflected in sales. Because Matsushita acknowledges that discounts, rebates, and commodity taxes are included in the selling price of the merchandise, and because the Department routinely adjusts for these items under its authority to adjust for differences in circumstances of sale, Zenith argues that they are "general expenses" as defined in the statute, and should, therefore, be included in CV.

Matsushita responds that the Department considers discounts and rebates to be adjustments to price rather than selling expenses, and that the statute does not provide for the inclusion of commodity taxes in the calculation of CV.

Department's Position: We disagree with Zenith. As we have stated in previous reviews of this case, we do not consider discounts and rebates to be selling expenses; as Matsushita correctly states, we consider discounts and rebates to be adjustments to price. We also agree with Matsushita that the statute does not provide for the inclusion of commodity taxes in our CV calculations. As a result, we have not included discounts, rebates, and the commodity tax in our CV calculations for these final results. See our response to Comment 20 in Television Receivers, Monochrome and Color, From Japan; Final Results of Antidumping Duty Administrative Review (56 FR 5396, February 11, 1991).

Comment 8: Matsushita objects to the Department's decision to initiate these administrative reviews without ruling in a timely manner on Matsushita's December 18, 1981, request for revocation of the antidumping finding on televisions.

Zenith replies that the Department rejected this argument during the previous reviews of Matsushita, and should do so again in the current reviews.

Department's Position: We disagree with Matsushita. During our previous reviews of Matsushita, we found dumping margins for the partial fifth and eighth administrative reviews, and determined that there was a likelihood of resumed dumping if the finding were to be revoked. Based on these analyses,

we determined not to revoke the antidumping finding with respect to Matsushita. Thus, contrary to Matsushita's assertions, we did rule on its revocation request before initiating the current reviews. As a result, we believe that Matsushita's objections regarding the validity of these reviews are inaccurate and inappropriate. See our response to Comment 75 in Television Receivers, Monochrome and Color, From Japan; Final Results of Antidumping Duty Administrative Review (54 FR 13927, April 6, 1989).

Comment 9: Matsushita objects to the Department's decision to abandon the "traditional methodologies" that it was using at the time the Government entered into the 1980 settlement agreements with respondents in these proceedings.

Zenith responds that the Department should reject this argument as it did in the previous reviews of Matsushita.

Department's Position: We disagree with Matsushita. As we stated in the previous reviews of Matsushita, the 1980 settlement agreement did not constitute a commitment by the Department to use a particular method of calculating dumping margins. As a result, we have not employed the "traditional methodology" that was in use at the time of the settlement agreement in these final results. See our response to Comment 66 in Television Receivers, Monochrome and Color, From Japan; Final Results of Antidumping Duty Administrative Review (54 FR 13926, April 6, 1989).

Comment 10: Matsushita argues that the Department's exclusion of "other" overhead costs from the calculation of the adjustment for differences in the physical characteristics of the merchandise constitutes an unwarranted departure from past practice. According to Matsushita, its method of calculating adjustments for differences in the physical characteristics using materials, labor, and variable and other overhead was accepted by the Department in all previous reviews, and was never challenged by any other party. In addition, Matsushita claims that because its other overhead costs are allocated according to its direct labor costs, these costs are actually variable costs that should be included in the calculation of adjustments for differences in merchandise.

Zenith supports the Department's method of calculating this adjustment, stating that the overhead portion of the adjustment should be limited to variable overhead costs because, by definition, these are the only overhead costs that

vary according to physical differences in merchandise. Zenith argues further that the inclusion of indirect factory overhead in the calculation would nullify the exclusion of indirect expenses from COS adjustments.

Department's Position: We disagree with Matsushita. Our longstanding practice has been to calculate adjustments for differences in the physical characteristics of merchandise using materials, labor, and variable factory overhead only. We have, to the best of our knowledge, consistently used this method in all previous reviews of

this case, including those pertaining to Matsushita. To the extent that there has been any deviation from this practice, it was inadvertent, and was never intended to be deliberate departure from the practice described above.

We agree with Zenith that only variable costs should be used in the calculation of adjustments for differences in merchandise because, by definition, the magnitude of these costs changes according to the physical characteristics of the merchandise. Although fixed factory overhead may be allocated using a variable measure such

as direct labor, the fixed overhead costs themselves do not vary according to production, and, therefore, do not reflect differences in the physical characteristics of the merchandise. Accordingly, we have not included fixed overhead costs in our calculation of adjustments for differences in merchandise for these final results.

Final Results of the Reviews

After analyzing the comments received, we have determined not to revise our preliminary results for Matsushita. Accordingly, we determine the margins to be:

| Manufacturer | Review No. | Period of review | Margin (percent) |
|--------------|------------|-------------------|------------------|
| Matsushita | 5 | 08/19/83-03/31/84 | 1.71 |
| | 6 | 04/01/84-02/28/85 | 1.47 |
| | 7 | 03/01/85-02/28/86 | 11.85 |

The Department will instruct the U.S. Customs Service to assess antidumping duties on all appropriate entries. Individual differences between United States price and foreign market value may vary from the percentages stated above. The Department will issue appraisal instructions directly to the Customs Service.

Further, as provided for by section 751(a)(1) of the Tariff Act, a cash deposit of estimated antidumping duties of 35.40 percent will be required for Matsushita; this is Matsushita's rate from the eleventh administrative review. For shipments of this merchandise manufactured by Funai Electric, Fujitsu General, Ltd., Hitachi, Ltd., Mitsubishi Electric Corporation, NEC, Sanyo Electric Company, Ltd. Seiko Epson Corporation, Sharp Corporation, Toshiba, or Victor Corporation of Japan, the cash deposit rate will continue to be the same as the rates published in the final results of the last administrative reviews of these firms (56 FR 5392, February 11, 1991).

For all other manufacturers/exporters of this merchandise, a cash deposit of estimated antidumping duties of 38.28 percent shall be required. This is the highest non-BLA (best information available) rate for the most current review for any firm in this case (56 FR 16069, April 19, 1991). These deposit requirements will be effective for all shipments of Japanese television receivers, monochrome or color, entered, or withdrawn from warehouse, for consumption on or after the date of publication of the final results of these administrative reviews.

These administrative reviews and this notice are in accordance with section 751(a)(1) of the Tariff Act (19 U.S.C. 1675(a)(1)) and 19 CFR 353.22.

Dated: June 28, 1991.
 Marjorie A. Chorlins,
Acting Assistant Secretary for Import Administration.
 [FR Doc. 91-17812 Filed 7-25-91; 8:45 am]
 BILLING CODE 3510-DS-M

[A-588-15]

Television Receivers, Monochrome and Color, from Japan; Final Results of Antidumping Duty Administrative Review

AGENCY: International Trade Administration/Import Administration, Department of Commerce.

ACTION: Notice of final results of antidumping duty administrative review.

SUMMARY: On April 26, 1991, the Department of Commerce published the preliminary results of its administrative review of the antidumping finding on television receivers, monochrome and color, from Japan. The review covers two manufacturers/exporters of this merchandise to the United States, Casio Computer Company, Ltd., and Citizen Watch Company, Ltd., and the period March 1, 1989 through February 28, 1990.

We gave interested parties an opportunity to comment on our preliminary results. Based on our analysis of the comments received and the correction of certain clerical errors, we have changed the final results from those presented in our preliminary results of review.

EFFECTIVE DATE: July 26, 1991.

FOR FURTHER INFORMATION CONTACT: Karin Price or Maureen Flannery, Office of Antidumping Compliance, International Trade Administration, U.S. Department of Commerce, 14th Street and Constitution Avenue, NW., Washington, DC 20230; telephone: (202) 377-2923.

SUPPLEMENTARY INFORMATION:

Background

On April 26, 1991, the Department of Commerce (the Department) published in the Federal Register (56 FR 19347) the preliminary results of its administrative review of the antidumping finding on television receivers, monochrome and color, from Japan (36 FR 4597, March 10, 1971). The Department has now completed that review in accordance with section 751 of the Tariff Act of 1930 (the Tariff Act).

Scope of the Review

Imports covered by this review are shipments of television receiving sets, monochrome and color, from Japan. Television receiving sets include, but are not limited to units known as projection televisions, receiver monitors, and kits (containing all parts necessary to receive a broadcast television signal and produce a video image). Not included are certain monitors not capable of receiving a broadcast signal, certain combination units, and certain subassemblies not containing the components essential for receiving a broadcast television signal and producing a video image. During the review period, television receiving sets, monochrome and color, were

classifiable under Harmonized Tariff Schedule (HTS) item numbers 8528.10.80 and 8528.20.00. The HTS item numbers are provided for convenience and Customs purposes only. The written description remains dispositive.

This review covers two manufacturers/exporters of Japanese television receivers, monochrome and color, Casio Computer Company, Ltd. (Casio), and Citizen Watch Company, Ltd. (Citizen), and the period March 1, 1989 through February 28, 1990.

Analysis of Comments Received

We invited interested parties to comment on the preliminary results. We received written comments from Zenith Electronics Corporation (Zenith), Casio and citizen. No public hearing was requested.

Comment 1

Zenith contends that the wrong variable is used in the section of Casio's and Citizen's computer programs that removes the sales sold at prices below the cost of production (COP) from the home market database. Zenith claims that the programming excludes sales below cost from the home market database when the below cost sales for the entire home market database are between 10 and 90 percent of total home market sales. Zenith states that the program should instead exclude below cost sales on a model-specific basis, that is, when the below cost sales of a particular model are between 10 and 90 percent of all of that model's sales.

Casio and Citizens respond that Zenith's argument is without merit since the programming indicates that the Department has correctly removed sales below cost from the home market database on a model-specific basis. Accordingly, they claim there is no need for programming changes.

Department's Position

We agree with Zenith and have corrected this error.

Comment 2

Zenith argues that Casio's U.S. sales which have a "negative United States price" are not "manipulated correctly" because a negative percentage dumping margin is calculated for these sales. Zenith contends that these sales actually have a positive dumping margin.

Casio replies that the negative percentage margin calculated for the individual sales for which there is a negative United States price (U.S. price) has no effect on the margin calculations. Casio contends that the absolute margin,

not the percentage margin, is used in the dumping margin calculation.

Department's Position

Certain sales had negative U.S. prices because, for these sales, adjustments to U.S. price exceeded the sales price. Although the negative U.S. price caused the computer program to show these sales as having a negative percentage margin, we agree with Zenith that these sales, in fact, have a positive dumping margin. We note that the percentage margin calculated for each sale is for informational purposes only, and has no effect on the final margin calculations because the weighted-average margin is calculated by dividing total dumping duties due by total U.S. price for all sales, not by averaging the percentage margins for each sale.

Comment 3

Zenith states that the Department unlawfully treated Japanese commodity and consumption taxes rebated or not collected by reason of exportation of the merchandise. According to Zenith, the Department added the full amount of the tax to U.S. price, and made a circumstance-of-sale (COS) adjustment to FMV for the difference between the amount of Japanese and U.S. tax. Zenith argues that the Court of International Trade (CIT) in *Zenith Electronics Corp. v. United States*, 755 F. Supp. 397 (1990) (as clarified by the Court order dated February 20, 1991) (*Zenith*) and in *Daewoo Electronics Co. v. United States*, 712 F. Supp. 931 (1989) (*Daewoo*), ruled that the Department must cap the amount of commodity or consumption tax added to U.S. price at the amount of tax added to FMV, and that the Department is forbidden from neutralizing the tax adjustment to U.S. price making a COS adjustment to FMV for differences in taxes. Moreover, the Department is required to measure the amount of commodity and consumption tax passed through to home market purchasers. Zenith also claims that the Department used an erroneously high tax base for determining the amount of commodity and consumption tax forgiven upon exportation, arguing that the Department should use the export price, not the resale price in the United States, as the tax base.

Casio replies that, with regard to consumption taxes, Zenith's comments are irrelevant because they do not address the calculations actually made by the Department. Casio contends that, with regard to commodity taxes, the Department correctly calculated the tax based on the constructed ex-factory price, the same tax base as that used for home market sales, and followed

longstanding practice in the treatment of the commodity tax, by adding the tax to U.S. price and making an adjustment to FMV for the differences between home market and U.S. taxes.

Citizen responds that the Department followed a well-established policy that the addition to U.S. price for taxes not be limited by the amount of tax in home market price. Citizen replies that the Department has repeatedly rejected Zenith's argument that the tax base for determining the amount of tax forgiven upon exportation should be the export price, and argues that the Department should determine that the appropriate tax base is the price to the first unrelated party in the United States.

Department's Position

We do not agree with the CIT in *Zenith* or *Daewoo*, but have not had an opportunity to appeal the issue on its merits. Consistent with our longstanding practice, we have not attempted to measure the amount of tax "passed-through" to customers in the home market. We do not agree that the statutory language limiting the amount of adjustment to the amount of tax "added to or included in the price" of color televisions (CTVs) in the home market requires the Department to measure the incidence of tax.

Because we believe that dumping margins should neither be inflated nor defaulted by differences between Japanese taxes and constructed taxes applied to U.S. price, we do not agree with the CIT's position on adjustments for differences in commodity taxes. After calculating the amount of commodity and consumption tax and adding it to U.S. price, we make an adjustment to FMV for the differences in taxes by deducting the Japanese consumption and commodity tax from FMV and replacing it with the constructed U.S. commodity and consumption tax. This method has the same effect on the absolute margin calculated as would capping the amount of U.S. tax added to U.S. price. See our response to Comment 1 in *Color Television Receivers from the Republic of Korea*; Final Results of Antidumping Duty Administrative Review (56 FR 12702, March 27, 1991) and our response to Comment 4 in *Color Television Receivers, Except for Video Monitors, from Taiwan*; Final Results of Antidumping Duty Administrative Review (56 FR 31380, July 10, 1991).

We disagree with Zenith that the amount of both commodity and consumption tax forgiven upon exportation should be calculated on the basis of the export price. The tax base

used for determining the amount of tax which the Japanese taxing authorities would have imposed on exports of the merchandise to the United States is the price which in analogous to the home market tax base. The tax base used to calculate the commodity tax was the constructed ex-factory price, the tax base comparable to that used in the home market. With regard to the consumption tax, which went into effect on April 1, 1989, the Department has determined that the price to the first unrelated party in the United States is comparable to the price on which the merchandise is taxed in the home market, the sales price.

Comment 4

Zenith argues that the Department failed to account for savings realized by Casio and Citizen as a result of delayed payment of home market discounts, rebates, and selling expenses accounts payable. According to Zenith, if Casio and Citizen do not disburse funds immediately after incurring an obligation to pay a particular expense, they earn interest income on those funds until the expense is actually paid. As a result, Zenith argues, the true measure of Casio's and Citizen's selling expenses is not the amount paid, but the amount of the payment less the savings realized by delayed payment. Accordingly, Zenith argues that the Department should reduce Casio's and Citizen's home market selling expenses by the amount of any interest earnable as a result of delayed payment of those expenses.

Casio and Citizen respond that the Department has repeatedly considered, and rejected, this argument. Casio further asserts that it is the Department's practice to make all adjustments to price on the basis of verifiable, actual costs where such data have been presented, that any savings in interest expenses due to delayed payment are taken into account in setting the payment terms for discounts and rebates, and that Zenith is not prejudiced by this practice since the method is used for both home market and U.S. sales. Casio also claims that even if Zenith were correct, the Department and respondent would spend enormous energy in determining trivial issues related to these secondary transactions.

Department's Position

We disagree with Zenith. We avoid imputing expenses or costs when a company quantifies or documents its actual expenses, and when the company's quantification accurately reflects the expense to the seller. Since

we have determined that Casio and Citizen accurately quantified their home market selling expenses, and that their claims accurately reflected these expenses, we have not reduced them by the amount of any savings realized as a result of delayed payment. See our response to Comment 2 in Television Receivers, Monochrome and Color, From Japan; Final Results of Antidumping Duty Administrative Reviews (54 FR 13918, April 6, 1989).

Comment 5

Zenith argues that the Department should deduct antidumping-related legal expenses from exporter's sales price (ESP). According to Zenith, these expenses are selling expenses because they are incurred as a result of a respondent selling the merchandise under review in the United States at prices below FMV. Moreover, Zenith argues that there is no basis for retaining in ESP legal expenses incurred as a result of an antidumping proceeding when all other legal expenses incurred by a foreign company's U.S. subsidiary are deducted from ESP.

Casio and Citizen respond that the Department has repeatedly determined that antidumping-related legal expenses are not expenses incurred in selling the merchandise in the United States. They also assert that deducting these legal fees as expenses would discriminate against those exporters who seek legal counsel in an antidumping proceeding.

Department Position

We disagree with Zenith. As we have stated in previous reviews of this finding, and of the antidumping duty orders on color television receivers from the Republic of Korea and color television receivers from Taiwan, we do not consider legal expenses incurred in defending against an allegation of dumping to be expenses incurred in selling the merchandise in the United States. As a result, we have not deducted these expenses from ESP in these final results. Also, see our response to Comment 4 in Television Receivers, Monochrome and Color, From Japan; Final Results of Antidumping Duty Administrative Reviews (54 FR 13919, April 6, 1989). We note, moreover, that whereas Zenith criticized the Department in *Comment 3* for failing to follow the CIT opinion in *Zenith*, in this instance, it is urging the Department to disregard the CIT opinion regarding this issue in *Doewoo*.

Comment 6

Zenith argues that the Department should deduct from U.S. price payments of estimated antidumping duties, and

any expenses related to such payments. According to Zenith, these items should be deducted from U.S. price along with the estimated ordinary duties paid, because the statute specifically requires that "United States import duties" be deducted from U.S. price.

Casio and Citizen both note that the Department has repeatedly rejected Zenith's argument. Casio also replies that the Department's policy of not deducting deposits of estimated antidumping duties from U.S. price was upheld in the CIT ruling in *P.Q. Corporation v. United States*, 652 F. Supp. 724, 737 (1987).

Department's Position

We disagree with Zenith. As we have stated in previous reviews of this finding, we believe that using estimated amounts of antidumping duties in our calculations would result in inaccurate margins. We do not consider payments of estimated antidumping duties to be expenses related to the sales of the merchandise under consideration for this review period. Further, given the possibility that these estimated duties could vary significantly from duties that may be assessed, we do not consider them to be "expenses" within the meaning of section 772(d)(2)(A) of the Tariff Act for purposes of determining U.S. price. Finally, estimated duties and duties assessed are paid by the importer, which is in some cases unrelated to the party whose sales are under review. As a result, we have not deducted them from U.S. price in these final results. See our response to Comment 5 in Television Receivers, Monochrome and Color, From Japan; Final Results of Antidumping Duty Administrative Reviews (54 FR 13919, April 6, 1989), our response to comment 6 in Color Television Receivers from the Republic of Korea; Final Results of Antidumping Administrative Review (56 FR 12703, 12704, March 27, 1991), and our response to Comment 8 in Color Television Receivers, Except for Video Monitors, from Taiwan; Final Results of Antidumping Administrative Review (56 FR 31380, July 10, 1991).

Comment 7

Zenith contends that the Department erroneously treated selling commissions in the United States as though they consisted entirely of indirect selling expenses. According to Zenith, commissions compensate the recipient for both direct and indirect selling expenses incurred on behalf of the respondent. Zenith argues that, since FMV has already been adjusted for direct selling expenses, an offset to FMV

comprised of indirect selling expenses up to the full amount of the U.S. commission overcompensates for the indirect portion of the commission and effectively negates the deduction from U.S. price of the direct expense portion of the commission.

Casio responds that Zenith's suggestion is contrary to the Department's regulations at 19 CFR 353.56(b), which provides for a commission offset of indirect selling expenses for the full amount of the commission paid. Citizen points out that this argument has been rejected by the Department previously when a commission is paid in one market but not in the other.

Department's Position

We disagree with Zenith. Section 353.56(b)(1) of our regulations requires us to make an adjustment for situations in which a commission is paid in one market but not in the other market. That adjustment is limited to "the amount of the other selling expenses" allowed in the other market. We do not interpret this regulation as requiring us to limit the offset to a specific portion of the expenses of the commissionaire. Indeed, it is not necessary to examine how the recipient of the commissions spends the money because, to the seller, such monies represent direct expenses incurred as a result of that particular sale. As a result, we have offset the full amount of the U.S. commissions in these final results. See our response to Comment 6 in Television Receivers, Monochrome and Color, From Japan; Final Results of Antidumping Duty Administrative Reviews (54 FR 13919, April 6, 1989), our response to Comment 9 in Color Television Receivers, Except for Video Monitors, from Taiwan; Final Results of Antidumping Duty Administrative Review (56 FR 31381, July 10, 1991), and our response to comment 7 in Color Television Receivers from the Republic of Korea; Final Results of Antidumping Duty Administrative Review (56 FR 12704, March 27, 1991).

Comment 8

Zenith asserts that the Department may have improperly used home market indirect expenses that are not selling expenses as an offset to U.S. indirect selling expenses. Zenith states that the Department should require an affirmative demonstration from Casio and Citizen that all home market indirect expenses they have claimed as ESP offset are actually selling expenses, and not general and administrative expenses.

Citizen responds that it followed the Department's practice in preparing its indirect selling expense data. Casio claims that it provided sufficient evidence to demonstrate that the reported home market selling expenses are selling expenses and do not include non-selling expenses.

Department's Position

We disagree with Zenith. As we have stated in previous reviews of this case, the pool of indirect selling expenses in the home market should include those expenses which are similar to the expenses incurred by the U.S. subsidiary, whose function it is to sell merchandise. We do not interpret our regulations as requiring that indirect selling expenses in the home market be limited to selling expenses in sales offices, and as excluding general and administrative expenses incurred by those offices. Accordingly, the equivalent home market expenses are those which are incurred by the home market selling division in support of the home market sales effort and which include certain general expenses associated with selling. Therefore, we believe that Casio and Citizen did not overstate their home market selling expenses, and we have used all these expenses in calculating the ESP offset for these final results. See our response to Comment 3 in Television Receivers, Monochrome and Color, From Japan; Final Results of Antidumping Duty Administrative Reviews (54 FR 13919, April 6, 1989) and our response to Comment 4 in Color Television Receivers from the Republic of Korea; Final Results of Antidumping Duty Administrative Review (56 FR 12703, March 27, 1991).

Comment 9

Zenith contends that it is unclear whether constructed value (CV) does or does not include discounts, rebates, or commodity and consumption taxes. According to Zenith, these items must be included among the "general expenses" component of CV because the statute requires that these general expenses encompass what is usually reflected in sales. Because Casio and Citizen acknowledge that discounts, rebates, and commodity and consumption taxes are included in the selling price of the merchandise, and because the Department routinely adjusts for these items under its authority to adjust for differences in circumstances of sales, Zenith argues that they are "general expenses" as defined in the statute, and should, therefore, be included in CV.

Citizen replies that the Department correctly excluded these items from its calculation of CV, because it is the Department's practice to calculate CV on the basis of the books and records of the foreign producer, and Citizen does not treat discounts, rebates, or taxes as expenses in its books or records.

Department's Position

We disagree with Zenith that these expenses should be included in CV. As we have stated in previous reviews, we do not consider discounts and rebates to be selling expenses; we consider them to be adjustments to price. Pursuant to the statute, the Department constructs an ex-factory value which consists of the sum of cost of manufacture (COM), general expenses (i.e., selling, general, and administrative expenses), profit on home market sales, and the cost of packing the merchandise for shipment to the United States. In order to make an apples-to-apples comparison of this surrogate FMV to U.S. price, all taxes, rebates, and discounts are removed from U.S. price, and no tax is added thereto. As a result, we have not included discounts, rebates, and commodity or consumption taxes in our calculations of CV for these final results. See our response to Comment 20 in Television Receivers, Monochrome and Color, From Japan; Final Results of Antidumping Duty Administrative Reviews (56 FR 5396, February 11, 1991), and our response to Comment 9 in Color Television Receivers from the Republic of Korea; Final Results of Antidumping Duty Administrative Review (56 FR 12704, 12705, March 27, 1991).

We do note, however, that in our preliminarily results, commodity and consumption taxes were included in our calculations of FMV when FMV was based on CV. This has been corrected for the purposes of these final results.

Comment 10

Casio claims that its packing labor and materials expenses for home market shipments are included in COM. Thus, Casio argues that the Department should deduct these packing expenses from the COP in determining whether the home market sales are sold at prices which are below the COP.

Zenith objects to the submission of this information on the part of Casio. Zenith responds that the time for the submission of such information is past, and therefore, the Department should not accept this data.

Department's Position

We disagree with Casio. As Casio admits in its brief, the Department did

not deduct these expenses from COP because we were not aware that these packing expenses were included in COM. Since this information was submitted to the Department after the preliminary results were published, it has not been considered for these final results. Accordingly, the Department has not deducted packing expenses from COP for the purposes of determining which sales were sold below cost.

Comment 11

Citizen argues that, for CTV COP, the Department should base Citizen's net financial expenses on the calculation originally submitted by the company in its questionnaire response. According to Citizen, this calculation, which was based solely on Citizen's non-consolidated interest income and expense, provides the most accurate measure of the company's actual CTV financing costs during the period of review.

Citizen further argues that, if the Department decides not to use Citizen's submitted financing expense calculation, then it should determine the company's net financing costs using the net interest expense incurred by only those entities that were related to Citizen are involved in CTV production during the period of review. Citizen maintains that the Department should not base the company's borrowing costs on the net interest expense incurred by Citizen's consolidated group of companies.

Finally, Citizen contends that, in revising Citizen's financing costs for the preliminary results in review, the Department erred in applying its own methodology to certain of the company's financial figures. Specifically, Citizen claims that to correctly calculate short-term interest income to offset total interest expense, the Department should have considered not only interest accruing from short-term marketable securities, but also that from cash and cash deposits. Citizen also claims that the Department's financing expense calculation should have included dividends from marketable securities as an offset to interest expense.

Department Position

We disagree with Citizen. In rejecting Citizen's claim that the Department should accept the company's non-consolidated financing expense calculation, we followed our well-established practice of deriving net financing costs based on the borrowing experience of the consolidated group of companies. See Antifriction Bearings and Parts Thereof from the Federal Republic of Germany (54 FR 18992, May

3, 1989), Certain Small Business Telephone Systems and Subassemblies from Korea (54 FR 31980, August 3, 1989), Sweaters Wholly or in Chief Weight of Man-Made Fiber from Hong Kong (55 FR 30743, July 27, 1990), and Titanium Sponge from Japan (55 FR 42227, October 18, 1990). The Department has followed this practice even in those cases involving consolidated groups whose member companies manufacture a variety of diverse products. Our practice is based on the fact that the group's parent company, because of its controlling interest, has the power to decide the capital structure of each member company within the group is generally best reflected at the group's consolidated level.

We based our revised net financing expense calculation on information obtained from Citizen's consolidated financial statements. Following our usual practice, we reduced the consolidated group's interest expense by the amount of interest income earned from the group's short-term investments of working capital. Because Citizen did not provide an analysis of its consolidated short and long-term interest income, as the best information available, we estimated short-term interest income by multiplying the consolidated group's total interest income by the ratio of the group's short-term invested assets to the balance of its total invested assets.

Although Citizen maintains that the Department should have considered the company's cash and deposits to be short-term invested assets, the information available from the record did not indicate what portion, if any, of the company's cash balance was invested in interest bearing deposit accounts. Consequently, we conservatively excluded these balances from our calculation.

Regarding Citizen's claim that the Department should have considered the company's dividend income in calculating net financial expense, the Department generally does not allow dividends earned as an offset to total interest expense unless there is evidence that dividend income was earned from short-term investments of the company's working capital. See Small Business Telephone Systems from Korea (54 FR 53141, December 27, 1989) and Television Receivers, Monochrome and Color, from Japan (54 FR 13917, April 6, 1989). In this case, there is no evidence to this effect. Consequently, we did not consider this income in our recalculation of Citizen's financing expense.

Comment 12

Citizen argues that the Department should correct its adjustment for differences in merchandise to reflect the correct variable COM for its home market models. The correct variable COM of its home market models should be based on a fixed/variable overhead split identical to that of the U.S. models, which were manufactured at the same production facility as their home market models. Citizen argues that the Department should use the variable overhead information in its April 15, 1991 submission, which was submitted in accordance with the Department's instructions.

Zenith objects to the submission of this new information on the part of Citizen. Zenith argues that the time for such submissions is past, and that the Department should reject this data.

Department's Position

We agree with Citizen. The Department agreed to allow Citizen to submit the variable overhead information for the record of this review (see memorandum from Karin Price to the file dated April 12, 1991), and it was received by the date established by the Department, before the preliminary results were published. This data has been used in the calculations of the variable COM of home market models, and the corrected difference in merchandise adjustments were made for the purposes of these final results of review.

Comment 13

Citizen argues that the Department should include in its analysis all merchandise sold within the period of review, not only merchandise shipped during the period of review. Citizen points out that the questionnaire requires respondents to report all purchase price (PP) and ESP sales made during the period of review. Therefore, according to Citizen, the Department must include all sales made during the period of review in its analysis in order to calculate and assess duties on all shipments.

Zenith replies that the Department has the discretion to establish reasonable cutoffs where all units sold during the period of review are not shipped during the same period of review. Zenith contends that those units not shipped during the period of review will be covered by the following review.

Department's Position

We disagree with Citizen. Section 353.22(b) of the Commerce regulations allows the Department discretion to

cover in its review "entries, exports, or sales of merchandise during the 12 months immediately preceding the most recent anniversary month." We have determined that PP sales shipped outside the period of this review will not be analyzed. Instead, in its review of the subsequent period (March 1, 1990 through February 28, 1991), the Department will review any sales which are not covered during this review because they were not shipped during the current review period.

Comment 14

Citizen argues that the Department should exclude from its analysis those U.S. sales of returned, second quality merchandise. Citizen argues that the expenses associated with the original sales have already been reported as part of its warranty expense, and that analyzing these sales would serve to double-count the expenses attributable to these transactions. Moreover, Citizen contends that the Department has already determined in previous cases that it is not reasonable to include in its analysis lower quality products sold at reduced prices. As evidence of this, Citizen cites Generic Cephalixin Capsules from Canada; Final Determination of Sales at Less than Fair Value (54 FR 26823, June 28, 1989). Therefore, Citizen claims that the Department should treat the cost of these sales as a warranty expense in accordance with Citizen's questionnaire response. If the Department decides that these sales should be analyzed, Citizen argues that a weighted-average rate for all other sales should be applied to these models.

Zenith responds that, in reviewing an existing antidumping duty order, the Department analyzes all U.S. sales unless the review has been deemed appropriate for sampling. Zenith points out that Citizen is relying on a final determination of sales at less than fair value (LTFV) for validation of its suggestion that these sales should be excluded from the analysis. Zenith contends that, in making LTFV determinations, the Department has historically not analyzed all sales.

Zenith also argues that the Department should reject Citizen's suggestion that reviewing these sales would constitute a double-counting of expenses attributable to these transactions, because the expenses originally incurred to sell the merchandise cannot be equated with the reduced price received in the second sale. Zenith also claims that Citizen's suggestion that the expense of the original sale is included in the warranty expense indicates that the Department

has been led by Citizen incorrectly to apportion those expenses over sales of all merchandise, when they should have been attributed only to merchandise identified by Citizen as having been sold in second-quality transactions.

Department's Position

We agree with Citizen that these sales should be excluded from the analysis. The original sales of merchandise which is returned, refurbished, and resold are included on the U.S. sales database. Accordingly, the Department will not review two different sales of the same merchandise. Contrary to what Citizen's comment implies, there were no warranty expenses reported for the original sales. For the purposes of these final results, the expenses associated with the second sales of the merchandise have been allocated to the other sales of the applicable models and deducted from U.S. price.

Comment 15

Citizen claims that the Department should correct certain clerical errors in its computer programs for the final results. Citizen contends that in both the PP and ESP programs, the Department unnecessarily merged the COP data twice, unnecessarily merged the below cost home market data twice, unnecessarily input the values for the differences in merchandise twice, and applied the consumption tax adjustment on the basis of the date of sale, rather than the date of shipment.

Department's Position

We agree in part. The Department's computer programs did merge the COP data and below cost home market data twice, and input the values for differences in merchandise twice. We have made the appropriate corrections for these final results. However, we note that none of these errors had an effect on the results of the program.

We disagree that the consumption tax, which went into effect on April 1, 1989, should be applied on the basis of the date of shipment. Citizen did not adequately explain the reasons it advocates using the date of shipment instead of the date of sale to determine to which sales the consumption tax, which went into effect on April 1, 1989, should apply. Moreover, the tax is calculated as a percentage of the selling price. Accordingly, the Department has used the date of sale for calculating the consumption tax for these final results.

Final Results of the Review

As a result of our review, we have determined the margins to be:

| Manufacturer/Exporter | Period of review | Margin (percent) |
|-----------------------------------|-------------------|------------------|
| Casio Computer Company, Ltd. | 03/01/89-02/28/90 | 0.497 |
| Citizen Watch Company, Ltd. | 03/01/89-02/28/90 | 17.07 |

The Department will instruct the Customs Service to assess antidumping duties on all appropriate entries. Individual differences between U.S. price and FMV may vary from the percentages stated above. The Department will issue appraisal instructions on each exporter directly to the Customs Service.

Further, as provided for by section 751(a)(1) of the Tariff Act, a cash deposit of estimated dumping duties based on the above margin will be required for Citizen. Since the margin for Casio is less than 0.5 percent and, therefore, *de minimis* for cash deposit purposes, the Department shall not require a cash deposit of antidumping duties on entries from Casio. For all other exporters/manufacturers not related to Casio or Citizen, or any previously reviewed firm, a cash deposit of 17.07 percent shall be required. These deposit requirements and waiver will be effective for all shipments of Japanese television receivers, monochrome and color, entered or withdrawn from warehouse, for consumption on or after the date of publication of the final results of this administrative review.

This administrative review and notice are in accordance with section 751(a)(1) of the Tariff Act (19 U.S.C. 1675(a)(1)) and 19 CFR 353.22 (1990).

Dated: July 18, 1991.

Eric I. Garfinkel,
Assistant Secretary for Import
Administration.

[FR Doc. 91-17811 Filed 7-25-91; 8:45 am]

BILLING CODE 3510-D9-M

[Application No. 86-A0008]

Export Trade Certificates of Review

AGENCY: International Trade Administration, Commerce.

ACTION: Notice of issuance of an Amended Export Trade Certification of Review.

SUMMARY: The Department of Commerce, has issued an amendment to the Export Trade Certificate of Review granted to Streamline Shippers Association, Inc. Notice of issuance of

the Certificate was published in the **Federal Register** on December 23, 1986 (51 FR 45928).

FOR FURTHER INFORMATION CONTACT: George Muller, Director, Office of Export Trading Company Affairs, International Trade Administration, (202) 377-5131. This is not a toll-free number.

SUPPLEMENTARY INFORMATION: Title III of the Export Trading Company Act of 1982 ("the Act") (15 U.S.C. 4001-21) authorizes the Secretary of Commerce to issue Export Trade Certificates of Review. The regulations implementing title III are found at 15 CFR part 325 (1990) (50 FR 1804, January 11, 1985).

The Office of Export Trading Company Affairs is issuing this notice pursuant to 15 CFR 325.6(b), which requires the Department of Commerce to publish a summary of a Certificate in the **Federal Register**. Under section 305(a) of the Act and 15 CFR 325.11(a), any person aggrieved by the Secretary's determination may, within 30 days of the date of this notice, bring an action in any appropriate district court of the United States to set aside the determination on the ground that the determination is erroneous.

Description of Amended Certificate

Export Trade Certificate of Review No. 88-00008 was issued to Streamline Shippers Association, Inc. (SSA) on December 17, 1986. Notice of issuance of the Certificate was published in the **Federal Register** on December 23, 1986 (51 FR 45928).

SSA has amended its Certificate to clarify the "forwarder services" it will offer and to revise its classes of members. These revisions require the following changes in its Certificate:

(1) Revision of part (c) of Export Trade to read as follows:

Transportation Services (As They Relate to the Export of Products) include: Overseas freight transportation; inland freight transportation to a U.S. export terminal, port, or gateway; packing and crating; leasing of transportation equipment and facilities; terminal or port storage; wharfage and handling; forwarder services (including, but not limited to, preparing and/or processing export declarations, preparing or processing delivery orders or dock receipts, preparing, processing, or issuing bills of lading, preparing or processing consular documents or arranging for their certification, preparing and/or sending advance notifications of shipments or other documents to banks, shippers or consignees, as required); insurance; warehousing; foreign exchange; financing and financial services; export

sale and trade documentation and services; overseas distribution; paying or charging commissions; marketing; advertising; communication and processing of foreign orders; accounting; clerical services; consulting; customs services; feasibility studies; investment services; legal services; management services; and translation services.

(2) Revision of part 7(c) of the Export Trade Activities and Methods of Operation as follows:

(c) SSA shall have four classes of SSA Members: (1) Regular members; (2) NVOCC members; (3) transportation members; and (4) shippers' association members, and may prescribe the eligibility requirements for each class of member;

(3) Addition of the following definitions to clarify certain terms in revised part 7(c):

Regular members include any firm, or affiliate thereof, engaged in a business other than transportation in the course of which such entity ships or receives cargo in interstate, intrastate, or foreign commerce.

NVOCC members include any non-vessel operating common carrier under the Shipping Act of 1984, and which shall maintain a tariff on file with the Federal Maritime Commission and post a surety bond as required by regulations of the Federal Maritime Commission.

Transportation members include any firm, or affiliate thereof, engaged primarily in the transportation business as an intermediary, direct carrier, or service organization.

Shippers' association members include any shippers' association, provided that for purposes of foreign commerce only, such shippers' association must maintain a list containing the names of its members and compliance data if any such member shall be a non-vessel operating common carrier as defined in the Shipping Act of 1984.

EFFECTIVE DATE: April 22, 1991.

A copy of the amended Certificate will be kept in the International Trade Administration's Freedom of Information Records Inspection Facility, room 4102, U.S. Department of Commerce, 14th and Constitution Avenue, NW., Washington, DC 20230.

Dated: July 22, 1991.

George Muller,
Director, Office of Export Trading Company Affairs.

[FR Doc. 91-17804 Filed 7-25-91; 8:45 am]

BILLING CODE 3510-DR-M

Applications for Duty-Free Entry of Scientific Instruments

Pursuant to section 6(c) of the Educational, Scientific and Cultural Materials Importation Act of 1966 (Pub. L. 89-651; 80 Stat. 897; 15 CFR Part 301), we invite comments on the question of whether instruments of equivalent scientific value, for the purposes for which the instruments shown below are intended to be used, are being manufactured in the United States.

Comments must comply with § 301.5(a)(3) and (4) of the regulations and be filed within 20 days with the Statutory Import Programs Staff, U.S. Department of Commerce, Washington, DC 20230. Applications may be examined between 8:30 a.m. and 5 p.m. in room 4204, U.S. Department of Commerce, 14th Street and Constitution Avenue, NW., Washington, DC.

Docket Number: 90-198R. *Applicant:* Research Foundation of SUNY at Albany, AD-335, 1400 Washington Avenue, Albany, NY 12222. *Instrument:* Infrared Neon Gas Laser. *Manufacturer:* MPB Technologies Inc., Canada notice of this resubmitted application was published in the **Federal Register** of December 11, 1990.

Docket Number: 90-231R. *Applicant:* Oregon State University, College of Oceanography, Oc Administrative Building 104, Corvallis, OR 97331-5503. *Instrument:* Noble Gas Mass Spectrometer, Model 215-50. *Manufacturer:* Mass Analyzer Products, Ltd., United Kingdom. Original notice of this resubmitted application was published in the **Federal Register** of February 1, 1991.

Docket Number: 91-092. *Applicant:* University of Illinois at Urbana-Champaign, Purchasing Division, 506 South Wright Street, Urbana, IL 61801. *Instrument:* Portable Differential Spectrometer/Scintillometer, Model GRS-500. *Manufacturer:* Scientrex, Canada. *Intended Use:* The instrument will be used to detect the total counts of low level gamma ray radiation of sandstones, limestones and shales. *Application Received by Commissioner of Customs:* June 19, 1991.

Docket Number: 91-096. *Applicant:* Hamilton College, College Hill Road, Clinton, NY 13323. *Instrument:* Electron Microscope, Model JEM 1200EXII/SEG/DP/DP. *Manufacturer:* JEOL Ltd., Japan. *Intended use:* The instrument will be used to study the ultrastructure of various tissues, microbes and viruses to ascertain basic information on insulin secretion from endocrine pancreas and gut and also to provide important insights into the evolution of vertebrate

gastro-entero-pancreatic system. In addition, the instrument will be used for teaching purposes in the courses Biol 349 (TEM), Biol 336 (Cell Biology) and Biol 550 (Senior Research). *Application Received by Commissioner of Customs:* June 20, 1991.

Docket Number: 91-097R. *Applicant:* Northeast Missouri State University, Science, Kirksville, MO 63501 *Instrument:* SF-41 Stopped Flow Sample Handling Unit with SU-40A Spectrophotometer Unit. *Manufacturer:* Hi-Tech Scientific, United Kingdom. *Intended Use:* A single organic radical reagent, tri(tert-butylphenyl)methyl radical, will be used to abstract hydrogen atoms from a benzylic site on a series of aromatic hydrocarbons. Specific organic compounds to be examined will first include those whose C-H bond dissociation energies are known and then include related compounds with various added substituents. The instrument will be used in the courses Chemistry 441 (Chemistry Research I), Chemistry 442 (Chemistry Research II) and Chemistry 443 (Chemistry Research III) which involve individual study and laboratory research. *Application Received by Commissioner of Customs:* June 21, 1991

Docket Number: 91-098. *Applicant:* Princeton University, Molecular Biology Department, Lewis Thomas Labs, Washington Road, Princeton, NJ 08544 *Instrument:* 60 SM1 Stereomicroscopes with Filter Sets. *Manufacturer:* Oriental Scientific Instruments, China *Intended Use:* The instrument will be used for the study of living organisms, including drosophila and nematode embryos. The experiments involve living embryos which are very fragile, to give students a clearer understanding of development in animals, the role of certain products of gene expression at certain key periods in an organism's life, and the effects of mutation on these normal processes. In addition, the instrument will be used for educational purposes in Molecular Biology courses. *Application Received by Commissioner of Customs:* June 26, 1991.

Docket Number: 91-099. *Applicant:* Wayne State University, School of Medicine, Gordon Scott Hall, 540 E. Canfield Avenue, Detroit, MI 48201. *Instrument:* Organ Baths and Field Stimulating Electrodes. *Manufacturer:* Hugo Sachs Elektronik, West Germany *Intended Use:* The instrument will be used to study the effects of Ethanol and its metabolites on muscle mechanics to determine the mechanism of action of these compounds in alcohol-induced cardiac dysfunction. In addition, the instrument will be used in a course of

basic graduate physiology to instruct graduate and nursing students in the mechanisms of cardiovascular function. *Application Received by Commissioner of Customs:* June 28, 1991.

Docket Number: 91-101. *Applicant:* USDA, ARS, W-321 Turner Hall, 1102 S. Goodwin, Urbana, IL 61801. *Instrument:* Chlorophyll Fluorometer, Model PAM 101. *Manufacturer:* Heinz Walz, Germany. *Intended Use:* The instrument will be used for studies of photosynthetic membranes isolated from plants to determine the factors that control rate and efficiency of light-driven electron transfer reactions in photosynthesis. *Application Received by Commissioner of Customs:* July 2, 1991.

Frank W. Creel,
Director, Statutory Import Programs Staff.
[FR Doc. 91-17813 Filed 7-25-91; 8:45 am]
BILLING CODE 3510-DS-M

Consolidated Decision on Applications for Duty-Free Entry of Scientific Instruments; University of California, San Diego, et al.

This is a decision consolidated pursuant to section 6(c) of the Educational, Scientific, and Cultural Materials Importation Act of 1966 (Public Law 89-651, 80 Stat. 897; 15 CFR 301). Related records can be viewed between 8:30 a.m. and 5 p.m. in room 4204, U.S. Department of Commerce, 14th and Constitution Avenue, NW., Washington, D.C.

Comments: None received. *Decision:* Approved. No instrument of equivalent scientific value to the foreign instruments described below, for such purposes as each is intended to be used, is being manufactured in the United States.

Docket Number: 91-001. *Applicant:* University of California, San Diego, La Jolla, CA 92093. *Instrument:* Rotating Anode X-Ray Generator, Model RU-200H. *Manufacturer:* Rigaku Corporation, Japan. *Intended Use:* See notice at 56 FR 4971, February 7, 1991. *Reasons:* The foreign instrument provides a small focal spot of 0.5 x 5.0 mm and a beam power of 12 kW. *Advice Submitted by:* National Institutes of Health, May 30, 1991.

Docket Number: 91-003. *Applicant:* Indiana University-Purdue University at Indianapolis, Indianapolis, IN 46202. *Instrument:* Stopped-Flow Spectrofluorimeter, Model SF-51 with SHU-51 Sample Handling Unit. *Manufacturer:* Hi-Tech, United Kingdom. *Intended use:* See notice at 56 FR 4972, February 7, 1991. *Reasons:* The foreign instrument provides a dead time

less than 1.0 ms. *Advice Submitted by:* National Institutes of Health, May 30, 1991.

Docket Number: 91-004. *Applicant:* Xavier University of Louisiana, New Orleans, LA 70125. *Instrument:* Organ Bath and Accessories. *Manufacturer:* Hugo Sachs Elektronik, West Germany. *Intended Use:* See notice at 56 FR 4972, February 7, 1991. *Reason:* The foreign instrument provides muscle support, bath circulation, temperature control and 4-organ capacity for studies of muscle contractility. *Advice Submitted by:* National Institutes of Health, May 30, 1991.

Docket Number: 91-006. *Applicant:* National Institute of Standards and Technology, Gaithersburg, MD 20899. *Instrument:* Excimer Multigas Laser, Model LPX 205i. *Manufacturer:* Lambda Physik, GmbH, West Germany. *Intended Use:* See notice at 56 FR 4972, February 7, 1991. *Reasons:* The foreign instrument provides an energy output of 400 mJ at 50 Hz and 308 nm (XeCl) and a gas lifetime of 10 million shots without halogen injection. *Advice Submitted by:* National Institutes of Health, May 30, 1991.

Docket Number: 91-007. *Applicant:* Rutgers, The State University of New Jersey, Piscataway, NJ 08855-0909. *Instrument:* Iris IR Eye-Tracker System, Model 6500. *Manufacturer:* Skalar Medical, The Netherlands. *Intended Use:* See notice at 56 FR 4972, February 7, 1991. *Reasons:* The foreign instrument provides infrared detection of eye movements with a resolution of 2.0 minutes of arc and with a bandwidth from DC to 200 Hz. *Advice Submitted by:* National Institutes of Health, May 30 1991.

Docket Number: 91-009. *Applicant:* National Institute of Standards and Technology, Gaithersburg, MD 20899. *Instrument:* Neutron Area Detector for Small Angle Neutron Scattering. *Manufacturer:* CERCA, France. *Intended Use:* See notice at 56 FR 8184, February 27, 1991. *Reasons:* The foreign instrument provides a spatial resolution (pixel size) of 10 x 10 mm² and a counting rate of 10/second per pixel. *Advice Submitted by:* National Institutes of Health, May 30, 1991.

The National Institutes of Health advises that (1) the capabilities of each of the foreign instruments described above are pertinent to each applicant's intended purpose and (2) it knows of no domestic instrument or apparatus of equivalent scientific value for the intended use of each instrument.

We know of no other instrument or apparatus being manufactured in the United States which is of equivalent

scientific value to any of the foreign instruments.
 Frank W. Creel,
 Director, Statutory Import Programs Staff.

[FR Doc. 91-17814 Filed 7-25-91; 8:45 am]
 BILLING CODE 3510-DS-M

Consolidated Decision on Applications for Duty-Free Entry of Scientific Instruments; University of California, et al

This is a decision consolidated pursuant to section 6(c) of the Educational, Scientific, and Cultural Materials Importation Act of 1966 (Pub. L. 89-651, 80 Stat. 897; 15 CFR part 301). Related records can be viewed between 8:30 a.m. and 5 p.m. in room 4204, U.S. Department of Commerce, 14th and Constitution Avenue NW., Washington, DC.

Comments: None received. *Decision:* Approved. No instrument of equivalent scientific value to the foreign instruments described below, for such purposes as each is intended to be used, is being manufactured in the United States.

Docket Number: 91-010. *Applicant:* University of California Berkeley, CA 94720. *Instrument:* Stopped-flow Spectrofluorimeter, Model SF.17. *Manufacturer:* Applied Photophysics Ltd., United Kingdom. *Intended Use:* See notice at 56 FR 8184, February 27, 1991. *Reasons:* The foreign instrument provides sub-millisecond dead time and requires a sample of only 25 ml per reactant per shot. *Advice Submitted by:* National Institutes of Health, May 30, 1991.

Docket Number: 91-017. *Applicant:* Mt. Sinai School of Medicine of the City University of New York, New York, NY 10029. *Instrument:* Fluorescence Lifetime Spectrometer, Model 5000. *Manufacturer:* IBH Consultants Ltd., United Kingdom. *Intended Use:* See notice at 56 FR 8185, February 27, 1991. *Reasons:* The foreign instrument provides time-resolved single photon counting capability with a resolution of 1.0 ns. *Advice Submitted by:* National Institutes of Health, May 30, 1991.

Docket Number: 90-019. *Applicant:* Vanderbilt University School of Medicine, Nashville, TN 37232-0615. *Instrument:* Volume Controller for Microinjections. *Manufacturer:* Singer, United Kingdom. *Intended Use:* See notice at 56 FR 11545, March 19, 1991. *Reasons:* The foreign instrument provides 3-dimensional movement using a single control handle shaped and used like a pencil for injections of

thousandths of a microliter. *Advice Submitted by:* National Institutes of Health, May 30, 1991.

Docket Number: 91-023. *Applicant:* Duke University Medical Center, Durham, NC 27710. *Instrument:* Flashlamp System JML-E for Photolysis Experiments. *Manufacturer:* Optische und elektronische Gerate Dr. Rapp, West Germany. *Intended Use:* See notice at 56 FR 11546, March 19, 1991. *Reasons:* The foreign instrument provides focusing optics and pulse shaping optimized for initiating contractile events in muscle fibers. *Advice submitted by:* National Institutes of Health, May 30, 1991.

The National Institutes of Health advises that (1) the capabilities of each of the foreign instruments described above are pertinent to each applicant's intended purpose and (2) it knows of no domestic instrument or apparatus of equivalent scientific value for the intended use of each instrument.

We know of no other instrument or apparatus being manufactured in the United States which is of equivalent scientific value to any of the foreign instruments.

Frank W. Creel,
 Director, Statutory Import Programs Staff.

[FR Doc. 91-17815 Filed 7-25-91; 8:45 am]
 BILLING CODE 3510-DS-M

Disposition of Application for Duty-Free Entry of Scientific Instrument; Yale University

Processing of Docket Number 89-102 (See notice at 54 FR 13727) has been discontinued. The U.S. Customs Service has ruled that the instrument is general purpose data processing equipment and is therefore ineligible for duty-free entry under section 9810.00.60 of the Harmonized Tariff Schedule of the United States.

Frank W. Creel,
 Director, Statutory Import Programs Staff.
 [FR Doc. 91-17816 Filed 7-25-91; 8:45 am]
 BILLING CODE 3510-DS-M

COMMITTEE FOR PURCHASE FROM THE BLIND AND OTHER SEVERELY HANDICAPPED

Procurement List Additions

AGENCY: Committee for Purchase from the Blind and Other Severely Handicapped.

ACTION: Additions to procurement list.

SUMMARY: This action adds to the

Procurement List commodities and services to be furnished by nonprofit agencies employing the blind or other severely handicapped.

EFFECTIVE DATE: August 26, 1991.

ADDRESSES: Committee for Purchase from the Blind and Other Severely Handicapped, Crystal Square 5, suite 1107, 1755 Jefferson Davis Highway, Arlington, Virginia 22202-3509.

FOR FURTHER INFORMATION CONTACT: Beverly Milkman (703) 557-1145.

SUPPLEMENTARY INFORMATION: On May 10, 24 and June 7, 1991, the Committee for Purchase from the Blind and Other Severely Handicapped published notices (56 FR 21664, 23876 and 26395) of proposed additions to the Procurement List.

After consideration of the material presented to it concerning capability of qualified nonprofit agencies to produce the commodities and provide the services at a fair market price and impact of the addition on the current or most recent contractors, the Committee has determined that the commodities and services listed below are suitable for procurement by the Federal Government under 41 U.S.C. 46-48c and 41 CFR 51-2.6.

I certify that the following actions will not have a significant impact on a substantial number of small entities. The major factors considered for this certification were:

- The actions will not result in any additional reporting, recordkeeping or other compliance requirements.
- The actions will not have a serious economic impact on any contractors for the commodities and services listed.
- The actions will result in authorizing small entities to produce the commodities and provide the services procured by the Government.

Accordingly, the following commodities and services are hereby added to the Procurement List:

Commodities

Strap, Webbing, 5340-00-784-0118,
 (Remaining Government Requirement).
 Perforator, Paper 7520-00-139-3942, 7520-00-163-2563.

Services

Commissary Shelf Stocking, Custodial and Warehousing, Travis Air Force Base, California.
 Commissary Shelf Stocking, Custodial and Warehousing, Patrick Air Force Base, Florida.
 Janitorial/Custodial, Post Exchange, Building 50004, Fort Hood, Texas.

This action does not affect contracts awarded prior to the effective date of this addition or options exercised under those contracts.

Beverly L. Milkman,
Executive Director.

[FR Doc. 91-17764 Filed 7-25-91; 8:45 am]

BILLING CODE 6820-33-M

Procurement List; Proposed Additions

AGENCY: Committee for Purchase from the Blind and Other Severely Handicapped.

ACTION: Proposed additions to procurement list.

SUMMARY: The Committee has received proposals to add to the Procurement List a commodity and a service to be furnished by nonprofit agencies employing the blind or other severely handicapped.

COMMENTS MUST BE RECEIVED ON OR BEFORE: August 26, 1991.

ADDRESSES: Committee for Purchase from the Blind and Other Severely Handicapped, Crystal Square 5, suite 1107, 1755 Jefferson Davis Highway, Arlington, Virginia 22202-3509.

FOR FURTHER INFORMATION CONTACT: Beverly Milkman (703) 557-1145.

SUPPLEMENTARY INFORMATION: This notice is published pursuant to 41 U.S.C. 47(a)(2) and 41 CFR 51-2.6. Its purpose is to provide interested persons an opportunity to submit comments on the possible impact of the proposed actions.

If the Committee approves the proposed additions, all entities of the Federal Government (except as otherwise indicated) will be required to procure the commodity and service listed below from nonprofit agencies employing the blind or other severely handicapped.

It is proposed to add the following commodity and service to the Procurement List:

Commodity

Pallet, Material Handling, 3990-00-NSH-0067
40" x 48", (Requirements of the Naval Supply Center, Jacksonville, FL).

Service

Janitorial/Custodial, Lock and Dam 19,
Keokuk, Iowa.

Beverly L. Milkman,
Executive Director.

[FR Doc. 91-17765 Filed 7-25-91; 8:45 am]

BILLING CODE 6820-33-M

DEPARTMENT OF DEFENSE

Public Information Collection Requirement Submitted to OMB for Review

ACTION: Notice.

The Department of Defense has submitted to OMB for clearance the following proposal for collection of information under the provisions of the Paperwork Reduction Act (44 U.S.C. chapter 35).

Title, Applicable Form, and Applicable OMB Control Number: Medical Information Questionnaire, DIS FL-14a OMB Control No. 0704-0206.

Type of Request: Reinstatement.
Average Burden Hours/Minutes Per Response: 0.6 hours.

Responses Per Respondent: 1.
Number of Respondents: 15,206.
Annual Burden Hours: 9,123.6.
Annual Responses: 15,206.

Needs and Uses: The DIS FL 14-a is used to obtain medical information during the conduct of personnel security investigations.

Affected Public: Individuals or households.

Frequency: On occasion.
Respondent's Obligation: Voluntary.
OMB Desk Officer: Mr. Edward C.

Springer. Written comments and recommendations on the proposed information collection should be sent to Mr. Springer at the Office of Management and Budget, Desk Officer for DoD, room 3235, New Executive Office Building, Washington, DC 20503.

DOD Clearance Officer: Mr. William P. Pearce. Written requests for copies of the information collection proposal should be sent to Mr. Pearce, WHS/DIOR, 1215 Jefferson Davis Highway, suite 1204, Arlington, Virginia 22202-4302.

Dated: July 23, 1991.

L.M. Bynum,

Alternate OSD Federal Register Liaison Officer, Department of Defense.

[FR Doc. 91-17778 Filed 7-25-91; 8:45 am]

BILLING CODE 3810-01-M

DEPARTMENT OF EDUCATION

National Assessment Governing Board; Meeting

AGENCY: National Assessment Governing Board.

ACTION: Notice of partially closed meeting.

SUMMARY: This notice sets forth the schedule and proposed agenda of forthcoming meetings of the National Assessment Governing Board and its

committees. This notice also describes the functions of the Board. Notice of this meeting is required under section 10(a)(2) of the Federal Advisory Committee Act. This document is intended to notify the general public of their opportunity to attend the open portions of the meeting.

DATES: August 1, 2, and 3, 1991.

TIMES: August 1, 1991—Achievement Levels Committee—3 p.m. to 4:30 p.m. (closed); Reporting and Dissemination Committee and Subject Area Committee #2 (Math and Science)—4:30 p.m. to 6:30 p.m. (open); Executive Committee—7 p.m.—10 p.m. (open). August 2, 1991—National Assessment Governing Board—8:30 a.m. to 12 p.m. (open); 12 p.m. to 2 p.m. (closed); 2 p.m. to 5:30 p.m. (open). August 3, 1991—Full Board—8:30 a.m. until adjournment, approximately, 1:30 p.m. (open).

LOCATION: Ritz-Carlton Hotel, 2100 Massachusetts Avenue, NW., Washington, DC 20008.

FOR FURTHER INFORMATION CONTACT: Roy Truby, Executive Director, National Assessment Governing Board, U.S. Department of Education, 1100 L Street, NW., suite 7322, Washington, DC, 20005-4013.

TELEPHONE: (202) 357-6938.

SUPPLEMENTARY INFORMATION: The National Assessment Governing Board (NAGB) is established under section 406(i) of the General Education Provisions Act (GEPA) as amended by section 3403 of the National Assessment of Educational Progress Act (NAEP Improvement Act), title III-C of the Augustus F. Hawkins—Robert T. Stafford Elementary and Secondary School Improvement Amendments of 1988 (Pub. L. 100-297); (20 U.S.C. 1221e-1).

The Board is established to advise the Commissioner of the National Center for Education Statistics on policies and actions needed to improve the form and use of the National Assessment of Educational Progress, and develop specifications for the design, methodology, analysis and reporting of test results. The Board also is responsible for selecting subject areas to be assessed, identifying the objectives for each age and grade tested, and establishing standards and procedures for interstate and national comparison. On August 1, three committees of the Board will be in session. The Achievement Levels Committee will meet in closed session from 3 p.m. until 4:30 p.m. to review and discuss the draft report of the achievement levels for the 1990 Mathematics Assessment. The draft report is still undergoing technical

review and analysis and there is a significant possibility that the data may be incorrect or incomplete. The premature disclosure of this information would likely frustrate implementation of proposed agency action. Such matters are protected by 5 U.S.C. 552b(c)(9)(B). Two committees, the Reporting and Dissemination and the Subject Area No. 2 (Math and Science) will meet in open session between 4:30 p.m. and 6:30 p.m.

The Reporting and Dissemination Committee will review and revise the NAGB policy on reporting and disseminating assessment results. The Subject Area Committee #2 (Math and Science) will review and prepare a recommendation for approving the format for the 1994 Science Assessment. Between 7 p.m. and 10 p.m. the Executive Committee will convene to hear progress reports on achievement levels; contract procurement for assessment of U.S. History, and Geography, and achievement levels setting for reading, writing, and math; plans for the science consensus.

The meeting of the full Board will begin on Friday, August 2, at 8:30 a.m. At 8:45 a.m., there will be a report from the Executive Director. During the period 9 a.m. to noon; the Humanities Committee will meet to review and revise the NAGB policy on reporting and disseminating assessment results; the Design and Analysis Committee will meet to review and formulate recommendations for the approval of the 1991 science assessment; and the full Board will meet to discuss the proposed individualized use of NAEP. From 12 noon to 2 p.m., the Board meeting will close to the public to allow the Board to review two draft NAEP reports. One report will present the 1990 NAEP results in terms of achievement levels. The other report will present NAEP trend data from assessments in math, reading, science, and writing. Both reports are undergoing technical review and analysis and there is a significant possibility that the data contained in each report may be incorrect or incomplete. Further, premature disclosure of these data may be misleading and could have serious consequences for third parties, whose performance could be misinterpreted, leading to decisions being taken by the Department and/or others, that would be based on incomplete, confusing, or erroneous inferences being drawn. Such matters are protected by exemption 9(B) of section 552b(c) of title 5 U.S.C. The closed portion of the meeting will be closed under the authority of 10(d) of the Federal Advisory Committee Act 5 U.S.C. 552b(c). During the period from 2

p.m. until completion of business, the Board will hear briefings on the work of the National Council on Education Standards and Testing; National Education Goals Panel; SCANS Project; 1994 Science Consensus; and NAEP reauthorization issues. On August 3, the full Board will meet from 8:30 a.m. until adjournment, approximately 1:30 p.m. The proposed agenda for this portion of the meeting includes a briefing on NAEP activities; presentation of NAGB committee reports; and Board organization and election of officers.

A summary of the activities at the closed sessions and related matters, which are informative to the public and consistent with the policy of 5 U.S.C. 552b, will be available to the public within 14 days after the meeting. Records are kept of all Board proceedings and are available for public inspection at the Department of Education, National Assessment Governing Board, 1100 L Street, NW., suite 7322, Washington, DC, from 8:30 a.m. to 5 p.m.

The public is being given less than fifteen days notice of this meeting because of the difficulties encountered in scheduling a meeting of the participants who are essential to the actions described in this notice.

Dated: July 23, 1991.

Bruno V. Manno,
Acting Assistant Secretary for Educational Research and Improvement.

[FR Doc. 91-17849 Filed 7-25-91; 8:45 am]

BILLING CODE 4000-01-M

DEPARTMENT OF ENERGY

Floodplain and Wetlands Involvement Notification for Two Separate Actions Involving the Department of Energy Uranium Mill Tailings Remedial Action Project Site Adjacent to Gunnison, CO

AGENCY: U.S. Department of Energy.

ACTION: Notice of floodplain and wetlands involvement.

SUMMARY: The U.S. Department of Energy (DOE) proposes two separate actions that are related to the DOE Gunnison Uranium Mill Tailings Remedial Action (UMTRA) Project site, an inactive uranium milling site adjacent to Gunnison, Colorado. The first proposed action is to provide a public water supply system to residents downgradient of the UMTRA Project site in an area where some wells have been contaminated with releases from uranium mill tailings. The second proposed action is to remove the source of contamination from the UMTRA Project site. Both actions could involve

the disturbance of floodplain or wetland areas along the Gunnison River or Tomichi Creek.

Additional information and figures depicting all potentially disturbed floodplain or wetland areas for the proposed remedial action and proposed water supply pipeline are available from DOE at the first address shown below.

DATES: Any comments are due on or before August 12, 1991.

ADDRESSES: Send comments to: Mark Matthews, Project Manager, Uranium Mill Tailings Remedial Action Project Office, U.S. Department of Energy, 5301 Central Avenue, NW., Suite 1720, Albuquerque, New Mexico 87108.

For further information on floodplain and wetlands environmental review requirements contact: Carol M. Borgstrom, Director, Office of NEPA Oversight, U.S. Department of Energy, 1000 Independence Avenue, SW., Washington, DC 20585.

SUPPLEMENTARY INFORMATION:

I. Provision of Public Supply System.

Studies to characterize the contaminated plume associated with the Gunnison UMTRA Project site found that potential health risks may exist from the continued use of contaminated groundwater at 22 wells downgradient of the site. There are potential noncarcinogenic health risks from uranium mill tailings including heavy metal contamination (in particular uranium, manganese, cadmium, antimony, and lead) and potential carcinogenic health risks from radiological contamination from uranium and its decay products. DOE proposes to provide a public water system to the affected or potentially affected areas by pipeline. The proposed route for the water pipeline is 5 miles long. The pipeline would be buried adjacent to or beneath existing roads at a depth of 7 feet. Surface disturbance would be confined to the areas within the road rights-of-way. The pipeline would have little or no impact on the 100-year floodplain of the Gunnison River. Five buried crossings of the Gunnison River are proposed; each crossing is on a different fork of the river and would require a coffer dam to allow for burial of the pipeline. Wetland areas are present adjacent to roads; potential wetland disturbance is anticipated to total between 1 and 10 acres. All disturbance to wetlands would be temporary, and there is no anticipated net loss to wetlands.

Construction of the pipeline is anticipated to take 6 months. The draft and final Environmental Assessments

on this proposed action will contain a floodplain/wetlands assessment that demonstrates compliance with the floodplain/wetlands environmental review requirements of 10 CFR part 1022. The construction of the proposed water supply system would begin in 1991, and completion is anticipated within one year.

II. Remedial Action

DOE proposes to stabilize and control uranium mill tailings and other non-hazardous materials associated with the UMTRA Project site. The remedial action must comply with the standards promulgated by the U.S. Environmental Protection Agency (40 CFR part 192) as required by the Uranium Mill Tailings Radiation Control Act of 1978 (Pub. L. 95-604). The proposed remedial action would consist of removing uranium mill tailings from the UMTRA Project site and other properties contaminated with uranium mill tailings from the site and disposing of the tailings in a remote location. Neither the UMTRA Project mill tailings site nor the proposed disposal site is within the 100-year floodplain, and no wetlands areas would be disturbed. However, the proposed haul route between the UMTRA Project mill tailings site and the disposal site would cross undisturbed wetland areas, and a small portion of the proposed route is within the 100-year floodplain of Tomichi Creek, a tributary to the Gunnison River. All floodplain/wetlands disturbance would be temporary. Wetlands could be disturbed for up to 3 years, after which they would be reclaimed; there would be no anticipated net loss of wetlands. In accordance with DOE regulations for compliance with the floodplain/wetlands environmental review requirements (10 CFR part 1022), DOE will prepare a floodplain/wetlands assessment to be attached to the environmental assessment of the proposed action. Remedial action is proposed to begin in the early spring of 1992.

Leo P. Duffy,

Director, Office of Environmental Restoration and Waste Management.

[FR Doc. 91-17719 Filed 7-25-91; 8:45 am]

BILLING CODE 6450-01-M

Assistant Secretary for International Affairs and Energy Emergencies

Proposed Subsequent Arrangement

Pursuant to section 131 of the Atomic Energy Act of 1954, as amended (42 U.S.C. 2160), notice is hereby given of a proposed "subsequent arrangement"

under the Additional Agreement for Cooperation between the Government of the United States of America and the European Atomic Energy Community (EURATOM) concerning Peaceful Uses of Atomic Energy, as amended, and the Agreement for cooperation between the Government of the United States of America and the Government of Sweden concerning Peaceful Uses of Nuclear Energy.

The subsequent arrangement to be carried out under the above-mentioned agreements involves approval of the following retransfer: RTD/SW(EU)-150, for the transfer of one fuel element containing 287.32 grams of uranium, enriched to 92.97 percent in the isotope uranium-235, from France to Sweden for use in the R-2 research reactor.

In accordance with section 131 of the Atomic Energy Act of 1954, as amended, it has been determined that this subsequent arrangement will not be inimical to the common defense and security.

This subsequent arrangement will take effect no sooner than fifteen days after the date of publication of this notice.

Issued in Washington, DC on July 22, 1991.

Richard H. Williamson,

Associate Deputy Assistant Secretary for International Affairs.

[FR Doc. 91-17800 Filed 7-25-91; 8:45 am]

BILLING CODE 6450-01-M

Proposed Subsequent Arrangement

Pursuant to section 131 of the Atomic Energy Act 1954, as amended (42 U.S.C. 2160), notice is hereby given of a proposed "subsequent arrangement" under the Additional Agreement for Cooperation between the Government of the United States of America and the European Atomic Energy Community (EURATOM) concerning Peaceful Uses of Atomic Energy, as amended, and the Agreement for Cooperation between the Government of the United States of America and the Government of the Republic of Indonesia concerning Peaceful Uses of Nuclear Energy.

The subsequent arrangement to be carried out under the above-mentioned agreements involves approval of the following retransfer: RTD/IE(EU)-8, for the transfer from Germany to Indonesia of 1,020 grams of uranium, enriched to 93.3 percent in the isotope uranium-235, for use as targets for radioisotope production.

In accordance with section 131 of the Atomic Energy Act of 1954, as amended, it has been determined that this subsequent arrangement will not be

inimical to the common defense and security.

This subsequent arrangement will take effect no sooner than fifteen days after the date of publication of this notice.

Issued in Washington, DC on July 22, 1991.

Richard H. Williamson,

Associate Deputy Assistant Secretary for International Affairs.

[FR Doc. 91-17801 Filed 7-25-91; 8:45 am]

BILLING CODE 6450-01-M

Proposed Subsequent Arrangement

Pursuant to section 131 of the Atomic Energy Act of 1954, as amended (42 U.S.C. 2160), notice is hereby given of a proposed "subsequent arrangement" under the Agreement for Cooperation between the Government of the United States of America and the Government of Canada concerning Civil Uses of Atomic Energy, as amended, and the Agreement for Cooperation between the Government of the United States of America and the Government of the Republic of Korea concerning Civil Uses of Atomic Energy, as amended.

The subsequent arrangement to be carried out under the above-mentioned agreements involves approval of the following retransfer: RTD/KO(CA)-1, for the transfer of 258.50 kilograms of uranium, enriched to 19.75 percent in the isotope uranium-235, from Canada to the Republic of Korea, for use as fuel in the Korean Multi-purpose research reactor.

In accordance with section 131 of the Atomic Energy Act of 1954, as amended, it has been determined that this subsequent arrangement will not be inimical to the common defense and security.

This subsequent arrangement will take effect no sooner than fifteen days after the date of publication of this notice.

Issued in Washington, DC on July 22, 1991.

Richard H. Williamson,

Associate Deputy Assistant Secretary for International Affairs.

[FR Doc. 91-17798 Filed 7-25-91; 8:45 am]

BILLING CODE 6450-01-M

Proposed Subsequent Arrangement

Pursuant to section 131 of the Atomic Energy Act of 1954, as amended (42 U.S.C. 2160), notice is hereby given of a proposed "subsequent arrangement" under the Additional Agreement for Cooperation between the Government of the United States of America and the European Atomic Energy Community

(EURATOM) concerning Peaceful Uses of Atomic Energy, as amended.

The subsequent arrangement to be carried out under the above-mentioned agreement involves approval for the transfer of 1.4 grams of uranium, enriched to 10.4 percent in the isotope uranium-235 and containing less than one percent uranium-233, and 1.6 grams of neptunium. These materials are contained in reference materials, and are to be transferred from Belgium to Czechoslovakia for use in reactor dosimetry at new power reactors which are under construction.

In accordance with section 131 of the Atomic Energy Act of 1954, as amended, it has been determined that this subsequent arrangement will not be inimical to the common defense and security.

This subsequent arrangement will take effect no sooner than fifteen days after the date of publication of this notice.

Issued in Washington, DC on July 22, 1991.

Richard H. Williamson,

Associate Deputy Assistant Secretary for International Affairs.

[FR Doc. 91-17799 Filed 7-25-91; 8:45 am]

BILLING CODE 6450-01-M

Federal Energy Regulatory Commission

[Docket Nos. ER91-537-000, et al.]

Washington Water Power Co., et al.; Electric Rate, Small Power Production, and Interlocking Directorate Filings

July 18, 1991.

Take notice that the following filings have been made with the Commission:

1. Washington Water Power Company

[Docket No. ER91-537-000]

Take notice that on July 8, 1991, Washington Water Power Company tendered for filing a Notice of Termination of the following Agreements:

| Other party | Type of agreement | FERC No. | Termination date |
|----------------------------|----------------------------------|----------|------------------|
| Puget Sound Power & Light. | Firm Capacity and Energy. | 150 | 6/30/91 |
| Pend Oreille County PUD. | Standby Energy. | 169 | 6/30/91 |
| Pend Oreille County PUD. | Exchange of Capacity and Energy. | 163 | 7/1/91 |

Comment date: August 1, 1991, in accordance with Standard Paragraph E at the end of this notice.

2. GWF Power Systems. L.P.

[Docket No. QF86-138-004]

On June 25, 1991, GWF Power Systems, L.P. (Applicant) of 225 Lennon Lane, Suite 120, Walnut Creek, California, 94598, filed an application for recertification of a facility as a qualifying cogeneration facility pursuant to 292.207 of the Commission's regulations. No determination has been made that the submittal constitutes a complete filing.

The proposed topping-cycle cogeneration facility will be located in Hanford, Kings County, California, and will consist of a fluidized bed boiler and an extraction/condensing steam turbine-generator (STG). Steam recovered from the STG will be used by Pirelli-Armstrong Tire Company for curing tires. Petroleum coke will be used as a boiler fuel. The installation began in November of 1988 and was completed in 1990.

The initial certification was issued on November 2, 1988, 45 FERC 61,187 (1988). The instant recertification is requested to reflect a change in the boiler fuel from coal to petroleum coke and natural gas, an increase in the net electric output to 25.44 MW and a decrease in the useful thermal output. In addition, the ownership of the facility has been transferred to the Applicant. Applicant is a Delaware limited partnership. The general partners are GWF Power Systems Company, Inc., CEA, GWF, Inc. (CEA GWF), a wholly-owned subsidiary of CEA USA, Inc. (CEA), and Harbert GWF, Inc. (Harbert GWF), a wholly owned subsidiary of Harbert Cogen, Inc. (Harbert Cogen). The limited partners are CEA and Harbert Cogen. CEA, GWF and CEA are subsidiaries of Public Service Enterprise Group Incorporated, an electric utility.

Comment date: August 26, 1991, in accordance with Standard Paragraph E at the end of this notice.

3. Washington Water Power Company

[Docket No. ER91-543-000]

Take notice that on July 15, 1991, The Washington Water Power Company (WWP) tendered for filing the annual contract rate for the period April 1, 1991 through March 31, 1992 under the 15-Year Purchase and Sale Agreement with Puget Sound Power & Light Company.

Comment date: August 1, 1991, in accordance with Standard Paragraph E at the end of this notice.

4. Niagara Mohawk Power Corporation

[Docket No. ER91-542-000]

Take notice that Niagara Mohawk Power Corporation (Niagara Mohawk) on July 15, 1991, tendered for filing an

agreement between Niagara Mohawk and The United Illuminating Company dated September 1, 1989.

The September 1, 1989 agreement is to provide for the sale by Niagara Mohawk Power Corporation of peaking capacity and related energy to The United Illuminating Company. The terms of this agreement and the period during which the purchase of peaking capacity can occur shall commence on September 1, 1989 and shall continue until October 31, 1989.

Copies of this filing were served upon The United Illuminating Company and the New York State Public Service Commission.

Comment date: August 1, 1991, in accordance with Standard Paragraph E at the end of this notice.

5. Washington Water Power Company

[Docket No. ER91-534-000]

Take notice that on July 8, 1991, Washington Water Power Company (WWP), tendered for filing a Capacity and Energy Sale Agreement between WWP and Sierra Pacific Power Company. WWP requests that the Commission (a) accept the Agreement for filing, effective as of July 1, 1991, and (b) grant a waiver of notice pursuant to 18 CFR 35.11, to allow the filing of the Agreement less than 60 days prior to the date on which service under the Agreement is to commence.

A copy of the filing was served upon Sierra Pacific Power Company.

Comment date: August 1, 1991, in accordance with Standard Paragraph E end of this notice.

6. Illinois Power Company

[Docket No. ER91-535-000]

Take notice that Illinois Power Company on July 8, 1991, tendered for filing Addenda which increase IP's demand rate ceilings for (1) Limited Term Power to "up to" \$27.08 per KW-Month, (2) Short Term Power to "up to" \$6.25 per KW-Week ("up to" \$1.25 per KW-Day), (3) Short Term Non-Firm to "up to" \$5.50 per KW-Week ("up to" \$1.10 per KW-Day), and (4) Non-Displacement and Term Power to "up to" 6.9 cents per kWh. The purpose of the Addenda are to update the peak demand rates for voluntary sales to reflect the cost of the most recent major generating unit placed in service on IP's System. The addenda also provide for a uniform emergency rate of \$100/MWH.

Copies of the filing were served upon the Illinois Commerce Commission and the appropriate utilities interconnected with IP.

Comment date: August 1, 1991, in accordance with Standard Paragraph E at the end of this notice.

Standard Paragraphs

E. Any person desiring to be heard or to protest said filing should file a motion to intervene or protest with the Federal Energy Regulatory Commission, 825 North Capitol Street, NE., Washington, DC 20426, in accordance with Rules 211 and 214 of the Commission's Rules of Practice and Procedure (18 CFR 385.211 and 385.214). All such motions or protests should be filed on or before the comment date. Protests will be considered by the Commission in determining the appropriate action to be taken, but will not serve to make protestants parties to the proceeding. Any person wishing to become a party must file a motion to intervene. Copies of this filing are on file with the Commission and are available for public inspection.

Lois D. Cashell,
Secretary.

[FR Doc. 91-17739 Filed 7-25-91; 8:45 am]

BILLING CODE 6717-01-M

[Docket Nos. CP91-2476-000, et al.]

Northwest Pipeline Corp., et al; Natural Gas Certificate Filings

July 18, 1991

Take notice that the following filings

have been made with the Commission:

1. Northwest Pipeline Corporation

[Docket No. CP91-2476-000]

Take notice that on July 15, 1991, Northwest Pipeline Corporation (Northwest), 295 Chipeta Way, Salt Lake City, Utah 84158, filed in Docket No. CP91-2476-000 a request pursuant to § 157.205 of the Commission's Regulations under the Natural Gas Act (18 CFR 157.205) to construct and operate measuring and regulating facilities for a delivery point in Pierce County, Washington, for a transportation service for Development Associates, Inc. (DA), under Northwest's blanket certificate issued in Docket No. CP82-433-000 pursuant to Section 7 of the Natural Gas Act, all as more fully detailed in the application which is on file with the Commission and open to public inspection.

Specifically, Northwest proposes to construct and operate the meter for the delivery of up to 5,160 MMBtu equivalent of natural gas on a peak day to DA, which will sell the gas to the Boeing Company, which is constructing a new aircraft plant using natural gas for boiler fuel and heating. Northwest states that it received prior notice authorization from the Commission for a firm transportation service for DA in Docket No. CP91-106-000. It is stated that deliveries using the proposed meter would be within DA's existing

entitlement from Northwest and would have no significant impact on Northwest's peak day deliveries.

Comment date: September 3, 1991, in accordance with Standard Paragraph G at the end of this notice.

2. Columbia Gulf Transmission Company, et al.

[Docket Nos. CP91-2488-000, CP91-2489-000, CP91-2491-000, CP91-2492-000]

Take notice that Applicants filed in the above-referenced dockets prior notice requests pursuant to §§ 157.205 and 284.223 of the Commission's Regulations under the Natural Gas Act for authorization to transport natural gas on behalf of shippers under the blanket certificates issued to Applicants pursuant to Section 7 of the Natural Gas Act, all as more fully set forth in the requests that are on file with the Commission and open to public inspection.¹

¹ These prior notice requests are not consolidated. Information applicable to each transaction, including the identity of the shipper, the type of transportation service, the appropriate transportation rate schedule, the peak day, average day and annual volumes, and the initiation service dates and related ST docket numbers of the 120-day transactions under Section 284.223 of the Commission's Regulations, has been provided by Applicants and is summarized in the attached Appendix A. Applicants' addresses and transportation blanket certificates are shown in the attached Appendix B. *Comment date:* September 3, 1991, in accordance with Standard Paragraph G at the end of this notice.

| Docket No. (date filed) | Shipper name (type) | Peak day, average day, annual Mcf | Receipt ¹ points | Delivery points | Contract date, rate schedule, service type | Related docket start up date |
|-------------------------|---|--|-----------------------------|-----------------|--|------------------------------|
| CP91-2488-000 (7-16-91) | Chevron U.S.A., Inc. (Producer). | 30,000 24,000 | OLA | LA | 6-6-88, ITS-2, Interruptible. | ST91-9372-000 4-1-91 |
| CP91-2489-000 (7-16-91) | Enron Gas Marketing, Inc. (Marketer). | ² 8,760,000 50,000 50,000 18,250,000 | OLA, OTX, LA, IL, TN, TX. | TN | 5-30-86, ³ PT, Interruptible. | ST91-9010-000 5-22-91 |
| CP91-2490-000 (7-16-91) | Stellar Gas Company (Marketer). | 10,000 10,000 3,650,000 | OTX | OTX | 5-28-91, PT, Interruptible. | ST91-9114-000 6-1-91 |
| CP91-2491-000 (7-16-91) | Shell Offshore Inc. (Producer). | 30,000 30,000 10,950,000 | OLA | LA | 5-16-91, PT, Interruptible. | ST91-9244-000 6-1-91 |
| CP91-2492-000 (7-17-91) | Aquila Energy Marketing Corporation (Marketer). | 1,000,000 1,000,000 ⁴ 365,000,000 | Various | Various | 4-13-89, ³ IT, Interruptible. | ST91-9462-000 7-2-91 |

¹ Offshore Louisiana and offshore Texas are shown as OLA and OTX.

² Columbia Gulf's quantities are in MMBtu.

³ As amended.

⁴ Tennessee's quantities are in dekatherms.

| Applicant's address | Blanket docket | Applicant's address | Blanket docket | Applicant's address | Blanket docket |
|--|----------------|---|----------------|---|----------------|
| Columbia Gulf Transmission Company, P.O. Box 683, Houston, Texas 77001 | CP86-239-000 | Tennessee Gas Pipeline Company, P.O. Box 2511, Houston, Texas 77252 | CP87-115-000 | Trunkline Gas Company, P.O. Box 1642, Houston, Texas 77251-1642 | CP86-586-000 |

3. El Paso Natural Gas Company, et al.

[Docket Nos. CP91-2447-000, CP91-2450-000, CP91-2452-000, CP91-2453-000]

Take notice that Applicants filed in the above-referenced dockets prior notice requests pursuant to §§ 157.205 and 284.223 of the Commission's Regulations under the Natural Gas Act for authorization to transport natural gas on behalf of shippers under the blanket certificates issued to Applicants pursuant to section 7 of the Natural Gas

Act, all as more fully set forth in the requests that are on file with the Commission and open to public inspection.²

Information applicable to each transaction, including the identity of the shipper, the type of transportation service, the appropriate transportation rate schedule, the peak day, average day and annual volumes, and the initiation

² These prior notice requests are not consolidated.

service dates and related ST docket numbers of the 120-day transactions under § 284.223 of the Commission's Regulations, has been provided by Applicants and is summarized in the attached Appendix A. Applicants' addresses and transportation blanket certificates are shown in the attached appendix. B.

Comment date: September 3, 1991, in accordance with Standard Paragraph G at the end of this notice.

| Docket No. (date filed) | Shipper name (type) | Peak day, average day, annual dt equivalent | Receipt points ¹ | Delivery points | Contract date, rate schedule, service type | Related docket, start up date |
|----------------------------|--|---|------------------------------|----------------------------|--|-------------------------------|
| CP91-2447-000 (7-11-91) | GasMark, Inc. (Marketer). | * 8,034 5,150 1,879,750 | Various..... | AZ..... | 5-24-91, T-1, Interruptible. | ST91-9032 6-1-91 |
| CP91-2450-000 (7-11-91) | Western Natural Gas and Transmission (Marketer). | * 4,000 365,000 | CO, WY..... | CO..... | 3-1-91, TI-1, Interruptible. | ST91-9391 6-10-91 |
| CP91-2452-000 (7-11-91) | Eastex Gas Transmission (Intrastate Pipeline). | 20,000 20,000 7,300,000 | OLA..... | LA..... | 4-27-87, IT, Interruptible. | ST91-9387 6-28-91 |
| CP91-2453-000 (7-11-91) | Kerr-McGee Corporation (Producer). | 185,000 185,000 67,525,000 | OLA, OTX, LA, TX, AL, MS. | LA, TX, AL, MS, WV, PA. | 4-30-88, IT, Interruptible. | ST91-9406 7-1-91 |

¹ Offshore Louisiana and offshore Texas are shown as OLA and OTX.

² Measured in MMBtu equivalent.

* Measured in Mcf.

| Applicant's address | Blanket docket |
|---|------------------|
| Colorado Interstate Gas Company, P.O. Box 1087, Colorado Springs, Colorado 80944. | CP86-589, et al. |
| El Paso Natural Gas Company, P.O. Box 1492, El Paso, Texas 79978. | CP88-433-000. |
| Tennessee Gas Pipeline Company, P.O. Box 2511, Houston, Texas 77252. | CP87-115-000. |

4. Northwest Pipeline Corporation

[Docket No. CP91-2456-000]

Take notice that on July 11, 1991, Northwest Pipeline Corporation (Northwest) 295 Chipeta Way, Salt Lake City, Utah 84158, filed in Docket No. CP91-2456-000, a request pursuant to §§ 157.205, 157.211(b) and 157.216(b) of the Commission's Regulations and Northwest's blanket certificate issued in Docket No. CP82-433-000 pursuant to section 7 of the Natural Gas Act (NGA) for authorization to abandon certain metering facilities at the existing Sedro Woolley Meter Station in Skagit County, Washington and to construct and operate upgraded metering facilities at the Sedro Woolley Meter Station in

order to enable both Northwest and the receiving party, Cascade Natural Gas Corporation (Cascade), to accommodate requests for additional transportation service to Texaco, Inc. (Texaco) and other end-users served by Cascade, all a more fully set forth in the request which is on file with the Commission and open to public inspection.

Northwest states that the Sedro Woolley Meter Station is located in Skagit County, Washington, at milepost 1447.66 on Northwest's mainline. The existing Sedro Woolley Meter Station consists of an eight-inch tap on Northwest's 26-inch mainline and a four-inch tap of Northwest's 30-inch mainline loop, an eight-inch turbine meter and a ten-inch orifice meter run, a monitor regulation run consisting of four-inch regulators, and appurtenances. The existing Sedro Woolley Meter Station has a maximum design delivery capacity of approximately 338,000 therms per day.

Northwest further states that Cascade is Northwest's only customer for firm service at the Sedro Woolley Meter Station and that Northwest has an existing firm obligation to deliver up to 267,315 therms per day to Cascade at the Sedro Woolley Station, under sales, transportation and storage agreements. In addition to the firm service to Cascade, the station is used for

interruptible transportation service to Cascade and others, including Texaco. Cascade has requested Northwest to provide additional delivery capacity at the Sedro Woolley delivery point to facilitate the transportation of additional gas which will be requested by Texaco and other shippers to serve the new March Point Cogeneration facility being constructed and other new requirements. The March Point Cogeneration facility is a new 140 megawatt cogeneration facility at Texaco's Puget Sound refinery in Anacortes, Washington, downstream of the Sedro Woolley delivery meter served by Cascade which will require up to 330,000 therms per day.

Northwest states that under its proposal it will remove the existing four-inch monitor regulation run (consisting of four-inch regulators), the ten-inch orifice meter, and associated appurtenances and will replace those facilities with a six-inch monitor regulation run (consisting of four six-inch regulators), a twelve-inch turbine meter, and associated appurtenances. The existing eight-inch turbine meter will remain in place. The upgraded Sedro Woolley Meter Station will have a design capacity of approximately 1,004,000 therms per day and the total estimated cost of the upgrading the

Sedro Woolley Meter Station is approximately \$493,290. Northwest further states that pursuant to the facilities reimbursement provisions of Northwest's Rate Schedule FT-1 Northwest will install and pay for the upgraded Sedro Woolley facilities, since the estimated revenues associated with the incremental load projected to result from service to the new March Point Cogeneration facility exceeds the cost-of-service for the meter upgrade.

Comment date: September 3, 1991, in accordance with Standard Paragraph G at the end of this notice.

5. Northwest Pipeline Corporation

[Docket No. CP91-2455-000]

Take notice that on July 11, 1991, Northwest Pipeline Corporation (Northwest), 295 Chipeta Way, Salt Lake City, Utah 84158-0900, filed in Docket No. CP91-2455-000 an application pursuant to section 7(b) of the Natural Gas Act for permission and approval to abandon an interruptible gathering and transportation service for Southwest Gas Corporation (Southwest), all as more fully set forth in the application which is on file with the Commission and open to public inspection.

Northwest states that it is requesting approval to abandon the interruptible gathering and transportation service it provided for Southwest pursuant to

Northwest's Rate Schedule X-49 of its FERC Gas Tariff, Original Volume No. 2 and a certificate issued in Docket No. CP78-380, as amended. Northwest indicates that no service has been provided under Rate Schedule X-49 since 1985. Northwest states that by letter dated May 28, 1991, it notified Southwest that pursuant to the terms of the gathering and transportation agreement that it was reducing the delivery volumes under the agreement to zero for priority purposes, and effectively terminating its contractual obligation to make deliveries for Southwest under Rate Schedule X-49.

Northwest indicates that in the May 28, 1991, letter, it has offered Southwest replacement non-jurisdictional gathering contracts and blanket transportation contracts at the same previous maximum contract volumes. Northwest also states that it does not propose the abandonment of any facilities with this proposal.

Comment date: August 8, 1991, in accordance with Standard Paragraph F at the end of the notice.

6. K N Energy, Inc., et al.

[Docket Nos. CP91-2470-000, CP91-2471-000, CP91-2472-000, CP91-2473-000, CP91-2475-000]

Take notice that on July 15, 1991, K N Energy, Inc., P.O. Box 281304, Lakewood,

CO 80228-9304, and Tennessee Gas Pipeline Company, P.O. Box 2511, Houston, Texas 77252, (Applicants) filed in the above-referenced dockets prior notice requests pursuant to §§ 157.205 and 284.223 of the Commission's Regulations under the Natural Gas Act for authorization to transport natural gas on behalf of shippers under the blanket certificates issued in Docket No. CP89-1043-000 and Docket No. CP87-115-000, respectively, pursuant to section 7 of the Natural Gas Act, all as more fully set forth in the requests that are on file with the Commission and open to public inspection.³

Information applicable to each transaction, including the identity of the shipper, the type of transportation service, the appropriate transportation rate schedule, the peak day, average day and annual volumes, and the initiation service dates and related ST docket numbers of the 120-day transactions under § 284.223 of the Commission's Regulations, has been provided by Applicants and is summarized in the attached appendix.

Comment date: September 3, 1991, in accordance with Standard Paragraph G at the end of this notice.

³ These prior notice requests are not consolidated.

| Docket No. (date filed) | Shipper name (type) | Peak day, average day annual Mcf | Receipt points | Delivery points | Contract date, rate schedule, service type | Related docket, start up date |
|----------------------------|------------------------------------|--|----------------------------|---|--|-------------------------------|
| CP91-2470-000 (7-15-91) | GPC Marketing Company (Marketer). | 6,000 6,000 2,190,000 | CO, KS, NB, WY | CO, KS, WY | 5-24-91, IT-1, IT-2, IT-3, Interruptible. | ST91-9208-000 6-1-91 |
| CP91-2471-000 (7-15-91) | John Brown E&C, Inc. (Shipper). | 8,000 8,000 2,920,000 | CO, KS, NB, WY | WY | 5-1-91, IT-1, IT-2, IT-3, Interruptible. | ST91-9211-000 6-1-91 |
| CP91-2472-000 (7-15-91) | Hiland Partners (Shipper). | 5,000 5,000 1,825,000 | WY | WY | 5-31-91, IT-1, IT-2, IT-3, Interruptible. | ST91-9209-000 6-1-91 |
| CP91-2473-000 (7-15-91) | Exxon Corporation (Producer). | 55,000 50,959 18,600,000 | CO, KS, NB, WY | CO, KS and WY | 5-8-91, IT-1, IT-2, IT-3, Interruptible. | ST91-9382-000 5-31-91 |
| CP91-2475-000 (7-15-91) | Kerr-McGee Corporation (Producer). | 380,000 380,000 ¹ 138,700,000 | Off LA, On LA, Off TX, MS. | PA, AL, MS, LA, TX, WV, TN, OH, KN, NY, NJ. | 3-24-88, as amended, IT, Interruptible. | ST91-9418-000 7-1-91 |

¹ Tennessee's quantities are in dekatherms.

7. Algonquin Gas Transmission Company

[Docket No. CP89-661-005]

Take notice that on July 10, 1991, Algonquin Gas Transmission Company (Algonquin), 1284 Soldiers Field Road, Boston, Massachusetts 02135, filed an amendment in Docket No. CP89-661-005 to a pending amendment in said docket

for a certificate of public convenience and necessity pursuant to section 7(c) of the Natural Gas Act for authorization to perform new transportation services, to transfer into this filing facilities necessary to perform the subject transportation that have been previously certificated by the Commission in other Algonquin filings, and to construct and operate facilities necessary to perform

the subject transportation, all as more fully set forth in the amendment which is on file with the Commission and open to public inspection.

Specifically, Algonquin seeks authorization to provide firm transportation service of up to 13,828 MMBtu per day on behalf of Dartmouth Power Associates (Dartmouth) and up to 3,948 MMBtu per day on behalf of

Colonial Gas Company (Colonial). In order to effectuate this transportation service, Algonquin intends to construct and operate, at an estimated cost of \$6.6 million, the following facilities:

(1) An additional 2.5 miles of 12-inch pipeline loop on Algonquin's E-1 system from the Browning Road Meter Station in Norwich, Connecticut to the Salem Turnpike Meter Station in Norwich, Connecticut.⁴

(2) An additional 1.5 miles of 20-inch pipeline loop on Algonquin's G-8 system from Plymouth, Massachusetts to the Bourne Meter Station in the towns of Plymouth and Bourne, Massachusetts.⁴

(3) A meter station on Algonquin's G-3 system at Dartmouth, Massachusetts.

The estimated cost of the facilities is \$6.6 million. Algonquin expects to finance these facilities in a manner similar to its current capitalization structure as filed in Docket No. RP90-22-000 (Debt, 49.18%; Equity, 50.82%), subject to change to reflect the most advantageous market conditions available at the time the financing is actually undertaken.

Algonquin intends to perform the instant transportation service pursuant to Rate Schedule AFT-2 which is pending in Docket No. CP89-661-004. Rate Schedule AFT-2 is designed to recover the cost of service associated with the incremental facilities required

⁴ These items, when combined with adjoining pipeline looping that has been moved to Docket No. CP89-661-004, total the mileage that has already been approved in Phase III of the Niagara Import Point Projects, Tennessee Gas Pipeline Company, 52 FERC ¶ 61,257.

to render the proposed service through a one-part demand charge.

Comment date: August 8, 1991, in accordance with the first subparagraph of Standard Paragraph F at the end of this notice.

8. Panhandle Eastern Pipe Line Company

[Docket No. CP91-2465-000]

Take notice that on July 12, 1991, Panhandle Eastern Pipe Line Company (Panhandle), P.O. Box 1642, Houston, Texas 77251-1642, filed in Docket No. CP91-2465-000 a request pursuant to § 157.205 of the Commission's Regulations under the Natural Gas Act (18 CFR 157.205) for authorization to reassign volumes at the Elwood delivery point on Indiana Gas Company's sales agreement dated October 26, 1990, under Panhandle's blanket certificate issued in Docket No. CP83-83-000 pursuant to Section 7 of the Natural Gas Act, all as more fully set forth in the request which is on file with the Commission and open to public inspection.

Panhandle states that it inadvertently omitted this request from the application filed in Docket No. CP91-595-000. Panhandle further states that no increase in volumes is proposed and that at no time shall the aggregate volumes delivered on a single day to all the delivery points in Article 3 of the sales agreement exceed 240,030 Mcf.

Comment date: September 3, 1991, in accordance with Standard Paragraph G at the end of this notice.

9. Columbia Gulf Transmission Company and Transcontinental Gas Pipe Line Corporation

[Docket No. CP91-2467-000, CP91-2469-000]

Take notice that Columbia Gulf Transmission Company, 3805 West Alabama, Houston, Texas 77027, and Transcontinental Gas Pipe Line Corporation, P.O. Box 1396, Houston, Texas 77251, (Applicants) filed in the above-referenced dockets prior notice requests pursuant to § 157.205 and 284.223 of the Commission's Regulations under the Natural Gas Act for authorization to transport natural gas on behalf of various shippers under the blanket certificates issued in Docket No. CP86-239-000 and Docket No. CP88-328-000, respectively, pursuant to section 7 of the Natural Gas Act, all as more fully set forth in the requests that are on file with the Commission and open to public inspection.⁵

Information applicable to each transaction, including the identity of the shipper, the type of transportation service, the appropriate transportation rate schedule, the peak day, average day and annual volumes, and the initiation service dates and related ST docket numbers of the 120-day transactions under § 284.223 of the Commission's Regulations, has been provided by Applicants and is summarized in the attached appendix.

Comment date: September 3, 1991, in accordance with Standard Paragraph G at the end of this notice.

⁵ These prior notice requests are not consolidated.

| Docket No. (date filed) | Shipper name (type) | Peak day, average day, annual MMBtu | Receipt points ¹ | Delivery points | Contract date, rate schedule, service type | Related docket, start up date |
|----------------------------|---|-------------------------------------|-----------------------------|-----------------|--|-------------------------------|
| CP91-2467-000 (7-12-91) | Enron Gas Marketing, Inc. (Marketer). | 20,000 16,000 7,300,000 | OLA, LA | LA | FTS-2, Firm | ST91-2294 6-13-91 |
| CP91-2469-000 (7-12-91) | Citizens Gas Supply Corporation (Marketer). | 100,000 50,000 18,250,000 | Various | Various | IT, Interruptible | ST91-8697 9-21-90 |

¹ Offshore Louisiana and offshore Texas are shown as OLA and OTX.

Standard Paragraphs

F. Any person desiring to be heard or make any protest with reference to said filing should on or before the comment date file with the Federal Energy Regulatory Commission, 825 North Capitol Street, NE., Washington, DC 20426, a motion to intervene or a protest in accordance with the requirements of the Commission's rules of Practice and

Procedure (18 CFR 385.211 and 385.214) and the Regulations under the Natural Gas Act (18 CFR 157.10). All protests filed with the Commission will be considered by it in determining the appropriate action to be taken but will not serve to make the protestants parties to the proceeding. Any person wishing to become a party to a proceeding or to participate as a party in any hearing therein must file a motion to

intervene in accordance with the Commission's Rules.

Take further notice that, pursuant to the authority contained in and subject to jurisdiction conferred upon the Federal Regulatory Commission by Sections 7 and 15 of the Natural Gas Act and the Commission's rules of Practice and Procedure, a hearing will be held without further notice before the Commission or its designee on this

ruling if no motion to intervene is filed within the time required herein, if the Commission on its own review of the matter finds that a grant of the certificate is required by the public convenience and necessity. If a motion for leave to intervene is timely filed, or if the Commission on its own motion believes that a formal hearing is required, further notice of such hearing will be duly given.

Under the procedure herein provided for, unless otherwise advised, it will be unnecessary for the applicant to appear or be represented at the hearing.

G. Any person or the Commission's staff may, within 45 days after the issuance of the instant notice by the Commission, file pursuant to rule 214 of the Commission's Procedural Rules (18 CFR 385.214) a motion to intervene or notice of intervention and pursuant to § 157.205 of the Regulations under the Natural Gas Act (18 CFR 157.205) a protest to the request. If no protest is filed within the time allowed therefore, the proposed activity shall be deemed to be authorized effective the day after the time allowed for filing a protest. If a

protest is filed and not withdrawn within 30 days after the time allowed for filing a protest, the instant request shall be treated as an application for authorization pursuant to Section 7 of the Natural Gas Act.

Lois D. Cashell,

Secretary.

[FR Doc. 91-17740 Filed 7-25-91; 8:45 am]

BILLING CODE 6717-01-M

[Docket Nos. CP-91-2496-000, et al.]

Trunkline Gas Co., et al.; Natural Gas Certificate Filings

July 19, 1991.

Take notice that the following filing have been made with the Commission:

1. Trunkline Gas Company

[Docket No.'s CP91-2496-000, CP91-2497-000, CP91-2498-000, CP91-2499-000, CP91-2500-000, CP91-2501-000]

Take notice that on July 17, 1991, Trunkline Gas Company (Trunkline), P.O. Box 1642, Houston, Texas 77251-1642, filed in the above-referenced dockets prior notice requests pursuant

to §§ 157.205 and 284.223 of the Commission's Regulations under the Natural Gas Act for authorization to transport natural gas on behalf of shippers under its blanket certificate issued in Docket No. CP86-586-000, pursuant to section 7 of the Natural Gas Act, all as more fully set forth in the requests that are on file with the Commission and open to public inspection.¹

Information applicable to each transaction, including the identity of the shipper, the type of transportation service, the appropriate transportation rate schedule, the peak day, average day and annual volumes, and the initiation service dates and related ST docket numbers of the 120-day transactions under § 284.223 of the Commission's Regulations, has been provided by Trunkline and is summarized in the attached appendix.

Comment date: September 3, 1991, in accordance with Standard Paragraph G at the end of this notice.

¹ These prior notice requests are not consolidated.

| Docket No. (date filed) | Shipper name (type) | Peak day, average day, annual Mcf | Receipt ¹ points | Delivery points | Contract date, rate schedule, service type | Related docket, start up date |
|----------------------------|--|-----------------------------------|-----------------------------------|-----------------|--|-------------------------------|
| CP91-2496-000 (7-17-91) | Exxon Corporation (producer). | 50,000 50,000 18,250,000 | OLA..... | LA..... | Apr. 22, 1991, PT, interruptible. | ST91-9242-000 6-01-91 |
| CP91-2497-000 (7-17-91) | Polaris Corporation (marketer). | 50,000 50,000 18,250,000 | TX, IL, LA, TN, OLA, OTX. | IN..... | May 30, 1991, PT, interruptible. | ST91-9120-000 6-01-91 |
| CP91-2498-000 (7-17-91) | Exxon Corporation (producer). | 25,000 25,000 9,125,000 | OLA, IL, LA, TN, TX, OLA, OTX. | LA..... | Apr. 15, 1991, PT, interruptible. | ST91-9243-000 6-01-91 |
| CP91-2499-000 (7-17-91) | Panhandle Trading Company (marketer). | 15,000 15,000 5,475,000 | TX, IL, LA, TN, OLA, OTX. | TN..... | May 24, 1991, PT, interruptible. | ST91-9119-000 6-01-91 |
| CP91-2500-000 (7-17-91) | Panhandle Trading Company (marketer). | 5,000 5,000 1,825,000 | TX, IL, LA, TN, OLA, OTX. | TN..... | May 24, 1991, PT, interruptible. | ST91-9118-000 6-01-91 |
| CP91-2501-000 (7-17-91) | Vesta Energy Company (marketer). | 5,000 5,000 1,825,000 | LA, IL, TN, TX, OLA, OTX. | IL..... | May 17, 1991, PT, interruptible. | ST91-9116-000 6-01-91 |

¹ Offshore Louisiana and offshore Texas are shown as OLA and OTX.

2. Northwest Pipeline Corporation

[Docket No.'s CP91-2484-000, CP91-2485-000, CP91-2486-000, CP91-2487-000]

Take notice that Applicant filed in the respective dockets prior notice requests pursuant to §§ 157.205 and 284.223 of the Commission's Regulations under the Natural Gas Act for authorization to transport natural gas on behalf of various shippers under their blanket certificate pursuant to section 7 of the Natural Gas Act, all as more fully set forth in the requests that are on file with

the Commission and open to public inspection.²

Information applicable to each transaction, including the identity of the shipper, the type of transportation service, the appropriate transportation rate schedule, the peak day, average day and annual volumes, and the initiation service dates and related docket numbers of the 120-day transactions under § 284.223 of the Commission's Regulations, has been provided by Applicant and is summarized in the attached appendix.

² These prior notice requests are not consolidated.

Applicant states that each of the proposed services would be provided under an executed transportation agreement, and that Applicant would charge the rates and abide by the terms and conditions of the referenced transportation rate schedules.

Comment date: September 3, 1991, in accordance with Standard Paragraph G at the end of this notice.

Applicant: Northwest Pipeline Corporation, 295 Chipeta Way, Salt Lake City, UT 84108.

Blanket Certificate Issued in Docket
No.: CP86-578-000.

| Docket No. (date filed) | Shipper name (type shipper) | Peak day, avg. annual | Points of | | Start up date, rate schedule | Related dockets ² |
|-----------------------------|---|-------------------------------|------------------|----------|------------------------------|------------------------------|
| | | | Receipt | Delivery | | |
| CP91-2484-000 (07-16-91) | Southwest Gas Corp.— Northern California (LDC). | 7,668 2,368 864,461 | CO, WY, WA | ID | 06-01-91, TF-1..... | ST91-9342-000 |
| CP91-2485-000 (07-16-91) | CP National Corp. (LDC). | 11,373 4,959 1,810,000 | CO, WY, WA | ID | 06-01-91, TF-1..... | ST91-9341-000 |
| CP91-2486-000 (07-16-91) | Sierra Pacific Power Co. (LDC). | 61,696 26,427 9,645,683 | CO, WY, WA | ID | 06-01-91, TF-1..... | ST91-9339-000 |
| CP91-2487-000 (07-16-91) | Southwest Gas Corp.— Northern Nevada (LDC). | 42,826 17,564 6,410,946 | CO, WY, WA | ID | 06-01-91, TF-1..... | ST91-9340-000 |

¹ Quantities are shown in MMBtu unless otherwise indicated.
² If an ST docket is shown, 120-day transportation service was reported in it.

3. Natural Gas Pipeline Company of America

[Docket Nos. CP91-2434-000, CP91-2435-000, CP91-2436-000, CP91-2437-000, CP91-2438-000, CP91-2439-000]

Take notice that on July 10, 1991, Natural Gas Pipeline Company of America (Natural), 701 East 22nd Street, Lombard, Illinois 60148, filed in the above-referenced dockets prior notice requests pursuant to §§ 157.205 and 284.223 of the Commission's Regulations under the Natural Gas Act for

authorization to transport natural gas on behalf of shippers under its blanket certificate issued in Docket No. CP86-582-000, pursuant to section 7 of the Natural Gas Act, all as more fully set forth in the requests that are on file with the Commission and open to public inspection.³

Information applicable to each transaction, including the identity of the

³ These prior notice requests are not consolidated.

shipper, the type of transportation service, the appropriate transportation rate schedule, the peak day, average day and annual volumes, and the initiation service dates and related ST docket numbers of the 120-day transactions under § 284.223 of the Commission's Regulations, has been provided by Natural and is summarized in the attached appendix.

Comment date: September 3, 1991, in accordance with Standard Paragraph G at the end of this notice.

| Docket No. (date filed) | Shipper name (type) | Peak day, average day, annual MMBtu | Receipt points | Delivery points | Contract date, rate schedule, service type | Related docket, start up date |
|----------------------------|--|-------------------------------------|----------------|---|--|-------------------------------|
| CP91-2434-000 (7-10-91) | Phibro Energy, Inc. (Marketer). | 50,000 30,000 10,950,000 | Various | Offshore LA & TX, LA, TX, OK, IL, CO. | 4-24-91, ITS, Interruptible. | ST91-8793-000 5-1-91 |
| CP91-2435-000 (7-10-91) | Hadson Gas Systems, Inc. (Marketer). | 100,000 50,000 18,250,000 | Various | Offshore LA & TX, LA, TX, OK, IL, IA, CO, NM. | 4-25-91, ITS, Interruptible. | ST91-8792-000 5-1-91 |
| CP91-2436-000 (7-10-91) | Industrial Energy Applications, Inc. (Marketer). | 20,000 60,000 21,900,000 | Various | Offshore LA & TX, LA, TX, OK, IL, IA, CO, NM. | 4-4-91, ITS, Interruptible. | ST91-8841-000 5-1-91 |
| CP91-2437-000 (7-10-91) | Tenaska Marketing Ventures (Marketer). | 5,000 2,500 912,500 | Various | Offshore LA & TX, LA, TX, OK, IL, IA, CO, NM. | 4-22-91, ITS, Interruptible. | ST91-8840-000 5-1-91 |
| CP91-2438-000 (7-10-91) | Owens-Illinois Glass Container, Inc. (Marketer). | 1,000 1,000 365,000 | Various | IL..... | 5-1-91, FTS, Firm..... | ST91-8860-000 5-1-91 |
| CP91-2439-000 (7-10-91) | Green Valley Chemical Corporation (End-User). | 3,800 3,800 1,387,000 | Various | IA..... | 11-12-90, FTS, Firm. | ST91-8723-000 5-1-91 |

4. Trunkline Gas Company; Northern Natural Gas Company

[Docket No's. CP91-2502-000, CP91-2503-000, CP91-2504-000, CP91-2505-000, CP91-2506-000]

Take notice that on July 17, 1991, Trunkline Gas Company, P.O. Box 1642, Houston, Texas 77251-1642, and Northern Natural Gas Company, 1400 Smith Street, P.O. Box 1188, Houston, Texas 77251-1188, (Applicants) filed in

the above-referenced dockets prior notice requests pursuant to §§ 157.205 and 284.223 of the Commission's Regulations under the Natural Gas Act for authorization to transport natural gas on behalf of shippers under the blanket certificates issued in Docket No. CP86-586-000 and Docket No. CP86-435-000, respectively, pursuant to section 7 of the Natural Gas Act, all as more fully set forth in the requests that

are on file with the Commission and open to public inspection.⁴

Information applicable to each transaction, including the identity of the shipper, the type of transportation service, the appropriate transportation rate schedule, the peak day, average day and annual volumes, and the initiation

⁴ These prior notice requests are not consolidated.

service dates and related ST docket numbers of the 120-day transactions under § 284.223 of the Commission's

Regulations, has been provided by Applicants and is summarized in the attached appendix.

Comment date: September 3, 1991, in accordance with Standard Paragraph G at the end of this notice.

| Docket No. (date filed) | Shipper name (type) | Peak day, average day, annual Mcf | Receipt ¹ points | Delivery points | Contract date, rate schedule, service type | Related docket, start up date |
|----------------------------|---|---|---------------------------------|-----------------|--|-------------------------------|
| CP91-2502-000 (7-17-91) | Sun Refining and marketing Company (End-user). | 30,000,..... 5,000,..... 10,950,000..... | OLA, OTX, LA, IL, TN, TX | IL..... | 6-20-89, PT Interruptible. | ST91-9126-000 6-1-91 |
| CP91-2503-000 (7-17-91) | Dishop Pipeline Corporation (Intrastate Pipeline). | 20,000,..... 20,000,..... 7,300,000..... | OLA, OTX, TX, IL, LA, TN | IN..... | 5-24-91, PT Interruptible. | ST91-9117-000 6-1-91 |
| CP91-2504-000 (7-17-91) | TEX/CON Gas Marketing Company (Marketer). | 50,000,..... 50,000,..... 18,250,000..... | OLA, OTX, IN, IL, LA, TN, TX | OH..... | 2-22-91, PT, Interruptible. | ST91-9175-000 6-1-91 |
| CP91-2505-000 (7-17-91) | Marathon Oil Company (Producer). | 4,000,..... 4,000,..... 1,460,000..... | OLA, OTX, IL, LA, TN, TX | IL..... | 6-1-91, PT, Firm | ST91-9115-000 6-1-91 |
| CP91-2508-000 (7-17-91) | Heimerich & Payne Energy Services, Inc. (Producer). | 30,000,..... 22,500,..... 10,950,000 ² | Various | Various..... | 6-12-91, IT-1, Interruptible. | ST91-9471-000 6-12-91 |

¹ Offshore Louisiana and offshore Texas are shown as OLA and OTX.

² Northern's quantities are in MMSbu.

G. Any person or the Commission's staff may, within 45 days after the issuance of the instant notice by the Commission, file pursuant to Rule 214 of the Commission's procedural Rules (18 CFR 385.214) a motion to intervene or notice of intervention and pursuant to § 157.205 of the Regulations under the Natural Gas Act (18 CFR 157.205) a protest to the request. If no protest is filed within the time allowed therefore, the proposed activity shall be deemed to be authorized effective the day after the time allowed for filing a protest. If a protest is filed and not withdrawn within 30 days after the time allowed for filing a protest, the instant request shall be treated as an application for authorization pursuant to section 7 of the Natural Gas Act.

Lois D. Cashell,

Secretary.

[FR Doc. 91-17741 Filed 7-25-91; 8:45 am]

BILLING CODE 6717-01-M

Change of Name or Address Filings

July 19, 1991.

Parties to a proceeding who want to notify the Commission and other parties of a change of name or address for a person listed on an official service list are directed to provide this notification in a letter which is separate from any pleading which is being filed with the Commission. Under 18 CFR 385.2010(c)(2), such notice must also be served on all parties to all relevant dockets. The notification of the change should include a list of docket numbers for all proceedings whose records must be corrected to reflect this change. Providing this notice by separate letter

and providing a list of relevant docket numbers will allow the Commission to take note of such changes promptly and to update its records accordingly. Only an original of the letter and one copy will be required for filing. The copy will be returned to the filer to confirm the changes were made.

Lois D. Cashell,

Secretary.

[FR Doc. 91-17738 Filed 7-25-91; 8:45 am]

BILLING CODE 6717-01-M

[Docket No. PL91-2-000]

Pipeline Rates: Gathering; Interstate Natural Gas Pipeline Rate Design, Policy Statement With Respect to the Recovery of Gathering Costs

Before Commissioners: Martin L. Allday, Chairman; Charles A. Trabandt, Elizabeth Anne Moler, Jerry J. Langdon and Branko Terzic.

Issued July 22, 1991.

An issue concerning the recovery of gathering costs has arisen in several litigated cases currently pending before the Commission. In particular, the question is whether the Commission will use the same test to determine the cost of service and rate design treatment applicable to gathering facilities as it uses to determine whether the Commission has certificate jurisdiction over these facilities. In this policy statement the Commission is providing guidance to the parties on the Commission's current view as to the relationship of the tests used to make these three decisions.

In litigated cases,¹ the parties' concern with the categorization of facilities as either gathering or transmission is a result of the four step process that the Commission has traditionally used to design rates. In the first step ("functionalization"), the pipeline's costs are divided between its major operations or functions, such as transmission, production, and storage. In the second step ("classification"), the costs for each function are classified as either fixed (that do not vary with the volume of gas moved) or variable, and then are further classified as demand or commodity costs, depending upon the type of rate design method used. The third step ("allocation") is to apportion the cost of service between the pipeline's services (jurisdictional and nonjurisdictional) and among its classes of customers or zones. The fourth step ("rate design"), involves the determination of the unit rates for each service provided under the pipeline's rate schedules. Since the Commission has traditionally allowed pipelines to recover gathering costs only in the commodity rate, a pipeline had to show in step one that the function of the facilities in question was transmission in order to recovery through a demand

¹ The form of recovery of gathering costs is an issue in the initial decisions issued in Trunkline Gas Company, 41 FERC ¶ 63,011 (1987), and Northwest Pipeline Corporation, 53 FERC ¶ 63,024 (1990). This issue also arises in the context of contested settlements filed by Panhandle Eastern Pipe Line Company on July 5, 1990, in Docket No. RP90-103-000, and by Williams Natural Gas Company on July 9, 1990, in Docket No. RP89-183-000. This issue also was originally present in the Colorado Interstate Gas Company (CIG) proceeding in Docket No. RP90-89-000. However, CIG has recently filed a settlement which seeks to resolve this issue.

charge any of the costs arising from those facilities.

It is unnecessary to have a rate policy concerning gathering/production area facilities turn on jurisdictional considerations since under sections 4 and 5 of the Natural Gas Act the Commission has jurisdiction over rates and charges "collected by any natural-gas company in connection with any transportation or sale of natural gas, subject to the jurisdiction of the Commission,"¹⁵ including the costs of pipeline facilities that might be gathering under section 1(b) of the Act. In fact, section 5(b) specifically authorizes the Commission to ascertain the cost of "the production or transportation of natural gas by a natural-gas company in cases where the Commission has no authority to establish a rate governing the transportation or sale of such natural gas."¹⁶ Thus, designing the method of cost recovery for facilities used in connection with jurisdictional service need not turn on whether the facilities are gathering or transmission under section 1(b) of the Act and thus subject to certificate and abandonment requirements of section 7 of the Act.¹⁷ For these reasons, the jurisdictional tests set out in *Farmland Industries, Inc.*¹⁸ will no longer control the rate treatment for a pipeline's gathering or production area facilities.¹⁹

However, there continues to be a need to categorize a pipeline's facilities in a rate case in order to determine the applicable depreciation rate and other elements of the cost of service for a particular facility that will be allowed in

the rates for jurisdictional service.²⁰ The Commission will functionalize the facility as either gathering or transmission as it has always done.²¹ For example, since the expected life of the reserves attached to the facility is the most relevant factor for determining the depreciation rate, the Commission in a rate case will continue to functionalize the facility as gathering or transmission by examining whether it serves only a localized source of supply or a broader regional source of supply. In functionalizing the facility as gathering or transmission, the Commission may also consider pattern of usage and physical factors incorporated in the modified Farmland jurisdictional test such as size and configuration of the facilities, although the conclusion may not be the same.

The Commission hereby gives notice that it intends to apply the principle established in this policy statement in future proceedings involving the recovery of gathering costs. Thus, in litigating cases, parties should not argue whether particular facilities are gathering or transmission under modified Farmland on the assumption that this determination will control the rate treatment accorded those facilities. Rather, parties should consider what rate treatment should be applied to gathering facilities to further the objectives of the Commission's rate design policies. If a party proposes that the costs of particular gathering facilities should be recovered by a method different than the historical one, that party should prepare a record that shows the impact of the proposed change on the pipeline's customers.²² Any person that wants to comment on this statement of policy may file a request for rehearing under 18 CFR 385.713.

By the Commission.

Lois D. Cashell,

Secretary.

[FR Doc. 91-17742 Filed 7-25-91; 8:45 am]

BILLING CODE 6717-01-W

¹⁵ The depreciation expense is the major element of the cost of service that is affected by the functionalization of facilities as gathering or transmission. Other elements of the cost of service that are affected by the functionalization are the allocation of administrative and general costs, and of taxes other than income taxes, between gathering and transmission.

¹⁶ The Uniform System of Accounts requires facilities to be functionalized as either "gathering" or "transmission."

¹⁷ See *Interstate Natural Gas Pipeline Rate Design, et al.*, 47 FERC ¶ 61,295 at 62,015 (1989).

Office of Conservation and Renewable Energy

[Case No. F-033]

Energy Conservation Program for Consumer Products; Application for Interim Waiver and Petition for Waiver of Furnace Test Procedures From Armstrong Air Conditioning, Inc.

AGENCY: Office of Conservation and Renewable Energy, Department of Energy.

SUMMARY: Today's notice publishes a letter granting an Interim Waiver to Armstrong Air Conditioning, Inc. (Armstrong) from the existing Department of Energy (DOE) test procedures for furnaces regarding blower time delay for the company's EG8G gas furnace.

Today's notice also publishes a "Petition for Waiver" from Armstrong. Armstrong's Petition for Waiver requests DOE to grant relief from the DOE test procedures relating to the blower time delay specification. Armstrong seeks to test using a blower delay time of 30 seconds for its EG8G gas furnace instead of the specified 1.5-minute delay between burner on-time and blower on-time. DOE is soliciting comments, data, and information respecting the Petition for Waiver.

DATES: DOE will accept comments, data, and information not later than August 26, 1991.

ADDRESSES: Written comments and statements shall be sent to: Department of Energy, Office of Conservation and Renewable Energy, Case No. F-033, Mail Stop CE-90, room 6B-025, Forrestal Building, 1000 Independence Avenue SW., Washington, DC 20585, (202) 586-3012.

FOR FURTHER INFORMATION CONTACT:

Cyrus H. Nasser, U.S. Department of Energy, Office of Conservation and Renewable Energy, Mail Station CE-43, Forrestal Building, 1000 Independence Avenue SW., Washington, DC 20585, (202) 586-9127.
Eugene Margolis, Esq., U.S. Department of Energy, Office of General Counsel, Mail Station GC-41, Forrestal Building, 1000 Independence Avenue SW., Washington, DC 20585, (202) 586-9507.

SUPPLEMENTARY INFORMATION: The Energy Conservation Program for Consumer Products (other than automobiles) was established pursuant to the Energy Policy and Conservation Act (EPCA), Public Law 94-163, 89 Stat. 917, as amended by the National Energy Conservation Policy Act (NECPA),

¹⁵ 15 U.S.C. 717d(a) (emphasis added).

¹⁶ 15 U.S.C. 717d(b).

¹⁷ See *Northern Natural Gas Company*, 43 FERC ¶ 61,473 (1988), *reh'g denied*, 44 FERC ¶ 61,384 (1988); *affirmed*, 929 F.2d 1261 (8th Cir. 1991), *petition for cert. filed* (July 2, 1991) (No. 91-14).

¹⁸ 23 FERC ¶ 61,663 (1983). In *Farmland*, the Commission held that, for purposes of determining whether a particular facility is exempt from the Commission's jurisdiction under section 1(b) of the Natural Gas Act, the ultimate test of how a facility should be classified is whether the primary function of the facility is transportation or gathering. The Commission then listed five factors that it would consider in determining the primary function of the facility: (1) The diameter and length of the facility; (2) the location of compressors and processing plants; (3) the extension of the facility beyond the central point in the field; (4) the location of wells along all or part of the facility; and (5) the geographical configuration of the system.

¹⁹ The Commission will no longer use the *Farmland* tests for rate design purposes as those tests are currently structured. In the context of the remand required by the court in *EP Operating Co. v. FERC*, 876 F.2d 46 (5th Cir. 1989), the Commission has reformulated those tests as applied to questions of jurisdiction. *Amerada Hess Corporation, et al.*, 52 FERC ¶ 61,286 (1990).

Public Law 95-619, 92 Stat. 3266, the National Appliance Energy Conservation Act of 1987 (NAECA), Public Law 100-12, and the National Appliance Energy Conservation Amendments of 1988 (NAECA 1988), Public 100-357, which requires DOE to prescribe standardized test procedures to measure the energy consumption of certain consumer products, including furnaces. The intent of the test procedures is to provide a comparable measure of energy consumption that will assist the consumer in making purchasing decisions. These test procedures appear at 10 CFR part 430, subpart B.

DOE amended the prescribed test procedures by adding 10 CFR 430.27 on September 26, 1980, creating the waiver process. 45 FR 64108. Thereafter DOE further amended the appliance test procedure waiver process to allow the Assistant Secretary for Conservation and Renewable Energy (Assistant Secretary) to grant an Interim Waiver from test procedure requirements to manufacturers that have petitioned DOE for a waiver of such prescribed test procedures. 51 FR 42823, November 26, 1986.

The waiver process allows the Assistant Secretary to waive temporarily test procedures for a particular basic model when a petitioner shows that the basic model contains one or more design characteristics which prevent testing according to the prescribed test procedures or when the prescribed test procedures may evaluate the basic model in a manner so unrepresentative of its true energy consumption as to provide materially inaccurate comparative data. Waivers generally remain in effect until final test procedure amendments become effective, resolving the problem that is the subject of the waiver.

The interim waiver provisions added by the 1986 amendment allow the Assistant Secretary to grant an Interim Waiver when it is determined that the applicant will experience economic hardship if the Application for Interim Waiver is denied, if it appears likely that the Petition for Waiver will be granted, and/or the Assistant Secretary determines that it would be desirable for public policy reasons to grant immediate relief pending a determination on the Petition for Waiver. An Interim Waiver remains in effect for a period of 180 days or until DOE issues its determination on the Petition for Waiver, whichever is sooner, and may be extended for an additional 180 days, if necessary.

On December 14, 1990, Armstrong filed an Application for an Interim Waiver regarding blower time delay.

Armstrong's Application seeks an Interim Waiver from the DOE test provisions that require a 1.5-minute time delay between the ignition of the burner and starting of the circulating air blower. Instead, Armstrong requests that allowance to test using a 30-second blower time delay when testing its EG8G gas furnace. Armstrong states that the 30-second delay is indicative of how these furnaces actually operate. Such a delay results in an energy savings of approximately 0.6 percent. Since current DOE test procedures do not address this variable blower time delay, Armstrong asks that the Interim Waiver be granted.

Previous waivers for this type of timed blower delay control have been granted by DOE to Coleman Company, 50 FR 2710, January 13, 1985; Magic Chef Company, 50 FR 41553, October 11, 1985; Rheem Manufacturing Company, 53 FR 48574, December 1, 1988, and 55 FR 3253, January 31, 1990; Trane Company, 54 FR 19226, May 4, 1989, and 55 FR 41589, October 12, 1990; DMO Industries, 55 FR 4004, February 6, 1990; Heil-Quaker Corporation, 55 FR 13184, April 9, 1990; Carrier Corporation, 55 FR 13182, April 9, 1990; Amana Refrigeration Inc., 56 FR 853, January 9, 1991; Armstrong Air Conditioning, Inc., 56 FR 10553, March 13, 1991; and Snyder General Corporation, 56 FR 14511, April 10, 1991. Thus, it appears likely that the Petition for Waiver will be granted for blower time delay.

In those instances where the likely success of the Petition for Waiver has been demonstrated based upon DOE having granted a waiver for a similar product design, it is in the public interest to have similar products tested and rated for energy consumption on a comparable basis.

Therefore, based on the above, DOE is granting Armstrong an Interim Waiver for its EG8G series of gas furnaces. Pursuant to paragraph (e) of § 430.27 of the Code of Federal Regulations, the following letter granting the Application for Interim Waiver to Armstrong Air Conditioning Inc., was issued.

Pursuant to paragraph (b) of 10 CFR 430.27, DOE is hereby publishing the "Petition for Waiver" in its entirety. The petition contains no confidential information. DOE solicits comments, data, and information respecting the petition.

Issued in Washington, DC, July 22, 1991.

J. Michael Davis,
Assistant Secretary, Conservation and Renewable Energy.
December 14, 1990

United States Department of Energy, 1000 Independence Avenue, SW, Washington, D.C. 20585

Gentlemen: This is a petition for waiver and petition for interim waiver submitted pursuant to 10 CFR 430.27. Waiver is requested from the Furnace test procedure found at appendix N to subpart B of part 430.

The test procedure requires a 1.5 minute delay between burner on and blower on. Armstrong is requesting authorization to use a 30 second delay instead of 1.5 minutes. Armstrong is manufacturing a series of induced draft furnaces which include the EG8G Horizontal Gas furnaces used for residential installations.

Maximum energy efficiency is achieved by fixed timing controls installed in the EG8G series that activate the circulating air blower 30 seconds after the burner is on.

Under the appendix N procedures, the vent gas temperature climbs at a faster rate than it would with a 30 second blower on time, allowing energy to be lost out the vent system. This waste of energy would not occur in actual operation. If this petition is granted, the true blower on time delay would be used in the calculations. Proposed ASHRAE Standard 103-1988 paragraph 9.5.1.2.2 specifically advances the use of timed blower operation.

The current test procedures does not give Armstrong credit for the energy savings which average approximately .8 percentage points on our A.F.U.E. test results.

Current prescribed test procedures prohibit Armstrong from taking credit for the saved energy, thus providing inaccurate comparative data.

Armstrong has been granted a waiver permitting the 20 second blower on time to be used in efficiency calculations for our Ultra series furnaces (Case Number-F-014) dated October 1985.

Several other manufacturers of furnaces have been granted a waiver to permit calculations based on timed blower operation.

Confidential comparative test data is available to you upon your request.

Sincerely,

ARMSTRONG AIR CONDITIONING INC.,

Bruce R. Maike,

Vice President Product Engineering.

JULY 22, 1991.

Mr. Bruce R. Maike

*Vice President Product Engineering,
Armstrong Air-Conditioning, Inc., 421
Monroe Street, Bellevue, Ohio 44811*

Dear Mr. Maike: This is in response to your December 14, 1990, Application for Interim Waiver and Petition for Waiver from the Department of Energy (DOE) test procedures for furnaces regarding blower time delay for the Armstrong Air Conditioning Inc. (Armstrong) EG8G gas furnace.

Previous waivers for timed blower delay control have been granted by DOE to Coleman Company, 50 F.R. 2710, January 13, 1985; Magic Chef Company, 50 F.R. 41553, October 11, 1985; Rheem Manufacturing Company, 53 F.R. 48574, December 1, 1988, and 55 F.R. 3253, January 31, 1990; Trane Company, 54 F.R. 19226, May 4, 1989, and 55 F.R. 4004, February 6, 1990; Heil-Quaker

Corporation, 55 F.R. 13184, April 9, 1990; Carrier Corporation, 55 F.R. 13182, April 9, 1990; Amana Refrigeration Inc., 56 F.R. 853, January 9, 1991; Armstrong Air Conditioning, Inc., 56 F.R. 10553, March 13, 1991; and Snyder General Corporation, 56 F.R. 14511, April 10, 1991.

Armstrong's Application for Interim Waiver does not provide sufficient information to evaluate what, if any economic impact or competitive disadvantage Armstrong will likely experience absent a favorable determination on its application. However, in those instances where the likely success of the Petition for Waiver has been demonstrated, based upon DOE having agreed a waiver for a similar product design, it is in the public interest to have similar products tested and rated for energy consumption on the comparable basis.

Therefore, Armstrong's Application for an Interim Waiver from the DOE test procedures for its EG&G gas furnace regarding blower time delay is granted.

Armstrong shall be permitted to test its line of EG&G gas furnace on the basis of the test procedures specified in 10 CFR part 430, Subpart B, Appendix N, with the modification set forth below.

(i) Section 3.0 in Appendix N is deleted and replaced with the following paragraph:

3.0 Test Procedure. Testing and measurements shall be as specified in section 9 in ANSI/ASHRAE 103-82 with the exception of sections 9.2.2, 9.3.1, and 9.3.2, and the inclusion of the following additional procedures:

(ii) Add a new paragraph 3.10 in Appendix N as follows:

3.10 Gas- and Oil-Fueled Central Furnaces. After equilibrium conditions are achieved following the cool-down test and the required measurements performed, turn on the furnace and measure the flue gas temperature, using the thermocouple grid described above, at 0.5 and 2.5-minutes after the main burner(s) comes on. After the burner start-up, delay the blower start-up by 1.5-minutes (-), unless: (1) the furnace employs a single motor to drive the power burner and the indoor air circulation blower, in which case the burner and blower shall be started together; or (2) the furnace is designed to operate using an unvarying delay time that is other than 1.5-minutes, in which case the fan control shall be permitted to start the blower, or (3) the delay time results in the activation of a temperature safety device which shuts off the burner, in which case the fan control shall be permitted to start the blower. In the latter case, if the fan control is adjustable, set it to start the blower at the highest temperature. If the fan control is permitted to start the blower, measure time delay, (-), using a stop watch. Record the measured temperatures. During the heat-up test for oil-fueled furnaces, maintain the draft in the flue pipe with ± 0.01 inch of water gauge of the manufacturer's recommended on-period draft.

This Interim Waiver is based upon the presumed validity of statements and all allegations submitted by the company. This Interim Waiver may be revoked or modified at any time upon a determination that the factual basis underlying the application is correct.

The Interim Waiver shall remain in effect for a period of 180 days or until DOE acts on the Petition for Waiver, whichever is sooner, and may be extended for an additional 180-day period, if necessary.

Sincerely,

J. Michael Davis,

Assistant Secretary, Conservation and Renewable Energy.

[FR Doc. 91-17803 Filed 7-25-91; 8:45 am]

BILLING CODE 6450-01-M

Office of Fossil Energy

[FE Docket No. 91-23-NG]

Puget Sound Power & Light Co.; Order Granting Authorization to Import Canadian Natural Gas and Granting Intervention

AGENCY: Office of Fossil Energy, Department of Energy.

ACTION: Notice of an order granting authorization to import Canadian natural gas and granting intervention.

SUMMARY: The Office of Fossil Energy of the Department of Energy gives notice that it has issued an order granting Puget Sound Power & Light Company (Puget) authorization to import up to 50 Bcf of natural gas over two-years beginning with the date of first import.

A copy of this order is available for inspection and copying in the Office of Fuels Programs Docket Room, 3F-056, Forrestal Building, U.S. Department of Energy, 1000 Independence Avenue, SW., Washington, DC 20585, (202) 586-9478. The docket room is open between the hours of 8 a.m. and 4:30 p.m., Monday through Friday, except Federal holidays.

Issued in Washington, DC, July 22, 1991.

Clifford P. Tomaszewski,

Acting Deputy Assistant Secretary for Fuels Programs, Office of Fossil Energy.

[FR Doc. 91-17802 Filed 7-25-91; 8:45 am]

BILLING CODE 6450-01-M

ENVIRONMENTAL PROTECTION AGENCY

[FRL 3978-1]

Proposed Settlement; "Top-Down" BACT Litigation

AGENCY: Environmental Protection Agency (EPA).

ACTION: Notice of proposed settlement; request for public comment.

SUMMARY: In accordance with section 113(g) of the Clean Air Act ("Act"), notice is hereby given of a proposed settlement of the following cases:

American Paper Inst. v. Reilly, No. 90-1364 (D.C. Cir.); and *American Paper Inst. v. Reilly*, No. 89-1428 and consolidated case (D.C. Cir.); *American Paper Inst. v. Reilly*, No. 89-2030 (D.D.C.). (The proposed settlement also addresses an administrative petition filed with EPA by the Utility Air Regulatory Group.) These cases involved challenges to the "top-down" process for determining best available control technology under the prevention of significant deterioration provisions of the Clean Air Act, 42 U.S.C. 7475.

For a period of thirty (30) days following the date of publication of this notice, the Agency will receive written comments relating to the settlement from persons who were not named as parties to the litigation in question. EPA or the Department of Justice may withhold or withdraw consent to the proposed settlement if the comments disclose facts or circumstances that indicate that such consent is inappropriate, improper, inadequate, or inconsistent with the requirements of the Act.

A copy of the settlement has been lodged with the Clerks of the United States Court of Appeals for the District of Columbia Circuit and the United States District Court for the District of Columbia. Copies of the settlement are also available from Jill E. Grant, Air and Radiation Division (LE-132A), Office of General Counsel, U.S. Environmental Protection Agency, 401 M Street SW., Washington, DC 20480, (202) 245-4149. Written comments should be sent to Jill E. Grant at the above address and must be submitted on or before August 26, 1991.

Dated: July 15, 1991.

E. Donald Elliott,

Assistant Administrator and General Counsel.

[FR Doc. 91-17795 Filed 7-25-91; 8:45 am]

BILLING CODE 6560-50-M

(ER-FRL-3978-6)

Environmental Impact Statements; Availability

Responsible Agency

Office of Federal Activities, General Information, (202) 382-5073 or (202) 382-5075. Availability of Environmental Impact Statements filed July 15, 1991 through July 19, 1991 pursuant to 40 CFR 1506.9.

EIS No. 910232, Draft EIS, BLM, CA

Eagle Mountain Class III Nonhazardous Solid Waste Landfill Project and Specific Plan, Federal Land

Exchange, Right-of-Way Approval, section 404 permit, Riverside County, CA. Due: September 24, 1991, Contract: Marianne Wetzel, (619) 323-4421.

EIS No. 910233, Final EIS, FHW, IL

FAP 302 (formerly FAP 407)/IL-336 Construction, US 24 at Quincy to US 136 at Carthage, funding and section 404 permit, Adams and Hancock Counties, IL. Due: August 26, 1991. Contact: Jay W. Miller, (217) 492-4600.

EIS No. 910234, Final EIS, AFS, CA

Kings River Special Management Area (SMA), South Fork, Middle Fork, Kings Wild and Scenic Rivers Development and Management, Implementation Plan, Sierra and Sequoia National Forests, King Rivers Ranger and Hume Lake Ranger Districts, Fresno County, CA. Due: August 26, 1991. Contact: Wallace McCray, (209) 487-5155.

EIS No. 910235, Final EIS, AFS, CO

Divide Creek Unit Coal-Bed Methane Project, Continued Development, Leasing, section 404 permit, White River National Forest, Garfield and Mesa Counties, CO. Due: September 3, 1991. Contact: Gary Osier, (303) 945-2521.

EIS No. 910236, Draft EIS, AFS, WA

Calypso Planning Area (commonly called Bourbon Roadless Area) Timber Sales, Implementation, Wind River Ranger District, Gifford Pinchot National Park, Skamania County, WA. Due: September 9, 1991. Contact: Karl Buermeyer, (509) 427-5645.

EIS No. 910237, Final EIS, AFS, MT

East Fortine Timber Sales and Road Construction, Implementation, Kootenai National Forest, Fortine Ranger District, Lincoln County, MT. Due: August 26, 1991. Contact: Thomas Puchlerz, (406) 882-4551.

EIS No. 910238, Draft, AFS, NB

Bessey Nursery Pest Control Management Plan, Implementation, Nebraska National Forest, Rocky Mountain Region, Thomas County, NB. Due: September 9, 1991. Contact: Sally Campbell, (503) 326-7755.

EIS No. 910239, Draft EIS, AFS, CO, KS, CO

Pike and San Isabel National Forests/Comanche and Cimarron National Grasslands Oil and Gas Exploration and Development, Leasing, Several Counties, CO and KS. Due: September 9, 1991. Contact: Ms. Logan Lee, (719) 545-8737.

EIS No. 910240, Final EIS, CDB, NY

Rochester City School Districts Carthage School #8 Replacement

Project, Construction and Operation, New Information, CDB Grant, City of Rochester, Monroe County, NY. Due: August 26, 1991. Contact: Robert Barrows, (716) 428-6924.

Amended Notices

EIS No. 910176, Draft EIS, SFW, CA

Stone Lakes National Wildlife Refuge Management Plan, Land Acquisition and Easement, Possible COE section 10 and 404 permits, Central Valley, Sacramento County, CA. Due: September 1, 1991. Contact: Peter Jerome, (916) 978-4420.

Published FR 06-07-91—Review period extended.

EIS No. 910201, Draft EIS, FAA, AZ

Phoenix Sky Harbor International Airport Master Plan Update Improvements, Runway 8L/26R Extension, Funding, City of Phoenix, Maricopa County, AZ. Due: September 19, 1991. Contact: David Kessler, (213) 297-1534.

Published FR 06-21-91—Review period extended.

Dated: July 23, 1991.

William D. Dickerson,
Deputy Director, Office of Federal Activities.

[FR Doc. 91-17796 Filed 7-25-91; 8:45 am]

BILLING CODE 6560-50-M

[ER-FRL-3879-7]

Environmental Impact Statements and Regulations; Availability of EPA Comments

Availability of EPA comments prepared July 8, 1991 through July 12, 1991 pursuant to the Environmental Review Process (ERP), under section 309 of the Clean Air Act and section 102(2)(c) of the National Environmental Policy Act as amended. Requests for copies of EPA comments can be directed to the Office of Federal Activities at (202) 382-5076.

An explanation of the ratings assigned to draft environmental impact statements (EISs) was published in FR dated April 5, 1991 (56 FR 14096).

Draft EISs

ERP No. D-AFS-L61192-AK Rating LO

Crystal Mountain Communication Site, Designation/Nondesignation, Tongass National Forest, Stikine Area, AK.

Summary

EPA has no objections to the proposed project. However, it cannot be conclusively demonstrated that exposure of the population to radio frequency radiation is without risk.

Commitment should be made to exclude the public, by fencing and posting any areas which could exceed American National Standards Institute guideline levels.

ERP No. D-AFS-L65146-ID Rating EC2

Van Camp Timber Sales and Winter Range Improvements, Road Construction/Reconstruction, Implementation, Clearwater National Forest, Lochsa Ranger District, Idaho County, ID.

Summary

EPA has environmental concerns that are based on the potential for adverse air quality effects on a mandatory Class I airshed. Additional information is needed to describe project monitoring, the effectiveness of proposed mitigation measures, and describe the effects of the project on biodiversity.

ERP No. D-COE-E32074-KY Rating EC2

Lower Cumberland and Tennessee Rivers Navigation Improvements, Kentucky Lock Addition, Implementation, Nashville District, Marshall and Livingston Counties, KY.

Summary

EPA has environmental concerns regarding the potential loss of two species of endangered mussels due to direct construction activities and losses resulting from indirect causes attendant to operating the new lock. Additional information is requested in the final EIS on this wetland and mitigation, and other issues.

ERP No. D-USA-K11047-00 Rating EC2

Fort Wingate Depot and Navajo Depot Activity Closures, Realignment of Umatilla Depot Activity with transfers to Hawthorne Army Ammunition Plant, Mineral County, NV; McKinley County, NM; Coconino County, AZ; Morrow and Umatilla Counties, OR.

Summary

EPA urged the Army to consider the preparation of EISs for future base reuse plans, to consider transferring lands with existing natural resource values to resource agencies such as the Fish and Wildlife Service, and to include Federal and State agencies in the base reuse planning process due to the complex hazardous waste cleanup problems that exist at many defense bases. EPA noted that base closure and realignment actions should not interfere with the assessment and remediation of hazardous substances contamination at the facilities.

ERP No. DS-COE-E34010-MS Rating EC2

Arkabutla, Enid, Grenda and Sardis Lake, Operation and Maintenance, Channel Restoration on the Tallatchie River and Yalobusha River, MS.

Summary

EPA has environmental concerns about the long-term consequences of this action in terms of its flood control effectiveness and its impact on existing wetland functions within the project reaches.

FINAL EISs**ERP No. F-AFS-L61183-WA**

White Pass Ski Area Expansion, Special Use Permit, Wenatchee and Gifford Pinchot National Forests, Lewis and Yakima Counties, WA.

Summary

EPA has no objections to the proposed action.

ERP No. F-BLM-K00001-00

Ward Valley Low-Level Radioactive Waste Disposal Facility, Site Selection, Construction and Operation, Funding and Right-of-Way Grants, San Bernardino County, CA.

Summary

EPA commended BLM and the California Health Department for modifying the vadose zone monitoring plan at the site. EPA requested that the Record of Decision contain a commitment to work with State agencies having jurisdiction over groundwater and air quality as well as with the U.S. Fish and Wildlife Service, and for BLM to work with generators of low level radioactive waste to reduce the volume of waste.

ERP No. F-BLM-K67011-NV

Betze Open Pit Gold Mine Expansion, Implementation, Elko and Eureka Counties, NV.

Summary

EPA noted that the final EIS adequately addressed the concerns which EPA raised on the draft EIS.

ERP No. F-MMS-L02018-AK

Navarin Basin Outer Continental Shelf (OCS) Oil and Gas Sale No. 107, Leasing, Bering Sea, AK.

Summary

EPA continues to have environmental concerns with the proposed action due to the uncertainty about the long-term disturbance effects (during development and production) on endangered right whales, Stellar sea lions, and Northern

fur seals. The proposed action includes lease tracks in the vicinity of feeding areas for right whales and rookery and haul-out areas for Stellar sea lions.

ERP No. F-SCS-K36099-CA

McCoy Wash Watershed, Flood Prevention Plan, Implementation, section 404 permit, Riverside County, CA.

Summary

Review of the final EIS was not deemed necessary. No formal letter was sent to the agency.

REGULATIONS**ERP No. R-DOI-A20028-00**

43 CFR part 11; Natural Resource Damage Assessments, Revision (56 FR 19752).

Summary

EPA considers the revisions of the rule an improvement of previously promulgated regulations. Several minor suggestions were offered to further improve the proposed rule.

Dated: July 23, 1991.

William D. Dickerson,

Deputy Director, Office of Federal Activities.

[FR Doc. 91-17797 Filed 7-25-91; 8:45 am]

BILLING CODE 6560-50-M

FEDERAL MARITIME COMMISSION**Agreement(s) Filed; Brazil, et al.**

The Federal Maritime Commission hereby gives notice of the filing of the following agreement(s) pursuant to section 5 of the Shipping Act of 1984.

Interested parties may inspect and obtain a copy of each agreement at the Washington, DC Office of the Federal Maritime Commission, 1100 L Street NW., room 10325. Interested parties may submit comments on each agreement to the Secretary, Federal Maritime Commission, Washington, DC 20573, within 10 days after the date of the Federal Register in which this notice appears. The requirements for comments are found in § 572.803 of title 46 of the Code of Federal Regulations. Interested persons should consult this section before communicating with the Commission regarding a pending agreement.

Agreement No.: 212-010027-031.

Title: Brazil/U.S. Atlantic Coast Agreement.

Parties:

Companhia de Navegacao Lloyd Brasileiro,

Companhia de Navegacao Maritima Netumar,

Companhia Maritima Nacional, American Transport Lines, Inc., Empresa Lineas Maritimas Argentinas, S.A., A. Bottacchi S.A. de Navegacion C.F.I.I.

Synopsis: The proposed amendment would add provisions to the Agreement permitting space chartering between or among the parties and cooperation in the rationalization of sailings. It would also permit any party to withdraw effective October 1, 1991, by giving 30 days' prior notice.

Agreement No.: 207-011339.

Title: Empremar/MSC Agreement.

Parties:

Mediterranean Shipping Co., S.A. Empremar S.A.

Synopsis: The proposed Agreement would authorize the parties to operate a joint service and pool profits in the trade between U.S. Atlantic and Gulf Coast ports and ports and points in Columbia, Ecuador, Peru and Chile; and intransit cargo to Bolivia via ports in Peru or Chile.

Dated: July 22, 1991.

By Order of the Federal Maritime Commission.

Joseph C. Polking,

Secretary.

[FR Doc. 91-17756 Filed 7-25-91; 8:45 am]

BILLING CODE 6730-01-M

FEDERAL RESERVE SYSTEM**Garwin Bancorporation; Acquisition of Company Engaged in Permissible Nonbanking Activities**

The organization listed in this notice has applied under § 225.23(a)(2) or (f) of the Board's Regulation Y (12 CFR 225.23(a)(2) or (f)) for the Board's approval under section 4(c)(8) of the Bank Holding Company Act (12 U.S.C. 1843(c)(8)) and § 225.21(a) of Regulation Y (12 CFR 225.21(a)) to acquire or control voting securities or assets of a company engaged in a nonbanking activity that is listed in § 225.25 of Regulation Y as closely related to banking and permissible for bank holding companies. Unless otherwise noted, such activities will be conducted throughout the United States.

The application is available for immediate inspection at the Federal Reserve Bank indicated. Once the application has been accepted for processing, it will also be available for inspection at the offices of the Board of Governors. Interested persons may express their views in writing on the question whether consummation of the

proposal can "reasonably be expected to produce benefits to the public, such as greater convenience, increased competition, or gains in efficiency, that outweigh possible adverse effects, such as undue concentration of resources, decreased or unfair competition, conflicts of interests, or unsound banking practices." Any request for a hearing on this question must be accompanied by a statement of the reasons a written presentation would not suffice in lieu of a hearing, identifying specifically any questions of fact that are in dispute, summarizing the evidence that would be presented at a hearing, and indicating how the party commenting would be aggrieved by approval of the proposal.

Comments regarding the application must be received at the Reserve Bank indicated or the offices of the Board of Governors not later than August 14, 1991.

A. Federal Reserve Bank of Chicago (David S. Epstein, Vice President) 230 South LaSalle Street, Chicago, Illinois 60690:

1. *Garwin Bancorporation*, Garwin, Iowa; to acquire Garwin Insurance Agency, Garwin, Iowa, and thereby engage in operating a general insurance agency in a town with a population of less than 5,000 pursuant to § 225.25(b)(8)(iii)(A) of the Board's Regulation Y.

Board of Governors of the Federal Reserve System, July 22, 1991.

Jennifer J. Johnson,

Associate Secretary of the Board.

[FR Doc. 91-17748 Filed 7-25-91; 8:45 am]

BILLING CODE 6210-01-F

Midland Financial Corporation; Formation of, Acquisition by, or Merger of Bank Holding Companies

The company listed in this notice has applied for the Board's approval under section 3 of the Bank Holding Company Act (12 U.S.C. 1842) and § 225.14 of the Board's Regulation Y (12 CFR 225.14) to become a bank holding company or to acquire a bank or bank holding company. The factors that are considered in acting on the applications are set forth in section 3(c) of the Act (12 U.S.C. 1842(c)).

The application is available for immediate inspection at the Federal Reserve Bank indicated. Once the application has been accepted for processing, it will also be available for inspection at the offices of the Board of Governors. Interested persons may express their views in writing to the Reserve Bank indicated for that

application or to the offices of the Board of Governors. Any comment on an application that requests a hearing must include a statement of why a written presentation would not suffice in lieu of a hearing, identifying specifically any questions of fact that are in dispute and summarizing the evidence that would be presented at a hearing.

Comments regarding this application must be received not later than August 14, 1991.

A. Federal Reserve Bank of Kansas City (Thomas M. Hoinig, Vice President) 925 Grand Avenue, Kansas City, Missouri 64198:

1. *Midland Financial Corporation*, Newton, Kansas; to become a bank holding company by acquiring at least 80 percent of the voting shares of Midland National Bank, Newton, Kansas.

Board of Governors of the Federal Reserve System, July 22, 1991.

Jennifer J. Johnson,

Associate Secretary of the Board.

[FR Doc. 91-17749 Filed 7-25-91; 8:45 am]

BILLING CODE 6210-01-F

DEPARTMENT OF HEALTH AND HUMAN SERVICES

Administration for Children and Families

Forms Submitted to the Office of Management and Budget for Clearance

The Administration for Children and Families' will publish on Fridays information collection packages submitted to the Office of Management and Budget (OMB) for clearance, in compliance with the Paperwork Reduction Act (44 U.S.C. Chapter 35). Following is the package submitted to OMB since the last publication. (For a copy of the package, call the FSA, Report Clearance Officer 202-401-5604)

Corrective Action Plan—0970-0027—Corrective Action Plans are a structured way for State agencies to plan, implement and evaluate corrective actions designed to reduce payment errors. The Office of Family Assistance reviews these plans to see whether they are sufficient and recommends additions and adjustments. Respondents: state and local governments, non-profit institutions; Number of Respondents: 13; Frequency of Response: summary from individual/case evaluation; Estimated Average Burden per Response: 160 hours; Estimated Annual Burden: 2,080 hours.

OMB Desk Officer: Laura Oliven.

Written comments and recommendations for the proposed information collection should be sent directly to the OMB Desk Officer designated above at the following address: OMB Reports Management Branch, New Executive Office Building, room 3201, 725 17th Street NW., Washington, DC 20503.

Dated: July 12, 1991.

Naomi B. Marr,

Associate Administrator, Office of Management and Information Systems.

[FR Doc. 91-17755 Filed 7-25-91; 8:45 am]

BILLING CODE 4150-04-M

Alcohol, Drug Abuse, and Mental Health Administration

Suspension of a Laboratory Which No Longer Meets Minimum Standards to Engage in Urine Drug Testing for Federal Agencies

AGENCY: National Institute on Drug Abuse, HHS.

ACTION: Notice.

SUMMARY: The Department of Health and Human Services routinely publishes in the Federal Register a list of laboratories currently certified to meet standards of subpart C of Mandatory Guidelines for Federal Workplace Drug Testing Programs (53 FR 11986) dated April 11, 1988. This notice informs the public that, effective July 23, 1991, the following laboratory's certification is suspended: Harris Medical Laboratory, P. O. Box 2981, 1401 Pennsylvania Avenue, Fort Worth, TX 76104, 817-878-5600

FOR FURTHER INFORMATION CONTACT: Drug Testing Section, Division of Applied Research, National Institute on Drug Abuse, Room 9-A-53, Telephone: 301-443-6014, 5600 Fishers Lane, Rockville, Maryland 20857.

Charles R. Schuster,

Director, National Institute on Drug Abuse.

[FR Doc. 91-17906 Filed 7-25-91; 8:45 am]

BILLING CODE 4160-20-M

Food and Drug Administration

[Docket No. 91N-0280]

Drug Export; Human T-Lymphotropic Virus Type I (HTLA-I)

AGENCY: Food and Drug Administration, HHS.

ACTION: Notice.

SUMMARY: The Food and Drug Administration (FDA) is announcing that Genetic Systems Corporation has

filed an application requesting approval for the export of the biological product Human T-Lymphotropic Virus, Type I (HTLV-I) to France.

ADDRESSES: Relevant information on this application may be directed to the Dockets Management Branch (HFA-305), Food and Drug Administration, Rm. 1-23, 12420 Parklawn Dr., Rockville, MD 20857, and to the contact person identified below. Any future inquiries concerning the export of human biological products under the Drug Export Amendments Act of 1986 should also be directed to the contact person.

FOR FURTHER INFORMATION CONTACT: Carl J. Chancey, Center for Biologics Evaluation and Research (HFB-124), Food and Drug Administration, 5600 Fishers Lane, Rockville, MD 20857, 301-295-8191.

SUPPLEMENTARY INFORMATION: The drug export provisions in section 802 of the Federal Food, Drug, and Cosmetic Act (the act) (21 U.S.C. 382) provide that FDA may approve applications for the export of biological products that are not currently approved in the United States. Section 802(b)(3)(B) of the act sets forth the requirements that must be met in an application for approval. Section 802(b)(3)(C) of the act requires that the agency review the application within 30 days of its filing to determine whether the requirements of section 802(b)(3)(B) have been satisfied. Section 802(b)(3)(A) of the act requires that the agency publish a notice in the Federal Register within 10 days of the filing of an application for export to facilitate public participation in its review of an application for export to facilitate public participation in its review of the application. To meet this requirement, the agency is providing notice that Genetic Systems Corporation, 6565 185th Avenue NE, Redmond, WA 98052, has filed an application requesting approval for the export of the biological product Human T-Lymphotropic Virus, Type I (HTLV-I) to France. The Human T-Lymphotropic Virus, Type I (HTLV-I) is an Enzyme Immunoassay (EIA) for the detection of circulating antibodies to Human T-Lymphotropic Virus, Type 1 (HTLV-1) in human serum or plasma. The application was received and filed in the Center for Biologics Evaluation and Research on June 18, 1991, which shall be considered the filing date for purposes of the act.

Interested persons may submit relevant information on the application to the Dockets Management Branch (address above) in two copies (except that individuals may submit single copies) and identified with the docket number found in brackets in the heading of this document. These submissions

may be seen in the Dockets Management Branch between 9 a.m. and p.m., Monday through Friday.

The agency encourages any person who submits relevant information on the application to do so by August 5, 1991, and to provide an additional copy of the submission directly to the contact person identified above, to facilitate consideration of the information during the 30-day review period.

This notice is issued under the Federal Food, Drug, and Cosmetic Act (section 802 (21 U.S.C. 382)) and under authority delegated to the Commissioner of Food and Drugs (21 CFR 5.10) and redelegated to the Center for Biologics Evaluation and Research (21 CFR 5.44).

Dated: July 18, 1991.

Thomas S. Bozzo,

Director, Office of Compliance, Center for Biologics Evaluation and Research.

[FR Doc. 91-17822 Filed 7-25-91; 8:45 am]

BILLING CODE 4160-01-M

[Docket No. 91N-0282]

Drug Export; Kenacort A-10 & A-40

AGENCY: Food and Drug Administration, HHS.

ACTION: Notice.

SUMMARY: The Food and Drug Administration (FDA) is announcing that Bristol-Myers Squibb Company has filed an application requesting approval for the export of the human drug Kenacort to Japan.

ADDRESSES: Relevant information on this application may be directed to the Dockets Management Branch (HFA-305), Food and Drug Administration, Rm. 1-23, 12420 Parklawn Dr., Rockville, MD 20857, and to the contact person identified below. Any future inquiries concerning the export of human drugs under the Drug Export Amendments Act of 1986 should also be directed to the contact person.

FOR FURTHER INFORMATION CONTACT: Thomas J. Schall, Division of Drug Labeling Compliance (HFD-313), Center for Drug Evaluation and Research, Food and Drug Administration, 5600 Fishers Lane, Rockville, MD 20857, 301-295-8073.

SUPPLEMENTARY INFORMATION: The drug export provisions in section 802 of the Federal Food, Drug, and Cosmetic Act (the act) (21 U.S.C. 382) provide that FDA may approve applications for the export of drugs that are not currently approved in the United States. Section 802(b)(3)(B) of the act sets forth the requirements that must be met in an application for approval. Section 802(b)(3)(C) of the act requires that the

agency review the application within 30 days of its filing to determine whether the requirements of section 802(b)(3)(B) have been satisfied. Section 802(b)(3)(A) of the act requires that the agency publish a notice in the Federal Register within 10 days of the filing of an application for export to facilitate public participation in its review of the application. To meet this requirement, the agency is providing notice that Bristol-Myers Squibb Company, P.O. Box 4000, Princeton, NJ 08543-4000, has filed an application requesting approval for the export of the drug Kenacort to Japan. This drug product is used in the treatment of allergies, dermatoses, and arthritides or other connective tissue disorders. The application was received and filed in the Center for Drug Evaluation and Research on July 3, 1991, which shall be considered the filing date for purposes of the act.

Interested persons may submit relevant information on the application to the Dockets Management Branch (address above) in two copies (except that individuals may submit single copies) and identified with the docket number found in brackets in the heading of this document. These submissions may be seen in the Dockets Management Branch between 9 a.m. and 4 p.m., Monday through Friday.

The agency encourages any person who submits relevant information on the application to do so by August 5, 1991, and to provide an additional copy of the submission directly to the contact person identified above, to facilitate consideration of the information during the 30-day review period.

This notice is issued under the Federal Food, Drug, and Cosmetic Act (sec. 802 (21 U.S.C. 382)) and under authority delegated to the Commissioner of Food and Drugs (21 CFR 5.10) and redelegated to the Center for Drug Evaluation and Research (21 CFR 5.44).

Dated: July 19, 1991.

Daniel L. Michels,

Director, Office of Compliance, Center for Drug Evaluation and Research.

[FR Doc. 91-17821 Filed 7-25-91; 8:45 am]

BILLING CODE 4160-01-M

Indian Health Service

Tribal Management Grant Program for American Indians/Alaska Natives: Technical Assistance Workshop Announcement.

AGENCY: Indian Health Service, HHS.

ACTION: Notice of technical assistance workshops for prospective IHS grantees.

SUMMARY: The Indian Health Service (IHS) announces that technical assistance workshops for the Tribal Management Grant Program to include grant proposal writing will be conducted for American Indian/Alaska Native Tribal Organizations as defined by Public Law 93-638, as amended.

DATES: Technical assistance workshops are scheduled for October 22-24, 1991, in Anchorage, Alaska; November 19-21, 1991, in Phoenix, Arizona; December 4-6, 1991, in Minneapolis, Minnesota; and December 10-12, 1991 in Oklahoma City, Oklahoma.

FOR FURTHER REGISTRATION

INFORMATION CONTACT: Beulah Bowman, Director, Division of Community Services, Office of Tribal Activities, Parklawn Building, room 6A-05, 5600 Fishers Lane, Rockville, Maryland 20857 (301) 443-6840; M. Kay Carpentier, Grants Management Officer, Division of Acquisition and Grants Operations, Twinbrook Building, suite 605, 12300 Twinbrook Parkway, Rockville, Maryland 20852 (301) 443-5204. (These are not toll-free numbers.)

SUPPLEMENTARY INFORMATION: The Office of Tribal Activities, Division of Community Services and the Division of Acquisition and Grants Operations, Grants Management Branch, will provide potential applicants an opportunity to receive technical assistance for Tribal Management including participation in grant writing workshops to assist applicants in developing and submitting competitive proposals. The purpose is to: (a) Establish communication between the IHS and the applicants, (b) determine the applicants eligibility, and (c) to provide technical assistance to increase the ability of an applicant to successfully compete. Applicants will prepare preapplications for constructive review and feedback during the workshop.

Dated: July 18, 1991.

Everett R. Rhoades,
Assistant Surgeon General, Director.

[FR Doc. 91-17720 Filed 7-25-91; 8:45 am]

BILLING CODE 4160-16-M

National Institutes of Health

National Cancer Institute; Notice of Meeting (Cancer Clinical Investigation Review Committee)

Pursuant to Pub. L. 92-463, notice is hereby given of the meeting of the

Cancer Clinical Investigation Review Committee, National Cancer Institute, National Institutes of Health, August 1-2, 1991, Holiday Inn Chevy Chase, 5520 Wisconsin Avenue, Chevy Chase, MD 20815.

This meeting will be open to the public on August 1 from 1 p.m. to 1:30 p.m. to discuss administrative details. Attendance by the public will be limited to space available.

In accordance with provisions set forth in secs. 552b(c)(4) and 552b(c)6, title 5, U.S.C. and sec. 10(d) of Public Law 92-463, the meeting will be closed to the public on August 1 from 1:30 p.m. to recess and on August 2 from 8 a.m. to adjournment for the review, discussion, and evaluation of individual grant applications. These applications and the discussions could reveal confidential trade secrets or commercial property such as patentable material and personal information concerning individuals associated with the proposals, disclosure of which would constitute a clearly unwarranted invasion of personal privacy.

Ms. Carole Frank, Committee Management Officer, National Cancer Institute, Building 31, room 10A06, National Institutes of Health, Bethesda, Maryland 20892, (301-496-5708), will provide a summary of meeting and a roster of committee members upon request.

Dr. Manuel Torres-Anjel, Scientific Review Administrator, Cancer Clinical Investigation Review Committee, 5333 Westbard Avenue, room 834, Bethesda, Maryland 20816, (301-496-7481), will furnish substantive program information.

This meeting notice is being published less than 15 days prior to the meeting due to the difficulty of coordinating the attendance of members because of conflicting schedules.

(Catalog of Federal Domestic Assistance Program Numbers: 93.393, Cancer Cause and Prevention Research; 93.394, Cancer Detection and Diagnosis Research; 93.395, Cancer Treatment Research; 93.396, Cancer Biology Research; 93.397, Cancer Centers Support; 93.398, Cancer Research Manpower; 93.399, Cancer Control).

Dated: July 22, 1991.

Betty J. Beveridge,
Committee Management Officer, NIH.

[FR Doc. 91-17920 Filed 7-25-91; 8:45 am]

BILLING CODE 4160-01-M

Public Health Service

National Institutes of Health; Statement of Organization, Functions and Delegations of Authority

Part H, chapter HN (National Institutes of Health) of the Statement of Organization, Functions and Delegations of Authority of the Department of Health and Human Services (40 FR 22859, May 27, 1975, as amended most recently at 56 FR 26418-9, June 7, 1991), is amended to reflect the following changes within the National Center for Human Genome Research (NCHGR): (1) Correct the Standard Administrative Code of the National Center for Human Genome Research; and (2) establish the following NCHGR substructure: (a) Office of the director (HN41); (b) Office of Administrative Management (HN412); (c) Office of Human Genome Communications (HN413); (d) Office of Scientific Review (HN414); (e) Research Grants Branch (HN42); and (f) Research Centers Branch (HN43). The NCHGR is a newly established Center of the NIH, and the formal establishment of its substructure clearly defines the function of each organizational component as it relates to the mission of the Center.

Section HN-B, Organization and Functions is amended as follows:

(1) Under the heading *National Center for Human Genome Research (HN3)*, change the Standard Administrative Code (HN3) to (HN4):

(2) Under the heading *National Center for Human Genome Research (HN4)*, insert the following:

Office of the Director (HN41). (1) Plans, directs, and coordinates the development and progress of the Center programs; (2) develops major policy and program decisions based on an evaluation of the status of support and accomplishments of the Center program areas; (3) coordinates grant review and program management activities; (4) plans and organizes conferences and workshops; and (5) communicates with the scientific community and coordinates activities with other private and government agencies.

Office of Administrative Management (HN412). (1) Advises the Director, Deputy Director, and senior Center staff on administrative matters; (2) supervises and directs the planning and execution of the Center's budget and financial management operations and the administrative activities of the Center, including personnel and staffing, the purchase and maintenance of equipment and supplies, and the acquisition and management of space; (3) interprets, analyzes, and implements

administrative orders and management activities affecting the mission of the Center; (4) directs and coordinates the Center's grants and contracts management and committee management functions; (5) develops, implements, and supervises the program planning and evaluation activities of the NCHGR by initiating and conducting a wide variety of analytical studies that provide a rational basis for key policy and program decisions; (6) analyzes and tracks legislation and assists in preparation of Congressional testimony for the Director; and (7) has broad responsibility for the supervision of computer related activities of the NCHGR, as well as the design, implementation, and day-to-day operation of an automated data processing system.

Office of Human Genome Communications (HN413). (1) Develops a broad communications program aimed at disseminating information about the NCHGR Human Genome Project; (2) prepares reports, publications, press releases, exhibits, education programs, and responds to inquiries from the press, lay organizations, the general public, and scientists about the research programs and policies of the NCHGR; (3) works with graphic arts on the design and production of art for exhibits and publications, including the Five-Year Plan; and (4) develops and maintains mailing lists using computer databases for mass mailings of press releases and other announcements.

Office of Scientific Review (HN414). (1) Plans and administers scientific review activities, including the organization and management of Initial Review Groups (IRGs), constituted to review NCHGR's extramural grants, cooperative agreements, and contract proposals; (2) performs initial scientific and administrative review of research, research center, program project, conference, and research training grant applications, cooperative agreements, and contracts; (3) plans and directs site-visits and meetings of IRGs; (4) establishes review criteria and standards for the IRGs and provides technical leadership to the review process; and (5) prepares summary statements and provides pertinent information concerning the review of applications to Council.

Research Grants Branch (HN42). (1) Manages and directs an extramural research grants program including the Center's portfolio of individual-initiated research grants, program project grants, post doctoral fellowships, research training grants, special initiatives such as special courses and instrumentation

supplements, and research contracts; (2) conducts and administers a program dealing with the ethical, legal, and social aspects of the Human Genome Program; (3) collaborates with joint NIH/DOE working groups on relevant program priorities; (4) analyzes national research efforts on the Human Genome Program and makes recommendations to assist the National Advisory Council for Human Genome Research or other advisory committees or groups appointed regarding: (a) Decisions about new or continuing areas of program emphasis, and (b) the relative scientific merit of applications; (5) develops pay plan for applications, coordinates and develops reports on program content, budget activities, and priorities in Branch; (6) advises universities, other centers of research, and professional and lay organizations about research needs and requirements of the Human Genome Program.

Research Centers Branch (HN43). (1) Plans and directs an extramural program for the establishment and support of human genome research centers: These multi-disciplinary centers will bring together investigators from diverse scientific backgrounds to collaborate on specific aspects of the Human Genome Program; (2) provides technical advice on scientific and programmatic management of human genome research center grants, and related cooperative agreements and research contracts; (3) administers large-scale DNA sequencing RO1s; (4) presents human genome research center grant applications, new initiatives, and other pertinent matters to the National Advisory Council for Human Genome Research and translates the recommendations of the Council into appropriate action; (5) evaluates recommendations of the Study Section and other review committees within the program area, and serves as the focal point for all contacts with the applicant institution, principal investigator, and any other appropriate persons or organizations having any role or special information in this program area; and (6) provides guidance and direction in the review and evaluation of grant, cooperative agreement, and contract supported human genome research centers to determine whether support should be continued at the level and within the time period approved.

Dated: May 2, 1991.

Bernadine Healy,

Director, NIH.

[FR Doc. 91-17777 Filed 7-25-91; 8:45 am]

BILLING CODE 4140-01-M

DEPARTMENT OF HOUSING AND URBAN DEVELOPMENT

Office of the Assistant Secretary for Community Planning and Development

[Docket No. N-91-1917; FR-2934-N-36]

Federal Property Suitable as Facilities to Assist the Homeless

AGENCY: Office of the Assistant Secretary for Community Planning and Development, HUD.

ACTION: Notice.

SUMMARY: This notice identifies unutilized, underutilized, excess, and surplus Federal property reviewed by HUD for suitability for possible use to assist the homeless.

ADDRESSES: For further information, contact James N. Forsberg, Room 7262, Department of Housing and Urban Development, 451 Seventh Street SW., Washington, DC 20410; telephone (202) 708-4300; TDD number for the hearing- and speech-impaired (202) 708-2565 (these telephone numbers are not toll-free), or call the toll-free Title V information line at 1-800-927-7588.

SUPPLEMENTARY INFORMATION: In accordance with 24 CFR Part 581 and section 501 of the Stewart B. McKinney Homeless Assistance Act (42 U.S.C. 11411), as amended, HUD is publishing this Notice to identify Federal buildings and other real property that HUD has reviewed for suitability for use to assist the homeless. The properties were reviewed using information provided to HUD by Federal landholding agencies regarding unutilized and underutilized buildings and real property controlled by such agencies or by GSA regarding its inventory of excess or surplus Federal property. This Notice is also published in order to comply with the December 12, 1988 Court Order in *National Coalition for the Homeless v. Veterans Administration*, No. 88-2503-OG (D.D.C.).

Properties reviewed are listed in this notice according to the following categories: Suitable/available, suitable/unavailable, suitable/to be excess, and unsuitable. The properties listed in the three suitable categories have been reviewed by the landholding agencies, and each agency has transmitted to HUD: (1) Its intention to make the property available for use to assist the homeless, (2) its intention to declare the property excess to the agency's needs, or (3) a statement of the reasons that the property cannot be declared excess or made available for use as facilities to assist the homeless.

Properties listed as suitable/available will be available exclusively for homeless use for a period of 60 days from the date of this notice. Homeless assistance providers interested in any such property should send a written expression of interest to HHS, addressed to Judy Breitman, Division of Health Facilities Planning, U.S. Public Health Service, HHS, room 17A-10, 5600 Fishers Lane, Rockville, MD 20857; (301) 443-2265. (This is not a toll-free number.) HHS will mail to the interested provider an application packet, which will include instructions for completing the application. In order to maximize the opportunity to utilize a suitable property, providers should submit their written expressions of interest as soon as possible. For complete details concerning the processing of applications, the reader is encouraged to refer to the interim rule governing this program, 56 FR 23789 (May 24, 1991).

For properties listed as suitable/to be excess, that property may, if subsequently accepted as excess by GSA, be made available for use by the homeless in accordance with applicable law, subject to screening for other Federal use. At the appropriate time, HUD will publish the property in a Notice showing it as either suitable/available or suitable/unavailable.

For properties listed as suitable/unavailable, the landholding agency has decided that the property cannot be declared excess or made available for use to assist the homeless, and the property will not be available.

Properties listed as unsuitable will not be made available for any other purpose for 20 days from the date of this Notice. Homeless assistance providers interested in a review by HUD of the determination of unsuitability should call the toll free information line at 1-800-927-7588 for detailed instructions or write a letter to James N. Forsberg at the address listed at the beginning of this Notice. Included in the request for review should be the property address (including zip code), the date of publication in the *Federal Register*, the landholding agency, and the property number.

For more information regarding particular properties identified in this Notice (*i.e.*, acreage, floor plan, existing sanitary facilities, exact street address), providers should contact the appropriate landholding agencies at the following addresses: *U.S. Air Force*: Bob Menke, USAF, Bolling AFB, SAF-MIIR, Washington, DC 20332-5000; (202) 767-6235; *U.S. Army*: Robert Conte, Dept. of the Army, Military Facilities, DAEN-ZCI-P, Rm. 1E671, Pentagon, Washington, DC 20310-2600; (202) 693-

4583; *GSA*: Ronald Rice, Federal Property Resources Services, GSA, 18th and F Streets NW., Washington, DC 20405; (202) 501-0067; *Dept. of Interior*: Lola D. Knight, Property Management Specialist, Dept. of Interior, 1849 C St. NW., Mailstop 5512-MIB, Washington, DC 20240; (202) 208-4080. (These are not toll-free numbers.)

Dated: July 19, 1991.

Paul Roitman Bardack,
Deputy Assistant Secretary for Economic Development.

Title V, Federal Surplus Property Program
Federal Register Report for 07/26/91

Suitable/Available Properties
Buildings (by State)

Alabama

Bldg. T05020—Fort Rucker
3rd Avenue
Fort Rucker Co: Dale AL 36362-
Landholding Agency: Army
Property Number: 219120108
Status: Unutilized
Comment: 2500 sq. ft., one story, possible asbestos, off-site use only.

Bldg. T08901—Fort Rucker
7th Avenue
Fort Rucker Co: Dale AL 36362-
Landholding Agency: Army
Property Number: 219120109
Status: Unutilized
Comment: 2350 sq. ft., one story, possible asbestos, needs rehab, off-site use only.

Bldg. T08902—Fort Rucker
7th Avenue
Fort Rucker Co: Dale AL 36362-
Landholding Agency: Army
Property Number: 219120110
Status: Unutilized
Comment: 3663 sq. ft., one story, possible asbestos, needs rehab, off-site use only.

Bldg. T08903—Fort Rucker
7th Avenue
Fort Rucker Co: Dale AL 36362-
Landholding Agency: Army
Property Number: 219120111
Status: Unutilized
Comment: 3404 sq. ft., one story, possible asbestos, needs rehab, off-site use only.

Bldg. T08917—Fort Rucker
Corner of Division Road & 7th Avenue
Fort Rucker Co: Dale AL 36362-
Landholding Agency: Army
Property Number: 219120112
Status: Unutilized
Comment: 16004 sq. ft., two story, possible asbestos, needs rehab.

Arizona

Bldg. T67208
U.S. Army Intelligence Center
Fort Huachuca
Sierra Vista Co: Cochise AZ 85635-
Landholding Agency: Army
Property Number: 219120113
Status: Unutilized
Comment: 2546 sq. ft., one story wood, most recent use—storage.

Bldg. T70224
U.S. Army Intelligence Center

Fort Huachuca
Sierra Vista Co: Cochise AZ 85635-
Landholding Agency: Army
Property Number: 219120149
Status: Unutilized
Comment: 1252 sq. ft., one story wood; most recent use Administrative.

Guam

Harmon VOR site (Portion) (AJKZ)
Municipality of Dededo
Dededo Co: Guam GU 96912-
Location:
Approx. 12 miles southwest of Anderson AFB proper.
Landholding Agency: Air Force
Property Number: 189120234
Status: Unutilized
Comment: 550 sq. ft. bldg., needs rehab on 82 acres.

Texas

Bldg. T-340—Fort Sam Houston
San Antonio Co: Bexar TX 78234-5000
Landholding Agency: Army
Property Number: 219120102
Status: Unutilized
Comment: 2284 sq. ft., one story wood bldg., potential utilities, presence of asbestos.

Bldg. T-341 Fort Sam Houston
San Antonio Co: Bexar TX 78234-5000
Landholding Agency: Army
Property Number: 219120103
Status: Unutilized
Comment: 2284 sq. ft., one story wood bldg., potential utilities, presence of asbestos.

Bldg. 456—Fort Bliss
456 Pershing Road
El Paso Co: El Paso TX 79916-
Landholding Agency: Army
Property Number: 219120115
Status: Unutilized
Comment: 1770 sq. ft., one story, most recent use—Youth center; off-site use only.

Bldg. 468—Fort Bliss
468 Shannon Road
El Paso Co: El Paso TX 79916-
Landholding Agency: Army
Property Number: 219120116
Status: Unutilized
Comment: 3540 sq. ft., two story wood frame; presence of friable asbestos in boiler room; most recent use—barracks; off-site use only.

Bldg. 469—Fort Bliss
469 Shannon Road
El Paso Co: El Paso TX 79916-
Landholding Agency: Army
Property Number: 219120117
Status: Unutilized
Comment: 3540 sq. ft., two story wood frame presence of friable asbestos; most recent use—barracks; off-site use only.

Bldg. 478—Fort Bliss
478 Doniphan Road
El Paso Co: El Paso TX 79916-
Landholding Agency: Army
Property Number: 219120118
Status: Unutilized
Comment: 3540 sq. ft., two story wood frame; presence of friable asbestos; most recent use—barracks; off-site use only.

Bldg. 479—Fort Bliss, Tex.
479 Doniphan Road

- El Paso Co: El Paso TX 79916-
Landholding Agency: Army
Property Number: 219120119
Status: Unutilized
Comment: 3540 sq. ft., two story wood frame;
presence of friable asbestos; most recent
use—barracks; off-site use only.
- Bldg. 4202—Fort Bliss, Tex.
4202 Access Road
Logan Heights
El Paso Co: El Paso TX 79916-
Landholding Agency: Army
Property Number: 219120120
Status: Unutilized
Comment: 2100 sq. ft., one story, needs rehab;
most recent use dental clinic; off-site use
only.
- Bldg. 4308—Fort Bliss, Tex.
4308 Link Road
El Paso Co: El Paso TX 79916-
Landholding Agency: Army
Property Number: 219120121
Status: Unutilized
Comment: 4106 sq. ft., one story wood frame;
needs rehab; most recent use—Skill
Development Center; off-site use only.
- Bldg. 4348—Fort Bliss, Tex.
4348 Leo Drive
El Paso Co: El Paso TX 79916-
Landholding Agency: Army
Property Number: 219120122
Status: Unutilized
Comment: 1829 sq. ft., one story wood frame;
most recent use vehicle maintenance shop;
off-site use only.
- Bldg. 4349—Fort Bliss, Tex.
4349 Leo Drive
El Paso Co: El Paso TX 79916-
Landholding Agency: Army
Property Number: 219120123
Status: Unutilized
Comment: 1829 sq. ft., one story wood frame;
most recent use vehicle maintenance shop;
off-site use only.
- Bldg. 4745—Fort Bliss, Tex.
4745 Grinder Avenue
El Paso Co: El Paso TX 79916-
Landholding Agency: Army
Property Number: 219120124
Status: Unutilized
Comment: 873 sq. ft., one story wood frame;
most recent use Company Headquarters
Bldg; off-site use only.
- Bldg. 4747—Fort Bliss, Tex.
4747 Grinder Avenue
Logan Heights
El Paso Co: El Paso TX 79916-
Landholding Agency: Army
Property Number: 219120125
Status: Unutilized
Comment: 488 net sq. ft., one story, needs
major rehab; off-site use only.
- Bldg. 4749—Fort Bliss, Tex.
4749 Gatchell Avenue
El Paso Co: El Paso TX 79916-
Landholding Agency: Army
Property Number: 219120126
Status: Unutilized
Comment: 873 net sq. ft., one story; most
recent use—storage; off-site use only.
- Bldg. 4752—Fort Bliss, Tex.
4752 Grinder Avenue
Logan Heights
El Paso Co: El Paso TX 79916-
Landholding Agency: Army
Property Number: 219120127
Status: Unutilized
Comment: 2169 sq. ft., one story wood frame;
limited utilities; most recent use—storage;
off-site use only.
- Bldg. 4758—Fort Bliss, Tex.
4758 Grinder Avenue
Logan Heights
El Paso Co: El Paso TX 79916-
Landholding Agency: Army
Property Number: 219120128
Status: Unutilized
Comment: 915 sq. ft., one story wood frame;
most recent use day room; off-site use only.
- Bldg. 4761—Fort Bliss, Tex.
4761 Logan Heights
El Paso Co: El Paso TX 79916-
Landholding Agency: Army
Property Number: 219120129
Status: Unutilized
Comment: 915 sq. ft., one story wood frame;
most recent use Administrative; off-site use
only.
- Bldg. 4781—Fort Bliss, Tex.
4781 Burgin Street
Logan Heights
El Paso Co: El Paso TX 79916-
Landholding Agency: Army
Property Number: 219120130
Status: Unutilized
Comment: 1266 sq. ft., one story wood frame;
presence of friable asbestos; most recent
use—sales store; off-site use only.
- Bldg. 4783—Fort Bliss, Tex. 4783 Burgin Street
Logan Heights
El Paso Co: El Paso TX 79916-
Landholding Agency: Army
Property Number: 219120131
Status: Unutilized
Comment: 873 sq. ft., one story wood frame;
possible asbestos; most recent use—Day
room; off-site use only.
- Bldg. 4818
Fort Bliss
4818 Gatchell Avenue
El Paso Co: El Paso TX 79916-
Landholding Agency: Army
Property Number: 219120132
Status: Unutilized
Comment: 873 sq. ft., one story wood frame;
presence of friable asbestos; most recent
use—Day room; off-site use only.
- Bldg. 4820—Fort Bliss, Tex.
4820 Hohenthal Avenue
Logan Heights
El Paso Co: El Paso TX 79916-
Landholding Agency: Army
Property Number: 219120133
Status: Unutilized
Comment: 873 sq. ft., one story wood frame;
possible asbestos; most recent use—Day
room; off-site use only.
- Bldg. 4825—Fort Bliss, Tex.
4825 Hohenthal Ave.
El Paso Co: El Paso TX 79916-
Landholding Agency: Army
Property Number: 219120134
Status: Unutilized
Comment: 2169 sq. ft., one story wood frame;
most recent use—General storage; off-site
use only.
- Bldg. 4828—Fort Bliss, Tex.
4828 Gatchell Avenue
El Paso Co: El Paso TX 79916-
Landholding Agency: Army
Property Number: 219120135
Status: Unutilized
Comment: 915 sq. ft., one story wood frame;
presence of friable asbestos, in boiler room;
most recent use—Day room; off-site use
only.
- Bldg. 4829—Fort Bliss, Tex.
4829 Gatchell Avenue
El Paso Co: El Paso TX 79916-
Landholding Agency: Army
Property Number: 219120136
Status: Unutilized
Comment: 915 sq. ft., one story wood frame;
most recent use—General storage; off-site
use only.
- Bldg. 4837—Fort Bliss, Tex.
4837 Gatchell Avenue
El Paso Co: El Paso TX 79916-
Landholding Agency: Army
Property Number: 219120137
Status: Unutilized
Comment: 1770 sq. ft., one story wood frame;
presence of friable asbestos in boiler room;
most recent use—Instruction bldg.; off-site
use only.
- Bldg. 4839—Fort Bliss, Tex.
4839 Burgin Street
El Paso Co: El Paso TX 79916-
Landholding Agency: Army
Property Number: 219120138
Status: Unutilized
Comment: 873 sq. ft., one story wood frame;
presence of friable asbestos in boiler room;
most recent use—Day room; off-site use
only.
- Bldg. 4867—Fort Bliss, Tex.
4867 Burgin Street
El Paso Co: El Paso TX 79916-
Landholding Agency: Army
Property Number: 219120139
Status: Unutilized
Comment: 2169 sq. ft., one story wood frame;
presence of friable asbestos in boiler room;
most recent use—Instruction bldg.; off-site
use only.
- Bldg. 4868—Fort Bliss, Tex.
4868 Burgin Street
El Paso Co: El Paso TX 79916-
Landholding Agency: Army
Property Number: 219120140
Status: Unutilized
Comment: 873 sq. ft., one story wood frame;
most recent use—Day room; off-site use
only.
- Bldg. 4875—Fort Bliss, Tex.
4875 Burgin Street
El Paso Co: El Paso TX 79916-
Landholding Agency: Army
Property Number: 219120141
Status: Unutilized
Comment: 2169 sq. ft., one story wood frame;
presence of friable asbestos; most recent
use—storage; off-site use only.
- Bldg. 4877—Fort Bliss, Tex.
4877 Burgin Street
El Paso Co: El Paso TX 79916-
Landholding Agency: Army
Property Number: 219120142
Status: Unutilized
Comment: 873 sq. ft., one story wood frame;
possible friable asbestos; most recent use—
Day room; off-site use only.

Bldg. 4921—Fort Bliss, Tex.
4921 Ketcham Avenue
El Paso Co: El Paso TX 79916—
Landholding Agency: Army
Property Number: 219120143
Status: Unutilized

Comment: 1381 sq. ft., one story wood frame;
possible friable asbestos; most recent use—
Day room; off-site use only.

Bldg. 4925—Fort Bliss, Tex.
4925 Ketcham Avenue
El Paso Co: El Paso TX 79916—
Landholding Agency: Army
Property Number: 219120144
Status: Unutilized

Comment: 2169 sq. ft., one story wood frame;
limited utilities; possible friable asbestos;
most recent use—storage; off-site use only.

Bldg. 4936—Fort Bliss, Tex.
4938 Burgin Street
El Paso Co: El Paso TX 79916—
Landholding Agency: Army
Property Number: 219120145
Status: Unutilized

Comment: 1770 sq. ft., one story wood frame;
possible friable asbestos; most recent use—
storage; off-site use only; limited utilities.

Bldg. 4940—Fort Bliss, Tex.
4940 Burgin Street
El Paso Co: El Paso TX 79916—
Landholding Agency: Army
Property Number: 219120146
Status: Unutilized

Comment: 1792 sq. ft., one story wood frame;
possible friable asbestos; most recent use—
storage; off-site use only; limited utilities.

Bldg. 11190—Fort Bliss, Tex.
11190 SGT E. Churchill Street
El Paso Co: El Paso TX 79916—
Landholding Agency: Army
Property Number: 219120147
Status: Unutilized

Comment: 600 sq. ft., one story wood frame;
limited utilities; needs rehab; most recent
use—storage; off-site use only.

Bldg. 11191—Fort Bliss, Tex.
11191 SGT E. Churchill Street
El Paso Co: El Paso TX 79916—
Landholding Agency: Army
Property Number: 219120148
Status: Unutilized

Comment: 1140 sq. ft., one story wood frame;
limited utilities; most recent use—storage;
off-site use only.

Virginia

Bldg. #43—Admin. Gen Purp Bldg.
Fort Myer
Washington Avenue
Fort Myer Co: Arlington VA 22211—
Landholding Agency: Army
Property Number: 219120100
Status: Unutilized

Comment: 1341 sq. ft., two story, brick/wood
siding, needs major rehab, possible
asbestos, off-site use only.

Bldg. #46—Admin. Gen Purp Bldg.
Fort Myer
Washington Avenue
Fort Myer Co: Arlington VA 22211—
Landholding Agency: Army
Property Number: 219120101
Status: Unutilized

Comment: 2866 sq. ft., two story brick/partial
wood shingles, needs major rehab, off-site
use only.

Suitable/Unavailable Properties

Buildings (by State)

Texas

Facility 237—Carswell AFB
301 Roaring Springs Road
Fort Worth Co: Tarrant TX 76127—
Landholding Agency: Air Force
Property Number: 189120235
Status: Unutilized

Comment: 1285 sq. ft., wood shingles, one
story, most recent use—residential, needs
rehab

Bldg. T-342 Fort Sam Houston
San Antonio Co: Bexar TX 78234-5000
Landholding Agency: Army
Property Number: 219120104
Status: Unutilized

Comment: 2284 sq. ft., one story wood bldg.,
presence of asbestos.

Bldg. T-1185 Fort Sam Houston
San Antonio Co: Bexar TX 78234-5000
Landholding Agency: Army
Property Number: 219120105
Status: Unutilized

Comment: 4720 sq. ft., two story wood bldg.,
potential utilities, needs rehab, presence of
asbestos.

Bldg. S-2588 Fort Sam Houston
San Antonio Co: Bexar TX 78234-5000
Landholding Agency: Army
Property Number: 219120106
Status: Unutilized

Comment: 19436 sq. ft., two story wood/
stucco bldg., potential utilities, needs
rehab.

Bldg. T-2589—Fort Sam Houston
San Antonio Co: Bexar TX 78234-5000
Landholding Agency: Army
Property Number: 219120107
Status: Unutilized

Comment: 15360 sq. ft., two stop wood bldg.,
needs rehab.

Bldg. 809 Fort Hood
20th Street and Central Avenue
Fort Hood Co: Bell TX 76544—
Landholding Agency: Army
Property Number: 219120114
Status: Unutilized

Comment: 4779 sq. ft., two story wooden
structure, needs major rehab, no latrine
facilities.

Unsuitable Properties

Buildings (by State)

Illinois

Former Martin L. King Center
3312 West Grenshaw Avenue
Chicago Co: Cook IL 60624—
Landholding Agency: GSA
Property Number: 549130005
Status: Excess

Reason:

Other

Comment: extensive deterioration
GSA Number: 2(R)-F-IL-691

Washington

Bldg. #36—Stehekin District
Company Creek Road
Stehekin Co: Chelan WA 98852—
Landholding Agency: Interior
Property Number: 619130001
Status: Unutilized

Reason:

Other

Comment: extensive deterioration

Bldg. 689—Comfort Station
Olympic Hot Springs Wilderness
Backcountry
Port Angeles Co: Clallam, WA 98362-6798
Landholding Agency: Interior
Property Number: 619130002
Status: Excess

Reason:

Other

Comment: extensive deterioration

Bldg. 252—Storage Shed
Olympic Hot Springs Wilderness
Backcountry
Port Angeles Co: Clallam WA 98362-6798
Landholding Agency: Interior
Property Number: 619130003
Status: Excess

Reason:

Other

Comment: extensive deterioration

[FR Doc. 91-17637 Filed 7-25-91; 8:45 am]

BILLING CODE 4210-29-M

DEPARTMENT OF THE INTERIOR

Bureau of Land Management

[CA-060-01-5440-10-ZBBB]

Availability of Draft Environmental Impact Statement and Report for the Proposed Eagle Mountain Landfill, Riverside County, CA

AGENCY: Bureau of Land Management,
Interior.

ACTION: Notice of availability.

SUMMARY: In accordance with section 102 of the National Environmental Policy Act of 1969, a joint Draft Environmental Impact Statement and Report (EIS/EIR) has been prepared by the Bureau of Land Management and County of Riverside, California for the proposed Eagle Mountain Landfill. The EIS/EIR describes and analyzes four alternatives including the proposed project. Mine Reclamation Corporation has proposed to utilize the Kaiser Steel Resources, Inc., Eagle Mountain Mine site in Riverside County, California, and an associated railroad spur for a Class III waste disposal facility. The site would also be used for the storage of recyclable materials, rail and equipment maintenance, landfill gas recovery and utilization, flare/energy recovery, leachate processing, wastewater treatment, the continuance and/or expansion of the existing residential and commercial land uses, and the expansion of the Return-to-Custody facility (California Department of Corrections). The proposal includes a land exchange and application for a

right-of-way with the BLM and a Specific Plan Amendment with the County. The EIS/EIR analyzes the effects of the proposed action and alternatives on such environmental issues as desert tortoise, air and water quality, visual and cultural resources, and public safety.

Public reading copies are available for review at the following libraries:

BLM Library, Service Center, Denver, CO
 California State Library, Government Publications, Sacramento, CA
 Coachella Branch Library, Coachella, CA
 Desert Hot Springs Branch Library, Desert Hot Springs, CA
 Indio Branch Library, Indio, CA
 Lake Tamarisk Branch Library, Desert Center, CA
 Los Angeles Public Library, Fifth St., Los Angeles, CA
 Los Angeles Public Library, Spring St., Los Angeles, CA
 Palm Desert Branch Library, Palm Desert, CA
 Palm Springs Library Center, Palm Springs, CA
 Palo Verde Valley District Library, Blythe, CA
 Central Library, Seventh St., Riverside, CA
 San Bernardino County Library, Joshua Tree, CA
 San Bernardino County Library, Adobe Rd, Yucca Valley, CA
 San Bernardino County Library, 29 Palms Hwy, Yucca Valley, CA
 San Bernardino Public Library, West 6th St., San Bernardino, CA
 UC Riverside Library, Government Publications, Riverside, CA

Copies are also available for review at the following BLM and County offices:

Bureau of Land Management, Palm Springs-South Coast RA, 400 S. Farrell Dr., Suite B-205, Palm Springs, CA 92262
 (As of mid-August, the new address will be: Palm Springs-South Coast RA, 63-500 Garnet Ave., P.O. Box 2000, N. Palm Springs, CA 92258-2000)
 Bureau of Land Management, CA Desert District Office, 6221 Box Springs Blvd., Riverside, CA 92507-0714
 Bureau of Land Management, California State Office, Federal Office Bldg., 2800 Cottage Way, Rm. E-2841, Sacramento, CA 95825
 Riverside County, Planning Dept., County Admin. Office, 4080 Lemon St., 9th Fl., Riverside, CA 92501-3651
 Riverside County Planning Dept., Bermuda Dunes Office, 79733 Country Club Dr., Bermuda Dunes, CA 92201.

DATES FOR PUBLIC HEARINGS AND COMMENTS: Public hearings will be held

on the following dates: 7 p.m. on Tuesday, August 27, 1991, at Palm Desert City Hall, 73510 Fred Waring Dr., Palm Desert, CA 92260 (619-346-0611) and 7 p.m. on Wednesday, August 28, 1991, at Lake Tamarisk Recreation Center, 26251 Parkview Dr., Desert Center, CA 92239 (619-227-3203).

Comments concerning the adequacy of this document will be considered in preparation of the Final EIS/EIR. A sixty (60) day comment period has been established for this document. Written comments on this document will be accepted through September 24, 1991, and should be addressed to: Bureau of Land Management, Palm Springs-South Coast Resource Area, Attn: Marianne Wetzell, 63-500 Garnet Ave., P.O. Box 2000, N. Palm Springs, CA 92258-2000.

Dated: July 10, 1991.

Alan Stein,
 Acting District Manager.
 [FR Doc. 91-16973 Filed 7-25-91; 8:45 am]

BILLING CODE 4310-40-M

[CA-010-01-4320-02]

Bakersfield District Grazing Advisory Board Meeting

AGENCY: Bureau of Land Management, Interior.

ACTION: Notice of Bakersfield District Grazing Advisory Board meeting.

SUMMARY: Notice is hereby given in accordance with the Federal Advisory Committee Act (Pub. L. 92-463) and the Federal Land Policy and Management Act (Pub. L. 94-579) that the Bakersfield District Grazing Advisory Board will meet Wednesday August 21, 1991 from 10 am to 3 pm in room 335 of the Federal Building, 800 Truxtun Ave., Bakersfield, California.

SUPPLEMENTARY INFORMATION: The agenda for the meeting will include discussion of FY 91 project accomplishments, FY 92 planned projects, and allotment management planning in the District.

The meeting is open to the public. Interested persons may make oral statements, or file written statements for consideration by the Board. Anyone wishing to make an oral statement must notify, in writing, the Bakersfield District Manager (Bureau of Land Management, 800 Truxtun Ave., room 311, Bakersfield, CA 93301) by August 19, 1991.

Summary minutes of the meeting will be maintained in the Bakersfield District Office, and will be available for inspection, during business hours, within 30 days following the meeting.

FOR FURTHER INFORMATION CONTACT: Holden Brink, Natural Resource

Specialist, Bureau of Land Management, 800 Truxtun Ave., room 311, Bakersfield, CA 93301 or phone (805) 861-4230.

H. Edward Lynch,
 Associate District Manager.
 [FR Doc. 91-17729 Filed 7-25-91; 8:45 am]

BILLING CODE 4310-04-M

[CO-050-4830-12]

Canon City District Advisory Council Meeting

AGENCY: Bureau of Land Management, Interior.

ACTION: Notice of meeting.

SUMMARY: Notice is hereby given in accordance with Public Law 94-579 that the Canon City District Advisory Council (DAC) Meeting will be held Thursday, August 15, 1991, 1:30 p.m. to 4:30 p.m. and Friday, August 16, 1991, 10 a.m. to 2:30 p.m., at the Canon City District Office, 3170 East Main, Canon City, Colorado.

The meeting agenda will include:

1. A tour of the Garden Park Fossil Area.
2. A workshop on the Arkansas River Wild and Scenic River Study.
3. Public presentations to the council (open invitation).

The meeting is open to the public. Persons interested may make oral presentations to the council at 11:30 a.m., August 16, or they may file written statements for the council's consideration. The District Manager may limit the length of oral presentations depending on the number of people wishing to speak.

ADDRESSES: Anyone wishing to make an oral or written presentation to the council should notify the District Manager, Bureau of Land Management, P.O. Box 2200, 3170 East Main, Canon City, Colorado 81215-2200, by August 15, 1991.

FOR FURTHER INFORMATION CONTACT: Ken Smith (719) 275-0631.

SUPPLEMENTARY INFORMATION: Summary of minutes of the meeting will be available for public inspection and reproduction during regular working hours at the District Office approximately 30 days following the meeting.

Donnie R. Sparks,
 District Manager.
 [FR Doc. 91-17730 Filed 7-25-91; 8:45 am]

BILLING CODE 4310-JB-M

(CA-010-4212-13; CACA 28305)

Realty Action; Exchange of Public Land in Placer County, CA; Correction

To notice document 91-14081, page 27267, issue of Thursday, June 13, 1991, in the second column, add the following to the end of the summary:

The subject public land is hereby segregated from settlement, location and entry under the public land laws and mining laws for a period of two years; the two year segregation will expire on June 13, 1993.

D.K. Swickard,
Area Manager.

[FR Doc. 91-17731 Filed 7-25-91; 8:45 am]

BILLING CODE 4310-40-M

(MT-020-4120-08)

Montana; Resource Management Plan Amendment

AGENCY: Bureau of Land Management, Miles City District Office, Interior.

ACTION: Notice of intent to prepare a resource management plan amendment to change the unsuitability criteria designation of Federal coal lands in Big Horn County, Montana.

SUMMARY: A Resource Management Plan (RMP) Amendment/Environmental Assessment will be prepared on a proposal to change the unsuitability criteria designation on certain Federal coal lands in and around the Spring Creek Coal Company's (SCCC) mine in Big Horn County, Montana.

The Powder River RMP identified portions of Federal coal lands in T. 8 S., R. 39 E., sections 22, 23, 26 and 27 as unsuitable for mining because of a golden eagle nest (criterion 11) and overlapped mule deer/antelope winter range (criterion 15). SCCC has requested consideration of a proposal to disturb a portion of these lands for the purpose of expanding its mining operations.

The golden eagle nest was destroyed by natural causes approximately seven years ago and the eagles have since relocated their nest some three miles distant. The U.S. Fish and Wildlife Service has been consulted and has no objections to removing the unsuitability criterion designation (11) for this site.

There are 880 acres of overlapped mule deer/antelope winter range. The lands involved are scattered parcels of Federal surface/Federal minerals; however, the majority of these lands are private surface/Federal minerals. SCCC is the private surface owner. Their proposal is to disturb a total of 228 acres of the winter range of which only 20 acres would be mined. The additional

disturbance would be for associated mining operations such as backsloping for reclamation purposes and haul roads. This disturbance may be considerably less, depending upon the final reclamation plan.

Montana Department of Fish, Wildlife, and Parks (MDFW&P); Montana Department of State Lands (MDSL); and SCCC representatives have met and agreed in principle that these lands can be changed from "unsuitable for mining" to "suitable for mining with stipulations."

Mitigation measures agreed upon by all parties involved the establishment of a rest-rotation grazing system and a hunter access program on SCCC private lands in and around the mine to realize management goals of keeping wildlife populations in balance with available forage. They also agreed to develop a satisfactory reclamation plan on any lands disturbed or mined as part of the mitigation plan agreement. SCCC, Montana DFWP, and Montana DSL are currently working on an acceptable agreement and have petitioned BLM to redesignate these lands as "suitable for mining with stipulations" contingent upon development of a final mitigation and reclamation plan.

DATES: On or before August 26, 1991, interested parties may comment on this proposal.

FOR FURTHER INFORMATION CONTACT: Bureau of Land Management, Attn: Bill Matthews, Powder River Resource Area, Miles City Plaza, Miles City, Montana 59301, Phone: (406) 232-7000.

Dated: July 17, 1991.

Sandra E. Sacher,

Acting District Manager, Miles City District.

[FR Doc. 91-17732 Filed 7-25-91; 8:45 am]

BILLING CODE 4310-DN-M

(UT-040-01-4410-08)

Intent To Conduct Further Planning

AGENCY: Bureau of Land Management (BLM), Interior.

ACTION: Notice of intent to do further planning for the Revised Dixie Resource Management Plan (RMP), Dixie Resource Area, Cedar City District, Utah.

SUMMARY: The Cedar City District, BLM, announces its intent to conduct further planning for the Dixie Resource Area. This further planning process will focus on the identification of off-highway vehicle (OHV) use areas, oil and gas leasing categories, desert tortoise protection, protection of other threatened and endangered species, Areas of Critical Environmental

Concern (ACECs), wild and scenic rivers, riparian protection, and the resultant impacts on livestock grazing and locatable minerals development. A revised Draft RMP/Environmental Impact Statement (EIS) and a revised Proposed RMP/EIS will be prepared for approximately 628,165 acres of public land located in Washington County, Utah.

SUPPLEMENTARY INFORMATION: The planning issues previously developed as a result of the November 14, 1986, Federal Register Notice (Vol. 51, No. 220) will remain unchanged. Briefly, they are to determine (1) the most appropriate use for those public lands in Washington County where rapid urban development is generating problems with the management of natural resources; (2) future management of outdoor recreation on public lands; and (3) how proposed water storage projects will influence natural resource management.

The preliminary planning criteria have been modified to reflect additional public concern provided by those commenting on the 1989 Draft Dixie RMP/EIS and the 1980 Proposed Dixie RMP/EIS. The modified preliminary planning criteria for the revised Dixie RMP/EIS will include the following:

1. All criteria listed in the 1989 Draft Dixie RMP/EIS will be utilized.
2. The following items will be added to the 1989 criteria:
 - a. Minerals—identify land not suitable for mineral development.
 - b. Mineral Materials Management—determine if commercial sales of decorative rock and petrified wood will be made.
 - c. Lands—identify those lands or interest in lands suitable for disposal by exchange only. Identify potential communication sites.
 - d. Grazing Management—identify major impacts to livestock grazing from resource decisions proposed in the plan. Review the 1982 grazing decisions.
 - e. ACECs—determine which lands meet relevance and importance criteria for designation as an ACEC. Develop management prescriptions for all proposed ACECs.
 - f. Recreation—identify areas and trails suitable for use by recreational OHVs. Lands inventoried through the Recreation Opportunity Spectrum (ROS) system as primitive or semi-primitive nonmotorized will be closed to all OHV uses. Identify lands suitable for recreational management in support of Zion National Park or other attractions.
 - g. Soil, Water, and Air Management—identify proposed reservoir sites identified by the Washington County

Water Conservancy District, and major proposed municipal water development projects including wells and support facilities. Identify varying levels of protection based on riparian values.

h. Endangered Species—identify the goals and objectives of the rangewide plan for the desert tortoise.

Table 1 lists those areas that have been nominated and found potentially suitable for designation as an ACEC. Additional ACEC nominations may be

made by the public and other agencies. They must be accompanied by descriptive materials, maps, and evidence of the relevance and importance of the values or hazards involved.

TABLE 1.—NOMINATED AREAS OF CRITICAL ENVIRONMENTAL CONCERN DETERMINED POTENTIALLY SUITABLE FOR DESIGNATION

| Area name | Critical concerns |
|----------------------------|--|
| Red Bluff..... | Endangered plant species (Dwarf bear poppy); Colorado River salinity control (saline soils). |
| Warner Ridge..... | Endangered plant species (Dwarf bear poppy, Siler cactus) Colorado River salinity control (saline soils); riparian system; candidate animal species (spotted bat). |
| Santa Clara River..... | Riparian system; cultural resources (Virgin Gunlock Section Anasazi and Paiute riverine sites); wildlife habitat; candidate fish species (Virgin River spinidace). |
| Santa Clara River..... | Riparian system; cultural resources (Virgin Landhill Section Anasazi and Paiute riverine sites); wildlife habitat; candidate fish species (Virgin River spinidace); petroglyphs. |
| Lower Virgin River..... | Riparian systems; endangered fish (Woundfin minnow); endangered fish (Virgin River chub); cultural resources (Virgin Anasazi riverine sites); wildlife habitat. |
| Little Creek Mountain..... | Cultural resources (Virgin Anasazi upland sites). |
| Cansan Mountain..... | National scenic resource (Colorado Plateau). |
| Red Mountain..... | National scenic resource (Colorado Plateau/Great Basin Variation). |
| Beaver Dam Slope..... | Threatened animal species (desert tortoise); Natural Landmark and Desert Woodbury. |
| City Creek..... | Threatened animal species (desert tortoise); community watershed. |
| Upper Beaver Dam Wash..... | Riparian values, fisheries, water quality. |

The revised Draft Dixie RMP/EIS will modify the off-road vehicle (ORV) designations established in 1980 Federal Register, Vol. 45, No. 188). The proposed modifications will be incorporated into the alternatives considered in the RMP.

The Dixie Resource Area will be inventoried to identify all river segments eligible for potential designation as a wild and scenic river. Three river segments have already been determined to be eligible. These river segments are portions of Deep Creek, the North Fork of the Virgin River, and the Virgin River Gorge section of the Beaver Dam Mountains Wilderness Area. All three segments are classified as wild. Additional river segments believed to be eligible may be identified for inventory by writing to the address included in this notice.

Four preliminary alternatives have been developed for evaluation in the revised Draft Dixie RMP/EIS:

Alternative A

Continue with the present MFP and current management situation; respond to controversies as they occur with plan amendments.

Alternative B

Analyze opportunities to dispose of all tracts identified by local and State planning interests which are not mandated by regulations for public retention; initiate sale and disposal of all parcels meeting the FLPMA criteria (Sec. 203) and the requirements for other disposal. The balance of the resource

programs would be managed under the current management situation.

Alternative C

Refine each program to reflect the current management situation and regulations and develop an RMP based on anticipation of population and development trends to Fiscal Year 2000 integrated with the principles of multiple use prescribed in FLPMA.

Alternative D

Utilize public input to develop a revised conservation/multiple-use approach for management of the Dixie Resource Area.

SUPPLEMENTARY INFORMATION: The public will be notified of this further planning by selected mailings, news releases, public meetings, and Federal Register Notices. Opportunities for public review of documents will be announced at appropriate stages of the planning process. Documents relevant to the planning process are available from the address below.

FOR FURTHER INFORMATION CONTACT: David Everett, Team Leader, BLM, 225 North Bluff Street, St. George, Utah 84770, telephone (801) 673-4654.

Dated: July 17, 1991.

James M. Parker,
State Director.

[FR Doc. 91-17744 Filed 7-25-91; 8:45 am]

BILLING CODE 4310-05-M

Bureau of Reclamation

Realty Actions; Sales, Leases, Etc.; Arizona

AGENCY: Bureau of Reclamation, Interior.

ACTION: Notice of realty action, competitive sale of public land.

SUMMARY: The following described land has been identified for disposal under the Act of February 2, 1911, (36 Stat. 895, 43 U.S.C. 374). The Bureau of Reclamation (Reclamation) will accept bids on the following land and will reject any bids, written or oral, for less than \$68,000, the appraised fair market value.

DATE OF SALE: September 26, 1991.

FOR FURTHER INFORMATION CONTACT: Ms. Nancy Seale, Realty Specialist, Bureau of Reclamation, PO Box 9960, Phoenix, Arizona 85068, 602-870-6733 or FTS 765-1733.

Land Identified for Disposal as Follows

Tract No. APO-SRP-EH-3—Two parcels of land, to be sold as one, in Section twenty-three (23), Township Three (3) North, Range One (1) East, Gila and Salt River Meridian, Maricopa County, Arizona, containing a combined area of 1.65 acres, more or less, and being more particularly and separately described as follows as Parcel One and Parcel Two. A more complete legal description may be obtained from the

local Reclamation office referenced above.

Parcel One—All that area as described in that certain Quitclaim Deed from J.B. Davis and Fannie H. Davis, his wife, to the United States of America recorded July 24, 1922, in Book 169 of Deeds, page 7, records of Maricopa County, Arizona.

Parcel Two—All that area as described in that certain Quitclaim Deed from Elizabeth H. Cook and Ernest E. Cook, her husband, to the United States of America recorded February 17, 1941, in Book 358 of Deeds, page 20, records of Maricopa County, Arizona.

The land will be offered for sale through the competitive bidding process. The sale will be held at the Bureau of Reclamation, Arizona Projects Office, PO Box 9980, 23636 North Seventh Street, Phoenix, Arizona 85068 on September 26, 1991.

Registration of qualified bidders will begin at 9 a.m. Bid opening will be at 10 a.m., at which time, sealed bids will be opened and oral bids will be accepted. Sealed bids will be received at the foregoing address until 4 p.m., September 25, 1991. Reclamation may accept or reject any or all offers; or withdraw any land or interest in land for sale, if, in the opinion of the authorized officer, consummation of the sale would not be fully consistent with the Act of February 2, 1911, (36 Stat. 895, 43 U.S.C. 374) or other applicable laws.

The sale of the land is consistent with Reclamation land use planning, and it is determined that the public interest will be best served by offering these lands for sale; the parcel listed and platted is offered for sale "as is" and "where is."

Resource clearances consistent with the National Environmental Policy Act of 1969 (42 U.S.C. 4321, *et seq.*) requirements have been completed and approved and can be viewed at the Bureau of Reclamation, Arizona Projects Office, 23636 North Seventh Street, Phoenix, Arizona 85024.

The deed issued for the parcel sold will be subject to rights-of-way for ditches and canals constructed by the authority of the United States in accordance with the Act of August 30, 1890, (26 Stat. 391, 86 U.S.C. 945) and reservations for public road and utility easements identified by the City of Peoria and the County of Maricopa. This land sale will be for the surface estate only.

For a period of 45 days from the date of this notice, interested parties may submit comments to the Regional Director, Lower Colorado Region, Bureau of Reclamation, PO Box 427, Boulder City, Nevada 89005. Any adverse comments will be evaluated by

the Regional Director who may vacate or modify this Notice of Realty Action and issue a final determination. In the absence of any action by the Regional Director, this Notice of Realty Action will become final determination of the Department of the Interior.

In compliance with the Federal Property Management Regulations, 114S-47.304-8, and Interior Property Management Regulations, 114.47.304-51, the successful bidder will be required to sign a certificate to the effect that "the bid was arrived at by the bidder or offeror independently and was tendered without collusion with any other bidder or offeror."

Dated: July 19, 1991.

Joe D. Hall,
Deputy Commissioner.

[FR Doc. 91-17745 Filed 7-25-91; 8:45 am]

BILLING CODE 4310-09-M

Fish and Wildlife Service

Extension of Comment Period for Public Review of the Draft Environmental Impact Statement (DEIS) for the Proposed Stone Lakes National Wildlife Refuge

AGENCIES: U.S. Department of the Interior, U.S. Fish and Wildlife Service
ACTION: Extension of comment period.

SUMMARY: This notice advises the public that the comment period for public review and comment of the draft Environmental Impact Statement on the feasibility of establishing a National Wildlife Refuge on or near Stone Lakes in south Sacramento County, California, is extended to September 1, 1991.

DATES: Written comments should be received by September 1, 1991.

ADDRESS WRITTEN COMMENTS TO: Peter J. Jerome, U.S. Fish and Wildlife Service, 2233 Watt Avenue, suite 375, Sacramento, California 95825-0509, telephone: (916) 978-4420.

Copies of the Executive Summary of the DEIS have been sent to all agencies and individuals who participated in the scoping process and to all others who have already requested copies. Copies of the full DEIS are available for review at several locations within the Sacramento metropolitan area including most local public libraries.

Dated: July 17, 1991.

Don Weathers,
Regional Director, U.S. Fish and Wildlife Service.

[FR Doc. 91-17658 Filed 7-25-91; 8:45 am]

BILLING CODE 4310-55-M

Taking of Walrus and Polar Bears in the Chukchi Sea, Alaska, Incidental to Oil and Gas Exploration

AGENCY: Fish and Wildlife Service, Interior.

ACTION: Notice.

SUMMARY: The Fish and Wildlife Service (Service) has issued a Letter of Authorization (LOA) that will allow the incidental, but not intentional, take of small numbers of walrus and polar bears during open water exploration for oil and gas in the Chukchi Sea adjacent to the coast of Alaska.

DATES: The LOA is effective from June 28, 1991, to December 31, 1991.

ADDRESSES: The LOA is available for public inspection upon request in the following Service offices: Marine Mammals Management, 4230 University Drive, suite 310, Anchorage, Alaska 99508, and Division of Fish and Wildlife Management Assistance, 4401 North Fairfax Drive, Arlington Square, room 840, Arlington, Virginia 22203.

FOR FURTHER INFORMATION CONTACT: Jon Nickles, Marine Mammals Management, Fish and Wildlife Service, 4230 University Drive, suite 310, Anchorage, Alaska 99508, telephone (907) 561-1239.

SUPPLEMENTARY INFORMATION: Notice is being given that on June 28, 1991, the Service issued a LOA that allows the incidental, but not intentional, take of small numbers of walrus and polar bears during open water oil and gas exploration in the Chukchi Sea adjacent to the coast of Alaska. The LOA was issued under the authority of section 101(a)(5) of the Marine Mammal Protection Act (MMPA), regulations at 50 CFR 18.27, and recently issued regulations at 50 CFR part 18, Subpart I—Taking of Marine Mammals Incidental to Oil and Gas Exploration Activities in Alaska.

The LOA was issued to Shell Western E & P Inc., P.O. Box 576, Houston, Texas, 77001. It is valid for Calendar Year 1991 and is subject to the provisions of the MMPA and the above identified regulations in 50 CFR part 18.

Issuance of the LOA is based on findings that the total taking will have a negligible impact on walrus and polar bear species, and will not have an unmitigable adverse impact on the availability of these species for subsistence uses by Alaskan Natives.

Dated: July 16, 1991.

John F. Turner,
Director, U.S. Fish and Wildlife Service.

[FR Doc. 91-17728 Filed 7-25-91; 8:45 am]

BILLING CODE 4310-55-M

INTERSTATE COMMERCE COMMISSION

Intent to Engage in Compensated Intercorporate Hauling Operations

This is to provide notice as required by 49 U.S.C. 10524(b)(1) that the named corporations intend to provide or use compensated intercorporate hauling operations as authorized in 49 U.S.C. 10524(b).

A.1. Parent corporation and address of principal office:

Phelps Dodge Corporation, New York, NY 10022.

2. Wholly-owned subsidiaries which will participate in the operations, and State(s) of incorporation:

Phelps Dodge Refining Corporation, (New York).

Phelps Dodge Industries, Inc., (Delaware).
Phelps Dodge Sales Company, Inc., (Delaware).

Western Nuclear, Inc., (Delaware).
Phelps Dodge Mercantile Company, (Arizona).

Tucson Cornelia & Gila Bend Railroad, (Arizona).

Ajo Improvement Co., (Arizona).
Morenci Water & Electric Co., (Arizona).
Pacific Western Land Co., (California).
Hudson International Conductors, (New York).

Accuride Corp., (Delaware).
Columbian Chemicals Co., (Delaware).
Hudson Wire Co., d/b/a Hudson International Conductors, (New York).
Phelps Dodge Morenci, Inc., (Delaware).
Burro Chief Copper Co., (Delaware).
Phelps Dodge International Corp., (Delaware).

B.1. Parent corporation and address of principal office:

Sammons Enterprises, Inc., 300 Crescent Court, suite 700, Dallas, TX 75201.

2. Wholly-owned subsidiaries which will participate in the operations, and States of incorporation:

- (i) Mt. Valley Spring Co., State of Incorporation: Arkansas.
- (ii) Diamond Water, Inc. State of Incorporation: Arkansas.
- (iii) Water Lines, Inc. State of Incorporation: Arkansas.
- (iv) Carolina Mountain Spring Water Company, Inc. State of Incorporation: North Carolina.

C.1. The parent corporation and address of principle office:

Waste System Inc., Group, 13701 S. Kostner, Crestwood Illinois 60445.

2. Wholly-owned subsidiaries which will participate in the operations and states of incorporation:

Waste System Inc. Group, State of Incorporation Illinois.

X L Disposal Corp., State of Incorporation Illinois.

Industrial Fuels & Resources Marketing Corp., State of Incorporation Illinois.

Industrial Fuels & Resources of Indiana, State of Incorporation Indiana.

Industrial Fuels & Resources of Missouri, State of Incorporation Missouri.

Chemical Services Corp., State of Incorporation Illinois.

Community Landfill Corp., State of Incorporation Illinois.

Best Environmental Corp., State of Incorporation Illinois.

Crest Disposal Corp., State of Incorporation Illinois.

Sidney L. Strickland, Jr.,
Secretary.

[FR Doc. 91-17782 Filed 7-25-91; 8:45 am]

BILLING CODE 7035-01-M

[Finance Docket No. 31896]

Central Properties, Inc.—Control—the Central Railroad Co. of Indianapolis and the Central Railroad Co. of Indiana

AGENCY: Interstate Commerce Commission.

ACTION: Exemption.

SUMMARY: The Commission exempts from the prior approval requirements of 49 U.S.C. 11343, *et seq.*, Central Properties, Incorporated's acquisition of common control of the Central Railroad Company of Indianapolis and the Central Railroad Company of Indiana, subject to standard labor protective conditions.

DATES: The exemption will be effective on August 15, 1991. Petitions for reconsiderations must be filed by August 15, 1991.

ADDRESSES: Send pleadings referring to Finance Docket No. 31896 to:

- (1) Office of the Secretary, Case Control Branch, Interstate Commerce Commission, Washington, DC 20423.
- (2) Petitioners' representative: Carl M. Miller, 2270 Lake Avenue, suite 270, Fort Wayne, IN 46805.

FOR FURTHER INFORMATION CONTACT: Joseph H. Dettmar, (202) 275-7245. [TDD for hearing impaired (202) 275-1721.]

SUPPLEMENTARY INFORMATION: Additional information is contained in the Commission's decision. To purchase a copy of that decision, write to, call, or pick up in person from: Dynamic Concepts, Inc., room 2229, Interstate Commerce Commission Building, Washington, DC 20423. Telephone: (202) 289-4357/4359. [Assistance for the hearing impaired is available through TDD services (202) 275-1721.]

Decided: July 19, 1991.

By the Commission, Chairman Philbin, Vice Chairman Emmett, Commissioners Simmons, Phillips, and McDonald. Commissioner

Simmons dissented in part with a separate expression.

Sidney L. Strickland, Jr.,
Secretary.

[FR Doc. 91-17781 Filed 7-25-91; 8:45 am]

BILLING CODE 7035-01-M

[Docket No. AB-55 (Sub-No. 388X)]

CSX Transportation, Inc.; Abandonment Exemption in Lewis and Harrison Counties, WV

Applicant has filed a notice of exemption under 49 CFR 1152 Subpart F—Exempt Abandonments to abandon its 6.49-mile line of railroad between milepost 16.21, at McWhorter, and milepost 22.70, at Jackson's Mill, in Lewis and Harrison Counties, WV.

Applicant has certified that: (1) No local traffic has moved over the line for at least 2 years; (2) any overhead traffic on the line can be rerouted over other lines; and (3) no formal complaint filed by a user of rail service on the line (or a State or local government entity acting on behalf of such user) regarding cessation of service over the line either is pending with the Commission or with any U.S. District Court or has been decided in favor of the complainant within the 2-year period. The appropriate State agency has been notified in writing at least 10 days prior to the filing of this notice.

As a condition to use of this exemption, any employee affected by the abandonment shall be protected under Oregon Short Line R. Co.—Abandonment—Goshen, 360 I.C.C. 91 (1979). To address whether this condition adequately protects affected employees, a petition for partial revocation under 49 U.S.C. 10505(d) must be filed.

Provided no formal expression of intent to file an offer of financial assistance has been received, this exemption will be effective on August 25, 1991 (unless stayed pending reconsideration). Petitions to stay that do not involve environmental issues,¹

¹ A stay will be routinely issued by the Commission in those proceedings where an informed decision on environmental issues (whether raised by a party or by the Section of Energy and Environment in its independent investigation) cannot be made prior to the effective date of the notice of exemption. See Exemption of Out-of-Service Rail Lines, 5 I.C.C.2d 377 (1989). Any entity seeking a stay involving environmental concerns is encouraged to file its request as soon as possible in order to permit this Commission to review and act on the request before the effective date of this exemption.

formal expressions of intent to file an offer of financial assistance under 49 CFR 1152.27(c)(2),² and trail use/rail banking statements under 49 CFR 1152.29 must be filed by August 5, 1991.³ Petitions for reconsideration or requests for public use conditions under 49 CFR 1152.28 must be filed by August 15, 1991, with: Office of the Secretary, Case Control Branch, Interstate Commerce Commission, Washington, DC 20423.

A copy of any petition filed with the Commission should be sent to applicant's representative: Karen Anne Koster, 500 Water Street J150, Jacksonville, FL 32202.

If the notice of exemption contains false or misleading information, use of the exemption is void *ab initio*.

Applicant has filed an environmental report which addresses environmental or energy impacts, if any, from this abandonment.

The Section of Energy and Environment (SEE) will prepare an environmental assessment (EA). SEE will issue the EA by July 31, 1991. Interested persons may obtain a copy of the EA from SEE by writing to it (room 3219, Interstate Commerce Commission, Washington, DC 20423) or by calling Elaine Kaiser, Chief, SEE at (202) 275-7684. Comments on environmental and energy concerns must be filed within 15 days after the EA becomes available to the public.

Environmental, public use, or trail use/rail banking conditions will be imposed, where appropriate, in a subsequent decision.

Decided: July 12, 1991.

By the Commission, David M. Konschnik, Director, Office of Proceedings.

Sidney L. Strickland, Jr.,

Secretary.

[FR Doc. 91-17705 Filed 7-25-91; 8:45 am]

BILLING CODE 7035-01-M

DEPARTMENT OF JUSTICE

Lodging of Consent Decree Pursuant to the Clean Air Act

In accordance with Department policy, 28 CFR 50.7, notice is hereby given that on June 24, 1991, proposed Consent Decrees in *United States v. City of Phenix City, Alabama and CIC Insulation Company, Inc.* were submitted for lodging with the Federal District Court for the Middle District of Alabama. The United States filed this action pursuant to section 113(b) of the

Clean Air Act, 42 U.S.C. 7413(b), for alleged violations of the National Emission Standards for Hazardous Air Pollutants ("NESHAP") for asbestos. The complaint alleges that the defendants violated section 112 (c) and (e), and 113(b) of the Act, 42 U.S.C. 7412 (c), and (e), and 7413(b) and the asbestos NESHAP work practice standards requiring that asbestos be adequately wet, 40 CFR 61.147 (e)(1), during the renovation of the City Hall and Annex Building of Phenix City, Alabama. The Decrees require the defendants to pay a civil penalty totaling \$7,500 for a one day violation and obligate the defendants to comply with the asbestos NESHAP, 40 CFR 61.147(e)(1).

The Department of Justice will receive for a period of thirty (30) days from the date of this publication comments concerning the proposed Consent Decrees. Comments should be addressed to the Assistant Attorney General, Environment and Natural Resources Division, U.S. Department of Justice, P.O. Box 7611, Ben Franklin Station, Washington, DC 20044, and should refer to *United States v. City of Phenix City, Alabama and CIC Insulation Company, Inc.*, DJ # 90-5-2-1-1433.

The proposed Consent Decrees may be examined at any of the following offices: (1) The United States Attorney for the Middle District of Alabama, 500 Federal Building and Courthouse, 15 Lee Street, Montgomery, Alabama; (2) the U.S. Environmental Protection Agency, Region IV, 345 Courtland Street, Atlanta, Georgia; and (3) the Environmental Enforcement Section, Environment & Natural Resources Division, U.S. Department of Justice, 10th & Pennsylvania Avenue, NW., Washington, DC. Copies of the proposed Decrees may be obtained by mail from the Environmental Enforcement Section of the Department of Justice, Environment and Natural Resources Division, P.O. Box 7611, Benjamin Franklin Station, Washington, DC 20044-7611, or in person at the Environmental Enforcement Section Document Center, 1333 F Street, suite 600, NW., Washington, DC. Any request for a copy of the proposed Consent Decrees should be accompanied by a check for copying costs totalling \$3.00 (\$0.25 per page) payable to "Consent Decree Library."

Richard B. Stewart,

Environment & Natural Resources Division, Assistant Attorney General.

[FR Doc. 91-17733 Filed 7-25-91; 8:45 am]

BILLING CODE 4410-01-M

Drug Enforcement Administration

Max's Distributors Corp.; Revocation of Registration

On May 3, 1991, the Deputy Assistant Administrator, Office of Diversion Control, Drug Enforcement Administration (DEA) issued an Order to Show Cause to Max's Distributors Corporation (Max's Distributors) of 1325 NW. 93rd Court, Unit B-109, Miami, Florida 33172, proposing to revoke its DEA Certificate of Registration, RM0153560, and deny any pending applications for renewal of such registration as a distributor under 21 U.S.C. 823(e). The Order to Show Cause alleged that its continued registration would be inconsistent with the public interest as that term is used in 21 U.S.C. 823(e) and 824(a)(4).

The Order to Show Cause was sent to Max's Distributors by registered mail. More than thirty days have passed since the Order to Show Cause was received by Max's Distributors and the Drug Enforcement Administration has received no response thereto. Pursuant to 21 CFR 1301.54(a) and 1301.54(d), Max's Distributors is deemed to have waived its opportunity for a hearing. Accordingly, the Administrator now enters his final order in this matter without a hearing and based on the investigative file. 21 CFR 1301.57.

The Administrator finds that Max's Distributors is registered with the Drug Enforcement Administration as a distributor of controlled substances in Schedule III, IIIN, IV and V. An investigation of the firm revealed that between July 26, 1990 and February 18, 1991, Max's Distributors ordered approximately 1,240,000 dosage units of Schedule III through V controlled substances.

During a DEA inspection, initiated on February 6, 1991, Maximiliano Dedieu, the president and only corporate officer of Max's Distributors, provided the investigators with 31 customer files, claiming that these were all of his customers. A further review revealed that the DEA numbers listed on the invoices for 22 of the customers were issued to pharmacies other than those listed on the invoices. In addition, 17 of the addresses listed for the pharmacies on the invoices did not physically exist.

An accountability audit was conducted of selected controlled substances covering the period July 19, 1990 through February 6, 1991. The audit revealed shortages of approximately 841,700 dosage units and overages of approximately 30,900 dosage units.

² See *Exempt. of Rail Abandonment—Offers of Finan. Assist.*, 4 I.C.C.2d 164 (1987).

³ The Commission will accept a late-filed trail use statement so long as it retains jurisdiction to do so.

On March 19, 1991, DEA Special Agents observed Maximiliano Dedieu delivering 7,000 dosage units of glutethimide and 7,000 dosage units of acetaminophen with codeine to a laundromat. The combination of glutethimide and acetaminophen with codeine is popular with drug abusers as a heroin substitute.

On March 29, 1991, Maximiliano Dedieu was indicted in the United States District Court for the Southern District of Florida and charged with six counts of illegal distribution of controlled substances in violation of 21 U.S.C. 841(a)(1), one count of furnishing false or fraudulent information in violation of 21 U.S.C. 843(a)(4), and one count of knowingly and intentionally failing to keep a record in violation of 21 U.S.C. 843(a)(5).

The Administrator may revoke a DEA Certificate of Registration and deny any application for such registration if he determines that the continued registration of the registrant would be inconsistent with the public interest. 21 U.S.C. 823(f) and 824(a)(4). Pursuant to 21 U.S.C. 823(f), the Administrator considers the following factors in determining the public interest:

(1) The recommendation of the appropriate State licensing or disciplinary authority.

(2) The applicant's experience in dispensing, or conducting research with respect to controlled substances.

(3) The applicant's conviction record under Federal or State laws relating to the manufacture, distribution, or dispensing of controlled substances.

(4) Compliance with applicable State, Federal, or local laws relating to controlled substances.

(5) Such other conduct which may threaten the public health and safety.

It is well established that these factors are to be considered in the disjunctive, i.e., the Administrator may properly rely on any one or a combination of factors, and give each factor the weight he deems appropriate. See, *Henry J. Schwarz, Jr., M.D.*, Docket No. 83-42, 54 FR 16422 (1989); *Neveille H. Williams, D.D.S.*, Docket No. 87-47, 53 FR 23465 (1988); *David E. Trawick, D.D.S.*, Docket No. 86-69, 53 FR 5326 (1988).

Based on the evidence in the investigative file, the Administrator concludes that there is more than ample evidence to support a finding that the continued registration of Max's Distributors would be inconsistent with the public interest. No evidence of explanation or mitigating circumstances has been offered by Max's Distributors. Therefore, the Administrator concludes

that Max's Distributors' DEA registration must be revoked.

Accordingly, the Administrator of the Drug Enforcement Administration, pursuant to the authority vested in him by 21 U.S.C. 823 and 824 and 28 CFR 0.100(b), hereby orders that DEA Certificate of Registration, RM0153560, previously issued to Max's Distributors Corporation, be, and it hereby is, revoked, and any pending applications for the renewal of such registration, be, and they hereby are, denied. This order is effective August 26, 1991.

Dated: July 22, 1991

Robert C. Bonner,

Administrator of Drug Enforcement.

[FR Doc. 91-17762 Filed 7-25-91; 8:45 am]

BILLING CODE 4410-09-M

[Docket No. 90-38]

Vincent A. Sundry, D.O., Denial of Application

On April 16, 1990, the Deputy-Assistant Administrator, Office of Diversion Control, Drug Enforcement Administration (DEA) issued an Order to Show Cause to Vincent A. Sundry, D.O. (Respondent) of 1730 Alternate 19 South, suite A, Tarpon Springs, Florida 34689, proposing to deny his pending application for registration as a practitioner under 21 U.S.C. 823(f). The Order to Show Cause alleged that Respondent's registration would be inconsistent with the public interest, as that term is used in 21 U.S.C. 823(f).

Respondent, through counsel, requested a hearing on the issues raised by the Order to Show Cause and the matter was docketed before Administrative Law Judge Mary Ellen Bittner. Following prehearing procedures, a hearing was held in Washington, DC on September 10, 1990. On April 23, 1991, Judge Bittner issued her opinion and recommended ruling, findings of fact, conclusions of law and decision. No exceptions were filed to Judge Bittner's opinion and recommended ruling and on June 10, 1991, the record was transmitted to the Administrator. The Administrator has considered the record in its entirety and pursuant to 21 CFR 1316.67, hereby issues his final order in this matter based upon the findings of fact and conclusions of law as hereinafter set forth.

The administrative law judge found that on or about October 25, 1972, in the United States District Court for the Western District of Pennsylvania, Respondent was convicted of four counts of illicit sale and distribution of amphetamine, felony offenses relating to

controlled substances. On or about December 14, 1972, in the United States District court for the Western District of Pennsylvania, Respondent was also convicted of two counts of willfully and knowingly failing to make an income tax return in violation of 26 U.S.C. 7203. On or about April 27, 1981, in the United States District Court for the District of Kansas, Respondent was convicted of acquiring and obtaining possession of Schedule II non-narcotic controlled substances to be distributed and dispensed in violation of 21 U.S.C. 841(a)(1), felony offenses relating to controlled substances. At the same time, Respondent was convicted of 12 counts of causing controlled substances to be distributed and dispensed unlawfully by writing prescriptions in names other than those of the actual recipients of the prescriptions. As a result of these convictions, Respondent served about 45 days in Federal prison.

In 1982, Respondent applied for a DEA registration at an address in Florida. An Order to Show Cause was issued by DEA proposing to deny that application. Respondent requested a hearing which was ultimately scheduled for February 17, 1983, in Tampa, Florida. Government counsel appeared at the hearing, however Respondent's counsel failed to show up. Thereafter, on September 19, 1983, the then-Acting Administrator denied Respondent's application in a final order published in the *Federal Register*, Volume 48, at page 43415 on September 23, 1983.

In October 1982, while Respondent's 1982 application for registration was pending, the Pinellas County, Florida, Sheriff's Office initiated an investigation of Respondent's controlled substance handling practices after receiving information that Respondent was writing prescriptions for controlled substances without being registered by DEA. The investigation revealed that Respondent did, in fact, write prescriptions for controlled substances for various individuals knowing that he was not registered with DEA and, therefore, not authorized to write such prescriptions. As a result of this investigation, Respondent was convicted in a Florida State court on or about August 24, 1983, after pleading *nolo contendere* to thirteen counts of sale or delivery of controlled substances in violation of the Florida Comprehensive Drug Abuse Prevention and Control Act, felony offenses relating to controlled substances.

Respondent then submitted two applications for registration with DEA, one dated November 28, 1986, and the other dated February 26, 1987. A hearing

was held regarding these applications, during which Respondent, assisted by counsel, called numerous witnesses who testified that they were very satisfied with the care and treatment Respondent provided them. Thereafter, on May 16, 1988, the Administrator of the Drug Enforcement Administration denied Respondent's applications for registration in a final order published in the Federal Register, Volume 53, at page 17257.

Subsequently, in July 1989, Respondent submitted the application for registration which is the subject of these proceedings. At the hearing in this matter, Respondent testified that he needed his DEA registration in order to obtain hospital privileges. In addition, Respondent offered into evidence a letter from the Florida Department of Professional Regulations, Board of Osteopathic Medical Examiners indicating that in October 1987, the Board voted to allow Respondent to apply to the Drug Enforcement Administration for a DEA Certificate of Registration.

The Administrator may deny an application for a DEA Certificate of Registration if he determines that the registration would be inconsistent with the public interest. Pursuant to 21 U.S.C. 823(f), "[i]n determining the public interest, the following factors will be considered:

- (1) The recommendation of the appropriate State licensing board or disciplinary authority.
- (2) The applicant's experience in dispensing, or conducting research with respect to controlled substances.
- (3) The applicant's conviction record under Federal or State laws relating to the manufacture, distribution, or dispensing of controlled substances.
- (4) Compliance with applicable State, Federal, or local laws relating to controlled substances.
- (5) Such other conduct which may threaten the public health or safety."

It is well established that these factors are to be considered in the disjunctive, i.e., the Administrator may properly rely on any one or a combination of factors, and give each factor the weight he deems appropriate. See, *Henry J. Schwarz, Jr., M.D.*, Docket No. 88-42, 54 Fed. Reg. 16422 (1989); *Neveille H. Williams, D.D.S.*, Docket No. 87-47, 53 Fed. Reg. 23465 (1988); *David E. Trawick, D.D.S.*, Docket No. 86-69, 53 Fed. Reg. 5328 (1988).

The administrative law judge concluded that the record clearly establishes that Respondent has repeatedly abused the authority granted by his DEA registration. Respondent contends, however, that since the

Government did not introduce any new evidence regarding his unsuitability for a DEA registration since the previous hearing in 1987, he should be trusted with a DEA registration. The administrative law judge disagreed and recommended that Respondent's application for registration should be denied.

Respondent contends that he "is much older and wiser and recommitted to staying within the bounds of proper procedure." Respondent also testified that he would "quit practice" if he ever thought he "couldn't be trusted." The administrative law judge concluded that Respondent's assertions are not persuasive given his history of serious mishandling of controlled substances. In addition, Judge Bittner concluded that Respondent does not appear to be conversant with current regulations regarding the handling of controlled substances, and although he has not handled controlled substances in some years, his lack of knowledge of proper controlled substance handling is a further indication that he is not able at the present time to carry out the responsibilities of a DEA registrant.

The administrative law judge recognized that a DEA registration may be a necessary condition for obtaining hospital privileges, however, DEA does not register individuals to enable them to obtain hospital privileges. Registrations under the Controlled Substances Act are issued for one purpose—to enable the registrant to lawfully handle controlled substances.

Respondent's three felony convictions relating to controlled substances and his failure to demonstrate that he would use controlled substances more responsibly in the future, led the administrative law judge to conclude that Respondent's registration would not be in the public interest, and to recommend that Respondent's application for such registration should be denied. The Administrator adopts the opinion and recommended ruling, findings of fact, conclusions of law and decision of the administrative law judge in its entirety.

Accordingly, the Administrator of the Drug Enforcement Administration, pursuant to the authority vested in him by 21 U.S.C. 823 and 28 CFR 0.100(b), hereby orders that the application for registration, executed on July 21, 1989, by Vincent A. Sundry, D.O., be, and it hereby is, denied. This order is effective July 26, 1991.

Dated: July 22, 1991.

Robert C. Bonner,
Administrator of Drug Enforcement.
[FR Doc. 91-17761 Filed 7-25-91; 8:45 am]

BILLING CODE 4410-09-M

DEPARTMENT OF LABOR

Office of the Secretary

Agency Recordkeeping/Reporting Requirements Under Review by the Office of Management and Budget (OMB)

Background

The Department of Labor, in carrying out its responsibilities under the Paperwork Reduction Act (44 U.S.C. chapter 35), considers comments on the reporting and recordkeeping requirements that will affect the public.

List of Recordkeeping/Reporting Requirements Under Review

As necessary, the Department of Labor will publish a list of the Agency recordkeeping/reporting requirements under review by the Office of Management and Budget (OMB) since the last list was published. The list will have all entries grouped into new collections, revisions, extensions, or reinstatements. The Departmental Clearance Officer will, upon request, be able to advise members of the public of the nature of the particular submission they are interested in.

Each entry may contain the following information:

The Agency of the Department issuing this recordkeeping/reporting requirement.

The title of the recordkeeping/reporting requirement.

The OMB and Agency identification numbers, if applicable.

How often the recordkeeping/reporting requirement is needed.

Who will be required to or asked to report or keep records.

Whether small businesses or organizations are affected.

An estimate of the total number of ours needed to comply with the recordkeeping/reporting requirements and the average hours per respondent.

The number of forms in the request for approval, if applicable.

An abstract describing the need for and uses of the information collection.

Comments and Questions

Copies of the recordkeeping/reporting requirements may be obtained by calling the Departmental Clearance Officer, Paul E. Larson, telephone (202) 523-6331. Comments and questions about the items on this list should be directed to Mr. Larson, Office of Information Management, U.S. Department of Labor, 200 Constitution Avenue NW., room N-1301, Washington, DC 20210. Comments should also be sent to the Office of

Information and Regulatory Affairs, Attn: OMB Desk Office for (BLS/DM/ESA/ETA/OLMS/MSHA/OSHA/PWBA/VETS), Office of Management and Budget, room 3208, Washington, DC 20503 (telephone (202) 395-6880).

Any member of the public who wants to comment on a recordkeeping/reporting requirement which has been submitted to OMB should advise Mr. Larson of this intent at the earliest possible date.

Revision

Employment Standards Administration

FECA Medical Report Forms 1215-0103; CA 16B; 17B; 20; 20A; 1090; 1302; 1303; 1305; 1306; 1314; 1316; 1331; 1332; and OWCP-5.

As needed.

Businesses or other for profit.

466,950 respondents; 175,697 total hours; .08-.75 hrs. per response; 14 forms.

Information obtained through the use of FECA Medical Report Forms is necessary to determine whether or not a federal employee who has filed a claim under the Federal Employees' Compensation Act (FECA), is entitled to compensation.

Assistant Secretary for Veterans' Employment and Training

Implementing Regulations for Veterans' Employment and Programs under Title IV, Part C of the Job Training Partnership Act 1293-0001.

Other (at time of application for grant).

State or local governments; non-profit institutions 50 responses; 1,600. Average hours per response 32 hours. The information is needed as the basis upon which the cost-effectiveness of the program proposed by the grant application will be evaluated. It is the primary focus of the application for funding used for approving or denying the application for funds under Title IV-C of JTPA.

Employment and Training Administration

Overpayment Detection/Recovery Activities.

1205-0173; ETA 227.

Quarterly

State or local governments.

53 respondents; 7,240 total hours; 10 hrs. per response; 1 form.

100 hrs. (One-Time only burden).

The Secretary has interpreted applicable section of Federal laws, to require States to have reasonable provisions in their State UI laws that

concern the prevention, detection and recovery of benefit overpayments caused by willful misrepresentation or errors by claimants or others. This report provides an accounting of the types and amounts of such overpayments and serves as a useful management tool for monitoring overall UI program integrity.

Extension

Mine Safety and Health Administration

Application for Use of Nonpermissible Explosives and Nonpermissible Shot-firing Units.

1219-0025.

On occasion.

Businesses or other for profit; small businesses or organizations.

75 applications; 1 hour per response; 75 total burden hours.

Provides a procedure by which a coal mine operator may apply for and get a permit to use nonpermissible explosives and shotfiring.

Employment and Training Administration

Senior Community Service Employment Program; Program Report and Grant Package.

1205-0040; ETAs 5-163, 5140, 8705; SFs 424&424A, 269.

| Form No. | Affected public | Respondents | Frequency | Average time per response |
|---|-------------------|-------------|-----------|---------------------------|
| ETA 5-163 | State/Local govt. | 67 | 1 | 40 hrs. |
| ETA 5140 | do. | 67 | 4 | 8 hrs. |
| ETA 8705 | do. | 67 | 1 | 12 hrs. |
| Posting | do. | 67 | 1 | 2 hrs. 59 min. |
| SF 424 & 424A | do. | 67 | 1 | 5 hrs. |
| SF 269 | do. | 67 | 4 | 8 hrs. |
| 5,493 total hours * | | | | |
| (* This total does not include 2479 hrs. for Standard Form activity). | | | | |

The four forms included in this package are needed to manage the Senior Community Service Employment Program (SCSEP). These documents are the sources of Program plans, performance data and resource allocation. They form the basis for the award of funds, Federal oversight and reports.

Mine Safety and Health Administration

Qualified Person, Explosives and

Blasting.

1219-0106.

On occasion.

Businesses or other for profit; small businesses or organizations 50

responses per year; 0.08 minutes per response.

Requires that blasting in underground coal mines be performed by a qualified person or a person working in the presence of and under the direction of a qualified person. Persons wishing to become qualified by MSHA contact the District Manager and arrange for a demonstration of ability. An MSHA inspector will observe the applicant during normal mining practices, therefore, no burden has been calculated for this function. The burden would be limited to a brief telephone call requesting that the person be qualified to use explosives. MSHA estimates that the telephone call would be no more than 5 minutes (0.08 hour) in duration. It is anticipated that MSHA will receive approximately 50 applications per year.

Signed at Washington, DC this 23rd day of July, 1991.

Paul E. Larson,

Departmental Clearance Officer.

[FR Doc. 91-17791 Filed 7-25-91; 8:45 am]

BILLING CODE 4510-30-M

Employment Standards Administration, Wage and Hour Division

Minimum Wages for Federal and Federally Assisted Construction; General Wage Determination Decisions

General wage determination decisions of the Secretary of Labor are issued in accordance with applicable law and are

based on the information obtained by the Department of Labor from its study of local wage conditions and data made available from other sources. They specify the basic hourly wage rates and fringe benefits which are determined to be prevailing for the described classes of laborers and mechanics employed on construction projects of a similar character and in the localities specified therein.

The determinations in these decisions of prevailing rates and fringe benefits have been made in accordance with 29 CFR part 1, by authority of the Secretary of Labor pursuant to the provisions of the Davis-Bacon Act of March 3, 1931, as amended (46 Stat. 1494, as amended, 40 U.S.C. 276a) and of other Federal statutes referred to in 29 CFR part 1, Appendix, as well as such additional statutes as may from time to time be enacted containing provisions for the payment of wages determined to be prevailing by the Secretary of Labor in accordance with the Davis-Bacon Act. The prevailing rates and fringe benefits determined in these decisions shall, in accordance with the provisions of the foregoing statutes, constitute the minimum wages payable on Federal and federally assisted construction projects to laborers and mechanics of the specified classes engaged on contract work of the character and in the localities described therein.

Good cause is hereby found for not utilizing notice and public comment procedure thereon prior to the issuance of these determinations as prescribed in 5 U.S.C. 553 and not providing for delay in the effective date as prescribed in that section, because the necessity to issue current construction industry wage determinations frequently and in large volume causes procedures to be impractical and contrary to the public interest.

General wage determination decisions, and modifications and supersedeas decisions thereto, contain no expiration dates and are effective from their date of notice in the *Federal Register*, or on the date written notice is received by the agency, whichever is earlier. These decisions are to be used in accordance with the provisions of 29 CFR parts 1 and 5. Accordingly, the applicable decision, together with any modifications issued, must be made a part of every contract for performance of the described work within the geographic area indicated as required by an applicable Federal prevailing wage law and 29 CFR part 5. The wage rates and fringe benefits, notice of which is published herein, and which are contained in the Government Printing

Office (GPO) document entitled "General Wage Determinations Issued Under The Davis-Bacon And Related Acts," shall be the minimum paid by contractors and subcontractors to laborers and mechanics.

Any person, organization, or governmental agency having an interest in the rates determined as prevailing is encouraged to submit wage rate and fringe benefit information for consideration by the Department. Further information and self-explanatory forms for the purpose of submitting this data may be obtained by writing to the U.S. Department of Labor, Employment Standards Administration, Wage and Hour Division, Division of Wage Determinations, 200 Constitution Avenue, NW., room S-3014, Washington, DC 20210.

Modifications to General Wage Determination Decisions

The numbers of the decisions listed in the Government Printing Office document entitled "General Wage Determinations Issued Under the Davis-Bacon and Related Acts" being modified are listed by Volume, State, and page number(s). Dates of publication in the *Federal Register* are in parentheses following the decisions being modified.

Volume I

- Alabama AL91-27(Feb. 22, 1991). p. 53, p. 54.
 District of Columbia DC91-1(Feb. 22, 1991). p. 79, pp. 80-90.
 Florida:
 FL91-17(Feb. 22, 1991).. p. 141, pp. 142-144.
 FL91-48(Feb. 22, 1991).. p. 218c, p. 218c.
 Georgia GA91-3(Feb. 22, 1991). p. 223, pp. 224-228.
 Massachusetts MA91-1(Feb. 22, 1991). p. 421, pp. 422-436.
 New York:
 NY91-2(Feb. 22, 1991)... p. 777, pp. 778-796b,
 NY91-5(Feb. 22, 1991)... p. 817, pp. 818-825.
 NY91-11(Feb. 22, 1991). p. 885, pp. 886-892.
 NY91-14(Feb. 22, 1991). p. 911, pp. 912-914.
 NY91-15(Feb. 22, 1991). p. 915, pp. 916-920b.

Volume II

- Alabama AL91-27(Feb. 22, 1991). p. 1, p. 2.
 Indiana:
 IN91-1(Feb. 22, 1991).... p. 243, pp. 245-247.
 IN91-2(Feb. 22, 1991).... p. 259, pp. 264-265.
 IN91-6(Feb. 22, 1991).... p. 315, pp. 316-334b.
 Kansas:
 KS91-6(Feb. 22, 1991) ... p. 360, pp. 364-365.
 KS91-8(Feb. 22, 1991) ... p. 373, pp. 375-380.
 Michigan:
 MI91-3(Feb. 22, 1991) ... p. 477, pp. 478-490b.
 MI91-7(Feb. 22, 1991) ... p. 515.

- Minnesota MN91-7(Feb. 22, 1991). p. 587, pp. 588-606b.
 Ohio OH91-1(Feb. 22, 1991). p. 809, pp. 810-820b.
 Wisconsin WI91-4(Feb. 22, 1991). p. 1209, pp. 1210-1211.

Volume III

- Montana MT91-5(Feb. 22, 1991). p. 271, p. 272.
 Oregon OR91-1(Feb. 22, 1991). p. 371, pp. 372-388.
 Washington WA91-5(Feb. 22, 1991). p. 495, pp. 496-498a.

General Wage Determination Publication

General wage determinations issued under the Davis-Bacon and related Acts, including those noted above, may be found in the Government Printing Office (GPO) document entitled "General Wage Determinations Issued Under The Davis-Bacon And Related Acts". This publication is available at each of the 50 Regional Government Depository Libraries and many of the 1,400 Government Depository Libraries across the country. Subscriptions may be purchased from: Superintendent of Documents, U.S. Government Printing Office, Washington, DC 20402, (202) 783-3238.

When ordering subscription(s), be sure to specify the State(s) of interest, since subscriptions may be ordered for any or all of the three separate volumes, arranged by State. Subscriptions include an annual edition (issued on or about January 1) which includes all current general wage determinations for the States covered by each volume. Throughout the remainder of the year, regular weekly updates will be distributed to subscribers.

Signed at Washington, DC this 19th day of July, 1991.

Alan L. Moss,

Director, Division of Wage Determinations.

[FR Doc. 91-17663 Filed 7-25-91; 8:45 am]

BILLING CODE 4510-27-M

Employment and Training Administration

[TA-W-25,640]

CAC Microcircuits, Inc., Mt. Carmel, IL; Dismissal of Application for Reconsideration

Pursuant to 29 CFR 90.18 an application for administrative reconsideration was filed with the Director of the Office of Trade Adjustment Assistance for workers at CAC Microcircuits, Incorporated, Mt.

Carmel, Illinois. The review indicated that the application contained no new substantial information which would bear importantly on the Department's determination. Therefore, dismissal of the application was issued.

TA-W-25,640; CAC Microcircuits, Incorporated, Mt. Carmel, Illinois (July 16, 1991).

Signed at Washington, DC this 17th day of July, 1991.

Marvin M. Fooks,

Director, Office of Trade Adjustment Assistance.

[FR Doc. 91-17786 Filed 7-25-91; 8:45 am]

BILLING CODE 4510-30-M

Investigations Regarding Certifications of Eligibility to Apply for Worker Adjustment Assistance; Carborundum Abrasives Co. et al.

Petitions have been filed with the

Secretary of Labor under section 221(a) of the Trade Act of 1974 ("the Act") and are identified in the appendix to this notice. Upon receipt of these petitions, the Director of the Office of Trade Adjustment Assistance, Employment and Training Administration, has instituted investigations pursuant to section 221(a) of the Act.

The purpose of each of the investigations is to determine whether the workers are eligible to apply for adjustment assistance under title II, chapter 2, of the Act. The investigations will further relate, as appropriate, to the determination of the date on which total or partial separations began or threatened to begin and the subdivision of the firm involved.

The petitioners or any other persons showing a substantial interest in the subject matter of the investigations may request a public hearing, provided such

request is filed in writing with the Director, Office of Trade Adjustment Assistance, at the address shown below, not later than August 5, 1991.

Interested persons are invited to submit written comments regarding the subject matter of the investigations to the Director, Office of Trade Adjustment Assistance, at the address shown below, not later than August 5, 1991.

The petitions filed in this case are available for inspection at the Office of the Director, Office of Trade Adjustment Assistance, Employment and Training Administration, U.S. Department of Labor, 200 Constitution Avenue NW., Washington, DC 20210.

Signed at Washington, DC this 15th day of July 1991.

Marvin M. Fooks,

Director, Office of Trade Adjustment Assistance.

APPENDIX

| Petitioner: Union/workers/firm | Location | Date received | Date of petition | Petition No. | Articles produced |
|--|----------------------|---------------|------------------|--------------|------------------------------------|
| Carborundum Abrasives Co. (OCAW) | Niagara Falls, NY | 07/15/91 | 07/02/91 | 26,057 | Sand paper. |
| Center Tool and Machine (wkrs) | Cheboygan, MI | 07/15/91 | 07/01/91 | 26,058 | Automatic feeder systems for ford. |
| Dietzgen Corp. (wkrs) | El Paso, TX | 07/15/91 | 06/28/91 | 26,059 | Blue print copiers. |
| Edwards-Warren Tire Co. (URW) | Bloomington, IL | 07/15/91 | 06/27/91 | 26,060 | Earth moving tires. |
| Federal Deposit Insurance Corp. (wkrs) | Midland, TX | 07/15/91 | 07/01/91 | 26,061 | Government insurance for money. |
| General Dynamics (wkrs) | Fort Worth, TX | 07/15/91 | 06/29/91 | 26,062 | Aircraft wiring harnesses. |
| General Motors Corp., CPC (UAW) | Tarrytown, NY | 07/15/91 | 07/03/91 | 26,063 | Van assembly. |
| Hi-Tech Manufacturing (wkrs) | Longmont, CO | 07/15/91 | 06/20/91 | 26,064 | Flex-leads, spin motors. |
| International Boiler Works Co. (wkrs) | East Stroudsburg, PA | 07/15/91 | 07/01/91 | 26,065 | Power boilers. |
| Jerrold Communications (Co) | Tucson, AZ | 07/15/91 | 06/03/91 | 26,066 | Cable TV electronics products. |
| John B. Harris, Inc. (UMWA) | Lewisburgh, WV | 07/15/91 | 06/18/91 | 26,067 | Metallurgical coal. |
| Johnson Controls, Inc. (wkrs) | Erie, PA | 07/15/91 | 07/02/91 | 26,068 | Plastic radiator end tanks. |
| K and G Manufacturing (wkrs) | Faribault, MN | 07/15/91 | 06/05/91 | 26,069 | Carriages. |
| Louisiana Garment Co. (wkrs) | Louisiana, MO | 07/15/91 | 07/02/91 | 26,070 | Jackets, shorts, lingerie, shirts. |
| Nice Specialty Bearings (USWA) | Kulpsville, PA | 07/15/91 | 06/18/91 | 26,071 | Ball bearings for automobiles. |
| Occidental Chemical (wkrs) | Columbia, TN | 07/15/91 | 07/03/91 | 26,072 | Phosphorus. |
| Ogden Services, Inc. (wkrs) | Oklahoma City, OK | 07/15/91 | 07/02/91 | 26,073 | Tires. |
| Olin Chemicals Joliet (OCWA) | Joliet, IL | 07/15/91 | 07/01/91 | 26,074 | Phosphates. |
| Oryx Energy Co. (Co.) | Dallas, TX | 07/15/91 | 06/26/91 | 26,075 | Crude oil, gas exploration. |
| Oryx Energy Co. Gulf Coast Prod. (Co) | Houston, TX | 07/15/91 | 06/26/91 | 26,076 | Crude oil and gas exploration. |
| Oryx Energy Co. Mid Continent Prod. (Co) | Oklahoma City, OK | 07/15/91 | 06/26/91 | 26,077 | Crude oil and gas exploration. |
| Oryx Energy Co. Southwestern Prod. (Co) | Midland, TX | 07/15/91 | 06/26/91 | 26,078 | Crude oil and gas exploration. |
| Seagate Technology (wkrs) | Bloomington, MN | 07/15/91 | 06/14/91 | 26,079 | Hard disc drive. |
| Sensus Technologies, Inc. (USWA) | Uniontown, PA | 07/15/91 | 07/05/91 | 26,080 | Sealed registers, water meters. |
| Teledyne Pittsburgh Tool Steel Wire (USWA) | Monaca, PA | 07/15/91 | 06/12/91 | 26,081 | Hexagon steel and other shapes. |
| Triumph Machine Corp. (USWA) | Hackettstown, NJ | 07/15/91 | 06/28/91 | 26,082 | Highway mowing equipment. |
| Union Metal, Eastern Division (USWA) | East Stroudsburg, PA | 07/15/91 | 07/05/91 | 26,083 | Steel metal light poles. |
| Unocal Corp., Energy Mining Div. (Co) | Parachute, CO | 07/15/91 | 07/03/91 | 26,084 | Crude oil. |
| USX Corp., Clairton Works (USWA) | Clairton, PA | 07/15/91 | 07/02/91 | 26,085 | Coke. |
| Wire Rope Corp. of America (wkrs) | Kansas City, MO | 07/15/91 | 06/17/91 | 26,086 | Steel wire and cable. |
| Woodings-Verona Tool Works (wkrs) | Verona, PA | 07/15/91 | 06/26/91 | 26,087 | Hand tools. |
| Woodings-Verona Tool Works (wkrs) | Columbiana, OH | 07/15/91 | 06/26/91 | 26,088 | Hand tools. |
| Woodings-Verona Tool Works (wkrs) | Falls City, NE | 07/15/91 | 08/26/91 | 26,089 | Hand tools. |

[FR Doc. 91-17785 Filed 7-25-91; 8:45 am]

BILLING CODE 4510-30-M

[TA-W-24,702]

Tektronix, Inc., Visual Systems Group, Wilsonville, OR and Operating at Various Locations in the Following States

TA-W-24,702A—Alabama
TA-W-24,702B—Alaska

TA-W-24,702C—Arizona
TA-W-24,702D—California
TA-W-24,702E—Colorado
TA-W-24,702F—Connecticut
TA-W-24,702G—Florida
TA-W-24,702H—Georgia
TA-W-24,702I—Illinois
TA-W-24,702J—Indiana

TA-W-24,702K—Maryland
 TA-W-24,702L—Massachusetts
 TA-W-24,702M—Maine
 TA-W-24,702N—Michigan
 TA-W-24,702O—Minnesota
 TA-W-24,702P—Missouri
 TA-W-24,702Q—New Jersey
 TA-W-24,702R—New Mexico
 TA-W-24,702S—New York
 TA-W-24,702T—North Carolina
 TA-W-24,702U—Ohio
 TA-W-24,702V—Oklahoma
 TA-W-24,702W—Oregon (except
 Wilsonville)
 TA-W-24,702X—Pennsylvania
 TA-W-24,702Y—Tennessee
 TA-W-24,702Z—Texas
 TA-W-24,702AA—Utah
 TA-W-24,702AB—Virginia
 TA-W-24,702AC—Washington
 TA-W-24,702AD—Washington, DC
 TA-W-24,702AE—Wisconsin
 TA-W-24,702AF—Rhode Island

Amended Certification Regarding Eligibility to Apply for Worker Adjustment Assistance

In accordance with section 223 of the Trade Act of 1974 (19 USC 2273) the Department of Labor issued a Certification of Eligibility to Apply for Worker Adjustment Assistance on October 31, 1990 applicable to all workers of the Visual Systems Group of Tektronix, Inc., Wilsonville, Oregon. The certification notice was published in the Federal Register on November 14, 1990 (55 FR 47550). The certification was subsequently amended on February 21, 1991 to reflect the correct worker group. The amended certification was published in the Federal Register on March 5, 1991 (56 FR 9236).

At the request of the State Agency, the Department reviewed the amended certification. New information from the company indicates that the State of Rhode Island was not included in the certification. The intent of the certification is to cover all workers of the Visual Systems Group of Tektronix, Inc. who were adversely affected by increased imports of articles like or directly competitive with work stations and network display terminals. The amended notice applicable to TA-W-24,702 is hereby issued as follows:

All workers of Tektronix, Inc., Visual Systems Group, Wilsonville, Oregon and in locations in the following States of Alabama, Alaska, Arizona, California, Colorado, Connecticut, Florida, Georgia, Illinois, Indiana, Massachusetts, Maryland, Maine, Michigan, Minnesota, Missouri, New Jersey, New Mexico, New York, North Carolina, Ohio, Oklahoma, Oregon (except Wilsonville), Pennsylvania, Tennessee, Texas, Utah, Virginia, Washington, Washington, DC, Wisconsin and Rhode Island who became totally or partially separated from employment on or after July 21, 1989 are

eligible to apply for adjustment assistance under section 223 of the Trade Act of 1974.

Signed at Washington, DC, this 19th day of July 1991.

Marvin M. Fooks,
 Director, Office of Trade Adjustment Assistance.

[FR Doc. 91-17790 Filed 7-25-91; 8:45 am]

BILLING CODE 4510-30-M

Federal-State Unemployment Compensation Program Extended Benefits; Ending of Extended Benefit Period in the State of West Virginia

This notice announces the ending of the Extended Benefit Period in the State of West Virginia, effective on July 13, 1991.

Background

The Federal-State Extended Unemployment Compensation Act of 1970 (26 U.S.C. 3304 note) established the Extended Benefit Program as a part of the Federal-State Unemployment Compensation Program. Under the Extended Benefit Program, individuals who have exhausted their rights to regular unemployment benefits (UI) under permanent State (and Federal) unemployment compensation laws may be eligible, during an extended benefit period, to receive up to 13 weeks of extended unemployment benefits, at the same weekly rate of benefits as previously received under the State law. The Federal-State Extended Unemployment Compensation Act is implemented by State unemployment compensation laws and by part 615 of title 20 of the Code of Federal Regulations (20 CFR part 615).

Extended Benefits are payable in a State during an Extended Benefit Period which is triggered "on" when the rate of insured unemployment in the State reached the State trigger rate set in the Act and the State law. During an Extended Benefit Period, individuals are eligible for a maximum of up to 13 weeks of benefits, but the total of Extended Benefits and regular benefits together may not exceed 39 weeks.

The Act and the State unemployment compensation laws also provide that an Extended Benefit Period in a State will trigger "off" when the rate of insured unemployment in the State is no longer at the trigger rate set in the law. A benefit period actually terminates at the end of the third week after the week for which there is an off indicator, but not less than 13 weeks after the benefit period began.

An Extended Benefit Period commenced in the State of West

Virginia on April 14, 1991, and has now triggered off.

Determination of an "off" Indicator

The head of the employment security agency of the State named above has determined that the rate of insured unemployment in the State for the period consisting of the week ending on June 22, 1991, and the immediately preceding twelve weeks, fell below the State trigger rate, so that for that week there was an "off" indicator in the State.

Therefore, the Extended Benefit Period in the State terminated with the week ending July 13, 1991.

Information for Claimants

The State employment security agency will furnish a written notice to each individual who is filing claims for Extended Benefits of the ending of the Extended Benefit Period and its effect on the individual's right to Extended Benefits, 20 CFR 615.13(c)(4).

Persons who wish information about their rights to Extended Benefits in the State named above would contact the nearest State employment service office in their locality.

Signed at Washington, DC on July 19, 1991.

Roberts T. Jones,
 Assistant Secretary of Labor.

[FR Doc. 91-17784 Filed 7-25-91; 8:45 am]

BILLING CODE 4510-30-M

Federal-State Unemployment Compensation Program Extended Benefits; Ending of Extended Benefit Period in the State of Vermont

This notice announces the ending of the Extended Benefit Period in the State of Vermont, effective on July 13, 1991.

Background

The Federal-State Extended Unemployment Compensation Act of 1970 (26 U.S.C. 3304 note) established the Extended Benefit Program as a part of the Federal-State Unemployment Compensation Program. Under the Extended Benefit Program, individuals who have exhausted their rights to regular unemployment benefits (UI) under permanent State (and Federal) unemployment compensation laws may be eligible, during an extended benefit period, to receive up to 13 weeks of extended unemployment benefits, at the same weekly rate of benefits as previously received under the State law. The Federal-State Extended Unemployment Compensation Act is implemented by State unemployment compensation laws and by part 615 of

title 20 of the code of Federal Regulations (20 CFR part 615).

Extended Benefits are payable in a State during an Extended Benefit Period which is triggered "on" when the rate of insured unemployment in the State reached the State trigger rate set in the Act and the State law. During an Extended Benefit Period, individuals are eligible for a maximum of up to 13 weeks of benefits, but the total of Extended Benefits and regular benefits together may not exceed 39 weeks.

The Act and the State unemployment compensation laws also provide that an Extended Benefit Period in a State will trigger "off" when the rate of insured unemployment in the State is no longer at the trigger rate set in the law. A benefit period actually terminates at the end of the third week after the week for which there is an off indicator, but not less than 13 weeks after the benefit period began.

An Extended Benefit Period commenced in the State of Vermont on March 17, 1991, and has now triggered off.

Determination of an "off" Indicator

The head of the employment security agency of the State named above has determined that the rate of insured unemployment in the State for the period consisting of the week ending on June 22, 1991, and the immediately preceding twelve weeks, fell below the State trigger rate, so that for that week there was an "off" indicator in the State.

Therefore, the Extended Benefit Period in the State terminated with the week ending July 13, 1991.

Information for Claimants

The State employment security agency will furnish a written notice to each individual who is filing claims for Extended benefits of the ending of the Extended Benefit Period and its effect on the individual's right to Extended Benefits, 20 CFR 615.13(c)(4).

Persons who wish information about their rights to Extended Benefits in the State named above would contract the nearest State employment service office in their locality.

Signed at Washington, DC on July 19, 1991.

Roberts T. Jones,
Assistant Secretary of Labor.

[FR Doc. 91-17783 Filed 7-25-91; 8:45 am]

BILLING CODE 4510-30-M

[TA-W-25,489]

Cooper Industries, Inc., Bussmann Division, Bristol, CT; Negative Determination Regarding Application for Reconsideration

By an application dated May 31, 1991, Local 260 of the International Union of Electrical Workers (IUE) requested administrative reconsideration of the subject petition for trade adjustment assistance. The denial notice was signed on April 26, 1991 and published in the Federal Register on May 21, 1991 (56 FR 23301).

Pursuant to 29 CFR 90.18(c) reconsideration may be granted under the following circumstances:

- (1) If it appears on the basis of facts not previously considered that the determination complained of was erroneous;
- (2) If it appears that the determination complained of was based on a mistake in the determination of facts not previously considered; or
- (3) If in the opinion of the Certifying Officer, a misinterpretation of facts or of the law justified reconsideration of the decision.

The union claims that Bussmann began transferring production from Bristol to foreign sources beginning in 1989 and that the Department's survey of customers was flawed because Bussmann is importing articles. Its also claimed that the decline in U.S. imports was not an absolute decrease since the U.S. market was also experiencing a similar reduction.

The Bristol plant produced power fuses and high speed fuses. Bristol closed on March 28, 1991. Sales and production of power fuses at Bristol increased in 1990 compared to 1989 while high speed fuses were discontinued and replaced by another product produced at Ellisville, Missouri.

During the period from April 10, 1989 to March 28, 1991 the preponderant share of Bristol's production was transferred to other domestic corporate facilities while a small amount was transferred to Mexico—affecting less than (5) five percent of the plant work force. Workers were not separately identifiable by product. Accordingly, there is no basis for a worker group certification.

With respect to the union's claim concerning reducers and semi-trons, the reducers were transferred to Goldsboro in early 1989 and semi-trons to Denmark in April, 1989. These production transfers would not form a basis for a worker group certification since they either were domestic transfers or occurred more than one year prior to the

date of the worker petition. Section 223(b)(1) of the Trade Act does not permit the certification of workers laid off more than one year prior to the date of the petition.

Also, other findings obtained during the investigation show that box covers, switches, adapters and receptacle products were never made in Bristol.

The Department's denial was not based on an absolute decline in U.S. imports of fuses in the first six months of 1990 compared to the same period in 1989 but on the fact that the "contributed importantly" test of the Group Eligibility Requirements of the Trade Act was not met. This test is generally demonstrated through a survey of the workers' firm's customers. The Department's survey of Bussmann's major declining customers shows that none imported fuses during the relevant period. Also, company imports are not part of the customer survey but are obtained directly from the company.

According to company officials, there is a negative impact on the domestic demand for U.S. fuses because of imported machinery which is designed to different standards and does not use U.L. power fuses. The courts, however, have ruled in the Bedell case, *United Shoe Workers of America, AFL-CIO v. Bedell*, 506 F2d (DC Circ. 1974) that this type of foreign competition would not serve as a basis for trade adjustment assistance i.e., the finished article (imported machinery) is not like or directly competitive with the component article (fuses).

Conclusion

After review of the application and investigative findings, I conclude that there has been no error or misinterpretation of the law or of the facts which would justify reconsideration of the Department of Labor's prior decision. Accordingly, the application is denied.

Signed at Washington, DC, this 18th day of July 1991.

Robert O. Deslongchamps,
Director, Office of Legislation & Actuarial Services, Unemployment Insurance Service.
[FR Doc. 91-17787 Filed 7-25-91; 8:45 am]

BILLING CODE 4510-30-M

[TA-W-25,545]

F-Dyne Electronics, Inc., Bridgeport, CT; Negative Determination Regarding Application for Reconsideration

By an application dated June 13, 1991, Local #299 of the United Electrical Workers (UE) requested administrative

reconsideration of the subject petition for trade adjustment assistance. The denial notice was signed on May 14, 1991 and published in the *Federal Register* on May 30, 1991 (56 FR 24414).

Pursuant to 29 CFR 90.18(c) reconsideration may be granted under the following circumstances:

(1) If it appears on the basis of facts not previously considered that the determination complained of was erroneous;

(2) If it appears that the determination complained of was based on a mistake in the determination of facts not previously considered; or

(3) If in the opinion of the Certifying Officer, a misinterpretation of facts or of the law justified reconsideration of the decision.

The workers produced film capacitors. The plant ceased operations in May, 1991.

The union claims that competition from off-shore firms has substantially contributed to the inability of the F-Dyne to make a profit. Its also claimed that the union was never notified of the investigation.

With respect to the union's claims, the Department did contact the union petitioner as soon as the investigation was instituted. Also, the inability to make a profit is not a worker group criterion for certification.

The Department's denial was based on the fact that the "contributed importantly" test of the Group Eligibility Requirements of the Trade Act was not met. The "contributed importantly" test is generally demonstrated through a survey of the workers' firm's customers. The Department's survey showed that none of the surveyed customers imported capacitors during the relevant period.

Conclusion

After review of the application and investigative findings, I conclude that there has been no error or misinterpretation of the law or of the facts which would justify reconsideration of the Department of Labor's prior decision. Accordingly, the application is denied.

Signed at Washington, DC, this 16th day of July 1991.

Robert O. Deslongchamps,
Director, Office of Legislation & Actuarial Services, Unemployment Insurance Service.

[FR Doc. 91-17788 Filed 7-25-91; 8:45 am]

BILLING CODE 4510-30-M

[TA-W-25,608]

Rockwell International Corp. T/A Division, New Castle, PA; Affirmative Determination Regarding Application for Reconsideration

On June 24, 1991 members of the United Steelworkers Local #4194 met in Washington, DC with the Director of the Office of Trade Adjustment Assistance. The union submitted written information and requested administrative reconsideration of the Department of Labor's notice of negative determination for workers of the subject firm. The negative determination was issued on June 21, 1991 and published in the *Federal Register* on June 28, 1991 (56 FR 29717).

The union claims that the company foreign sourced several of its components. The transfer of production and company import issues were not addressed in the Department's denial notice.

Conclusion

After careful review of the application, I conclude that the claims are of sufficient weight to justify reconsideration of the Department of Labor's prior decision. The application is, therefore, granted.

Signed at Washington, DC, this 16th day of July 1991.

Robert O. Deslongchamps
Director, Office of Legislation & Actuarial Services Unemployment Insurance Service.

[FR Doc. 91-17789 Filed 7-25-91; 8:45 am]

BILLING CODE 4510-30-M

NATIONAL COMMISSION ON ACQUIRED IMMUNE DEFICIENCY SYNDROME

AGENCY: National Commission on Acquired Immune Deficiency Syndrome.

ACTION: Notice of hearing.

SUMMARY: In accordance with the Federal Advisory Committee Act, Public Law 92-463 as amended, the National Commission on Acquired Immune Deficiency Syndrome announces the forthcoming meeting.

DATE AND TIME: Wednesday, August 7, 1991 8:30 a.m. to 5 p.m. Thursday, August 8, 1991 8:30 a.m. to 5 p.m.

PLACE: Old Colony Inn, 625 First Street, Alexandria, VA.

TYPE OF EVENT: Open.

FOR FURTHER INFORMATION CONTACT: Maureen Byrnes, Executive Director, The National Commission on Acquired Immune Deficiency Syndrome, 1730 K Street, NW., suite 815, Washington, DC 20006 (202) 254-5125. Records shall be

kept on all Commission proceedings and shall be available for public inspection at this address.

AGENDA: Discussion of Commission's Comprehensive Report, third year plans and other Commission Business.

Interpreting services are available for deaf people. Please call our TDD number (202) 254-3816 to request services no later than August 1, 1991.

Dated: July 22, 1991.

Maureen Byrnes,
Executive Director.

[FR Doc. 91-17745 Filed 7-25-91; 8:45 am]

BILLING CODE 6820-CN-M

NUCLEAR REGULATORY COMMISSION

Abnormal Occurrence Report; Section 208 Report Submitted to the Congress

Notice is hereby given that pursuant to the requirements of section 208 of the Energy Reorganization Act of 1974, as amended, the Nuclear Regulatory Commission (NRC) has published and issued another periodic report to Congress on abnormal occurrences (NUREG-0090, Vol. 14, No. 1).

Under the Energy Reorganization Act of 1974, which created the NRC, an abnormal occurrence is defined as "an unscheduled incident or event that the Commission (NRC) determines is significant from the standpoint of public health or safety." The NRC has made a determination, based on criteria published in the *Federal Register* (42 FR 10950) on February 24, 1977, that events involving an actual loss or significant reduction in the degree of protection against radioactive properties of source, special nuclear, and by-product material are abnormal occurrences.

The report to Congress is for the first calendar quarter of 1991. The report identifies the occurrences or events that the Commission determined to be significant and reportable; the remedial actions that were undertaken are also described.

The report discusses six abnormal occurrences, none of which involved a nuclear power plant. Five of the events occurred at NRC-licensed facilities: One involved a significant degradation of plant safety at a nuclear fuel cycle facility, one involved a medical diagnostic misadministration, and three involved medical therapy misadministration. An Agreement State (Arizona) reported one abnormal occurrence that involved medical therapy misadministrations.

A copy of the report is available for public inspection and/or copying at the NRC Public Document Room, 2120 L Street, NW., (Lower Level), Washington DC 20555, or at any of the nuclear power plant Local Public Document Rooms throughout the country.

Copies of NUREG-0090, Vol. 14, No. 1 (or any of the previous reports in this series), may be purchased from the Superintendent of Documents, U.S. Government Printing Office, Post Office Box 37082, Washington, DC 20013-7082. A year's subscription to the NUREG-0090 series publication, which consists of four issues, is also available.

Copies of the report may also be purchased from the National Technical Information Service, Springfield, VA 22161.

Dated at Rockville, MD this 22nd day of July 1991.

For the Nuclear Regulatory Commission.

Samuel J. Chilk,

Secretary of the Commission.

[FR Doc. 91-17780 Filed 7-25-91; 8:45 am]

BILLING CODE 7590-01-M

[Docket No. 70-143]

Environmental Assessment, Finding of No Significant Impact and Notice of Opportunity for Hearing Related to Amendment of Materials License No. SNM-124 Nuclear Fuel Services, Inc. Erwin, TN

The United States Nuclear Regulatory Commission (NRC) is considering issuing an amendment of Materials License SNM-124, held by Nuclear Fuel Services, Inc. (NFS), to authorize removal of radioactively contaminated sediments from the three on-site surface impoundments, dewatering to less than 0.5 percent free-standing water, packaging, compaction, and shipment for disposal of the filter cake at a licensed low-level radioactive waste disposal facility, as a necessary step toward decontamination of the NFS site to levels acceptable for eventual decommissioning and release for unrestricted use.

Introduction

By letter dated November 17, 1989, NFS requested authorization to decommission three impoundments, designated Impoundments 1, 2, and 3, in accordance with the Decommissioning Plan for Three Waste Water Impoundments dated November 1989. NFS proposed to remove the radioactively contaminated sediments as well as three to six inches of subsoil in order to reduce any potential adverse effects which the contamination may

have on the health and safety of the general public and the environment. In response to the staff's request for additional information dated March 25, 1991, NFS submitted a revised part 1 dated May 1991 to the two-part Plan. The NRC staff reviewed NFS's request and prepared its Safety Evaluation Report (SER), dated July 1991, "Safety Evaluation Report, Amendment Application Dated May 7, 1991, Re: Decommissioning Plan for Three Waste Water Surface Impoundments."

Contamination in the sediments is recognized as a cause of groundwater quality deterioration. Even though removal of the sediments will help improve groundwater quality in the long-term, the sediment removal process potentially could further deteriorate the already contaminated groundwater in the short-term. Accordingly, pursuant to 10 CFR 51.21, the NRC has prepared this EA.

Background

Between 1957 and 1978, three unlined impoundments were used to retain liquid wastes generated from operations associated with the production of nuclear fuels at the NFS plant in Erwin, Tennessee. Figure 2 and Table 1 of the SER summarizes the discharges to the impoundments during the period of their operation. The three impoundments, which were constructed between 1957 and 1963, were excavated to depths of approximately four feet and enclosed by low earthen berms. Use of the impoundments was discontinued in 1978 when operation of the NFS waste water treatment plant was initiated. The impoundments primarily contain sediments two to six feet thick contaminated with radioactive materials (uranium and thorium) as well as trace levels of other materials associated with the production of nuclear fuels. A site plan of NFS is shown in Figure 1 of the SER. Table 2 of the SER provides the estimated radionuclide concentrations and inventories in the impoundment sediment. Analysis of sampled sediment in accordance with the Environmental Protection Agency's (EPA) Toxicity Characteristic Leaching Procedure (TCLP) showed that two non-radiological contaminants, cadmium and tetrachloroethylene, exceeded the limits in some regions of the sediments in Impoundments 1 and 2.

The total volume of sediments in the three impoundments is estimated to be approximately 86,000 cubic feet (2,500 cubic meters). Average sediment densities are estimated to be 1.22, 1.45 and 1.42 grams per cubic centimeter for Impoundments 1, 2 and 3, respectively. The average depths of the sediments

contained in Impoundments 1, 2 and 3 are estimated to be 40, 27 and 36 inches, respectively.

The Proposed Action

The proposed action is an amendment to License No. SNM-124 to authorize NFS to (1) remove the radioactively contaminated sediments and three to six inches of subsoil from the impoundments by slurry pumping; (2) dewater the sediments using a filter press equipped with membrane plates; (3) initially return the water from the dewatering operation to the impoundments; (4) package the dewatered sediments in 55-gallon drums; (5) compact the drummed sediments to eliminate packaging voids; (6) ship the packaged sediment for burial at a licensed disposal facility; and (7) after sediment removal, treat the water remaining in the impoundments so that it can be discharged to the surface water system in accordance with NFS's modified National Pollution Discharge Elimination System (NPDES) permit requirements. At least one additional impoundment volume of water from each impoundment, infiltrating into the impoundments from the surrounding aquifer during and after the treatment process, will also be treated and discharged. Figure 2 of the SER presents a simplified process flow diagram.

Figures 3 and 4 of the SER respectively provide a layout of the sediment processing equipment and plant proposed by NFS to be used in the decontamination of the impoundments. Operational work will be performed under Decommissioning Work Procedures (DWP) and special health and safety procedures, which are approved by the NFS Safety and Safeguards Review (SSR) Council.

Sediment excavation will be accomplished with a floating dredge. The dredge will be fitted with a horizontal cutter/auger on the pump suction, to provide a cutting action into the sediments and to cause the solids to enter the pump and transport piping.

The sediments will be directed through a shredding operation to remove large objects which may be entrained in the dredge discharge, then transported to the sediment mixing tanks. Sediments and contaminants will be contained in pressure piping throughout the processing operations. This piping will be encased within outer pipes where it crosses Banner Spring Branch to preclude contamination of the branch if a pipe rupture occurs. Connections will be minimized in this area.

Sediments will be fed into one of two 10,000-gallon cone bottom sediment reaction tanks. Sediments will be pumped at the average 10 percent by weight solids loading. Once in the tank, the sediments will be allowed to settle for several hours.

After settling, samples will be taken to verify the sediments/supernate interface, supernate will be decanted and returned to the impoundments and the sediment transferred to the filter press. Solids loading at this point is estimated to be approximately 20 to 25 percent by weight.

A 100 cubic foot filter press will be used for dewatering. Sediment will be fed into the filter press using a pneumatically operated diaphragm pump. Filter cake moisture will be maintained at or below 35 to 40 weight percent. As the press is opened, the filter cake will drop from the plates to the conveyor running the length of the filter press, which moves the cake to the end of the filter press and into 55-gallon drums positioned at the discharge of the conveyor. Based on results obtained from the sediment dewatering pilot project, the filter cake densities of sediments extracted from Impoundments 1, 2 and 3 were estimated by NFS to be 1.79, 1.87 and 2.05 grams per cubic centimeter, respectively.

Each 55-gallon drum will be manually filled, with as many voids as possible removed prior to compaction. Drum extensions will be utilized to allow overfilling prior to compaction. The amount of sediment in each drum will be maintained at about 750 pounds (340 kilograms), since the weight limit for each packaged drum is 800 pounds (363 kilograms).

Compaction will be performed on site using a drum contents compactor equipped with high-efficiency exhaust ventilation control. Compaction will be performed prior to the drum survey station.

Each drum will be surveyed and released for shipment off site as "Radioactive, Low Specific Activity." The average amounts of fissile material (uranium-235) contained in each drum were estimated to be 63, 33 and 98 grams (or dry sediment (0% moisture content) from Impoundments 1, 2 and 3, respectively. The actual average uranium-235 amounts would be less than the values estimated, since the dewatered filter cake would have a relatively high moisture content when packaged. Transportation to the burial site will be via standard tractor-trailer modes on an "exclusive use" basis. Each shipment will contain about 48 drums and be limited to a maximum weight of 40,000 pounds (18,000 kilograms). Over

two hundred shipments could result from the processing of contaminated sediment and soil from all three impoundments. Burial will be at a licensed disposal facility.

As the sediments are removed and processed, sufficient water is required to maintain flotation of the dredge; therefore, filtrate will be returned to the impoundments or further processed through the new Waste Water Treatment System (WWTS). The licensee states that return of the filtrate to the impoundments will stabilize the hydraulic balance with the surrounding aquifer, thus minimizing the influx of groundwater. This action will also minimize the total quantity of water requiring treatment during the remediation effort. The final design of the WWTS will be determined as based upon requirements of the modified NPDES permit and results of the filtrate treatability studies. After removal of the sediments, the remaining water will be processed for discharge. At least one additional impoundment volume of infiltrating groundwater will also be treated and discharged, in order to back-flush some contamination out of the groundwater.

Filtrate will be stored in the filtrate storage tanks until a sufficient quantity has been collected for analysis and discharge. Filtrate will be measured for total alpha and beta activities and other constituents set forth in the modified NPDES permit. Only if analysis indicates that the filtrate meets the permit requirements, will it be discharged to the Nolichucky River. If not, then it will be either stored in the tanks prior to treatment or pumped back into the impoundments.

The equipment used in the remediation effort is intended for reuse after completion of this project. All major equipment items will be disassembled, surveyed, and decontaminated to unrestricted use levels or disposed of as radioactive waste.

NFS will assure that all packages and shipments are made according to requirements of the Department of Transportation (DOT) and the NRC contained in title 49, Code of Federal Regulations, part 173 (49 CFR part 173) and 10 CFR part 71 respectively. NFS will also assure that packaging conforms to the standards established by the licensed disposal facility.

Need for Proposed Action

Radioactively contaminated sediment in the impoundments has been and is a source of local groundwater contamination. If allowed to remain under current conditions, with a portion

of the sediment lying below the water table, it will in all likelihood continue to deteriorate the groundwater. Because of the quantities, small volatility limits and large half-lives of the radio-nuclides contained in the sediment, this deterioration could be expected to last for hundreds if not thousands of years. Even though in the short-term, sediment removal activities may cause the local groundwater to worsen, in the long-term sediment removal will help improve the groundwater quality. In addition, due to its high content of insoluble thorium-232, which has a half life of over ten billion years, the sediment will also continue to pose a direct gamma exposure hazard. Therefore, removal of the sediment from the impoundments will reduce any potential adverse effects on the health and safety of NFS employees, the general public and the environment. Sediment removal is also a necessary step toward decontamination of the site to levels acceptable for eventual decommissioning and release for unrestricted use.

Alternatives to the Proposed Action

The following general categories were identified by NFS's consultant EcoTek as potentially applicable to the remediation of the three NFS surface impoundments:

- In Situ Remediation
- Excavate and Contain On Site
- Excavate and Bury Off Site
- Recover and Recycle
- No Action

In situ remedial actions would involve processes that physically confine or immobilize the impoundment sediments in place. The sediments in this case would be rendered less vulnerable to disturbances, such as rainwater infiltration or animal contact. Therefore, the potential for the formation and migration of leachate or the transport of contaminants by biota and/or airborne mechanisms would be greatly reduced. A perpetual care program would have to be implemented with this option.

Excavation and containment on site would involve the excavation, dewatering and packaging of the impoundment sediment and placement in an engineered containment facility constructed on NFS property. This option would require implementation of a continuing monitoring program. Removal of the sediment would preclude additional formation and migration of leachate in the impoundment area, and placement of radioactive materials in engineered vaults would assure long-term containment.

Excavation and burial off site would involve the excavation, dewatering, packaging and shipping of impoundment sediment to an off-site burial facility. Removal of the sediment would preclude additional formation and migration of leachate at the site and containment of radioactive contaminants associated with the sediments would no longer be a concern.

Recovery and recycle would involve the excavation, dewatering, and processing of impoundment sediments to separate and concentrate radioactive constituents for recycling. The associated waste would be treated for either on-site or off-site burial at a chemical landfill if residual activity permitted. This alternative also results in removal of the sediment providing the environmental benefits of the above options and would also provide for resource recovery, thus potentially resulting in economic benefits.

The specific remediation technologies identified as potentially applicable to the NFS surface impoundments included:

- In Situ Remediation
"No Action"—Impermeable Cover Only, In situ Vitrification, In situ Stabilization, Impermeable Cover With Slurry Wall.
- Excavate and Contain on Site Above Grade Containment Cell, Below Grade Containment Cell.
- Excavate and Bury Off Site A Licensed Disposal Facility.
- Recover and Recycle Chemical Separation.

Within each alternative technology there exists a number of processing options. For example, several of the alternatives require the sediment to be excavated. Excavation of the sediment could be accomplished by several methods including slurry pumping by floating dredge, extraction by dewatering bucket drag line or dewatering of the surrounding aquifer with pumping wells followed by extraction by clam shell, backho, or other excavation device. Also, some of these process options are applicable to more than one alternative technology. For example, sediment excavation is required for the excavate and contain onsite, excavate and bury off site and recover and recycle alternative technologies. This formed a complex interconnecting decision path.

Each remedial action alternative identified as applicable and proven was evaluated by EcoTek in more detail. Five factors were used to evaluate the alternatives:

- Regulatory Acceptability
- Technical Feasibility

- Employee, Public and Environmental Safety
- Economic Feasibility
- Required Implementation Time

The remedial action alternatives were qualitatively ranked in each of the five identified categories and relative to each other. Designations of high (3), moderate (2), and low (1) were used to assign degree of compliance with the intent and spirit of the category. These differences are subtle and subjective. This process eliminated those alternatives which did not provide adequate protection to the employees, public and the environment, and those that cannot be implemented at the site. Each of the identified factors were given equal weight with respect to each other, although a low ranking in regulatory acceptability was given extra weight.

The evaluation of regulatory acceptability involved the identification of NRC and State of Tennessee guidelines and regulations applicable to the situation followed by determining the level of compliance with each applicable requirement.

The evaluation of technical feasibility involved determining the success of similar techniques and methods in similar remediation efforts as described in applicable technical engineering and waste management documents and the availability of local and regional vendors to supply necessary services and/or equipment.

The evaluation of employee, public and environmental safety involved the qualitative, and where possible, the quantitative assessment of probable impact associated with each remedial action. Items examined included external and internal radiation exposure, environmental impact of a process upset and the danger from the construction and process machinery.

If an alternative technology or process option was eliminated due to other concerns, a cost analysis was not performed. The quantification of cost associated with each feasible option was based on best available information provided by applicable engineering documents and information provided by vendors followed by a comparison to other options. These costs include capital costs and operational costs as much as possible.

The evaluation of required implementation time involved the quantification of time required to implement each alternative based on best available information provided by applicable engineering documents and vendor information followed by a comparison to other options.

The results of the remediation alternatives evaluation conducted by

NFS's consultant EcoTek clearly identified the most effective, safe and environmentally sound action to be excavation and burial off site.

The staff has reviewed the licensee's evaluation of alternatives and concluded that the licensee's choice is adequately protective of health, safety and environment, and that none of the alternatives is obviously superior, taking cost-effectiveness into consideration.

Environmental Impacts of the Proposed Action

Groundwater Releases

Description of the Hydrogeologic System

Groundwater beneath the impoundments area occurs in the unconsolidated deposits and the consolidated Rome Formation. Groundwater within the unconsolidated deposits occurs under unconfined conditions; this aquifer represents the uppermost aquifer at the site. The unconsolidated deposits consist of clays, silts, sands, and gravels. Movement of water is primarily within the sand and gravel units, toward the southwest and west. The water table is generally 3 to 9 feet below land surface.

Groundwater within the Rome Formation occurs under weak artesian conditions. The Rome Formation is comprised of shales, siltstones, sandstones and carbonate rocks; however, the carbonate rocks are generally not present at the NFS site.

Groundwater flows within the two aquifers are generally separated by shale deposits within the Rome Formation. Flow between the two aquifers can either be downward or upward depending upon the location at the site. Further characterization is needed to better define the interaction between these two aquifers. However, the results of the characterization would not require the sediment removal process or the groundwater monitoring program to be altered.

Fine-grained sediments and organic detritus at the base of the impoundments tend to impede water moving out of the impoundments; as a result water levels within the impoundments area are mounded.

Groundwater Contamination

Characterization of the sediment within the impoundments has identified radionuclides, heavy metals, and organic chemicals. Radionuclides detected are listed in Table 2 of the SER. The principal isotopes detected are U-234 and Th-232.

Contaminants within the impoundments have resulted in

contamination of the uppermost aquifer at the site. Constituents detected within the groundwater include nitrates, metals, organic chemicals, and radionuclides. Nitrate and mercury were detected at concentrations above the EPA drinking water standards. In addition, gross alpha and combined radium concentrations measured in the groundwater exceeded EPA maximum concentration limits for drinking water. Gross alpha concentrations exceed the EPA limit by several orders of magnitude in the area immediately surrounding the impoundments. Isotopic analyses of groundwater samples detected uranium, radium, technetium, thorium, plutonium, and americium. U-234 accounts for most of the radiochemical contamination within the groundwater.

Additional characterization is needed to delineate the full lateral and vertical extent of the contamination plume. Based upon the current level of characterization, which is considered adequate for the proposed action, the contamination plume does not extend beyond the site boundary.

NFS has determined that the closest down-gradient groundwater user to the site is over five miles away. This assessment is based upon a literature review, instead of an actual field survey. The closest houses near the site are several thousand feet away from the delineated contamination plume; therefore, even if these houses have private wells, it is unlikely that they would be currently affected by contamination from the impoundments.

Impacts From the Sediment Removal Operation

The contaminated sediments are acting as a source of groundwater contamination; thus removal of the sediments, in the long run, should help to improve the groundwater quality. Once the source of contamination is removed, natural flushing and recharge will dilute contaminants within the groundwater. Since several contaminants greatly exceed the EPA maximum concentration limit, it is likely that several contaminant concentrations will remain above EPA limits even with dilution.

During sediment removal, it is possible that the groundwater quality may be slightly worsened. Removal of sediments lining the impoundments will very likely improve the degree of interconnection between the impoundment water and the groundwater. In addition, the stirring action of the dredge will likely release some contaminants absorbed onto the sediment particles. The stirring action

will also likely change the pH and redox potential within the impoundments which may cause some contaminants to be redissolved into solution. NFS has estimated that additional significant groundwater deterioration could occur within a distance of 50 feet of the impoundments. Even if this estimate is incorrect, it is extremely unlikely that this additional groundwater contamination will adversely affect down-gradient groundwater users since they are located so far away.

NFS has proposed to monitor the groundwater of the uppermost aquifer during sediment removal to detect groundwater quality deterioration. Under the proposed monitoring plan, 14 monitoring wells (surrounding the impoundments) will be sampled monthly to determine total alpha and total beta activities. Control charts will be developed and used to determine when a trend in worsening water quality is occurring. NFS's proposed monitoring plan is designed to indicate when a worsening trend in conditions is occurring as distinguished from a short-term negative fluctuation.

If it is determined that the groundwater quality is worsening, NFS has proposed a contingency plan which may include the following actions:

1. Maximizing the dewatering to reduce the hydraulic gradient between the impoundments and the groundwater.
2. Altering the dredging operation to reduce the disturbance within the impoundment.

In summary, since the groundwater in the uppermost aquifer is already contaminated, with several contaminants being well above the EPA safe drinking water standards, it is unlikely that the sediment removal itself will pose a significant additional impact to the groundwater.

Surface Water Releases

Filtrate generated by the dewatering of wet sediments will either be pumped back into the impoundments or discharged to the Nolichucky River. Prior to discharge, the filtrate will be stored in the filtrate storage tanks until a sufficient quantity is collected for analysis. Filtrate will be measured for total alpha and beta and other constituents set forth in the modified NPDES permit. Only if analysis indicates that the filtrate meets the permit requirements, will it be discharged to the Nolichucky River. If not, then it will be either stored in the tanks prior to treatment or pumped back into the impoundments.

Filtrate will be treated in the new Waste Water Treatment System (WWTS). The final design of the WWTS

will be determined based upon requirements of the modified NPDES permit and results of the filtrate treatability studies. After removal of the sediments the remaining water will be processed for discharge. At least one additional impoundment volume of infiltrating groundwater will also be treated and discharged, in order to back-flush some contamination out of the groundwater.

Atmospheric Releases

Because the sediment extraction, dewatering and packaging operations will be carried out under wet conditions, resuspension of sediments is not likely. Lack of airborne particulates will be verified with stationary air samplers inside the dewatering facility and a perimeter air sampler in the impoundment area.

Transportation

Transportation of sediment packaged in 55 gallon drums to the burial site will be via standard tractor-trailer modes on an "exclusive use" basis. Each shipment will contain about 48 drums and be limited to a maximum weight of 40,000 pounds (18,000 kilograms). Over two hundred shipments could result from processing the contaminated sediment and soil from all three impoundments over about a 2-year period.

External gamma exposure rates were estimated for 55 gallon drums containing average concentrations of compacted impoundment sediments packaged for shipment. A 55-gallon sphere was used as a model to estimate the exposure rates. Gamma attenuation due to the steel wall of the drum was not accounted for. Filter press product densities estimated to be 1.79, 1.87 and 2.05 grams per cubic centimeter for sediments from Impoundments 1, 2 and 3, respectively, were used. The external gamma exposure rates at the surface of, and at one meter from the sphere containing packaged sediments from Impoundments 1, 2 and 3 were calculated to be 9.85 and 0.48, 10.1 and 0.49, and 17.4 and 0.85 milliroentgen per hour, respectively. These are within the transportation dose limits of 200 millirem per hour at the surface of the package and 10 millirem per hour at a distance of one meter from the package as specified in 49 CFR 173.441.

The potential for routine transportation impacts has been previously analyzed for the shipment of "Radioactive, Low Specific Activity" materials if packaged in accordance with DOT regulations. Assessment of the radiological impacts of transportation for routes of similar

length and nature, as may be utilized in this remediation effort, is described in a DOE report entitled, "Environmental Assessment of the Proposed Low-Level Waste Processing and Shipment System." These studies show that the shipments result in insignificant impacts to the cargo handlers, truck drivers and persons living along the route.

Although a remote possibility, a transportation accident could result in a spill due to a breach of a container. However, the material is in a form (dewatered solid) that could be recovered with a minimal loss to the environment and is of such low activity that the recovery operations would result in minimal exposure to the clean-up personnel or the general public.

Accident Analysis

A Safety Hazards Analysis (SHA) was conducted by the NFS safety function. The principal criteria applicable to the evaluation included, but were not necessarily limited to, fire protection, radiological safety, containment, confinement, and nuclear criticality prevention.

All process equipment, with the exception of the floating pump and the transfer piping, will be enclosed in such a manner that the major portion of any incidental leaks or spills, including tank overflow, will drain back into Impoundment 3.

If the volume of water in Impoundment 3 approaches maximum capacity, water will be transferred to Impoundment 1 or 2 until sufficient freeboard exists in Impoundment 3. Due to the low pressures involved and suitable pressure relief devices, a catastrophic failure, such as pipe or tank rupture, is considered unlikely.

In order to preclude the possibility of contaminating Banner Spring Branch, the sediment transfer and filtrate return piping in the area of the crossing will be encased in steel casing and connections will be minimized by NFS.

In accordance with the existing License, the NFS fire protection program consists of fire prevention, emergency equipment for fires and fixed systems for fire protection.

The potential for fire in the work area is considered minimal. Very few combustibles exist in the work area. Smoking is not permitted in the work area. The most likely source of ignition is from an electrical malfunction; fire extinguishers suitable for these types of fires will be located by NFS within the work area and onboard the floating dredge. The Plant Emergency Fire Brigade has received training in preventing situations where fires might

be started and in responding to emergency situations.

Agencies and Persons Contacted

No outside agencies or persons were consulted in the preparation of this environmental assessment.

Summary and Conclusions

NFS has requested an amendment of License No. SNM-124 to authorize removal of radioactively contaminated sediment along with three to six inches of subsoil contained in the three wastewater surface impoundments located on site. NFS has proposed to extract the sediment and subsoil by slurry pumping; dewater by first allowing settlement in two 10,000 gallon cone bottom tanks and then by use of a filter press equipped with membrane plates; package and compact the dewatered sediment in 55-gallon drums; and transport the packaged sediment to a low level waste disposal facility for burial.

The staff's conclusions based on the review may be summarized as follows:

1. Removal of the impoundment sediments is a necessary step toward decontamination of the site to levels acceptable for eventual decommissioning and release for unrestricted uses.
2. Evaluation of the impacts of potential accidents showed that as long as appropriate safety measures are taken, decontamination of the impoundments will not pose a serious threat to the environment.
3. Early removal of the impoundment sediments as a source of contamination will help prevent further deterioration of the groundwater quality.
4. Even though in the long-term, sediment removal will help improve the groundwater quality, in the short-term the groundwater may worsen; however, NFS has developed a monitoring and contingency plan to detect and correct this should it occur. Presently as well as in the past, there has been no known use of groundwater for potable or irrigation purposes in the vicinity of the groundwater plume-spread from the NFS impoundments. Thus, although potential future use cannot be disregarded, further degradation of the groundwater in the short-term is not expected to have any adverse impacts on any member of the public.
5. The proposed process of removal, treatment and packaging of the impoundment sediments appears to be an effective process which will control and limit the spread of contamination from the impoundment sediments while this activity is being carried out.

Based on the above, the staff concludes that an amendment can be

issued to authorize the decontamination of the impoundments in accordance with the Decommissioning Plan for Three Waste Water Impoundments, as revised, without undue radiological risk to the public or environment.

Due to the insignificant impacts to the existing environment, a finding of no significant impact is considered appropriate for this proposed action and in accordance with 10 CFR 51.31, an environmental impact statement is not warranted.

Finding of No Significant Impact

Based on the foregoing Environmental Assessment, the Commission has determined not to prepare an Environmental Impact Statement and has determined that a finding of no significant impact is appropriate.

Opportunity for a Hearing

Any person whose interest may be affected by the issuance of this amendment may file a request for a hearing. Any request for hearing must be filed with the Office of the Secretary, U.S. Nuclear Regulatory Commission, Washington, DC 20555, within 30 days of the publication of this notice in the Federal Register; be served on the NRC staff (Executive Director of Operations, One White Flint North, 11555 Rockville Pike, Rockville, MD 20852); on the licensee Nuclear Fuel Services, Inc., attn: Dr. Donald Paine, 205 Banner Hill Road, Erwin, Tennessee 37650-9718; and must comply with requirements for requesting a hearing set forth in NRC regulation, 10 CFR part 2, subpart L, "Informal Hearing Procedures for Adjudications in Materials Licensing Proceedings."

These requirements, which the requester must describe in detail, are:

1. The interest of the requestor in the proceeding;
2. How that interest may be affected by the results of the proceeding, including the reasons why the requestor should be permitted a hearing;
3. The requestor's areas of concern about the licensing activity that is the subject matter of the proceeding; and
4. The circumstances establishing that the request for hearing is timely, that is, filed within 30 days of the date of this notice.

In addressing how the requestor's interest may be affected by the proceeding, the request should describe the nature of the requestor's right under the Atomic Energy Act of 1954, as amended, to be made a party to the proceeding; the nature and extent of the requestor's property, financial, or other (i.e., health, safety) interest in the

proceeding; and the possible effect of any order that may be entered in the proceeding upon the requestor's interest.

The NFS license amendment application dated November 17, 1989, and its revised part I dated May 1991, the Commission's Safety Evaluation Report, Environmental Assessment and Finding of No Significant Impact are available for public inspection and copying at the Commission's Public Document Room, The Gelman Building, 2120 L Street NW., Washington, DC 20555.

Dated at Rockville, Maryland, this 19th day of July 1991.

For the Nuclear Regulatory Commission.

Frederick C. Sturz,

*Acting Chief, Fuel Cycle Safety Branch,
Division of Industrial and Medical Nuclear
Safety, Office of Nuclear Material Safety and
Safeguards.*

[FR Doc. 91-17779 Filed 7-25-91; 8:45 am]

BILLING CODE 7590-01-M

SECURITIES AND EXCHANGE COMMISSION

[Release No. 34-29465; File No. S7-8-90]

Options Price Reporting Authority; Notice of Filing of Amendments to the Plan for Reporting of Consolidated Options Last Sale Reports and Quotation Information

The parties to the Plan, collectively referred to as the Options Price Reporting Authority ("OPRA"),¹ for Reporting of Consolidated Options Last Sale Reports and Quotation Information ("Plan") on June 17, 1991, submitted an amendment to the Plan pursuant to Rule 11Aa3-2 under the Securities Exchange Act of 1934 ("Act").²

I. Description of the Amendment

The amendment establishes a fee to be paid by persons who provide back-up facilities to OPRA Subscribers, including access to current options market information. Persons wishing to offer this service will be required to enter into a "Back-Up Facility Provider Agreement" and to pay a Back-Up Facility Access Fee and, under certain circumstances, additional device charges.

The purpose of the Back-Up Facility Provider Agreement and related fees is to permit persons to provide back-up

facilities to their customers, who are OPRA Subscribers, to be used by the Subscribers in the event the Subscriber's own facilities are temporarily unavailable as a result of a natural disaster or other calamity. The Back-Up Facility Access Fee is payable by every person whose business is limited to offering back-up facilities to its customers. In addition, a device charge equal to the regular Professional Subscriber must be paid for each device actually used as a back-up facility during any month.

II. Implementation of the Amendment

The Back-Up Facility arrangement will be implemented upon its approval by the Commission pursuant to Rule 11Aa3-2(c)(2) by requiring every person who wishes to offer this service to execute a Back-Up Facility Provider Agreement and to pay the fees provided for therein. The Agreement describes the terms and conditions governing the service.

III. Request for Comment

Interested persons are invited to submit written comments on the amendments. Persons submitting comments should file six copies with the Secretary of the Securities and Exchange Commission, 450 Fifth Street, NW., Washington, DC 20549. Copies of the submissions and related items, other than those that may be withheld from the public in accordance with the provisions of 5 U.S.C. 552, will be available for inspection and copying in the Commission's Public Reference Room, 450 Fifth Street, NW., Washington, DC. All communications should refer to File No. S7-8-90 and should be submitted by August 16, 1991.

For the Commission, by the Division of Market Regulation pursuant to delegated authority. 17 CFR 200.30-3(a)(27).

Dated: July 19, 1991.

Margaret H. McFarland,
Deputy Secretary.

[FR Doc. 91-17817 Filed 7-25-91; 8:45 am]

BILLING CODE 8010-01-M

[Release No. 34-29466; File No. SR-CBOE-91-26]

Self-Regulatory Organizations; Notice of Filing of Proposed Rule Change by the Chicago Board Options Exchange, inc. Relating to Member and Customers Access to CBOE Constitution and Rules

Pursuant to section 19(b)(1) of the Securities Exchange Act of 1934 ("Act"), 15 U.S.C. 78e(b)(1), notice is hereby given that on June 17, 1991, the Chicago

Board Options Exchange, Inc. ("CBOE" or "Exchange") filed with the Securities and Exchange Commission ("Commission") the proposed rule change as described in Items I, II and III below, which Items have been prepared by the self-regulatory organization. The Commission is publishing this notice to solicit comments on the proposed rule change from interested persons.

I. Self-Regulatory Organization's Statement of the Terms of Substance of the Proposed Rule Change

The Exchange proposes to amend CBOE Rule 3.6 to delete redundant language regarding authorization for nominees of member organizations, codify the current Exchange policy that requires individual members and certain persons associated with member organizations to pledge to abide by the CBOE Constitution and Rules ("Rules"), and to require that all members keep and maintain a current copy of the Rules.

The text of the proposed rule is available at the Office of the Secretary, CBOE, and at the Commission.

II. Self-Regulatory Organization's Statement of the Purpose of, and Statutory Basis for, the Proposed Rule Change

In its filing with the Commission, the self-regulatory organization included statements concerning the purpose of, and statutory basis for, the proposed rule change and discussed any comments it received on the proposed rule change. The text of these statements may be examined at the places specified in Item IV below. The self-regulatory organization has prepared summaries, set forth in sections (A), (B), and (C) below, of the most significant aspects of such statements.

A. Self-Regulatory Organization's Statement of the Purpose of, and Statutory Basis for, the Proposed Rule Change

The Exchange is proposing to delete the last sentence of paragraph (a) of CBOE Rule 3.6 pertaining to a member organization's authorization of nominees because this requirement is clearly set forth in Exchange Rule 3.8. In addition, the CBOE is proposing to codify in Rule 3.6 existing Exchange practice that individual members and executive officers, directors, principal shareholders, and general and limited partners of member organizations execute a Consent to Exchange Jurisdiction.

Finally, in order to fully understand and comply with the Exchange's Rules, as from time to time amended, and all circulars issued thereunder, CBOE members and persons associated with member organizations must have ready access to the CBOE's Constitution and Rules and the Exchange Bulletin. In addition, the Exchange believes that the Rules should be readily available to public customers. Accordingly, proposed paragraph (d) to Exchange Rule 3.6 will require members and member organizations to keep a current copy of the Exchange Rules and will require all member organizations doing business with the public to have the Rules available to customers. One copy of the paperback Rules will be given to members each time the volume is published, usually in January of each year. The Rules are updated in the Regulatory Bulletin, which is included twice a month in the weekly Exchange Bulletin. One copy of the Exchange Bulletin is currently provided to each membership. As with the Exchange Bulletin, a member organization's copy of the Rules will be distributed to the nominee of the organization.

In this regard, the Exchange intends to publish a Regulatory Circular notifying members that maintaining the paperwork Rules or the CBOE Guide, together with the Regulatory Bulletin, will satisfy the requirements of Rule 3.6(d). In addition, member organizations doing business with the public will be notified that all branch offices will be required to keep and maintain either the paperwork Rules or the CBOE Guide and the Regulatory Bulletin.

The Exchange believes that the proposed rule change is consistent with section 6(b) of the Act, in general, and furthers the objectives of section 6(b)(5), in particular, in that it is designed to protect investors and the public interest by insuring that all parties who utilize the facilities of the CBOE are familiar with, and have access to, the Rule governing the Exchange.

B. Self-Regulatory Organization's Statement on Burden on Competition

The CBOE does not believe that the proposed rule change will impose any inappropriate burden on competition.

C. Self-Regulatory Organization's Statement on Comments on the Proposed Rule Change Received From Members, Participants, or Others

No written comments were solicited or received with respect to the proposed rule change.

III. Date of Effectiveness of the Proposed Rule Change and Timing for Commission Action

Within 35 days of the date of publication of this notice in the *Federal Register* or within such longer period (i) as the Commission may designate up to 90 days of such date of it finds such longer period to be appropriate and publishes its reasons for so finding or (ii) as to which the self-regulatory organization consents, the Commission will:

- (a) By order approve such proposed rule change, or
- (b) Institute proceedings to determine whether the proposed rule change should be disapproved.

IV. Solicitation of Comments

Interested persons are invited to submit written data, views and arguments concerning the foregoing. Persons making written submissions should file six copies thereof with the Secretary, Securities and Exchange Commission, 450 Fifth Street, NW., Washington, DC 20549. Copies of the submission, all subsequent amendments, all written statements with respect to the proposed rule change that are filed with the Commission, and all written communications relating to the proposed rule change between the Commission and any person, other than those that may be withheld from the public in accordance with the provisions of 5 U.S.C. 552, will be available for inspection and copying in the Commission's Public Reference Section, 450 Fifth Street, NW., Washington, DC. Copies of such filing will also be available for inspection and copying at the principal office of the above-mentioned self-regulatory organization. All submissions should refer to the file number in the caption above and should be submitted by August 16, 1991.

For the Commission, by the Division of Market Regulation, pursuant to delegated authority.

Dated: July 22, 1991.

Margaret H. McFarland,

Deputy Secretary.

[FR Doc. 91-17818 Filed 7-25-91; 8:45 am]

BILLING CODE 8010-01M

[Release No. 34-29460; File No. SR-OCC-90-13]

Self-Regulatory Organizations; The Options Clearing Corporation; Order Approving a Proposed Rule Change Relating to an Electronic Mail Service to be Offered and Fees to be Charged in Connection With the Service

July 19, 1991.

Introduction

On December 3, 1990, The Options Clearing Corporation ("OCC") filed a proposed rule change [File No. SR-OCC-90-13] with the Securities and Exchange Commission ("Commission") pursuant to Section 19(b) of the Securities Exchange Act of 1934 ("Act").¹ Notice of the proposal was published in the *Federal Register* on December 17, 1990, to solicit comments from interested persons.² No comments were received. On June 7, 1991, OCC filed an amendment to the proposed rule change.³ As discussed below, this order approves the amended proposal.

II. Description of the Proposal

OCC's proposal relates to an electronic mail service ("E-Mail") to be offered in conjunction with OCC's Options News Network ("ONN").⁴ Generally, electronic mail is a system that allows messages to be sent from one computer to another with the messages being stored until the receiver elects to read them. In addition to message transmission, electronic mail systems usually provide to users the capability of attaching documents to outgoing messages. Under the proposal, subscribers may utilize E-Mail to facilitate the transmission and reception of messages and other documents attached thereto.

E-Mail is currently being offered to exchange participants.⁵ This proposal expands the field of eligible users of E-Mail to OCC clearing members (and their correspondents), financial institutions with which OCC has business dealings, and members of OCC's participant exchanges which are not members of OCC. OCC will not offer E-Mail to public "retail" customers.⁶

¹ 15 U.S.C. 78a(b).

² Securities Exchange Act Release No. 28688 (December 10, 1990), 55 FR 51782.

³ Letter from Jean M. Cawley, Staff Counsel, OCC, to Jerry W. Carpenter, Branch Chief, Division of Market Regulation ("Division"), Commission (June 6, 1991).

⁴ ONN is an on-line centralized database developed by OCC at the request of its participant exchanges. The database contains informational memoranda and other notices issued by OCC and its participant exchanges for the benefit of clearing members as well as other options market participants. Securities Exchange Act Release No. 28689 (December 3, 1990), 55 FR 50793 (notice of filing and immediate effectiveness of ONN (SEC File No. SR-OCC-90-12)).

⁵ *Id.*

⁶ Letter from Jean M. Cawley, Staff Counsel, OCC, to Jonathan Kallman, Assistant Director, Division, Commission (May 9, 1991).

The ONN database, including the E-Mail facility offered in conjunction with ONN, is maintained on a system separate from the OCC clearance and settlement system.⁷ Volume capacity for the system is limited only by the number of telephone lines that can be used at one time to access and enter the system, which OCC believes is adequate to meet anticipated use.

The proposed rule change also sets forth the fee schedule OCC has established for E-Mail subscribers. Those fees are as follows:

Participant Exchanges—\$20.00 per month⁸

OCC Clearing Members—\$15.00 per month⁹

Exchange Members (which are not OCC members but which may be correspondents of OCC members)—\$20.00 per month¹⁰

Financial Institutions (with which OCC has business dealings)—\$20.00 per month¹¹

III. Discussion

Section 17A(a)(1)(C) of the Act¹² articulates Congress' finding that clearing agencies' new data processing and communications techniques create the opportunity for more efficient, effective, and safe procedures for clearance and settlement. As noted above, OCC has indicated that the E-Mail system will expedite communication of information between OCC, its members, and other E-Mail subscribers. The Commission concurs and believes that this technique for the transfer of information is efficient, effective, and safe.

Section 17A(b)(3)(D) of the Act¹³ requires that the rules of a clearing agency provide for the equitable allocation of reasonable dues, fees, and other charges among its participants. The Commission believes that the fees associated with this optional information transfer technique are reasonable.

Because E-Mail is a novel service for a clearing agency to provide, OCC, at the Commission's request, has agreed that one year after the date of this approval order it will perform an assessment of E-Mail. The assessment

will include such subjects as: a general assessment of the facility; description of any problems in the system and responses to such problems; subscriber complaints and disposition of those complaints; and planned modifications to the system. OCC will provide a copy of the report to the Division. Additionally, the Commission notes that OCC has agreed to maintain a log of subscribers' use of the E-Mail system.¹⁴

IV. Conclusion

For the reasons stated above, the Commission finds that OCC's proposal is consistent with section 17A of the Act.

IT IS THEREFORE ORDERED, pursuant to section 19(b)(2) of the Act,¹⁵ that OCC's proposed rule change (SR-OCC-90-13) be, and hereby is, approved.

For the Commission, by the Division of Market Regulation, pursuant to delegated authority.¹⁶

Margaret H. McFarland,

Deputy Secretary.

[FR Doc. 91-17819 Filed 7-25-91; 8:45 am]

BILLING CODE 8010-01-M

[Release. No. IC-18244; File No. 812-7707]

SMA Life Assurance Co.

July 19, 1991.

AGENCY: Securities and Exchange Commission ("SEC").

ACTION: Notice of Application for Exemption under the Investment Company Act of 1940 (the "1940 Act").

APPLICANTS: SMA Life Assurance Company ("SMA Life"), SMA Life Separate Account VA-K ("Account VA-K"), and SMA Equities, Inc.

RELEVANT 1940 ACT SECTIONS: Exemption requested under Section 6(c) from Sections 26(a)(2)(C) and 27(c)(2) of the 1940 Act.

SUMMARY OF APPLICATION: Applicants seek an order to permit the deduction of mortality and expense risk charges from the assets of Account VA-K pursuant to certain individual combination fixed/variable annuity contracts issued by SMA Life (the "Contracts").

FILING DATE: The application was filed on April 3, 1991 and amended on June 14, 1991.

¹⁴ Subscribers to ONN and E-Mail are reminded that certain transmissions may be subject to their recordkeeping requirements provided in Act Rules 17a-1, 17a-3, and 17a-4 (17 CFR 240.17a-1, 240.17a-3, and 240.17a-4).

¹⁵ 15 U.S.C. 78s(b)(2).

¹⁶ 17 CFR 200.30-3(a)(12).

HEARING OR NOTIFICATION OF HEARING:

If no hearing is ordered, the application will be granted. Any interested person may request a hearing on this application, or ask to be notified if a hearing is ordered. Any request must be received by the SEC by 5:30 p.m., on August 13, 1991. Request a hearing in writing, giving the nature of your interest, the reason for the request, and the issues you contest. Serve the Applicants with the request, either personally or by mail, and also send it to the Secretary of the SEC, along with proof of service by affidavit, or, for lawyers, by certificate. Request notification of the date of a hearing by writing to the Secretary of the SEC.

ADDRESSES: Secretary, Securities and Exchange Commission, 450 5th Street, Washington, DC 20549. SMA Life, c/o Sheila B. St. Hilaire, 440 Lincoln Street, Worcester, Massachusetts, 01605.

FOR FURTHER INFORMATION CONTACT: Cindy Rose, Financial Analyst (202) 272-3027 or Nancy M. Rappa, Senior Staff Attorney (202) 272-2622, Office of Insurance Products and Legal Compliance (Division of Investment Management).

SUPPLEMENTARY INFORMATION:

Following is a summary of the application. The complete application is available for a fee from the SEC's Public Reference Branch.

Applicants' Representations

1. SMA Life, a stock life insurance company organized under the laws of Delaware, is the depositor and sponsor of Account VA-K. Account VA-K is registered with the SEC as a unit investment trust under the 1940 Act. Account VA-K consists of nine subaccounts, each of which invests solely in the shares of one of the funds of SMA Investment Trust (the "Trust") or of the portfolios of Variable Insurance Products Fund ("VIPF"). SMA Equities, Inc. is the principal underwriter for the Contracts.

2. The Contracts are combination fixed/variable annuity contracts which may be used for either immediate or deferred annuities. The Contracts may be issued to plans qualifying for special federal income tax treatment, plans and trusts which do not qualify for special tax treatment under the Internal Revenue Code, and individuals. The Contracts permit multiple purchase payments, unlimited as to frequency or number, but with initial and subsequent minimums of \$600 and \$50, respectively. Contract owners may allocate net purchase payments to any one or more of the subaccounts, and to the general

⁷ Letter from Jean M. Cawley, Staff Counsel, OCC, to Jerry W. Carpenter, Branch Chief, Division, Commission (June 6, 1991).

⁸ Organizations with five or more passwords utilizing E-Mail will receive a discounted fee of \$12.00 per month per password.

⁹ *Id.*

¹⁰ Subscribers will be invoiced for the full calendar year subscription to E-Mail.

¹¹ *Id.*

¹² 15 U.S.C. 78q-1(a)(1)(C).

¹³ 15 U.S.C. 78q-1(b)(3)(D).

account of SMA Life for accumulation on a fixed basis.

3. Prior to the annuity commencement date, SMA Life assesses an annual contract charge, equal to the lesser of \$30 or 3% of the accumulated value of the Contract. The contract charge will be deducted on each Contract anniversary and at full surrender or annuitization of the Contract during a contract year. SMA Life guarantees that the amount of this charge will not increase over the life of the Contract.

4. In addition, for certain administrative and clerical services, SMA Life assess a daily charge equal to 0.20% on an annual basis of the current value of the subaccounts of Account VA-K. The level of this administrative service charge is guaranteed not to increase.

5. The contract charge and the administrative service charge are designed to cover the cost of administrative and related expenses and are not expected to be a source of profit.

6. The Contracts do not assess a front-end sales charge from the gross purchase payments made by owners. In lieu of a front-end sales charge, the Contracts assess a contingent deferred sales charge which is applied in the case of Contract surrender, partial redemptions or annuitization under period certain options during certain periods.

7. For purposes of determining the contingent deferred sales charge, the accumulated value is divided into three categories: (1) purchase payments received by SMA Life during the nine years preceding the date of the surrender ("New Payments"); (2) purchase payments not defined as New Payments ("Old Payments"); and (3) the amount of accumulated value in excess of all purchase payments that have not been previously surrendered ("Earnings"). For purposes of determining the amount of any contingent deferred sales charge, surrenders will be deemed to be taken first from Old Payments, then from New Payments, and then from Earnings. Old Payments may be withdrawn from the Contract at any time without the imposition of a contingent deferred sales charge. Then, for the purpose of calculating surrender charges for New Payments, all amounts withdrawn are assumed to be deducted first from the earliest New Payment and then from the next earliest New Payment and so on, until all New Payments have been exhausted pursuant to the FIFO method of accounting. Subsequent withdrawals will be deducted from Earnings.

8. The contingent deferred sales charge is computed as follows:

| Years from date of payment to date of withdrawal | Withdrawal charge (percent) |
|--|-----------------------------|
| less than 2..... | 8 |
| 2 but less than 3..... | 7 |
| 3 but less than 4..... | 6 |
| 4 but less than 5..... | 5 |
| 5 but less than 6..... | 4 |
| 6 but less than 7..... | 3 |
| 7 but less than 8..... | 2 |
| 8 but less than 9..... | 1 |
| 9 or more..... | 0 |

The charge is applied as a percentage of the New Payments redeemed. In no event will the total contingent deferred sales charges assessed against a Contract exceed 8% of the gross New Payments.

9. In each calendar year, SMA Life will waive the contingent deferred sales charge, if any, on an amount equal to a given percentage of the accumulated value ("Free Withdrawal Amount") under a Contract. In the event that a redemption of New Payments is made in excess of the amount that may be redeemed free of charge, only the excess will be subject to a contingent deferred sales charge.

10. To compensate for its assumption of certain mortality and expense risks, SMA Life will deduct from the daily net asset value of each subaccount an amount computed daily, which is equal to an annual rate of 1.25%. The charge is approximately allocable 0.80% to SMA Life's assumption of mortality risks and 0.45% to SMA Life's assumption of expense risks. Applicants represent that the level of this charge is guaranteed not to increase.

11. The mortality risk arises from SMA Life's guarantees: (a) that it will make annuity payments, in accordance with annuity rate provisions established within the Contract at the time it is issued, for the life of the annuitant (or in accordance with the annuity option selected), no matter how long the annuitant or other payee lives and no matter how long all annuitants as a class live and (b) that it will pay the special death benefit available under the Contract prior to annuitization. The expense risk arises from SMA Life's guarantee that the charges it makes will not exceed the limits described in the Contracts.

12. If the mortality and expense risk charge is insufficient to cover the Company's mortality costs and excess expenses, SMA Life will absorb the losses. If expenses are less than the amounts resulting from the charge, the difference will be a profit to SMA Life. Any such profit will be available for use by SMA Life for any lawful purpose, including the payment of sales,

distribution and other expenses not covered by the contingent deferred sales charge. SMA Life acknowledges that the contingent deferred sales charge alone may be insufficient to recoup distribution expenses.

13. Applicants represent that the charge of 1.25% for the mortality and expense risks assumed by SMA Life is within the range established by industry practice for similar contracts. This representation is based on SMA Life's analysis of similar industry products, taking into account such factors as current charge levels, existence of charge level guarantees, and guaranteed annuity rates.

14. SMA Life represents that it will maintain at its home office, and make available to the Commission, a memorandum setting forth in detail the products analyzed in the course of, and the methodology and results of, its comparative survey.

15. Applicants represent that profits, if any, from the mortality and expense risk charge could be viewed as indirectly providing for a portion of the costs relating to the distribution and sales of the Contracts. SMA Life nevertheless has concluded that there is a reasonable likelihood that the proposed distribution financing arrangement will benefit Account VA-K and Contract owners.

16. SMA Life will maintain at its administrative offices and make available to the Commission a memorandum setting forth the basis for the conclusion that Account VA-K's distribution financing arrangements might benefit Account VA-K and the Contract owners.

17. Account VA-K will invest only in open-end management investment companies which undertake, in the event such company adopts a plan under rule 12b-1 under the 1940 Act to finance distribution expenses, to have a Board of Trustees or Directors, a majority of the members of which will not be "interested persons" of such investment company, formulate and approve such plan under rule 12b-1.¹

For the Commission, by the Division of Investment Management, pursuant to delegated authority.

Margaret H. McFarland,

Deputy Secretary.

[FR Doc. 91-17736 Filed 7-25-91; 8:45 am]

BILLING CODE 8010-01-M

¹ Applicants represent that, during the notice period, the application will be amended to reflect this representation.

[Release No. 35-25351]

Filings Under the Public Utility Holding Company Act of 1935 ("Act")

July 19, 1991.

Notice is hereby given that the following filing(s) has/have been made with the Commission pursuant to provisions of the Act and rules promulgated thereunder. All interested persons are referred to the application(s) and/or declaration(s) for complete statements of the proposed transaction(s) summarized below. The application(s) and/or declaration(s) and any amendments thereto is/are available for public inspection through the Commission's Office of Public Reference.

Interested persons wishing to comment or request a hearing on the application(s) and/or declaration(s) should submit their views in writing by August 12, 1991 to the Secretary, Securities and Exchange Commission, Washington, DC 20549, and serve a copy on the relevant applicant(s) and/or declarant(s) at the address(es) specified below. Proof of service (by affidavit or, in case of an attorney at law, by certificate) should be filed with the request. Any request for hearing shall identify specifically the issues of fact or law that are disputed. A person who so requests will be notified of any hearing, if ordered, and will receive a copy of any notice or order issued in the matter. After said date, the application(s) and/or declaration(s), as filed or as amended, may be granted and/or permitted to become effective.

Central Power and Light Company (70-7861)

Central Power and Light Company ("CPL"), 539 North Carancahua Street, Corpus Christi, Texas 78401, an electric public-utility subsidiary company of Central and South West Corporation, a registered holding company, has filed a declaration under section 12(d) of the Act and rule 44 thereunder.

CPL owns and maintains as part of its transmission system approximately 14.2 miles of 345 KV transmission line ("Line Section") in Wharton County, Texas. The Line Section was originally constructed by CPL in 1974 as part of the transmission line extending from CPL's Lon C. Hill plant to the W.A. Parish plant, owned by Houston Lighting & Power Company ("HPL"), a nonaffiliate company. The Line Section was interconnected with HLP's transmission line within the South Texas Project ("STP") corridor upon completion of the corridor in 1981. STP Unit 1 went into

commercial operation on August 25, 1988.

CPL proposes to lease to HLP the Line Section in Wharton County, Texas in accordance with a lease agreement ("Agreement"). The Agreement provides for HLP to pay CPL a rental rate of \$13,442 per month. The Agreement will be effective beginning August 25, 1988 for an initial term of 30 years. The parties contemplate that a lump sum payment will be made by HLP to CPL upon the effectiveness of the Agreement for the period from August 25, 1988 to the present. CPL expects to apply the proceeds of the proposed lease to its general operating funds.

For the Commission, by the Division of Investment Management, pursuant to delegated authority.

Margaret H. McFarland,
Deputy Secretary.

[FR Doc. 91-17737 Filed 7-25-91; 8:45 am]

BILLING CODE 8010-01-M

SUSQUEHANNA RIVER BASIN COMMISSION**Proposed Project Review Filing & Monitoring Fee Schedule**

AGENCY: Susquehanna River Basin Commission (SRBC).

ACTION: Notice of re-proposal.

SUMMARY: Notice is hereby given that the Susquehanna River Basin Commission is re-proposing and seeking comments on a filing and monitoring fee schedule.

DATES: Written comments should be submitted by August 31, 1991.

ADDRESSES: Written comments should be submitted to Richard A. Cairo, Secretary to the Commission, 1721 N. Front St., Harrisburg, PA. 17102-2391.

FOR FURTHER INFORMATION CONTACT: Richard A. Cairo, Secretary to the Commission (717) 238-0423.

SUPPLEMENTARY INFORMATION: In the April 10, 1991 issue of the *Federal Register*, at p. 14556, the Susquehanna River Basin Commission proposed two alternative forms of a project review filing and monitoring fee schedule to help defray a portion of the costs associated with processing project review applications and monitoring compliance with Commission regulations. The proposed schedules were also published in *Pennsylvania Bulletin*, the *New York Register* and the *Maryland Register*. On May 23, 1991 the Commission held a public hearing to receive comments on the proposed schedules. A thirty-day written

comment period was allowed following the hearing.

The Commission has received numerous comments on the fee schedules and has made a number of changes in response to those comments. Those changes are reflected in the re-proposed fee schedule published herein and are summarized as follows:

1. Most commentators felt that Alternative 1, which assesses fees on the basis of water requested for consumption or use, is a fairer method of assessing a fee than Alternative 2 which is based on project cost. The Commission agrees that Alternative 1 is a fairer reflection of a project's impact on water resources and therefore chooses Alternative 1.

2. Some commentators cited paragraph 2(g) of Alternative 1 as being overly broad and vague. Upon consideration, the Commission agrees and therefore paragraph 2(g) is being deleted from the re-proposed fee schedule.

3. Commission staff, upon further review, noted the need to add the word "requested" before the words "consumptive use" in paragraph 3(a) to make it clear that the application fee will be based on the amount of consumptive use requested for approval.

Also, with respect to paragraph 3(a), many agricultural interests complained that the application/monitoring fee schedule for consumptive users could be overly burdensome for agricultural users whose main consumptive use, irrigation, is intermittent in nature. Such intermittent users should be exempted from the fees or given some form of relief.

The Commission recognizes that, while irrigation is a consumptive use of water for purposes of Commission Regulation 803.61 (18 CFR 803.61), it is also an intermittent use. When intermittent irrigation is calculated on a 30 consecutive day average basis, as prescribed by Commission Regulation 803.61, many irrigation projects may be determined to be below the regulatory threshold of 20,000 gpd and thus be free of any regulation and fees.

To afford relief to those irrigators and other intermittent users exceeding the threshold amount, the Commission is adding sub-paragraph (i) to paragraph 3(a) which provides that projects consuming water in excess of the threshold amount for not more than any single 90 consecutive day period each calendar year shall pay an application fee of \$250.00. In a similar vein, the Commission is proposing to exempt these same users from annual

compliance monitoring fees as now proposed in new paragraph 5(a)(i).

4. A number of commentators had difficulty discerning the meaning of paragraph 4 which referred to fees for "revision of or addition to projects previously submitted to the Commission." The intent of this paragraph is to cover projects which are modified and must be re-submitted to the Commission for approval. The new wording below clearly indicates that intent.

5. The Commission staff, upon further review, recommended that the four-tiered monitoring fee be reduced to a three-tiered scale which would retain a \$100 annual compliance monitoring fee for small consumptive users consuming up to 100,000 gpd.

The Commission received a number of other comments. These are summarized by category below and responses are provided.

Comment No. 1: The Compact does not authorize project review application fees or monitoring and compliance fees. The fees are not justified by the actions performed by staff.

Response: Article 3, § 3.9—Rates and Charges, authorizes the Commission, after public hearing, to fix, alter and revise rentals, charges and tolls for services it provides. In addition, Article 3, Section 3.4(8)—Powers of the Commission, states that the Commission may "exercise all powers necessary or convenient to carry out its express powers, and other powers which may be implied therefrom."

In reviewing project applications, the Commission provides a service to a specific project sponsor. The Commission staff often meets with applicants, explaining the regulatory requirements and suggesting methods and strategies for compliance. Depending on the complexity of a proposed project, staff expends several man-hours meeting with applicants, corresponding with them by letter and telephone and reviewing all pertinent material related to the project. A computerized data file is maintained to track all projects and monitor their continued compliance.

With respect to monitoring and compliance, the Commission must monitor the streams of the basin to determine when low flows occur and then advise permittees of those low flows so that they can take the steps needed to comply with the regulation. This is a service to the permittees and protects other uses and users on the stream. The Commission must also assimilate and store the data which consumptive users and well operators periodically submit.

Comment No. 2: All revenues to operate the project review functions of the Commission should originate through the appropriations process thus imposing accountability on the Commission for the use of these funds. Fees are just an attempt to circumvent that process and impose a tax.

Response: The proposed fees are projected to provide less than 30% of the cost to operate the project review functions of the Commission. Thus, most of the funds will originate with the appropriations process. The Commission's financial records are audited annually and the Commission is held accountable for all monies it acquires and utilizes, regardless of its source.

We would note further that it is not uncommon for governmental units who rely on appropriated funds to impose fees. Such fees are charged by the U.S. Corps of Engineers, the Pa. Dept. of Environmental Resources, the New York State Dept. of Environmental Conservation and the Delaware River Basin Commission. Local units of government such as county row offices and municipalities charge fees for such services as recording papers, filing law suits, and applying for zoning or building permits. These fees are not taxes in that they are not directed to the general populace, but to the users of the services provided.

Comment No. 3: Both alternatives presented by the Commission are not directly related to the Commission's costs of conducting reviews. The fiscal justification for these fees has not been made clear.

Response: If the Commission based its project review application fees on the actual cost of conducting reviews, the fees would have to be much higher. The cost of conducting reviews has now risen above the \$200,000 per year level as more and more projects of greater complexity have been submitted to the Commission. The fee schedule alternatives are designed to recover less than 30 of the actual review costs.

Comment No. 4: The Commission should exempt local units of government from any and all fees.

Response: About 70% of the applicants for ground-water withdrawals are municipalities or their related authorities. Exempting these municipalities, which generate the preponderance of review costs, will severely limit the effectiveness of the fee schedule in defraying a portion of the project review costs. In addition, all applicants, including municipalities, will receive a dollar for dollar credit for any fees they pay to any signatory party for the same scope of review on the same

project. Also, where the Commission exercises an oversight review of surface water allocations to public water suppliers, no project review fees will be assessed.

Comment No. 5: The proposed monitoring and compliance fees pertaining to consumptive users are arbitrary because there is no difference in the amount of effort it takes to monitor small or large users.

Response: In setting monitoring fees, the Commission does not believe it is arbitrary to give some consideration to the applicant's impact on the system as a factor in setting fees. Larger users usually involve more complex systems and have a greater potential to impact a larger position of the basin's water resources. Review and often monitoring becomes more complex and involved and thus more costly.

Comment No. 6: The fee schedule imposes regulations where there were none before.

Response: This is a misconception. "Regulations and Procedures for Review of Projects" has been in effect for quite some time covering such projects as consumptive uses and ground water withdrawals. There have been no fees charged for such reviews up to this time.

Re-Proposed Project Review Filing Fee

1. A non-refundable project review fee shall be paid to the Commission, according to the schedule herein, for projects described in paragraph 2 hereof. Agencies, authorities, or commissions of the signatories to the Compact shall be exempt from such project review fee; however, political subdivisions of the signatory states shall be subject to said fee.

2. A project review fee under this resolution shall be required for the following categories of projects which require review and approval by the Commission under section 3.10(2) of the Compact and Commission Regulation 803.3 and 803.4 (18 CFR 803.3 & 803.4):

a. Diversions of water into or out of the Susquehanna River Basin.

b. Surface water withdrawals for which the Commission has primary review authority as may be applicable within the signatory states; provided, however, that the Commission shall exercise as it deems necessary overview of proposed surface withdrawals and subsequent allocations of water and shall exempt such overview action from its project review fees.

c. Hydroelectric projects.

d. Stream encroachments including local flood protection projects and impoundments having potential to cause interstate effects, or such other projects

as the Commission may determine necessary.

e. Consumptive uses as defined and regulated by Commission Regulation 803.61 (18 CFR § 803.61).

f. Ground-water withdrawals as defined and regulated by Commission Regulation 803.62 (18 CFR § 803.62).

3. Fee Schedule

a. All projects involving consumptive use of water will be charged an application fee based on their requested consumptive use in accordance with the following schedule:

(i) Projects consuming water in excess of a consecutive thirty day average of 20,000 gpd for not more than any single 90 consecutive day period each calendar year—\$250.00; and

(ii) All other projects as follows:

| | |
|--|--------|
| 20,000 gallons per day (gpd)—100,000 gpd..... | \$750 |
| 100,001 gpd—500,000 gpd..... | 3,000 |
| 500,001 gpd—1 million gallons per day (mgd)..... | 6,000 |
| Over 1 mgd..... | 12,000 |

b. All hydropower projects will be charged an application fee based on name plate generation capacity as follows:

| | |
|--------------------------------|-------|
| Less than 1 megawatt..... | \$250 |
| 1-10 megawatts..... | 1,500 |
| Greater than 10 megawatts..... | 7,500 |

These fees will be charged for review of applications for FERC exemption, short form, or regular license, if the hydro project requires Commission review and approval as per paragraph 2 above. No fee will be charged for review of applications for a preliminary permit.

c. Stream encroachments—\$2,500.

d. All other project review fees will be based on the quantities of water requested in the application as follows:

| | |
|-----------------------------|---------|
| Up to 250,000 gpd..... | \$1,000 |
| 250,001 to 500,000 gpd..... | 2,000 |
| 500,001 gpd to 1 mgd..... | 3,000 |
| Over 1 mgd..... | 4,000 |

e. If any project involves more than one of the above elements, the highest of the applicable fees shall apply.

4. The applicable fee shall be submitted upon billing by the Commission. Modification of projects previously approved by the Commission shall require submission of a review fee as provided herein unless the Commission finds that the said modification requires no significant review by staff.

5. Except as otherwise provided by contract, the sponsors of projects

previously approved by the Commission shall be required to pay an annual compliance monitoring fee as follows:

a. All consumptive use projects will be charged as follows:

(i) Projects consuming water in excess of a consecutive thirty day average of 20,000 gpd for not more than any single 90 consecutive day period each calendar year will be exempted; and

(ii) All other projects as follows:

| | |
|-----------------------------|-------|
| 20,000 gpd—100,000 gpd..... | \$100 |
| 100,001 gpd—1 mgd..... | 500 |
| Over 1 mgd..... | 1,500 |

b. All ground-water withdrawal projects will be charged \$100.

c. Projects having special monitoring requirements may be assessed annual fees as determined by Commission review.

d. Projects that have consumptive use from ground-water sources will be charged a fee from each category of a and b above.

6. In assessing the application fees, the Commission shall give a dollar for dollar credit to the project sponsor for any application fees paid to any signatory agency for the same scope of review on the same project.

7. Whenever, under the guidelines and requirements of Commission Regulation 18 CFR part 803, subpart C, §§ 803.40-803.51, the Commission holds a public hearing or an adjudicatory hearing on a project, the project sponsor shall be required to pay the reasonable costs of holding and making a record of said hearing.

8. Revenues received pursuant to this resolution shall be deposited in the Commission's general fund and be appropriated for use in support of the Commission's Annual Expense Budget.

Authority: Susquehanna River Basin Compact, 84 Stat 1509 *et seq.*

Dated: July 18, 1991.

Robert J. Bielo,

Executive Director.

[FR Doc. 91-17734 Filed 7-25-91; 8:45 am]

BILLING CODE 7040-01-M

DEPARTMENT OF TRANSPORTATION

Office of the Secretary

[Order 91-7-24]

Fitness Determination of Rocky Mountain Helicopters, Inc.; D/B/A Rocky Mountain Aviation D/B/A Advantage Airlines

AGENCY: Department of Transportation.

ACTION: Notice of commuter air carrier fitness determination, order to show cause.

SUMMARY: The Department of Transportation is proposing to find that Rocky Mountain Helicopters, Inc. d/b/a Rocky Mountain Aviation d/b/a Advantage Airlines is fit, willing, and able to provide commuter air service under section 419(e) (1) of the Federal Aviation Act.

RESPONSES: All interested persons wishing to respond to the Department of Transportation's tentative fitness determination should file their responses with the Air Carrier Fitness Division, P-56, room 6401, Department of Transportation, 400 Seventh Street, SW., Washington, DC 20590, and serve them on all persons listed in Attachment A to the order. Responses shall be filed no later than August 6, 1991.

FOR FURTHER INFORMATION CONTACT: Mrs. Janet A. Davis, Air Carrier Fitness Division, Department of Transportation, 400 Seventh Street, SW., Washington, DC 20590, (202) 366-9721.

Dated: July 22, 1991

Patrick V. Murphy, Jr.,

Deputy Assistant Secretary for Policy and International Affairs.

[FR Doc. 91-17722 Filed 7-25-91; 8:45 am]

BILLING CODE 4910-82-M

[Order 91-7-25]

Fitness Determination of Safe Air International, Inc. d/b/a Island Express.

AGENCY: Department of Transportation.

ACTION: Notice of Commuter Air Carrier Fitness Determination; order to show cause.

SUMMARY: The Department of Transportation is proposing to find that Safe Air International, Inc. d/b/a Island Express is fit, willing, and able to provide commuter air service under section 419(e) of the Federal Aviation Act.

RESPONSES: All interested persons wishing to respond to the Department of Transportation's tentative fitness determination should file their responses with the Air Carrier Fitness Division, P-56, room 6401, Department of Transportation, 400 Seventh Street, SW., Washington, DC 20590, and serve them on all persons listed in Attachment A to the order. Responses shall be filed no later than August 6, 1991.

FOR FURTHER INFORMATION CONTACT: Mrs. Barbara P. Dunnigan, Air Carrier Fitness Division, Department of

Transportation, 400 Seventh Street, SW., Washington, DC 20590, (202) 366-2342.

Dated: July 22, 1991.

Patrick V. Murphy, Jr.,
Deputy Assistant Secretary for Policy and
International Affairs.

[FR Doc. 91-17723 Filed 7-25-91; 8:45 am]

BILLING CODE 4910-62-M

Advisory Commission on Conferences in Ocean Shipping; Notice of Open Meeting

AGENCY: Department of Transportation (DOT), Office of the Secretary.

ACTION: Notice of open meeting of the Advisory Commission on Conferences in Ocean Shipping.

SUMMARY: The Commission will be holding its fourth field hearing in Portland, OR on August 9, 1991; the hearing will be open to the public. In the morning, the Commission plans to focus on issues related to antitrust immunity for conferences and other participants in the ocean shipping industry. In the afternoon, the Commission plans to hear testimony on all issues relating to the Shipping Act of 1984 and conferences in the ocean shipping industry.

DATES: Public hearing: Friday, August 9, 1991, 8:30 a.m. to 5 p.m. Pdt. Deadline for requests to speak at the public hearing: Friday, August 2, 1991.

ADDRESS: The address for the public hearing is World Trade Center, One World Trade Center Portland, Portland, OR, 97204, in the Mezzanine Level, Rooms 1, 2, and 3.

FOR FURTHER INFORMATION CONTACT: James L. Reitzes, Economist, or Ruth Dicker, Counsel, Advisory Commission on Conferences in Ocean Shipping, Department of Transportation, 400 Seventh Street, SW., room 5102, Washington, DC 20590; telephone (202) 366-9781; FAX (202) 366-7870.

SUPPLEMENTARY INFORMATION: The Commission was created by the Shipping Act of 1984 to conduct an independent and comprehensive study of conferences in ocean shipping, particularly whether the Nation would be best served by prohibiting conferences, or by closed or open conferences. The Commission is to provide its report, including recommendations, to the President and the Congress by April 10, 1992. The Commission began formal operations on April 10, 1991, at a day-long open meeting in Washington, DC, at which the Commission heard reports from Federal agencies on the impact of the 1984 Act and discussed issues to be studied by the Commission.

As part of its study, the Commission has been holding a series of public hearings around the United States. It held hearings on June 3, 1991 in New Orleans, LA; June 21, 1991, in San Francisco, CA; and July 12, 1991 in Charleston, SC. The last hearing is scheduled for New York, NY (September 13, 1991). At each hearing, a part of the day has been dedicated to issues generally raised by the 1984 Act, and part of each hearing has focused on a specific predesignated issue.

The Commission will be holding its fourth field hearing on August 9, 1991 in Portland, OR, at The World Trade Center Portland, Portland, OR 97204, in Mezzanine Level, Rooms 1, 2, and 3. Attendance is open to the public but limited to space available. The morning session will be devoted to testimony on issues related to antitrust immunity for conferences and other participants in the ocean shipping industry. The afternoon session will be open to receive testimony on any aspect of the Shipping Act of 1984.

Interested members of the public are invited to address the Commission at the August 9, 1991 hearing. In order to be assured of an opportunity to do so, each person wishing to speak should contact James Reitzes or Ruth Dicker at the address set out above by August 2, 1991. Each such person is also requested to provide by August 2, 1991 a copy of the testimony he/she will present at the Commission hearing. Persons from similar segments of the international ocean shipping industry (e.g., shippers, freight forwarders, carriers) may be grouped into panels of 2-3 persons. In this situation, each person will be given 5 minutes to summarize (give key points of) his testimony, followed by a 15 minute question and answer period. Persons who the staff believes cannot effectively be placed in a panel will present testimony individually, followed by a question and answer period. Persons appearing before the Commission are encouraged to support all opinions with factual information and evidence. To the extent that time permits and that it does not disrupt the orderly process of the meeting and will not be unfair to any person, persons who do not make prior written requests to speak will be given opportunity to do so as part of the afternoon session.

Persons who wish to provide written comments for the Commission's consideration may do so at any time by forwarding them to the address set out above.

Issued in Washington, DC on July 24, 1991.

Florizelle B. Liser,

Executive Director.

[FR Doc. 91-17944 Filed 7-26-91; 8:45 am]

BILLING CODE 4910-62-M

Office of Hearings

[U.S.-Italy Service Case Docket 47654]

Assignment of Proceeding

This proceeding has been assigned to Chief Administrative Law Judge John J. Mathias. All future pleadings and other communications regarding the proceeding shall be served on him at the Office of Hearings, M-50, room 9228, Department of Transportation, 400 Seventh Street, SW., Washington, DC 20590. Telephone: (202) 366-2142.

John J. Mathias,

Chief Administrative Law Judge.

[FR Doc. 91-17855 Filed 7-25-91; 8:45 am]

BILLING CODE 4910-62-M

[U.S.-Italy Service Case Docket 47654]

Prehearing Conference

Notice is hereby given that a prehearing conference in the above entitled matter is assigned to be held on August 7, 1991, at 10 a.m. (local time), in room 5332, Nassif Building, 400 Seventh Street, SW., Washington, DC, before Administrative Law Judge John J. Mathias. Order 91-7-28, instituting this proceeding was issued on July 22, 1991, and posted on that same date.

In order to facilitate the conduct of the conference, all parties and potential parties are directed to submit one copy to each entity on the attached service list and six copies to the Judge of (1) proposed statement of the issues; (2) proposed stipulations; and (3) proposed changes in request for information and evidence set forth in the appendix to Order 91-7-28. Public Counsel will circulate their material on or before July 26, 1991, and the other parties and potential parties shall do so on or before August 2, 1991. The submissions of other parties and potential parties shall be limited to points on which they differ with Public Counsel and shall follow the numbering and lettering used by Public Counsel to facilitate cross-referencing.

The Instituting Order in this proceeding sets a deadline for the Recommended Decision in this matter of December 6, 1991. In order to adhere to this deadline, the case will be set for hearing on October 1 through 4, 1991. If additional time is needed for the presentation of evidence, we will have

to have extended hours on those dates, and, possibly, also hold hearings on October 5 and 6. The prescribed deadline will also require an expedited schedule in other respects. Accordingly, I expect to adhere to the following procedural schedule:

Direct Exhibits will be due: August 28, 1991

Rebuttals will be due: September 24, 1991

Posthearing briefs will be due: October 25, 1991¹

Recommended Decision on or before: December 6, 1991

In view of the expedited schedule the parties and potential parties are advised to begin the preparation of their testimony and exhibits immediately. All

¹ Due to the short deadline provided, there will be no time for reply briefs.

parties to the proceeding will be expected to cooperate in bringing this matter to decision within the prescribed deadline.

So Ordered.

John J. Mathias,

Chief Administrative Law Judge.

[FR Doc. 91-17856 Filed 7-25-91; 8:45 am]

BILLING CODE 4910-28-M

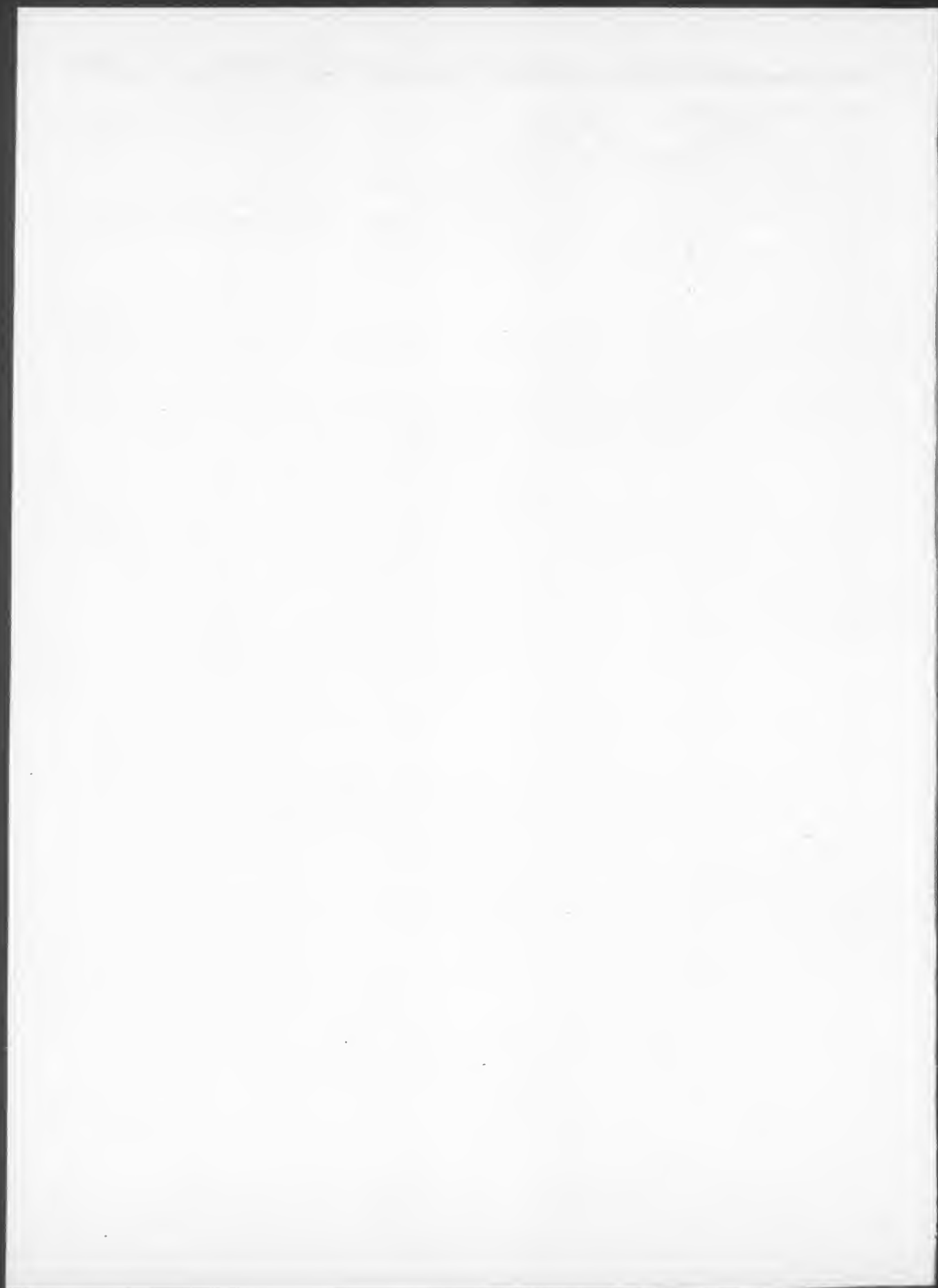

Sunshine Act Meetings

Federal Register

Vol. 56, No. 144

Friday, July 26, 1991

This section of the FEDERAL REGISTER contains notices of meetings published under the "Government in the Sunshine Act" (Pub. L. 94-409) 5 U.S.C. 552b(e)(3).

FARM CREDIT ADMINISTRATION

Farm Credit Administration Board; Special Meeting

AGENCY: Farm Credit Administration.

SUMMARY: Notice is hereby given, pursuant to the Government in the Sunshine Act (5 U.S.C. 552b(e)(3)), of the special meeting of the Farm Credit Administration Board (Board).

DATE AND TIME: The special meeting of the Board was held at the offices of the Farm Credit Administration in McLean, Virginia, on July 25, 1991, from 10:00 a.m. until such time as the Board concluded its business.

FOR FURTHER INFORMATION CONTACT: Curtis M. Anderson, Secretary to the Farm Credit Administration Board, (703) 883-4003, TDD 703 883-4444.

ADDRESS: Farm Credit Administration, 1501 Farm Credit Drive, McLean, Virginia 22102-5090.

SUPPLEMENTARY INFORMATION: This meeting of the Board was closed to the public pursuant to exemptive provisions of the Government in the Sunshine Act. The matter considered at the meeting was:

Closed Session*

New Business

- Government-Sponsored Enterprises—Agency Options

Dated: July 24, 1991.

Curtis M. Anderson,
Secretary, Farm Credit Administration Board.

[FR Doc. 91-17956 Filed 7-24-90; 3:13 pm]

BILLING CODE 6705-01-M

* Session closed to the public—exempt pursuant to 5 U.S.C. § 552b(c)(9).

FEDERAL DEPOSIT INSURANCE CORPORATION

Notice of Agency Meeting

Pursuant to the provisions of the "Government in the Sunshine Act" (5 U.S.C. 552b), notice is hereby given that the Federal Deposit Insurance Corporation's Board of Directors will meet in open session at 2:00 p.m. on Tuesday, July 30, 1991, to consider the following matters:

Memorandum and resolution re: Final amendments to part 308 of the Corporation's rules and regulations, entitled "Rules of Practice and Procedures," which make uniform those rules concerning formal enforcement actions.

Memorandum and resolution re: Proposed amendments to the Corporation's rules and regulations in the form of a new part 358, entitled "Insider Transactions—Conflicts of Interest," which would: (1) Provide that business dealings (other than extensions of credit) between an insured nonmember bank and its directors, executive officers, principal shareholders and related interests of such persons must meet an arms-length standard, (2) require that covered business dealings be approved by the bank's board of directors in advance if the dollar value of the business dealings exceed a certain aggregate figure, (3) require bank insiders to disclose their conflicts of interest, (4) provide for certain recordkeeping requirements, (5) require the bank's board of directors to adopt written guidelines governing covered business dealings, and (6) prohibit insured nonmember banks from investing in real estate in which any of the bank's directors, executive officers, principal shareholders or related interests of such persons has an equity interest.

The meeting will be held in the Board Room on the sixth floor of the FDIC Building located at 550 17th Street N.W., Washington, D.C.

Requests for further information concerning the meeting may be directed to Mr. Hoyle L. Robinson, Executive Secretary of the Corporation, at (202) 898-6757.

Dated: July 23, 1991.

Federal Deposit Insurance Corporation,
Hoyle L. Robinson,
Executive Secretary.

[FR Doc. 91-17673 Filed 7-24-91; 8:46 am]

BILLING CODE 6714-01-M

RESOLUTION TRUST CORPORATION

Notice of Agency Meeting

Pursuant to the provisions of the "Government in the Sunshine Act" (5 U.S.C. 552b), notice is hereby given that the Board of Directors of the Resolution Trust Corporation will meet in open session following the FDIC open session that begins at 2:00 p.m. on Tuesday, July 30, 1991 to consider the following matters:

Summary Agenda:

- Memorandum re: Delegations of authority relating to staffing.
- Memorandum re: Delegations of authority relating to personnel.

Discussion Agenda:

- Memorandum re: Proposed rule regarding the establishment of minority and women contracting program to ensure inclusion, to the maximum extent possible, of firms owned by minorities and women in RTC contracting activities.
- Memorandum re: Proposed revisions to indemnification of contractors.
- Memorandum re: Mid-year budget review and staffing analysis.

The meeting will be held in the Board Room on the sixth floor of the FDIC Building located at 500—17th Street, NW., Washington, DC.

Requests for further information concerning the meeting may be directed to Mr. William J. Tricarico, Assistant Executive Secretary of the Resolution Trust Corporation, at (202) 416-7282.

Dated: July 23, 1991.

Resolution Trust Corporation.

William J. Tricarico,
Assistant Executive Secretary.

[FR Doc. 91-17923 Filed 7-24-91; 12:10 pm]

BILLING CODE 6714-01-M

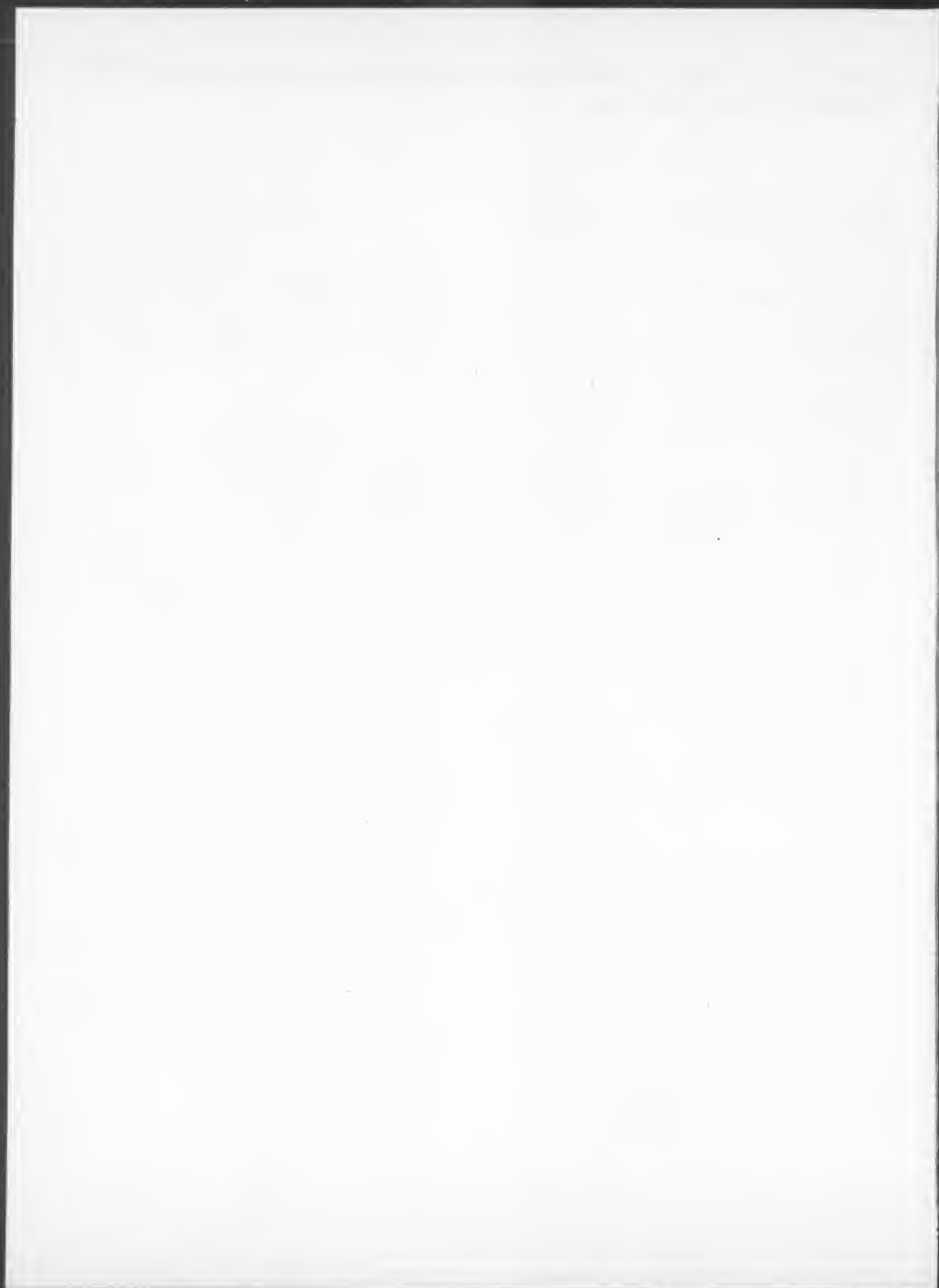

Corrections

Federal Register

Vol. 56, No. 144

Friday, July 26, 1991

This section of the FEDERAL REGISTER contains editorial corrections of previously published Presidential, Rule, Proposed Rule, and Notice documents. These corrections are prepared by the Office of the Federal Register. Agency prepared corrections are issued as signed documents and appear in the appropriate document categories elsewhere in the issue.

DEPARTMENT OF EDUCATION

Office of Special Education and Rehabilitative Services; Intent To Compromise a Claim, Minnesota Department of Education

Correction

In notice document 91-17069 appearing on page 33026 in the issue of

Thursday, July 18, 1991, make the following correction:

In the second column, in the first full paragraph, in the third line from the bottom insert the following before the paren:

"On July 20, 1990, the MDE filed a timely application for review with the Office of Administrative Law Judges. Subsequent to the filing of its appeal, the MDE submitted additional documentation to OSERS in order to rebut the findings. On May 13, 1991, the Assistant Secretary filed a Notice of Reduction of Claim in which he determined that the statewide projection for the child count should be dropped and the cost disallowance should be reduced to \$2,318.27, which is the total pro rata share of EHA-B funds for each

of the remaining seven ineligible students. The MDE has agreed to repay this amount in full.

With respect to the time distribution issue, the MDE submitted additional documentation in an attempt to justify the EHA-B charges for the eight employees questioned in the PDL. No question exists that these employees worked substantially on activities that could be reimbursed by EHA-B funds. The Federal interest involved in this case is that of ensuring that the amount of time spent by each employee is proportionate to the salary costs charged to the program. (34 CFR part 74, appendix C, part II, section B, paragraph 10.b.)"

BILLING CODE 1505-01-D

federal register

Friday
July 26, 1991

Part II

Architectural and Transportation Barriers Compliance Board

36 CFR Part 1191

**Americans With Disabilities Act (ADA)
Accessibility Guidelines for Buildings and
Facilities; Final Guidelines**

**ARCHITECTURAL AND
TRANSPORTATION BARRIERS
COMPLIANCE BOARD**

36 CFR Part 1191

[Docket No. 90-2]

RIN 3014-AA09

**Americans With Disabilities Act (ADA)
Accessibility Guidelines for Buildings
and Facilities**

AGENCY: Architectural and
Transportation Barriers Compliance
Board.

ACTION: Final guidelines.

SUMMARY: The Architectural and Transportation Barriers Compliance Board is issuing final guidelines to assist the Department of Justice to establish accessibility standards for new construction and alterations in places of public accommodation and commercial facilities, as required by title III the Americans with Disabilities Act (ADA) of 1990. The guidelines will ensure that newly constructed and altered portions of buildings and facilities covered by title III of the ADA are readily accessible to and usable by individuals with disabilities in terms of architecture and design, and communication. The Department of Justice has proposed to adopt the guidelines as the accessibility standards for new construction and alterations in places of public accommodation and commercial facilities for purposes of title III of the ADA.

EFFECTIVE DATE: July 26, 1991.

FOR FURTHER INFORMATION CONTACT: James Raggio, Office of the General Counsel, Architectural and Transportation Barriers Compliance Board, 1111-18th Street, NW., Suite 501, Washington, DC 20036. Telephone (202) 653-7834 (Voice/TDD). This is not a toll-free number. This document is available in accessible formats (cassette tape, braille, large print, or computer disc) upon request.

SUPPLEMENTARY INFORMATION:

Statutory Background

The Americans with Disabilities Act (ADA) of 1990 extends to individuals with disabilities comprehensive civil rights protections similar to those provided to persons on the basis of race, sex, national origin, and religion under the Civil Rights Act of 1964. Title III of the ADA, which becomes effective on January 26, 1992, prohibits discrimination on the basis of disability in places of public accommodation by any person who owns, leases or leases to, or operates a place of public

accommodation. As discussed below, title III establishes accessibility requirements for new construction and alterations in places of public accommodation and commercial facilities.

"Public accommodation" is defined by section 301(7) of the ADA as including the following twelve categories of private entities if their operations affect commerce:

- (1) An inn, hotel, motel, or other place of lodging, except for an establishment located within a building that contains not more than five rooms for rent or hire and that is actually occupied by the proprietor of such establishment as the residence of such proprietor;
- (2) A restaurant, bar, or other establishment serving food or drink;
- (3) A motion picture house, theater, concert hall, stadium, or other place of exhibition or entertainment;
- (4) An auditorium, convention center, lecture hall, or other place of public gathering;
- (5) A bakery, grocery store, clothing store, hardware store, shopping center, or other sales or rental establishment;
- (6) A laundromat, dry-cleaner, bank, barber shop, beauty shop, travel service, shoe repair service, funeral parlor, gas station, office of an accountant or lawyer, pharmacy, insurance office, professional office of a health care provider, hospital, or other service establishment;
- (7) A terminal, depot, or other station used for specified public transportation;
- (8) A museum, library, gallery, or other place of public display or collection;
- (9) A park, zoo, amusement park, or other place of recreation;
- (10) A nursery, elementary, secondary, undergraduate, or postgraduate private school, or other place of education;
- (11) A day care center, senior citizen center, homeless shelter, food bank, adoption agency, or other social service center establishment; and
- (12) A gymnasium health spa, bowling alley, golf course, or other place of exercise or recreation.

The legislative history states that these twelve categories "should be construed liberally consistent with the intent of the legislation that people with disabilities should have equal access to the array of establishments that are available to others who do not currently have disabilities." H. Rept. 101-485, pt. 2, at 100.

"Commercial facilities" are defined by section 301(1) of the ADA as facilities that are intended for nonresidential use and whose operations will affect commerce. The legislative history states that the term is to be interpreted broadly to cover commercial establishments that are not included within the specific definition of "public accommodation" such as office buildings, factories, and

other places in which employment will occur. H. Rept. 101-485, pt. 2, at 116-17.

Section 303 of the ADA establishes accessibility requirements for new construction and alterations in places of public accommodation and commercial facilities. With respect to new construction, section 303(a)(1) requires that places of public accommodation and commercial facilities designed or constructed for first occupancy after January 26, 1993, must be readily accessible to and usable by individuals with disabilities, except where an entity can demonstrate that it is structurally impracticable. When alterations are made that affect or could affect usability of or access to a place of public accommodation or commercial facility, section 303(a)(2) requires that the alterations be made in such a manner that, to the maximum extent feasible, the altered portions of the facility are readily accessible to and usable by individuals with disabilities. In addition, where alterations affect or could affect usability of or access to an area of the facility containing a primary function, section 303(a)(2) requires that the alterations be made in such a manner that, to the maximum extent feasible, the path of travel to the altered area, and the restrooms, telephones, and drinking fountains serving the altered area are readily accessible to and usable by individuals with disabilities unless it is disproportionate to the overall alterations in terms of cost and scope, as determined under criteria established by the Attorney General.

Section 303(b) of the ADA contains an exception which specifies that the installation of an elevator is not required for newly constructed or altered facilities that are less than three stories or have less than 3,000 square feet per story unless the building is a shopping center, shopping mall, the professional office of a health care provider, or another type of facility determined by the Attorney General to require the installation of an elevator based on the usage of the facility.

According to the legislative history, the term "readily accessible to and usable by" is intended to provide "a high degree of convenient accessibility" and "enable people with disabilities (including mobility, sensory, and cognitive impairments) to get to, enter and use a facility." H. Rept. 101-485, pt. 2, at 117-18. The term includes "accessibility of parking areas, accessible routes to and from the facility, accessible entrances, usable bathrooms and water fountains, accessibility of public and common use areas, and access to the goods, services,

programs, facilities, accommodations and work areas available at the facility.' Id. The legislative history further explains that when identical features will generally serve the same function, only a reasonable number must be accessible depending on such factors as their use, location, and number; however, when identical features will generally be used in different ways, each one must be accessible in most situations. H. Rept. 101-485, pt. 2, at 118; H. Rept. 101-485, pt. 3, at 61. For example, only a reasonable number of spaces in a parking lot or stalls within a restroom would have to be accessible, but all meeting rooms at a conference center would have to be accessible because each one may be used for different purposes at any given time. Id.

Under section 504 of the ADA, the Architectural and Transportation Barriers Compliance Board is required to issue guidelines to assist the Department of Justice to establish accessibility standards for new construction and alterations in places of public accommodation and commercial facilities covered by title III.¹ Section 504 requires that the guidelines supplement the existing Minimum Guidelines and Requirements for Accessible Design (MGRAD) and "establish additional requirements, consistent with this Act, to ensure that buildings (and) facilities * * * are accessible in terms of architecture and design * * * and communication, to individuals with disabilities."² Section

504 also requires that the guidelines include provisions for alterations to qualified historic properties.

The Department of Justice is responsible for issuing final regulations to implement the provisions of title III of the ADA except for transportation vehicles. Section 306(c) of the ADA requires that the Department of Justice's final regulations include accessibility standards for new construction and alterations of buildings and facilities covered by title III of the ADA that are consistent with the Board's guidelines. On February 22, 1991, the Department of Justice proposed to adopt the Board's proposed guidelines with any changes made by the Board as the accessibility standards for purposes of title III of the ADA. See Department of Justice's proposed regulations, 28 CFR 34.406(a) and Appendix A to part 36—Standards for Accessible Design at 56 FR 7478, 7492, 7494 (February 22, 1991).

Proposed Guidelines

On January 22, 1991, the Board published a notice of proposed rulemaking (NPRM) in the Federal Register which contained the proposed Americans With Disabilities Act (ADA) Accessibility Guidelines For Buildings and Facilities (56 FR 2296). The proposed guidelines were modeled on the Uniform Federal Accessibility Standards (UFAS) which are generally consistent with MGRAD and use the same format and numbering system as the American National Standard Specifications for Making Buildings and Facilities Accessible to and Usable by Physically Handicapped People (ANSI A117.1-1980).³ Where the ADA establishes requirements that differ from MGRAD or UFAS, the ADA requirements were followed.

The proposed guidelines contained:

- General provisions (sections 1 through 3) which include the purpose section, general information about the guidelines, miscellaneous instructions, and definitions.
- Scoping provisions (sections 4.1.1 through 4.1.7) which include the application section and scoping requirements for new construction of sites and exterior facilities, new construction of buildings and facilities, additions, alterations, and alterations to qualified historic properties.

³ The ANSI A117.1 standard was revised in 1986 after UFAS was adopted. The 1980 and 1986 versions of the ANSI A117.1 standard are very similar and both are currently in use. As discussed under the general issues, the ANSI A117.1 standard is in the process of being revised again and the Board intends to coordinate its work with the ANSI A117 Committee.

- Technical specifications (sections 4.2 through 4.34) which reprint the test and illustrations of the ANSI A117.1-1980 standard with differences in the text noted by italics.

- Special application sections (sections 5 through 10) which include additional requirements for restaurants and cafeterias, medical care facilities, business and mercantile facilities, libraries, transient lodging, and transportation facilities.⁴

- An appendix which contains additional information to aid in understanding the guidelines, and designing buildings and facilities for greater accessibility.

The NPRM also asked questions and sought information on a number of specific issues related to the proposed guidelines.

Public Hearings and Comments

The Board held 14 public hearings around the country on the proposed guidelines between February 11, 1991 and March 7, 1991. A total of 450 people presented testimony on the proposed guidelines at the hearings. In addition, 1,585 written comments were submitted to the Board by the end of the comment period on March 25, 1991. Another 280 comments were received between March 26, 1991 and April 3, 1991. Although those comments were not timely, they were analyzed along with the comments received by March 25, 1991. The Board did not find it practical to consider comments received after April 3, 1991. In all, the Board received over 12,000 pages of comments and testimony on the proposed guidelines.

The Board received comments and testimony from a broad range of interested individuals and groups. Ten categories were identified and approximately the following numbers submitted timely comments or testimony for each category:

⁴ The NPRM reserved section 10 for transportation facilities. The Board issued a supplemental notice of proposed rulemaking (SNPRM) in the Federal Register on March 20, 1990 which proposed additional requirements for transportation facilities that would make the guidelines also applicable to transportation facilities constructed or altered by public entities covered by title II of the ADA (56 FR 11874). The Department of Transportation has also proposed to adopt the Board's guidelines as the accessibility standards for transportation facilities for purposes of title II of the ADA. See Department of Transportation's proposed regulations, 49 CFR 37.13(b) and Appendix B to Part 37—Standards for Accessible Transportation Facilities at 56 FR 13861, 13861, and 13907 (April 4, 1991).

¹ The Board is an independent Federal agency established pursuant to section 502 of the Rehabilitation Act of 1973 to ensure that the requirements of the Architectural Barriers Act of 1968 are met and to propose alternative solutions to architectural, transportation, communication, and attitudinal barriers faced by individuals with disabilities. The Board consists of 12 members appointed by the President from among the general public, at least six of whom are required to be individuals with disabilities, and the heads of 11 Federal agencies or their designees whose positions are Executive Level IV or above. The Federal agencies are: The Departments of Health and Human Services, Education, Transportation, Housing and Urban Development, Labor, Interior, Defense, Justice, and Veterans Affairs; General Services Administration; and United States Postal Service.

² The Board developed MGRAD to assist the General Services Administration, Department of Defense, Department of Housing and Urban Development, and United States Postal Service to establish accessibility standards for those federally owned, leased, or financed buildings covered by the Architectural Barriers Act of 1968. See 36 CFR part 1190. The standards established by those agencies are known as the Uniform Federal Accessibility Standards (UFAS) and are generally consistent with MGRAD.

- 1270 Individuals who identified themselves as having a disability or who voiced a "consumer" perspective, and organizations representing these persons. For purposes of convenience, this category is referred to as "individuals with disabilities and their organizations" in the section-by-section analysis.
- 100 Government agencies involved with disability issues.
- 60 Building code officials and State agencies responsible for accessibility.
- 80 Architects, designers, engineers, and organizations representing these persons.
- 320 Businesses and organizations representing businesses.
- 60 Manufacturers.
- 20 Transit agencies.
- 50 Building owners and managers, and organizations representing these persons.
- 50 Other government agencies.
- 20 Other persons or organizations not in the above categories.

The comments and testimony were sorted by section and analyzed. For some sections, the comments were grouped around certain issues or questions identified in the NPRM. For other sections, the comments were scattered. A large number of commenters, especially individuals with disabilities and their organizations, expressed support for the guidelines, as proposed. Some commenters requested that sections be clarified or made recommendations for changes, including deletion of sections. Further, it was evident from some comments that a few of the proposed provisions in the NPRM were unclear and needed to be revised. With respect to those commenters who recommended changes, a few submitted data or studies in support of their recommendations; however, most recommendations were based on individual opinions or preferences. Where data or studies were not submitted in support of a recommended change, the Board was inclined to retain the provisions taken from the MGRAD, UFAS, and the ANSI A117.1 standard, especially with respect to the technical specifications in 4.2 through 4.34, unless more than a few commenters or an organization representing the interests of a large group believed that the provision was inadequate or otherwise in need of change. The Board considered each of those recommended changes on its merits. In some sections, commenters pointed out a need for new or additional requirements but further research or study is necessary for the Board to develop guidelines in the area. Some commenters asked questions regarding

application of the guidelines to specific situations.

Due to the large number of comments received and the deadline for issuing the final guidelines, it is not possible for the Board to respond to each comment in this preamble. The Board has made every effort within the time available to respond to significant comments in the section-by-section analysis. As discussed under specific sections, the Board has reserved action in some areas pending further study or research. The Board has an on-going research and technical assistance program and plans to periodically review and up-date the guidelines to ensure that they remain consistent with technological developments and changes in model codes and national standards, and meet the needs of individuals with disabilities.

General Issues

Coordination of Board and ANSI Processes

Many commenters generally supported using the ANSI A117.1—1980 standard as the basis for the technical specifications of the guidelines since that standard or its 1986 update is incorporated or reference in many State and local building codes and is generally accepted and understood by the building industry. The Council of American Building Officials (CABO), National Conference of States on Building Codes and Standards (NCSBCS), American Institute of Architects (AIA), and other commenters recommended that the Board coordinate any substantive changes to the ANSI A117.1 standard with the ANSI A117 Committee in order to maintain a consistent and uniform set of accessibility standards which can be efficiently and effectively implemented at the State and local level through established building regulatory processes.⁵

The Board is a member of the ANSI A117 Committee and is committed to working cooperatively with the Committee. The ANSI A117 Committee solicited proposals for changes to the

⁵ The ANSI A117 Committee is responsible for periodically reviewing and up-dating the ANSI A117.1 standard. The Committee consists of 42 organizations representing individuals with disabilities, architects and designers, building owners and managers, building product manufacturers, model code groups, building code officials, and government agencies. The Committee operates under due process and consensus procedures established by the American National Standards Institute. See American National Standards Institute, *Procedures for the Development and Coordination of American National Standards*, approved by ANSI Board of Directors September 9, 1987.

ANSI A117.1 standard in July 1989, a full year before the ADA was enacted. When the ADA was enacted in July 1990, the Board was charged with the responsibility of issuing final guidelines in nine months. In order to meet this responsibility, the Board issued the NPRM on January 22, 1991. The ANSI A117 Committee published draft revisions to the ANSI A117.1 standard on February 22, 1991. The timing of these events did not permit the Board and the ANSI A117 Committee to fully coordinate their processes.⁶

Members of the ANSI A117 Committee have objected to various changes proposed in the February 1991 draft revisions to the ANSI A117.1 standard and the group is scheduled to meet in July 1991 to review the objections. In voting on the draft revisions to the ANSI A117.1 standard, the Board recommended that the ANSI A117 Committee consider the final ADA guidelines with the goal of establishing a single accessibility standard that meets the requirements of the ADA and that can be incorporated or referenced by the Federal government, model codes, and State and local building codes.

A single accessibility standard would greatly facilitate the certification of State and local codes by the Department of Justice.⁷ Establishing a single accessibility standard that meets the requirements of the ADA and that can be incorporated or referenced by all levels of government will also ensure that the ADA requirements are routinely implemented at the design stage when building plans are reviewed and permits issued by state and local building officials and that non-compliance can be discovered and corrected through the building inspection process before buildings are occupied.

Several commenters also recommended that the Board adopt the draft scoping provisions developed by the CABO Board for the Coordination of the Model Codes (BCMC). The draft BCMC scoping provisions were developed before the ADA was enacted and do not meet all the requirements of the ADA. Further, the draft BCMC scoping provisions were not developed

⁶ In an effort to make the guidelines generally consistent with the planned revisions to the ANSI A117.1 standard, the Board based some sections of the NPRM (e.g., alarms, detectable warnings, signage) on proposed changes considered by the ANSI A117 Committee.

⁷ Section 308(b)(1)(A)(ii) of the ADA provides that, on the application of a state or local government, the Attorney General may, in consultation with the Board, and after prior notice and a public hearing, certify that a state or local code meets or exceeds the accessibility requirements of the ADA.

in accordance with the same due process and consensus procedures followed by the ANSI A117 Committee.⁸ Nonetheless, as discussed under specific provisions, the Board has considered the draft BCMC scoping provisions where they are consistent with the requirements of the ADA.

Minimum Guidelines

Several commenters remarked that section 504 of the ADA provides that the guidelines issued by the Board are to be "minimum guidelines" and that the NPRM exceeded the Board's statutory authority. Specifically, some of the commenters noted that the provisions in the NPRM for areas of refuge [areas of rescue assistance in the final guidelines], visual alarms, detectable warnings, and signage go beyond existing codes and standards.

As discussed under the statutory background, section 504(a) of the ADA requires the Board to "issue minimum guidelines that shall supplement the existing Minimum Guidelines and Requirements for Accessible Design (MGRAD) * * *." The Board was authorized to develop MGRAD by the 1978 amendments to the Rehabilitation Act of 1973 which required the Board to "establish minimum guidelines and requirements for the standards issued pursuant to * * * the Architectural Barriers Act of 1968." 29 U.S.C. 502(b)(7).⁹ As originally promulgated by the Board, MGRAD contained detailed technical specifications which described how to make entrances, telephones, drinking fountains, toilet rooms, and other elements and spaces of a building or facility accessible; and scoping provisions which specified the extent to which the technical specifications must be followed, including which and how many elements and spaces are to be made accessible within a building or facility. The scoping provisions and technical specifications in MGRAD are considered to be "minimum guidelines" in that the four standard setting agencies under the Architectural Barriers Act of 1968 may exceed

MGRAD's requirements and establish standard that provide a greater level of accessibility. The Department of Justice and other standard setting agencies under the ADA can also exceed the Board's "minimum guidelines" and establish standards that provide greater accessibility.

Congress specifically required in section 504 of the ADA that the Board "supplement the existing [MGRAD]" for purposes of title III of the ADA and further required that the "supplemental guidelines * * * establish additional requirements, consistent with this Act, to ensure that buildings (and) facilities * * * are accessible in terms of architecture and design, * * * and communication, to individuals with disabilities." The legislative history further explains the Board's responsibilities as follows:

In issuing the supplemental minimum guidelines and requirements called for under this legislation, the Board should consider whether other revisions or improvements of the existing MGRAD (including scoping provisions) are called for to achieve consistency with the intent and the requirements of this legislation. Particular attention should be paid to providing greater guidance regarding communication accessibility.

In no event shall the minimum guidelines issued under this legislation reduce, weaken, narrow, or set less accessibility standards than those included in existing MGRAD. H. Rept. 101-485, pt. 2, at 139.

Further, Congress was clear that it intended "a high degree of convenient accessibility" and that minimum guidelines do not mean "minimal accessibility." H. Rept. 101-485, pt. 2, at 118. Thus, Congress authorized the Board to revise MGRAD and to establish new requirements where appropriate to ensure that newly constructed and altered buildings and facilities covered by title III of the ADA provide a high degree of convenient accessibility to individuals with disabilities.

In carrying out its responsibilities, the Board considered research and studies which have been conducted since MGRAD was last revised; the work of the ANSI A117 Committee in updating the ANSI A117.1 standard; and developments in the model codes. As directed by Congress, the Board paid particular attention to those areas relating to communication accessibility, including public telephones equipped with volume controls, public text telephones, assistive listening systems for assembly areas, visual alarms, detectable warnings, and signage. Where possible and consistent with the ADA, the Board attempted to make

provisions in the NPRM consistent with the planned revisions to the ANSI A117.1 standard. This was done for visual alarms, detectable warnings, and signage. In developing provisions for areas of rescue assistance, as further explained in the NPRM the Board looked to the proposed BCMC scoping provisions for the ANSI A117.1 standard and the 1991 Uniform Building Code. See 56 FR 2296, at 2304 and 2309 (January 22, 1991).

The Board received many comments on the new provisions proposed in the NPRM. As further discussed under the section-by-section analysis, the Board has carefully considered all the comments and many of the new provisions have been revised or clarified based on the comments. The Board believes that it has acted consistent with the statute in supplementing MGRAD and establishing new requirements where appropriate to ensure that buildings and facilities covered by title III of the ADA provide a high degree of convenient accessibility to individuals with disabilities.

"User Friendly" Guidelines

Several commenters recommended editorial changes to the guidelines. Some of these commenters noted that editorial changes have been proposed to the ANSI A117.1 standard and requested that the Board incorporate the proposed changes in the guidelines.

The Board has attempted to make the guidelines as "user friendly" as possible, including using the ANSI format and numbering system and providing additional explanatory information in the appendix to the guidelines. The Board also intends to make available manuals explaining the guidelines and to provide training and technical assistance. With respect to the proposed editorial changes to the ANSI A117.1 standard, the Board will consider all editorial changes to that standard after they have been approved by the ANSI A117 Committee.

Relationship to Other Regulations and Laws

A number of commenters requested clarification of the relationship between the Board's guidelines and section 302(b)(2)(A)(iv) of the ADA which requires the removal of architectural barriers, and communication barriers that are structural in nature, in existing facilities, where such removal is readily achievable.

The Board's guidelines are to be applied to the design, construction, and alteration of buildings and facilities to the extent required by regulations issued

⁸ The February 22, 1991 draft revisions to the ANSI A117.1 standard reprinted the draft BCMC scoping provisions with modifications as an appendix to the standard. However, the draft BCMC scoping provisions are not part of the ANSI A117.1 standard and are not approved by the American National Standards Institute.

⁹ The Architectural Barriers Act of 1968 requires that certain federally owned, leased, or financed buildings be accessible to individuals with disabilities. The General Services Administration, Department of Defense, Department of Housing and Urban Development, and United States Postal Service are responsible for establishing accessibility standards for those buildings covered by the Architectural Barriers Act of 1968.

by other Federal agencies, including the Department of Justice, under the ADA. The Department of Justice's final regulations will address whether the Board's guidelines are applicable to removal of barriers in existing facilities where measures are taken solely to comply with section 302(b)(2)(A)(iv) of the ADA.

Several commenters also requested the Board to clarify the relationship between its guidelines and areas used only by employees as work areas. As further discussed under the section-by-section analysis, the provision in 4.1.1(3) has been revised to clarify that such areas must be designed and constructed so that individuals with disabilities can approach, enter and exit the areas. Modifications to particular work areas to meet the needs of an individual employee or applicant with a disability would be addressed by title I of the ADA which prohibits discrimination in employment on the basis of disability and which requires reasonable accommodation. This issue is within the jurisdiction of the Equal Employment Opportunity Commission.

Some commenters requested clarification regarding what requirements apply if an entity is covered by both the ADA and other Federal laws or regulations which require accessibility in new construction and alterations such as the Architectural Barriers Act of 1968 or section 504 of the Rehabilitation Act of 1973. UFAS is the applicable standard for purposes of the Architectural Barriers Act of 1968 and is also referenced as the accessibility standard in many regulations issued by other Federal agencies under section 504 of the Rehabilitation Act of 1973. In some areas, the ADA guidelines provide for greater accessibility than UFAS (e.g., provisions relating to communication access); and in other areas, UFAS provides for greater accessibility than the ADA guidelines (e.g., no elevator exception for facilities that are less than three stories or that have less than 3,000 square feet per story). An entity that is covered by both the ADA and another Federal law or regulation which requires compliance with accessibility standards must comply with the specific provisions that provide for greater accessibility.

State and Local Government Buildings

The Board is also required by section 504 of the ADA to issue accessibility guidelines for newly constructed and altered State and local government buildings which are covered by title II of the ADA. The requirements in title II of the ADA for State and local government buildings differ in some aspects from those in title III for places of public

accommodation and commercial facilities. For example, the title III structural impracticability exception in new construction and the elevator exception for newly constructed or altered facilities that are less than three stories or have less than 3,000 square feet per story do not apply to State and local government buildings. The NPRM requested information on several issues relating to State and local government buildings for purposes of developing accessibility guidelines for those facilities, including providing access to various areas in courthouses (e.g., jury boxes, witness standards, and judge's benches); experience of detention and correctional facilities in complying with the UFAS scoping provisions under current regulations issued under section 504 of the Rehabilitation Act of 1973; and whether the requirements for alterations to State and local government buildings should be the same as for places of public accommodation and commercial facilities. The Board received many comments on these issues. The Board intends to further analyze those comments and to issue proposed guidelines for State and local government buildings for public comment after these final guidelines and the final guidelines for transportation vehicles and facilities are published.

The Department of Justice's final regulations will include requirements for new construction and alterations of State and local government buildings and further address the applicable accessibility standards.

Children's Environments and Recreational Facilities

The NPRM also requested information relevant to establishing accessibility guidelines for children's environments and recreational facilities. The Board received comments in each of these areas. The Board has undertaken several activities in preparation for developing accessibility guidelines in these areas. The Board is sponsoring a research project on "Accessibility Standards for Children's Environments". The Board is also working with the U.S. Forest Service, National Park Service, and other Federal agencies with recreation responsibilities in the development of comprehensive accessibility guidelines for outdoor recreational facilities, including boating access, water access at beaches, fishing piers, and horse back riding. It is anticipated that these projects will be completed in the Fall of 1991 and the Board intends to initiate rulemaking activity in the areas of children's

environments and recreational facilities at that time.

Although the final guidelines do not include accessibility guidelines for children's environments and recreational facilities at this time, newly constructed or altered children's facilities and recreational facilities subject to title III of the ADA must comply with these guidelines where applicable. For example, an accessible route must be provided to a swimming pool deck area even though the guidelines do not presently include specific requirements for providing access to the pool itself. Technical assistance is available from the Board in this area.

Chemical and Environmental Sensitivities

The Board received over 400 comments from individuals who identified themselves as chemically sensitive. Many of the comments were sent in on preprinted postcards distributed by the National Center for Environmental Health Strategies (NCEHS). The commenters described the health problems that they have experienced due to exposure to chemical substances and indoor contaminants in buildings, including certain building materials, furnishings, cleaning products and fragrances, and tobacco smoke. They requested that the Board address their need for access to place of public accommodation and commercial facilities. Action on Smoking and Health (ASH) also requested the Board to address tobacco smoke in buildings. NCEHS and the Environmental Health Network provided additional background materials on chemical sensitivities. Among the suggestions made to lessen exposure to chemical substances and indoor contaminants in buildings were providing windows that open; improving the design and requirements for heating, cooling, and ventilation systems; and selecting building materials and furnishings that do not contain certain chemical substances.

Chemical and environmental sensitivities present some complex issues which require coordination and cooperation with other Federal agencies and private standard setting agencies. Pending further study of these issues, the Board does not believe it is appropriate to address them at this time.

Section-by-Section Analysis

This section of the preamble contains a concise summary of the significant comments received on the NPRM, the

Board's response to those comments, and any changes made to the guidelines.

1. Purpose

The purpose section has been clarified to state that the guidelines are to be applied during the design, construction, and alteration of places of public accommodation and commercial facilities to the extent required by regulations issued by Federal agencies, including the Department of Justice, under the ADA. The Department of Justice's final regulations will address the extent to which the guidelines are applicable to places of public accommodation and commercial facilities under new construction and alteration sections, including alterations to an area containing a primary function and cost disproportionality. The Department of Justice's final regulations will also address whether the guidelines are applicable to the removal of architectural barriers, and communications barriers that are structural in nature, in existing buildings and facilities where such removal is readily achievable. The Equal Employment Opportunity Commission's final regulations will address whether the guidelines are applicable for purposes of reasonable accommodation under title I of the ADA.

2. General

2.1 Provisions for Adults

There were no comments on this section. As discussed under the general issues, the Board will develop guidelines for children's environments.

2.2 Equivalent Facilitation

Comment. Commenters generally supported the equivalent facilitation provision which permits departures from the guidelines where substantially equivalent or greater access to or usability of a building or facility is provided. Some commenters requested that the guidelines include examples of alternatives that would provide equivalent facilitation. Other commenters expressed concerns about enforcement and a few recommended that a process be established for reviewing whether equivalent facilitation is provided.

Response. The equivalent facilitation provision has been clarified by substituting the words "designs and technologies" for "methods." The purpose of the provision is to allow for flexibility to design for unique and special circumstances and to facilitate the application of new technologies. The accessibility and usability of design solutions developed for unique and

special circumstances must be evaluated on a case by case basis. In the case of new technologies which provide equivalent facilitation, as those technologies become more common, the Board will consider incorporating them in the guidelines.

The final guidelines in corporate specific provisions for equivalent facilitation in five sections. In 4.1.6(3)(c), in the case of alterations to an existing facility the guidelines permit an elevator car to have different dimensions when usability can be demonstrated and all other elements required to be accessible comply with the applicable provisions of 4.10 (e.g., a 49 inch by 69 inch elevator car with a door opening on the narrow dimension could accommodate the standard wheelchair clearances shown in figure 4). In 4.31.9, the guidelines permit the use of a portable text telephone if it is readily available for use with a nearby public pay telephone that is equipped with a shelf; an electrical outlet within, or adjacent to, the telephone enclosure; and a long enough telephone handset cord to allow connection of the text telephone and the telephone receiver if an acoustic coupler is used. In 7.2, the guidelines provide for equivalent facilitation at counters that may not have a cash register but at which goods or services are distributed (e.g., teller stations in banks, registration counters in hotels and motels) by permitting use of a folding shelf attached to the main counter on which an individual with a disability can write, and use of the space on the side of the counter or at the concierge desk for handling materials back and forth. In 9.1.4, the guidelines deem it equivalent facilitation if the operator of a hotel or similar place of transient lodging elects to limit construction of accessible rooms to those intended for multiple occupancy provided that such rooms are made available to an individual with a disability who requests a single-occupancy room. In 9.2.2(b)(d), hotels and other similar places of transient lodging are permitted to utilize a higher door threshold or a change in level at patios, terraces and balconies where necessary to protect the integrity of the unit from wind and water damage but equivalent facilitation is required where it results in patios, terraces, or balconies that are not on an accessible level (e.g., raised decking or a ramp must be provided to permit access to the patio, terrace or balcony).

Equivalent facilitation is appropriate and applies to the entire guidelines and not only those sections mentioned above. For example, other areas where equivalent facilitation may be appropriate include the use of automatic

door openers for double leaf doors, and provision of audible signage for individuals with vision impairments. The use of a portable ramp, however, is not considered equivalent facilitation.

The ADA does not require any process to be established for reviewing whether equivalent facilitation is provided.

3. Miscellaneous Instructions and Definitions

- 3.1 Graphic Conventions
- 3.2 Dimensional Tolerances
- 3.3 Notes
- 3.4 General Terminology

Few comments were received on these sections and they did not warrant any changes.

3.5 Definitions

Comment. Several commenters recommended that the term "individual with a disability" should be defined the same as in the ADA.

Response. The definition of the term "individual with a disability" has been deleted from the guidelines as unnecessary since the guidelines will be incorporated in the Department of Justice's regulations implementing title III of the ADA which will include a definition of the term. The NPRM defined "accessible" in terms of being used "by individuals with disabilities, including those affecting mobility, sensory, or cognitive functions." The definition of the term "accessible" has been revised in the final guidelines to mean a site, building, facility, or portion thereof that complies with the guidelines. In other words, buildings and facilities that meet the requirements of the guidelines are by definition accessible to individuals with disabilities.

Comment. Commenters made several recommendations for changes in the definition of the term "technically infeasible."

Response. The Definition of the term "technically infeasible" has been revised and moved to the scoping provisions for alterations at 4.1.6(1)(j). Changes to that definition are discussed under that section. A new term "structural frame" has been added to 3.5 in connection with the revised definition of "technically infeasible" which is also discussed under the scoping provision for alterations.

Comment. A commenter requested that the term "text telephone" be used in place of "telecommunication display device or telecommunication device for the deaf (TDD)."

Response. The term "text telephone" is used in the final guidelines. The term "TDD" is often understood to include devices which use only the Baudot code. Many newer models are also capable of transmitting in the ASCII code and this appears to be the trend. Other systems of communication based on computer hardware and software are also being used for communication by individuals with disabilities and their rapid proliferation suggests that they may become the dominant modes of communication in the future. The Board is concerned that the term "TDD" will become outmoded, and that entities will assume that they have satisfied their responsibilities by providing access only in an obsolete format that may be incompatible with many devices. By using the more inclusive term "text telephone," the Board intends that, as technology develops in this rapidly changing area, entities will be able to choose from a broader range of appropriate devices and formats.

Further, although the term TDD refers to a "telecommunication device for the deaf," TDDs are not used only by individuals who are deaf. Nor do all individuals who are deaf use TDDs to communicate over the telephone. The legislative history recognizes that many individuals who are deaf, hard of hearing, and speech impaired use other kinds of non-voice terminal devices. The term "text telephone" would encompass the various types of telecommunication devices. This term is currently used in Europe to describe telephones with keyboards and visual screens, and it is generally understood to mean TDDs, computer hardware and software, and other non-voice terminal devices. "Text telephones" do not include facsimile (fax) equipment.

4. Accessible Elements and Spaces: Scope and Technical Requirements

4.1 Minimum Requirements

The scoping provisions are contained in 4.1.1 through 4.1.7 and are discussed below.

4.1.1 Application

This section describes the application of the guidelines.

General (4.1.1 (1))

Comment. Several commenters requested that the application of the guidelines be clarified with respect to existing buildings.

Response. The general provision in 4.1.1(1) has been revised to clarify that all areas of newly designed or constructed buildings and facilities, and altered portions of existing buildings

and facilities required to be accessible by 4.1.6, must comply with the guidelines unless otherwise provided in 4.1.1 or a special application section. The specific requirements for alterations to existing buildings are discussed under 4.1.6.

Application Based on Building Use (4.1.1(2))

Comment. Several commenters requested that application of the guidelines be clarified with respect to transportation facilities.

Response. The special application sections 5 through 10 provide additional requirements for restaurants and cafeterias, medical care facilities, business and mercantile facilities, libraries, transient lodging, and transportation facilities. Section 10 on transportation facilities was reserved in the NPRM. The Board issued a supplemental notice of proposed rulemaking (SNPRM) on March 20, 1991 in connection with its proposed guidelines on transportation vehicles containing proposed additional requirements for transportation facilities (56 FR 11874).¹⁰ A final section 10 on transportation facilities will be issued at the same time as the final guidelines for transportation vehicles. Although the final guidelines do not contain any additional requirements for transportation facilities at this time, newly constructed or altered transportation facilities subject to title III of the ADA must comply with these guidelines where applicable. For example, the restrooms in a newly constructed transportation facility such as a bus depot must comply with the requirements for accessible toilet facilities.

Areas Used Only By Employees As Work Areas (4.1.1(3))

Comment. A number of commenters requested that the application of the guidelines to areas used only by employees as work areas be clarified. Some commenters wanted employee work areas to be adaptable with adjustable elements and to comply with requirements for clear floor space, reach ranges and visual alarms.

Response. The legislative history explains that areas used only by employees as work areas are covered by the guidelines but individual work

¹⁰ The SNPRM also proposed to amend the guidelines to make them applicable to transportation facilities constructed or altered by public entities covered by title II of the ADA. Until final notice of the amended guidelines is published in the *Federal Register*, the guidelines do not apply to transportation facilities constructed or altered by public entities covered by title II of the ADA.

stations are not required to be constructed in a fully accessible manner. H. Rept. 101-485, pt. 3, at 63. Modifications to an individual workstation would be covered by reasonable accommodation under title I of the ADA which prohibits discrimination in employment on the basis of disability. The Equal Employment Opportunity Commission is responsible for issuing regulations to implement title I of the ADA.

The provision in 4.1.1(3) has been revised to clarify that areas that are used only by employees as work areas shall be designed and constructed so that individuals with disabilities can approach, enter, and exit the areas. For instance, individual office rooms in a typical office building must be on an accessible route and the doors to the rooms must comply with the technical specifications in 4.1.3.

The guidelines do not require that any work areas be constructed to permit maneuvering within the work area (e.g., maneuvering spaces around a desk) or that fixed or built-in equipment be accessible (e.g., counters or shelves). However, modifications may be required to a particular work area for an individual employee or applicant with a disability as a reasonable accommodation under title I of the ADA.

The appendix includes advisory guidance on individual work stations at A4.1.1(3). Where there are a series of built-in or fixed individual work stations of the same type (e.g., laboratories, service counters, ticket booths), in order to facilitate reasonable accommodation at a future date, it is recommended that 5% or at least one of each type of work station should be constructed so that an individual with disabilities can maneuver within the work station. Consideration should also be given to placing shelves in an employee work area at a convenient height for accessibility or installing commercially available shelving that is adjustable so that reasonable accommodations can be made in the future.

Comment. The NPRM requested information on fixed or built-in equipment in physician's offices that is used by patients and should be addressed by the guidelines. Commenters recommended that examining tables, diagnostic machinery, and dental chairs should be accessible or adaptable. However, anecdotal information suggests that most of the equipment is not fixed or built-in the structure of the building. No information was submitted on technical specifications for such equipment.

Response. These guidelines are intended to address only that equipment that is fixed or built into the structure of the building. The Board believes that this issue requires further study before it can be addressed in the guidelines. The Board may provide technical assistance in this area.

Temporary Structures (4.1.1(4))

Comment. The NPRM asked whether trailers at construction sites should be included in the list of temporary structures in 4.1.1(4) covered by the guidelines. Most of the commenters from each category who responded to the question stated that such structures should not be required to comply with the guidelines. The Associated General Contractors of America pointed out that the legislative history specifically states that construction sites are not to be considered a public accommodation. See H. Rept. 101-485, pt. 1, at 36.

Response. Based on legislative history, the list of temporary structures in 4.1.1(4) has been revised to state that construction trailers are not included.

General Exceptions (4.1.1(5))

Comment. With respect to the exception in 4.1.1(5)(a) for structural impracticability in new construction, some commenters questioned whether such an exception is necessary in new construction. Other commenters requested that the term be further defined. A few commenters suggested that the exception implied that the entire building or facility was exempt from the guidelines.

Response. The exception in 4.1.1(5)(a) is based on section 303(a)(1) of the ADA. The legislative history explains that the exception is a narrow one and applies only in rare circumstances where unique characteristics of terrain prevent the incorporation of accessibility features. H. Rept. 101-485, pt. 2, at 120. The legislative history further explains that the exception is not to be viewed as totally exempting the entire building or facility for the guidelines. *id.* The exception has been revised to clarify that if full compliance with the guidelines is structurally impracticable in new construction, the entity must comply with the guidelines to the extent that it is not structurally impracticable. Any portion of the building or facility which can be made accessible and is required by the guidelines to be accessible must comply with the guidelines.

Comment. The NPRM asked whether other spaces should be included in the list in 4.1.1(5)(b) of spaces exempt from complying with the guidelines and whether functional criteria should be

developed for identifying such spaces. Most of the commenters who responded to the question favored the functional criteria approach. Commenters also recommended specific spaces to be included in the exception.

Response. The exception in 4.1.1(5)(b) has been revised to include functional criteria and exempts non-occupiable spaces that are: (a) Accessed only by ladders, catwalks, crawl spaces, very narrow passageways, or freight or non-passenger elevators; and (b) frequented only by service personnel for repair purposes. Such spaces include but are not limited to elevator pits, elevator penthouses, and piping or equipment catwalks. Some of the spaces recommended by commenters such as cooling towers and utility tunnels would be covered by the functional criteria. Other spaces suggested by commenters such as mechanical rooms or closets that are not accessed by ladders or very narrow passageways are considered employee work areas and are covered under 4.1.1(3) which only requires that individuals with disabilities be able to approach, enter, and exit the area but does not require maneuvering space to be provided in the area.

Observation galleries that are raised to look out over an area below and are used primarily for security purposes have also been included in the spaces exempt from the guidelines. This exemption prevails over the requirement in 4.1.1(3) that employee work areas be designed and constructed so that individuals with disabilities can approach, enter, and exit the area. Under the exemption, a vertical means of accessibility is not required to such galleries. However, modifications to such galleries to provide a vertical means of access to an employee with a disability may be required as a reasonable accommodation under title I of the ADA.

4.1.2 Accessible Sites and Exterior Facilities

This section contains scoping provisions for accessible sites and exterior facilities.

Accessible Route (4.1.2(1) and (2))

Protruding Objects (4.1.2(3))

Ground Surfaces (4.1.2(4))

Few comments were received on these scoping provisions and they did not warrant any changes.

Parking (4.1.2(5))

Comment. A number of commenters from each category stated that the number of accessible parking spaces specified in the table in 4.1.2(5)(a) is

adequate. Some commenters stated that the number should be increased, and other commenters stated that the number should be reduced. One commenter submitted a report prepared for the Institute of Traffic Engineers (ITE) which was based on a survey of 198 sites taken between 1986 and 1987. The ITE report recommended that the number of accessible spaces be based on occupancy type and gross floor area of the building or facility. The National Parking Association (NPA) and some members of its Parking Consultants Council (PCC) submitted recommended standards based on the ITE report. The NPA/PCC standards recommend that three categories be established for accessible parking spaces: High use, moderate use, and low use. The high use category would provide a number of accessible parking spaces similar to that contained in the table in 4.1.2(5)(a) and apply to occupancy types where an above average number of individuals with disabilities might reasonably be anticipated. The NPA/PCC suggested that high use occupancy types would include hospitals, nursing homes, medical office buildings, and social service agencies. The low use category would provide for approximately one-half the number of accessible spaces as the high use category and apply to occupancy types which generate primarily regular, long-term parking (3 hours or more in duration) such as airports, schools, universities, office buildings (except medical), warehousing, manufacturing, and industries. The medium use category would provide for a number of accessible parking spaces between the high use and low use categories and apply to any occupancy type that does not clearly qualify as either high or low use. The NPA submitted a revised set of recommendations after the close of the comment period based on a recent survey by its members. In place of the high, medium, and low use categories, the NPA recommended three classes of occupancy types. Class I would consist of medical facilities and have a slightly higher number of accessible parking spaces than contained in the table in 4.1.2(5)(a). Class II would consist of public accommodations except those specifically included in Classes I or III and provide for a number of accessible parking spaces similar to that contained in the table in 4.1.2(5)(a). According to the NPA, the recent survey data showed the number of parking spaces specified in the table in 4.1.2(5)(a) "appears to reasonably fit the Class II uses [public accommodations] and the requirements of smaller facilities are not

unreasonable." Class III would consist of commercial uses, mixed uses in which the majority of parkers are generated by a commercial use, public parking facilities in central business districts, and universities and provide for about one-half the number of accessible parking spaces specified in the table in 4.1.2(5)(a).

Response. The number of parking spaces required for specific occupancy uses is usually established by State and local zoning and land use codes. The guidelines require that a percentage of the parking spaces required under State and local codes be accessible. As noted above, the recent NPA survey supports the adequacy of the table contained in 4.1.2(5)(a) for most public accommodations. A recent study conducted for the Board on accessible parking spaces and loading zones also concluded that the table in 4.1.2(5)(a) was adequate and recommended that surveys be taken every two to three years to evaluate its continuing adequacy. No changes have been made in the table contained in 4.1.2(5)(a) because the comments and two surveys support the table.

A sentence has been added to 4.1.2(5)(a) to clarify that spaces required by the table need not be provided in the particular lot. They may be provided in a different location if equivalent or greater accessibility in terms of distance from an accessible entrance, cost, and convenience is ensured.

The NPRM proposed to add a provision to 4.1.5(a) requiring accessible parking spaces to be located as close as practical to an accessible entrance. In the final guidelines, requirements regarding the location of accessible parking spaces have been consolidated in the technical specifications for parking at 4.6.2 and are further discussed there.

Facilities that provide medical care and other services for persons with mobility impairments are discussed under a separate comment below. As for so called "low use" or "Class III" occupancy types, the ITE and NPA surveys apparently did not consider the level of accessibility provided at the buildings and facilities which would affect usage by individuals with disabilities. The Board finds no basis for concluding that individuals with disabilities have less need for using buildings and facilities included in the so called "low use" or "Class III" occupancy types, including airports, schools, universities, office buildings, and public parking facilities in central business districts. The passage and implementation of the ADA will enable and encourage many more individuals

with disabilities to use these buildings and facilities and, therefore, the Board rejects establishing a separate table with a lower number of accessible parking spaces for so called "low use" or "Class III" occupancy types.

Comment. The NPRM asked whether accessible parking spaces should be required for vans and, if so, whether such spaces should be in addition to the number of accessible parking spaces specified in the table in 4.1.2(5)(a) or a percentage of those spaces. Most of the persons in each category who responded to the question were in favor of requiring accessible parking spaces for vans and recommended that those spaces should be a percentage of the spaces specified in the table in 4.1.2(5)(a). Specific recommendations ranged from 0.5% to 75%. Commenters also submitted various recommendations for the minimum width of accessible parking spaces needed to accommodate vans which ranged from 13 feet to 18 feet, including an adjacent access aisle. Recommendations for vertical clearance needed for vans ranged from 96 inches to 144 inches. Several commenters recommended that all accessible parking spaces should be the same size and be capable of accommodating vans. Some commenters recommended adoption of the universal parking design guidelines developed by the City of Phoenix Fire Department which provides for all accessible parking spaces to be at least 11 feet wide and to have an adjacent access aisle at least 5 feet wide.

Response. The technical specification in 4.6.3 for accessible parking spaces require such spaces to be 8 feet (96 inches) wide minimum and to have an adjacent access aisle 5 feet (60 inches) wide minimum. Two accessible parking spaces may share a common access aisle. An access aisle that is 60 inches wide does not provide sufficient space to permit a lift to be deployed from the side of a van and still leave room for a person using a wheelchair or other mobility aid to exit from the lift platform. A recent Board sponsored study on accessible parking and loading zones conducted tests with various van, lift, and wheelchair combinations and found that a parking space and access aisle almost 17 feet wide is needed to deploy a lift and exit conveniently.

Requirements have been added to the scoping provisions in 4.1.2(5)(b) requiring that one in every eight accessible parking spaces, but not less than one, be served by an access aisle 96 inches (8 feet) wide minimum and be designated "van accessible." For instance, if there are 16 accessible

parking spaces, at least two wider access aisles must be provided. If a wider access aisle is placed between two accessible parking spaces, then both parking spaces can accommodate vans.

Requirements have also been added to the technical specifications in 4.6.5 regarding the vertical clearance to be provided at van accessible parking spaces. The NPRM proposed that the minimum vertical clearances should be 114 inches. This figure was taken from MGRAD and UFAS which was based on a survey of paratransit vehicles for purposes of establishing the vertical clearance needed at passenger loading zones. The survey found that the highest paratransit vehicle had a height of 120 inches but that a vertical clearance of 114 inches would accommodate most paratransit vehicles. MGRAD and UFAS used the same figure for accessible parking spaces for vans; however, such spaces were not mandatory. Personal vans are usually not as tall as paratransit vehicles. This is especially true with growing use of accessible mini-vans. California requires a minimum vertical clearance of 98 inches which accommodates most vans without seriously affecting multi-level parking structures. Based on the experience with the California standard, the technical specifications in 4.6.5 adopt a minimum vertical clearance of 98 inches for van accessible parking spaces. The vertical clearance must be provided along at least one vehicle access route from the site entrance(s) and exit(s) to the van accessible parking space. The technical specifications in 4.6.5 permit the van accessible parking spaces to be grouped on one level of a parking structure.

An exception has also been added to 4.1.2(5)(a) permitting all required accessible parking spaces to conform to the universal parking design guidelines developed by the City of Phoenix Fire Department. As discussed above, those guidelines provide for accessible parking spaces to be at least 11 feet wide and to have an adjacent access aisle at least 5 feet wide. Additional information on the universal parking design guidelines is provided in the appendix at A4.6.3

Comment. A number of commenters recommended that the scoping provision for accessible parking spaces at transient lodging (4.1.2(5)(d) in the NPRM) be revised. The provision would require that where parking is provided for all occupants, one accessible parking space be provided for each accessible unit or sleeping room; and where parking is provided for visitors, 2% of the spaces or a least one be accessible.

Some commenters pointed out that the provision was not workable because many places of transient lodging, such as hotels, do not provide parking spaces for each room.

Response. The provision was based on similar requirement in MGRAD and UFAS which was intended for accessible housing. The provision may not be applicable to all places of transient lodging and has been deleted from the final guidelines. Instead, places of transient lodging must provide the number of accessible parking spaces specified in the table in 4.1.2(5)(a).

Comment. The NPRM asked whether the scoping provision in 4.1.2(5)(d) (4.1.2(5)(e) in the NPRM) should require nonmedical facilities that specialize in providing services for persons with mobility impairments such as vocational rehabilitation facilities to provide a higher number of accessible parking spaces. Most of the commenters who responded to the question favored requiring such facilities to provide a higher number of accessible parking spaces. Some commenters recommended that the percentage be greater than that proposed in the NPRM.

Response. The scoping provision in 4.1.2(5)(d) (4.1.2(5)(e) in the NPRM) has been revised and clarified. The provision has been clarified as applying to facilities that provide medical care and other services for persons with mobility impairments and units of such facilities. Generally, facilities that provide medical care and other services for persons with mobility impairments are required to provide the number of accessible parking spaces specified in the table in 4.1.2(5)(a) except in two cases. The first case applies to outpatient units and facilities where 10% of the total number of parking spaces serving each such unit or facility must be accessible. The second case applies to units and facilities that specialize in treatment or services for persons with mobility impairments where 20% of the total number of parking spaces serving each such unit or facility must be accessible. The latter case would include vocational rehabilitation facilities.

Comment. The National Parking Association (NPA) requested that valet parking facilities not be required to comply with the guidelines.

Response. Valet parking facilities are different from self-parking facilities. In valet parking facilities, the driver and passenger usually leave the vehicle at the entrance of the facility and another person parks the vehicle. The final guidelines require in 4.1.2(5)(e) that valet parking facilities provide an accessible passenger loading zone located on an

accessible route to the entrance of the facility. Additional advisory material on valet parking is included in the appendix at A4.1.2(5)(e).

Portable Toilet and Bathing Units (4.1.2(6))

Comment. The NPRM asked whether the scoping provision of accessible portable toilets and bathing units should be advisory or mandatory. Most persons who responded to the question favored making the provision mandatory. As for how many accessible units should be required when single user units are clustered at a single location, the recommendations ranged from at least one unit to 100%.

Response. The provision has been revised to require that where single user portable toilet or bathing units are clustered at a single location, at least 5% but no less than one of the units at each cluster must be accessible.

Comment. Several commenters recommended that portable toilet units at construction sites should not be required to be accessible.

Response. An exception has been added for portable toilet units at construction sites used exclusively by construction personnel.

Exterior Signage (4.1.2(7))

Comment. Based on the comments received from graphic designers and sign manufacturers, the Board concluded that the scoping provisions and technical specifications for signage were unclear and needed to be revised. Many interpreted the NPRM as requiring all signs to have raised and brailled characters and all upper case letters.

Response. The scoping provisions for exterior and interior signage and the accompanying technical specifications have been clarified and revised in response to the comments. See 4.1.3(16) for scoping provisions for interior signage; and 4.30 for technical specifications for signage. Exterior signs which designate permanent rooms and spaces must comply with the technical specifications in 4.30.1 and 4.30.4 through 4.30.6 for raised and brailled characters, finish and contrast, and mounting location and height. For instance, signs on toilet facilities at a zoo must have raised and brailled characters designating the men's and women's toilet facilities, and also meet the finish and contrast, and mounting location and height requirements. Exterior signs which provide directions to or information about functional spaces of a building or facility must comply with the technical specifications in 4.30.1, 4.30.2 and 4.30.5 for character proportion, and finish and contrast. The

technical specifications in 4.30.3 for character height must also be complied with if the signage is suspended or projected overhead in compliance with the technical specifications in 4.4.2 for head room for protruding objects. For instance, a sign adjacent to a pedestrian walkway directing the public to an accessible entrance to a building or facility must meet the character proportion and finish and contrast requirements, as well as the character height requirements if suspended or projected above the walkway in compliance with 4.4.2.

4.1.3 Accessible Buildings: New Construction

This section contains scoping provisions for new construction of accessible buildings and facilities.

Accessible Route (4.1.3(1))

Protruding Objects (4.1.3(2))

Ground and Floor Surfaces (4.1.3(3))

Few comments were received on these scoping provisions and they did not warrant any changes.

Stairs (4.1.3(4))

Comment. Several commenters requested clarification regarding whether 4.1.3(4) applies to exterior stairs, as well as interior stairs.

Response. The provision has been clarified that interior and exterior stairs must comply with the technical specifications in 4.9 for stairs when they connect levels that are not connected by an elevator or other accessible means of vertical access (e.g., ramp or lift). In other words, for example, if an elevator serves as a means of going from one floor to another, the stairs connecting the two floors are not required to comply with 4.9.

Comment. The NPRM asked whether in new construction stairs connecting levels that are also served by an elevator should be required to comply with the technical specifications in 4.9 for stairs especially since stairs must be used in emergency evacuations. Most persons who responded to the question favored such a requirement. Several commenters recommended that the provision should apply only to stairs required by State and local building codes for egress. Other commenters noted that the model codes are incorporating more safety features for stairs and that it is unnecessary to address the same features in accessibility standards.

Response. The technical specifications in 4.9 regarding stair treads and risers, nosings, and handrails

are safety features which affect all members of the public. As the model codes are updated, more general safety features which also provide greater accessibility are being incorporated in those codes. The problem identified in the NPRM may be addressed through the model codes. The Board plans to monitor the development of the model codes and has not made any changes to the scoping provision for stairs other than to clarify that the provisions applies to exterior stairs, as well as interior stairs.

Elevators (4.1.3(5))

Elevator Exemption (4.1.3(5) Exception 1).

Comment. A number of commenters objected to exempting buildings and facilities that are less than three stories or have less than 3,000 square feet per story from the elevator requirement unless the building or facility is a shopping center, a shopping mall, the professional office of a health care provider, or another type of facility that has been determined by the Attorney General to require an elevator.

Response. The elevator exemption is based on section 303(b) of the ADA. The Department of Justice is responsible for implementing this section of the ADA and that agency's final regulations will address definitions and application of the section.

A statement has been added to the appendix at 4.1.3(8) explaining that if a building or facility is exempt from the elevator requirement, it is not necessary to provide another accessible means of vertical access (e.g., ramps, platform lifts or wheelchair lifts) between each level of the building or facility.

Comment. Some commenters requested that basements, attics, and mezzanines be counted for purposes of determining whether a building or facility is less than three stories. Other commenters requested that basements, attics, and mezzanines not be counted.

Response. A "story" is defined in 3.5 as including "occupiable" space which in turn is defined as space that is: (a) Designed for human occupancy in which individuals congregate for amusement, educational or similar purposes, or in which occupants are engaged at labor; and (b) equipped with means of egress, light, and ventilation. If a basement or attic is designed or intended to be used as occupiable space or is later altered to be occupiable, it is counted for purposes of determining whether a building or facility is less than three stories.

As for mezzanines, the model codes do not consider mezzanines to be a story. Where possible, the Board defines

terms in the guidelines to be consistent with the model codes when they are also consistent with the ADA and, therefore, mezzanines are not counted for purposes of determining whether a building or facility is less than three stories. However, as further discussed below, if a building or facility is exempt from the elevator requirement, but nonetheless has a full passenger elevator, that elevator must serve each level, including the mezzanine.

Comment. Several commenters questioned why buildings and facilities that are exempt from the elevator requirement must comply with other requirements in 4.1.3 on floors above or below the accessible ground floor.

Response. This provision is based on the legislative history which states that "the exception regarding elevators does not obviate or limit in any way the obligation to comply with the other accessibility requirements established by this legislation, including requirements applicable to floors which, pursuant to the exception, are not served by an elevator." H. Rept. 101-485, pt 2, at 114. There are several reasons for this provision. Some individuals who are mobility impaired may work on a building's second floor, which they can reach by stairs and the use of crutches; however, the same individuals, once they reach the second floor, may then use a wheelchair that is kept in the office. Further, an elevator may be installed at a future date, or an addition to the building or a second building which is later connected may include an elevator. The second floor must also be accessible to individuals with visual or hearing impairments.

Comment. With respect to a new building or facility that is exempt from the elevator requirement but an elevator is nonetheless planned, the NPRM asked whether it was appropriate to require the elevator in such a building or facility to meet the technical specifications in 4.10 for elevators and to serve each level in the building or facility. Most persons who responded to the question favored the requirement. Some commenters recommended that the provision be limited to full passenger elevators and not freight elevators.

Response. This provision is also based on the legislative history. See H. Rept. 101-485, pt. 2, at 114. The Board agrees that the provision should apply only to full passenger elevators and has added appropriate language to the elevator exemption. A sentence has also been added to the provision that if a full passenger elevator provides service from a garage to only one level of a building or facility, it is not required to

serve the other levels of the building or facility.

Platform Lifts/Wheelchair Lifts (4.1.3(5) Exception 4)

Comment. The NPRM noted that some building codes and the proposed BCMC scoping provisions prohibit the installation of platform lifts or wheelchair lifts as part of a required accessible route in new construction and asked a series of questions regarding their use. Individuals with disabilities and their organizations who responded to the questions viewed platform lifts or wheelchair lifts as inferior to ramps, not independently operated, poorly maintained, dangerous, and undignified. However, some of these commenters acknowledged that in some alteration projects, and in limited areas in new construction, a platform lift or wheelchair lift may be the only viable option for accessibility. Lift manufacturers and vendors acknowledged that there have been significant problems in the past but believed that improvements have been made, and gave examples where a platform lift or wheelchair lift provided a better design solution than a ramp. Several architects and other commenters recommended that the Board specify conditions for the use of platform lifts or wheelchair lifts.

Response. Rather than prohibit platform lifts or wheelchair lifts in new construction, the Board believes that the better approach is to specify the conditions where their use is allowed. The applicable exception under 4.1.3(5) has been revised to permit the use of platform lifts or wheelchair lifts complying with 4.11 and applicable State or local codes in new construction under the following conditions:

(a) To provide an accessible route to performing area in an assembly occupancy;

(b) To comply with the wheelchair viewing position line-of-sight and dispersion requirements of 4.33.3 (e.g., to provide access to seating areas located above a cross aisle or to box seats);

(c) To provide access to incidental occupant spaces and rooms which are not open to the general public and which house no more than five persons (e.g., equipment control rooms, projection booths, radio and news booths, raised pharmacy platforms, manager's stations in food stores); and

(d) To provide access when existing site constraints or other constraints make use of a ramp or an elevator infeasible.

The last condition allows the use of platform lifts or wheelchair lifts only in

very limited circumstances where use of a ramp or an elevator is infeasible due to existing site constraints or other constraints. For example, if a new infill building is being constructed incorporating a historic facade which must be maintained, thereby effectively predetermining the entry floor level, and space for a ramp to the entry floor level was not available, a platform lift or wheelchair lift would be permitted.

Windows (4.1.3(6))

The NPRM proposed to require that operable windows comply with the technical specifications in 4.12 for windows. For reasons explained under 4.12, the Board has decided to reserve the technical specifications for windows in the final guidelines and, therefore, the scoping provision is also reserved.

Doors (4.1.3(7))

Comment. Several commenters requested that a requirement be added for at least one automated door at a principal entrance, or at each entrance, or at certain rooms (e.g., restrooms, meeting rooms).

Response. The force required to open a door can affect usability of a building or facility by individuals with disabilities. This is especially true for exterior doors where a variety of factors can affect closing force (e.g., wind pressure, weight of door, heating and ventilation systems, positive or negative pressure within a building). Neither UFAS nor these guidelines specify an opening force for exterior doors because of these variable factors. Requiring an automated door in certain occupancies or large buildings could provide a solution to the problem. The Board plans to study this issue to determine where and in what types of buildings and facilities automated doors may be practical or necessary and cost feasible for future revision of the guidelines.

Entrances (4.1.3(8))

Comment. The NPRM asked two questions regarding entrances in new construction. First, in the case of buildings that have more than one ground floor level (e.g., buildings with a split level entrance leading only to stairs or escalators which connect with upper and lower levels less than one story above or below grade, and buildings built on hillsides with more than one floor having direct access to grade), should each ground floor level have an accessible entrance?¹¹ Second, should

all entrances to every building be accessible. Businesses generally favored providing an accessible entrance at only one ground floor level in response to the first question and making some but not all entrances accessible in response to the second question. Individuals with disabilities and their organizations, and commenters from other categories, generally favored providing an accessible entrance at each ground floor level in response to the first question and making all entrances accessible in response to the second question.

Response. The NPRM proposed to follow UFAS which establishes two requirements for entrances. First, at least one principal entrance at each ground floor would be required to be accessible.¹² Second, when a building or facility has entrances which normally serve transportation facilities, passenger loading zones, accessible parking facilities, public streets and sidewalks, or accessible interior vertical access, at least one of the entrances serving each function would have to be accessible.

Depending on the interpretation of what it means for an entrance to "normally serve" a function, the NPRM could result in all the entrances to a building being accessible as illustrated by the following example. A building has four entrances: One on each side. Two of the entrances lead directly to parking lots of equal size on opposite sides of the building. People who use the building usually arrive by car and enter through the two parking lot entrances making them principal entrances. Each parking lot has accessible parking spaces and the two parking lot entrances are accessible and connected by an accessible route to the accessible parking spaces. The third entrance leads directly to a driveway with a bus stop and the fourth entrance leads directly to a public sidewalk. Even if the bus stop and the public sidewalk are connected by an accessible route to the two parking lot entrances, the third and fourth entrances could nonetheless be required to be accessible under the NPRM if an entrance which "normally serves" a function means the nearest entrance which directly leads to the function.

¹¹ "ground floor," for example, by constructing a building whose main entrance leads only to stairways or escalators that connect with upper or lower floors; at least one accessible ground story must be provided." H. Rept. 101-596, at 77.

¹² UFAS defines a "principal entrance" as "the main door through which most people enter." The NPRM defined a "principal entrance" as "one through which a significant number of people enter" in recognition of the fact that buildings, especially larger ones, typically have several principal entrances.

The legislative history makes clear that not every feature of every building needs to be accessible but rather a high level of convenient access is contemplated. The legislative history further states that "(a)ccessibility requirements shall not be evaded by constructing facilities in such a way that no story constitutes a 'ground floor,' for example, by constructing a building whose main entrance leads to stairways or escalators that connect with upper or lower floors; at least one accessible ground story must be provided." H. Rept. 101-596, at 77. Thus, each newly constructed building or facility must have at least one ground story entrance and at least one accessible entrance. The legislative history does not state that all or even most entrances must be accessible.

The Board wants to ensure a high level of access to all new buildings consistent with the statute. The Board has sought to require accessible entrances in a number that is easily definable and reasonable. The Board also wants to ensure that the requirements can be and will be met in all instances, except in those rare cases where the structural impracticability exception applies. In some urban and suburban areas, much new construction is "infill" between existing facilities and is constricted by slope and other site considerations, such as existing sidewalks and nearby property lines. In some areas there are land use plans and other restrictions that, in effect, limit development to sites where slopes are between 10% and 25%. For example, Maryland is considering imposing a land use plan on its localities which would preserve "agricultural" land (generally less than 10% slope) and steeply sloped land (more than 25% slope) and thus focus new development in areas with slopes between 10% and 25%. The Board understands that other States are considering similar proposals. Structural impracticability is a very narrow exception and, as explained in the legislative history, does not apply to situations where a building is constructed on "hilly" terrain or on a plot of land with steep slopes. H. Rept. 101-485, pt. 2, at 120. The Board believes it would be unreasonable to require all entrances to be accessible in these cases.

There is very little data available concerning the impact of site considerations on entrance accessibility. The Department of Housing and Urban Development's analysis of its Fair Housing Accessibility (FHA) Guidelines estimated the cost of providing 27 accessible entrances in new

¹¹ This question was suggested by the legislative history which stated that: "[a]ccessibility requirements shall not be evaded by constructing facilities in such a way that no story constitutes a

constructions at three different apartment complexes at sites having slopes of less than 10%, as ranging from an additional \$240 to \$1636 per entrance. The average cost was \$836 per entrance. This data is not easily transferable to commercial construction because of the differences between residential and commercial construction and the differences in the FHA guidelines and the ADA guidelines. The Board's draft final regulatory impact analysis estimates the cost of an accessible building entrance ramp with a 1:12 slope for a 5-foot rise and railings extensions to be \$6460 for offices and hotels. This cost does not take grading or retaining walls into account.

Thus, the Board is not at this time mandating 100% accessible entrances in new construction. At the same time, the Board recognizes that providing only one accessible entrance to a building with multiple public entrances will not always achieve the high level of convenient access contemplated by the ADA. In light of all these concerns, the Board has established two independent requirements for entrances in 4.1.3(8)(a) and (b). First, 4.1.3(8)(a)(i) requires that at least 50% of all public entrances be accessible. One of these must be a ground floor entrance. In addition, 4.1.3(8)(a)(ii) requires that accessible entrances must be provided in a number at least equivalent to the number of exits required by the applicable State or local building or life safety code. This provision acknowledges the importance of life safety issues in access to, use of, and egress from a building. Model building and life safety codes are generally consistent in their method of determining the number of exits required, the exit width necessary, and the separation of exits needed to ensure safe egress during an emergency. Since not all exits are required to serve as entrances, if only one building entrance is planned, and a building or life safety code requires two fire exits, 4.1.3(8)(ii) would not require the provision of more than the one planned entrance. Furthermore, 4.1.8(a)(iii) requires accessible entrances be provided to each tenancy in a facility. One entrance may be considered as meeting more than one of the requirements in 4.1.3(8)(a) (i) through (iii). Where feasible, the accessible entrances must be the entrances used by the majority of people visiting or working in the building.

Second, 4.1.3(8)(b) (i) and (ii) require that accessible entrances be provided from any indoor garages, pedestrian tunnels, or elevated walkways that have entrances to the facility. One entrance

may be considered as meeting more than one of the requirements in 4.1.3(8)(b) (i) and (ii).

The Board believes that these provisions, combined with the other requirements described above, will ensure access at least equivalent to that required by MGRAD and UFAS and intended by Congress.

The NPRM included a requirement in the technical specifications for signage at 4.30.1 that entrances which are not accessible to have directional signage complying with 4.30 indicating the location of the nearest accessible entrance. This requirement has been placed in the scoping provisions for entrances in the final guidelines.

Comment. Several commenters recommended including sections from the proposed BCMC scoping provisions in the guidelines requiring an accessible entrance to be provided to each tenancy within a building (e.g., retail stores in a strip shopping center), and all entrances having walkways with a change in elevation of 6 inches or less at the entrance to be accessible.

Response. Multi-tenant facilities such as a strip shopping center are generally viewed as one building. To ensure that each retail store and other places of public accommodation within such facilities are accessible, a requirement has been added to 4.1.3(8)(a)(iii) for an accessible entrance to be provided to each tenancy within a building. As for entrances having walkways with a change in elevation of 6 inches or less at the entrance, the provision is not necessary in light of 4.1.3(8) in its entirety. Further, the proposed BCMC scoping provision does not address the fact that site preparation can usually be made to ensure an elevation change of more than 6 inches, thereby circumventing the intent of the requirement.

Egress and Areas of Rescue Assistance (4.1.3(9))

Comment. The NPRM proposed to require "areas of refuge" in newly constructed buildings and facilities which were defined as areas, which have direct access to an exit stairway, where people who are unable to use stairs may remain safely to await further instructions or assistance during emergency evacuation. Building owners and managers and businesses objected to the concept of "area of refuge." Many of these commenters, including the Building Owners and Managers Association (BOMA), expressed concern that such areas would result in restricting evacuation of individuals with disabilities during an emergency. Evacuation plans were recommended

instead. Individuals with disabilities and their organizations who commented on the provision supported it.

Response. The Board wishes to emphasize that the purpose of areas of refuge is to facilitate and not restrict the evacuation of wheelchair users and other individuals with mobility impairments during an emergency. MGRAD, UFAS, and the ANSI A117.1 standard, all require that accessible routes connect to an accessible place of refuge in the event of an emergency. Since elevators are generally not available for egress during a fire, a safe area is needed where wheelchair users and other individuals with mobility impairments who cannot exit by stairways can temporarily await further instructions or evacuation assistance. To clarify this point, the area has been renamed "areas of rescue assistance" in the final guidelines. The appendix to the guidelines recognizes in A4.3.10 that an emergency management plan for the evacuation of people with disabilities is essential in providing for fire safety in buildings and facilities. However, an evacuation plan alone is not sufficient to ensure the safety of individuals with mobility impairments during an emergency since individuals may not be able to transfer to an evacuation device or may require assistance from trained personnel.

The final guidelines incorporate modified scoping provisions and technical specifications from chapter 31, section 3104 of the 1991 Uniform Building Code. In buildings and facilities, or portions of buildings and facilities, required to be accessible under the ADA, accessible means of egress must be provided in the same number as required for exits by State or local building and life safety codes. Where a required exit from an occupiable level above or below a level of accessible exit discharge is not accessible, areas of rescue assistance must be provided on each level in a number equal to that of inaccessible required exits. A horizontal exit which meets the requirements of state or local building or life safety codes may also be used for an area of rescue assistance.

The scoping provisions in 4.1.3(9) for areas of rescue assistance do not apply to exterior facilities covered by 4.1.2. For example, parking lots and open parking garages are covered only by 4.1.2 and are not required to comply with the scoping provisions in 4.1.3(9) for areas of rescue assistance.

The technical specifications for areas of rescue assistance are discussed under 4.3.11 and provide several alternatives for design of such areas. The draft final

regulatory impact estimates the additional direct costs for creation of an area of rescue assistance in a portion of a stairway landing in a new building to be \$624. Although there are less expensive alternatives, this option was analyzed in the draft final regulatory impact analysis because it is commonly used at the current time in buildings that provide area of rescue assistance and because it represents the highest range of cost that will be incurred. Based on this estimate, the additional direct costs for providing areas of rescue assistance in stairway landings in a new low-rise office building 6 stories and 40,000 square feet per story would be \$6,240 or \$.03 per square foot of building area; and in a high-rise office building with 25 stories 30,000 square feet per story would be \$29,952 or \$.04 per square foot of building area. In many cases the cost of providing areas of rescue assistance will be much lower because such areas can be provided in elevator lobbies, office rooms, and similar space used for other purposes. No costs will be incurred in alterations or in new buildings with supervised automatic sprinkler systems because of exceptions which are included in the final guidelines as explained below. The Board believes these costs to be reasonable in light of this important life safety issue.

Comment. Several commenters requested that buildings and facilities equipped with a supervised automatic sprinkler system be exempted from the requirements for areas of rescue assistance.

Response. An exception has been added exempting buildings and facilities having a supervised automatic sprinkler from the requirements for areas of rescue assistance. Supervised automatic sprinkler systems have built in signals for monitoring features of the system such as the opening and closing of water control valves, the power supplies for needed pumps, and water tank levels, and for indicating conditions that will impair the satisfactory operation of the sprinkler system. Because of these monitoring features, supervised automatic sprinkler systems have a high level of satisfactory performance and response to fire conditions and the Board does not believe that additional measures are needed in buildings and facilities with such systems.

Comment. The American Hotel and Motel Association requested that in the case of hotels and motels on floors used exclusively for guest rooms, such rooms be permitted to serve as areas of rescue assistance because State and local

building and life safety codes require them to be fire-resistive.

Response. The organization responsible for development of the Uniform Building Code rejected this proposal on the grounds that it is inappropriate to designate a room or space that is not available to the public as an area of rescue assistance. The Board declines to accept the proposal for the same reason. In addition, there are some inconsistencies among State and local building and life safety codes regarding requirements for fire-resistive construction.

Comment. Several commenters raised questions regarding the application of the requirements for areas of rescue of assistance to alterations of existing facilities.

Response. The guidelines require areas of rescue assistance only in new construction. For the reasons discussed under 4.1.6(1)(g), a paragraph has been added to the scoping provisions for alterations to clarify that the requirements for areas of rescue assistance do not apply to alterations of existing facilities.

Drinking Fountains (4.1.3(10))

Comment. The NPRM asked whether a specific percentage of accessible drinking fountains should be required and, if so, whether at least 50% would be an appropriate number. Most persons who commented on the question stated that at least 50% was an appropriate number. Several commenters requested that the provisions address the distance between accessible drinking fountains.

Response. The Board wants to ensure that drinking fountains are accessible to wheelchair users and individuals who have difficulty bending or stooping. The final guidelines provide that where there is only one drinking fountain on a floor, there must be a drinking fountain that is accessible to wheelchair users in accordance with 4.15 and individuals who have difficulty bending or stooping. This can be accomplished by use of a "hi-lo" drinking fountain; by providing one drinking fountain accessible to wheelchair users and one drinking fountain at a standard height convenient for those who have difficulty bending or stooping; by providing a drinking fountain accessible under 4.15 and a water cooler; or by such other means as would achieve the required accessibility for each group on each floor. Where more than one drinking fountain or water cooler is provided on a floor, 50% of those provided must comply with 4.15 and be on an accessible route. In the event an odd number of drinking fountains are provided on a floor, the requirement can be met by rounding

down the odd number to an even number and calculating 50% of the even number. Additional advisory material on drinking fountains is included in the appendix at A4.1.3(10).

Toilet Rooms (4.1.3(11))

Comment. Some commenters were opposed to the scoping provision in 4.1.3(11) requiring that each public and common use toilet room be accessible.

Response. Although each common and public use toilet room must be accessible, if more than one toilet stall, lavatory, or other feature is provided in such a toilet room, generally only one of each feature is required to be accessible. See 4.22.4 through 4.22.7. Toilet rooms serving specific sleeping accommodations in dormitories, hotels, and other similar places of transient lodging are not public or common use toilet rooms.

Comment. A few commenters objected to requiring other toilet rooms to be adaptable.

Response. The scoping provision in 4.1.3(11) has been clarified that the adaptability requirement applies to toilet rooms that are designed or intended for the use of the occupant of a specific space such as a private toilet room which is part of an executive's office. Exempting such toilet rooms in new construction from the adaptability requirement would make reasonable accommodation in the future impossible in many cases.

Comment. Several commenters requested clarification whether every toilet room provided as part of a sleeping accommodation in medical care facilities and transient lodging must be accessible or adaptable.

Response. As stated in 4.1.1(1), in new construction all areas of buildings and facilities must comply with 4.1 through 4.35, unless otherwise provided in the general application section or a special application section. Medical care facilities and transient lodging are covered by special application sections 6 and 9 respectively which require that a specific percentage of sleeping accommodations, including toilet rooms, be accessible. The guidelines do not require toilet rooms in other sleeping accommodations to be accessible except that, in the case of hotels, motels and other similar places of transient lodging, doors and doorways must be designed to allow passage into the toilet room.

Comment. A few commenters recommended that an accessible unisex toilet room should be required either in addition to or in place of separate toilet rooms for men and women.

Response. Unisex toilet rooms are discussed in the technical specifications for toilet rooms in 4.22.

Storage, Shelving and Display Units (4.1.3(12))

Comment. Several commenters requested clarification regarding whether all storage, shelving and display units must be within the forward and side reach ranges for wheelchair users.

Response. The scoping provision in 4.1.3(12)(a) applies only to fixed cabinets, shelves, closets, and drawers and expressly states that additional storage space may be provided outside the forward and side reach ranges for wheelchair users. The technical specifications for reach ranges for storage spaces have also been clarified. See 4.25.3; and figures 38a and 38b.

The scoping provision in 4.1.3(12)(b) applies to fixed shelves or display units allowing self-service by customers and requires such shelves and display units be located on an accessible route. A sentence has been added to the provision to clarify that compliance with the forward and side reach ranges for wheelchair users is not required.

Comment. Businesses requested that shelves in employee work areas (e.g., stockrooms, baggage rooms, maids closets) be exempt from the scoping provision in 4.1.3(12)(a).

Response. As stated in 4.1.1(1), in new construction all areas of buildings and facilities must comply with 4.1 through 4.35, unless otherwise provided in the general application section or a special application section. Areas used only by employees as work areas are covered by 4.1.1(3) which requires that such areas be designed and constructed so that individuals with disabilities can approach, enter, and exit the areas. This provision expressly states that employee work areas are not required to be equipped with accessible shelves. The appendix includes advisory guidance at A4.1.1(3) that consideration should be given to placing shelves in employee work areas at a convenient height for accessibility or installing commercially available shelving that is adjustable so that reasonable accommodation can be made in the future.

Controls and Operating Maintenance (4.1.3(13))

Comment. Several commenters requested clarification whether controls not intended for public use must be within the forward or side reach ranges for wheelchair users.

Response. An exception has been added to the technical specifications in 4.27.3 stating that the forward and side

reach range requirements do not apply where the use of special equipment dictates otherwise or where electrical and communications systems receptacles are not normally intended for use by building occupants.

Audible and Visual Alarms (4.1.3(14))

Comment. Commenters generally supported the inclusion of visual alarms in the guidelines. Some businesses considered requiring visual alarms in new buildings and facilities to be excessive and recommended that such alarms should be provided only in areas where an individual with a hearing impairment was an occupant or that portable or personal alarm devices should be permitted. A few commenters requested that buildings with automatic sprinkler systems be exempt from the requirement for visual alarms.

Response. Builders and designers cannot know in advance whether a space will be occupied by a person with a hearing impairment. If visual alarms are not included in the design of new buildings and facilities but instead are required only where an individual with a hearing impairment was an occupant, buildings and facilities would have to be retrofitted at potentially greater cost.

Further, visual alarms are intended to alert visitors, and not just regular tenants, to emergencies. Portable or personal alarm devices are carried by an individual and are triggered by a signal from the building emergency alarm system. Provision of these devices is not an acceptable alternative, especially in places of public accommodation such as retail stores, assembly areas, and transportation facilities where the number of visitors and temporary users greatly exceeds the number of tenants. They have been demonstrably ineffective in both drill and emergency situations in such places and have resulted in visitors being left unaware of the need for evacuation. The only situation where portable or personal alarm devices are permitted under the guidelines is in sleeping accommodations in hotels and other similar places of transient lodging where guests are assigned temporarily to a specific room and can be provided appropriate devices when registering for the room. See 9.3.2. Even then, hallways, lobbies and other common areas in hotels and other similar places of transient lodging must have permanently installed visual alarms.

As for buildings with automatic sprinkler systems, visual alarms are generally required only where audible alarms are required or provided. Since buildings with automatic sprinkler systems are required to provide audible

alarms, the Board believes that persons with hearing impairments are entitled to access the same emergency warning system.

The draft final regulatory impact analysis estimates the direct additional cost per visual alarm device in new construction, including installation, to be \$169. A high-rise office building with 25 stories and 30,000 square feet per story is estimated to require 160 devices for a total cost of \$27,040 or \$.04 per square foot of building area. The Board believes that this cost is reasonable in light of the importance of this life safety issue.

Detectable Warnings (4.1.3(15))

A large number of comments was received in support of and in opposition to detectable warnings in general and at specific locations. As further discussed under 4.29, the requirements for detectable warnings have been revised and some sections have been reserved pending further study and research for future revisions to the guidelines. An editorial change has been made to 4.1.3(15) stating that detectable warnings shall be provided at locations specified in 4.29.

Interior Signage (4.1.3(16))

Comment. As discussed under 4.1.2(7), the Board has concluded based on review of the comments that the scoping provisions and technical specifications for signage were unclear and needed to be revised.

Response. The scoping provisions for interior and exterior signage and the accompanying technical specifications have been clarified and revised in response to the comments. See 4.1.2(7) for scoping provisions for exterior signage; and 4.30 for technical specifications for signage. Interior signs which designate permanent rooms and spaces must comply with the technical specifications in 4.30.1 and 4.30.4 through 4.30.6 for raised and brailled characters, finish and contrast, and mounting locations and height. For instance, numbers on hotel guest rooms, patient rooms in hospitals, office suites, and signs designating men's and women's toilet facilities must have raised and brailled characters, and also must meet the finish and contrast, and mounting height requirements. Interior signs which provide direction to or information about functional spaces of a building or facility must comply with the technical specifications in 4.30.1, 4.30.2 and 4.30.5 for character proportion and finish and contrast. The technical specifications in 4.30.3 for character height must also be complied with if the

signage is suspended or projected overhead in compliance with the technical specifications in 4.4.2 for head room for protruding objects.

An exception has also been added to 4.1.3(16) to clarify that building directories, menus, and other signs which provide temporary information about rooms and spaces such as the current occupant's name do not have to comply with the requirements for signage.

Comment. The NPRM asked whether additional types of signage such as informational and directional signage about functional spaces, rules of conduct, or hazards should be tactile (i.e., comply with technical specifications in 4.30.4 and 4.30.6 for raised and braille characters and mounting location and height). The NPRM also requested information on available technologies such as audible signs for overhead and remote signage. Comments from individuals with disabilities and their organizations regarding additional types of signage that should be tactile were scattered with no clear consensus of opinion that would be useful for purposes of establishing guidelines. Technical information was submitted by Love Electronics regarding infrared signage.

Response. Although technology is available for making overhead and remote signage accessible, the Board plans to further study this issue to determine where and in what types of buildings and facilities such technology may be necessary for future revision of the guidelines.

Accessible Public Telephones (4.1.17(a))

Comment. Individuals with disabilities and their organizations requested that more accessible telephones be required. One commenter recommended that a maximum distance of 300 feet be established between accessible public telephones in large buildings and facilities. A telephone company objected to requiring at least one public telephone per floor to meet the technical specifications in 4.31.2 for forward reach by wheelchair users when two or more banks of telephones are provided on each floor. One commenter recommended that the exception under 4.1.3(17)(a) for exterior public telephones should permit a side reach telephone instead of a forward reach telephone if dial tone first service is available.

Response. The exception under 4.1.3(17)(a) has been revised as recommended. It has also been clarified that accessible public telephones required by 4.1.3(17)(a) do not include

text telephones which are covered by 4.1.3(17)(c).

Public Telephones Equipped With Volume Controls (4.1.3(17)(b))

Comment. Most individuals with disabilities and their organizations supported the NPRM proposal to require 25% of public telephones in newly constructed buildings and facilities to be equipped with a volume control in addition to the requirement in 4.1.3(17)(a) for accessible public telephones. A few requested that the number be increased. Some recommended that scoping be based on occupancy. Telephone companies responded that they have adopted voluntary programs to install public telephones equipped with volume controls and recommended that the Board defer to a Federal Communication Commission (FCC) proceeding which declined to require 25% of all public telephones to be equipped with volume controls. See Order Completing Inquiry and Providing Further Notice of Proposed Rulemaking, CC Docket No. 87-124 (July 27, 1989).

Response. The FCC declined to require 25% of all public telephones to be equipped with volume controls based on cost estimates provided by telephone companies for retrofitting all existing public telephones with a volume control. The NPRM proposal was more modest and only required 25% of public telephones installed in newly constructed buildings and facilities to be accessible. The American Telephone and Telegraph Company reported that its newly designed public telephones incorporate volume controls as a standard feature. Southwestern Bell Telephone Company also reported that it installs volume controls in its public telephones free upon the request of its customers. Cost data provided by other telephone companies for equipping public telephones with volume controls ranged from \$10 to \$80. Since the additional direct cost of requiring 25% of public telephones in newly constructed buildings and facilities is nothing to minimal depending on the telephone manufacturer or company, the requirement has been retained in the final guidelines.

Comment. The American Public Communication Council requested that the requirement be postponed for one year to permit suppliers to test and evaluate equipment.

Response. The American Telephone and Telegraph Company and other telephone companies currently offer public telephones equipped with volume controls as a standard feature or upon request. In addition, many telephone

companies incorporate the volume control feature into the base of the telephone rather than the handset which has virtually eliminated concerns about vandalism. The Board does not believe that any delay is warranted beyond the January 26, 1992 effective date for title III of the ADA.

Public Text Telephones (4.1.3(17)(c)-(d))

Comment. The NPRM asked whether the scoping provision for public text telephones should be based on the total number of public pay telephones in a building or facility and whether six public pay telephones should be the trigger point. As an alternative, the NPRM asked whether the scoping provision should be based on occupancy type as is done in Michigan. The NPRM also asked for information about the need for public text telephones in general and at specific types of facilities. Most individuals with disabilities and their organizations and other commenters who responded to the questions recommended basing the scoping provision on occupancy type in addition to the total number of public pay telephones in a building or facility and generally supported the need for public text telephones in the same occupancy types as required in Michigan (e.g., transportation facilities, hospitals, shopping malls, convention centers, hotels with a convention center). Many of these commenters expressed concern that smaller or rural communities may have buildings and facilities where there is a need for public text telephones regardless of the number of public pay telephones. As for the trigger point for a scoping provision based on total number of public pay telephones, many individuals with disabilities and their organizations and other commenters recommended that the trigger point be less than six public pay telephones and offered a variety of percentage, bank, and cluster options. Businesses and telephone companies were generally opposed to public text telephones and expressed concerns about cost, utilization, and maintenance. One telephone company stated that the presence of six public telephones would indicate a high volume of traffic and suggests a potential for cost recovery. Other telephone companies referred to a Federal Communications Commission proceeding to gather information concerning the telecommunication needs of individuals with hearing impairments which concluded that "requiring that pay telephones be designed to accommodate portable TDDs, however, should be less costly, and may well provide benefits that outweigh the

costs." Order Completing Inquiry and Providing Further Notice of Proposed Rulemaking, CC Docket No. 87-124 (July 27, 1989) at paragraph 110.

Response. A number of changes have been made to the scoping provision for public text telephones in response to the comments. The final guidelines include requirements based on (1) the total number of interior and exterior public pay telephones provided at a site and (2) certain occupancy types, regardless of the number of public pay telephones provided at the site. The trigger point has been set at four or more interior and exterior public pay telephones at a site where at least one is in an interior location. For instance, if a building or facility has two exterior and two interior public pay telephones on the site, the scoping provisions for a public text telephone is triggered. On the other hand, if all public pay telephones are located outdoors, a public text telephone is not required because text telephones do not currently work well outdoors and the use of portable text telephones at such locations is impractical.

The final guidelines further provide that if an interior public pay telephone is provided in a stadium or arena, a convention center, a hotel with a convention center, or a covered mall, at least one interior public text telephone must be provided in the facility. In the case of hospitals, if a public pay telephone is located in or adjacent to an emergency room, recovery room, or waiting room, one public text telephone must be provided at each such location.

The scoping provision for public text telephones in transportation facilities will be included in section 10 of the final guidelines. The Board will also incorporate a scoping provision for public text telephones in State and local government buildings when the guidelines are supplemented for purposes of title II of the ADA.

The final guidelines also include new technical specifications for public text telephones at 4.31.9 and additional explanatory information in the appendix at A4.31.9. The technical specifications permit the use of either an integrated text telephone and pay telephone unit, or a conventional text telephone that is permanently affixed within, or adjacent to, the telephone enclosure. In addition, the technical specifications permit the use of portable text telephones as equivalent facilitation under certain conditions. At the present time, pocket-type text telephones do not accommodate a wide range of individuals with disabilities and are not considered appropriate for purposes of equivalent facilitation. As technology develops, this may change. To be

considered equivalent facilitation, the portable text telephone must be readily available for use with nearby public pay telephones. For example, if a hotel has portable text telephones available at the registration desk on a 24 hour basis for use with nearby public pay telephones, substantially equivalent access to and usability of the public pay telephone would be provided. On the other hand, if the portable text telephone is kept at a remote location from the public pay telephones or is stored in a space near the public pay telephones but the user must search for personnel not regularly stationed near the public pay telephones, substantially equivalent access to and use of the public pay telephone would not be provided. If a portable text telephone is provided as equivalent facilitation, at least one nearby public pay telephone must be equipped with a shelf and an electrical outlet to accommodate the portable text telephone. The technical specifications for the shelf are in 4.31.9(2). If an acoustic coupler is used, the telephone handset cord must be long enough to connect the public pay phone with the text telephone. Regardless of whether the public text telephone is portable or permanently affixed, the technical specifications for signage in 4.30.7(3) require that directional signage indicating the location of the nearest public text telephone must be provided near all banks of telephones which do not contain a text telephone. If a building or facility has no banks of telephones, the directional signage must be provided at the entrance (e.g., in a building directory).

Comment. Several commenters recommended that, in addition to requiring at least one public text telephone in certain buildings and facilities, public pay telephones should be designed to accommodate portable text telephones so that individuals who carry their own devices can use public pay telephones, especially in larger facilities where one may have to walk a considerable distance to find a public text telephone.

Response. A new scoping provision has been added at 4.1.3(17)(d) requiring at least one public pay telephone in each bank of three or more interior public pay telephones to be designed to accommodate a portable text telephone. The public pay telephone must comply with the technical specifications in 4.31.9(2), and be equipped with a shelf on which to place a portable text telephone, an electrical outlet, and a telephone handset cord long enough to reach the shelf for acoustical coupling. Some telephone enclosure companies currently have several models on the

market which comply with these requirements.

Fixed Seating and Tables (4.1.3(18))

Comment. The NPRM asked whether the five percent scoping provision for fixed seating and tables was adequate. Many commenters interpreted the provision as applying to seating in assembly areas or restaurants and stated that the number was too low. Some commenters stated that similar scoping provisions in their states were adequate.

Response. Wheelchair seating spaces in assembly areas and restaurants are addressed in separate provisions. See 4.1.3(19)(a) for assembly areas; and 5.1 for restaurants. The five percent figure has not been changed. Several editorial changes have been made to the provision to be consistent with 4.1.1(3) regarding areas used only by employees as work areas. The term "accessible public or common use areas" has been substituted for "accessible spaces" and the reference to "work surfaces" has been deleted. As clarified, the provision applies to fixed seating and tables in accessible public and common use areas such as study carrels or laboratory stations in a classroom.

Wheelchair Seating Spaces in Assembly Areas (4.1.3(19)(a))

Comment. Individuals with disabilities and their organizations and other commenters recommended that the scoping provisions for wheelchair seating spaces in assembly areas include such spaces for areas with less than 50 seats and generally favored an increase in the number of wheelchair seating spaces. Several commenters, including theater owners, believed that the requirements for wheelchair seating spaces in assembly areas were excessive.

Response. The table in 4.1.3(19)(a) specifying the number of wheelchair seating spaces in assembly areas has been revised in response to the comments. The new scoping provision is generally taken from the California building code. In smaller assembly areas, one wheelchair seating space is required in areas having a seating capacity of 4 to 25, and two wheelchair seating spaces are required in areas having a seating capacity of 26 to 50. The NPRM required no accessible seating in assembly areas with fewer than 50 seats. Unlike the NPRM, the new scoping provision also requires that one percent, but not less than one, of all fixed seats be aisle seats that have either no armrests, or removable or folding armrests on the aisle side of the

seat to increase accessibility for wheelchair users who wish to transfer to a fixed seat and individuals with other mobility impairments for whom armrests present an obstacle. These seats must be identified by a sign or marker and a sign must be posted in the ticket office notifying patrons of their availability.

The total number of seating spaces for individuals with mobility impairments is generally the same under the NPRM and the final guidelines. For instance, in an assembly area with a seating capacity of 200, the NPRM required 6 wheelchair seating spaces; and the final guidelines require 4 wheelchair seating spaces and 2 accessible aisle seats. In an assembly area with a seating capacity of 1,000, the NPRM required 20 wheelchair seating spaces; and the final guidelines require 11 wheelchair seating spaces and 10 accessible aisle seats. To address the concerns regarding the number of wheelchair seating spaces required in larger facilities, a paragraph has been added to the appendix explaining that readily removable or folding seating units may be installed in wheelchair seating spaces which may be used by other persons when not needed for wheelchair users or individuals with other mobility impairments. Folding seating units usually consists of two fixed seats that can be easily folded into a fixed center bar to allow for open spaces for wheelchair users when needed.

Assistive Listening Systems (4.1.3(19)(b))

Comment. The NPRM asked whether certain assembly areas with fixed seating should be required to have permanently installed assistive listening systems, and whether other areas should be permitted to have an adequate number of electrical outlets or other supplementary wiring to accommodate portable assistive listening systems. Most commenters who responded to the question favored requiring permanently installed assistive listening systems in assembly areas with fixed seating and permitting the use of portable systems in other areas. For instance, hotels pointed out that larger meeting rooms are frequently subdivided into smaller meeting rooms and a permanently installed assistive listening system may not be usable in such spaces. Some commenters recommended that all assistive listening systems should be portable.

Response. The scoping provision for assistive listening systems has been revised. The provision applies to concert and lecture halls, playhouses and movie theaters, meeting rooms, and other assembly areas where audible

communication is integral to use of the space. If such an assembly area (a) accommodates at least 50 persons or has an audioamplification system and (b) has fixed seating, a permanently installed assistive listening system is required. Other assembly areas are permitted to have an adequate number of electrical outlets or other supplementary wiring to accommodate portable assistive listening systems. The requirement assures that individuals with hearing impairments can attend functions in assembly areas with fixed seating without having to give advance notice or disrupt the event to have a portable assistive listening system set up. The requirement also provides for flexibility for smaller assembly areas and rooms and spaces with changeable seating arrangements.

The provision in the NPRM which would have required assistive listening systems to be installed in rooms if they are used regularly as meeting or conference rooms was deleted because it would have covered individual offices which are used for meetings which was not intended.

Comment. Several commenters requested that the scoping provision not be limited to indoor assembly areas and include such facilities as baseball stadiums.

Response. The baseball stadium in Boston has a permanently installed assistive listening system. Since the technology currently exists for providing communication access to such facilities, the scoping provision is not limited to indoor assembly areas.

Comment. Most commenters supported requiring that the minimum number of receivers be equal to four percent of the total number of seats but not less than two. Some commenters believed that the number was excessive and other commenters wanted the number to be increased.

Response. The four percent figure is based on a Bureau of the Census estimate of the number of persons aged 15 and over who have difficulty hearing what is said in a normal conversation with another person, excluding those who cannot hear at all. See Bureau of Census, Disability Functional Limitation and Insurance Coverage, 1984-85. There are other studies which indicate that the numbers may be as high as eight to ten percent. As assistive listening systems become more readily available, it is expected that their usage will increase. The Board intends to monitor this issue and if a need for an increase in the number of receivers is demonstrated, the scoping provision will be revised.

Comment. The NPRM requested information regarding which types of assistive listening systems (induction loop, FM, and infra red) work best in particular environments. Each of the three types of systems received some support for all applications. Many commenters described their personal experiences with particular types of systems. Those who provided extensive information on the advantages and disadvantages of the various systems recommended that a specific type should be selected only after consultation with experts in the field.

Response. The appendix in A4.33.6 has been expanded to provide additional information on the various types of assistive listening systems. The appendix includes a table reprinted from a National Institute of Disability and Rehabilitation Research "Rehab Brief" which shows some of the advantages and disadvantages of each system and typical applications. New York has also adopted technical specifications which may be useful. A pamphlet is available from the Board which lists demonstration centers across the country where technical assistance can be obtained in selecting and installing appropriate systems.

Comment. The NPRM also requested information regarding the need for an assistive listening device at sales and service counters, teller windows, box offices, and information kiosks where a physical barrier separates service personnel and customers. Most commenters favored the provision of an assistive listening device at these places. Those who were opposed to this provision recommended alternative means to address the problem such as training personnel how to communicate effectively with individuals who have hearing impairments.

Response. A provision has been added to the appendix at A7.2(3) recommending that at least one permanently installed assistive listening system be installed at sales and service counters, teller windows, box offices, and information kiosks where a physical barrier separates service personnel and customers.

Automated Teller Machines (4.1.3 (20))

The legislative history of the ADA specifically mentions automatic teller machines (ATMs) as covered by the accessibility requirements. The NPRM included proposed scoping provisions and technical specifications for ATMs. The scoping provisions in the final guidelines have been revised and require that where ATMs are provided, each machine shall comply with 4.34

except where two or more machines are provided at one location, then only one machine shall comply with 4.34. For example, if a large shopping mall has an ATM located at each end of the mall, then each ATM must be accessible. On the other hand, if the ATMs are located adjacent to each other, then only one ATM must be accessible. Comments regarding ATMs and the requirements of the final guidelines are discussed under the technical specifications at 4.34.

Dressing and Fitting Rooms (4.1.3(21))

Comment. The NPRM asked whether the guidelines should include requirements for accessible dressing and fitting rooms. Individuals with disabilities and their organizations supported such requirements. Businesses expressed concern about having sufficient space for accessible dressing and fitting rooms, especially in existing buildings and facilities.

Response. A new scoping provision has been added at 4.1.3(21) for new construction requiring that where dressing and fitting rooms are provided for use by the public or employees, 5 percent, but not less than one, of such rooms for each type of use in each cluster of dressing rooms must be accessible. For instance, in a hospital where dressing rooms are provided for specific treatment or examination rooms, 5 percent, but not less than one, of the dressing rooms provided for each type of treatment or examination rooms must be accessible.

The Board recognizes that in some cases it may be technically infeasible to comply with the scoping provisions for new construction when altering dressing rooms in existing facilities due to space limitations and has included a provision in 4.1.6(3)(h) that requires only one dressing room for each sex on each level to be accessible in alterations where technical infeasibility can be demonstrated. Accessible unisex dressing rooms may be used to meet the requirement in 4.1.6(3)(h) where only unisex dressing rooms are provided.

Technical specifications for accessible dressing rooms are provided in 4.35.

4.1.5 Accessible Buildings: Additions

This section contains the scoping provisions for additions to existing buildings and facilities.

Comment. Several commenters raised questions regarding whether an addition to an existing building is to be treated as new construction or an alteration.

Response. Additions to existing buildings have attributes of both new construction and an alteration. To the extent that a space or element in the addition is newly constructed, each new

space or element must comply with the applicable scoping provisions of 4.1.1 to 4.1.3 for new construction, the applicable technical specifications of 4.2 through 4.35, and the applicable special application sections 5 through 10. For instance, if a restroom is provided in the addition, it must comply with the requirements for new construction. Construction of an addition does not, however, create an obligation to retrofit the entire existing building or facility to meet requirements for new construction. Rather, the addition is to be regarded as an alteration and to the extent that it affects or could affect the usability of or access to an area containing a primary function, the requirements in 4.1.6(2) are triggered with respect to providing an accessible path of travel to the altered area and making the restrooms, telephones, and drinking fountains serving the altered area accessible. For example, if a museum adds a new wing that does not have a separate entrance as part of the addition, an accessible path of travel would have to be provided through the existing building or facility unless it is disproportionate to the overall cost and scope of the addition as determined under criteria established by the Attorney General. The scoping provision in 4.1.5 has been clarified to reflect these requirements.

4.1.6 Accessible Buildings: Alterations

This section contains scoping provisions for alterations.

General (4.1.6(1))

Comment. Some commenters pointed out that the provision in 4.1.6(1)(a) prohibiting any decrease in accessibility when an alteration is undertaken was inconsistent with the provision in 4.1.6(1)(d) [4.1.6(1)(e) in the NPRM] which does not impose any greater requirements in alterations than in new construction.

Response. The provision has been revised to state that no alteration shall be undertaken which decreases or has the affect of decreasing accessibility or usability of a building or facility below the requirements for new construction at the time of the alteration.

Comment. Several businesses expressed concern about minor alterations triggering extensive retrofitting of existing buildings and facilities to meet the requirements for new construction.

Response. The Board wishes to make it clear that minor alterations do not trigger extensive retrofitting of existing buildings. There are three general principles for alterations. First, if any existing element, space, or common area is altered, the altered element, space, or

common area must meet new construction requirements. 4.1.6(1)(b). Second, if alterations to the elements in a space when considered together amount to an alteration of the space, the entire space must meet new construction requirements. 4.1.6(1)(c). Third, if the alteration affects or could affect the usability of or access to an area containing a primary function, the path of travel to the altered area and the restrooms, drinking fountains, and telephones serving the altered area must be made accessible unless it is disproportionate to the overall alterations in terms of cost and scope as determined under criteria established by the Attorney General. 4.1.6(2). This last requirement will be addressed in greater detail in the Department of Justice's final regulations.

There are two general exceptions that apply to alterations. First, compliance with a specific scoping provision or technical specification is not required if it is technically infeasible. 4.1.6(1)(j). As further discussed below, the definition of the term "technically infeasible" has been revised and does not require compliance with new construction requirements where existing structural conditions would require removing or altering a load-bearing member which is an essential part of the structural frame or where existing physical or site constraints prohibit full and strict compliance. Second, the installation of an elevator is not required in an altered building or facility that is less than three stories or has less than 3,000 square feet per story unless the building is a shopping center, a shopping mall, the professional office of a health care provider, or another type of facility determined by the Attorney General. 4.1.6(1)(k). The elevator exception is established by section 303(b) of the ADA and is the same as that contained in the scoping provisions for new construction. As discussed above, if a building or facility is not exempt from the elevator requirement and the requirement for an accessible path of travel is triggered under 4.1.6(2), the installation of an elevator is subject to the disproportionality limitation. However, if an escalator or stair is planned or installed where none existed previously and major structural modifications are necessary for such installation, then an elevator or other vertical means of access must be provided. 4.1.6(1)(f).

The following examples illustrate the application of these principles and exceptions:

1. If a door handle is replaced, the new door handle must comply with

4.13.9 which states that door hardware shall have a shape that is easy to grasp and does not require tight grasping, tight pinching, or turning of the wrist (e.g., lever handles, U-shaped handles). Replacing the door handle does not trigger any other accessibility requirements for the door.

2. A common practice when replacing doors is to install a complete door assembly consisting of the frame and a pre-hung door. In interior light-frame construction (e.g., wood or metal studs), a wider door assembly can be installed without altering a load-bearing structural member which is an essential part of the structural frame. If a complete door assembly is installed in interior light-frame construction and space is available to comply with the clear width and maneuvering clearances specified in 4.13.5 and 4.13.6, those requirements must be met. However, if space is restricted, as in the case of some hotel guest rooms where narrow doorways are defined by bathroom and closet walls, it may be technically infeasible to comply with the clear width or maneuvering clearances specified in 4.13.5 and 4.13.6 due to existing physical constraints.

3. If a parking lot is resurfaced and does not have the number of accessible parking spaces required by 4.1.2(5) or the parking spaces do not comply with 4.6.3, those requirements must be met with unless it is technically infeasible. If the resurfacing does not include regrading, it may be technically infeasible to comply with the requirement in 4.6.3 that accessible parking spaces and access aisles be level with surface slopes not exceeding 1:50 (2%) in all directions due to existing site constraints. If a local zoning or land use code requires the parking lot to have a certain number of parking spaces and providing the number of accessible parking spaces in 4.1.2(5) would result in reducing the total number of parking spaces below that required by the local code, it would be technically infeasible to fully comply with the scoping provision due to site constraints resulting from legitimate requirements of the local code. For instance, if 4.1.2(5) requires five accessible parking spaces to be provided, but the parking lot can only accommodate four accessible parking spaces and still meet the local code requirement for total number of parking spaces, then four accessible parking spaces must be provided.

4. If the water closets, toilet stalls, lavatories and mirrors in a toilet room are all replaced, the new fixtures must comply with the technical specifications in 4.16, 4.17, and 4.19 for those elements.

Since replacing the water closets, toilet stalls, lavatories and mirrors also amounts to an alteration of the toilet room, the entire toilet room must comply with the technical specifications in 4.22 for toilet rooms which include a requirement for the doors to the toilet room to comply with 4.13.

The Board has added provisions to the final guidelines to clarify when accessible routes and accessible entrances are required in alterations to existing buildings and facilities. A provision has been added at 4.1.6(1)(b) that, if the requirements for new construction provide for an element, space, or common area to be on an accessible route, alteration of the element, space, or common area does not trigger the requirement for an accessible route unless the alteration affects the usability of or access to an area containing a primary function in which case an accessible path of travel is required by 4.1.6(2) subject to the disproportionality limitation. For instance, in new construction the scoping provision in 4.1.3(10) requires that drinking fountains be on an accessible route. If a drinking fountain is replaced on the third story of a building that does not have an elevator, installation of a new accessible drinking fountain does not trigger the installation of an elevator.

A provision has also been added to the final guidelines at 4.1.6(1)(h) that, if a planned alteration entails alterations to an entrance, and the building has an accessible entrance, the entrance being altered is not required to comply with the new construction requirements unless the alteration affects the usability of or access to an area containing a primary function in which case an accessible path of travel is required by 4.1.6(2) subject to the disproportionality limitation. If an entrance is altered and is not made accessible, appropriate signage must be provided indicating the location of the nearest accessible entrance. Additional advisory material on alterations to entrances is included in the appendix at A4.1.6(2)(h).

Comment. A few commenters requested that a waiver process be established.

Response. The ADA does not provide for a waiver process. The technical infeasibility and elevator exceptions in 4.1.6(1) (i) and (j) are similar to a waiver in that compliance with specific scoping provisions and technical specifications is not required if certain conditions are met. Special scoping provisions and technical specifications are provided for in the case of some elements and spaces where technical infeasibility exists. See

4.1.6(3). However, the exceptions differ from a waiver in that to obtain a waiver an entity must usually submit documentation to a reviewing authority showing that conditions exist to warrant not complying with a specific scoping provision or technical specification and the reviewing authority must decide whether to grant or deny the waiver. The ADA only provides for review after the fact if a complaint is filed with the Department of Justice or a court. Entities should maintain documentation of conditions warranting an exemption in the event of such review.

Comment. Several commenters questioned why altered elements and spaces must be made accessible if the rest of the building or facility is inaccessible.

Response. Congress recognized that it would be costly to retrofit entire buildings and facilities to be accessible and that it would be more cost effective to incorporate accessibility gradually as elements and spaces are altered. See H. Rept. 101-485, pt. 3, at 60. The scoping provisions are based on the statute and ensure that individuals with disabilities will have access to the goods, services, and employment available in the altered parts of buildings and facilities.

Comment. Several commenters requested that the guidelines specifically address when public text telephones are required in existing buildings and facilities.

If alterations to existing buildings or facilities with less than four interior or exterior public pay telephones would increase the number to four or more public pay telephones with at least one in an interior location, then at least one interior public text telephone must be provided. For instance, if an existing building or facility has one interior and one exterior public pay telephone and two more are added, then at least one interior public text telephone would be required. If one or more interior or exterior public pay telephones in an existing facility with four or more public pay telephones with at least one in an interior location is altered, then at least one interior public text telephone must be provided. For instance, if an existing building or facility has two interior and two exterior public pay telephones and one or more of them is replaced, then at least one interior public text telephone would be required.

Comment. Several commenters requested that areas of rescue assistance not be required in existing buildings and facilities because it would require costly and extensive renovations.

Response. The Board recognizes that providing areas of rescue assistance in existing buildings may require costly and extensive renovations. Pending further study, a provision has been added in 4.1.6(1)(g) stating that the requirements in 4.1.6(9), 4.3.10, and 4.3.11 regarding areas of rescue assistance do not apply to alterations of existing buildings.

Comment. Several commenters requested that hazardous materials abatement and automatic sprinkling retrofitting be added to the list of alterations in 4.1.6(1)(i) (4.1.6(1)(f) in the NPRM) exempt from guidelines.

Response. Alterations which are limited solely to hazardous materials abatement and automatic sprinkling retrofitting and which do not involve changes to any elements or spaces required to be accessible by the guidelines have been added to the list of alterations in 4.1.6(1)(i) exempt from the guidelines.

Comment. A number of commenters requested changes in the definition of the term "technically infeasible." Some commenters requested that in the case of alterations that would require removing or altering a load-bearing member, a distinction should be made between: (a) wood and metal studs or joists used in light-frame construction of interior walls and floors; and (b) concrete, masonry, heavy timber or steel columns, beams, girders and structural slabs. Other commenters requested that a cost factor be included in the definition of "technically infeasible."

Response. The definition of "technically infeasible" has been moved from the definitions in 3.5 to 4.1.6(1)(i). With respect to alterations that would require removing or altering a load-bearing member, the definition has been revised to apply to a load-bearing member which is an essential part of the structural frame. The structural frame is defined in 3.5 as consisting of the columns and the girders, beams, trusses and spandrels having direct connections to the columns, and all other members which are essential to the stability of the building as a whole. This definition would not include wood or metal studs or joists used in light-frame construction of interior walls and floors. With respect to existing physical or site constraints prohibiting full and strict compliance, such constraints can result from legitimate legal requirements (e.g., a right of way agreement preventing construction of a ramp in front of a building).

As for costs, that factor has been taken into account in several places in the scoping provisions for alterations. First, as further discussed above where

requirements for an accessible path of travel, including vertical access by means of an elevator, ramp, or platform lift or wheelchair lift, are triggered by an alteration that affects access to or usability of an area containing a primary function, there is a disproportionality limitation which will be addressed in the Department of Justice's final regulations. See 4.1.6(2). Second, the technical infeasibility exception is designed to limit costs by not requiring the removal or alteration of a load-bearing member which is an essential part of the structural frame and not requiring compliance with new construction requirements where there are existing physical or site constraints. Third, where commenters have pointed out specific new construction requirements which would require costly and extensive renovations to existing buildings and facilities such as those for areas of rescue assistance, the Board has not required them. See 4.1.6(1)(g). Fourth, the installation of elevators is not required in alterations of existing buildings and facilities which are less than three stories or have less than 3,000 square feet per story except for certain types of facilities. See 4.1.6(1)(k).

4.1.6(2) Alterations To An Area Containing A Primary Function

Comment. A number of commenters requested that the terms "an area containing a primary function;" "path of travel;" and "disproportionate" be defined.

Response. The Department of Justice's final regulations will define and apply these terms.

4.1.6(3) Special Technical Provisions For Alterations

Comment. A few commenters requested that the application of the special provisions in 4.1.6(3) be clarified. Some commenters objected to allowing a short ramp to be steeper and elevators to have a 48 inch by 48 inch inside car dimension. Other commenters made recommendations for elevator car sizes and alternative provisions that require further study or will be discussed in the technical assistance manual.

Response. The special provisions in 4.1.6(3) contain requirements for ramps, stairs, elevators, doors, toilet facilities, assembly areas, and dressing and fitting rooms that may be used in alterations to existing buildings and facilities when it is technically infeasible to comply with new construction requirements or other specified conditions exist. The Board recognizes that the special provisions for ramps and elevators do not accommodate as many individuals with

disabilities as do the technical specifications in 4.7.2, 4.8.2, and 4.10.9. However, faced with the choice between providing no access or a lesser degree of access to existing buildings and facilities that are altered, the Board has opted for the latter. As noted above, other recommendations have been made for elevator car sizes and alternative provisions that will be studied for future revision of the guidelines or will be discussed in the technical assistance manual.

A new provision has been added at 4.1.6(3)(g) that platform lifts or wheelchair lifts complying with 4.11 and applicable State and local codes are allowed as part of an accessible route in alterations and that the use of lifts is not limited to the conditions specified in the scoping provisions for new construction.

4.1.7 Accessible Buildings: Historic Preservation

This section contains scoping provisions and alternative requirements for alterations to qualified historic buildings and facilities.

Comment: A number of commenters requested that the Board clarify the application of 4.1.7(1) and the procedures under section 106 of the National Historic Preservation Act.

Response: The provision has been revised to clarify that alterations to a qualified historic building or facility shall comply with the scoping provisions for alterations (4.1.6), the applicable technical specifications (4.2 through 4.35), and the applicable special application sections (5 through 10) unless it is determined in accordance with the procedures discussed below that compliance with the requirements for accessible routes (exterior and interior), ramps, entrances, or toilets would threaten or destroy the historic significance of the building or facility in which case the alternative requirements in 4.1.7(3) (4.1.7(2) in the NPRM) may be used. The alternative requirements allow for flexibility to accommodate the national interest in historic preservation.

The definition of a "qualified historic building or facility" has been moved to 4.1.7(1)(b) and retains the UFAS definition as required by section 504(c)(1) of the ADA.

New paragraphs have been added at 4.1.7(2)(a)(i) and (ii) to clarify the procedures under section 106 of the National Historic Preservation Act (16 U.S.C. 470f) and their application to alterations covered by the ADA. Section 106 requires that a Federal agency with jurisdiction over a Federal, federally assisted, or federally licensed undertaking consider the effects of the

agency's undertaking on buildings and facilities listed in or eligible for listing in the National Register of Historic Places and give the Advisory Council on Historic Preservation a reasonable opportunity to comment on the undertaking prior to approval of the undertaking. The Advisory Council on Historic Preservation has established a process to implement section 106. See 36 CFR part 800. The section 106 process provides for the Federal agency to consult with the State Historic Preservation Officer established under section 101(b) of the National Historic Preservation Act (16 U.S.C. 470a(b)) whose responsibilities include cooperating with Federal and State agencies, local governments, and organizations and individuals to ensure that historic properties are taken into consideration at all levels of planning and development. The section 106 process encourages the Federal agency and State Historic Preservation Officer to agree on alternatives to avoid or minimize adverse effects on buildings and facilities listed in or eligible for listing in the National Register of Historic Places. The section 106 process does not apply to buildings and facilities that are designated as historic under an appropriate State or local law but are not listed in or eligible for listing in the National Register of Historic Places. For example, the section 106 process applies if the National Park Service leases a federally owned building listed in the National Register of Historic Places to a private entity with permission to renovate the building for use as a bed and breakfast inn or if the Small Business Administration loans funds to a private entity to renovate a building eligible for listing in the National Register of Historic Places for use as a restaurant. Where alterations are undertaken to a qualified historic building or facility that is subject to section 106 of the National Historic Preservation Act, the Federal agency with jurisdiction over the undertaking is responsible for following the section 106 process. If the State Historic Preservation Officer or Advisory Council on Historic Preservation agrees that compliance with the requirements for accessible routes (exterior and interior), ramps, entrances, or toilets would threaten or destroy the historic significance of the building or facility, the alternative requirements may be used.

Comment: Section 504(c)(3) of the ADA requires the Board to establish procedures for determining whether the alternative requirements may be used for qualified historic buildings and

facilities that are not subject to section 106 of the National Historic Preservation Act. The NPRM requested information on what procedures should be followed. The National Park Service, Advisory Council on Historic Preservation, National Conference of State Historic Preservation Officers, and other commenters responsible for historic preservation programs recommended that an entity undertaking alterations to a qualified historic building or facility should consult with the State Historic Preservation Officer whenever the entity believes that compliance with the accessibility requirements would threaten or destroy the historical significance of the building or facility and that the alternative requirements should be used. Individuals with disabilities and their organizations requested that criteria be established for determining whether compliance with the accessibility requirements would threaten or destroy the historical significance of a building or facility and that State and local accessibility officials and organizations representing individuals with disabilities should be involved in the consultation process.

Response: The State Historic Preservation Officer is a key public official in the Federal-State partnership envisioned under the National Historic Preservation Act. Every State currently has a State Historic Preservation Officer approved by the Secretary of the Interior whose responsibilities include advising and assisting Federal and State agencies and local governments in carrying out their historic preservation responsibilities; cooperating with organizations and individuals to ensure that historic properties are taken into consideration at all levels of planning and development; and providing technical assistance relating to Federal and State historic preservation programs. See 16 U.S.C. 470a(b)(3)(E) through (F). The State Historic Preservation Officer is required to have a full-time professional staff in each of the following disciplines: history, archeology, and architectural history. See 36 CFR 61.4(d).

The Board believes that it is consistent with the State Historic Preservation Officer's existing responsibilities under the National Historic Preservation Act to provide for that official to be consulted with whenever an entity undertakes alterations to a qualified historic building or facility that is not subject to the section 106 process and the entity believes that compliance with the accessibility requirements would threaten or destroy the historical

significance of the building or facility and that the alternative requirements should be used. An entity may not unilaterally decide to use the alternative requirements. Rather, if an entity wants to use the alternative requirements, the entity must consult with the State Historic Preservation Officer and if that official agrees that compliance with the accessibility requirements would threaten or destroy the historic significance of the building or facility, then the alternative requirements may be used. A new paragraph has been added at 4.1.7(2)(b) for this purpose.

The Board wishes to emphasize that when applying this provision, the inquiry should focus on whether compliance with the accessibility requirements would threaten or destroy the characteristics of a building or facility that make it eligible for listing in the National Register of Historic Places or designation as historic under an appropriate State or local law. The National Park Service and Advisory Council on Historic Preservation have had considerable experience with making accessible alterations to qualified historic buildings and facilities and have expressed interest in working with the Board to develop technical guidance and procedures to assist State Historic Preservation Officers in carrying out their consultation responsibilities and to ensure consistent and uniform application of the provision at the State and local level.

The National Conference of State Historic Preservation Officers reported that some State historic preservation programs have established good working relationships with their State and local accessibility officials and that the guidelines should encourage these relationships. The section 106 process also provides for involving other interested parties in the consultation process. See 36 CFR 800.5(e)(1). A new paragraph has been added at 4.1.7(2)(c) recommending that State and local accessibility officials, and individuals with disabilities and their organizations be involved in the consultation process.

Section 101(c)(1) of the National Historic Preservation Act (16 U.S.C. 407a(c)(1)) allows for responsibilities to be delegated to a local government historic preservation program certified by the State Historic Preservation Officer and the Secretary of the Interior. To be certified, a local government must meet certain minimum requirements, including professional expertise in architectural history. See 36 CFR 61.5. There are about 600 certified local governments. A new paragraph has been added at 4.1.7(2)(d) to allow the

State Historic Preservation Officer to delegate consultation responsibilities for purposes of this section to a certified local government.

Comment: Commenters generally expressed support for using the alternative requirements in 4.1.7(3) (4.1.7(2) in the NPRM) in those cases where accessibility cannot be achieved without threatening or destroying the historical significance of a building or facility. The National Park Service noted that based on its experience accessibility can be achieved in most cases with some alteration of non-significant features. The National Park Service, Advisory Council on Historic Preservation, National Trust for Historic Preservation, and other commenters with historic preservation responsibilities expressed a need for greater flexibility in providing accessibility to qualified historic buildings and facilities. These commenters expressed concern that it may be technically infeasible to comply with specific accessibility requirements in the case of some buildings and facilities. These commenters also recommended that an exception be established for a small group of buildings and facilities such as a historic house museum that has only one entrance and where modifying the doorway or cutting out a window to create an accessible entrance would destroy the characteristics that make the building eligible for listing on the National Register of Historic Places.

Response: As stated in 4.1.7(1)(a), the provisions of 4.1.6 relating to alterations apply to qualified historic buildings and facilities. If it is technically infeasible to comply with a specific accessibility requirement, the other elements and features of the building or facility that are being altered and can be made accessible must be made accessible within the scope of the alteration. See 4.1.6(1)(g). Flexibility is also allowed under 2.2 which permits alternative designs and technologies to be used on a case-by-case basis where they will provide substantially equivalent or greater access to and usability of a building or facility. As for those buildings and facilities where it may not be possible to achieve compliance with the alternative requirements without destroying the historic significance of the building, the Board plans to consult with the National Park Service and Advisory Council on Historic Preservation about this issue and propose an exception in the next phase of rulemaking. An exception is reserved under 4.1.7(1)(a) for this purpose.

Comment: With respect to the exception in 4.1.7(3)(b) (4.1.7(2)(b) in the NPRM) which permits access by means of an entrance not generally used by the public if a public entrance cannot be made accessible provided that the alternative entrance is unlocked and directional signage is provided, the NPRM asked how security concerns can be addressed and convenient and independent access facilitated at the same time. Most persons who responded to the question favored retaining the requirement that the alternative entrance be unlocked and independently operable, and recommended that a notification system also be provided.

Response: The requirement for the alternative entrance to be unlocked has been retained and a new requirement has been added for a notification system to be provided. A provision has also been added permitting use of a remote monitoring system where security is a concern. If a remote monitoring system is used, the alternative entrance must remain unlocked.

4.2 through 4.35 Technical Specifications

Sections 4.2 through 4.35 contain the technical specifications for elements and spaces required to be accessible by the scoping provisions (4.1 through 4.1.7) and special application sections (5 through 10). The technical specifications are the same as the 1980 version of ANSI A117.1 standard, except as noted in the text of italics.¹³

4.2 Space Allowances and Reach Ranges

Comment: Several commenters recommended that the technical specifications for clear floor turning, and maneuvering spaces should be increased for individuals who use power wheelchairs and three wheeled scooters. A few commenters also recommended changes to the side reach ranges.

Response: Additional research is needed regarding space allowances and reach ranges for individuals who use power wheelchairs or three wheeled scooters. No change has been made in the guidelines.

4.3 Accessible Route

Comment: A number of commenters recommended that skywalks and tunnels be specifically included as part of accessible routes.

¹³ The ANSI A117.1 standard is reprinted with permission from the American National Standards Institute. Copies of the ANSI A117.1 standard may be purchased from the American National Standards Institute at 1430 Broadway, New York, NY 10016.

Response: Since skywalks and tunnels can be part of an accessible route, they have been specifically included in 4.3.1.

Comment: The NPRM requested comments on various options for language to include in 4.3.2 regarding travel distances between points on an accessible route. Most commenters from each category who responded to the question favored stating that the accessible route shall, to the maximum extent feasible, coincide with the route for the general public.

Response: A requirement has been added to 4.3.2 that the accessible route shall, to the maximum extent feasible, coincide with the route for the general public. Since the route provided for the general public is usually the shortest and most direct route, the requirement will result in that route being made accessible in most cases.

Comment: Several commenters stated that the minimum widths for accessible routes and passing space requirements were not adequate and should be increased. No research or supportive data was provided.

Response: No changes have been made.

4.3.11 Areas of Rescue Assistance

Comment: Many commenters favored including technical specifications for areas of rescue assistance in the guidelines. Commenters, including the National Fire Protection Association (NFPA), submitted various recommendations for changes to the technical specifications, including permitting the use of exit stairway landings with a standpipe and areas having direct access to elevators specifically designed for emergency evacuation purposes. Several commenters recommended that the 1991 Uniform Building Code provisions for areas of rescue assistance be adopted.

Response: The 1991 Uniform Building Code provisions for areas of rescue assistance have been modified and incorporated in 4.3.11 since they represent the most current and comprehensive provisions on the subject. See 1991 Uniform Building Code, chapter 31, section 3104(b). The final guidelines permit seven different areas meeting certain conditions to be used as areas of rescue assistance. The final guidelines do not restrict the use of exit stairway landings with standpipes because the first duty of firefighters is to assist in the evacuation of individuals from the building or facility before undertaking the protection of property. The final guidelines also permit use of elevator lobbies with direct access to an emergency evacuation elevator when

elevator shafts and adjacent lobbies are pressurized as required for smokeproof enclosures by local regulations and when complying with certain other requirements. The Uniform Building Code provisions for size, stairway width, two-way communication and signage have also been adopted with a clarification that the communication system must include both visual and audible signals.

4.4 Protruding Objects

Comment. The NPRM asked questions regarding the adequacy of the technical specifications for protruding objects. About one-fourth of the commenters believed that they were adequate. The other commenters made over 30 different suggestions for changes.

Response. No changes have been made. The comments suggest that additional research is needed in this area.

4.5 Ground and Floor Surfaces

Comment. The NPRM asked whether a quantitative value should be assigned for slip resistance of ground and floor surfaces. Although there was general support for the concept, commenters presented information on a variety of issues, including the variability of measurement techniques and the likelihood of obtaining different values; lack of consensus regarding appropriate testing methods; and manufacturers certification of products.

Response. Recommended values for slip resistant surfaces on accessible routes and ramps have been included in the appendix at A 4.5.1. Many common building materials suitable for flooring are now labelled with information on the static coefficient of friction. Although it may not be possible to compare one product directly with another, or to guarantee a constant measure, builders and designers are encouraged to specify materials with appropriate values. As more products include information on slip resistance, improved uniformity in measurement and specification is likely.

Comment. The greenhouse industry raised questions about the coverage of gravel pathways in greenhouses.

Response. If a greenhouse is used only as an employee work area, the guidelines only require that the work area be designed and constructed so that individuals with disabilities can approach, enter, and exit the area. See 4.1.1(3) Thus, ground and floor surfaces within the greenhouse are not required to comply with 4.5 where the facility is used only as an employee work area. On the other hand, if the greenhouse is also used for retail sales purposes, the

facility must be designed and constructed to be accessible, including having an accessible route which has a ground or floor surface that complies with 4.5. Gravel is generally used for drainage under plant beds and walkways can be made of asphalt or concrete. Even where walkway drainage is needed, there are a variety of methods for providing firm, stable, and slip resistant surfaces.

Comment. A number of comments were received on the technical specifications for carpets in 4.5.3. Some commenters expressed concern about the 1/2 inch maximum pile height and recommended that it should not apply to carpeting off an accessible route. Other commenters recommended that performance requirements should be developed for carpets with pile height higher than 1/2 inch.

Response. The technical specifications for carpets in 4.5.3 are taken directly from the ANSI A117.1 standard. The requirements only apply to ground and floor surfaces along accessible routes and in accessible rooms and spaces, including public use and common use areas. If an area is used only as an employee work area, the ground and floor surfaces within the work area are not required to comply with 4.5, consistent with the provision in 4.1.1(3) that requires the work area to be designed and constructed so that individuals with disabilities can approach, enter, and exit the area. Additional advisory material on carpets is included in the appendix at A4.5.3.

4.6 Parking and Passenger Loading Zones¹⁴

Comment. Several commenters requested that the requirements regarding the location of accessible parking spaces be clarified. Some commenters recommended that a maximum distance such as 200 feet be specified between accessible parking spaces and accessible entrances.

Response. The technical specifications in 4.6.2 have been revised based on the proposed BCNC scoping provisions and provide that accessible parking spaces serving a particular building must be located on the shortest accessible route of travel from adjacent parking to an accessible entrance. In parking facilities that do not serve a particular building, the accessible parking spaces must be located on the shortest accessible route of travel to an

accessible pedestrian entrance of the parking facility. In buildings with multiple accessible entrances with adjacent parking, accessible parking spaces must be dispersed and located closest to the accessible entrances. For instance, at a shopping mall with several accessible entrances or a strip shopping center where each separate tenancy is required to have an accessible entrance, the accessible parking spaces would be dispersed and located closest to the accessible entrances.

A maximum distance has not been included in the guidelines because the requirement that accessible parking spaces be located on the shortest accessible route of travel to an accessible entrance will in most cases result in the spaces being located as close as practical to the nearest accessible entrance. Specifying a maximum distance such as 200 feet could result in the provision being misinterpreted as requiring that the spaces be within 200 feet but not necessarily located closest to an accessible entrance.

Comment. Several commenters from the parking industry questioned the requirement in 4.6.3 that accessible parking spaces and adjacent access aisles must be level with surface slopes not exceeding 1:50 (2%) in all directions. For instance, the National Parking Association (NPA) noted that paved surfaces must have a designed slope of at least 1:100 (1%) to provide drainage and that structural systems frequently used in parking structures have cambered elements where the member must be sloped more than 2% to get a 1% actual slope at the high end of element.

Response. The requirement in 4.6.3 for a level surface with slopes not exceeding 1:50 (2%) applies only to accessible parking spaces and adjacent access aisles and not to the entire floor area of the parking facility. A level surface is necessary at accessible parking spaces and adjacent access aisles to enable individuals who use wheelchairs to safely transfer to and from a vehicle and to permit the deployment of lifts from vans. As the NPA's comment recognizes, it is possible to achieve an actual 1% slope at parts of the floor area of the parking facility. When planned for in the early design phase, it is possible to achieve a level surface with a slope not exceeding 1:50 (2%) at the accessible spaces and adjacent access aisles.

Comment. Several commenters recommended additional requirements for access aisles, including location of

¹⁴ As discussed under the scoping provisions for parking in 4.1.2(5), the final guidelines include requirements for van accessible parking spaces and the technical specifications in 4.6.4 and 4.6.5 relating to vans have been modified.

curb ramps and striping or otherwise designating access aisles.

Response. Figure 9 shows that the access aisle must be demarcated (a wide parking space alone is not in compliance) and that the connection to the accessible route is at the front of the aisle. Additional information has been included in the appendix on access aisles. The access aisle must be connected to an accessible route to the appropriate accessible entrance of a building a facility. The access aisle must either blend with the accessible route or have a curb ramp complying with 4.7. The curb ramp opening must be located within the boundaries of the access aisle, and not the parking space, and the curb ramp cannot project into the aisle. The required dimensions of the access aisle cannot be restricted by planters, curbs, or wheel stops.

4.7 Curb Ramps

Few comments were received on the technical specifications for curb ramps in 4.7 and they did not warrant any changes. Some comments concerned wayfinding for persons with visual impairments and detectable warnings at curb ramps which are addressed under 4.29.

4.8 Ramps

Comment. The NPRM asked whether the technical specification in 4.8.2 requiring a maximum 1:12 slope for ramps in new construction should be changed. Most persons in each category who responded to the question favored retaining the maximum 1:12 ramp slope. Those commenters who recommended a change preferred ramp slopes between 1:16 and 1:20.

Response. The technical specification in 4.8.2 has not been changed. However, information has been added to the appendix at A4.8.2 explaining that the ability to manage an incline is related to both its slope and its length. Wheelchair users with disabilities affecting their arms or with low stamina have serious difficulty using inclines. Many wheelchair users, for instance, cannot manage a slope of 1:12 for 30 feet. Most wheelchair users and people with mobility impairments who are ambulatory can manage a slope of 1:16. For these reasons, ramp slopes between 1:16 and 1:20 are preferred. The technical specifications in 4.8.4 have also been revised to clarify that a level landing is required at the top of each ramp and each ramp run. A statement has been added to the appendix at A4.8.4 explaining that level landings are essential toward maintaining an aggregate slope that complies with the guidelines. A ramp landing that is not

level can cause individuals using wheelchairs to tip backward or bottom out when the ramp is approached.

Comment. Several commenters recommended changes to the technical specifications for handrails in 4.8.5, including making the height ranges consistent with the model codes and not requiring handrails on ramps adjacent to seating in assembly areas.

Response. The height ranges for handrails in 4.8.5(5) has been changed from "between 30 inches and 34 inches" to "between 34 inches and 38 inches" to be consistent with the model codes. A similar change has been made to the technical specifications for handrails on stairs in 4.9.4. A provision has also been added to 4.8.5 clarifying that handrails are not required on ramps adjacent to seating in assembly areas.

Comment. A number of commenters recommended that additional railings or higher edge protection be provided for persons with visual impairments.

Response. These recommendations will be studied for future revisions of the guidelines.

4.9 Stairs

Comment. Several commenters recommended that open risers should be permitted on stairs under certain conditions such as where ventilation is critical or on monumental and decorative stairs.

Response. The prohibition against open risers in 4.9.2 applies only to stairs covered by the scoping provision in 4.1.3(4). That provision requires that interior and exterior stairs connecting levels that are not connected by an elevator must comply with 4.9. Thus, open risers may be used on stairs which connect levels also served by an elevator or other accessible means of vertical access.

Comment. Several commenters recommended that steps should have contrasting nosings or tread markings. Some commenters also recommend that the nosing projection should be reduced from 1/2 inches to 1/4 inch maximum.

Response. The Board is not aware of any research that supports these recommendations. There is some controversy over whether each step should have the contrast nosing or only the top and bottom step of each stair. The Board is aware that the February 1991 draft revisions to the ANSI A117.1 standard proposed to add a technical specification for tread markings on stairs. Pending further research or action by the ANSI A117 Committee, the Board is not inclined to include this provision in the guidelines.

Comment. Commenters made several recommendations for changes to the

technical specifications for handrails in 4.9.4, including making the height ranges consistent with the model codes; permitting the 1/2 inch clearance between handrails and the wall to be a minimum; and adopting a provision from the California code on handrail extensions. Some commenters also presented detailed comments regarding wayfinding problems when persons who are visually impaired encounter diagonal or circular stairs.

Response. The height range for handrails in 4.9.4(5) has been changed from "between 30 inches and 34 inches" to "between 34 inches and 38 inches" to be consistent with the model codes. A similar change has been made to the technical specifications for handrails on ramps in 4.8.5. The Board has retained the 1/2 inch clearance between the handrails and the wall as an absolute. As explained in the appendix at A4.26.1, many people brace their forearms between supports and walls to give them more leverage and stability in maintaining balance. The 1/2 inch clearance is a safety clearance to prevent injuries from arms slipping through the openings. It also provides adequate gripping room. The other recommendations require further study.

Comment. A number of comments were received raising safety concerns about the use of the raised truncated domes as detectable warnings at stairs. These comments are further discussed under 4.29.

Response. For the reasons explained under 4.29, the requirement in 4.9.5 for detectable warnings at stairs has been reserved until further research is conducted regarding the use of raised truncated domes as a detectable warning at stairs.

4.10 Elevators

Comment. Several commenters recommended that the February 1991 draft revisions to the ANSI A117.1 standard be adopted. Some commenters also recommended that references to the elevator safety code be updated.

Response. The February 1991 draft revisions to the ANSI A117.1 standard proposed to establish separate technical specifications for new and existing elevators. The Board believes that it is best to await further action by the ANSI A117 Committee in this area. In the meantime, the references to the elevator safety code in 4.10.1, 4.10.6, and 4.10.14 have been updated to the current code, ASME A17.1-1990. The reference to platform lifts or wheelchair lifts has also been deleted from 4.10.1 in light of the revised scoping provisions for those devices in 4.1.3(5) and 4.1.6(3)(g).

Comment. Commenters generally supported the requirement for braille characters on hoistway entrances, control panels, and emergency communication systems. Several commenters requested that the technical specifications in 4.10.5, 4.10.12, and 4.10.14 be clarified to specify that raised characters must be accompanied by braille. Some commenters requested that the reference to the use of recessed letters or symbols in 4.10.14 for identifying emergency communication systems be deleted. A number of commenters recommended that automatic verbal announcements of floor stops be required in place of audible signals.

Response. The NPRM provided in 4.10.5, 4.10.12, and 4.10.14 that hoistway entrances, control panels, and emergency communication systems have raised characters complying with 4.30.4. That provision provided for raised characters to be accompanied by braille. The final guidelines have been clarified by including the requirement for brailled characters in 4.10.5, 4.10.12, and 4.10.14. The technical specifications in 4.30.4 do not permit the use of recessed letters. To be consistent with that provision, the reference to recessed letters or symbols in 4.10.14 for identifying emergency communication systems has been deleted.

The Board recognizes that automatic verbal announcements of floor stops is preferred by individuals with visual impairments. The technical specifications in 4.10.13 permit their use in place of audible signals.

Comment. A number of commenters recommended that the ANSI A117.1-1986 standard for control panel height should be adopted in place of the NPRM.

Response. The NPRM provided in 4.10.12(3) that all floor buttons on elevator control panels be no higher than 48 inches, unless there is a substantial increase in cost, in which case the maximum mounting height may be increased to 54 inches. Commenters questioned what constitutes a "substantial increase in cost" and pointed out that the ANSI A117.1-1986 standard provides for greater flexibility by requiring all floor buttons to be no higher than 54 inches above the floor for side approach and 48 inches for front approach. The final guidelines adopt the ANSI A117.1-1986 standard for control panel height in 4.10.12(3).

Comment. A number of commenters requested additional guidance on the technical specification in 4.10.14 for an emergency two-way communication system.

Response. Additional information has been included in the appendix at A4.10.14 on emergency two-way communication systems. Such systems should ideally provide both voice and visual display intercommunication so that persons with visual impairments and persons with speech and hearing impairments can receive information regarding the status of a rescue. A voice intercommunication system cannot be the only means of communication because it is not accessible to persons with speech and hearing impairments. While a voice intercommunication system is not required, at a minimum, the system must provide both an audio and visual indication, such as a recorded message and flashing light, to announce that a rescue is on the way.

4.11 Platform Lifts/Wheelchair Lifts

Comment. Most of the comments received on platform lifts or wheelchair lifts were in response to questions in the NPRM regarding scoping provisions which are discussed under 4.1.3(5). Commenters from the lift industry recommended that the technical specifications should reference current safety standards. Individuals with disabilities and their organizations recommended that the technical specifications should specifically provide for independent operation.

Response. The technical specifications in 4.11.2 have been revised to reference the current safety standard, ASME A17.1-1990, part XX. The scoping provisions in 4.1.3(5) Exception 4 also require that platform lifts or wheelchair lifts comply with applicable state or local codes. The technical specification in 4.11.3 has also been revised in response to comments regarding independent operation to specifically require the platform lifts or wheelchair lifts provide for unassisted operation. This requirement does not preclude the use of a key to operate a lift as long as the key is readily available and allows for unassisted operation. The appendix in A4.11 has also been revised to provide more up-to-date information on platform lifts or wheelchair lifts.

Comment. Commenters from the lift industry requested that an exception be established to permit the use of inclined lifts with a 30 inch by 40 inch platform size in stairwells with space limitations.

Response. Inclined lifts are required to comply with the technical specifications in 4.2.4 for clear floor space which provides for a minimum clear space of 30 inches by 48 inches to accommodate a wheelchair user. The Board is aware that this space will not accommodate some powered wheelchairs or three

wheeled scooters which are increasing in popularity, especially among older people. The Board does not believe that any exceptions should be established permitting the use of shorter platform lifts or wheelchair lifts.

4.12 Windows

Comment. The NPRM proposed to adopt the ANSI A117.1 standard for windows which provides for a maximum 5 pounds of force (lb.) to open operable windows and for locks, cranks, and other hardware to comply with the technical specifications for controls and operating mechanisms, including reach ranges for forward or side approaches. A number of commenters expressed concern that the 5 lb. maximum force requirement is not currently achievable.

Response. The technical specifications for windows have been reserved in the final guidelines and information from the ANSI A117.1 standard has been placed in the appendix at A4.12.1 and A4.12.2. When the Board issued MGRAD in 1982, it reserved the technical specifications for windows pending further study or experience with the ANSI A117.1 standard. See 47 FR 33862. (August 4, 1982). The Board subsequently sponsored a research project on hand anthropometrics which studied the capabilities of selected individuals with disabilities to operate mechanisms and building components. The findings from the research project suggested design criteria for window opening hardware and indicated appropriate operable forces based on specific types of hardware that were compatible with the ANSI A117.1 standard. Based on the results of the research project, Board adopted the ANSI A117.1 standard when it revised MGRAD in 1989. See 36 CFR 1190.31(j), 54 FR 5434 (February 3, 1989). Information obtained during the current rulemaking revealed that the existing industry standards for operable windows are 25 lb. for sliding windows and 45 lb. for double hung windows and that windows meeting the ANSI A117.1 standard are not commonly available for use in heavy construction. The Board needs additional information about existing products and technologies before it can adopt final technical specifications for windows.

4.13 Doors

Comment. Commenters made individual recommendations for changes or clarifications to the technical specifications for doors in 4.13 and the accompanying figures. For instance, clarification was requested regarding whether all or part of the clear space on

the latch side of the door in figure 25(a) can be provided by other accessible space such as an open space for hanging clothes in a hotel guestroom.

Response. Two minor changes have been included in the technical specifications for door hardware in 4.13.9. First, the sentence in the NPRM referring to doors in dwelling units has been deleted since it was not consistent with the requirements for doors in accessible units in transient lodging in 9.2.2(3) which requires all doors designed to allow passage into and within all accessible sleeping rooms and units to comply with 4.13. Second, the sentence in the NPRM referring to doors to hazardous areas has been deleted because the technical specifications in 4.29.3 for detectable warnings on doors to hazardous areas has been reserved. An additional change has been made to 4.13.6 to label the exemption in the last sentence of that technical specification as an "exception."

With regard to figure 25(a), the guidelines do not preclude other accessible space from being used to provide the required clearance on the latch side of the door as long as the specified dimensions are met and other uses of the space do not interfere with or intrude upon the clearance required by a wheelchair user or crutch user to reach and open the door or present other barriers not allowed in the guidelines. For example, an open rack mounted on the wall in such a way so as to provide clearance for a wheelchair user or crutch user could be a protruding object. An enclosed closet area would not likely permit adequate maneuvering space.

4.14 Entrances

All the comments on entrances concerned the scoping provision and are discussed under 4.1.3(8). No changes have been made to the technical specifications.

4.15 Drinking Fountains and Water Coolers

Comment. Commenters made individual recommendations for changes or clarifications to the technical specifications for drinking fountains and water coolers in 4.15. For instance, clarification was requested regarding the spout location on a drinking fountain with a round or oval bowl.

Response. A sentence has been added to the technical specification for spout location in 4.15.3 to clarify that on a drinking fountain with a round or oval bowl, the spout must be positioned so the flow of water is within 3 inches of the front edge of the fountain. The sentence in appendix at A4.15.2 has also been clarified that two drinking

fountains, mounted side by side or on a single post, are usable by individuals with disabilities and people who find it difficult to bend over.

4.16 Water Closets

Comment. Commenters made individual recommendations for changes or clarifications to the technical specifications for water closets in 4.16 and accompanying figures. For instance, clarification was requested regarding the dimensions of the grab bar behind the water closet in figure 29(a) and the location of the lavatory in figure 28.

Response. A sentence has been added to the technical specifications in 4.16.4 to clarify that the grab bar behind the water closet must be 36 inches minimum. The grab bar dimensions have also been clarified in figure 29(a). Additional information has been provided in the appendix at A4.22 regarding figure 28 and the placement of the lavatory. The dotted lines in figure 28 designate the minimum clear floor space, depending on the direction of approach, required for wheelchair users to transfer onto the water closet. The dimensions of 48 inches and 60 inches, respectively, correspond to the space required for wheelchair users to perform a diagonal approach transfer and side approach transfer. See Fig. A6 (a) and (b). Placement of the lavatory to the immediate side of the water closet will preclude use of the side approach transfer. To accommodate the side approach transfer, the space adjacent to the water closet must remain clear of obstruction for 42 inches from the center line of the toilet and the lavatory must not be located within this space. A turning circle or T-turn, the clear floor space of the lavatory, and maneuvering space at the door must be considered when determining the possible wall location. See Fig. 3, 25 and 32.

4.17 Toilet Stalls

Comment. The NPRM presented two approaches for accommodating the needs of persons with mobility impairments who are ambulatory with respect to use of toilet stalls: (a) provide for moveable grab bar in the 60 inch wide standard stall; or (b) provide for a 36 inch wide alternate stall or a conventional, non-accessible stall equipped with dual parallel grab bars in addition to the 60 inch standard stall. Most persons in each category who commented on the two approaches opposed the use of moveable grab bars and supported the provisions of a 36 inch wide alternate stall with dual grab bars in addition to the 60 inch wide standard stall. Some commenters questioned why the 36 inch or 48 inch

alternate stalls are only permitted in alterations where the provision of a 60 inch wide standard stall is technically infeasible.

Response. The guidelines require use of the 60 inch wide standard stall unless it is technically infeasible in alterations because that stall provides clear floor space and grab bars to enable wheelchair users to perform a side approach transfer or diagonal approach transfer from a wheelchair to the toilet. See Fig. A6 (a) and (b). Although many wheelchair users are unable to use either alternate stall, persons with mobility impairments who are ambulatory can use them. Many of those persons find it more convenient to use the two parallel grab bars in the 36 inch wide alternate stall. Based on the comments, a provision has been added to the technical specifications for toilet rooms in 4.22.4 requiring that a 36 inch wide alternate stall with parallel grab bars be provided in addition to the 60 inch wide standard stall where six or more toilet stalls are provided. Since the stall is primarily intended for use by persons with mobility impairments who are ambulatory rather than wheelchair users, the length of the stall could be conventional. The door, however, must swing outward to ensure a usable space by persons with mobility impairments who are ambulatory.

Comment. Several commenters recommended that the width dimensions in figure 30 (a) and (b) should be labeled as minimum. A number of commenters requested that the requirements for hardware on toilet stall doors be clarified.

Response. The width dimensions in figure 30 (a) and (b) have been labeled as minimum. The technical specification in 4.19.5 has been clarified that toilet stall doors including hardware, must comply with 4.13. That provision requires in relevant part at 4.13.9 that handles, pulls, latches, locks, and other operating devices on accessible doors must have a shape that is easy to grasp with one hand and does not require tight grasping, tight pinching, or twisting of the wrist to operate.

4.18 Urinals

Few comments were received on the technical specifications for urinals in 4.18 and they did not warrant any changes.

4.19 Lavatories and Mirrors

Comment. Commenters made individual recommendations for changes or clarifications to the technical specification for lavatories and mirrors in 4.19. For instance, it was pointed out

that hot water and drain pipes under lavatories can be configured near the back wall so as to prevent contact but the technical specifications only allowed insulation for protection.

Response. The technical specifications for exposed pipes and surfaces in 4.19.4 have been revised to require that hot water and drain pipes under lavatories be insulated or otherwise configured to protect against contact.

4.20 Bathtubs

Comment. Commenters made individual recommendations for changes or clarifications to the technical specifications for bathtubs in 4.20. For instance, clarification was requested that the lavatory in figure 33 must provide clear space under it to reach the bathtub control area and that the shower spray unit required by 4.20.6 can be used both as a fixed shower head and as a hand-held shower.

Response. The technical specifications for lavatories in 4.19.2 and 4.19.3 require that a clearance of at least 29 inches be provided from the floor to the bottom of the apron of the lavatory and that a clear floor space of 30 inches by 48 inches be provided in front of the lavatory. The technical specifications in 4.20.6 has been clarified to provide that the shower spray unit can be used both as a fixed shower head and as a hand-held shower.

Comment. The NPRM asked whether a vertical grab bar should be provided in addition to the dual horizontal grab bars required by 4.20.4. Most persons in each category who responded to the question favored the provision of a vertical grab bar. However, the commenters made differing recommendations regarding the location and size of the vertical grab bar.

Response. The location and size of the vertical grab bar requires further study before it can be specified.

4.21 Shower Stalls

Comment. As further discussed under 9.1.2, the final guidelines require that hotels with 50 or more sleeping rooms or suites must provide a certain number of sleeping rooms or suites that include a 30 inch by 60 inch or 36 inch by 60 inch roll-in shower as illustrated in figure 57 (a) and (b). The NPRM asked several questions regarding the design of the roll-in shower. Most persons from each category who responded to the question favored: (a) including a fold-up seat in the shower; (b) requiring the seat to be slip-resistant; (c) allowing the shower head and controls to be located in the center of the long wall of the shower;

and (d) providing two mounting hooks for the shower spray unit.

Response. The technical specifications for seats in 4.21.3 have been revised to add a provision for a fold-up seat in the 30 inch by 60 inch roll-in shower required for hotels. The seat must be mounted on the wall adjacent to the controls or shower as shown in figure 57. A requirement has not been included for the seat to be slip-resistant pending further study. A note has been added to figure 37(b) allowing the shower head to be located on the long wall or on either side wall. A requirement has not been included for two mounting hooks pending further study of mounting heights. However, the technical specification in 4.20.6 has been clarified to provide that the shower spray unit must be useable both as a fixed shower head and as a hand-held shower.

Comment. One commenter pointed out that the American Society of Testing and Materials (ASTM) and the Consumer Product Safety Commission have developed slip resistant standards for shower stalls. Another commenter submitted data showing that shower stall drains should be located in a corner to avoid the potential hazards of slipping on a sloping surface and to provide an even surface for portable shower seats.

Response. These matters will be further studied for future revisions of the guidelines.

4.22 Toilet Rooms

Comment. As further discussed under 4.17, most persons who responded to questions in the NPRM regarding accommodating the needs of persons with mobility impairments who are ambulatory with respect to use of toilet stalls favored the provision of a 36 inch wide alternate stall with dual grab bars in addition to the 60 inch wide standard stall.

Response. A provision has been added to the technical specifications for toilet rooms in 4.22.4 requiring that a 36 inch wide alternate stall with parallel grab bars be provided in addition to the 60 inch wide standard stall where six or more toilet stalls are provided. Additional information on the design of this stall is provided in the appendix at A4.17.3 and is discussed under 4.17.

Comment. Some commenters recommended that accessible "unisex" toilet rooms be provided.

Response. Accessible "unisex" toilet rooms are preferred by some wheelchair users, especially those who may be assisted by another person. Information on the design of accessible "unisex" toilet rooms has been included in the

appendix at A4.22.3. The appendix recommends that consideration be given to providing accessible "unisex" toilet rooms in new construction, in addition to providing the required accessible toilet stalls in other rest rooms. The appendix also points out that accessible "unisex" toilet rooms are permitted in alterations where it is technically infeasible to make existing toilet rooms accessible.

4.23 Bathrooms, Bathing Facilities, and Shower Rooms

Comment. Commenters made individual recommendations for changes to the technical specifications for bathrooms, bathing facilities, and shower rooms. For instance, it was recommended that group showers in locker rooms be addressed.

Response. Group showers will be more fully addressed in future revisions of the guidelines. The technical specifications for the placement of controls and the shower head in roll-in showers can be used in a corner of a group shower to provide access.

4.24 Sinks

Few comments were received on the technical specifications for sinks in 4.24 and they did not warrant any changes. To be consistent with the change made to technical specifications for lavatories in 4.19, 4.24.6 has been revised to require that hot water and drain pipes under sinks be insulated or otherwise configured to protect against contact.

4.25 Storage

Comment. Commenters made individual recommendations for changes or clarifications to the technical specifications for storage in 4.25. For instance, it was requested that the height and depth for closet rods and shelves be clarified.

Response. The technical specifications in 4.25.3 for the height and depth of closet rods and shelves have been clarified. Accessible storage must be within the reach ranges in 4.2.5 or 4.2.6 for a forward approach (Fig. 5) or a side approach (Fig. 6). For a side approach where the distance from the wheelchair to the clothes rod or shelves does not exceed 10 inches, the height of the clothes rod cannot exceed 54 inches and shelves must be provided between 9 inches and 54 inches. In reach-in closets without accessible doors where the distance from the wheelchair to the clothes rod or shelves exceeds 10 inches, but is less than 21 inches, the height of the clothes rod cannot exceed 48 inches and shelves must be provided between 9 inches and 48 inches. These

dimensions are shown in figures 38 (a) and (b). An additional closet rod or shelves may be provided outside the specified dimensions.

4.26 Handrails, Grab Bars, and Tub and Shower Seats

Few comments were received on the technical specifications for handrails and grab bars in 4.26 and they did not warrant any changes.

4.27 Controls and Operating Mechanisms

Comment. Several commenters asked whether controls and operating mechanisms that are not normally intended for public use must comply with the technical specifications in 4.27.

Response. An exception has been added to the technical specifications at 4.27.3 which provides that the requirements do not apply where the use of special equipment dictates otherwise or where electrical and communications systems receptacles are not normally intended for use by building occupants. For instance, electrical receptacles installed specifically for wall-mounted clocks and refrigerators or microwave ovens in transient lodging or lunch rooms in an office building are not required to be placed within the specified reach ranges if the receptacles are not intended for regular or frequent use by building occupants.

Comment. The American Hotel and Motel Association (AHMA) stated, without any explanation, that thermostats must be mounted at 60 inches and cannot be placed at an accessible height. A few commenters also expressed concern that State and local codes require electrical outlets be placed lower than 15 inches above the floor.

Response. The technical specifications in 4.27.3 require that the highest operable part of controls, dispensers, receptacles, and other operable equipment be placed within the forward reach range in 4.2.5 (maximum high forward reach is 48 inches and minimum low forward reach is 15 inches, where there is no obstruction) or the side reach range in 4.2.6 (maximum high side reach is 54 inches and minimum low side reach is 9 inches, where there is no obstruction). Thermostats and electrical outlets that are intended for use by building occupants are controls subject to 4.27. The technical specifications in 4.27.3 regarding the location of such controls are taken directly from the ANSI A117.1 standard. AHMA did not cite to any State or local code provision that requires thermostats to be mounted at 60 inches and the Board is not aware of

any. State and local building codes allow the lower placement of electrical outlets but do not preclude what is required in 4.27.3. The Fair Housing Accessibility Guidelines also provide for thermostats and electrical outlets to be placed within similar heights. Therefore, there is no basis for establishing different requirements for thermostats or electrical outlets.

4.28 Alarms

Comment. The NPRM asked whether requirements should be established for the standardization of audible alarms to distinguish them from other sounds. The commenters were divided on the issue. The National Fire Protection Association (NFPA) and several other commenters recommended that the technical specifications for audible alarms in 4.28.2 should be consistent with the NFPA 72A Standard for Protective Signalling Systems. NFPA 72A recommends that the duration of a sound which an alarm should exceed by 5 decibels should be 60 seconds rather than 30 seconds. NFPA 72A also recommends a 130 decibel maximum sound level. NFPA further recommended that the requirements should be stated in terms of the "A" weighted scale.

Response. The technical specifications for audible alarms in 4.28.2 have been revised to conform to NFPA 72A, except that the maximum sound level of 120 decibels has not been changed. The Board understands that the 120 decibel level is commonly known as the "threshold of pain." The 130 decibel level recommended in NFPA 72A was primarily intended for industrial application where noise is a problem and may be appropriate only for industrial occupancies. The 120 decibel level limit has been retained pending further information. The comments did not otherwise present any information beyond that obtained through the Board's research project which concluded that there was not enough known about the problem to develop specific requirements for the standardization of audible alarms. Instead, additional information developed by the Board's research project has been included in the appendix to assist builders and designers in selecting appropriate systems.

Comment. NFPA and several other commenters recommended that the technical specifications for visual alarms in 4.28.3 should be consistent with NFPA 72G Guide for Installation, Maintenance, and Use of Notification Appliances for Protective Signalling Systems. A few commenters recommended that the Board reserve

establishing any requirements for visual alarms until it evaluated a recent study by the Underwriters Laboratory (UL) on such alarms. Some building owners and managers requested that the requirements should be more performance oriented. For example, a system was suggested in which some or all of the building lights would flash in some fashion. Several commenters stated that the requirements should address ambient light levels due to concern that the intensity of the visual signal might temporarily blind people in areas with low light. A few commenters were also concerned about the effect of strobe lights in inducing seizures in certain individuals.

Response. The technical specifications for visual alarms in 4.28.3 have been revised as follows to be consistent with NFPA 72G:

(a) A new paragraph has been added at 4.28.3(3) to provide for a maximum pulse duration of 0.2 sec. with a maximum duty cycle of 40%.

(b) The maximum 120 candela intensity has been deleted from 4.28.3(4) (4.28.3(3) in the NPRM). NFPA 72G permits intensities up to 1000 candela and the UL study found no evidence that such bright devices caused any eye damage in view of the shortness of the flash pulse.

(c) The height requirement for placement of visual signal devices in 4.28.3(6) (4.28.3(5) in the NPRM) has been amended to specify that the devices be at least 6 inches below the ceiling to reduce the potential concealment by smoke.

The requirements in 4.28.3 (7) and (8) (4.28.3 (6) and (7) in the NPRM) have been revised to clarify that the spacing distance applies only in rooms or spaces which are required to have visual signal appliances. The requirement that no place be more than 50 feet from the signal means that the signaling devices would be spaced 100 feet apart as recommended in NFPA 72G. A sentence has also been added to address the spacing of signaling devices in large rooms and spaces such as auditoriums that are more than 100 feet across and are not divided by walls or partitions above 6 feet. In such rooms and spaces, the signaling devices may be placed 100 feet apart around the perimeter of the room or space instead of suspending the devices from the ceiling.

The Board has reviewed the UL study and it generally supports the technical specifications in 4.28.3. The Board notes that NFPA 72G is scheduled to be revised in 1993 and that the UL is planning to develop standards for visual signal devices. The Board intends to

monitor these standards and update the guidelines, as appropriate.

The Board has not opted for more performance oriented requirements because the lack of specificity in the current UFAS and ANSI A117.1 standards have resulted in the provision of some ineffective visual alarm systems. As new systems and technologies are developed and tested, the equivalent facilitation provision in 2.2 provides sufficient flexibility for builders and designers to use them. The Board will also consider new systems and technologies when it periodically updates the guidelines.

NFPA 72G and the UL study indicate that the 75 candela minimum signal intensity specified in 4.28.3(4) is not harmful at different lighting levels. The ambient lighting level of typical offices, classrooms, and hotel rooms as tested by UL ranges from 20 to 75 lumens per square foot. NFPA 72G recommends a signal intensity of 100 to 1000 candela for that lighting level. The UL study tested strobe lights with intensity levels equivalent to those required by 4.28.3(4), including tests conducted in a totally dark room where the strobe flash provided the only light. Not only were the subjects not blinded, but they were able to move about the room and find specific objects on a table. As for the possible effect of strobe lights in inducing seizures in certain individuals, the Board's research project and other available information indicate that the problem does not occur if the flash rate is less than 5 HZ. The Board has set the maximum rate at 3 HZ for additional safety.

Comment. Several commenters pointed out that if portable visual alarms are permitted in dwelling units and sleeping rooms, they should be triggered by the emergency alarm system for the building. A few commenters recommended that portable vibrating alarms should also be required to awaken sleepers. Some commenters noted that the requirement that the signal be visible in all areas of the dwelling unit or sleeping room would be difficult in some unusually shaped rooms and spaces.

Response. The intent of the technical specifications for auxiliary alarms in 4.28.4 is that the portable devices will be equivalent to a permanently installed visual alarm that is connected to the building emergency alarm system. The requirement has been clarified by specifying that a means must be provided by which a signal from the building emergency alarm system can trigger the auxiliary alarm. This can be accomplished by providing a separate circuit or transmitting a signal through

the normal wiring system to trigger the portable device.

The UL study found that it required a signal of 110 candela to wake a sleeping person compared to a 15 candela signal to alert people in normal work situations. The UL study also found that vibrating alarms were more effective than visual signals for waking sleeping persons. This information has been included in the appendix at A4.28.4.

The requirement that the signal be visible in all areas of the dwelling unit or sleeping room is reasonable since the purpose of the alarm is to alert persons to emergencies. NFPA 72G states that the signal should be visible "regardless of the orientation" of the individual. The signal can reflect off the walls and be visible in various areas of the room. Some unusually shaped rooms and spaces may require more than one visual alarm device. Builders and designers should take this into consideration when designing and building new facilities.

4.29 Detectable Warnings

Comment. The NPRM proposed to include new provisions for detectable warnings based on research and planned revisions to the ANSI A117.1 standard. A detectable warning is a standardized surface feature built in or applied to walking surfaces or other elements to warn individuals with visual impairments of hazards on a circulation path. The detectable warning should consist of raised truncated domes. Comments were received in support of and in opposition to including detectable warnings in the guidelines. Commenters who opposed detectable warnings gave a variety of reasons. Some individuals with visual impairments stated that with proper training and use of mobility aids they can avoid dangers in the physical environment. These commenters believed that detectable warnings are unnecessary and the people with visual impairments may tend to rely on detectable warnings rather than learn adequate mobility skills. They also expressed concern that detectable warnings might cause hazards for people with visual impairments because the warnings are distracting and can cause people to lose their balance. They noted that detectable warnings may also be hazardous for people with mobility impairments who are ambulatory especially in outdoor conditions where ice and snow removal may be adversely affected by the raised truncated domes. Other commenters stated that detectable warnings create and perpetuate misconceptions and attitudinal barriers about people who

have visual impairments. They expressed concern that detectable warnings would negatively affect the employment of people with visual impairments because employers might mistakenly perceive that such individuals cannot function in an environment that is not specially equipped. In their view, detectable warnings could result in "unintended discriminatory effects." A few commenters questioned the adequacy of the research; the long term durability of raised truncated domes; the ability of the construction industry to comply with the requirement; and the aesthetics of detectable warnings.

Commenters who supported detectable warnings also gave a variety of reasons. They pointed out that there is a significant number of people with visual impairments who are not able to fully master mobility skills due to a range of factors, including age of onset, type of disability, and innate abilities. They further pointed out that necessary cues such as traffic sounds are not always distinguishable due to various circumstances which are beyond the control of the individual. These commenters were concerned about the safety of persons who cannot depend on using mobility skills to detect hazardous conditions. They believed that detectable warnings can prevent unnecessary accidents and deaths and do not stigmatize people who have visual impairments because the warnings are helpful to all people. They noted that detectable warnings are frequently used in industrial settings to warn workers whose vision may be temporarily obscured of hazards in the workplace and have been proven effective in preventing accidents and injuries.

Some commenters generally supported the concept of detectable warnings but suggested that the guidelines should allow for a variety of surface treatments in order to accommodate variations in walking surfaces and design techniques.

Response. Accessibility includes ensuring that individuals with disabilities can safely use the built environment. Some of the requirements in the guidelines such as those for areas of rescue assistance and visual alarms are based primarily on concern for the safety of individuals with disabilities. The purpose of detectable warnings is to alert individuals with visual impairments of hazards on a circulation path that might otherwise go unnoticed and result in serious injury. Although mobility training is essential, as some of the commenters pointed out, a

significant number of people with visual impairments are not able to fully master mobility skills. Further, mobility training is not always readily available.

The Board's goal is to provide appropriate cues in the built environment to facilitate the use of mobility skills. The Board does not believe that detectable warnings are any more stigmatizing than ramps. Like other accessibility features, detectable warnings benefit all people.

As discussed in the NPRM, studies have demonstrated the raised truncated dome pattern to be an effective detectable warning. See *Tactile Warnings to Promote Safety in the Vicinity of Transit Platform Edges*, Urban Mass Transportation Administration (1987); *Pathfinder Tactile Tile Demonstration Test Project*, Metro-Dade Transit Agency (1988). The domes can be constructed using a variety of methods including concrete stamping or the application of a prefabricated surface treatment. Although there are other common surface treatments that are detectable, the concept of a detectable warning is to provide consistent and uniform surface treatment that is distinctive from other materials and consistently recognized as a warning in order to alert pedestrians that they are approaching a potentially dangerous area.

The final guidelines retain the requirements in 4.29.2 for detectable warnings to consist of raised truncated domes. The requirement for detectable warnings used on interior surfaces to differ from adjoining walking surfaces in resiliency or sound on cane contact has also been retained. However, for the reasons discussed under the comments below, the Board has limited the application of detectable warnings to hazardous vehicular ways, reflecting pools that are not otherwise protected, and curb ramps. The provisions for detectable warnings at stairs and on doors to hazardous areas have been reserved pending further study.

Comment. The NPRM provided in 4.29.2 for detectable warnings to contrast visually with adjoining surfaces and proposed to specify a 70% contrast ratio. The NPRM asked several questions regarding the proposed contrast ratio, including whether it was too difficult to achieve and whether a one inch black band between the detectable warning and adjoining surfaces would provide sufficient contrast for persons with low vision. Most of the persons who responded to the question objected to the contrast ratio. Several commenters stated that it could not be measured or enforced under field conditions. Some

commenters noted that materials with demonstrated low maintenance and durability characteristics often have low reflective values and would not meet the criteria. Many commenters also opposed the use of a black band. Several commenters recommended that detectable warnings should be a yellow color.

Response. The final guidelines provide in 4.29.2 that detectable warnings must contrast visually with adjoining surfaces, either light-on-dark or dark-on-light. The 70% contrast ratio has been placed in the appendix at A4.29.2 and is advisory only.

Comment. A number of commenters opposed the requirements in 4.9.5 and 4.29.4 for detectable warnings at stairs primarily based on concern that the raised truncated domes will create a tripping hazard. Several commenters, including industries which use detectable warnings to alert workers of hazards such as loading docks, requested that the depth of the warning be decreased from 36 inches to 24 inches.

Response. Although detectable warnings have been successfully used at such locations as transit platform edges and loading dock edges, there is no data available regarding this application at stairs. People may use a different gait when they approach stairs compared to other walking surfaces. The requirement in 4.9.5 and 4.29.4 for detectable warnings at stairs have been reserved pending further study regarding possible tripping hazards. The requirements in 4.29.3 and 4.29.7 for detectable warnings on doors to hazardous areas and for standardization of such warnings within a building, facility or site have also been reserved pending further study.

Comment. A number of commenters requested that detectable warnings also be required at uncurbed and unprotected drop off areas where a fall may be extremely hazardous or life threatening such as transit platforms and loading docks. Some commenters were opposed to detectable warnings at those locations. Several commenters recommended that detectable warnings should be required where the drop-off separating the pedestrian and vehicular way is more than curb height.

Response. The requirement in 4.29.5 has been clarified that a detectable warning is required when a walk crosses or adjoins a vehicular way, and the walking surfaces are not separated by curbs, railings, or other elements between the pedestrian areas and vehicular areas. For instance, some hotels have driveways that adjoin walkways at entrances. If there is no curb separating the pedestrian and

vehicular area, a detectable warning would have to be provided. Detectable warnings for transportation facilities will be addressed in section 10 of the final guidelines which will be published separately in the *Federal Register*. Detectable warnings have not been required at loading docks and loading ramps because those areas are generally not open to the public. If an individual employee with a visual impairment works in an area with hazardous drop-offs, detectable warnings would be covered by reasonable accommodation under title I of the ADA.

Comment. Some commenters questioned the requirement in 4.7.7 for detectable warnings at curb ramps. A few commenters expressed concerns about maintenance, including snow and ice removal. Other commenters suggested changes to the requirement that the detectable warnings extend the full width and depth of the curb ramp.

Response. Properly designed curb ramps have gentle slopes which may not be easily detectable by some persons with visual impairments. Furthermore, changes in slope along pedestrian ways are commonplace and persons with visual impairments cannot predictably know when a change in slope indicates the presence of a curb ramp. The Board is concerned about the safety of persons with visual impairments who may unknowingly enter a vehicular way due to the lack of any cue or warnings at curb ramps to prevent serious injuries and deaths. The requirement in 4.7.7 for detectable warnings at curb ramps has therefore been retained.

4.30 Signage

Comment. A number of commenters, including graphic designers and sign manufacturers, objected to the technical specifications for character height and letter spacing in 4.30.3. Their primary concern was the impact of the requirements on the size of the sign. For instance, the NPRM proposed that letters on building directories be $\frac{5}{16}$ -inch minimum. One commenter pointed out that the current industry standard for film negative directories is $\frac{1}{16}$ inch which is roughly $\frac{1}{4}$ the size proposed in the NPRM. Building directories would need to be 16 times their current size (4 times as high and 4 times as wide) to meet the $\frac{5}{16}$ -inch minimum. The commenter noted that larger office buildings have difficulty just accommodating a directory large enough to list their occupants in $\frac{1}{16}$ -inch type. Several individuals with disabilities and other commenters objected to wide letter spacing because they believed it

would make it more difficult to read by word shape or "footprint."

Response. The minimum height requirements for building directories and wall mounted signs and the provision for wide letter spacing have been deleted from the technical specifications in 4.30.3. Signs that are suspended or projected overhead in compliance with the technical specifications for protruding objects in 4.4.2 (i.e., more than 80 inches above the floor or ground) are required to have a character height of 3 inches minimum. A sentence has also been added to 4.30.3 to clarify that lower case letters are permitted.

Comment. Individuals with disabilities and government agencies involved with disability issues supported the technical specifications for raised and brailled characters in 4.30.4. Many of the commenters who opposed the technical specifications, including graphic designers and sign manufacturers, interpreted the NPRM as requiring all signs to have raised and brailled characters and all upper case letters and apparently objected to the scoping provisions and technical specifications on that basis. A few commenters also expressed concern that raised and braille characters may be more prone to vandalism.

Response. As discussed earlier, the scoping provisions for exterior and interior signage have been clarified in response to the comments. See 4.1.2(7) and 4.1.3(16). Only those signs which designate permanent rooms and spaces must comply with the technical specifications in 4.30.4 through 4.30.6 for raised and brailled characters, finish and contrast, and mounting location and height. No changes have been made to the technical specifications for raised and brailled characters in 4.30.4. Raised and brailled characters can be designed to be as vandal resistant as other signage.

Comment. Several graphic designers and sign manufacturers objected to eggshell finish being specified in the technical specifications for finish and contrast in 4.30.5. They felt that it unnecessarily restricts the industry. A number of commenters also objected to the 70% contrast ratio proposed in the NPRM because they believed that it could not be measured or enforced in the field.

Response. The Board sponsored research project on which the technical specifications for finish and contrast in 4.30.5 are based found that eggshell and matte finishes are equally readable by persons with low vision. The NPRM proposed to require only eggshell because of its relative resistance to

soiling compared to matte. The final guidelines provide for eggshell, matte, or other non-glare finish. The 70% contrast formula has been placed in the appendix at A4.30.5 and is advisory only. The appendix also recommends an eggshell finish and light characters on a dark background.

Comment. The NPRM proposed in 4.30.6 that signs providing permanent identification of rooms and spaces be mounted on the wall adjacent to the latch side of the door at a height between 54 and 66 inches. These signs are required to include raised and brailled characters. A number of commenters recommended different mounting heights. Some pointed out that the 66 inch height was not within the reach range for wheelchair users. Other commenters pointed out that a more uniform and consistent mounting height would make it easier for persons with visual impairments to locate the signage.

Response. The technical specifications in 4.30.6 have been revised to require that signs providing permanent identification of rooms and spaces be mounted 60 inches above the finish floor to the center of the sign. The 60 inch mounting height was recommended in the original research for the ANSI A117.1—1980 standard. See Accessible Buildings for People with Severe Visual Impairments, Steinfeld (1978). Lowering the maximum height also reduces the viewing distance for persons with low vision and places the sign at a more comfortable reading height for users of braille and raised characters. A sentence has also been added to 4.30.6 clarifying that where there is no wall space to the latch side of the door, including at double leaf doors, signs are to be placed on the nearest adjacent wall.

Comment. A number of commenters recommended that the international symbol of access for hearing loss be used to identify the availability of permanently installed assistive listening systems in assembly areas required to have such systems by 4.1.3(19)(b).

Response. A requirement has been added to the technical specifications for symbols of accessibility in 4.30.7 that assistive listening systems be identified by signage that includes the international symbol of access for hearing loss. See Fig. 43(d). Additional information is provided in the appendix at A4.30.7 regarding appropriate messages to include with the symbol (e.g., infrared Assistive Listening System Available—Please Ask).

Comment. The NPRM proposed in 4.30.8 that illumination levels on the sign surface be in the 200 to 300 lux range (10 to 30 footcandles) and that the

illumination level on the surface of the sign not be significantly exceeded by the ambient light or visible bright lighting source behind or in front of the sign. A number of commenters objected to this provision as unenforceable. Other commenters noted that the proposed levels were generally met or exceeded in indoor lighted areas.

Response. The technical specifications for illumination levels in 4.30.8 has been reserved pending further study. The NPRM provision has been included in the appendix at A4.30.8 and is advisory only.

4.31 Telephones

Comment. The NPRM asked what decibel range should be specified for volume control telephones. Persons who responded to the question generally favored a range of 12 decibels to 18 decibels. Some commenters requested higher levels, stating that those with lower levels were not helpful. Although most telephone companies who responded to the question indicated that their equipment would fall within this range, they were opposed to specifying any decibel level.

Response. The final guidelines provide in 4.31.5(2) that public telephones required to be equipped with volume controls by 4.1.3(17)(b) must be capable of a minimum of 12 decibels and a maximum of 18 decibels above normal because higher levels can damage the ear. If an automatic reset button is provided, the 18 decibel level may be exceeded.

Comment. A number of commenters recommended that the requirement in 4.31.5 for a magnetic field in the area of the receiver cup should be changed to require hearing aid compatible telephones.

Response. The technical specifications in 4.31.5(1) have been revised to require that public telephones required to be equipped with volume controls by 4.1.3(17)(b) must be hearing aid compatible. The Hearing Aid Compatibility Act of 1988 requires that nearly all telephones be hearing aid compatible.

4.32 Fixed or Built-In Seating and Tables

Comment. Commenters made individual recommendations for changes and clarifications to the technical specifications for fixed or built-in seating and tables in 4.32. For instance, it was recommended that the depth requirement under tables be increased to accommodate guide dogs.

Response. The reference to "work surfaces" have been deleted from the

technical specifications in 4.32 since those features are not required to be accessible by 4.1.1(3). The appendix recommends at A4.1.1(3) that if individual work stations are made accessible, they should comply with the applicable technical specifications. As for change to the depth requirements under tables, further study is needed.

4.33 Assembly Areas

Comment. Individuals with disabilities and their organizations supported the requirements in 4.33.3 for wheelchair seating spaces to be dispersed throughout the seating area. Several commenters requested that companion seating also be provided next to wheelchair seating spaces. Commenters from the theater industry expressed concern about the loss of seats if wheelchair seating spaces are placed mid-row. Motion picture theater owners pointed out that new movie theaters are typically a multiplex of small auditoriums each of which seats between 150 and 300 people and that each seat is situated to provide a clear line of sight to the screen. They requested that such small auditoriums be exempt from the dispersal requirement. A few commenters recommended that ramped aisles which are part of an accessible route to wheelchair seating spaces should be permitted to have steeper slopes if necessary to provide adequate sightlines.

Response. The requirements in 4.33.3 for dispersal of wheelchair seating spaces have been modified. Wheelchair seating spaces must be an integral part of any fixed seating plan and be situated so as to provide wheelchair users a choice of admission prices and lines of sight comparable to those available to the rest of the public. A provision has been added for at least one companion fixed seat to be provided next to each wheelchair seating space. The final guidelines require that when the seating capacity exceeds 300, wheelchair seating spaces must be provided in more than one location. This provision is based on the California code and balances considerations of cost and lost of other seating spaces with the need for access. It should be noted, however, that the guidelines do not require wheelchair seating spaces to be placed mid-row. No significant loss of seats is anticipated. As discussed under the scoping provisions in 4.1.3(19)(a), to address concerns regarding the number of wheelchair seating spaces required in large facilities, a provision has also been added to 4.33.3 permitting readily removable seats to be installed in wheelchair seating spaces which may be

used by other persons when these spaces are not needed by wheelchair users or other individuals with mobility impairments. As explained in the appendix at 4.33.3, folding seating units usually consist of two fixed seats that can be easily folded into a fixed center bar to allow for open spaces for wheelchair users when needed.

As for ramped aisles which are part of an accessible route to wheelchair seating spaces, the Board is not convinced that slopes steeper than the maximum 1:12 permitted in 4.8.2 are necessary to provide adequate sightlines. Sightlines and visibility are affected by several factors, including the slope of the floor; the height of the screen; the distance between rows; and the staggering of seats. The Board understands that there are theaters designed with ramp aisles that comply with the maximum 1:12 slope and provide adequate sightlines.

Comment. The NPRM asked questions regarding row spacing and lines of sight over standing spectators in sports arenas and other similar assembly areas. Many of the persons who responded to the question stated that they have difficulty accessing mid-row seats in an assembly area. Many commenters also recommended that lines of sight should be provided over standing spectators.

Response. Building and life safety codes set minimum distances between rows of fixed seats with consideration of the number of seats in a row, the exit aisle width and arrangement, and the location of exit doors. Because row spacing is related to these other factors, the Board does not believe that it is appropriate for the guidelines to set requirements in this area. However, information has been included in the appendix at A4.33.3 on "continental" seating which allows a greater number of seats per row with a commensurate increase in row spacing and exit doors. This alternative increases ease of access to mid-row seats for people who walk with difficulty and facilitates emergency egress for all people. Builders and designers are encouraged to consider "continental" seating along with other factors when planning seating in assembly areas.

The issue of lines of sight over standing spectators will be addressed in guidelines for recreational facilities.

Comment. As discussed under the scoping provision in 4.1.3(19)(b) for assistive listening systems in assembly areas, the NPRM requested information regarding which types of assistive listening systems (magnetic induction loops, FM, and infra-red) work best in

particular environments. Many comments described their personal experiences with particular types of systems. Those who provide extensive information on the various systems recommended that a specific type should be selected only after consultation with experts in the field.

Response. Additional information on assistive listening systems is provided in the technical specifications in 4.33.6 and in the appendix at A4.33.6. The type of assistive listening system appropriate for a particular application depends on the characteristics of the setting, the nature of the program, and the intended audience. The appendix includes a table reprinted from a National Institute of Disability and Rehabilitation Research "Rehab Brief" which shows some of the advantages and disadvantages of each system and typical applications. New York has also adopted technical specifications which may be useful. A pamphlet is available from the Board which lists demonstration centers across the country where technical assistance can be obtained in selecting and installing appropriate systems.

4.34 Automated Teller Machines

Comment. The NPRM contained an exception in 4.1.3(20) for drive-up-only ATMs, which provided that drive-up ATMs are not required to comply with the requirements in 4.34.2 and 4.34.3 for controls and clearances and reach ranges because they are designed to be used from motor vehicles. The NPRM requested information on reach range requirements from standard size motor vehicles. The American Bankers Association (ABA) stated:

A number of uncontrollable variables are inherent in designing drive-up ATMs, e.g., the size of the driver; car dimensions; the skill of the driver in stopping the car close to the ATM. * * * However, given the number of uncontrollable variables, it is inevitable that certain drivers will be unable to use comfortably the drive-up ATM or will have to exit the car in order to complete a transaction.

Response. Because of the uncontrollable variables involved in utilizing drive-up ATMs, the Board, in the NPRM, provided an exception in the scoping provisions in 4.1.3(20) for drive-up ATMs. The drive-up ATMs do not have to comply with 4.34.2 (Controls) (which refers to 4.27) and 4.34.3 (Clearances and Reach Range) because they are designed to be used from motor vehicles. The Board maintained that exception with a minor change in referencing the provisions. The current provision states that the drive-up ATMs

are not required to comply with 4.27.2, 4.27.3 and 4.34.3.

Comment. The ABA took the position that drive-up ATMs should be exempt from requirements that they be accessible to persons with visual impairments. The basis for their position was that drive-up ATMs are supposed to be used by the driver of the car who must have sufficient vision to drive legally. Should a passenger wish to use the ATM, stated the ABA, the driver could assist. Another commenter supported this position stating that a person who is visually impaired cannot use the drive-up ATM from the rear seat because most newer cars do not have fully openable windows.

Response. While the Board understands that the driver must have sufficient vision to operate the automobile, a passenger riding in either the front or back seat of the automobile may be visually impaired. Although the ABA cites the availability of the driver for assistance, this method would not allow the individual to use the ATM independently. In responding to the issue of drive-up ATMs in general, the ABA stated that given the number of uncontrollable variables, it is inevitable that some drivers will have to exit the car in order to complete a transaction. Thus it is entirely conceivable and not unexpected that a passenger may exit the automobile to use the drive-up ATM and this passenger may be an individual who is visually impaired. Furthermore, while some cars do not have fully operable rear windows, many cars do and, as with the front seat passenger, the individual in the rear seat may exit the car to utilize the ATM.

Consistent with the scoping provisions in 4.1.3(20) where a drive-up ATM is located adjacent to a walk-up ATM, only one ATM would have to be accessible to persons with visual impairments. Operational issues regarding the availability of accessible ATM services (e.g., accessible ATM being open same hours as non-accessible ATM) would be covered by the Department of Justice's regulations.

Comment. Section 4.34.4 provides that instructions and all information for use of ATMs shall be made accessible to and independently usable by persons with vision impairments. In the NPRM, the Board sought additional information on equipment presently in use or available technologies for making instructions and other information relating to the use of ATMs accessible to persons with vision impairments. There were over 50 different suggestions for making ATMs accessible to persons with vision impairments including (1) The installation of a handset voice

output telephone device; (2) using large print and braille; (3) a "talking machine"; (4) using phone type receivers behind locked doors; (5) cassette instructions; (6) braille instructions; and (7) using a consumer electronics bus or universal interface bus for output accessibility.

The ABA took the position that while some technology does exist to assist many visually impaired persons, there does not appear to be technology to ensure in every case ATM accessibility to all visually impaired persons. The ABA stated that current technology supplied to assist visually impaired persons includes raised key identification overlay; high quality contrast screens; character font design selections to ensure easiest reading; and character enlargement. The ABA suggested that educational audio tapes and braille manuals offer at least one source of immediate accommodation for persons with vision impairments.

The ABA further recommended that the regulations concerning ATMs be "flexible and fluid." The ABA stated that "(i)t would be unfortunate if the initial or later regulations locked in specifications and standards in a manner which discourages future innovations and improvements" and that "(a)s technology develops and improves and as disabled persons determine and convey their suggestions, the facilities should evolve to provide better accessibility to disabled persons." The ABA was of the opinion that flexibility is particularly crucial with regard to providing ATM access to persons with vision impairments.

Response. While not stated specifically in the rule, braille and large print instructions (as proposed in the planned revisions to the ANSI A117.1 standard), when used in conjunction with tactually marked keys or other means of identification, do serve as one source of accommodation for persons with vision impairments. In an article recently published in the ABA Banking Journal, it was noted that at least one manufacturer provides ATMs with brailled keys as a standard feature. The manufacturer also provides training kits for bank customers with vision impairments that include a braille workbook on how to use the machine. Access Comes to ATMs, ABA Banking Journal (November 1990).

In light of the evolving technology in this area and to allow flexibility in design, the Board has stated the requirement for accessibility for persons with vision impairments in general performance terms. No changes were made to this section from the proposed rule which provides that instructions

and all information for use of ATMs shall be made accessible to and independently usable by persons with vision impairments. While the planned revisions to the ANSI A117.1 standard may contain more specific provisions with respect to equipping ATMs for use by persons with vision impairments, the Board has chosen to maintain its position of flexibility in this area.

Comment. The Board sought comment on whether or not visual displays should be required to maintain accessibility for persons with hearing impairments where telephone handsets are used to convey printed and displayed information to persons with vision impairments. The Board queried whether there was a possibility that handsets would entirely replace video display screens. The overwhelming majority of comments from individuals with disabilities and their organizations indicated that where telephone handsets are used, visual displays should also be provided. The ABA took the position that it is inconceivable at this time that telephone handsets would ever replace a visual display. The American Council of the Blind was in agreement with this position stating that whatever accommodations that are made for persons with visual impairments should not preclude use by persons with other disabilities. One commenter indicated that visual displays must be maintained for people with limited use of arms or hands and another commenter stated that many persons with hearing loss are not able to use instructions via telephones or intercoms.

Response. The Board is also of the opinion that if telephone handsets or similar devices are provided, these will be in addition to and not preclude video display screens. Although it is unlikely that this should ever occur, the Board may address this issue in the future.

Comment. The Board also sought information concerning vandalism and the use of telephone handsets. The ABA took the position that telephone handsets furnished with ATMs are more susceptible to vandalism than telephone handsets currently used for public telephones, citing the reason that ATM telephone handsets are often vandalized for reasons which do not apply to telephone handsets. As an example, the ABA cited the instance where people who try to access someone else's account using a debit card which does not belong to them could become angry enough to vandalize an ATM when they are denied access to the ATM. The Wells Fargo Bank, the Service Centers Corporation and other commenters also

expressed concern that telephone handsets are subject to vandalism.

Response. The Board is not requiring telephone handsets. Telephone handsets were suggested because they are one way that some banks have chosen to address the need for accommodation for persons with visual impairments. As cited in the ABA article, other means are available for providing information for use of ATMs by persons with vision impairments. These other means are not precluded should the banks prefer to use them. (The handset alternative was chosen to cost out in the regulatory impact analysis because of its high initial cost.)

Comment. The Board sought comment on whether information provided on video display screens (such as "deposit or withdrawal" and "checking or savings") can also be provided in braille when the user presses various keys. Additionally, the Board inquired whether receipts can be made accessible by braille or voice synthesis if a telephone handset or other listening device is used. Since many ATMs are located in an outdoor environment, the Board requested comment on how screen illumination and contrast can be provided in an outdoor environment where glare may be a problem.

The ABA stated that they are not aware of the availability of video display screens which are capable of displaying information in braille. Braille printers for receipts are available; however, the ABA took the position that such printers cannot be integrated with ATMs as a practical matter.

Further, according to the ABA, ATM manufacturers have researched in depth how to minimize glare through screen illumination and contrast. The ABA further stated that as new materials and techniques are developed, the effects of glare will be reduced and readability improved. They took the position that the Board should not enumerate specific contrast and color requirements as competition alone will ensure that the most readable combinations are marketed and used.

Response. Given the lack of technology which allows for the practical integration of braille printers in ATMs, the Board has not required braille printers at this time. The Board believes that technology in the industry must improve before specific contrast and color requirements can be included in the guidelines. The Board believes that this area needs further research.

Comment. The Board invited comments on how privacy needs can be met in the context of accessible ATMs. Comments received in response to this

section were primarily based on individual concerns and no research or supportive documentation was included. The ABA took the position that given the unavailability of voice synthesis, the use of a speaker is a viable option at this point which will not threaten the privacy of the user. Another commenter suggested using a system of beeps to confirm the transaction, while other commenters noted that audio output could result in a loss of privacy and security. Other suggestions for increased privacy included (1) installation of a "next in line" area behind which the visual display is unreadable; (2) making the display of information optional; (3) having a screen with a narrow viewing range or one which is not readable from all directions and angles; (4) enclosing ATMs in a booth; and (5) modifying the video display or viewing slot so it can be angled down farther or turned to the left or right, both manually and automatically, for individuals who use wheelchairs and others.

An issue which is interrelated with privacy matters is the concern for security. The Board sought comments concerning what security issues, if any, should be considered relative to an individual with a disability and whether or not there were considerations with respect to the environment around ATMs that may cause difficulty complying with the provisions of this section. The majority of the comments received addressed the need for security at ATMs based on use by the general public and not just by those individuals with disabilities. A limited number of commenters took the position that individuals with disabilities are "easier prey" and that use by visually impaired persons may increase the opportunity for criminal activity. One commenter stated that complex or costly security measures may be unreasonable in relation to the actual use by disabled people. Many commenters stressed the need for proper lighting at ATMs. Several other commenters took the position that security must not be compromised for access, and another comment asked that flexibility be allowed because the location and security considerations at ATMs vary widely. Suggestions to improve security included (1) using a telephone handset (audio output through speakers is undesirable since it can be overheard by others) or shaded screen and keeping the handset in a closed compartment accessible by card users only to prevent vandalism; (2) providing both $\frac{1}{8}$ and $\frac{1}{4}$ inch jacks so personal headphones can be plugged into an ATM (the jacks can be protected from tampering or vandalism by a sliding cover until the

ATM is activated by logging in a correct user identification); and (3) video monitoring around ATMs, as is done in convenience stores.

Response. Based on the response that the Board received concerning these areas, it is apparent that security and privacy are issues of general concern which apply to all ATM users and not just to individuals with disabilities and are issues which the industry must address. Until such time as additional research can be conducted into the issues of security and privacy at ATMs, the Board does not propose to include requirements for such measures.

Comment. The Board sought comment on whether other point of sale machines, such as machines selling insurance at airports or machines used for overnight delivery of letters and packages, should be covered by these guidelines and, if so, what requirements would be appropriate. Many persons who responded to the question favored providing access to the machines. A few commenters questioned whether the machines were fixed or built-in parts of a building or facility. Some commenters recommended that the machines should be addressed on a case-by-case basis as the services develop because blanket coverage in the early development stage could significantly lessen their distribution and the variety and quality of services provided.

Response. The Board believes this issue needs further study. However, the Board tends to agree with comments saying that a majority of the machines are equipment and therefore not within the Board's purview.

4.35 Dressing and Fitting Rooms

As discussed in the scoping provisions at 4.1.3(21), requirements have been added to the final guidelines for accessible dressing and fitting rooms. Technical specifications are provided for clear floor space, doors, a bench, and mirrors where provided.

5. Restaurants and Cafeterias

5.1 General

Section 5 contains specific requirements for restaurants and cafeterias, in addition to those contained in 4.1 through 4.35 and provides that where fixed tables are provided (or dining counters where food is consumed but there is no service) at least 5 percent, but not less than one, of the fixed tables (or a portion of the dining counter) shall be accessible and comply with 4.32 as required in 4.1.3(18).

Comment. The NPRM did not contain a specific reference to "counters" and a

number of the commenters questioned whether restaurants that provide only high counters along the wall are covered.

Response. Such counters are covered by the guidelines and the Board has clarified this coverage by specifically referencing "counters" in this section. The board further clarified the language to reflect that the 5% requirement of fixed or built-in seating or tables is not in addition to section 4.1.3(18). To avoid confusion with section 5.2 (Counters and Bars), the Board inserted language to clarify that this section refers to dining counters where food is consumed but is not served at the counter as opposed to section 5.2 which addresses counters where food or drink is served at the counter for consumption. Where counters are provided solely for the sale of food and drink and not consumption then those counters must comply with 7.2 Sales and Service Counters.

Comment. The Board invited comment on whether requiring that at least 5%, but not less than one, of the fixed tables be accessible and comply with 4.32 (Seating Tables, and Work Surfaces) was adequate or whether a higher or lower percent should be specified. The Board sought comment on the impact of the different percentages on space layouts and revenues.

Response. While a slight majority of the commenters favored a higher percentage, little supporting information was provided to assess the impact of the higher (or lower) percentage on space layouts and revenues. The requirement of 5% accessibility of fixed tables is based on current building codes. The Board retained the 5% provision with no further changes to this paragraph.

5.2 Counters and Bars

This section requires that where food or drink is served at counters exceeding 34 inches in height to customers seated on stools or standing at the counter, a portion of the main counter which is 60 inches in length minimum shall be provided in compliance with 4.32 (Fixed or Built-in Seating and Tables) or service shall be available at accessible tables within the same area.

Comment. The NPRM did not explain the term "portion" and at least half of those responding to this section urged the Board to clarify the reference to a "portion".

Response. The Board provided language to reflect that a "portion of the counter" refers to a portion of the main counter which is 60 inches in length minimum. The 60 inches space provides for two wheelchairs or one wheelchair and one seat or chair.

5.3 Access Aisles

This section contains technical specifications for access aisles to accessible fixed tables. No changes were made to this paragraph.

5.4 Dining Areas

Section 5.4 requires that, in newly constructed restaurants and cafeterias, raised or sunken dining areas, loggias, and outdoor seating areas must be accessible. In alterations, accessibility to raised or sunken dining areas, or to all parts of outdoors seating areas is not required provided that the same services and decor are provided in an accessible space usable by the general public and not restricted to use by people with disabilities.

In non-elevator buildings, an accessible means of vertical access to the mezzanine is not required provided the area of mezzanine seating measures no more than 33 percent of the area of the accessible seating area and the same services and decor are provided in an accessible space usable by the general public and are not restricted to use by persons with disabilities. This exception does not apply to buildings required to have an elevator.

Comment. Several commenters indicated that clarification was needed regarding the requirement that dining rooms be accessible. Based on the language of the NPRM, it was unclear whether all dining rooms or just those which are raised or sunken are required to be accessible.

Response. The Board clarified its intent that all dining areas are to be accessible in new construction.

5.5 Food Service Lines

Section 5.5 is taken from UFAS and provides technical specification for accessible food service lines. Instead of requiring a "reasonable portion" of self-service shelves to be within forward and side reach ranges (4.2.5 and 4.2.6), the guidelines require at least 50% of each type of self-service shelves to be within the required reach ranges. No changes were made to this paragraph.

5.6 Tableware and Condiment Areas

This section requires that self-service shelves and dispensing devices for tableware, dishware, condiments, food and beverages be installed to comply with 4.2 (Space Allowance and Reach Ranges). No changes were made to this section.

5.7 Raised Platforms

Section 5.7 requires that a raised platform used for the head table or speaker's lectern in banquet rooms or spaces shall be accessible by means of a

ramp or platform lift complying with 4.8 or 4.11, respectively. Open edges of a raised platform must be protected by the placement of tables or by a curb. No changes were made to this section.

5.8 Vending Machines and Other Equipment

This section requires that spaces for vending machines and other equipment shall comply with 4.2 and shall be located on an accessible route. The NPRM also provided that the equipment comply with 4.27 (Controls and Operating Mechanisms). This latter provision was deleted as it relates to equipment not under the jurisdiction of these guidelines.

5.9 Quiet Areas (Reserved)

Comment. A significant number of responses raised the issue of the need for "Quiet Areas" in restaurants. According to these commenters, extraneous noise and dim lights make it difficult for persons with hearing impairments to communicate when dining out.

Response. The Board has reserved this section until such time as research can be conducted on appropriate requirements which address the need for a quiet area in restaurants.

6. Medical Care Facilities

These sections establish specific requirements for medical care facilities, in addition to those contained in 4.1 through 4.35. The sections apply to medical care facilities such as hospitals where persons may need assistance in responding to an emergency and where the period of stay may exceed twenty-four hours. Doctors' and dentists' offices are not included in this section but are subject to the requirements of section 4.

6.1 General

Comment. Regarding the scoping provision for hospitals specifically approximately half of the commenters proposed increasing the percentage while the other half suggested that it be reduced. In addition to those comments, there were other commenters who favored increasing the percentage for medical facilities in general. Those arguing for a reduced figure in hospitals, did so based on the impact on cost and space. Humana Inc. expressed concern that the requirements of the guidelines for accessible bed and toilet rooms could result in a loss of 10% of beds in alterations. They further expressed concern about the requirement that all employee work areas be accessible. The American Hospital Association estimated cost increases of 20% for new

construction and 40% to 60% for alterations.

Response. The scoping requirement of 10% is based on the current MGRAD. The draft final regulatory impact analysis shows that the cost per square foot increase is \$1.00 per square foot for an overall percentage increase in new construction costs of 1.02%. The draft final regulatory analysis further shows that the cost increase per bed in a 100 bed hospital is \$879.50. Over the 40 year useful life of the facility this cost amounts to \$21.99 per bed per year. These figures support the requirement for 10% accessibility.

A portion of the commenters' anticipated cost was attributable to the health care industry's concern over the perceived 100% accessibility required in employee areas. To avoid any misunderstanding that the Board is requiring 100% accessibility for all rooms as a result of the reference to "employee use areas," the Board has deleted that reference. Provisions concerning areas used only by employees as work areas and individual work stations are covered under section 4.1.1(3). That section requires access to employee work areas to the extent that individuals with disabilities can approach, enter, and exit the areas.

Furthermore, retrofitting existing facilities solely for accessibility reasons is not required by the guidelines. Additionally, the distribution of accessible beds in a hospital can vary based on the anticipated need in different specialized units. For example, more than 10% may be needed in a general surgical unit and less than 10% in obstetrics and pediatrics.

The loss of beds referenced in the comments could result only from alteration of existing units and would be unlikely in most situations. A new section 6.1(4) has been added to address concerns about the impact of the alterations requirements. Section 6.1(4)(a) provides that when patient bedrooms (and toilet/bath rooms that are part of the patient bedroom) are being added or altered as part of a planned renovation to a discrete department of an existing medical facility, accessible patient bedrooms shall be provided in a percentage consistent with the percentage of rooms required to be accessible by the applicable requirements of 6.1(1), 6.1(2), or 6.1(3), until the number of accessible patient bedrooms in the facility equals the overall number of accessible patient bedrooms that would be required if the facility were newly constructed. For example, if 20 patient bedrooms are being altered in the obstetrics department of a hospital, 2 of the altered

rooms must be made accessible. If 20 patient bedrooms are being altered in a unit within the same hospital that specializes in treating mobility impairments, all of the altered rooms must be made accessible.

Section 6.1(4)(b) addresses alterations within departments that are not undergoing a complete renovation. Under section 6.1(4)(b), when patient bedrooms are being added or altered individually, and not as part of an alteration of the entire area, the altered patient bedrooms shall comply with 6.3, unless either (1) the number of accessible rooms provided in the department or area containing the altered patient bedroom equals the number of accessible patient bedrooms that would be required if the percentage requirements of 6.1(1), 6.1(2), or 6.1(3) were applied to that department or area or (2) the number of accessible patient bedrooms in the facility equals the overall number that would be required if the facility were newly constructed. For example, if a patient bedroom in a rehabilitation unit in a general hospital is altered, it must be made accessible because 6.1(2) requires all rehabilitation unit beds to be accessible. A patient bedroom in the obstetrics ward of a general hospital which is altered must be made accessible unless 10% of the beds in that ward are currently accessible or unless the facility as a whole already meets the new construction accessibility requirements. Where toilet or bath rooms are part of patient bedrooms which are added or altered and are required to be accessible, each such patient toilet or bathroom shall comply with 6.4. These provisions will enable a medical care facility to ensure that accessible rooms are distributed appropriately among the various units within the facility.

Comment. Many of the comments received on this section addressed the issue of scoping requirements for nursing homes. The majority of the comments received from nursing homes felt that the requirement for 50% of the patient bedrooms and toilets, all public use, common use and employee use areas was too excessive and suggested a figure of 5%. The justification given for the reduction was the substantial impact this requirement would have on cost and space. Many of those comments estimated that the cost increase per bed would be \$8,000.

Response. The scoping requirement of 50% is based on the current MGRAD. The draft final regulatory impact analysis shows that the cost per square foot increase is \$1.70 per square foot for an overall percentage increase in new construction costs of 1.74%. The draft

final regulatory impact analysis further shows that the cost increase per bed in a 76 bed nursing home is \$1553. Over the 40 year useful life of the facility this cost amounts to \$38.83 per year. These figures support the requirement for 50% accessibility.

Comment. The majority of the comments received from the nursing homes took the position that, "residential care facilities" should be exempt from the guidelines. The basis for their position was that, by definition, those facilities are not medical care facilities since they are primarily residential in nature and are not providing medical care.

Response. The Board considered the issue of residential care facilities. It is the understanding of the Board that clarification of the applicability of these guidelines to "residential care facilities" will be addressed in the rules to be issued by the Department of Justice. To avoid any misunderstanding, the term "period of residence" used in this section was revised to read "period of stay".

Comment. The responses from the nursing homes took exception to requiring that "employee work areas" be accessible. Those commenters reasoned that since nursing facility residents are dependent upon staff to assist them in the event of a fire or life-threatening emergency, staff must be physically capable of providing assistance as a requirement of employment. The provision for employee access to all patient rooms was characterized as a needless expense.

Response. The Board is of the opinion that not all nursing home staff are expected to be physically capable of providing assistance in emergency situations (e.g. clinicians, administrative personnel). As indicated above, to avoid any misunderstanding that the Board is requiring 100% accessibility for all rooms as a result of the reference to "employee use areas," the Board has deleted that reference.

Comment. The Board sought comment on whether other types of facilities should be listed in the scoping table. A majority of the responses supported the provision as proposed in the NPRM. Approximately 25% of the responses recommended adding clinics. Other facilities which were recommended for inclusion were outpatient/ambulatory care facilities, medical professional buildings, and dentist offices. Also suggested were hospices, assisted living and congregate care facilities and rehabilitation facilities.

Response. Clinics can vary considerably in the type of services

provided, and many do not provide patient bedrooms or provide overnight accommodation. If the clinics do provide patient bedrooms or overnight accommodation, they are covered under the provisions of this section of the guidelines, otherwise, they would be subject only to the requirements of section 4. The medical care facilities listed are meant to be illustrative. If a specific medical care facility is not mentioned, it is required to meet the requirements for the type of facility that it most closely resembles. For instance, an orthopedic hospital would be considered a rehabilitation facility. The Board considered outpatient care facilities, medical professional buildings and dentists offices, but did not consider these to be medical care facilities under this section as the period of stay does not exceed 24 hours.

The Board considered and included rehabilitation facilities in the guidelines based on the reason that those facilities would also specialize in treating conditions that affect mobility.

Additionally, the Board revised the language to reflect that if a hospital or a rehabilitation facility has a "unit" within the facility that specializes in treating conditions that affect mobility, then that unit, not the entire facility must meet the higher level of requirements for accessibility.

6.2 Entrances

This section contains technical specifications for entrances. No changes were made to this paragraph.

6.3 Patient Bedrooms

Section 6.3 provides that accessible patient bedrooms shall be provided in compliance with 4.1 through 4.35. Each accessible bedroom shall have a door that complies with 4.13, except that entry doors to acute care hospital bedrooms for in-patients shall be exempted from the requirement in 4.13.6 for maneuvering space at the latch side of the door if the door is at least 44 inches wide. Each accessible bedroom shall also have adequate space to provide a maneuvering space that complies with 4.2.3. In rooms with 2 beds, it is preferable that this space be located between beds. Furthermore, each accessible bedroom shall have adequate space to provide a minimum clear floor space of 36 inches along each side of the bed and to provide an accessible route complying with 4.3.3 to each side of each bed.

Comment. The NPRM provided that each bedroom would have a turning space preferably located near the entrance and a minimum clear floor space of 36 inches along each side of the

bed. Approximately one-third of the comments received which addressed this section considered the space requirements at entrances to patient bedrooms and along side beds to be too restrictive or excessive and would have a substantial impact on costs and availability of space. The American Association of Homes for the Aging (AAHA) recommended that the guidelines only require a minimum amount of square footage per room and leave the configuration of the room to the discretion of facility operators. The AAHA argued that existing requirements such as those issued by the Health Care Finance Administration (HCFA) on environmental quality already address the needs of patients including those who are disabled.

Response. The HCFA requirements cannot be regarded as an effective alternative to these guidelines as they address environmental quality and are not designed to address accessibility.

The NPRM recommended that a turning space in compliance with 4.2.3 be located near the entrance. As the provisions in 4.13 for doors addresses the issue of maneuvering space at doors, this was deleted.

In the NPRM, the Board distinguished between requirements for two-bed rooms and four-bed rooms. With the exception of stating that in rooms with two beds, it is preferable that the maneuvering space be located between the beds, the Board has revised the language to provide that each bedroom shall have adequate space to provide a minimum clear floor space of 36 inches along each side of the bed and to provide an accessible route complying with 4.3.3 to each side of the bed. The Board determined that the additional requirements for space between the foot of the bed and the wall or the foot of the opposing bed of 42 and 48 inches was excessive and not consistent with other accessibility requirements in the guidelines. Accordingly, the Board revised the guidelines to provide that only a provision of 36 inches along all sides of the bed is required.

For purposes of clarity, the Board restated the exception to 4.13 that entry doors to acute care hospital bedrooms for in-patients shall be exempted from the requirement in 4.13.6 for maneuvering space at the latch side of the door if the door is at least 44 inches wide.

6.4 Patient Toilet Rooms

This section was revised to clarify that where private toilet/bath rooms are provided as part of an accessible patient bedroom, the toilet/bath room must

comply with 4.22 or 4.23 and be on an accessible route.

7. Business and Mercantile

7.1 General

These sections contain specific requirements for all areas used for business transactions with the public, and are in addition to those in 4.1 through 4.35.

The comments received on this section generally involved operational issues which, pursuant to the ADA, are under the jurisdiction of the Department of Justice and not these guidelines. With the exception of providing that the provisions of this section are in addition to those in 4.1 through 4.35 (as opposed to 4.34 in the NPRM), no changes were made to this paragraph.

7.2 Sales and Service Counters, Teller Windows, Information Counters

Section 7.2 requires that where counters with cash registers are provided in department stores and miscellaneous retail stores for sales or distribution of goods or services to the public, at least one of each type shall have a portion of the counter which is at least 36 inches in length with a maximum height of 36 inches above the finish floor. It shall be on an accessible route complying with 4.3. The accessible counters must be dispersed throughout the building or facility. In alterations where it is technically infeasible to provide an accessible counter, an auxiliary counter meeting these requirements may be provided. Where counters without cash registers are provided and at which goods or services are sold or distributed, this section provides for three options: (1) A portion of the main counter which is a minimum of 36 inches in length shall be provided with a maximum height of 36 inches in; (or) (2) an auxiliary counter with a maximum height of 36 inches in close proximity to the main counter shall be provided; or (3) equivalent facilitation shall be provided. All accessible sales and service counters shall be on an accessible route complying with 4.3.

Comment. The NPRM did not explain the term "portion" and the Board was urged to clarify the reference to "portion".

Response. The Board provided language to reflect that a "portion of the counter" refers to a portion of the counter which is at least 36 inches in length with a maximum height of 36 inches above the finish floor.

Comment. The Board sought comments on whether a portion of each teller station or ticketing area should be

accessible or whether a percentage of the stations should be accessible where services are available at several points. Approximately 25% of the commenters to this section supported the requirement that a percentage should comply. Only a third of those responses recommended a specific percentage which ranged from 5% to 100%, but not less than one. Almost 50% of the responses preferred that a portion of each counter/station comply. The latter group of commenters argued that a portion of each is better because (1) it is difficult to ensure that the accessible counter will be staffed at all times; (2) it eliminates the stigma of a "handicap counter"; (3) counter functions may change throughout the day; (4) often there is only one queuing line rather than a separate line for each station which lessens the chance of getting the "accessible station"; and (5) equipment may break down rendering the accessible counter unusable.

Comments from banking institutions raised the concern that lower counters are a security risk for their tellers, banks, employees and customers. The hotel/motel industry was equally concerned over the security risks for their employees and also raised the issue that a higher counter is more ergonomically efficient for standing work areas. Supermarkets were concerned with how to make the refrigerated display cases in the meat, deli, and seafood accessible. They proposed serving disabled customers at the end of the counter. Retailers were concerned over the showcase islands which they use, as well as security and the loss of storage and display areas if they have to have a lower counter at every island.

Response. The Board amended the language of this section to take into consideration the different types of businesses and the varying uses of counters.

Counters with cash registers: In a department store or other retail store where counters with cash registers are provided, there must be at least one of each type which shall have a portion of the counter which is at least 36 inches with a maximum height of 36 inches above the finish floor. It shall be on an accessible route complying with 4.3. Accordingly, if the retailer chooses to have an express cash lane and one which takes only charges, one of each must be accessible.

Counters without cash registers, but where goods or services are sold or distributed: Where there are no cash registers at the counter, the Board provided for three options: (1) A portion of the main counter that is 36 inches in

width minimum shall be provided with a maximum height of 36 inches; or (2) an auxiliary counter with a height of 36 inches in close proximity to the main counter shall be provided; or (3) equivalent facilitation shall be provided.

The NPRM provided that where counters exceeding 36 inches in height are provided, a portion of the main counter shall be provided with a maximum height of between 28 inches to 34 inches above the floor. To address the concerns of safety raised by the commenters in response to the Board's question, the Board changed the scoping from "a portion of the main counter" to "at least one of each type" and raised the height requirement to a maximum of 36 inches above the finish floor. Additionally, where there is a cash register, only a portion of the counter need comply and that portion would not have to contain the cash register. Furthermore, for counters where there is no cash register, equivalent facilitation such as providing an auxiliary counter in close proximity to the main counter can be provided and may accommodate security concerns.

The Board has also added a provision in the appendix which recommends that an assistive listening device which complies with 4.33 be permanently installed at each location or series.

7.3 Check-out Aisles

Section 7.2 refers to counters without aisles whereas this section concerns counters with aisles which are identified here as check out aisles. A counter without an aisle can be approached in more than one direction such as in a convenience store, whereas a counter with an aisle has a circulation route having one approach and one exit and is therefore only approachable in one direction.

Comment. Of the comments received on this section, there was strong support from individuals with disabilities and their organizations for requiring that all check-out aisles be accessible. The response from the business community was strong in its opposition to requiring 100% accessibility. In support of their position, the business industry cited security risks, expense and difficult employee working conditions. The businesses provided statistics to support their concern for the costs involved. In connection with the cost impact of lost space, the International Mass Retail Association advised that sales per square foot equalled \$185 in the last year and on the average it was \$224.

Response. In the NPRM, the Board pointed out options which are available that can be designed and constructed to be accessible with only minor variations

from what is considered the "typical" design and little or no increase in overall square footage. The Board cited examples such as cashiers' stations that can be staggered front-to-back, or two narrow check-out aisles can be combined into a double-wide aisle served by cashiers on both the right and left sides of the aisle. The Board sought comments relating to the experience of stores which have utilized these designs to provide wider check-out aisles and whether the designs presented security considerations or required additional space. The comments received from the business industry reflected a concern over the loss of store space that would result with each accessible aisle and security problems. The Board has addressed these concerns by changing the requirement for 100% accessibility to a requirement that the number of accessible aisles be provided in accordance with a sliding scale which is based on the number of each "design" of check-out aisles. Check-out aisles of different design include those which are specifically designed to serve different functions and includes the following features: length of belt or no belt; or permanent signage designating the aisle as an express lane. Signage identifying accessible check-out aisles shall comply with 4.30.7 and shall be mounted above the check-out aisle in the same location where the check-out number or type of check-out is displayed. For small businesses, where the selling space is under 5000 square feet, only one check-out aisle is required to be accessible.

In alterations, at least one check-out aisle shall be accessible in facilities under 5000 square feet of selling space. In facilities over 5000 square feet of selling space, at least one of each design of check-out aisle shall be made accessible when altered until the number of accessible check-out aisles of each design equals the number required in new construction.

7.4 Security Bollards

No changes were made to this paragraph.

8. Libraries

These sections are taken from UFAS without change and provide specific requirements for the design of all public areas of libraries, including reading and study areas, stacks, reference rooms, reserve areas, and special facilities and collections. They are in addition to the requirements contained in 4.1 through 4.35.

Comment. The majority of the comments received regarding this section were from individuals with

disabilities and their organizations and included changes related primarily to individual concerns or preferences. Except for one commenter who stated that the North Carolina Building Code requires all fixed tables, stacks and carrels to be accessible, no research or supporting data was cited in the recommended changes.

Several commenters did raise concerns over the lack of requirements for braille/voice input/output terminals for book catalogs and existing electronic catalogs.

Response. The issue of braille/voice input/output terminals is an operational matter and is under the purview of the Department of Justice and is not addressed in the guidelines.

The Board retained the language of this section with only two minor changes. In section 8.3, the reference for the check out area was changed to reference 7.2(1) to be consistent with the requirements under sales and service counters. In section 8.4 (Card Catalogs and Magazine Displays), the term "reference stacks" was deleted to avoid confusion with section 8.5 which places no limit on the height of "stacks".

9. Accessible Transient Lodging

Section 9 contains specific requirements for buildings with multiple functions, the cross-reference to sections 4.1 through 4.35.

Comment. Many of the comments on this particular section came from the hotel industry, the majority of which recommended that the cross-reference to sections 5 and 7 should be deleted as it is redundant.

Response. Since 4.1.1(2) identifies the requirements for buildings with multiple functions, the cross-reference to sections 5 and 7 has been deleted.

Comment. The response from individuals with disabilities and their organizations generally recommended additional provisions for signage for persons who are visually impaired, such as requirements for tactile characters on doors, braille instructions on the use of phones, television, appliances, environmental controls, and other necessities and amenities which are provided by the hotel, as well as directional signage.

Response. No changes were made to this section regarding signage since section 4.30 addresses this issue and is applicable to transient lodging. In particular, sections 4.30.4 through 4.30.6 provide for permanent identification of rooms and spaces. Requiring brailled instructions for the use of phones, televisions and other portable items as suggested by commenters, is an operational issue which falls under the

jurisdiction of the Department of Justice and is not addressed in these guidelines.

Comment. One commenter noted that requiring all rooms to be on an accessible route would require the installation of elevators in two story hotels previously excluded in 4.1.3(5).

Response. In lieu of installing an elevator, the accessible rooms may be located on a ground floor which is accessible and thus elevators are not mandatory in two story hotels.

Section 9.1 Hotels, Motels, Inns, Boarding Houses, Dormitories, Resorts and Other Similar Places of Transient Lodging

The proposed guidelines provided that all public use and common use areas and five percent, but never fewer than one, of each class of sleeping rooms or suites are required to be designed and constructed to comply with section 4 and sections 9.2 through 9.3. The proposed guidelines further provided that in addition to the 5% accessible room requirement, another 5% must comply with 9.3 (sleeping accommodations for persons with hearing impairments) for a total of 10% of each class.

These requirements were enumerated in paragraph 9.1 of the proposed guidelines. The final guidelines address these areas in individually numbered sub-paragraphs in 9.1. They are discussed below in the order they appear under the new numbering system.

9.1.2 Accessible Units, Sleeping Rooms, and Suites

Comment—Number of accessible rooms. The majority of the comments from individuals with disabilities and their organizations supported the provision of a minimum of 5% accessible rooms. A small number of commenters suggested that the percentage of accessible rooms should equal the percentage of persons with disabilities; that at least 8% of the rooms should be accessible; that the 5% figure should increase to 10% in new construction; the exemption for facilities with fewer than 5 units should be deleted or that long term lodging (i.e. dormitories) should have additional rooms if the demand exceeds the supply.

Comments received from the business and industry groups strongly argued against the 5% figure stating that there was no foundation to support that requirement. Several commenters suggested a 2 to 4% figure. The American Hotel and Motel Association (AHMA) argued for a lower figure citing (1) the Department of Justice Preliminary Regulatory Impact Analysis which

states that according to a 1984 study by Mathematica Policy Research, 645,000 persons use wheelchairs; and (2) the US Travel Data Center statistics which found that 65% of all US residents take one or more trips for business or pleasure at least 100 miles away from home each year. Using these statistics, the AHMA found that a goal of achieving an equivalent amount of travel for disabled people would result in 419,000 travelers who use wheelchairs in the United States which equates to less than 0.3% of all travelers. Using the Board's statistics, of 1,341,000 people who use a wheelchair and/or a walker (National Health Institute Services, Home Care Supplement: 1980) and assuming 65% traveling, the AHMA found this to result in slightly more than 0.5%. The AHMA also cited the 1990 California Hotel and Motel Association survey of its members which indicated that the "incidence of demand as demonstrated by reservations for wheelchair accessible rooms was less than 0.1%." Based on that survey, the AHMA proposed that only 1% of the rooms should be required to be accessible.

Comment. Roll-in showers. The Board invited comments relative to a requirement for the larger roll-in showers in transient lodging. The majority of the responses received were strongly in favor of the larger stalls but varied on the number which should be required. Some of the issues raised in the responses included (1) requiring roll-in showers for people with disabilities who are unable to transfer into a bathtub or onto a shower seat; (2) requiring 5 feet by 5 feet showers; (3) providing fold down bench seats in all shower stalls; (4) placing shower controls along the side wall adjacent to the bathroom; (5) requiring both bath tubs and showers in accessible units; and (6) providing accessible shower chairs.

Response. The Board based the requirement for 5% accessible rooms on Board sponsored research which provided that 1,341,000 individuals are reported to use a wheelchair and/or walker (National Health Institute Services, Home Care Supplement: 1980); and 5,191,000 individuals have other mobility impairments (Bureau of Census, Disability Functional Limitation and Insurance coverage: 1984-85). While the statistics provided by AHMA and others in the lodging industry would suggest a much lower percentage of 1%, the comments received from individuals with disabilities and their organizations were overwhelmingly in favor of a higher percentage citing instances where

no rooms or an insufficient number of rooms were available, thus making travel difficult or impossible for individuals with disabilities. The Board took note of a voluntary standard approved by the AHMA Executive Engineers Committee and published by both AHMA and the Paralyzed Veterans of America. The standard proposed a 2% to 4% criteria for the number of accessible guest rooms in newly constructed hotels and motels (An Interpretation of ANSI A117.1 (1986) The American National Standard for Buildings and Facilities—Providing Accessibility and Usability for Physically Handicapped People as applicable to New Hotels and Motels).

Taking into consideration the additional statistics provided by AHMA regarding the percentage of people who travel as well the response from individuals with disabilities and their organizations regarding the difficulty experienced in traveling and the overwhelmingly favorable response to requiring a roll-in shower, the Board revised this section to provide that accessible sleeping rooms and roll-in showers in compliance with 9.2, 4.21 and Figure 57 shall be provided on a sliding scale in accordance with the table in 9.1.2. The table provides for 4% of the first 100 rooms to be accessible, decreasing to 20 accessible rooms in a facility with 1000 rooms, plus 1% for each 100 over that 1000. The table also provides that in facilities with over 50 rooms, 1% of the rooms shall have roll-in showers.

9.1.3 Sleeping Accommodations for Persons with Hearing Impairments

Comment. A number of commenters misunderstood the provisions relating to the number of rooms which must comply with section 9.3 (Visual Alarms, Notification Devices, and Telephones). Many did not understand that the requirement that a number of rooms must comply with 9.3 was in addition to those required to comply with 9.2.

Response. The Board has revised the language to clearly reflect that the provision for sleeping accommodations for persons with hearing impairments is in addition to the accessible room requirements for section 9.2.

Comment. As with 9.1.2, there was strong support from individuals with disabilities and their organizations in support of accessible rooms for people with hearing impairments, and strong objections from the business community over the basis for requiring 5%. The lodging industry based its objections on statistics cited by the Board in its preamble which provide that 1,741,000 individuals are deaf in both ears

(National Institute on Disability and Rehabilitation Research, Data on Disability from the National Health Interview Survey: 1983) and the US Travel Data Center statistics which found that 65% of all US residents take one or more trips for business or pleasure at least 100 miles away from home each year. Using these statistics, the result would be .7% travelers. The lodging industry suggested that 1% would be a more appropriate requirement.

Response. In the preamble to the proposed guidelines, the Board also cited the Bureau of Census statistics which stated that 7,694,000 individuals have difficulty hearing what is said in a normal conversation with another person, including those who cannot hear at all (Bureau of Census, Disability Functional Limitation and Insurance Coverage: 1984-85). The Board further pointed out that an analysis of demographic data reveals there are at least as many persons with hearing impairments as there are persons with mobility impairments. Other studies indicate that a greater percentage of individuals have a hearing impairment (i.e., the National Center for Health Statistics found a 7.9 percent rate, National Health Interview Survey, 1979-80). Based on that data and the ADA's mandate that the Board provide greater guidance with respect to communication accessibility, the proposed guidelines required compliance with section 9.3 for an additional number of rooms equal to that required to comply with section 9.2. Taking into consideration the statistical data provided by the AHMA regarding the percentage of travelers as discussed in 9.1.2 above, the Board has revised this section to provide that in addition to those accessible sleeping rooms and suites required by 9.1.2, sleeping rooms which comply with 9.3 shall be provided in conformance with the table in 9.1.3. That table provides for 4% of the first 100 rooms to comply with 9.3, decreasing to 20 accessible rooms in a facility with 1000 rooms, plus 1% for each 100 over that 1000.

9.1.4 Classes of Sleeping Accommodations

Comment. The majority of the comments received from individuals with disabilities and their organizations suggested that "class" should take into consideration price, the size of the room (i.e. number of beds) and the various amenities and features provided. Two commenters from the building code group/state access agency category suggested that in lieu of using the term "class" it would be preferable to require that the rooms be dispersed throughout

the facility to ensure that a person with a disability the fullest range of room reservations available to the general public.

The lodging industry urged the use of the "standard industry classification" to define "class": (a) Standard rooms; (b) premium rooms (where a distinctly different level of service is provided); (c) suites (all types). Use of this classification would take into consideration the size of the room, amenities and features and, indirectly, price.

Response. In order to provide persons with disabilities with a range of options which are available to others, the Board has revised this section to provide that the rooms will be dispersed among the various classes of sleeping accommodations available. Factors to be considered in determining the various classes include room size, cost, amenities provided, and the number of beds provided.

The Board added a provision for equivalent facilitation to this section which allows the operator of a facility to limit construction of accessible rooms to those intended for multiple occupancy, provided that such rooms are made available to those who request a single occupancy room at the cost of a single occupancy room. This provision allows for more flexibility in the distribution of accessible rooms for the operator of a facility and provides accessible rooms for those who request a single occupancy room and rate.

9.1.5 Alterations to Accessible Units, Sleeping Rooms, and Suites

The Board took the position that a section on alterations specifically for transient lodging was appropriate for the reason that there are a number of problems peculiar to hotels, which regularly implement a seven or eight year cycle of alterations. For instance, if a percentage of rooms is required to be accessible and the hotel later alters a non-accessible room, a question is raised as to whether to make that room an accessible room or that element an accessible element, and as to how this would apply to wings of hotels. Accordingly, the Board has added a paragraph to section 9 which provides requirements for accessibility when sleeping rooms or a portion of the rooms are altered in an existing facility. The guidelines provide that where alterations occur, at least one sleeping room or suite that complies with the requirement of 9.2 (Requirements for Accessible Units, Sleeping Rooms, and Suites) shall be provided for each 25 sleeping rooms, or fraction thereof, of

rooms being altered until the number of such rooms provided equals the number required to be accessible by 9.1.2. For each 25 sleeping rooms, or fraction, of rooms being altered, at least one sleeping room or suite that complies with the requirement of 9.3 (Visual Alarms, Notification Devices, and telephones) shall be provided until the number of such rooms equals the number required to be accessible by 9.1.3. For further discussion regarding alteration requirements which directly affect transient lodging, see 4.1.6 (Accessible Buildings: Alterations).

9.2 Requirements for Accessible Units, Sleeping Rooms and Suites

9.2.1 General

This section provides that units, sleeping rooms and suites required to be accessible by 9.1 shall comply with 9.2.

No comments were received for this section and the Board has not made any changes.

9.2.2 Minimum Requirements

This section provides the minimum requirements for accessible units, sleeping rooms and suites.

Maneuvering Space (9.2.2(1))

This section requires a maneuvering space of 36 inches clear width located along both sides of a bed, except that where two beds are provided, this requirement can be met by providing a 36 inches wide maneuvering space located between the two beds.

Comment. The Board sought comments on whether maneuvering space should be required along both sides of a bed to accommodate individuals who use wheelchairs and can transfer from a wheelchair to a bed from only one side. The results were divided among individuals with disabilities and their organizations and the business organizations. Individuals with disabilities and their organizations, government agencies involved with disability issues and other government agencies overwhelmingly supported the provision of maneuvering space on both sides of a bed. The lodging industry however, overwhelmingly took the opposite position based on the reasoning that the maneuvering clearances required by section 9.2.2(1) allow forward or reverse approach, thus permitting side access from either the right or the left.

Response. Because an individual can transfer from the left or the right as a result of the ability to go forward or reverse, does not mean that the individual can also turn themselves around 180 degrees to be at one end of

the bed or the other. Thus, such an individual would not be able to utilize amenities provided such as television or necessities such as telephones. For this reason, the forward and reverse argument of the lodging industry was not acceptable.

The Board took the position that a maneuvering space should be required on both sides of a bed and that a 36 inches clear width maneuvering space was appropriate. Where two beds are provided, the requirement is met by providing the maneuvering space between the two beds.

Accessible Route (9.2.2(2))

This section requires that an accessible route complying with 4.3 connect all accessible spaces and elements including telephones within the unit. This does not require an elevator in multi-story units as long as the spaces identified in 9.2.2 (6) and (7) are on accessible levels and the accessible sleeping area is suitable for dual occupancy.

Comment. One commenter suggested that the route should be required into and through the unit. This latter was reference to HUD's guidelines which provides in 24 CFR 100.205(c)(3)(ii) that there shall be an accessible route into and through the covered dwelling.

The lodging industry noted that there are a number of transient lodging facilities that have types of sleeping accommodations or dwelling units that are multi-story or split level. They took the position that vertical access should not be required to each story or level as long as all primary functions are available on accessible levels.

Response. To require an accessible route into and through each multi-story unit would be cost prohibitive unless the occupant exited their living space into a common area, used public use elevator, and reentered the unit from a different level at great inconvenience to the occupant.

The final guidelines address the concerns of the lodging industry and clarify that it is not the Board's intent to require vertical access to each story or level. However, this is provided that the spaces identified in 9.2.2 (6) and (7) are on accessible levels and are suitable for dual occupancy.

Doors (9.2.2(3))

This section requires that doors and doorways designed to allow passage into and within all sleeping rooms, suites or other covered units shall comply with 4.13.

Comment. The AHMA and other members of the lodging industry took the position that the Board should not

require doors to non-usable space to be accessible.

Response. The response from individuals with disabilities and their organizations was overwhelmingly in favor of this requirement. Many individuals with disabilities stated that rooms not required to be fully accessible would still be usable by some if they were able to enter the doorways. For instance, if the doorways are accessible, individuals with varying mobility impairments may be able to use a room that does not have grab bars or a room that does not have maneuvering space.

The legislative history of the ADA states that, with respect to hotels, accessibility includes "requiring all doors and doorways designed to allow passage into and within all hotel rooms and bathrooms to be sufficiently wide to allow passage by individuals who use wheelchairs." H. Rept. 101-485, pt. 2, at 118. The Board retained this provision with no changes.

Storage (9.2.2(4))

This section requires that if fixed or built-in storage facilities such as cabinets, shelves, closets, and drawers are provided in accessible spaces, at least one of each type provided shall contain storage space complying with 4.25. Additional storage may be provided outside those dimensions.

Comment. The majority of the comments on this section were from the lodging industry, who suggested that the accessible rooms should also be usable by other than disabled guests. This could be accomplished they suggested, by such practices as installing two door viewers, two clothes closet rods—one at an "accessible" height and one at a standard height.

Response. The Board has addressed the concerns of the lodging industry by clarifying that as long as the minimum requirements are met, additional storage may be provided outside the dimensions required in 4.25.

Controls (9.2.2(5))

This section provides that all controls shall comply with 4.27. No changes were made to this section.

Accessible Areas (9.2.2(6))

This section requires that where provided the following shall be accessible and on an accessible route:

- The living area;
- the dining area;
- at least one sleeping area;
- patios, terraces or balconies;
- at least one full bathroom;
- if only half baths are provided, at least one half bath, and
- garports, garages or parking spaces.

Of the comments received on transient lodging, the majority concerned this section. The comments mainly focused on two areas—(d) patios and terraces; and (e) the bathroom area. Those areas are addressed below.

Patios, Terraces and Balconies (9.2.2(6)(d))

Comment. One commenter objected to this provision as it placed an unreasonable restraint on exterior architecture and window/door systems. The AHMA and others in the lodging industry however, were almost unanimous in their opposition to this requirement due to weather protection needs at ocean side resort property and other areas subject to high wind and water damage from hurricanes and storms which result in door sills higher than ½ inch.

Response. The Board understands the need to protect the integrity of the unit from water and weather damage and that many local building codes require higher door thresholds or a change in the level of the balcony to prevent structural damage from water. The Board also recognizes that to provide for higher thresholds or a change in level would, in all probability, eliminate the use of a balcony or deck area by individuals with disabilities. The final guidelines therefore provide that the requirements of 4.13.8 (Thresholds at Doorways) and 4.3.8 (Changes in Level) do not apply where it is necessary to utilize a higher door threshold or a change in level to protect the integrity of the unit from wind and water damage. The final guidelines also provide that where the exception to 4.13.8 and 4.3.8 would result in an inaccessible route to patios, terraces or balconies, that equivalent facilitation shall be provided. Equivalent facilitation at a hotel patio or balcony might consist of providing raised decking or a ramp to achieve accessibility.

Bathrooms (9.2.2(6)(e))

Comment. The responses to this paragraph were primarily from the disability community and focused on the need for accessible showers.

Response. The Board has responded to the issue of a roll-in shower under section 9.1.2 (Accessible Units, Sleeping Rooms, and Suites) and has included a requirement for a roll-in shower based on a sliding scale.

Kitchens, Kitchenettes, or Wet Bars (9.2.2(7))

This section provides for minimum requirements when kitchens, kitchenettes or wet bars are provided as accessory to a sleeping room or suite.

Comment. The AHMA and other commenters from the lodging industry urged the Board to reduce the requirement that 50% of the shelf space shall be accessible to 20% due to conventional design and cabinet fabrication practices.

Response. The Board considered the position of the lodging industry, however no further data was submitted in support of this position. The Board is of the opinion that current conventional design and fabrication practices are available which allow for the provision of 50% accessibility.

Comment. The AHMA and others in the lodging industry also expressed concern that many appliances are not manufactured with controls which are accessible according to 4.27 (such as coffee makers, toasters, microwave ovens, and other appliances).

Response. Under the ADA, the Board has jurisdiction to provide guidelines for built in appliances—not items such as toasters and coffee makers. Those items are therefore not addressed in the guidelines. Although portable devices are allowed under equivalent facilitation, the guidelines do not prescribe the features or controls of such devices. The Board does propose to address the issue of such appliances in the ADA manual.

9.3 Sleeping Room Accommodations for Persons with Hearing Impairments

9.3.1 General.

These requirements were enumerated in paragraph 9.3 of the proposed guidelines. The final guidelines address this area in 9.3.1. This section specifies the features which must be provided in units, sleeping rooms, or suites required to accommodate persons with hearing impairments. Visual alarms which comply with 4.28.4 must be provided. Visual notification devices which alert room occupants of incoming telephone calls and a door knock or bell must also be provided. The visual notification device may not be connected to visual alarm signal appliances. If a permanently installed telephone is provided, it shall have a volume control. An accessible electrical outlet within 4 feet of a telephone connection shall be provided to facilitate the use of a text telephone.

Comment. The disability groups generally supported the requirements of this provision. The comments suggested additional considerations which primarily involved the provision of portable devices. Members of the lodging industry took the position that guests could provide their own

notification devices and that only electrical outlets should be required.

In the PRM, the Board noted the availability of both portable and built-in visual alarms and visual notification devices. The Board sought information on the effectiveness and usability of portable devices as compared to built-in devices.

Generally, individuals with disabilities and their organizations were divided on which was preferable. In all, 25% of the comments (the majority of which were from the disability community) preferred built-in devices while 23% of the comments (the majority of which were from the disability community) preferred portable devices; 12% of the comments stated that portable devices were acceptable; 2% of the comments supported the use of portable devices when built-in devices are not available; 5% of the comments opposed the use of portable devices; and 18% of the comments supported the use of both.

The lodging industry took the position that if it was the intent of the guidelines to use portable devices only when they can be activated by a building alarm system then permanent devices will be required due to the lack of availability of such a portable system. The lodging industry stated that permanent devices will result in excessive costs and less flexibility in room selections.

Response. The guidelines require that auxiliary visual alarms shall be provided and comply with 4.28.4. Visual notification devices shall also be provided to alert room occupants of incoming telephone calls and a door knock or bell. The guidelines do allow for equivalent facilitation which requires the installation of electrical outlets and telephone wiring in order to enable the use of portable visual alarms and communications devices provided by the operator of the facility.

9.4 Other Sleeping Rooms and Suites

This section provides that doors and doorways designed to allow passage into and within all sleeping units or other covered units shall comply with 4.13.5.

Comment. The responses from individuals with disabilities and their organizations were overwhelmingly in favor of the accessibility of all doors and doorways. Responses from the lodging industry however, were overwhelmingly against this provision arguing that accessible doors should not be required to non-usable units as it is an undue burden without proven demand. Comments from the lodging industry cite the incurring of

extraordinary costs by necessitating greater square footage in guest rooms and bathrooms to accommodate door swings and clearance. As for existing buildings which are altered, the industry commenters argued that it would be prohibitively expensive and architecturally or structurally impractical. The industry further took the position that the 32-inch minimum clearance should apply only to the guestroom entrance doors and only in new construction.

Response. Comments from individuals with disabilities however, frequently identified situations where a standard room could be used if it has an accessible entrance and bathroom doors.

The legislative history of the ADA states that, with respect to hotels, accessibility includes "requiring all doors and doorways designed to allow passage into and within all hotel rooms and bathrooms to be sufficiently wide to allow passage by individuals who use wheelchairs." H. Rept. 101-485, pt. 2, at 118.

The Board retained this provision with no changes.

9.5 Transient Lodging in Homeless Shelters, Halfway Houses, Transient Group Homes, and other Social Services Establishments

The Board received few comments specifically from organizations who were advocates for the homeless, however overall the comments received on this section from individuals with disabilities, disability groups and the business community generally expressed a sensitivity to the issues of cost and availability and the needs of those who are homeless.

9.5.1 New Construction

This section provides that in new construction all public use and common use areas are required to comply with section 4. At least one of each type of amenity in each common area shall be accessible and shall be located on an accessible route to any accessible unit or sleeping accommodation.

Comment. The Board sought comment on whether it is necessary or appropriate to require at least one of every amenity to be accessible in each of the common areas. The majority of the responses were from individuals with disabilities and their organizations. The responses were split on whether or not the Board should amend the proposed language to provide that at least one of each type of amenity be available in an accessible common area.

Response. The Board has retained the language of this provision without

change but has added a provision to acknowledge the elevator exception provided in section 4.1.3(5). Where elevators are not provided, as allowed in 4.1.3(5), accessible amenities are not required on inaccessible floors as long as one of each type is provided in common areas on accessible floors.

9.5.2 Alterations

This section was previously reserved in the NPRM. The Board recognized that unique problems may arise when homeless shelters and similar establishments are placed in existing facilities originally designed for different purposes. The Board sought comments on what scoping provisions should apply to homeless shelters. Factors to be considered are the needs of the population to be served, service availability, and the significant demand for these important and scarce facilities.

Comment. Approximately 25% of the commenters took the position that the scoping should be the same as in other transient lodging. Just over 10% suggested that the scoping should be less than that in transient lodging. Some commenters responded by urging the Board to consider the cost vs. usage issue and to be sensitive to the realization that the number of shelters may be limited by the standards. A few commenters suggested a proportion (5% to 10%) of the shelter space should be accessible.

Response. The Board is mindful of the considerations in assessing the appropriate scoping requirements for alterations in homeless shelters and sought comments concerning this issue. The responses, however did not provide sufficient information regarding the need and the impact of applying the guidelines developed for other transient lodging, such as hotel and motels, to homeless shelters.

The Board is concerned that without homeless shelters, the most vulnerable members of society, including those homeless people who are disabled, will be without shelter. The Board wishes to avoid guidelines which result in a shelter not opening or expanding or result in the closing of shelters which are out of compliance.

The Board intends to conduct further study of this issue. Until such research is completed and guidelines are adopted, the Board has provided interim minimum guidelines.

The guidelines provide the provisions of 9.5.3 (Accessible Sleeping Accommodations in New Construction) and 9.1.5 (Alterations to Accessible Units, Sleeping Rooms, and Suites) shall apply to sleeping rooms and beds in social service establishments which are

not homeless shelters and the alterations of other areas in such establishments shall be consistent with the new construction provisions of 9.5.1 (New Construction).

In homeless shelters, where the following elements are altered, the following requirements apply: (a) at least one public entrance shall allow a person with mobility impairments to approach, enter and exit including a minimum clear door width of 32 inches; (b) sleeping space for homeless persons as provided in the scoping provision of 9.1.2 (Accessible Units, Sleeping Rooms, and Suites in Transient Lodging) shall include doors to the sleeping area with a minimum clear width of 32 inches and maneuvering space around the beds for persons with mobility impairments complying with 9.2.2(1); (c) at least one toilet room for each gender or one unisex toilet room shall have a minimum clear door width of 32 inches, minimum turning space complying with 4.2.3 (Wheelchair Turning Space), one water closet complying with 4.16 (Water Closets), one lavatory complying with 4.19 (Lavatories and Mirrors), and the door shall have a privacy latch and, if provided, at least one tub or shower shall comply with 4.20 (Bathtubs) or 4.21 (Shower Stalls) respectively; (d) at least one common area which a person with mobility impairments can approach, enter and exit including a minimum clear door width of 32 inches; (e) at least one route connecting elements (a), (b), (c) and (d) which a person with mobility impairments can use including minimum clear width of 36 inches, passing space complying with 4.3.4 (Passing Space) turning space complying with 4.2.3 (Wheelchair Turning Space) and changes in levels complying with 4.3.8 (Changes in Levels); and (f) homeless shelters can comply with the provisions of (a)-(e) by providing the above elements on one floor.

9.5.3 Accessible Sleeping Accommodations in New Construction

The Board previously reserved this section in the NPRM and sought comments on whether the Board should require 5% of sleeping accommodations to be fully accessible, with an additional 2% for people with hearing impairments.

Comment. With respect to accessible sleeping rooms, approximately 50% of the responses supported requiring 5% of the sleeping rooms to be fully accessible.

Response. The Board is mindful of the desire to balance the need for accessibility in homeless shelters versus the impact of additional construction requirements. In the section on transient

lodging for establishments such as hotels and motels, the Board adopted a sliding scale and it is the position of the Board that homeless shelters should not be held to more stringent scoping provisions. Accordingly, the scoping provisions for homeless shelters in new construction provide for accessible sleeping rooms in accordance with the table in 9.1.2 (Accessible Units, Sleeping Rooms, and Suites) and shall comply with 9.2 (Accessible Units, Sleeping Rooms and Suites) where such items are provided.

The Board recognizes that in some homeless shelters, the room or rooms contain a number of beds. In those instances, a percentage of the beds equal to the table provided in 9.1.2 shall comply with 9.2.2(1).

Comment. With respect to sleeping accommodations for persons with hearing impairments, approximately 25% of the responses favored requiring an additional 2% of the rooms to accommodate persons with hearing impairments. Approximately 50% of the commenters took the position that the 2% was too low. A number of commenters suggested that 9.5.3 should be consistent with the requirements for hotels, motels and other similar establishments.

Response. As in the requirements for accessible sleeping rooms in homeless shelters, the Board took the position that scoping provisions equal to those applicable to hotels, motels and similar establishments were appropriate. The guidelines provide that in addition to the rooms required to comply with the table in 9.1.2 (Accessible Units, Sleeping Rooms, and Suites), sleeping rooms that comply with 9.3 (Visual Alarms, Notification Devices and Telephones) shall be provided in accordance with the table in 9.1.3 (Sleeping Accommodations for Persons with Hearing Impairments).

10. Transportation Facilities [Reserved]

Regulatory Process Matters

The guidelines are issued to assist the Department of Justice to establish accessibility standards for new construction and alterations in places of public accommodation and commercial facilities as required by title III of the ADA. The Department of Justice has proposed to incorporate the guidelines in its final regulations as the accessibility standards for purposes of title III of the ADA. The guidelines thus meet the criteria for a major rule under Executive Order 12291 and have been reviewed by the Office of Management and Budget.

The Board has prepared a draft final regulatory impact analysis (RIA) of the

guidelines. The draft final RIA is available for public comment. The Board will provide copies of the document to the public upon request. The public is encouraged to provide additional information as to the costs and benefits associated with the guidelines. Comments on costs and benefits that are received within 60 days of publication of these guidelines will be analyzed in the final RIA which will be completed by January 1, 1992.

Accessibility does not generally add features to a building or facility but rather simply requires that features commonly provided have certain characteristics. Several studies discussed in the draft final RIA have shown that designing buildings and facilities to be accessible, from the conceptual phase onward, adds less than 1% to the total construction costs. The draft final RIA analyzes the cost impact of accessibility elements which have the potential of adding to the cost of a building or facility. Included in the analysis are: Areas of rescue assistance; parking (signage); curb ramps (detectable warnings); ramps (handrail extensions and edge protection); stairs (handrail extensions); elevators (raised characters on hoistway entrances, reopening devices, tactile and braille control indicators, and audible signage for car position); entrances (ramps); water closets and toilet stalls (grab bars); lavatories and sinks (insulation of hot water and drain pipes); bath tubs and shower stalls (seat, grab bars, and hand-held showers); alarms (visual systems); signage (tactile and braille characters); telephones (volume controls, text telephones, and signage); assembly areas (assistive listening systems); automated teller machines (equipment for persons with visual impairments); dressing and fitting rooms (curtained opening and swinging door); and roll-in showers and visual notification devices for accessible sleeping accommodations.

The draft final RIA also assesses the cost of space increases in certain building and facility types which are caused when accessible elements are repeated (e.g., accessible parking spaces in a parking lot and a parking garage; accessible patient bedrooms in a hospital and a nursing home). The element related costs are aggregated to estimate the costs for certain building types, including high-rise and low-rise office buildings, high-rise and low-rise hotels, auditoriums and movie theaters, parking lots and parking garages, and hospitals and nursing homes. For parking lots and parking garages, and hospitals and nursing homes, the aggregate costs also include the cost of

space increases. The draft final RIA also discusses the indirect costs of the accessibility elements such as maintenance, operation and opportunity costs. Space allocation and re-allocation issues are analyzed with respect to maneuvering space in corridors; the standard toilet stall versus the alternate toilet stall; check-out aisles; and areas of rescue assistance.

As for regulatory alternatives, section 504 of the ADA specifically requires that the guidelines "supplement the existing (MGRAD)" on which the current UFAS is based and "establish additional requirements, consistent with this Act, to ensure that buildings (and) facilities * * * are accessible, in terms of architecture and design, * * * and communication, to individuals with disabilities." The legislative history states that the guidelines may not "reduce, weaken, narrow, or set less accessibility standards than those included in existing MGRAD" and should provide greater guidance in the area of communication accessibility for individuals with hearing and visual impairments. As mandated by the statute, the final guidelines use MGRAD and UFAS as their base or floor. The draft final RIA discusses regulatory alternatives considered for major provisions which go beyond MGRAD and UFAS. These include provisions for accessible parking; areas of rescue assistance; volume controls for public telephones; text telephones; detectable warnings; assistive listening systems; signage; and automated teller machines.

The draft final RIA also contains information that would be included in a final regulatory flexibility analysis under the Regulatory Flexibility Act and the final RIA will serve as the final regulatory flexibility analysis. The extensive notice and public comment procedure followed by the Board in the promulgation of these guidelines, which included public hearings, dissemination of materials, and provision of speakers to affected groups, clearly provided any interested small entities with the notice and opportunity for comment provided under the Regulatory Flexibility Act procedures.

The Board wishes to point out that Congress amended the Internal Revenue Code in 1990 to facilitate compliance by small entities with the ADA. Under section 44 of the Internal Revenue Code, as amended, eligible small businesses can receive a tax credit for certain costs of compliance with the ADA. An eligible small business is one whose gross receipts do not exceed \$1,000,000 or whose workforce does not consist of more than 30 full-time workers.

Qualifying businesses may claim a credit of up to 50 percent of eligible access expenditures that exceed \$250 but do not exceed \$10,250. Examples of eligible access expenditures include the necessary and reasonable costs of removing barriers, providing auxiliary aids, and acquiring or modifying equipment or devices. Section 190 of the Internal Revenue Code, as amended, also provides for a deduction of up to \$15,000 per year for expenses associated with the removal of qualified architectural and transportation barriers for any entity, regardless of size.

The guidelines do not preempt State and local regulation of the construction and alteration of places of public accommodation and commercial facilities. Section 308(b)(1)(A)(ii) of the ADA permits State and local governments to apply to the Attorney General for certification that a State or local code meets or exceeds the

accessibility requirements of the ADA. Therefore, a Federalism assessment has not been prepared under Executive Order 12612.

The guidelines are effective immediately so that they can be incorporated in the Department of Justice's final regulations. The Department of Justice's final regulations will establish the effective date for the accessibility standards.

List of Subjects in 36 CFR Part 1191

Buildings, Civil rights, Handicapped, Individuals with disabilities.

Authorized by vote of the Board on July 1 and 12, 1991.

William H. McCabe,

Chairman, Architectural and Transportation Barriers Compliance Board.

For the reasons set forth in the preamble, the Board adds part 1191 to

title 36 of the Code of Federal Regulations to read as follows:

PART 1191—AMERICANS WITH DISABILITIES ACT (ADA) ACCESSIBILITY GUIDELINES FOR BUILDINGS AND FACILITIES

Sec.

1191.1 Accessibility guidelines.

Appendix to part 1191—Americans With Disabilities Act (ADA) Accessibility Guidelines for Buildings and Facilities.

Authority: Americans With Disabilities Act of 1990, Pub. L. 101-336, 42 U.S.C. 12204.

§ 1191.11 Accessibility guidelines.

The accessibility guidelines for buildings and facilities for purposes of the Americans With Disabilities Act are found in the appendix to this part. The guidelines are issued to assist the Department of Justice to establish accessibility standards to implement the legislation.

BILLING CODE 8150-01-M

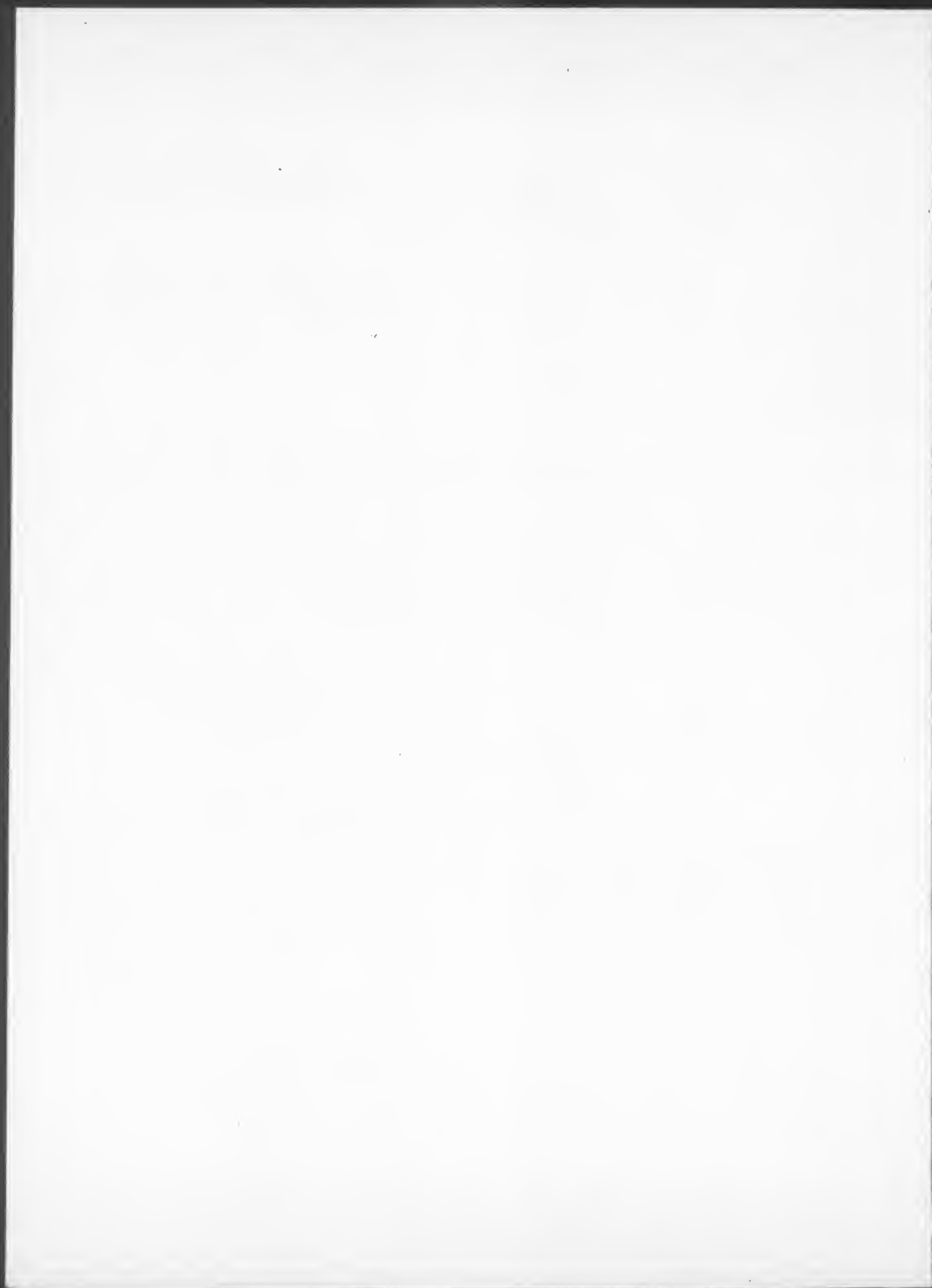

Appendix to Part 1191—Americans With Disabilities Act (ADA) Accessibility Guidelines for Buildings and Facilities

Americans with Disabilities Act (ADA)

Accessibility Guidelines for Buildings and Facilities

U.S. Architectural & Transportation Barriers
Compliance Board
1111 18th Street, N.W., Suite 501
Washington, D.C. 20036-3894
(202) 653-7834 v/TDD
(202) 653-7863 FAX

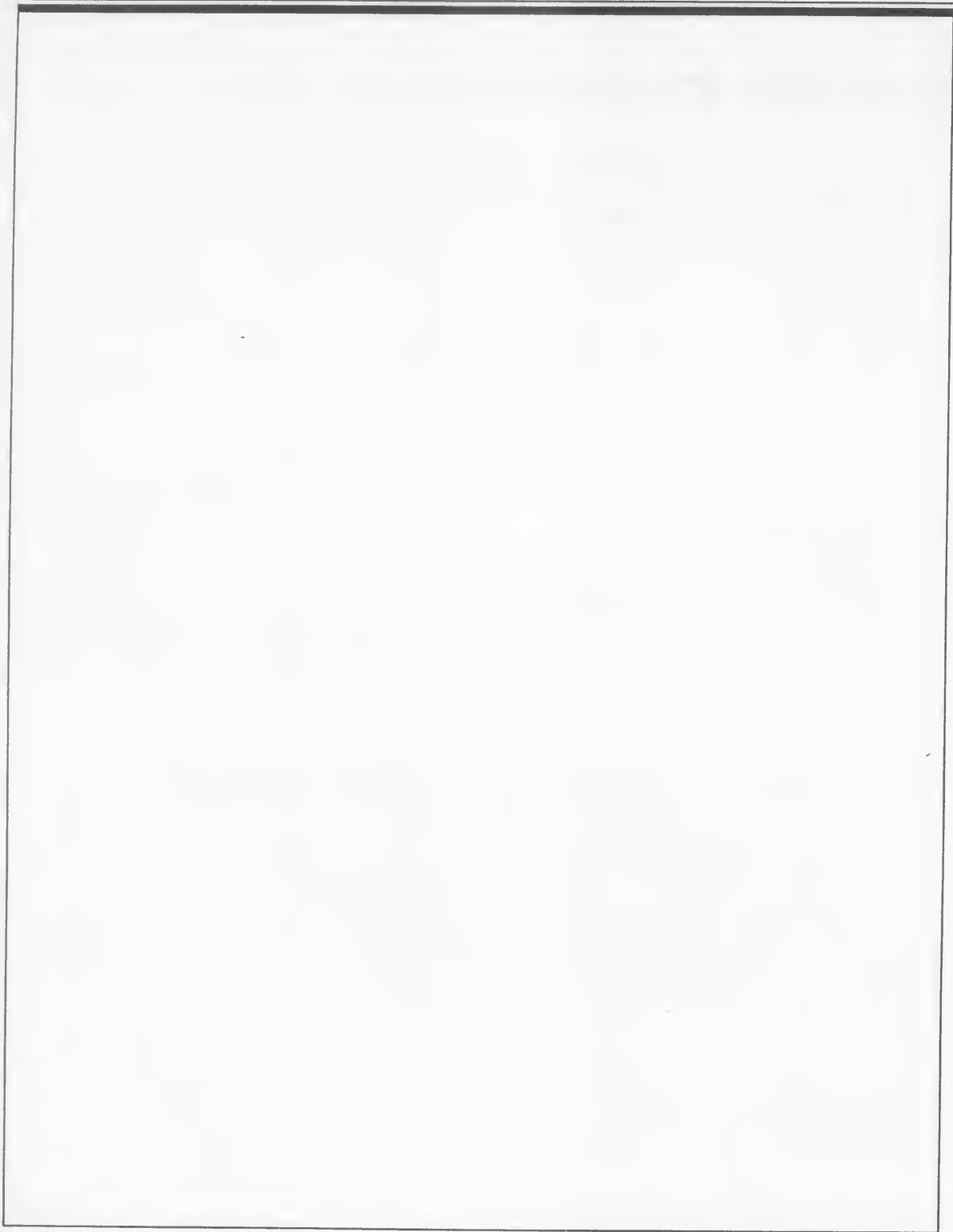

**ADA ACCESSIBILITY GUIDELINES
FOR BUILDINGS AND FACILITIES
TABLE OF CONTENTS**

| | |
|--|----------|
| 1. PURPOSE | 1 |
| 2. GENERAL | 1 |
| 2.1 Provisions for Adults | 1 |
| 2.2 Equivalent Facilitation | 1 |
| 3. MISCELLANEOUS INSTRUCTIONS AND DEFINITIONS | 1 |
| 3.1 Graphic Conventions | 1 |
| 3.2 Dimensional Tolerances | 2 |
| 3.3 Notes | 2 |
| 3.4 General Terminology | 2 |
| 3.5 Definitions | 2 |
| 4. ACCESSIBLE ELEMENTS AND SPACES: SCOPE AND TECHNICAL REQUIREMENTS | 5 |
| 4.1 Minimum Requirements | 5 |
| 4.1.1. Application | 5 |
| 4.1.2. Accessible Sites and Exterior Facilities: New Construction | 5 |
| 4.1.3. Accessible Buildings: New Construction | 7 |
| 4.1.4. (Reserved) | 10 |
| 4.1.5. Accessible Buildings: Additions | 10 |
| 4.1.6. Accessible Buildings: Alterations | 11 |
| 4.1.7. Accessible Buildings: Historic Preservation | 13 |
| 4.2 Space Allowance and Reach Ranges | 14 |
| 4.3 Accessible Route | 15 |
| 4.4 Protruding Objects | 21 |
| 4.5 Ground and Floor Surfaces | 22 |
| 4.6 Parking and Passenger Loading Zones | 24 |
| 4.7 Curb Ramps | 26 |
| 4.8 Ramps | 27 |
| 4.9 Stairs | 30 |
| 4.10 Elevators | 30 |

| | |
|--|-----------|
| 4.11 Platform Lifts (Wheelchair Lifts) | 36 |
| 4.12 Windows | 36 |
| 4.13 Doors | 36 |
| 4.14 Entrances | 40 |
| 4.15 Drinking Fountains and Water Coolers | 40 |
| 4.16 Water Closets | 40 |
| 4.17 Toilet Stalls | 41 |
| 4.18 Urinals | 44 |
| 4.19 Lavatories and Mirrors | 44 |
| 4.20 Bathtubs | 45 |
| 4.21 Shower Stalls | 45 |
| 4.22 Toilet Rooms | 45 |
| 4.23 Bathrooms, Bathing Facilities, and Shower Rooms | 48 |
| 4.24 Sinks | 49 |
| 4.25 Storage | 49 |
| 4.26 Handrails, Grab Bars, and Tub and Shower Seats | 50 |
| 4.27 Controls and Operating Mechanisms | 51 |
| 4.28 Alarms | 52 |
| 4.29 Detectable Warnings | 53 |
| 4.30 Signage | 53 |
| 4.31 Telephones | 54 |
| 4.32 Fixed or Built-in Seating and Tables | 56 |
| 4.33 Assembly Areas | 56 |
| 4.34 Automated Teller Machines | 58 |
| 4.35 Dressing and Fitting Rooms | 58 |
| | |
| 5. RESTAURANTS AND CAFETERIAS | 59 |
| | |
| 6. MEDICAL CARE FACILITIES | 60 |
| | |
| 7. BUSINESS AND MERCANTILE | 61 |
| | |
| 8. LIBRARIES | 62 |
| | |
| 9. ACCESSIBLE TRANSIENT LODGING | 63 |
| | |
| 10. TRANSPORTATION FACILITIES | 67 |
| | |
| APPENDIX | A1 |

1. PURPOSE.

This document sets guidelines for accessibility to places of public accommodation and commercial facilities by individuals with disabilities. These guidelines are to be applied during the design, construction, and alteration of such buildings and facilities to the extent required by regulations issued by Federal agencies, including the Department of Justice, under the Americans with Disabilities Act of 1990.

The technical specifications 4.2 through 4.35, of these guidelines are the same as those of the American National Standard Institute's document A117.1-1980, except as noted in this text by italics. However, sections 4.1.1 through 4.1.7 and sections 5 through 10 are different from ANSI A117.1 in their entirety and are printed in standard type.

The illustrations and text of ANSI A117.1 are reproduced with permission from the American National Standards Institute. Copies of the standard may be purchased from the American National Standards Institute at 1430 Broadway, New York, New York 10018.

2. GENERAL.





2.1 Provisions for Adults. *The specifications in these guidelines are based upon adult dimensions and anthropometrics.*

2.2* Equivalent Facilitation. *Departures from particular technical and scoping requirements of this guideline by the use of other designs and technologies are permitted where the alternative designs and technologies used will provide substantially equivalent or greater access to and usability of the facility.*

3. MISCELLANEOUS INSTRUCTIONS AND DEFINITIONS.

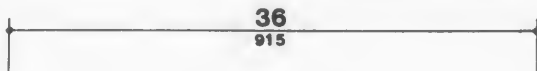
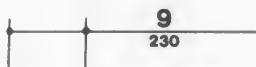
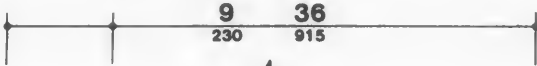
3.1 Graphic Conventions. Graphic conventions are shown in Table 1. Dimensions that are not marked minimum or maximum are absolute, unless otherwise indicated in the text or captions.

Table 1
Graphic Conventions

| Convention | Description |
|---|--|
|  | Typical dimension line showing U.S. customary units (in inches) above the line and SI units (in millimeters) below |
|  | Dimensions for short distances indicated on extended line |
|  | Dimension line showing alternate dimensions required |
|  | Direction of approach |
| max | Maximum |
| min | Minimum |
|  | Boundary of clear floor area |
|  | Centerline |

3.4 General Terminology

3.2 Dimensional Tolerances. All dimensions are subject to conventional building industry tolerances for field conditions.

3.3 Notes. The text of *these guidelines* does not contain notes or footnotes. Additional information, explanations, and advisory materials are located in the Appendix. Paragraphs marked with an asterisk have related, non-mandatory material in the Appendix. In the Appendix, the corresponding paragraph numbers are preceded by an A.

3.4 General Terminology.

comply with. Meet one or more specifications of *these guidelines*.

if, if... then. Denotes a specification that applies only when the conditions described are present.

may. Denotes an option or alternative.

shall. Denotes a mandatory specification or requirement.

should. Denotes an advisory specification or recommendation.

3.5 Definitions.

Access Aisle. An accessible pedestrian space between elements, such as parking spaces, seating, and desks, that provides clearances appropriate for use of the elements.

Accessible. Describes a site, building, facility, or portion thereof that complies with *these guidelines*.

Accessible Element. An element specified by *these guidelines* (for example, telephone, controls, and the like).

Accessible Route. A continuous unobstructed path connecting all accessible elements and spaces of a building or facility. Interior accessible routes may include corridors, floors, ramps, elevators, lifts, and clear floor space at fixtures. Exterior accessible routes may include parking access aisles, curb ramps, *crosswalks at vehicular ways*, walks, ramps, and lifts.

Accessible Space. Space that complies with *these guidelines*.

Adaptability. The ability of certain building spaces and elements, such as kitchen counters, sinks, and grab bars, to be added or altered so as to accommodate the needs of *individuals with or without disabilities* or to accommodate the needs of persons with different types or degrees of disability.

Addition. An expansion, extension, or increase in the gross floor area of a building or facility.

Administrative Authority. A governmental agency that adopts or enforces regulations and *guidelines* for the design, construction, or alteration of buildings and facilities.

Alteration. An alteration is a change to a building or facility made by, on behalf of, or for the use of a public accommodation or commercial facility, that affects or could affect the usability of the building or facility or part thereof. Alterations include, but are not limited to, remodeling, renovation, rehabilitation, reconstruction, historic restoration, changes or rearrangement of the structural parts or elements, and changes or rearrangement in the plan configuration of walls and full-height partitions. Normal maintenance, reroofing, painting or wallpapering, or changes to mechanical and electrical systems are not alterations unless they affect the usability of the building or facility.

Area of Rescue Assistance. An area, which has direct access to an exit, where people who are unable to use stairs may remain temporarily in safety to await further instructions or assistance during emergency evacuation.

Assembly Area. A room or space accommodating a group of individuals for recreational, educational, political, social, or amusement purposes, or for the consumption of food and drink.

Automatic Door. A door equipped with a power-operated mechanism and controls that open and close the door automatically upon receipt of a momentary actuating signal. The switch that begins the automatic cycle may be a photoelectric device, floor mat, or manual switch (see power-assisted door).

3.5 Definitions

Building. Any structure used and intended for supporting or sheltering any use or occupancy.

Circulation Path. An exterior or interior way of passage from one place to another for pedestrians, including, but not limited to, walks, hallways, courtyards, stairways, and stair landings.

Clear. Unobstructed.

Clear Floor Space. The minimum unobstructed floor or ground space required to accommodate a single, stationary wheelchair and occupant.

Closed Circuit Telephone. A telephone with dedicated line(s) such as a house phone, courtesy phone or phone that must be used to gain entrance to a facility.

Common Use. Refers to those interior and exterior rooms, spaces, or elements that are made available for the use of a restricted group of people (for example, occupants of a homeless shelter, the occupants of an office building, or the guests of such occupants).

Cross Slope. The slope that is perpendicular to the direction of travel (see running slope).

Curb Ramp. A short ramp cutting through a curb or built up to it.

Detectable Warning. A standardized surface feature built in or applied to walking surfaces or other elements to warn visually impaired people of hazards on a circulation path.

Dwelling Unit. A single unit which provides a kitchen or food preparation area, in addition to rooms and spaces for living, bathing, sleeping, and the like. Dwelling units include a single family home or a townhouse used as a transient group home; an apartment building used as a shelter; guestrooms in a hotel that provide sleeping accommodations and food preparation areas; and other similar facilities used on a transient basis. For purposes of these guidelines, use of the term "Dwelling Unit" does not imply the unit is used as a residence.

Egress Means of. A continuous and unobstructed way of exit travel from any point in a building or facility to a public way. A means of egress comprises vertical and horizontal travel

and may include intervening room spaces, doorways, hallways, corridors, passageways, balconies, ramps, stairs, enclosures, lobbies, horizontal exits, courts and yards. An accessible means of egress is one that complies with these guidelines and does not include stairs, steps, or escalators. Areas of rescue assistance or evacuation elevators may be included as part of accessible means of egress.

Element. An architectural or mechanical component of a building, facility, space, or site, e.g., telephone, curb ramp, door, drinking fountain, seating, or water closet.

Entrance. Any access point to a building or portion of a building or facility used for the purpose of entering. An entrance includes the approach walk, the vertical access leading to the entrance platform, the entrance platform itself, vestibules if provided, the entry door(s) or gate(s), and the hardware of the entry door(s) or gate(s).

Facility. All or any portion of buildings, structures, site improvements, complexes, equipment, roads, walks, passageways, parking lots, or other real or personal property located on a site.

Ground Floor. Any occupiable floor less than one story above or below grade with direct access to grade. A building or facility always has at least one ground floor and may have more than one ground floor as where a split level entrance has been provided or where a building is built into a hillside.

Mezzanine or Mezzanine Floor. That portion of a story which is an intermediate floor level placed within the story and having occupiable space above and below its floor.

Marked Crossing. A crosswalk or other identified path intended for pedestrian use in crossing a vehicular way.

Multifamily Dwelling. Any building containing more than two dwelling units.

Occupiable. A room or enclosed space designed for human occupancy in which individuals congregate for amusement, educational or similar purposes, or in which occupants are engaged at labor, and which is equipped with means of egress, light, and ventilation.

3.5 Definitions

Operable Part. A part of a piece of equipment or appliance used to insert or withdraw objects, or to activate, deactivate, or adjust the equipment or appliance (for example, coin slot, pushbutton, handle).

Path of Travel. (Reserved).

Power-assisted Door. A door used for human passage with a mechanism that helps to open the door, or relieves the opening resistance of a door, upon the activation of a switch or a continued force applied to the door itself.

Public Use. Describes interior or exterior rooms or spaces that are made available to the general public. Public use may be provided at a building or facility that is privately or publicly owned.

Ramp. A walking surface which has a running slope greater than 1:20.

Running Slope. The slope that is parallel to the direction of travel (see cross slope).

Service Entrance. An entrance intended primarily for delivery of goods or services.

Signage. Displayed verbal, symbolic, tactile, and pictorial information.

Site. A parcel of land bounded by a property line or a designated portion of a public right-of-way.

Site Improvement. Landscaping, paving for pedestrian and vehicular ways, outdoor lighting, recreational facilities, and the like, added to a site.

Sleeping Accommodations. Rooms in which people sleep; for example, dormitory and hotel or motel guest rooms or suites.

Space. A definable area, e.g., room, toilet room, hall, assembly area, entrance, storage room, alcove, courtyard, or lobby.

Story. That portion of a building included between the upper surface of a floor and upper surface of the floor or roof next above. If such

portion of a building does not include occupiable space, it is not considered a story for purposes of these guidelines. There may be more than one floor level within a story as in the case of a mezzanine or mezzanines.

Structural Frame. The structural frame shall be considered to be the columns and the girders, beams, trusses and spandrels having direct connections to the columns and all other members which are essential to the stability of the building as a whole.

Tactile. Describes an object that can be perceived using the sense of touch.

Text Telephone. Machinery or equipment that employs interactive graphic (i.e., typed) communications through the transmission of coded signals across the standard telephone network. Text telephones can include, for example, devices known as TDD's (telecommunication display devices or telecommunication devices for deaf persons) or computers.

Transient Lodging. A building, facility, or portion thereof, excluding inpatient medical care facilities, that contains one or more dwelling units or sleeping accommodations. Transient lodging may include, but is not limited to, resorts, group homes, hotels, motels, and dormitories.

Vehicular Way. A route intended for vehicular traffic, such as a street, driveway, or parking lot.

Walk. An exterior pathway with a prepared surface intended for pedestrian use, including general pedestrian areas such as plazas and courts.

NOTE: Sections 4.1.1 through 4.1.7 are different from ANSI A117.1 in their entirety and are printed in standard type (ANSI A117.1 does not include scoping provisions).

4.0 Accessible Elements and Spaces: Scope and Technical Requirements**4. ACCESSIBLE ELEMENTS AND SPACES: SCOPE AND TECHNICAL REQUIREMENTS.****4.1 Minimum Requirements****4.1.1* Application.**

(1) General. All areas of newly designed or newly constructed buildings and facilities required to be accessible by 4.1.2 and 4.1.3 and altered portions of existing buildings and facilities required to be accessible by 4.1.6 shall comply with these guidelines, 4.1 through 4.35, unless otherwise provided in this section or as modified in a special application section.

(2) Application Based on Building Use. Special application sections 5 through 10 provide additional requirements for restaurants and cafeterias, medical care facilities, business and mercantile, libraries, accessible transient lodging, and transportation facilities. When a building or facility contains more than one use covered by a special application section, each portion shall comply with the requirements for that use.

(3)* Areas Used Only by Employees as Work Areas. Areas that are used only as work areas shall be designed and constructed so that individuals with disabilities can approach, enter, and exit the areas. These guidelines do not require that any areas used only as work areas be constructed to permit maneuvering within the work area or be constructed or equipped (i.e., with racks or shelves) to be accessible.

(4) Temporary Structures. These guidelines cover temporary buildings or facilities as well as permanent facilities. Temporary buildings and facilities are not of permanent construction but are extensively used or are essential for public use for a period of time. Examples of temporary buildings or facilities covered by these guidelines include, but are not limited to: reviewing stands, temporary classrooms, bleacher areas, exhibit areas, temporary banking facilities, temporary health screening services, or temporary safe pedestrian passageways around a construction site. Structures,

sites and equipment directly associated with the actual processes of construction, such as scaffolding, bridging, materials hoists, or construction trailers are not included.

(5) General Exceptions.

(a) In new construction, a person or entity is not required to meet fully the requirements of these guidelines where that person or entity can demonstrate that it is structurally impracticable to do so. Full compliance will be considered structurally impracticable only in those rare circumstances when the unique characteristics of terrain prevent the incorporation of accessibility features. If full compliance with the requirements of these guidelines is structurally impracticable, a person or entity shall comply with the requirements to the extent it is not structurally impracticable. Any portion of the building or facility which can be made accessible shall comply to the extent that it is not structurally impracticable.

(b) Accessibility is not required to (i) observation galleries used primarily for security purposes; or (ii) in non-occupiable spaces accessed only by ladders, catwalks, crawl spaces, very narrow passageways, or freight (non-passenger) elevators, and frequented only by service personnel for repair purposes; such spaces include, but are not limited to, elevator pits, elevator penthouses, piping or equipment catwalks.

4.1.2 Accessible Sites and Exterior Facilities: New Construction. An accessible site shall meet the following minimum requirements:

(1) At least one accessible route complying with 4.3 shall be provided within the boundary of the site from public transportation stops, accessible parking spaces, passenger loading zones if provided, and public streets or sidewalks, to an accessible building entrance.

(2) At least one accessible route complying with 4.3 shall connect accessible buildings, accessible facilities, accessible elements, and accessible spaces that are on the same site.

(3) All objects that protrude from surfaces or posts into circulation paths shall comply with 4.4.

4.1.2 Accessible Sites and Exterior Facilities: New Construction

(4) Ground surfaces along accessible routes and in accessible spaces shall comply with 4.5.

(5) (a) If parking spaces are provided for self-parking by employees or visitors, or both, then accessible spaces complying with 4.6 shall be provided in each such parking area in conformance with the table below. Spaces required by the table need not be provided in the particular lot. They may be provided in a different location if equivalent or greater accessibility, in terms of distance from an accessible entrance, cost and convenience is ensured.

| Total Parking in Lot | Required Minimum Number of Accessible Spaces |
|----------------------|--|
| 1 to 25 | 1 |
| 26 to 50 | 2 |
| 51 to 75 | 3 |
| 76 to 100 | 4 |
| 101 to 150 | 5 |
| 151 to 200 | 6 |
| 201 to 300 | 7 |
| 301 to 400 | 8 |
| 401 to 500 | 9 |
| 501 to 1000 | 2 percent of total |
| 1001 and over | 20 plus 1 for each 100 over 1000 |

Except as provided in (b), access aisles adjacent to accessible spaces shall be 60 in (1525 mm) wide minimum.

(b) One in every eight accessible spaces, but not less than one, shall be served by an access aisle 96 in (2440 mm) wide minimum and shall be designated "van accessible" as required by 4.6.4. The vertical clearance at such spaces shall comply with 4.6.5. All such spaces may be grouped on one level of a parking structure.

EXCEPTION: Provision of all required parking spaces in conformance with "Universal Parking Design" (see appendix A4.6.3) is permitted.

(c) If passenger loading zones are provided, then at least one passenger loading zone shall comply with 4.6.6.

(d) At facilities providing medical care and other services for persons with mobility impairments, parking spaces complying with 4.6 shall

be provided in accordance with 4.1.2(5)(a) except as follows:

(i) Outpatient units and facilities: 10 percent of the total number of parking spaces provided serving each such outpatient unit or facility;

(ii) Units and facilities that specialize in treatment or services for persons with mobility impairments: 20 percent of the total number of parking spaces provided serving each such unit or facility.

(e)*Valet parking: Valet parking facilities shall provide a passenger loading zone complying with 4.6.6 located on an accessible route to the entrance of the facility. Paragraphs 5(a), 5(b), and 5(d) of this section do not apply to valet parking facilities.

(6) If toilet facilities are provided on a site, then each such public or common use toilet facility shall comply with 4.22. If bathing facilities are provided on a site, then each such public or common use bathing facility shall comply with 4.23.

For single user portable toilet or bathing units clustered at a single location, at least 5% but no less than one toilet unit or bathing unit complying with 4.22 or 4.23 shall be installed at each cluster whenever typical inaccessible units are provided. Accessible units shall be identified by the International Symbol of Accessibility.

EXCEPTION: Portable toilet units at construction sites used exclusively by construction personnel are not required to comply with 4.1.2(6).

(7) Building Signage. Signs which designate permanent rooms and spaces shall comply with 4.30.1, 4.30.4, 4.30.5 and 4.30.6. Other signs which provide direction to, or information about, functional spaces of the building shall comply with 4.30.1, 4.30.2, 4.30.3, and 4.30.5. Elements and spaces of accessible facilities which shall be identified by the International Symbol of Accessibility and which shall comply with 4.30.7 are:

(a) Parking spaces designated as reserved for individuals with disabilities;

4.1.3 Accessible Buildings: New Construction

(b) Accessible passenger loading zones;

(c) Accessible entrances when not all are accessible (inaccessible entrances shall have directional signage to indicate the route to the nearest accessible entrance);

(d) Accessible toilet and bathing facilities when not all are accessible.

4.1.3 Accessible Buildings: New Construction. Accessible buildings and facilities shall meet the following minimum requirements:

(1) At least one accessible route complying with 4.3 shall connect accessible building or facility entrances with all accessible spaces and elements within the building or facility.

(2) All objects that overhang or protrude into circulation paths shall comply with 4.4.

(3) Ground and floor surfaces along accessible routes and in accessible rooms and spaces shall comply with 4.5.

(4) Interior and exterior stairs connecting levels that are not connected by an elevator, ramp, or other accessible means of vertical access shall comply with 4.9.

(5)* One passenger elevator complying with 4.10 shall serve each level, including mezzanines, in all multi-story buildings and facilities unless exempted below. If more than one elevator is provided, each full passenger elevator shall comply with 4.10.

EXCEPTION 1: Elevators are not required in facilities that are less than three stories or that have less than 3000 square feet per story unless the building is a shopping center, a shopping mall, or the professional office of a health care provider, or another type of facility as determined by the Attorney General. The elevator exemption set forth in this paragraph does not obviate or limit in any way the obligation to comply with the other accessibility requirements established in section 4.1.3. For example, floors above or below the accessible ground floor must meet the requirements of this section except for elevator service. If toilet or bathing facilities are provided on a level not served by an elevator, then toilet or bathing facilities must be provided on the accessible

ground floor. In new construction if a building or facility is eligible for this exemption but a full passenger elevator is nonetheless planned, that elevator shall meet the requirements of 4.10 and shall serve each level in the building. A full passenger elevator that provides service from a garage to only one level of a building or facility is not required to serve other levels.

EXCEPTION 2: Elevator pits, elevator penthouses, mechanical rooms, piping or equipment catwalks are exempted from this requirement.

EXCEPTION 3: Accessible ramps complying with 4.8 may be used in lieu of an elevator.

EXCEPTION 4: Platform lifts (wheelchair lifts) complying with 4.11 of this guideline and applicable state or local codes may be used in lieu of an elevator only under the following conditions:

(a) To provide an accessible route to a performing area in an assembly occupancy.

(b) To comply with the wheelchair viewing position line-of-sight and dispersion requirements of 4.33.3.

(c) To provide access to incidental occupiable spaces and rooms which are not open to the general public and which house no more than five persons, including but not limited to equipment control rooms and projection booths.

(d) To provide access where existing site constraints or other constraints make use of a ramp or an elevator infeasible.

(6) Windows: (Reserved).

(7) Doors:

(a) At each accessible entrance to a building or facility, at least one door shall comply with 4.13.

(b) Within a building or facility, at least one door at each accessible space shall comply with 4.13.

(c) Each door that is an element of an accessible route shall comply with 4.13.

4.1.3 Accessible Buildings: New Construction

(d) Each door required by 4.3.10, Egress, shall comply with 4.13.

(8) In new construction, at a minimum, the requirements in (a) and (b) below shall be satisfied independently:

(a)(i) At least 50% of all public entrances (excluding those in (b) below) must be accessible. At least one must be a ground floor entrance. Public entrances are any entrances that are not loading or service entrances.

(ii) Accessible entrances must be provided in a number at least equivalent to the number of exits required by the applicable building/fire codes. (This paragraph does not require an increase in the total number of entrances planned for a facility.)

(iii) An accessible entrance must be provided to each tenancy in a facility (for example, individual stores in a strip shopping center).

One entrance may be considered as meeting more than one of the requirements in (a). Where feasible, accessible entrances shall be the entrances used by the majority of people visiting or working in the building.

(b)(i) In addition, if direct access is provided for pedestrians from an enclosed parking garage to the building, at least one direct entrance from the garage to the building must be accessible.

(ii) If access is provided for pedestrians from a pedestrian tunnel or elevated walkway, one entrance to the building from each tunnel or walkway must be accessible.

One entrance may be considered as meeting more than one of the requirements in (b).

Because entrances also serve as emergency exits whose proximity to all parts of buildings and facilities is essential, it is preferable that all entrances be accessible.

(c) If the only entrance to a building, or tenancy in a facility, is a service entrance, that entrance shall be accessible.

(d) Entrances which are not accessible shall have directional signage complying with 4.30.1,

4.30.2, 4.30.3, and 4.30.5, which indicates the location of the nearest accessible entrance.

(9)* In buildings or facilities, or portions of buildings or facilities, required to be accessible, accessible means of egress shall be provided in the same number as required for exits by local building/life safety regulations. Where a required exit from an occupable level above or below a level of accessible exit discharge is not accessible, an area of rescue assistance shall be provided on each such level (in a number equal to that of inaccessible required exits). Areas of rescue assistance shall comply with 4.3.11. A horizontal exit, meeting the requirements of local building/life safety regulations, shall satisfy the requirement for an area of rescue assistance.

EXCEPTION: Areas of rescue assistance are not required in buildings or facilities having a supervised automatic sprinkler system.

(10)* Drinking Fountains:

(a) Where only one drinking fountain is provided on a floor there shall be a drinking fountain which is accessible to individuals who use wheelchairs in accordance with 4.15 and one accessible to those who have difficulty bending or stooping. (This can be accommodated by the use of a "hi-lo" fountain; by providing one fountain accessible to those who use wheelchairs and one fountain at a standard height convenient for those who have difficulty bending; by providing a fountain accessible under 4.15 and a water cooler; or by such other means as would achieve the required accessibility for each group on each floor.)

(b) Where more than one drinking fountain or water cooler is provided on a floor, 50% of those provided shall comply with 4.15 and shall be on an accessible route.

(11) Toilet Facilities: If toilet rooms are provided, then each public and common use toilet room shall comply with 4.22. Other toilet rooms provided for the use of occupants of specific spaces (i.e., a private toilet room for the occupant of a private office) shall be adaptable. If bathing rooms are provided, then each public and common use bathroom shall comply with 4.23. Accessible toilet rooms and bathing facilities shall be on an accessible route.

4.1.3 Accessible Buildings: New Construction

(12) Storage, Shelving and Display Units:

(a) If fixed or built-in storage facilities such as cabinets, shelves, closets, and drawers are provided in accessible spaces, at least one of each type provided shall contain storage space complying with 4.25. Additional storage may be provided outside of the dimensions required by 4.25.

(b) Shelves or display units allowing self-service by customers in mercantile occupancies shall be located on an accessible route complying with 4.3. Requirements for accessible reach range do not apply.

(13) Controls and operating mechanisms in accessible spaces, along accessible routes, or as parts of accessible elements (for example, light switches and dispenser controls) shall comply with 4.27.

(14) If emergency warning systems are provided, then they shall include both audible alarms and visual alarms complying with 4.28. Sleeping accommodations required to comply with 9.3 shall have an alarm system complying with 4.28. Emergency warning systems in medical care facilities may be modified to suit standard health care alarm design practice.

(15) Detectable warnings shall be provided at locations as specified in 4.29.

(16) Building Signage:

(a) Signs which designate permanent rooms and spaces shall comply with 4.30.1, 4.30.4, 4.30.5 and 4.30.6.

(b) Other signs which provide direction to or information about functional spaces of the building shall comply with 4.30.1, 4.30.2, 4.30.3, and 4.30.5.

EXCEPTION: Building directories, menus, and all other signs which are temporary are not required to comply.

(17) Public Telephones:

(a) If public pay telephones, public closed circuit telephones, or other public telephones are provided, then they shall comply with 4.31.2 through 4.31.8 to the extent required by the following table:

| Number of each type of telephone provided on each floor | Number of telephones required to comply with 4.31.2 through 4.31.8 ¹ |
|---|---|
| 1 or more single unit | 1 per floor |
| 1 bank ² | 1 per floor |
| 2 or more banks ² | 1 per bank. Accessible unit may be installed as a single unit in proximity (either visible or with signage) to the bank. At least one public telephone per floor shall meet the requirements for a forward reach telephone ³ . |

¹ Additional public telephones may be installed at any height. Unless otherwise specified, accessible telephones may be either forward or side reach telephones.

² A bank consists of two or more adjacent public telephones, often installed as a unit.

³ EXCEPTION: For exterior installations only, if dial tone first service is available, then a side reach telephone may be installed instead of the required forward reach telephone (i.e., one telephone in proximity to each bank shall comply with 4.31).

(b)* All telephones required to be accessible and complying with 4.31.2 through 4.31.8 shall be equipped with a volume control. In addition, 25 percent, but never less than one, of all other public telephones provided shall be equipped with a volume control and shall be dispersed among all types of public telephones, including closed circuit telephones, throughout the building or facility. Signage complying with applicable provisions of 4.30.7 shall be provided.

(c) The following shall be provided in accordance with 4.31.9:

(i) if a total number of four or more public pay telephones (including both interior and exterior phones) is provided at a site, and at least one is in an interior location, then at least one interior public text telephone shall be provided.

(ii) if an interior public pay telephone is provided in a stadium or arena, in a convention center, in a hotel with a convention center, or

4.1.3 Accessible Buildings: New Construction

in a covered mall, at least one interior public text telephone shall be provided in the facility.

(iii) if a public pay telephone is located in or adjacent to a hospital emergency room, hospital recovery room, or hospital waiting room, one public text telephone shall be provided at each such location.

(d) Where a bank of telephones in the interior of a building consists of three or more public pay telephones, at least one public pay telephone in each such bank shall be equipped with a shelf and outlet in compliance with 4.31.9(2).

(18) If fixed or built-in seating or tables (including, but not limited to, study carrels and student laboratory stations), are provided in accessible public or common use areas, at least five percent (5%), but not less than one, of the fixed or built-in seating areas or tables shall comply with 4.32. An accessible route shall lead to and through such fixed or built-in seating areas, or tables.

(19)* Assembly areas:

(a) In places of assembly with fixed seating accessible wheelchair locations shall comply with 4.33.2, 4.33.3, and 4.33.4 and shall be provided consistent with the following table:

| Capacity of Seating in Assembly Areas | Number of Required Wheelchair Locations |
|--|--|
|--|--|

| | |
|------------|--|
| 4 to 25 | 1 |
| 26 to 50 | 2 |
| 51 to 300 | 4 |
| 301 to 500 | 6 |
| over 500 | 6, plus 1 additional space for each total seating capacity increase of 100 |

In addition, one percent, but not less than one, of all fixed seats shall be aisle seats with no armrests on the aisle side, or removable or folding armrests on the aisle side. Each such seat shall be identified by a sign or marker. Signage notifying patrons of the availability of such seats shall be posted at the ticket office. Aisle seats are not required to comply with 4.33.4.

(b) This paragraph applies to assembly areas where audible communications are integral to the use of the space (e.g., concert and lecture halls, playhouses and movie theaters, meeting rooms, etc.). Such assembly areas, if (1) they accommodate at least 50 persons, or if they have audio-amplification systems, and (2) they have fixed seating, shall have a permanently installed assistive listening system complying with 4.33. For other assembly areas, a permanently installed assistive listening system, or an adequate number of electrical outlets or other supplementary wiring necessary to support a portable assistive listening system shall be provided. The minimum number of receivers to be provided shall be equal to 4 percent of the total number of seats, but in no case less than two. Signage complying with applicable provisions of 4.30 shall be installed to notify patrons of the availability of a listening system.

(20) Where automated teller machines (ATMs) are provided, each ATM shall comply with the requirements of 4.34 except where two or more are provided at a location, then only one must comply.

EXCEPTION: Drive-up-only automated teller machines are not required to comply with 4.27.2, 4.27.3 and 4.34.3.

(21) Where dressing and fitting rooms are provided for use by the general public, patients, customers or employees, 5 percent, but never less than one, of dressing rooms for each type of use in each cluster of dressing rooms shall be accessible and shall comply with 4.35.

Examples of types of dressing rooms are those serving different genders or distinct and different functions as in different treatment or examination facilities.

4.1.4 (Reserved).**4.1.5 Accessible Buildings: Additions.**

Each addition to an existing building or facility shall be regarded as an alteration. Each space or element added to the existing building or facility shall comply with the applicable provisions of 4.1.1 to 4.1.3, Minimum Requirements (for New Construction) and the applicable technical specifications of 4.2 through 4.35 and sections 5 through 10. Each addition that

4.1.6 Accessible Buildings: Alterations

affects or could affect the usability of an area containing a primary function shall comply with 4.1.6(2).

4.1.6 Accessible Buildings: Alterations.

(1) General. Alterations to existing buildings and facilities shall comply with the following:

(a) No alteration shall be undertaken which decreases or has the effect of decreasing accessibility or usability of a building or facility below the requirements for new construction at the time of alteration.

(b) If existing elements, spaces, or common areas are altered, then each such altered element, space, feature, or area shall comply with the applicable provisions of 4.1.1 to 4.1.3 Minimum Requirements (for New Construction). If the applicable provision for new construction requires that an element, space, or common area be on an accessible route, the altered element, space, or common area is not required to be on an accessible route except as provided in 4.1.6(2) (Alterations to an Area Containing a Primary Function.)

(c) If alterations of single elements, when considered together, amount to an alteration of a room or space in a building or facility, the entire space shall be made accessible.

(d) No alteration of an existing element, space, or area of a building or facility shall impose a requirement for greater accessibility than that which would be required for new construction. For example, if the elevators and stairs in a building are being altered and the elevators are, in turn, being made accessible, then no accessibility modifications are required to the stairs connecting levels connected by the elevator. If stair modifications to correct unsafe conditions are required by other codes, the modifications shall be done in compliance with these guidelines unless technically infeasible.

(e) At least one interior public text telephone complying with 4.31.9 shall be provided if:

(i) alterations to existing buildings or facilities with less than four exterior or interior public pay telephones would increase the total number to four or more telephones with at least one in an interior location; or

(ii) alterations to one or more exterior or interior public pay telephones occur in an existing building or facility with four or more public telephones with at least one in an interior location.

(f) If an escalator or stair is planned or installed where none existed previously and major structural modifications are necessary for such installation, then a means of accessible vertical access shall be provided that complies with the applicable provisions of 4.7, 4.8, 4.10, or 4.11.

(g) In alterations, the requirements of 4.1.3(9), 4.3.10 and 4.3.11 do not apply.

(h)*Entrances: If a planned alteration entails alterations to an entrance, and the building has an accessible entrance, the entrance being altered is not required to comply with 4.1.3(8), except to the extent required by 4.1.6(2). If a particular entrance is not made accessible, appropriate accessible signage indicating the location of the nearest accessible entrance(s) shall be installed at or near the inaccessible entrance, such that a person with disabilities will not be required to retrace the approach route from the inaccessible entrance.

(i) If the alteration work is limited solely to the electrical, mechanical, or plumbing system, or to hazardous material abatement, or automatic sprinkler retrofitting, and does not involve the alteration of any elements or spaces required to be accessible under these guidelines, then 4.1.6(2) does not apply.

(j) EXCEPTION: In alteration work, if compliance with 4.1.6 is technically infeasible, the alteration shall provide accessibility to the maximum extent feasible. Any elements or features of the building or facility that are being altered and can be made accessible shall be made accessible within the scope of the alteration.

Technically Infeasible. Means, with respect to an alteration of a building or a facility, that it has little likelihood of being accomplished because existing structural conditions would require removing or altering a load-bearing member which is an essential part of the structural frame; or because other existing physical or site constraints prohibit modification or

4.1.6 Accessible Buildings: Alterations

addition of elements, spaces, or features which are in full and strict compliance with the minimum requirements for new construction and which are necessary to provide accessibility.

(k) EXCEPTION:

(i) These guidelines do not require the installation of an elevator in an altered facility that is less than three stories or has less than 3,000 square feet per story unless the building is a shopping center, a shopping mall, the professional office of a health care provider, or another type of facility as determined by the Attorney General.

(ii) The exemption provided in paragraph (i) does not obviate or limit in any way the obligation to comply with the other accessibility requirements established in these guidelines. For example, alterations to floors above or below the ground floor must be accessible regardless of whether the altered facility has an elevator. If a facility subject to the elevator exemption set forth in paragraph (i) nonetheless has a full passenger elevator, that elevator shall meet, to the maximum extent feasible, the accessibility requirements of these guidelines.

(2) Alterations to an Area Containing a Primary Function: In addition to the requirements of 4.1.6(1), an alteration that affects or could affect the usability of or access to an area containing a primary function shall be made so as to ensure that, to the maximum extent feasible, the path of travel to the altered area and the restrooms, telephones, and drinking fountains serving the altered area, are readily accessible to and usable by individuals with disabilities, unless such alterations are disproportionate to the overall alterations in terms of cost and scope (as determined under criteria established by the Attorney General).

(3) Special Technical Provisions for Alterations to Existing Buildings and Facilities:

(a) Ramps: Curb ramps and interior or exterior ramps to be constructed on sites or in existing buildings or facilities where space limitations prohibit the use of a 1:12 slope or less may have slopes and rises as follows:

(i) A slope between 1:10 and 1:12 is allowed for a maximum rise of 6 inches.

(ii) A slope between 1:8 and 1:10 is allowed for a maximum rise of 3 inches. A slope steeper than 1:8 is not allowed.

(b) Stairs: Full extension of handrails at stairs shall not be required in alterations where such extensions would be hazardous or impossible due to plan configuration.

(c) Elevators:

(i) If safety door edges are provided in existing automatic elevators, automatic door reopening devices may be omitted (see 4.10.6).

(ii) Where existing shaft configuration or technical infeasibility prohibits strict compliance with 4.10.9, the minimum car plan dimensions may be reduced by the minimum amount necessary, but in no case shall the inside car area be smaller than 48 in by 48 in.

(iii) Equivalent facilitation may be provided with an elevator car of different dimensions when usability can be demonstrated and when all other elements required to be accessible comply with the applicable provisions of 4.10. For example, an elevator of 47 in by 69 in (1195 mm by 1755 mm) with a door opening on the narrow dimension, could accommodate the standard wheelchair clearances shown in Figure 4.

(d) Doors:

(i) Where it is technically infeasible to comply with clear opening width requirements of 4.13.5, a projection of 5/8 in maximum will be permitted for the latch side stop.

(ii) If existing thresholds are 3/4 in high or less, and have (or are modified to have) a beveled edge on each side, they may remain.

(e) Toilet Rooms:

(i) Where it is technically infeasible to comply with 4.22 or 4.23, the installation of at least one unisex toilet/bathroom per floor, located in the same area as existing toilet facilities, will be permitted in lieu of modifying existing toilet facilities to be accessible. Each unisex toilet room shall contain one water closet complying with 4.16 and one lavatory complying with 4.19, and the door shall have a privacy latch.

4.1.7 Accessible Buildings: Historic Preservation

(ii) Where it is technically infeasible to install a required standard stall (Fig. 30(a)), or where other codes prohibit reduction of the fixture count (i.e., removal of a water closet in order to create a double-wide stall), either alternate stall (Fig. 30(b)) may be provided in lieu of the standard stall.

(iii) When existing toilet or bathing facilities are being altered and are not made accessible, signage complying with 4.30.1, 4.30.2, 4.30.3, 4.30.5, and 4.30.7 shall be provided indicating the location of the nearest accessible toilet or bathing facility within the facility.

(f) Assembly Areas:

(i) Where it is technically infeasible to disperse accessible seating throughout an altered assembly area, accessible seating areas may be clustered. Each accessible seating area shall have provisions for companion seating and shall be located on an accessible route that also serves as a means of emergency egress.

(ii) Where it is technically infeasible to alter all performing areas to be on an accessible route, at least one of each type of performing area shall be made accessible.

(g) Platform Lifts (Wheelchair Lifts): In alterations, platform lifts (wheelchair lifts) complying with 4.11 and applicable state or local codes may be used as part of an accessible route. The use of lifts is not limited to the four conditions in exception 4 of 4.1.3(5).

(h) Dressing Rooms: In alterations where technical infeasibility can be demonstrated, one dressing room for each sex on each level shall be made accessible. Where only unisex dressing rooms are provided, accessible unisex dressing rooms may be used to fulfill this requirement.

4.1.7 Accessible Buildings: Historic Preservation.**(1) Applicability:**

(a) General Rule. Alterations to a qualified historic building or facility shall comply with 4.1.6 Accessible Buildings: Alterations, the applicable technical specifications of 4.2

through 4.35 and the applicable special application sections 5 through 10 unless it is determined in accordance with the procedures in 4.1.7(2) that compliance with the requirements for accessible routes (exterior and interior), ramps, entrances, or toilets would threaten or destroy the historic significance of the building or facility in which case the alternative requirements in 4.1.7(3) may be used for the feature.

EXCEPTION: (Reserved).

(b) Definition. A qualified historic building or facility is a building or facility that is:

(i) Listed in or eligible for listing in the National Register of Historic Places; or

(ii) Designated as historic under an appropriate State or local law.

(2) Procedures:

(a) Alterations to Qualified Historic Buildings and Facilities Subject to Section 106 of the National Historic Preservation Act:

(i) Section 106 Process. Section 106 of the National Historic Preservation Act (16 U.S.C. 470 f) requires that a Federal agency with jurisdiction over a Federal, federally assisted, or federally licensed undertaking consider the effects of the agency's undertaking on buildings and facilities listed in or eligible for listing in the National Register of Historic Places and give the Advisory Council on Historic Preservation a reasonable opportunity to comment on the undertaking prior to approval of the undertaking.

(ii) ADA Application. Where alterations are undertaken to a qualified historic building or facility that is subject to section 106 of the National Historic Preservation Act, the Federal agency with jurisdiction over the undertaking shall follow the section 106 process. If the State Historic Preservation Officer or Advisory Council on Historic Preservation agrees that compliance with the requirements for accessible routes (exterior and interior), ramps, entrances, or toilets would threaten or destroy the historic significance of the building or facility, the alternative requirements in 4.1.7(3) may be used for the feature.

4.2 Space Allowance and Reach Ranges

(b) Alterations to Qualified Historic Buildings and Facilities Not Subject to Section 106 of the National Historic Preservation Act. Where alterations are undertaken to a qualified historic building or facility that is not subject to section 106 of the National Historic Preservation Act, if the entity undertaking the alterations believes that compliance with the requirements for accessible routes (exterior and interior), ramps, entrances, or toilets would threaten or destroy the historic significance of the building or facility and that the alternative requirements in 4.1.7(3) should be used for the feature, the entity should consult with the State Historic Preservation Officer. If the State Historic Preservation Officer agrees that compliance with the accessibility requirements for accessible routes (exterior and interior), ramps, entrances or toilets would threaten or destroy the historical significance of the building or facility, the alternative requirements in 4.1.7(3) may be used.

(c) Consultation With Interested Persons. Interested persons should be invited to participate in the consultation process, including State or local accessibility officials, individuals with disabilities, and organizations representing individuals with disabilities.

(d) Certified Local Government Historic Preservation Programs. Where the State Historic Preservation Officer has delegated the consultation responsibility for purposes of this section to a local government historic preservation program that has been certified in accordance with section 101(c) of the National Historic Preservation Act of 1966 (16 U.S.C. 470a (c)) and implementing regulations (36 CFR 61.5), the responsibility may be carried out by the appropriate local government body or official.

(3) Historic Preservation: Minimum Requirements:

(a) At least one accessible route complying with 4.3 from a site access point to an accessible entrance shall be provided.

EXCEPTION: A ramp with a slope no greater than 1:6 for a run not to exceed 2 ft (610 mm) may be used as part of an accessible route to an entrance.

(b) At least one accessible entrance complying with 4.14 which is used by the public shall be provided.

EXCEPTION: If it is determined that no entrance used by the public can comply with 4.14, then access at any entrance not used by the general public but open (unlocked) with directional signage at the primary entrance may be used. The accessible entrance shall also have a notification system. Where security is a problem, remote monitoring may be used.

(c) If toilets are provided, then at least one toilet facility complying with 4.22 and 4.1.6 shall be provided along an accessible route that complies with 4.3. Such toilet facility may be unisex in design.

(d) Accessible routes from an accessible entrance to all publicly used spaces on at least the level of the accessible entrance shall be provided. Access shall be provided to all levels of a building or facility in compliance with 4.1 whenever practical.

(e) Displays and written information, documents, etc., should be located where they can be seen by a seated person. Exhibits and signage displayed horizontally (e.g., open books), should be no higher than 44 in (1120 mm) above the floor surface.

NOTE: The technical provisions of sections 4.2 through 4.35 are the same as those of the American National Standard Institute's document A117.1-1980, except as noted in the text.

4.2 Space Allowance and Reach Ranges.

4.2.1* Wheelchair Passage Width. The minimum clear width for single wheelchair passage shall be 32 in (815 mm) at a point and 36 in (915 mm) continuously (see Fig. 1 and 24(e)).

4.2.2 Width for Wheelchair Passing. The minimum width for two wheelchairs to pass is 60 in (1525 mm) (see Fig. 2).

4.2.3* Wheelchair Turning Space. The space required for a wheelchair to make a 180-degree turn is a clear space of 60 in (1525 mm)

4.2.4* Clear Floor or Ground Space for Wheelchairs

diameter (see Fig. 3(a)) or a T-shaped space (see Fig. 3(b)).

4.2.4* Clear Floor or Ground Space for Wheelchairs.

4.2.4.1 Size and Approach. The minimum clear floor or ground space required to accommodate a single, stationary wheelchair and occupant is 30 in by 48 in (760 mm by 1220 mm) (see Fig. 4(a)). The minimum clear floor or ground space for wheelchairs may be positioned for forward or parallel approach to an object (see Fig. 4(b) and (c)). Clear floor or ground space for wheelchairs may be part of the knee space required under some objects.

4.2.4.2 Relationship of Maneuvering Clearance to Wheelchair Spaces. One full unobstructed side of the clear floor or ground space for a wheelchair shall adjoin or overlap an accessible route or adjoin another wheelchair clear floor space. If a clear floor space is located in an alcove or otherwise confined on all or part of three sides, additional maneuvering clearances shall be provided as shown in Fig. 4(d) and (e).

4.2.4.3 Surfaces for Wheelchair Spaces. Clear floor or ground spaces for wheelchairs shall comply with 4.5.

4.2.5* Forward Reach. If the clear floor space only allows forward approach to an object, the maximum high forward reach allowed shall be 48 in (1220 mm) (see Fig. 5(a)). The minimum low forward reach is 15 in (380 mm). If the high forward reach is over an obstruction, reach and clearances shall be as shown in Fig. 5(b).

4.2.6* Side Reach. If the clear floor space allows parallel approach by a person in a wheelchair, the maximum high side reach allowed shall be 54 in (1370 mm) and the low side reach shall be no less than 9 in (230 mm) above the floor (Fig. 6(a) and (b)). If the side reach is over an obstruction, the reach and clearances shall be as shown in Fig 6(c).

4.3 Accessible Route.

4.3.1* General. All walks, halls, corridors, aisles, skywalks, tunnels, and other spaces

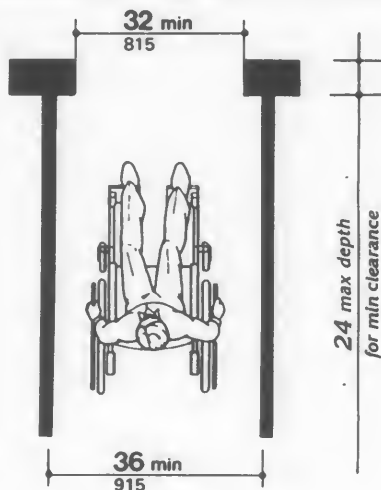

Fig. 1
Minimum Clear Width
for Single Wheelchair

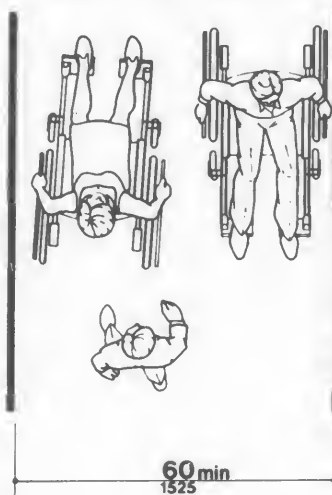

Fig. 2
Minimum Clear Width
for Two Wheelchairs

4.3 Accessible Route

that are part of an accessible route shall comply with 4.3.

4.3.2 Location.

(1) At least one accessible route *within the boundary of the site* shall be provided from public transportation stops, accessible parking, and accessible passenger loading zones, and public streets or sidewalks to the accessible building entrance they serve. *The accessible route shall, to the maximum extent feasible, coincide with the route for the general public.*

(2) At least one accessible route shall connect accessible buildings, facilities, elements, and spaces that are on the same site.

(3) At least one accessible route shall connect accessible building or facility entrances with all accessible spaces and elements and with all accessible dwelling units within the building or facility.

(4) An accessible route shall connect at least one accessible entrance of each accessible

dwelling unit with those exterior and interior spaces and facilities that serve the accessible dwelling unit.

4.3.3 Width. The minimum clear width of an accessible route shall be 36 in (915 mm) except at doors (see 4.13.5 and 4.13.6). If a person in a wheelchair must make a turn around an obstruction, the minimum clear width of the accessible route shall be as shown in Fig. 7(a) and (b).

4.3.4 Passing Space. If an accessible route has less than 60 in (1525 mm) clear width, then passing spaces at least 60 in by 60 in (1525 mm by 1525 mm) shall be located at reasonable intervals not to exceed 200 ft (61 m). A T-intersection of two corridors or walks is an acceptable passing place.

4.3.5 Head Room. Accessible routes shall comply with 4.4.2.

4.3.6 Surface Textures. The surface of an accessible route shall comply with 4.5.

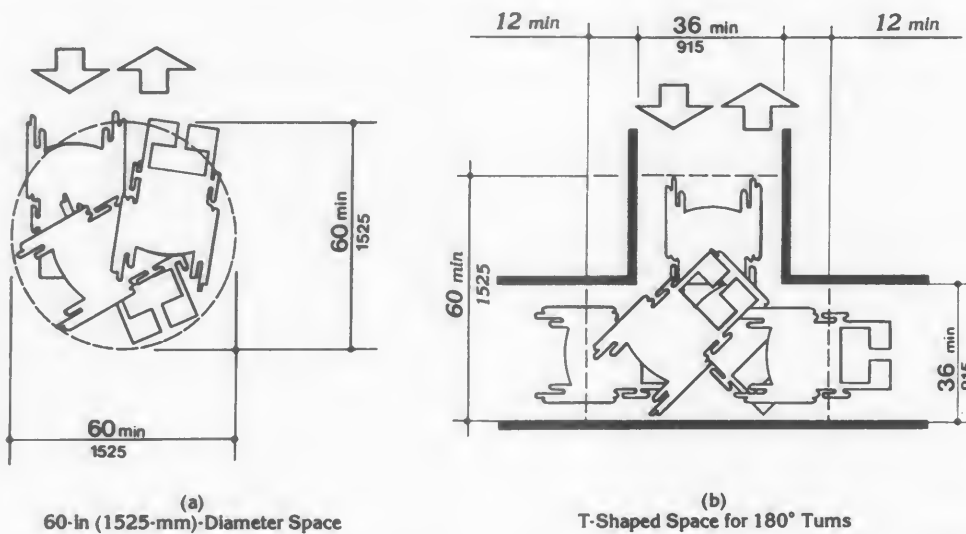

Fig. 3
Wheelchair Turning Space

4.3 Accessible Route

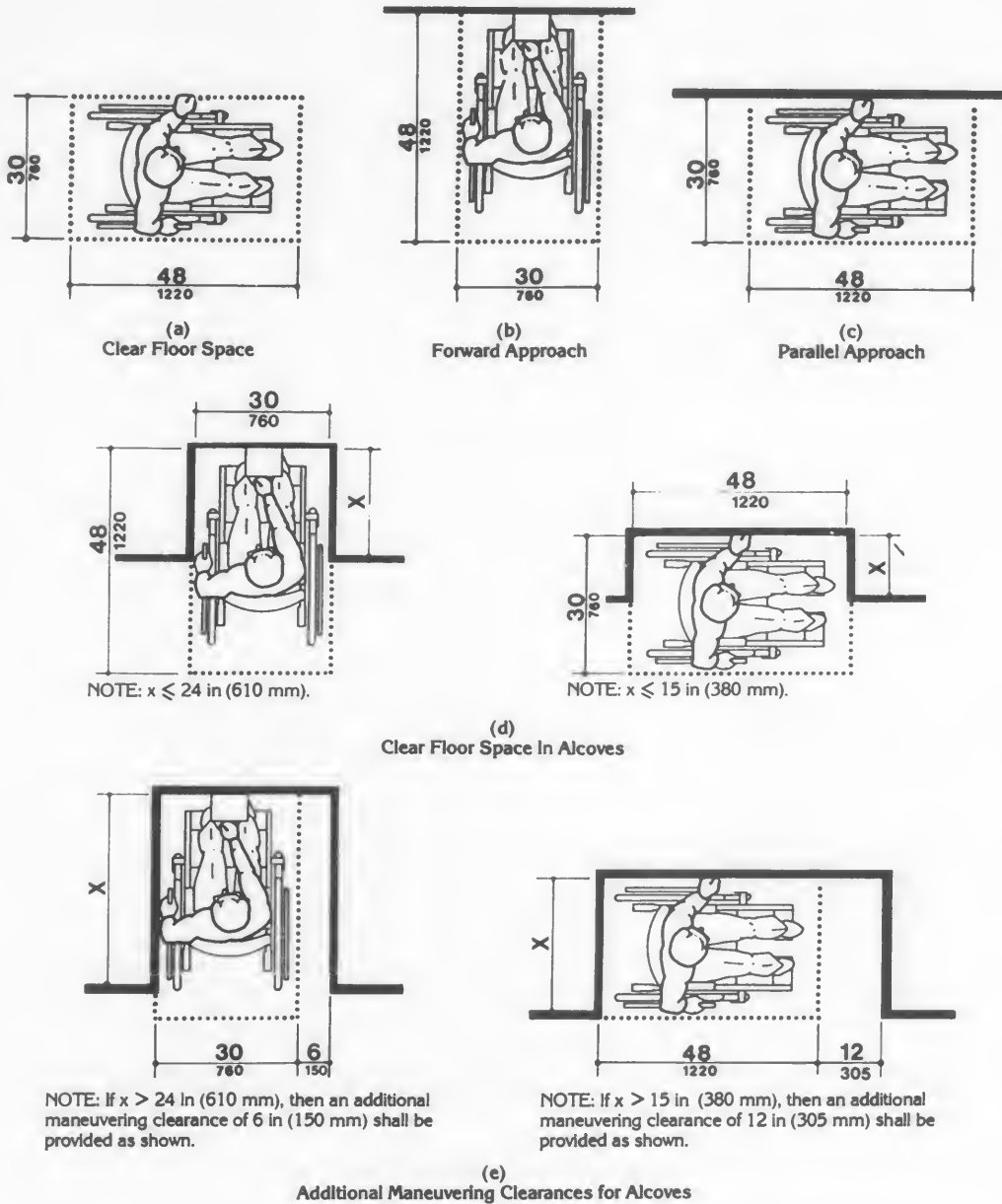
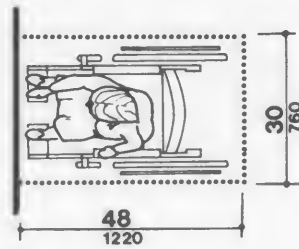
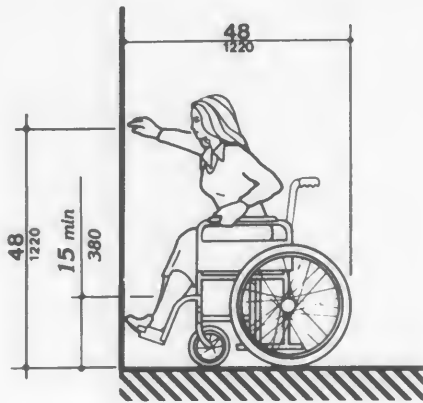
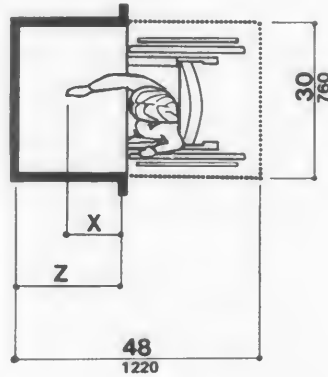
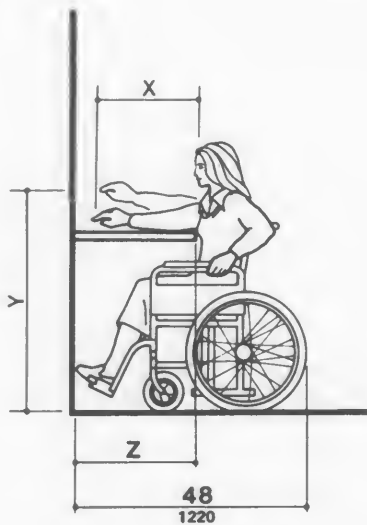

Fig. 4
 Minimum Clear Floor Space for Wheelchairs

4.3 Accessible Route



(a)
High Forward Reach Limit



NOTE: x shall be ≤ 25 in (635 mm); z shall be $\geq x$. When $x < 20$ in (510 mm), then y shall be 48 in (1220 mm) maximum. When x is 20 to 25 in (510 to 635 mm), then y shall be 44 in (1120 mm) maximum.

(b)
Maximum Forward Reach over an Obstruction

Fig. 5
Forward Reach

4.3.7 Slope

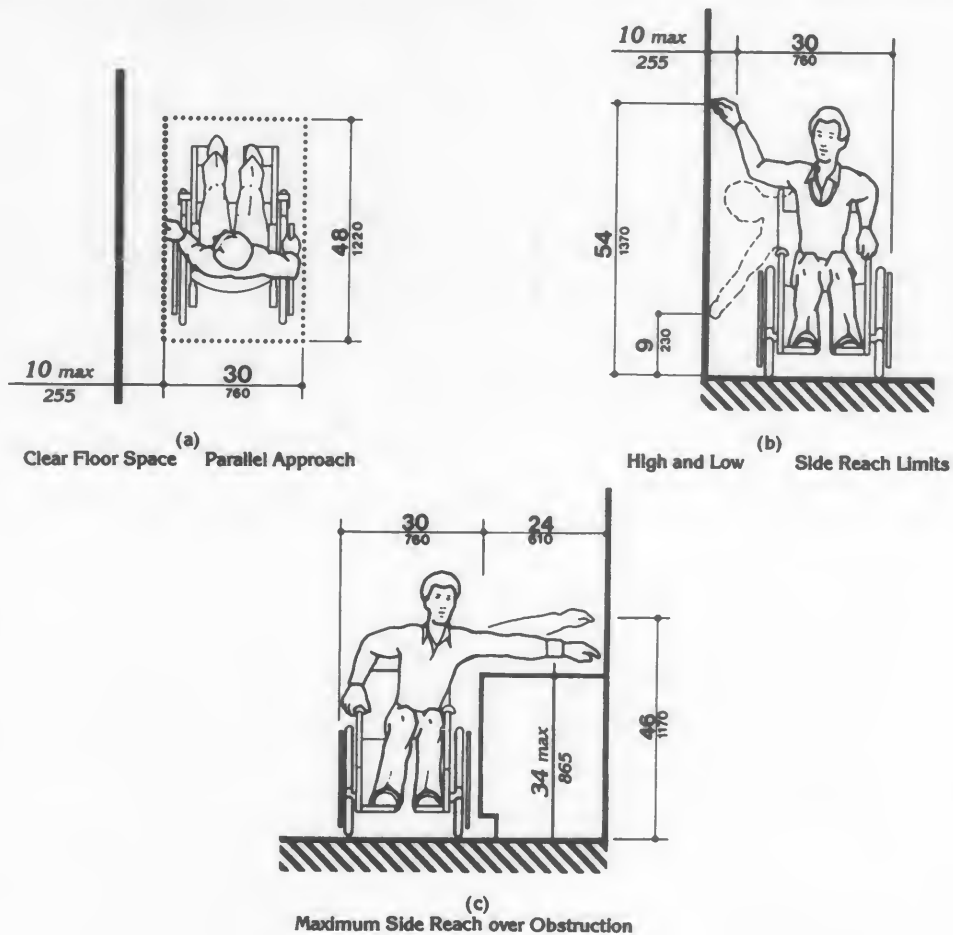

Fig. 6
Side Reach

4.3.7 Slope. An accessible route with a running slope greater than 1:20 is a ramp and shall comply with 4.8. Nowhere shall the cross slope of an accessible route exceed 1:50.

4.3.8 Changes in Levels. Changes in levels along an accessible route shall comply with 4.5.2. If an accessible route has changes in level greater than 1/2 in (13 mm), then a curb

ramp, ramp, elevator, or platform lift (as permitted in 4.1.3 and 4.1.6) shall be provided that complies with 4.7, 4.8, 4.10, or 4.11, respectively. An accessible route does not include stairs, steps, or escalators. See definition of "egress, means of" in 3.5.

4.3.9 Doors. Doors along an accessible route shall comply with 4.13.

4.3.10* Egress

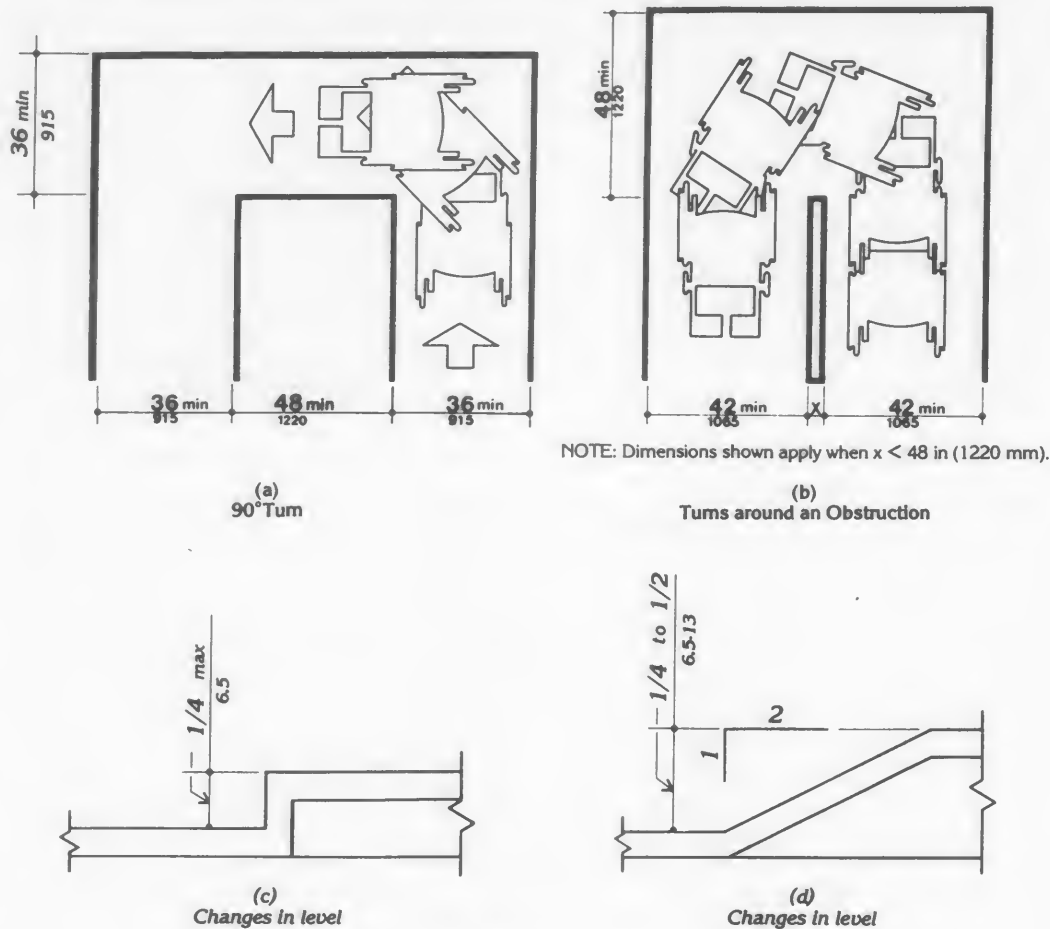

Fig. 7
Accessible Route

4.3.10* Egress. Accessible routes serving any accessible space or element shall also serve as a means of egress for emergencies or connect to an accessible area of rescue assistance.

4.3.11 Areas of Rescue Assistance.

4.3.11.1 Location and Construction. An area of rescue assistance shall be one of the following:

(1) A portion of a stairway landing within a smokeproof enclosure (complying with local requirements).

(2) A portion of an exterior exit balcony located immediately adjacent to an exit stairway when the balcony complies with local requirements for exterior exit balconies. Openings to the interior of the building located within 20 feet (6 m) of the

4.4 Protruding Objects

area of rescue assistance shall be protected with fire assemblies having a three-fourths hour fire protection rating.

(3) A portion of a one-hour fire-resistive corridor (complying with local requirements for fire-resistive construction and for openings) located immediately adjacent to an exit enclosure.

(4) A vestibule located immediately adjacent to an exit enclosure and constructed to the same fire-resistive standards as required for corridors and openings.

(5) A portion of a stairway landing within an exit enclosure which is vented to the exterior and is separated from the interior of the building with not less than one-hour fire-resistive doors.

(6) When approved by the appropriate local authority, an area or a room which is separated from other portions of the building by a smoke barrier. Smoke barriers shall have a fire-resistive rating of not less than one hour and shall completely enclose the area or room. Doors in the smoke barrier shall be tight-fitting smoke and draft-control assemblies having a fire-protection rating of not less than 20 minutes and shall be self-closing or automatic closing. The area or room shall be provided with an exit directly to an exit enclosure. Where the room or area exits into an exit enclosure which is required to be of more than one-hour fire-resistive construction, the room or area shall have the same fire-resistive construction, including the same opening protection, as required for the adjacent exit enclosure.

(7) An elevator lobby when elevator shafts and adjacent lobbies are pressurized as required for smokeproof enclosures by local regulations and when complying with requirements herein for size, communication, and signage. Such pressurization system shall be activated by smoke detectors on each floor located in a manner approved by the appropriate local authority. Pressurization equipment and its duct work within the building shall be separated from other portions of the building by a minimum two-hour fire-resistive construction.

4.3.11.2 Size. Each area of rescue assistance shall provide at least two accessible areas each being not less than 30 inches by 48 inches (760 mm by 1220 mm). The area of rescue

assistance shall not encroach on any required exit width. The total number of such 30-inch by 48-inch (760 mm by 1220 mm) areas per story shall be not less than one for every 200 persons of calculated occupant load served by the area of rescue assistance.

EXCEPTION: The appropriate local authority may reduce the minimum number of 30-inch by 48-inch (760 mm by 1220 mm) areas to one for each area of rescue assistance on floors where the occupant load is less than 200.

4.3.11.3* Stairway Width. Each stairway adjacent to an area of rescue assistance shall have a minimum clear width of 48 inches between handrails.

4.3.11.4* Two-way Communication. A method of two-way communication, with both visible and audible signals, shall be provided between each area of rescue assistance and the primary entry. The fire department or appropriate local authority may approve a location other than the primary entry.

4.3.11.5 Identification. Each area of rescue assistance shall be identified by a sign which states "AREA OF RESCUE ASSISTANCE" and displays the international symbol of accessibility. The sign shall be illuminated when exit sign illumination is required. Signage shall also be installed at all inaccessible exits and where otherwise necessary to clearly indicate the direction to areas of rescue assistance. In each area of rescue assistance, instructions on the use of the area under emergency conditions shall be posted adjoining the two-way communication system.

4.4 Protruding Objects.

4.4.1* General. Objects projecting from walls (for example, telephones) with their leading edges between 27 in and 80 in (685 mm and 2030 mm) above the finished floor shall protrude no more than 4 in (100 mm) into walks, halls, corridors, passageways, or aisles (see Fig. 8(a)). Objects mounted with their leading edges at or below 27 in (685 mm) above the finished floor may protrude any amount (see Fig. 8(a) and (b)). Free-standing objects mounted on posts or pylons may overhang 12 in (305 mm) maximum from 27 in to 80 in (685 mm to 2030 mm) above the ground or

4.4 Protruding Objects

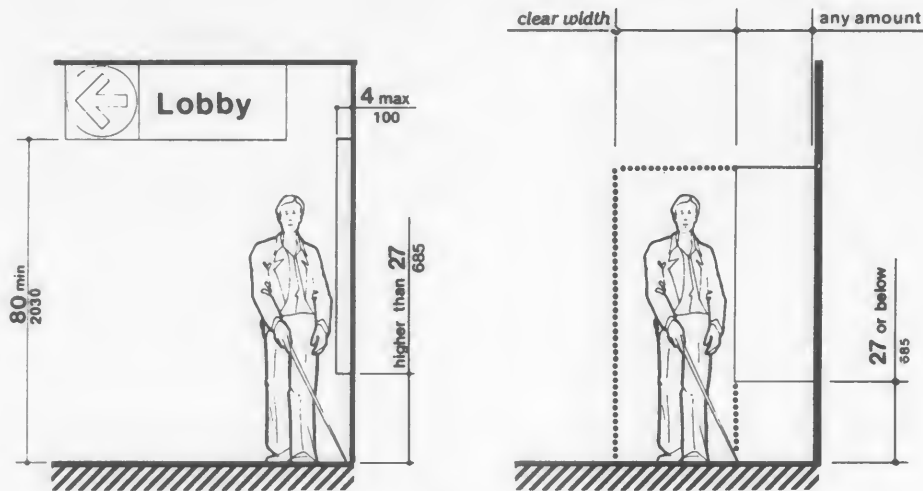

Fig. 8 (a)
Walking Parallel to a Wall

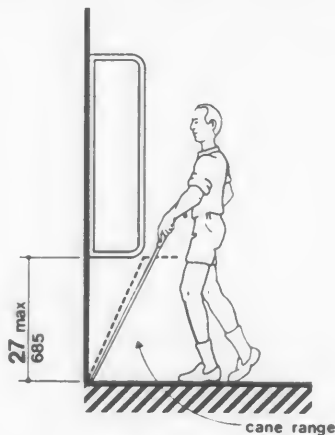

Fig. 8 (b)
Walking Perpendicular to a Wall

Fig. 8
Protruding Objects

finished floor (see Fig. 8(c) and (d)). Protruding objects shall not reduce the clear width of an accessible route or maneuvering space (see Fig. 8(e)).

4.4.2 Head Room. Walks, halls, corridors, passageways, aisles, or other circulation spaces shall have 80 in (2030 mm) minimum clear head room (see Fig. 8(a)). If vertical clearance of an area adjoining an accessible route is reduced to less than 80 in (nominal dimension), a barrier to warn blind or visually-impaired persons shall be provided (see Fig. 8(c-1)).

4.5 Ground and Floor Surfaces.

4.5.1* General. Ground and floor surfaces along accessible routes and in accessible rooms and spaces including floors, walks, ramps, stairs, and curb ramps, shall be stable, firm, slip-resistant, and shall comply with 4.5.

4.5.2 Changes in Level. Changes in level up to 1/4 in (6 mm) may be vertical and without edge treatment (see Fig. 7(c)). Changes in level between 1/4 in and 1/2 in (6 mm and 13 mm)

4.4 Protruding Objects

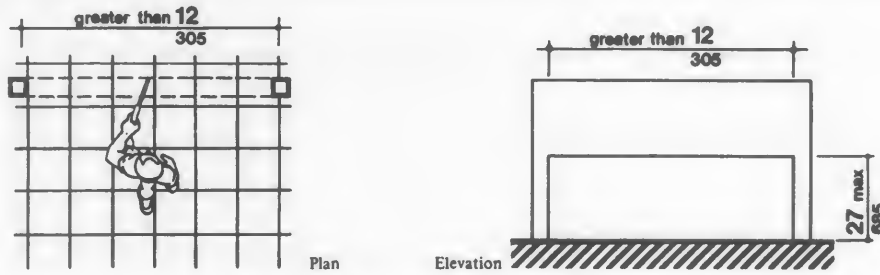

Fig. 8 (c) Free-Standing Overhanging Objects

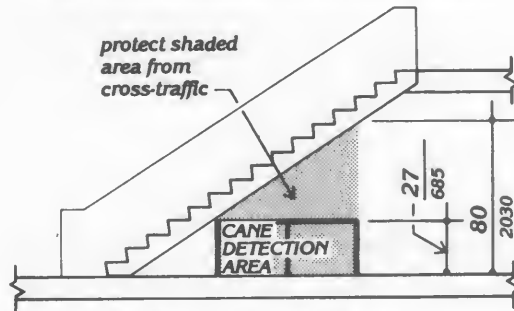

Fig. 8 (c-1) Overhead Hazards

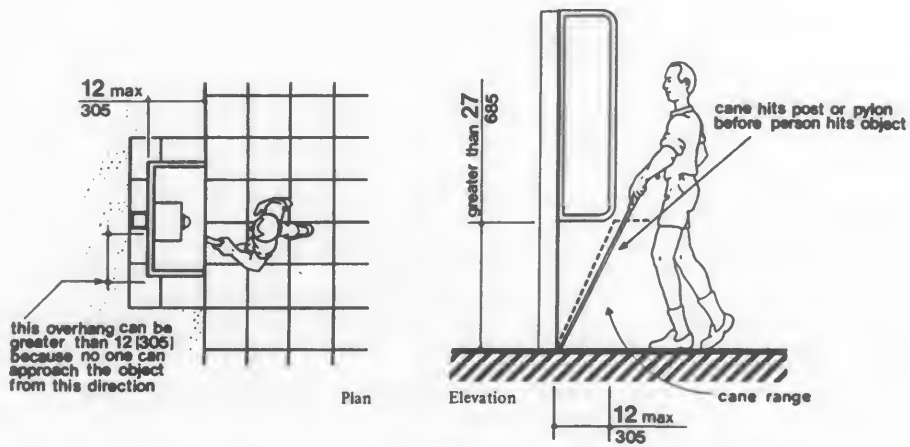

Fig. 8 (d)
Objects Mounted on Posts or Pylons

Fig. 8
Protruding Objects (Continued)

4.5 Ground and Floor Surfaces

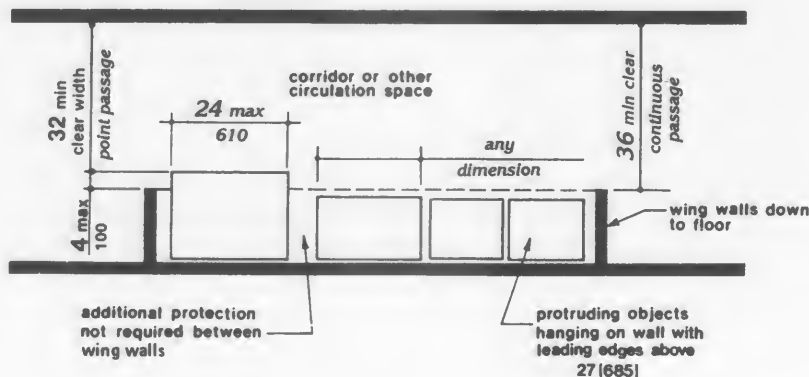

Fig. 8 (e)
Example of Protection around Wall-Mounted Objects and Measurements of Clear Widths

Fig. 8
Protruding Objects (Continued)

shall be beveled with a slope no greater than 1:2 (see Fig. 7(d)). Changes in level greater than 1/2 in (13 mm) shall be accomplished by means of a ramp that complies with 4.7 or 4.8.

4.5.3* Carpet. If carpet or carpet tile is used on a ground or floor surface, then it shall be securely attached; have a firm cushion, pad, or backing, or no cushion or pad; and have a level loop, textured loop, level cut pile, or level cut/uncut pile texture. The maximum pile thickness shall be 1/2 in (13 mm) (see Fig. 8(f)). Exposed edges of carpet shall be fastened to floor surfaces and have trim along the entire length of the exposed edge. Carpet edge trim shall comply with 4.5.2.

4.5.4 Gratings. If gratings are located in walking surfaces, then they shall have spaces no greater than 1/2 in (13 mm) wide in one direction (see Fig. 8(g)). If gratings have elongated openings, then they shall be placed so that the long dimension is perpendicular to the dominant direction of travel (see Fig. 8(h)).

4.6 Parking and Passenger Loading Zones.

4.6.1 Minimum Number. Parking spaces required to be accessible by 4.1 shall comply with 4.6.2 through 4.6.5. Passenger loading zones required to be accessible by 4.1 shall comply with 4.6.5 and 4.6.6.

4.6 Parking and Passenger Loading Zones

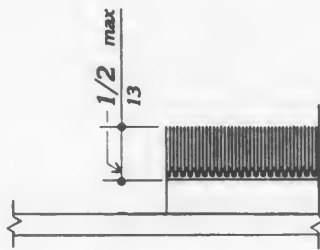

Fig. 8 (f)
Carpet Pile Thickness

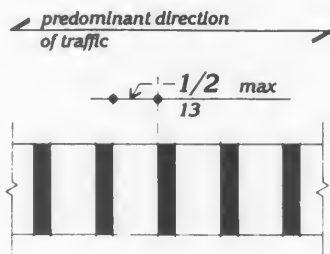

Fig. 8 (g)
Gratings

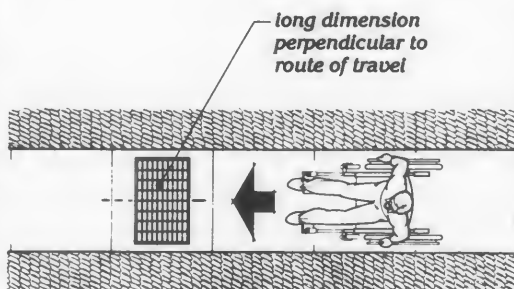

Fig. 8 (h)
Grating Orientation

4.6.2 Location. Accessible parking spaces serving a particular building shall be located on the shortest accessible route of travel from adjacent parking to an accessible entrance. In parking facilities that do not serve a particular building, accessible parking shall be located on the shortest accessible route of travel to an accessible pedestrian entrance of the parking facility. In buildings with multiple accessible entrances with adjacent parking, accessible parking spaces shall be dispersed and located closest to the accessible entrances.

4.6.3* Parking Spaces. Accessible parking spaces shall be at least 96 in (2440 mm) wide. Parking access aisles shall be part of an accessible route to the building or facility entrance and shall comply with 4.3. Two accessible parking spaces may share a common access aisle (see Fig. 9). Parked vehicle overhangs shall not reduce the clear width of an accessible route. Parking spaces and access aisles shall be level with surface slopes not exceeding 1:50 (2%) in all directions.

4.6.4* Signage. Accessible parking spaces shall be designated as reserved by a sign showing the symbol of accessibility (see 4.30.7). Spaces complying with 4.1.2(5)(b) shall have an additional sign "Van-Accessible" mounted below the symbol of accessibility. Such signs shall be located so they cannot be obscured by a vehicle parked in the space.

4.6.5* Vertical Clearance. Provide minimum vertical clearance of 114 in (2895 mm) at accessible passenger loading zones and along at least one vehicle access route to such areas from site entrance(s) and exit(s). At parking spaces complying with 4.1.2(5)(b), provide minimum vertical clearance of 98 in (2490 mm) at the parking space and along at least one vehicle access route to such spaces from site entrance(s) and exit(s).

4.6.6 Passenger Loading Zones. Passenger loading zones shall provide an access aisle at least 60 in (1525 mm) wide and 20 ft (240 in) (6100 mm) long adjacent and parallel to the vehicle pull-up space (see Fig. 10). If there are curbs between the access aisle and the vehicle pull-up space, then a curb ramp complying with 4.7 shall be provided. Vehicle standing spaces and access aisles shall be level with

4.7 Curb Ramps

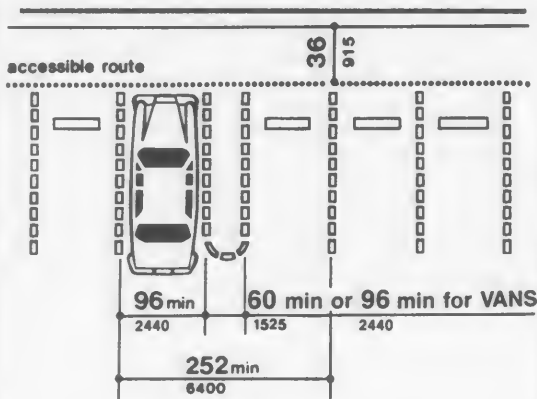

Fig. 9
Dimensions of Parking Spaces

surface slopes not exceeding 1:50 (2%) in all directions.

4.7 Curb Ramps.

4.7.1 Location. Curb ramps complying with 4.7 shall be provided wherever an accessible route crosses a curb.

4.7.2 Slope. Slopes of curb ramps shall comply with 4.8.2. The slope shall be measured as shown in Fig. 11. *Transitions from ramps to walks, gutters, or streets shall be flush and free of abrupt changes. Maximum slopes of adjoining gutters, road surface immediately adjacent to the curb ramp, or accessible route shall not exceed 1:20.*

4.7.3 Width. The minimum width of a curb ramp shall be 36 in (915 mm), exclusive of flared sides.

4.7.4 Surface. Surfaces of curb ramps shall comply with 4.5.

4.7.5 Sides of Curb Ramps. If a curb ramp is located where pedestrians must walk across the ramp, or where it is not protected by handrails or guardrails, it shall have flared sides; the maximum slope of the flare shall be 1:10 (see Fig. 12(a)). Curb ramps with returned curbs

may be used where pedestrians would not normally walk across the ramp (see Fig. 12(b)).

4.7.6 Built-up Curb Ramps. Built-up curb ramps shall be located so that they do not project into vehicular traffic lanes (see Fig. 13).

4.7.7 Detectable Warnings. A curb ramp shall have a *detectable* warning complying with 4.29.2. *The detectable warning shall extend the full width and depth of the curb ramp.*

4.7.8 Obstructions. Curb ramps shall be located or protected to prevent their obstruction by parked vehicles.

4.7.9 Location at Marked Crossings. Curb ramps at marked crossings shall be wholly contained within the markings, excluding any flared sides (see Fig. 15).

4.7.10 Diagonal Curb Ramps. If diagonal (or corner type) curb ramps have returned curbs or other well-defined edges, such edges shall be parallel to the direction of pedestrian flow. The bottom of diagonal curb ramps shall have 48 in (1220 mm) minimum clear space as shown in Fig. 15(c) and (d). If diagonal curb ramps are provided at marked crossings, the 48 in (1220 mm) clear space shall be within the markings (see Fig. 15(c) and (d)). If diagonal curb ramps have flared sides, they shall also have at least a 24 in (610 mm) long segment of straight curb located on each side of the curb ramp and within the marked crossing (see Fig. 15(c)).

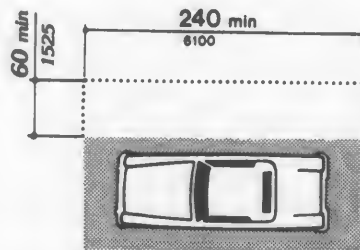

Fig. 10
Access Aisle at Passenger Loading Zones

4.8 Ramps

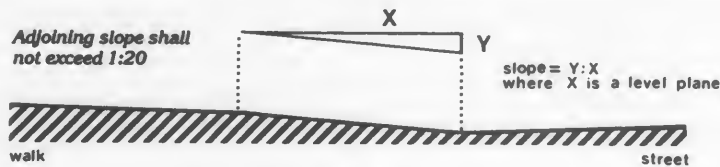
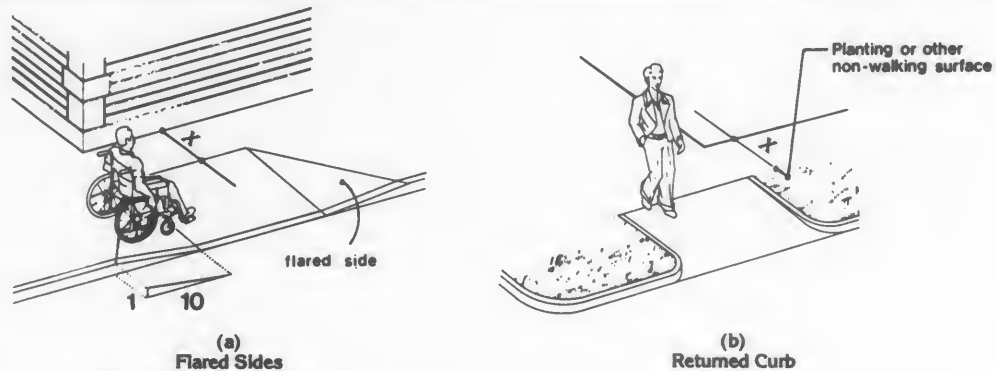

Fig. 11
Measurement of Curb Ramp Slopes



If X is less than 48 in,
then the slope of the flared side
shall not exceed 1:12.

Fig. 12
Sides of Curb Ramps

4.7.11 Islands. Any raised islands in crossings shall be cut through level with the street or have curb ramps at both sides and a level area at least 48 in (1220 mm) long between the curb ramps in the part of the island intersected by the crossings (see Fig. 15(a) and (b)).

4.8 Ramps.

4.8.1* General. Any part of an accessible route with a slope greater than 1:20 shall be considered a ramp and shall comply with 4.8.

4.8.2* Slope and Rise. The least possible slope shall be used for any ramp. The maximum slope of a ramp in new construction shall be 1:12. The maximum rise for any run shall be 30 in (760 mm) (see Fig. 16). Curb ramps

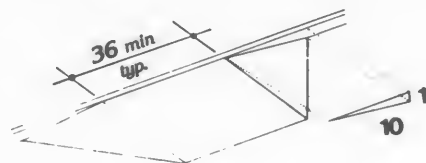

Fig. 13
Built-Up Curb Ramp

and ramps to be constructed on existing sites or in existing buildings or facilities may have slopes and rises as allowed in 4.1.6(3)(a) if space limitations prohibit the use of a 1:12 slope or less.

4.8 Ramps

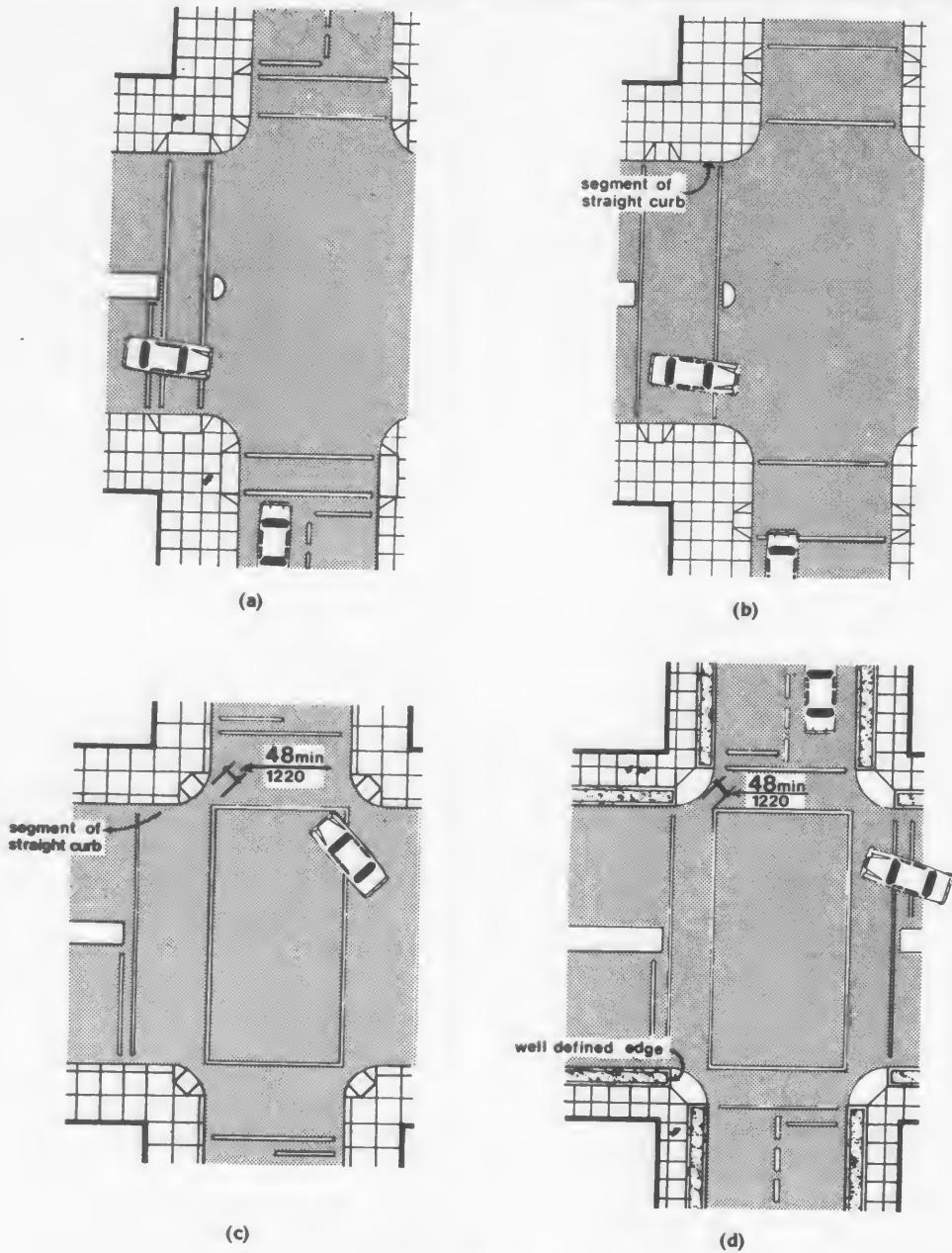
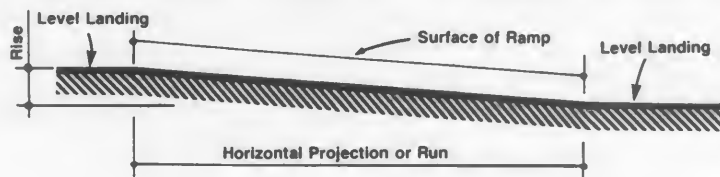

Fig. 15
Curb Ramps at Marked Crossings

4.8 Ramps



| Slope | Maximum Rise | | Maximum Horizontal Projection | |
|----------------|--------------|-----|-------------------------------|----|
| | in | mm | ft | m |
| 1:12 to < 1:16 | 30 | 760 | 30 | 9 |
| 1:16 to < 1:20 | 30 | 760 | 40 | 12 |

Fig. 16
Components of a Single Ramp Run and Sample Ramp Dimensions

4.8.3 Clear Width. The minimum clear width of a ramp shall be 36 in (915 mm).

4.8.4* Landings. Ramps shall have level landings at bottom and top of *each ramp and each ramp run*. Landings shall have the following features:

- (1) The landing shall be at least as wide as the ramp run leading to it.
- (2) The landing length shall be a minimum of 60 in (1525 mm) clear.
- (3) If ramps change direction at landings, the minimum landing size shall be 60 in by 60 in (1525 mm by 1525 mm).
- (4) If a doorway is located at a landing, then the area in front of the doorway shall comply with 4.13.6.

4.8.5* Handrails. If a ramp run has a rise greater than 6 in (150 mm) or a horizontal projection greater than 72 in (1830 mm), then it shall have handrails on both sides. Handrails are not required on curb ramps or *adjacent to seating in assembly areas*. Handrails shall comply with 4.26 and shall have the following features:

(1) Handrails shall be provided along both sides of ramp segments. The inside handrail on switchback or dogleg ramps shall always be continuous.

(2) If handrails are not continuous, they shall extend at least 12 in (305 mm) beyond the top and bottom of the ramp segment and shall be parallel with the floor or ground surface (see Fig. 17).

(3) The clear space between the handrail and the wall shall be 1 - 1/2 in (38 mm).

(4) Gripping surfaces shall be continuous.

(5) *Top of handrail gripping surfaces shall be mounted between 34 in and 38 in (865 mm and 965 mm) above ramp surfaces.*

(6) *Ends of handrails shall be either rounded or returned smoothly to floor, wall, or post.*

(7) *Handrails shall not rotate within their fittings.*

4.8.6 Cross Slope and Surfaces. The cross slope of ramp surfaces shall be no greater than 1:50. Ramp surfaces shall comply with 4.5.

4.9 Stairs

4.8.7 Edge Protection. Ramps and landings with drop-offs shall have curbs, walls, railings, or projecting surfaces that prevent people from slipping off the ramp. Curbs shall be a minimum of 2 in (50 mm) high (see Fig. 17).

4.8.8 Outdoor Conditions. Outdoor ramps and their approaches shall be designed so that water will not accumulate on walking surfaces.

4.9 Stairs.

4.9.1* Minimum Number. Stairs required to be accessible by 4.1 shall comply with 4.9.

4.9.2 Treads and Risers. On any given flight of stairs, all steps shall have uniform riser heights and uniform tread widths. Stair treads shall be no less than 11 in (280 mm) wide, measured from riser to riser (see Fig. 18(a)). Open risers are not permitted.

4.9.3 Nosings. The undersides of nosings shall not be abrupt. The radius of curvature at the leading edge of the tread shall be no greater than 1/2 in (13 mm). Risers shall be sloped or the underside of the nosing shall have an angle not less than 60 degrees from the horizontal. Nosings shall project no more than 1-1/2 in (38 mm) (see Fig. 18).

4.9.4 Handrails. Stairways shall have handrails at both sides of all stairs. Handrails shall comply with 4.26 and shall have the following features:

(1) Handrails shall be continuous along both sides of stairs. The inside handrail on switchback or dogleg stairs shall always be continuous (see Fig. 19(a) and (b)).

(2) If handrails are not continuous, they shall extend at least 12 in (305 mm) beyond the top riser and at least 12 in (305 mm) plus the width of one tread beyond the bottom riser. At the top, the extension shall be parallel with the floor or ground surface. At the bottom, the handrail shall continue to slope for a distance of the width of one tread from the bottom riser; the remainder of the extension shall be horizontal (see Fig. 19(c) and (d)). Handrail extensions shall comply with 4.4.

(3) The clear space between handrails and wall shall be 1-1/2 in (38 mm).

(4) Gripping surfaces shall be uninterrupted by newel posts, other construction elements, or obstructions.

(5) Top of handrail gripping surface shall be mounted between 34 in and 38 in (865 mm and 965 mm) above stair nosings.

(6) Ends of handrails shall be either rounded or returned smoothly to floor, wall or post.

(7) Handrails shall not rotate within their fittings.

4.9.5 Detectable Warnings at Stairs. (Reserved).

4.9.6 Outdoor Conditions. Outdoor stairs and their approaches shall be designed so that water will not accumulate on walking surfaces.

4.10 Elevators.

4.10.1 General. Accessible elevators shall be on an accessible route and shall comply with 4.10 and with the ASME A17.1-1990, Safety Code for Elevators and Escalators. Freight elevators shall not be considered as meeting the requirements of this section unless the only elevators provided are used as combination passenger and freight elevators for the public and employees.

4.10.2 Automatic Operation. Elevator operation shall be automatic. Each car shall be equipped with a self-leveling feature that will automatically bring the car to floor landings within a tolerance of 1/2 in (13 mm) under rated loading to zero loading conditions. This self-leveling feature shall be automatic and independent of the operating device and shall correct the overtravel or undertravel.

4.10.3 Hall Call Buttons. Call buttons in elevator lobbies and halls shall be centered at 42 in (1065 mm) above the floor. Such call buttons shall have visual signals to indicate when each call is registered and when each call is answered. Call buttons shall be a minimum of 3/4 in (19 mm) in the smallest dimension. The button designating the up direction shall be on top. (See Fig. 20.) Buttons shall be raised or flush. Objects mounted beneath hall call buttons shall not project into the elevator lobby more than 4 in (100 mm).

4.10 Elevators

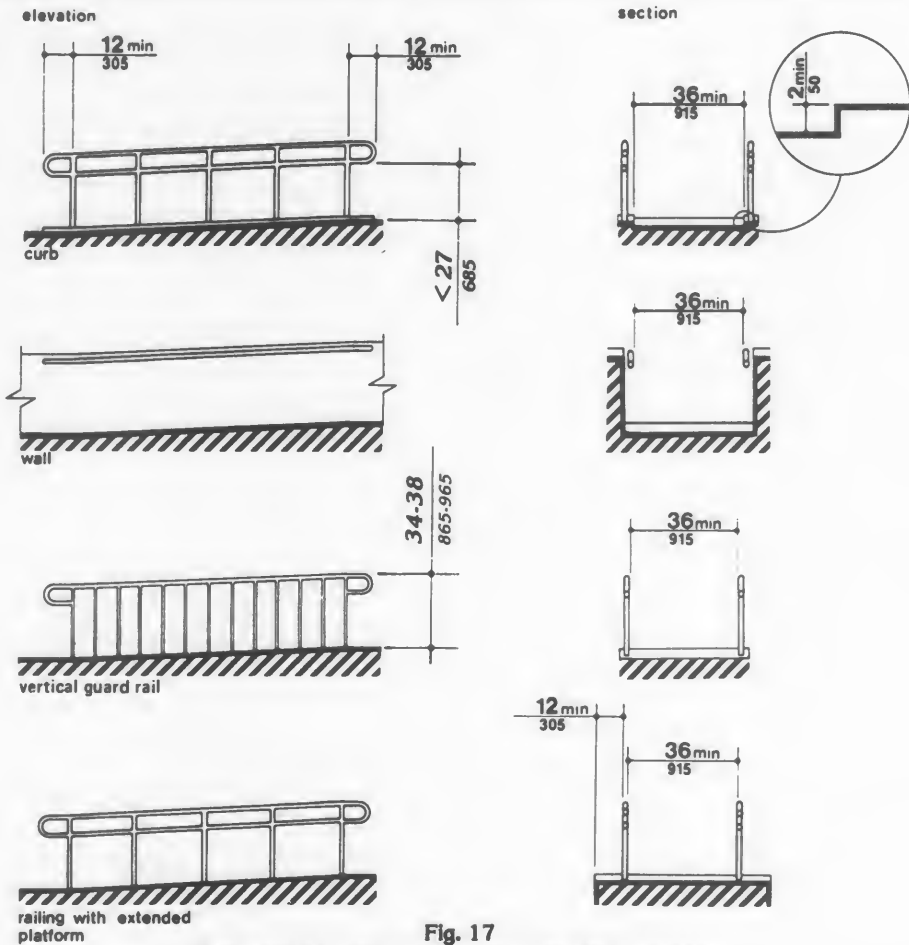

Fig. 17 Examples of Edge Protection and Handrail Extensions

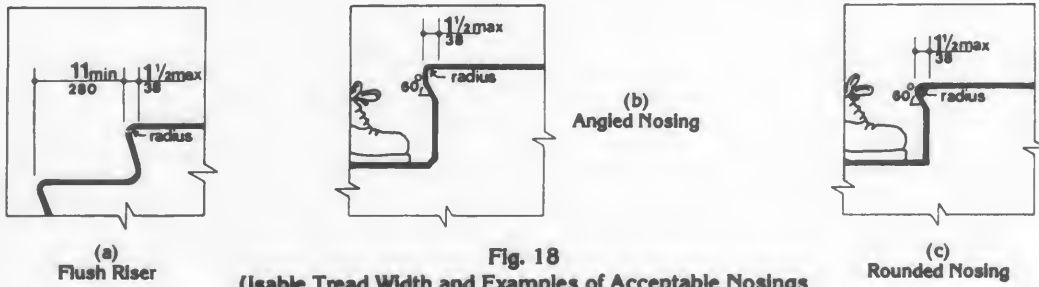
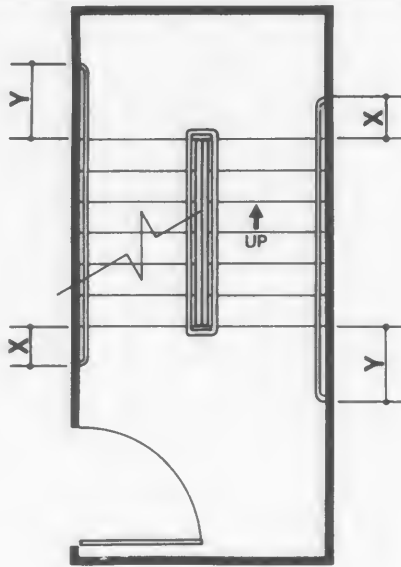
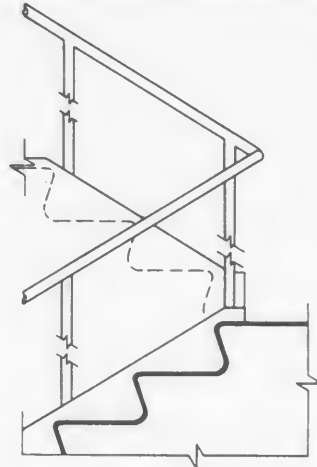

Fig. 18 Usable Tread Width and Examples of Acceptable Nosings

4.10 Elevators



(a)
Plan



(b)
Elevation of Center Handrail

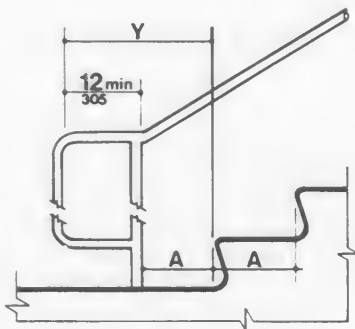

(c)
Extension at Bottom of Run

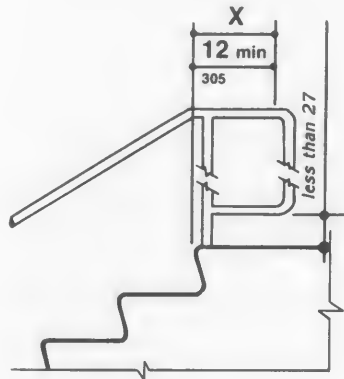

(d)
Extension at Top of Run

NOTE:

X is the 12 in minimum handrail extension required at each top riser.

Y is the minimum handrail extension of 12 in plus the width of one tread that is required at each bottom riser.

Fig. 19
Stair Handrails

4.10 Elevators

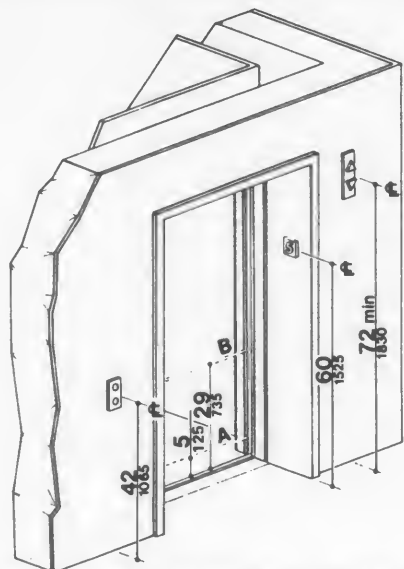

NOTE: The automatic door reopening device is activated if an object passes through either line A or line B. Line A and line B represent the vertical locations of the door reopening device not requiring contact.

Fig. 20
Hoistway and Elevator Entrances

4.10.4 Hall Lanterns. A visible and audible signal shall be provided at each hoistway entrance to indicate which car is answering a call. Audible signals shall sound once for the up direction and twice for the down direction or shall have verbal annunciators that say "up" or "down." Visible signals shall have the following features:

(1) Hall lantern fixtures shall be mounted so that their centerline is at least 72 in (1830 mm) above the lobby floor. (See Fig. 20.)

(2) Visual elements shall be at least 2-1/2 in (64 mm) in the smallest dimension.

(3) Signals shall be visible from the vicinity of the hall call button (see Fig. 20). In-car lanterns located in cars, visible from the vicinity of hall call buttons, and conforming to the above requirements, shall be acceptable.

4.10.5 Raised and Braille Characters on Hoistway Entrances. All elevator hoistway entrances shall have *raised and Braille* floor designations provided on both jambs. The centerline of the characters shall be 60 in (1525 mm) above finish floor. Such characters shall be 2 in (50 mm) high and shall comply with 4.30.4. Permanently applied plates are acceptable if they are permanently fixed to the jambs. (See Fig. 20).

4.10.6* Door Protective and Reopening Device. Elevator doors shall open and close automatically. They shall be provided with a reopening device that will stop and reopen a car door and hoistway door automatically if the door becomes obstructed by an object or person. The device shall be capable of completing these operations without requiring contact for an obstruction passing through the opening at heights of 5 in and 29 in (125 mm and 735 mm) above finish floor (see Fig. 20). Door reopening devices shall remain effective for at least 20 seconds. After such an interval, doors may close in accordance with the requirements of ASME A17.1-1990.

4.10.7* Door and Signal Timing for Hall Calls. The minimum acceptable time from notification that a car is answering a call until the doors of that car start to close shall be calculated from the following equation:

$$T = D/(1.5 \text{ ft/s}) \text{ or } T = D/(445 \text{ mm/s})$$

where T total time in seconds and D distance (in feet or millimeters) from a point in the lobby or corridor 60 in (1525 mm) directly in front of the farthest call button controlling that car to the centerline of its hoistway door (see Fig. 21). For cars with in-car lanterns, T begins when the lantern is visible from the vicinity of hall call buttons and an audible signal is sounded. *The minimum acceptable notification time shall be 5 seconds.*

4.10.8 Door Delay for Car Calls. The minimum time for elevator doors to remain fully open in response to a car call shall be 3 seconds.

4.10.9 Floor Plan of Elevator Cars. The floor area of elevator cars shall provide space for wheelchair users to enter the car, maneuver

4.10.12 Car Controls

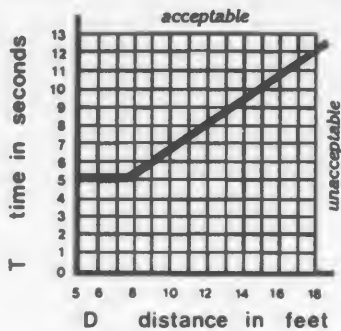

Fig. 21
Graph of Timing Equation

within reach of controls, and exit from the car. Acceptable door opening and inside dimensions shall be as shown in Fig. 22. The clearance between the car platform sill and the edge of any hoistway landing shall be no greater than 1-1/4 in (32 mm).

4.10.10 Floor Surfaces. Floor surfaces shall comply with 4.5.

4.10.11 Illumination Levels. The level of illumination at the car controls, platform, and car threshold and landing sill shall be at least 5 footcandles (53.8 lux).

4.10.12* Car Controls. Elevator control panels shall have the following features:

(1) Buttons. All control buttons shall be at least 3/4 in (19 mm) in their smallest dimension. They shall be *raised* or flush.

(2) Tactile, Braille, and Visual Control Indicators. All control buttons shall be designated by *Braille* and by *raised* standard alphabet characters for letters, arabic characters for numerals, or standard symbols as shown in Fig. 23(a), and as required in ASME A17.1-1990. *Raised* and *Braille* characters and symbols shall comply with 4.30. The call button for the main entry floor shall be designated by a *raised* star at the left of the floor designation (see Fig. 23(a)). All raised designations for control buttons shall be placed immediately to the left of the button to which they apply. Applied plates,

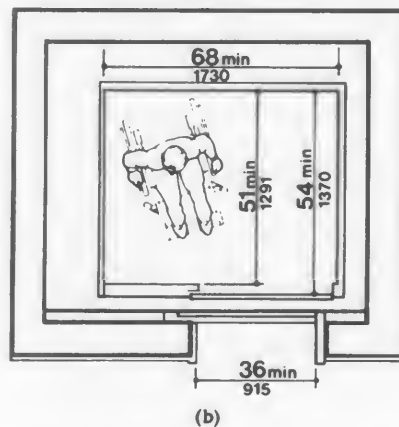
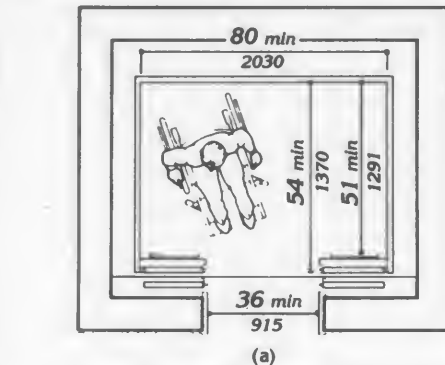

Fig. 22
Minimum Dimensions of Elevator Cars

permanently attached, are an acceptable means to provide raised control designations. Floor buttons shall be provided with visual indicators to show when each call is registered. The visual indicators shall be extinguished when each call is answered.

(3) Height. All floor buttons shall be no higher than 54 in (1370 mm) above the *finish* floor for *side approach* and 48 in (1220 mm) for *front approach*. Emergency controls, including the emergency alarm and emergency stop, shall be grouped at the bottom of the panel and shall have their centerlines no less than 35 in (890 mm) above the finish floor (see Fig. 23(a) and (b)).

4.10.13* Car Position Indicators

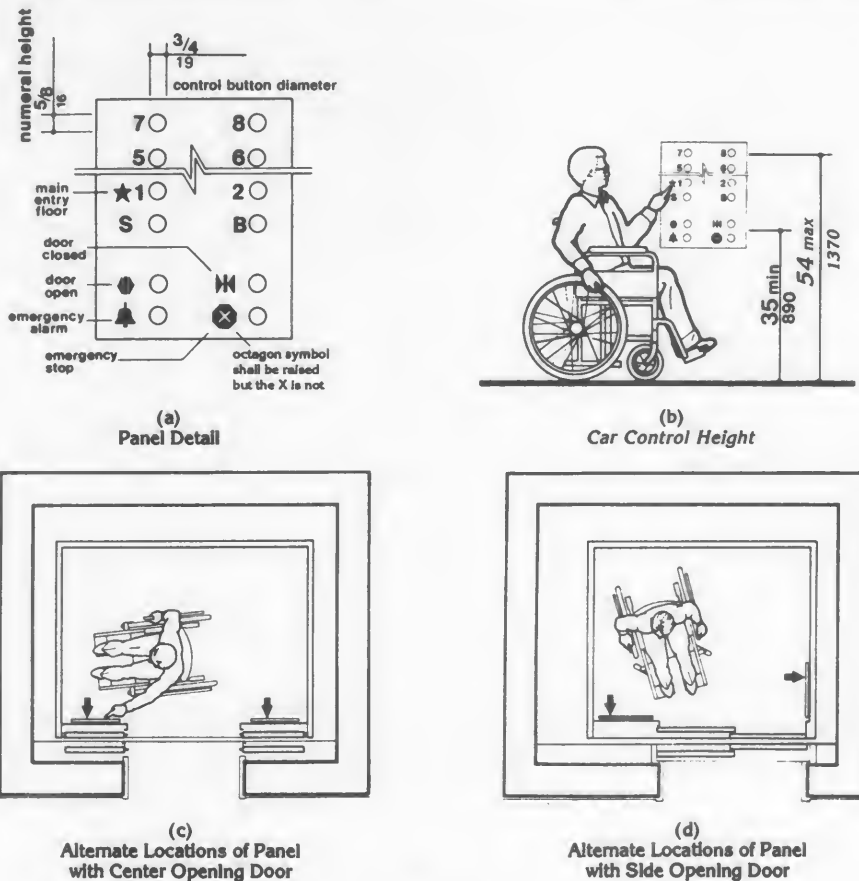

Fig. 23
Car Controls

(4) Location. Controls shall be located on a front wall if cars have center opening doors, and at the side wall or at the front wall next to the door if cars have side opening doors (see Fig. 23(c) and (d)).

4.10.13* Car Position Indicators. In elevator cars, a visual car position indicator shall be provided above the car control panel or over the door to show the position of the elevator in the hoistway. As the car passes or stops at a floor served by the elevators, the corresponding numerals shall illuminate,

and an audible signal shall sound. Numerals shall be a minimum of 1/2 in (13 mm) high. The audible signal shall be no less than 20 decibels with a frequency no higher than 1500 Hz. An automatic verbal announcement of the floor number at which a car stops or which a car passes may be substituted for the audible signal.

4.10.14* Emergency Communications. If provided, emergency two-way communication systems between the elevator and a point outside the hoistway shall comply with ASME

4.11 Platform Lifts (Wheelchair Lifts)

A17.1-1990. The highest operable part of a two-way communication system shall be a maximum of 48 in (1220 mm) from the floor of the car. It shall be identified by a raised symbol and lettering complying with 4.30 and located adjacent to the device. If the system uses a handset then the length of the cord from the panel to the handset shall be at least 29 in (735 mm). *If the system is located in a closed compartment the compartment door hardware shall conform to 4.27, Controls and Operating Mechanisms. The emergency inter-communication system shall not require voice communication.*

4.11 Platform Lifts (Wheelchair Lifts).

4.11.1 Location. Platform lifts (wheelchair lifts) permitted by 4.1 shall comply with the requirements of 4.11.

4.11.2* Other Requirements. If platform lifts (wheelchair lifts) are used, they shall comply with 4.2.4, 4.5, 4.27, and ASME A17.1 Safety Code for Elevators and Escalators, Section XX, 1990.

4.11.3 Entrance. If platform lifts are used then they shall facilitate unassisted entry, operation, and exit from the lift in compliance with 4.11.2.

4.12 Windows.

4.12.1* General. (Reserved).

4.12.2* Window Hardware. (Reserved).

4.13 Doors.

4.13.1 General. Doors required to be accessible by 4.1 shall comply with the requirements of 4.13.

4.13.2 Revolving Doors and Turnstiles. Revolving doors or turnstiles shall not be the only means of passage at an accessible entrance or along an accessible route. An accessible gate or door shall be provided adjacent to the turnstile or revolving door and shall be so designed as to facilitate the same use pattern.

4.13.3 Gates. Gates, including ticket gates, shall meet all applicable specifications of 4.13.

4.13.4 Double-Leaf Doorways. If doorways have two *independently operated* door leaves, then at least one leaf shall meet the specifications in 4.13.5 and 4.13.6. That leaf shall be an active leaf.

4.13.5 Clear Width. Doorways shall have a minimum clear opening of 32 in (815 mm) with the door open 90 degrees, measured between the face of the door and the *opposite* stop (see Fig. 24(a), (b), (c), and (d)). Openings more than 24 in (610 mm) in depth shall comply with 4.2.1 and 4.3.3 (see Fig. 24(e)).

EXCEPTION: Doors not requiring full user passage, such as shallow closets, may have the clear opening reduced to 20 in (510 mm) minimum.

4.13.6 Maneuvering Clearances at Doors. Minimum maneuvering clearances at doors that are not automatic or power-assisted shall be as shown in Fig. 25. The floor or ground area within the required clearances shall be level and clear.

EXCEPTION: Entry doors to acute care hospital bedrooms for in-patients shall be exempted from the requirement for space at the latch side of the door (see dimension "x" in Fig. 25) if the door is at least 44 in (1120 mm) wide.

4.13.7 Two Doors in Series. The minimum space between two hinged or pivoted doors in series shall be 48 in (1220 mm) plus the width of any door swinging into the space. Doors in series shall swing either in the same direction or away from the space between the doors (see Fig. 26).

4.13.8* Thresholds at Doorways. Thresholds at doorways shall not exceed 3/4 in (19 mm) in height for exterior sliding doors or 1/2 in (13 mm) for other types of doors. Raised thresholds and floor level changes at accessible doorways shall be beveled with a slope no greater than 1:2 (see 4.5.2).

4.13.9* Door Hardware. Handles, pulls, latches, locks, and other operating devices on accessible doors shall have a shape that is easy

4.13 Doors

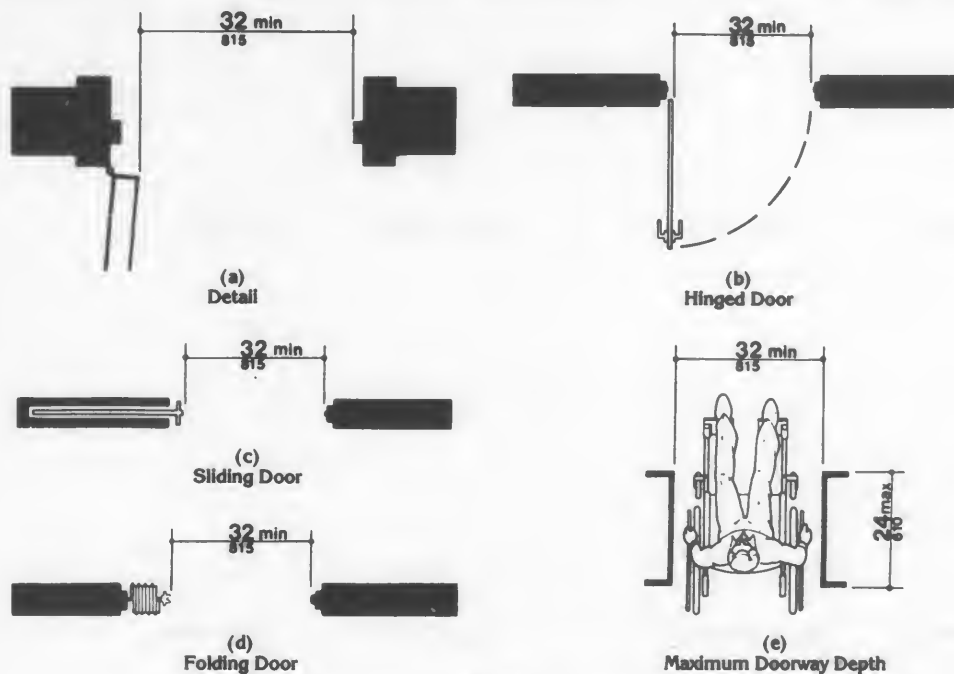

Fig. 24
Clear Doorway Width and Depth

to grasp with one hand and does not require tight grasping, tight pinching, or twisting of the wrist to operate. Lever-operated mechanisms, push-type mechanisms, and U-shaped handles are acceptable designs. When sliding doors are fully open, operating hardware shall be exposed and usable from both sides. *Hardware required for accessible door passage shall be mounted no higher than 48 in (1220 mm) above finished floor.*

4.13.10* Door Closers. If a door has a closer, then the sweep period of the closer shall be adjusted so that from an open position of 70 degrees, the door will take at least 3 seconds to move to a point 3 in (75 mm) from the latch, measured to the leading edge of the door.

4.13.11* Door Opening Force. The maximum force for pushing or pulling open a door shall be as follows:

(1) Fire doors shall have the minimum opening force allowable by the appropriate administrative authority.

(2) Other doors.

(a) exterior hinged doors: *(Reserved)*.

(b) interior hinged doors: 5 lbf (22.2N)

(c) sliding or folding doors: 5 lbf (22.2N)

These forces do not apply to the force required to retract latch bolts or disengage other devices that may hold the door in a closed position.

4.13 Doors

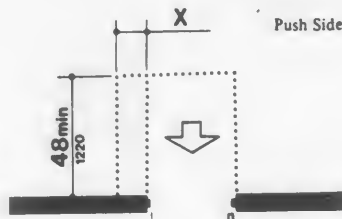
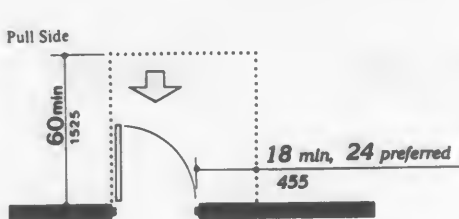

NOTE: x = 12 in (305 mm) if door has both a closer and latch.

(a)
Front Approaches — Swinging Doors

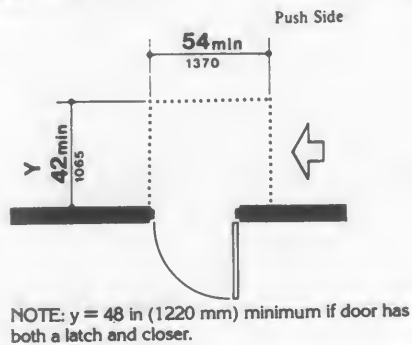
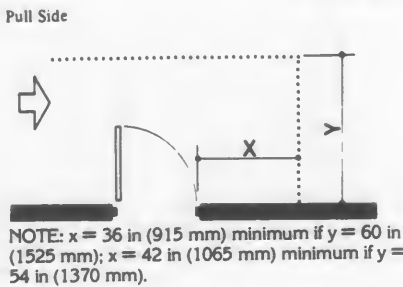

(b)
Hinge Side Approaches — Swinging Doors

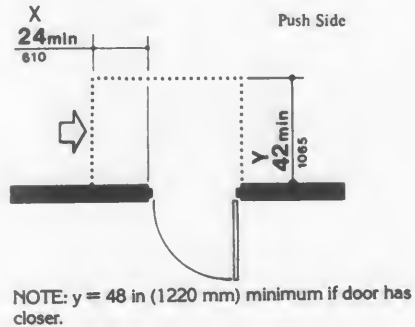
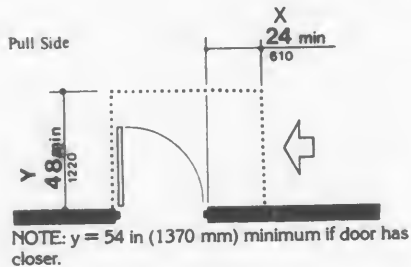

(c)
Latch Side Approaches — Swinging Doors

NOTE: All doors in alcoves shall comply with the clearances for front approaches.

Fig. 25
Maneuvering Clearances at Doors

4.13 Doors

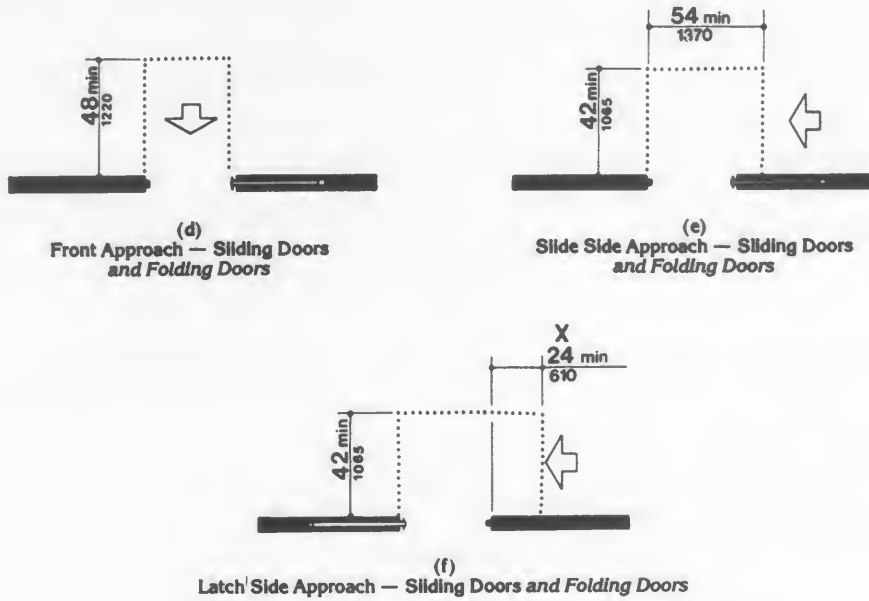

NOTE: All doors in alcoves shall comply with the clearances for front approaches.

Fig. 25
Maneuvering Clearances at Doors (Continued)

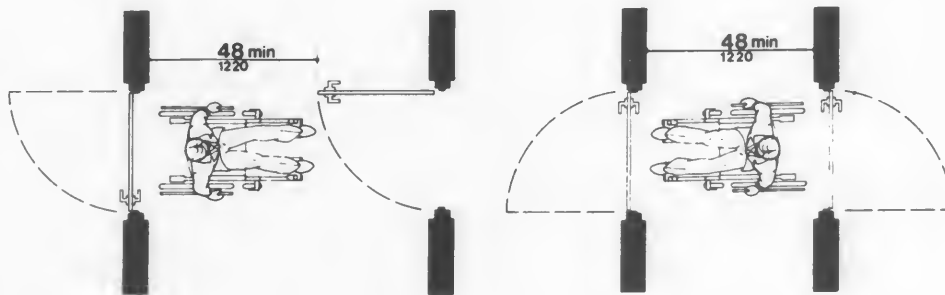

Fig. 26
Two Hinged Doors in Series

4.14 Entrances

4.13.12* Automatic Doors and Power-Assisted Doors. If an automatic door is used, then it shall comply with *ANSI/BHMA A156.10-1985*. Slowly opening, low-powered, automatic doors shall comply with *ANSI A156.19-1984*. Such doors shall not open to back check faster than 3 seconds and shall require no more than 15 lbf (66.6N) to stop door movement. If a power-assisted door is used, its door-opening force shall comply with 4.13.11 and its closing shall conform to the requirements in *ANSI A156.19-1984*.

4.14 Entrances.

4.14.1 Minimum Number. Entrances required to be accessible by 4.1 shall be part of an accessible route complying with 4.3. Such entrances shall be connected by an accessible route to public transportation stops, to accessible parking and passenger loading zones, and to public streets or sidewalks if available (see 4.3.2(1)). They shall also be connected by an accessible route to all accessible spaces or elements within the building or facility.

4.14.2 Service Entrances. A service entrance shall not be the sole accessible entrance unless it is the only entrance to a building or facility (for example, in a factory or garage).

4.15 Drinking Fountains and Water Coolers.

4.15.1 Minimum Number. Drinking fountains or water coolers required to be accessible by 4.1 shall comply with 4.15.

4.15.2* Spout Height. Spouts shall be no higher than 36 in (915 mm), measured from the floor or ground surfaces to the spout outlet (see Fig. 27(a)).

4.15.3 Spout Location. The spouts of drinking fountains and water coolers shall be at the front of the unit and shall direct the water flow in a trajectory that is parallel or nearly parallel to the front of the unit. The spout shall provide a flow of water at least 4 in (100 mm) high so as to allow the insertion of a cup or glass under the flow of water. On an accessible drinking fountain with a round or

oval bowl, the spout must be positioned so the flow of water is within 3 in (75 mm) of the front edge of the fountain.

4.15.4 Controls. Controls shall comply with 4.27.4. Unit controls shall be front mounted or side mounted near the front edge.

4.15.5 Clearances.

(1) Wall- and post-mounted cantilevered units shall have a clear knee space between the bottom of the apron and the floor or ground at least 27 in (685 mm) high, 30 in (760 mm) wide, and 17 in to 19 in (430 mm to 485 mm) deep (see Fig. 27(a) and (b)). Such units shall also have a minimum clear floor space 30 in by 48 in (760 mm by 1220 mm) to allow a person in a wheelchair to approach the unit facing forward.

(2) Free-standing or built-in units not having a clear space under them shall have a clear floor space at least 30 in by 48 in (760 mm by 1220 mm) that allows a person in a wheelchair to make a parallel approach to the unit (see Fig. 27(c) and (d)). This clear floor space shall comply with 4.2.4.

4.16 Water Closets.

4.16.1 General. Accessible water closets shall comply with 4.16.

4.16.2 Clear Floor Space. Clear floor space for water closets not in stalls shall comply with Fig. 28. Clear floor space may be arranged to allow either a left-handed or right-handed approach.

4.16.3* Height. The height of water closets shall be 17 in to 19 in (430 mm to 485 mm), measured to the top of the toilet seat (see Fig. 29(b)). Seats shall not be sprung to return to a lifted position.

4.16.4* Grab Bars. Grab bars for water closets not located in stalls shall comply with 4.26 and Fig. 29. The grab bar behind the water closet shall be 36 in (915 mm) minimum.

4.16.5* Flush Controls. Flush controls shall be hand operated or automatic and shall comply with 4.27.4. Controls for flush valves

4.17 Toilet Stalls

shall be mounted on the wide side of toilet areas no more than 44 in (1120 mm) above the floor.

4.16.6 Dispensers. Toilet paper dispensers shall be installed within reach, as shown in Fig. 29(b). *Dispensers that control delivery, or that do not permit continuous paper flow, shall not be used.*

4.17 Toilet Stalls.

4.17.1 Location. Accessible toilet stalls shall be on an accessible route and shall meet the requirements of 4.17.

4.17.2 Water Closets. Water closets in accessible stalls shall comply with 4.16.

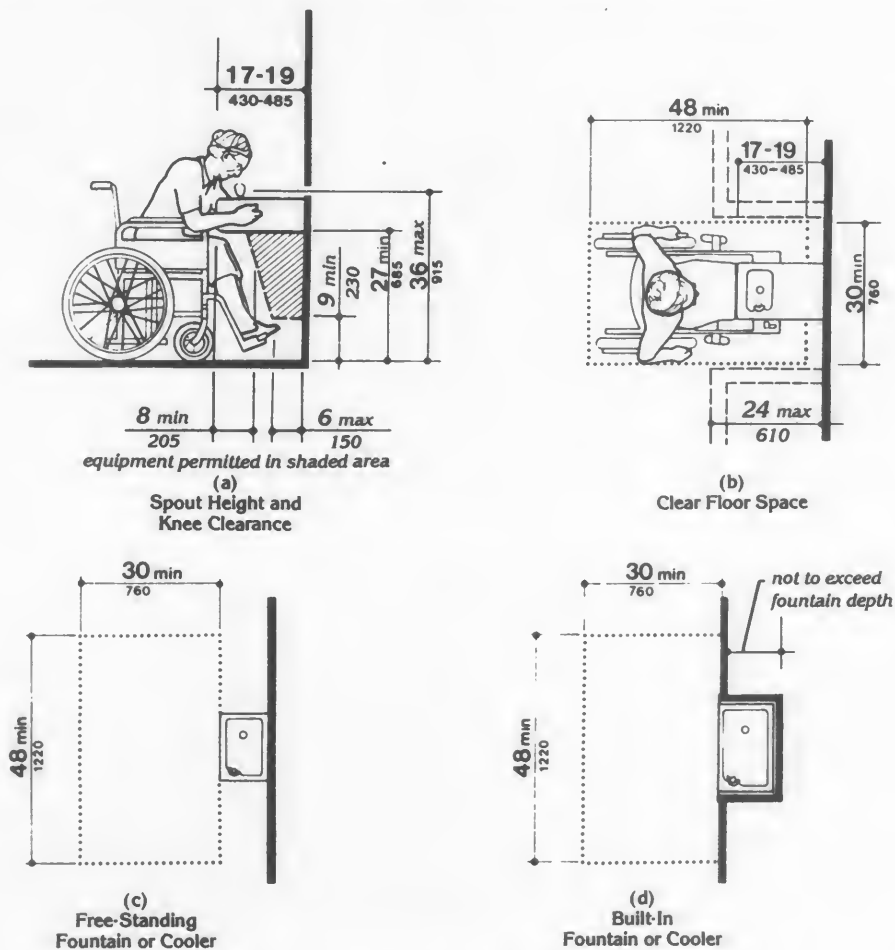

Fig. 27
Drinking Fountains and Water Coolers

4.17 Toilet Stalls

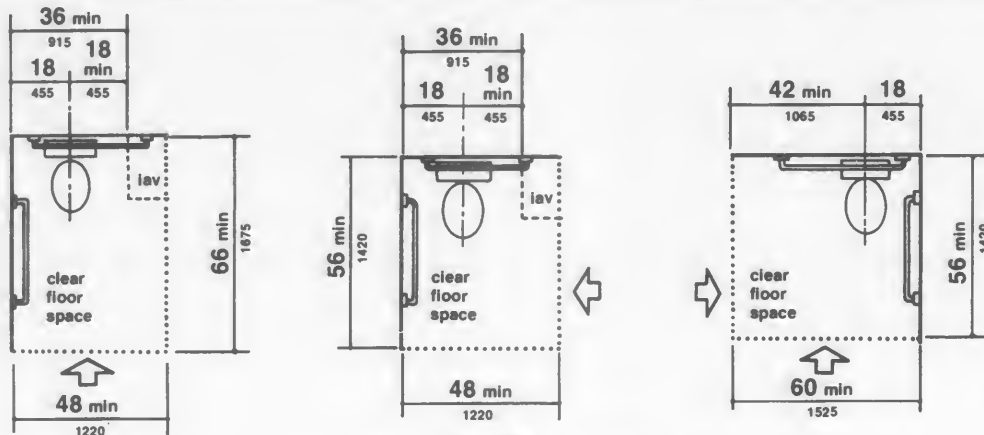

Fig. 28
Clear Floor Space at Water Closets

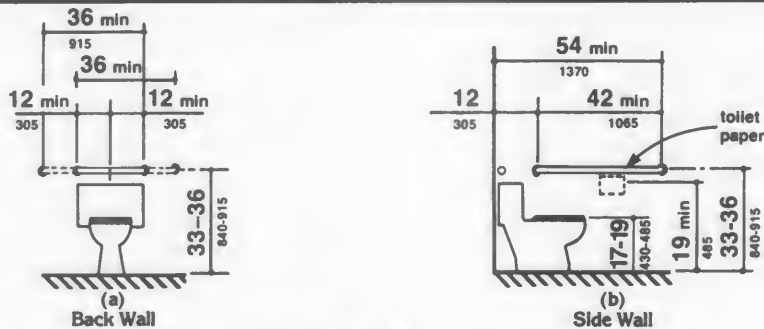

Fig. 29
Grab Bars at Water Closets

4.17.3* Size and Arrangement. The size and arrangement of the standard toilet stall shall comply with Fig. 30(a), *Standard Stall*. Standard toilet stalls with a minimum depth of 56 in (1420 mm) (see Fig. 30(a)) shall have wall-mounted water closets. If the depth of a standard toilet stall is increased at least 3 in (75 mm), then a floor-mounted water closet may be used. Arrangements shown for standard toilet stalls may be reversed to allow either a left- or right-hand approach. Additional stalls shall be provided in conformance with 4.22.4.

EXCEPTION: In instances of alteration work where provision of a standard stall (Fig. 30(a))

is technically infeasible or where plumbing code requirements prevent combining existing stalls to provide space, either alternate stall (Fig. 30(b)) may be provided in lieu of the standard stall.

4.17.4 Toe Clearances. In standard stalls, the front partition and at least one side partition shall provide a toe clearance of at least 9 in (230 mm) above the floor. If the depth of the stall is greater than 60 in (1525 mm), then the toe clearance is not required.

4.17.5* Doors. Toilet stall doors, including door hardware, shall comply with 4.13. If toilet stall approach is from the latch side of the stall door, clearance between the door side of the

4.17 Toilet Stalls

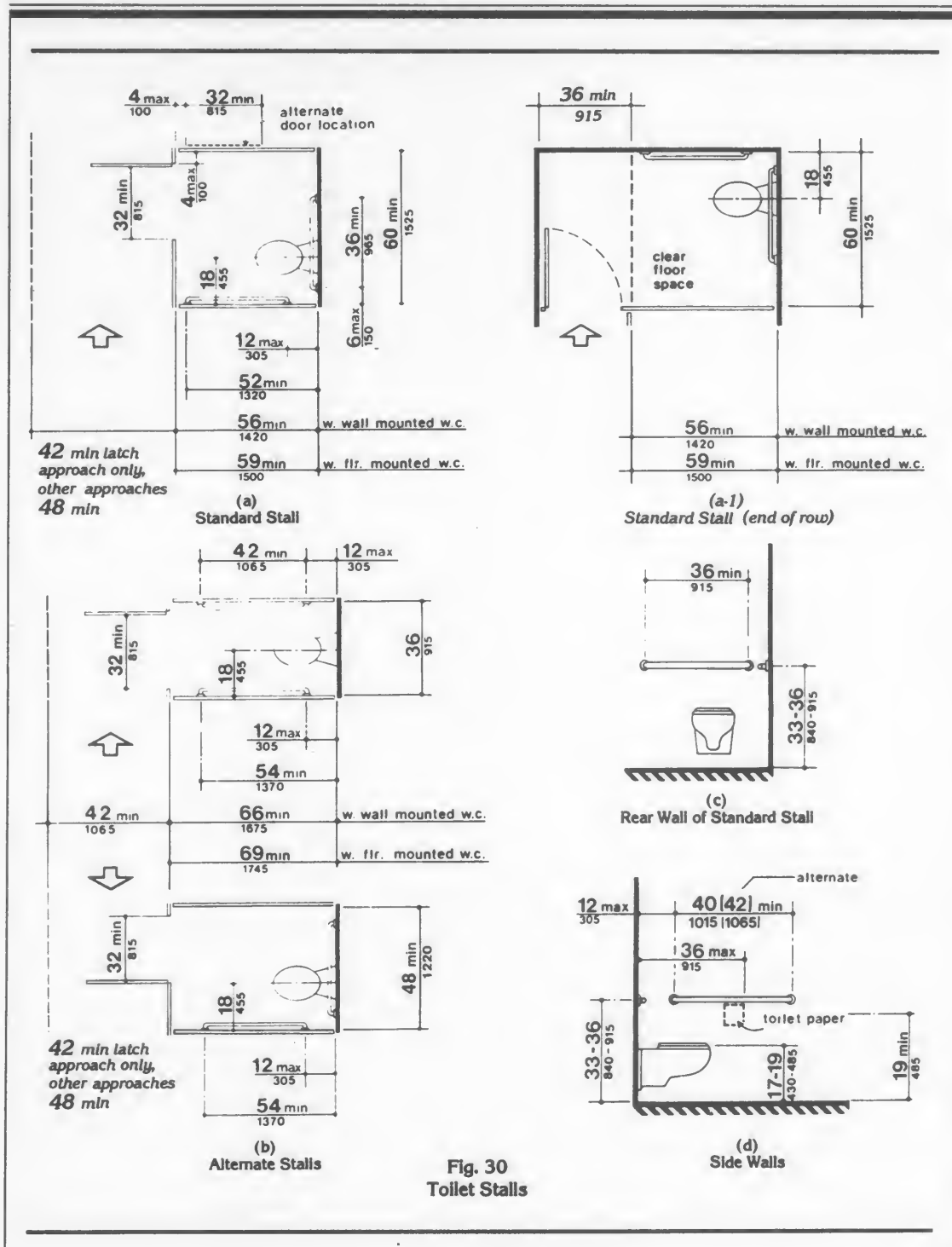

Fig. 30 Toilet Stalls

4.19 Lavatories and Mirrors

stall and any obstruction may be reduced to a minimum of 42 in (1065 mm) (Fig. 30).

4.17.6 Grab Bars. Grab bars complying with the length and positioning shown in Fig. 30(a), (b), (c), and (d) shall be provided. Grab bars may be mounted with any desired method as long as they have a gripping surface at the locations shown and do not obstruct the required clear floor area. Grab bars shall comply with 4.26.

4.18 Urinals.

4.18.1 General. Accessible urinals shall comply with 4.18.

4.18.2 Height. Urinals shall be stall-type or wall-hung with an elongated rim at a maximum of 17 in (430 mm) above the finish floor.

4.18.3 Clear Floor Space. A clear floor space 30 in by 48 in (760 mm by 1220 mm) shall be provided in front of urinals to allow forward approach. This clear space shall adjoin or overlap an accessible route and shall comply with 4.2.4. *Urinal shields that do not extend beyond the front edge of the urinal rim may be provided with 29 in (735 mm) clearance between them.*

4.18.4 Flush Controls. Flush controls shall be hand operated or automatic, and shall comply with 4.27.4, and shall be mounted no more than 44 in (1120 mm) above the finish floor.

4.19 Lavatories and Mirrors.

4.19.1 General. The requirements of 4.19 shall apply to lavatory fixtures, vanities, and built-in lavatories.

4.19.2 Height and Clearances. Lavatories shall be mounted with the rim or counter surface no higher than 34 in (865 mm) above the finish floor. Provide a clearance of at least 29 in (735 mm) above the finish floor to the bottom of the apron. Knee and toe clearance shall comply with Fig. 31.

4.19.3 Clear Floor Space. A clear floor space 30 in by 48 in (760 mm by 1220 mm) complying with 4.2.4 shall be provided in front of a lavatory to allow forward approach. Such

clear floor space shall adjoin or overlap an accessible route and shall extend a maximum of 19 in (485 mm) underneath the lavatory (see Fig. 32).

4.19.4 Exposed Pipes and Surfaces. Hot water and drain pipes under lavatories shall be insulated or otherwise configured to protect against contact. There shall be no sharp or abrasive surfaces under lavatories.

4.19.5 Faucets. Faucets shall comply with 4.27.4. Lever-operated, push-type, and electronically controlled mechanisms are examples of acceptable designs. *If self-closing valves are*

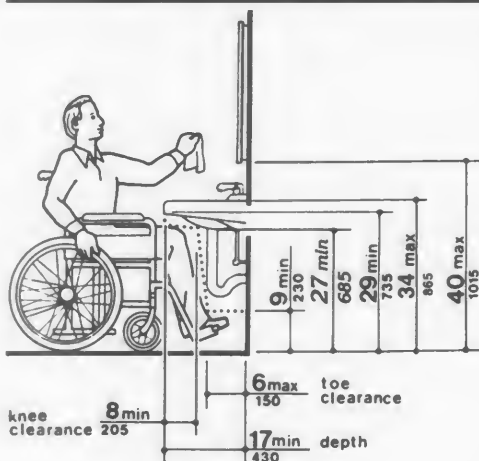

Fig. 31
Lavatory Clearances

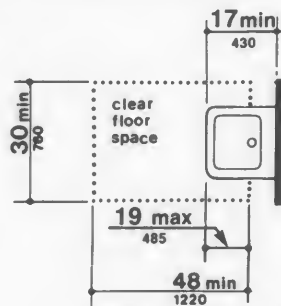

Fig. 32
Clear Floor Space at Lavatories

4.20 Bathtubs

used the faucet shall remain open for at least 10 seconds.

4.19.6* Mirrors. Mirrors shall be mounted with the bottom edge of the reflecting surface no higher than 40 in (1015 mm) above the finish floor (see Fig. 31).

4.20 Bathtubs.

4.20.1 General. Accessible bathtubs shall comply with 4.20.

4.20.2 Floor Space. Clear floor space in front of bathtubs shall be as shown in Fig. 33.

4.20.3 Seat. An in-tub seat or a seat at the head end of the tub shall be provided as shown in Fig. 33 and 34. The structural strength of seats and their attachments shall comply with 4.26.3. Seats shall be mounted securely and shall not slip during use.

4.20.4 Grab Bars. Grab bars complying with 4.26 shall be provided as shown in Fig. 33 and 34.

4.20.5 Controls. Faucets and other controls complying with 4.27.4 shall be located as shown in Fig. 34.

4.20.6 Shower Unit. A shower spray unit with a hose at least 60 in (1525 mm) long that can be used both as a fixed shower head and as a hand-held shower shall be provided.

4.20.7 Bathtub Enclosures. If provided, enclosures for bathtubs shall not obstruct controls or transfer from wheelchairs onto bathtub seats or into tubs. Enclosures on bathtubs shall not have tracks mounted on their rims.

4.21 Shower Stalls.

4.21.1* General. Accessible shower stalls shall comply with 4.21.

4.21.2 Size and Clearances. Except as specified in 9.1.2, shower stall size and clear floor space shall comply with Fig. 35(a) or (b). The shower stall in Fig. 35(a) shall be 36 in by 36 in (915 mm by 915 mm). Shower stalls required by 9.1.2 shall comply with Fig. 57(a)

or (b). The shower stall in Fig. 35(b) will fit into the space required for a bathtub.

4.21.3 Seat. A seat shall be provided in shower stalls 36 in by 36 in (915 mm by 915 mm) and shall be as shown in Fig. 36. The seat shall be mounted 17 in to 19 in (430 mm to 485 mm) from the bathroom floor and shall extend the full depth of the stall. In a 36 in by 36 in (915 mm by 915 mm) shower stall, the seat shall be on the wall opposite the controls. Where a fixed seat is provided in a 30 in by 60 in minimum (760 mm by 1525 mm) shower stall, it shall be a folding type and shall be mounted on the wall adjacent to the controls as shown in Fig. 57. The structural strength of seats and their attachments shall comply with 4.26.3.

4.21.4 Grab Bars. Grab bars complying with 4.26 shall be provided as shown in Fig. 37.

4.21.5 Controls. Faucets and other controls complying with 4.27.4 shall be located as shown in Fig. 37. In shower stalls 36 in by 36 in (915 mm by 915 mm), all controls, faucets, and the shower unit shall be mounted on the side wall opposite the seat.

4.21.6 Shower Unit. A shower spray unit with a hose at least 60 in (1525 mm) long that can be used both as a fixed shower head and as a hand-held shower shall be provided.

EXCEPTION: In unmonitored facilities where vandalism is a consideration, a fixed shower head mounted at 48 in (1220 mm) above the shower floor may be used in lieu of a hand-held shower head.

4.21.7 Curbs. If provided, curbs in shower stalls 36 in by 36 in (915 mm by 915 mm) shall be no higher than 1/2 in (13 mm). Shower stalls that are 30 in by 60 in (760 mm by 1525 mm) minimum shall not have curbs.

4.21.8 Shower Enclosures. If provided, enclosures for shower stalls shall not obstruct controls or obstruct transfer from wheelchairs onto shower seats.

4.22 Toilet Rooms.

4.22.1 Minimum Number. Toilet facilities required to be accessible by 4.1 shall comply

4.21 Shower Stalls

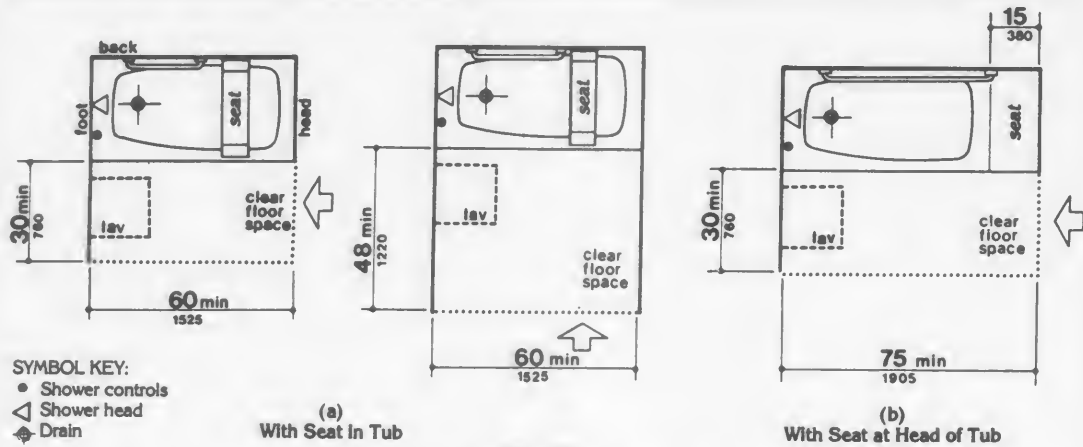
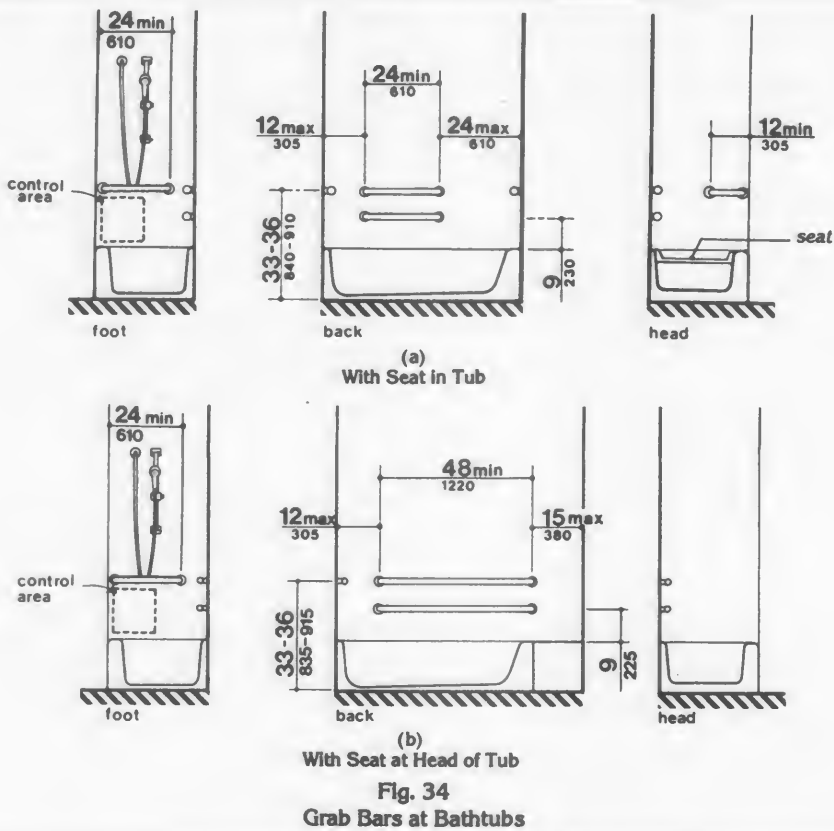

Fig. 33
Clear Floor Space at Bathtubs



4.22 Toilet Rooms

with 4.22. Accessible toilet rooms shall be on an accessible route.

4.22.2 Doors. All doors to accessible toilet rooms shall comply with 4.13. Doors shall not swing into the clear floor space required for any fixture.

4.22.3* Clear Floor Space. The accessible fixtures and controls required in 4.22.4, 4.22.5, 4.22.6, and 4.22.7 shall be on an accessible route. An unobstructed turning space complying with 4.2.3 shall be provided within an accessible toilet room. The clear floor space at fixtures and controls, the accessible route, and the turning space may overlap.

4.22.4 Water Closets. If toilet stalls are provided, then at least one shall be a standard

toilet stall complying with 4.17; where 6 or more stalls are provided, in addition to the stall complying with 4.17.3, at least one stall 36 in (915 mm) wide with an outward swinging, self-closing door and parallel grab bars complying with Fig. 30(d) and 4.26 shall be provided. Water closets in such stalls shall comply with 4.16. If water closets are not in stalls, then at least one shall comply with 4.16.

4.22.5 Urinals. If urinals are provided, then at least one shall comply with 4.18.

4.22.6 Lavatories and Mirrors. If lavatories and mirrors are provided, then at least one of each shall comply with 4.19.

4.22.7 Controls and Dispensers. If controls, dispensers, receptacles, or other

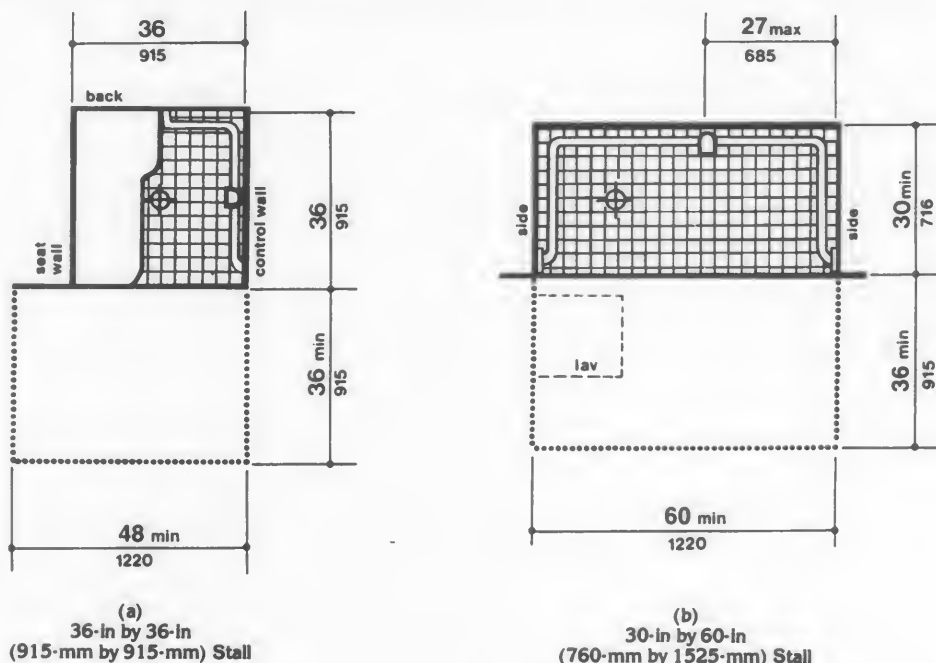

Fig. 35
Shower Size and Clearances

4.24 Sinks

space complying with 4.2.3 shall be provided within an accessible bathroom. The clear floor spaces at fixtures and controls, the accessible route, and the turning space may overlap.

4.23.4 Water Closets. If toilet stalls are provided, then at least one shall be a standard toilet stall complying with 4.17; *where 6 or more stalls are provided, in addition to the stall complying with 4.17.3, at least one stall 36 in (915 mm) wide with an outward swinging, self-closing door and parallel grab bars complying with Fig. 30(d) and 4.26 shall be provided.* Water closets in such stalls shall comply with 4.16. If water closets are not in stalls, then at least one shall comply with 4.16.

4.23.5 Urinals. If urinals are provided, then at least one shall comply with 4.18.

4.23.6 Lavatories and Mirrors. If lavatories and mirrors are provided, then at least one of each shall comply with 4.19.

4.23.7 Controls and Dispensers. If controls, dispensers, receptacles, or other equipment are provided, then at least one of each shall be on an accessible route and shall comply with 4.27.

4.23.8 Bathing and Shower Facilities. If tubs or showers are provided, then at least one accessible tub that complies with 4.20 or at least one accessible shower that complies with 4.21 shall be provided.

4.23.9* Medicine Cabinets. If medicine cabinets are provided, at least one shall be located with a usable shelf no higher than 44 in (1120 mm) above the floor space. The floor space shall comply with 4.2.4.

4.24 Sinks.

4.24.1 General. Sinks required to be accessible by 4.1 shall comply with 4.24.

4.24.2 Height. Sinks shall be mounted with the counter or rim no higher than 34 in (865 mm) above the finish floor.

4.24.3 Knee Clearance. Knee clearance that is at least 27 in (685 mm) high, 30 in (760 mm) wide, and 19 in (485 mm) deep shall be pro-

vided underneath sinks.

4.24.4 Depth. Each sink shall be a maximum of 6-1/2 in (165 mm) deep.

4.24.5 Clear Floor Space. A clear floor space at least 30 in by 48 in (760 mm by 1220 mm) complying with 4.2.4 shall be provided in front of a sink to allow forward approach. The clear floor space shall be on an accessible route and shall extend a maximum of 19 in (485 mm) underneath the sink (see Fig. 32).

4.24.6 Exposed Pipes and Surfaces. Hot water and drain pipes exposed under sinks shall be insulated or otherwise configured so as to protect against contact. There shall be no sharp or abrasive surfaces under sinks.

4.24.7 Faucets. Faucets shall comply with 4.27.4. Lever-operated, push-type, touch-type, or electronically controlled mechanisms are acceptable designs.

4.25 Storage.

4.25.1 General. Fixed storage facilities such as cabinets, shelves, closets, and drawers required to be accessible by 4.1 shall comply with 4.25.

4.25.2 Clear Floor Space. A clear floor space at least 30 in by 48 in (760 mm by 1220 mm) complying with 4.2.4 that allows either a forward or parallel approach by a person using a wheelchair shall be provided at accessible storage facilities.

4.25.3 Height. Accessible storage spaces shall be within at least one of the reach ranges specified in 4.2.5 and 4.2.6 (see Fig. 5 and Fig. 6). Clothes rods or shelves shall be a maximum of 54 in (1370 mm) above the finish floor for a side approach. Where the distance from the wheelchair to the clothes rod or shelf exceeds 10 in (255 mm) (as in closets without accessible doors) the height and depth to the rod or shelf shall comply with Fig. 38(a) and Fig. 38(b).

4.25.4 Hardware. Hardware for accessible storage facilities shall comply with 4.27.4. Touch latches and U-shaped pulls are acceptable.

4.26 Handrails, Grab Bars, and Tub and Shower Seats

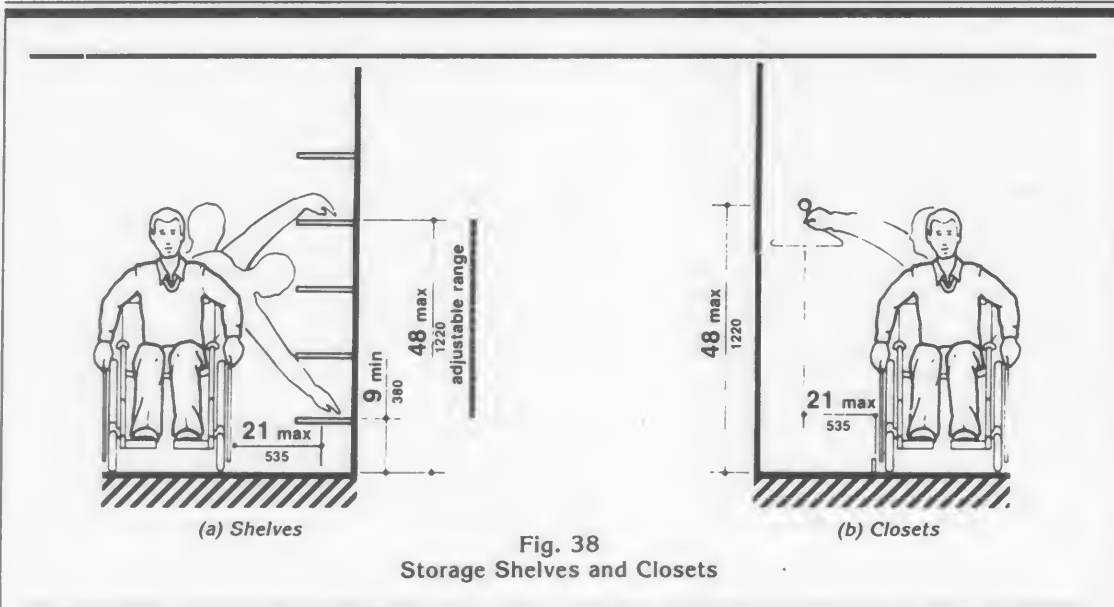

4.26 Handrails, Grab Bars, and Tub and Shower Seats.

4.26.1* General. All handrails, grab bars, and tub and shower seats *required to be accessible* by 4.1, 4.8, 4.9, 4.16, 4.17, 4.20 or 4.21 shall comply with 4.26.

4.26.2* Size and Spacing of Grab Bars and Handrails. The diameter or width of the gripping surfaces of a handrail or grab bar shall be 1-1/4 in to 1-1/2 in (32 mm to 38 mm), or the shape shall provide an equivalent gripping surface. If handrails or grab bars are mounted adjacent to a wall, the space between the wall and the grab bar shall be 1-1/2 in (38 mm) (see Fig. 39(a), (b), (c), and (e)). Handrails may be located in a recess if the recess is a maximum of 3 in (75 mm) deep and extends at least 18 in (455 mm) above the top of the rail (see Fig. 39(d)).

4.26.3 Structural Strength. The structural strength of grab bars, tub and shower seats, fasteners, and mounting devices shall meet the following specification:

(1) Bending stress in a grab bar or seat induced by the maximum bending moment from the application of 250 lbf (1112N) shall

be less than the allowable stress for the material of the grab bar or seat.

(2) Shear stress induced in a grab bar or seat by the application of 250 lbf (1112N) shall be less than the allowable shear stress for the material of the grab bar or seat. If the connection between the grab bar or seat and its mounting bracket or other support is considered to be fully restrained, then direct and torsional shear stresses shall be totaled for the combined shear stress, which shall not exceed the allowable shear stress.

(3) Shear force induced in a fastener or mounting device from the application of 250 lbf (1112N) shall be less than the allowable lateral load of either the fastener or mounting device or the supporting structure, whichever is the smaller allowable load.

(4) Tensile force induced in a fastener by a direct tension force of 250 lbf (1112N) plus the maximum moment from the application of 250 lbf (1112N) shall be less than the allowable withdrawal load between the fastener and the supporting structure.

(5) Grab bars shall not rotate within their fittings.

4.26 Handrails, Grab Bars, and Tub and Shower Seats

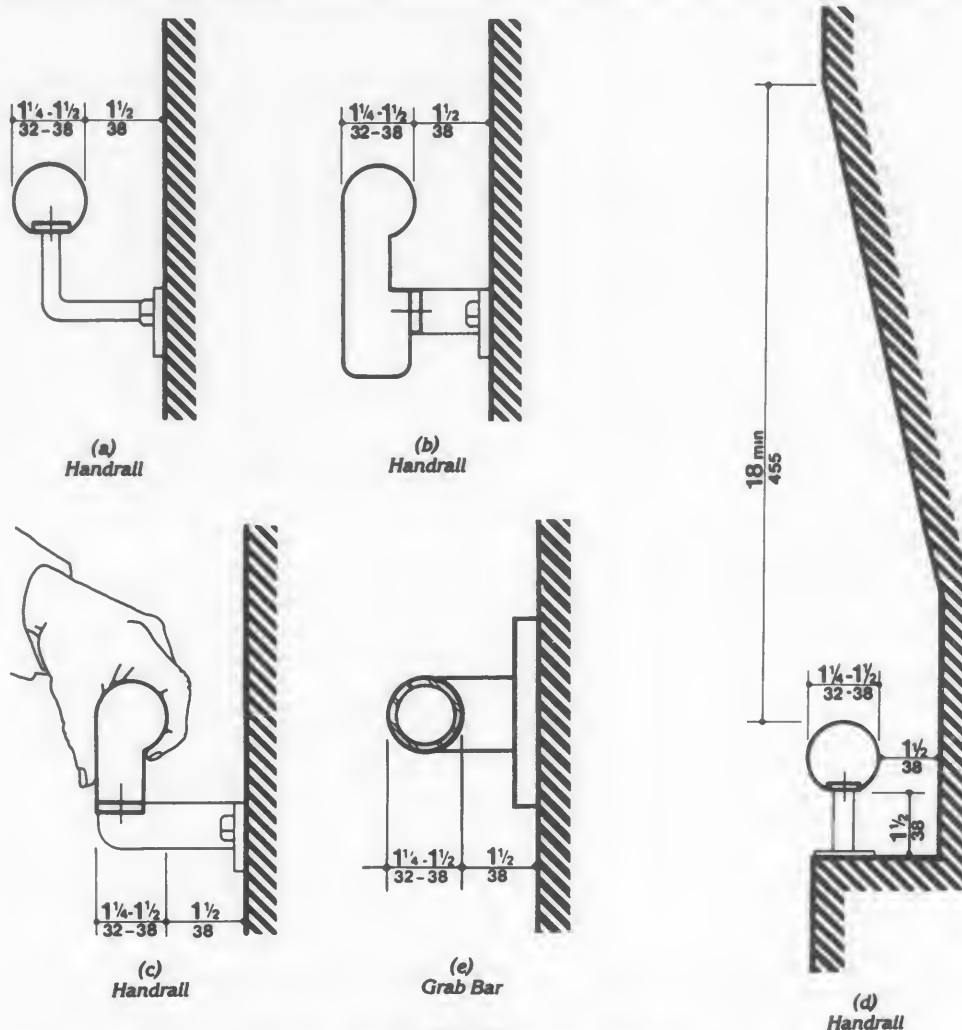

Fig. 39
Size and Spacing of Handrails and Grab Bars

4.26.4 Eliminating Hazards. A handrail or grab bar and any wall or other surface adjacent to it shall be free of any sharp or abrasive elements. Edges shall have a minimum radius of 1/8 in (3.2 mm).

4.27 Controls and Operating Mechanisms.

4.27.1 General. Controls and operating mechanisms required to be accessible by 4.1 shall comply with 4.27.

4.28 Alarms

4.27.2 Clear Floor Space. Clear floor space complying with 4.2.4 that allows a forward or a parallel approach by a person using a wheelchair shall be provided at controls, dispensers, receptacles, and other operable equipment.

4.27.3* Height. The highest operable part of controls, dispensers, receptacles, and other operable equipment shall be placed within at least one of the reach ranges specified in 4.2.5 and 4.2.6. Electrical and communications system receptacles on walls shall be mounted no less than 15 in (380 mm) above the floor.

EXCEPTION: These requirements do not apply where the use of special equipment dictates otherwise or where electrical and communications systems receptacles are not normally intended for use by building occupants.

4.27.4 Operation. Controls and operating mechanisms shall be operable with one hand and shall not require tight grasping, pinching, or twisting of the wrist. The force required to activate controls shall be no greater than 5 lbf (22.2 N).

4.28 Alarms.

4.28.1 General. Alarm systems required to be accessible by 4.1 shall comply with 4.28. At a minimum, visual signal appliances shall be provided in buildings and facilities in each of the following areas: restrooms and any other general usage areas (e.g., meeting rooms), hallways, lobbies, and any other area for common use.

4.28.2* Audible Alarms. If provided, audible emergency alarms shall produce a sound that exceeds the prevailing equivalent sound level in the room or space by at least 15 dbA or exceeds any maximum sound level with a duration of 60 seconds by 5 dbA, whichever is louder. Sound levels for alarm signals shall not exceed 120 dbA.

4.28.3* Visual Alarms. Visual alarm signal appliances shall be integrated into the building or facility alarm system. If single station audible alarms are provided then single station visual alarm signals shall be provided. Visual alarm signals shall have the following minimum photometric and location features:

(1) The lamp shall be a xenon strobe type or equivalent.

(2) The color shall be clear or nominal white (i.e., unfiltered or clear filtered white light).

(3) The maximum pulse duration shall be two-tenths of one second (0.2 sec) with a maximum duty cycle of 40 percent. The pulse duration is defined as the time interval between initial and final points of 10 percent of maximum signal.

(4) The intensity shall be a minimum of 75 candela.

(5) The flash rate shall be a minimum of 1 Hz and a maximum of 3 Hz.

(6) The appliance shall be placed 80 in (2030 mm) above the highest floor level within the space or 6 in (152 mm) below the ceiling, whichever is lower.

(7) In general, no place in any room or space required to have a visual signal appliance shall be more than 50 ft (15 m) from the signal (in the horizontal plane). In large rooms and spaces exceeding 100 ft (30 m) across, without obstructions 6 ft (2 m) above the finish floor, such as auditoriums, devices may be placed around the perimeter, spaced a maximum 100 ft (30 m) apart, in lieu of suspending appliances from the ceiling.

(8) No place in common corridors or hallways in which visual alarm signalling appliances are required shall be more than 50 ft (15 m) from the signal.

4.28.4* Auxiliary Alarms. Units and sleeping accommodations shall have a visual alarm connected to the building emergency alarm system or shall have a standard 110-volt electrical receptacle into which such an alarm can be connected and a means by which a signal from the building emergency alarm system can trigger such an auxiliary alarm. When visual alarms are in place the signal shall be visible in all areas of the unit or room. Instructions for use of the auxiliary alarm or receptacle shall be provided.

4.29 Detectable Warnings

4.29 Detectable Warnings.

4.29.1 General. Detectable warnings required by 4.1 and 4.7 shall comply with 4.29.

4.29.2* Detectable Warnings on Walking Surfaces. Detectable warnings shall consist of raised truncated domes with a diameter of nominal 0.9 in (23 mm), a height of nominal 0.2 in (5 mm) and a center-to-center spacing of nominal 2.35 in (60 mm) and shall contrast visually with adjoining surfaces, either light-on-dark, or dark-on-light.

The material used to provide contrast shall be an integral part of the walking surface. Detectable warnings used on interior surfaces shall differ from adjoining walking surfaces in reflectivity or sound-on-cane contact.

4.29.3 Detectable Warnings on Doors To Hazardous Areas. (Reserved).

4.29.4 Detectable Warnings at Stairs. (Reserved).

4.29.5 Detectable Warnings at Hazardous Vehicular Areas. If a walk crosses or adjoins a vehicular way, and the walking surfaces are not separated by curbs, railings, or other elements between the pedestrian areas and vehicular areas, the boundary between the areas shall be defined by a continuous detectable warning which is 36 in (915 mm) wide, complying with 4.29.2.

4.29.6 Detectable Warnings at Reflecting Pools. The edges of reflecting pools shall be protected by railings, walls, curbs, or detectable warnings complying with 4.29.2.

4.29.7 Standardization. (Reserved).

4.30 Signage.

4.30.1* General. Signage required to be accessible by 4.1 shall comply with the applicable provisions of 4.30.

4.30.2* Character Proportion. Letters and numbers on signs shall have a width-to-height ratio between 3:5 and 1:1 and a stroke-width-to-height ratio between 1:5 and 1:10.

4.30.3 Character Height. Characters and numbers on signs shall be sized according to the viewing distance from which they are to be read. The minimum height is measured using an upper case X. Lower case characters are permitted.

| Height Above Finished Floor | Minimum Character Height |
|--|--------------------------|
| Suspended or Projected Overhead in compliance with 4.4.2 | 3 in. (75 mm) minimum |

4.30.4* Raised and Brailled Characters and Pictorial Symbol Signs (Pictograms). Letters and numerals shall be raised 1/32 in, upper case, sans serif or simple serif type and shall be accompanied with Grade 2 Braille. Raised characters shall be at least 5/8 in (16 mm) high, but no higher than 2 in (50 mm). Pictograms shall be accompanied by the equivalent verbal description placed directly below the pictogram. The border dimension of the pictogram shall be 6 in (152 mm) minimum in height.

4.30.5* Finish and Contrast. The characters and background of signs shall be eggshell, matte, or other non-glare finish. Characters and symbols shall contrast with their background — either light characters on a dark background or dark characters on a light background.

4.30.6 Mounting Location and Height. Where permanent identification is provided for rooms and spaces, signs shall be installed on the wall adjacent to the latch side of the door. Where there is no wall space to the latch side of the door, including at double leaf doors, signs shall be placed on the nearest adjacent wall. Mounting height shall be 60 in (1525 mm) above the finish floor to the centerline of the sign. Mounting location for such signage shall be so that a person may approach within 3 in (76 mm) of signage without encountering protruding objects or standing within the swing of a door.

4.30.7* Symbols of Accessibility.

(1) Facilities and elements required to be identified as accessible by 4.1 shall use the international symbol of accessibility. The

4.30 Signage

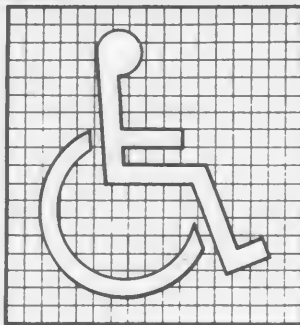

(a)
Proportions
International Symbol of Accessibility



(b)
Display Conditions
International Symbol of Accessibility



(c)
International TDD Symbol



(d)
International Symbol of Access for Hearing Loss

Fig. 43
International Symbols

symbol shall be displayed as shown in Fig. 43(a) and (b).

(2) *Volume Control Telephones.* Telephones required to have a volume control by 4.1.3(17)(b) shall be identified by a sign containing a depiction of a telephone handset with radiating sound waves.

(3) *Text Telephones.* Text telephones required by 4.1.3 (17)(c) shall be identified by the international TDD symbol (Fig 43(c)). In addition, if a facility has a public text telephone, directional signage indicating the location of the nearest text telephone shall be placed adjacent to all banks of telephones which do not contain a text telephone. Such directional signage shall include the international TDD symbol. If a facility has no banks of telephones, the directional signage shall be provided at the entrance (e.g., in a building directory).

(4) *Assistive Listening Systems.* In assembly areas where permanently installed assistive listening systems are required by 4.1.3(19)(b) the availability of such systems shall be identified with signage that includes the international symbol of access for hearing loss (Fig 43(d)).

4.30.8* Illumination Levels. (Reserved).

4.31 Telephones.

4.31.1 General. Public telephones required to be accessible by 4.1 shall comply with 4.31.

4.31.2 Clear Floor or Ground Space. A clear floor or ground space at least 30 in by 48 in (760 mm by 1220 mm) that allows either a forward or parallel approach by a person using a wheelchair shall be provided at telephones (see Fig. 44). The clear floor or ground space shall comply with 4.2.4. Bases, enclosures, and fixed seats shall not impede approaches to telephones by people who use wheelchairs.

4.31.3* Mounting Height. The highest operable part of the telephone shall be within the reach ranges specified in 4.2.5 or 4.2.6.

4.31.4 Protruding Objects. Telephones shall comply with 4.4.

4.31 Telephones

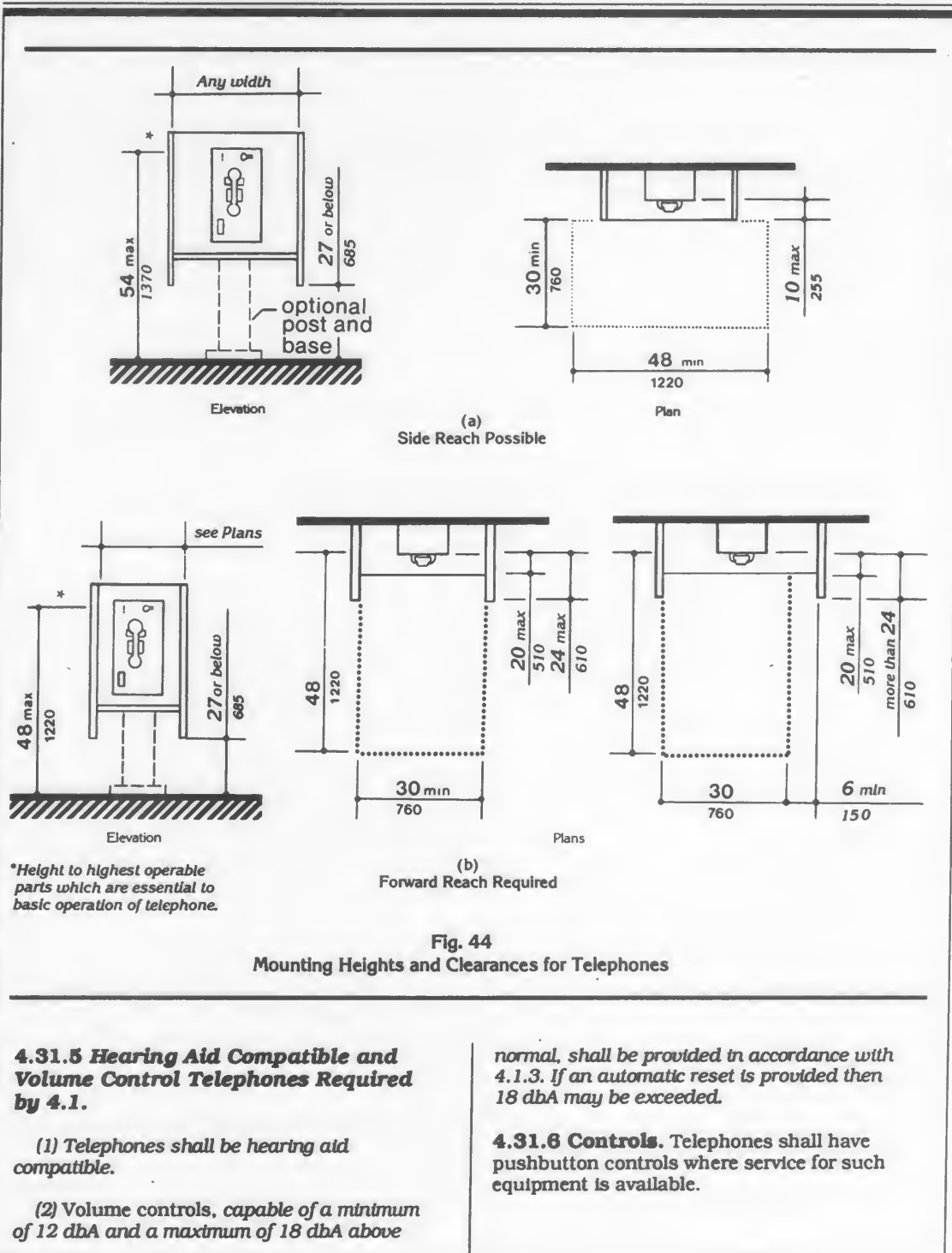

4.32 Fixed or Built-in Seating and Tables

4.31.7 Telephone Books. Telephone books, if provided, shall be located in a position that complies with the reach ranges specified in 4.2.5 and 4.2.6.

4.31.8 Cord Length. The cord from the telephone to the handset shall be at least 29 in (735 mm) long.

4.31.9* Text Telephones Required by 4.1.

(1) Text telephones used with a pay telephone shall be permanently affixed within, or adjacent to, the telephone enclosure. If an acoustic coupler is used, the telephone cord shall be sufficiently long to allow connection of the text telephone and the telephone receiver.

(2) Pay telephones designed to accommodate a portable text telephone shall be equipped with a shelf and an electrical outlet within or adjacent to the telephone enclosure. The telephone handset shall be capable of being placed flush on the surface of the shelf. The shelf shall be capable of accommodating a text telephone and shall have 6 in (152 mm) minimum vertical clearance in the area where the text telephone is to be placed.

(3) Equivalent facilitation may be provided. For example, a portable text telephone may be made available in a hotel at the registration desk if it is available on a 24-hour basis for use with nearby public pay telephones. In this instance, at least one pay telephone shall comply with paragraph 2 of this section. In addition, if an acoustic coupler is used, the telephone handset cord shall be sufficiently long so as to allow connection of the text telephone and the telephone receiver. Directional signage shall be provided and shall comply with 4.30.7.

4.32 Fixed or Built-in Seating and Tables.

4.32.1 Minimum Number. Fixed or built-in seating or tables required to be accessible by 4.1 shall comply with 4.32.

4.32.2 Seating. If seating spaces for people in wheelchairs are provided at fixed tables or counters, clear floor space complying with 4.2.4 shall be provided. Such clear floor space

shall not overlap knee space by more than 19 in (485 mm) (see Fig. 45).

4.32.3 Knee Clearances. If seating for people in wheelchairs is provided at tables or counters, knee spaces at least 27 in (685 mm) high, 30 in (760 mm) wide, and 19 in (485 mm) deep shall be provided (see Fig. 45).

4.32.4* Height of Tables or Counters.

The tops of accessible tables and counters shall be from 28 in to 34 in (710 mm to 865 mm) above the finish floor or ground.

4.33 Assembly Areas.

4.33.1 Minimum Number. Assembly and associated areas required to be accessible by 4.1 shall comply with 4.33.

4.33.2* Size of Wheelchair Locations.

Each wheelchair location shall provide minimum clear ground or floor spaces as shown in Fig. 46.

4.33.3* Placement of Wheelchair

Locations. Wheelchair areas shall be an integral part of any fixed seating plan and shall be provided so as to provide people with physical disabilities a choice of admission prices and lines of sight comparable to those for members of the general public. They shall adjoin an accessible route that also serves as a means of egress in case of emergency. At least one companion fixed seat shall be provided next to each wheelchair seating area. When the seating capacity exceeds 300, wheelchair spaces shall be provided in more than one location. Readily removable seats may be installed in wheelchair spaces when the spaces are not required to accommodate wheelchair users.

EXCEPTION: Accessible viewing positions may be clustered for bleachers, balconies, and other areas having sight lines that require slopes of greater than 5 percent. Equivalent accessible viewing positions may be located on levels having accessible egress.

4.33.4 Surfaces. The ground or floor at wheelchair locations shall be level and shall comply with 4.5.

4.33 Assembly Areas

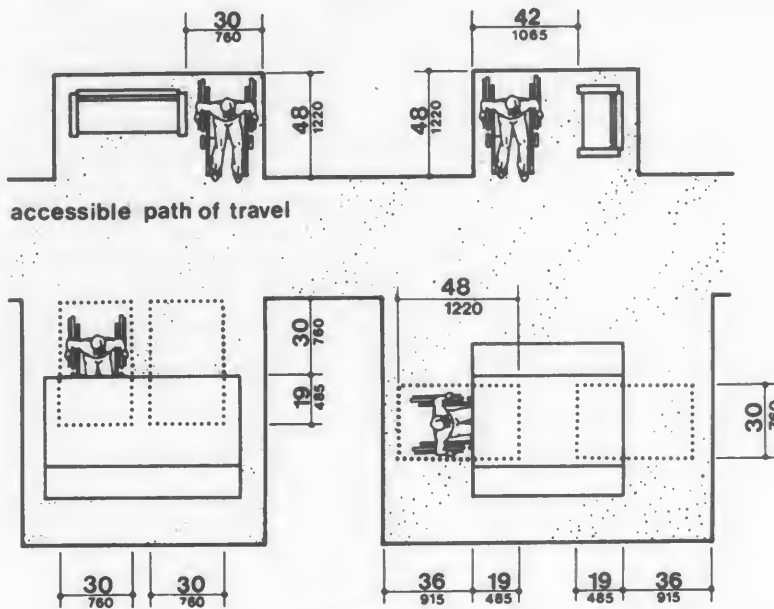

Fig. 45
Minimum Clearances for Seating and Tables

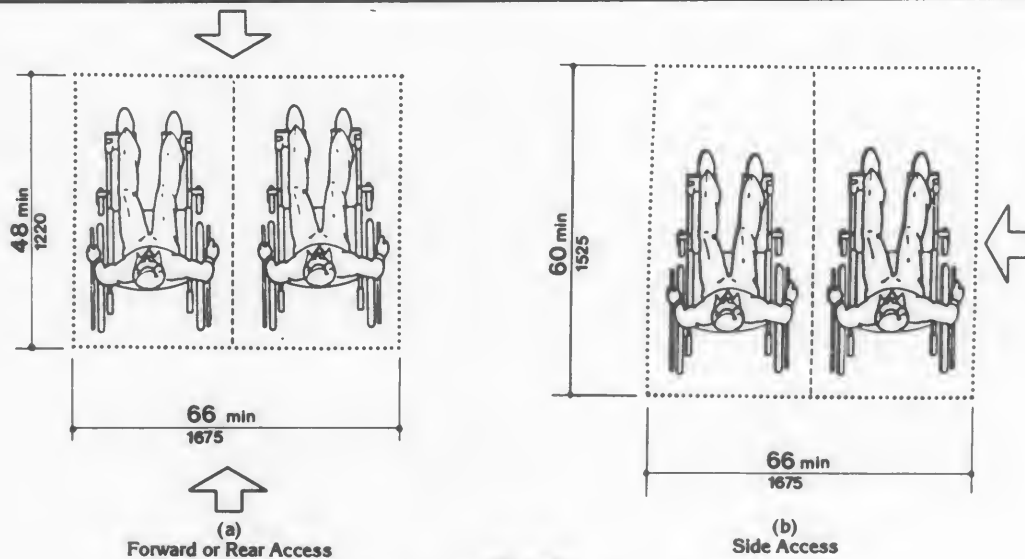

Fig. 46
Space Requirements for Wheelchair
Seating Spaces In Series

4.34 Automated Teller Machines

4.33.5 Access to Performing Areas.

An accessible route shall connect wheelchair seating locations with performing areas, including stages, arena floors, dressing rooms, locker rooms, and other spaces used by performers.

4.33.6* Placement of Listening Systems.

If the listening system provided serves individual fixed seats, then such seats shall be located within a 50 ft (15 m) viewing distance of the stage or playing area and shall have a complete view of the stage or playing area.

4.33.7* Types of Listening Systems.

Assistive listening systems (ALS) are intended to augment standard public address and audio systems by providing signals which can be received directly by persons with special receivers or their own hearing aids and which eliminate or filter background noise. The type of assistive listening system appropriate for a particular application depends on the characteristics of the setting, the nature of the program, and the intended audience. Magnetic induction loops, infra-red and radio frequency systems are types of listening systems which are appropriate for various applications.

4.34 Automated Teller Machines.

4.34.1 General. Each machine required to be accessible by 4.1.3 shall be on an accessible route and shall comply with 4.34.

4.34.2 Controls. Controls for user activation shall comply with the requirements of 4.27.

4.34.3 Clearances and Reach Range. Free standing or built-in units not having a clear space under them shall comply with 4.27.2 and 4.27.3 and provide for a parallel approach and both a forward and side reach to the unit allowing a person in a wheelchair to access the controls and dispensers.

4.34.4 Equipment for Persons with Vision Impairments. Instructions and all information for use shall be made accessible to and independently usable by persons with vision impairments.

4.35 Dressing and Fitting Rooms.

4.35.1 General. Dressing and fitting rooms required to be accessible by 4.1 shall comply with 4.35 and shall be on an accessible route.

4.35.2 Clear Floor Space. A clear floor space allowing a person using a wheelchair to make a 180-degree turn shall be provided in every accessible dressing room entered through a swinging or sliding door. No door shall swing into any part of the turning space. Turning space shall not be required in a private dressing room entered through a curtained opening at least 32 in (815 mm) wide if clear floor space complying with section 4.2 renders the dressing room usable by a person using a wheelchair.

4.35.3 Doors. All doors to accessible dressing rooms shall be in compliance with section 4.13.

4.35.4 Bench. Every accessible dressing room shall have a 24 in by 48 in (610 mm by 1220 mm) bench fixed to the wall along the longer dimension. The bench shall be mounted 17 in to 19 in (430 mm to 485 mm) above the finish floor. Clear floor space shall be provided alongside the bench to allow a person using a wheelchair to make a parallel transfer onto the bench. The structural strength of the bench and attachments shall comply with 4.26.3. Where installed in conjunction with showers, swimming pools, or other wet locations, water shall not accumulate upon the surface of the bench and the bench shall have a slip-resistant surface.

4.35.5 Mirror. Where mirrors are provided in dressing rooms of the same use, then in an accessible dressing room, a full-length mirror, measuring at least 18 in wide by 54 in high (460 mm by 1370 mm), shall be mounted in a position affording a view to a person on the bench as well as to a person in a standing position.

NOTE: Sections 4.1.1 through 4.1.7 and sections 5 through 10 are different from ANSI A117.1 in their entirety and are printed in standard type.

5.0 Restaurants and Cafeterias

5. RESTAURANTS AND CAFETERIAS.

5.1* General. Except as specified or modified in this section, restaurants and cafeterias shall comply with the requirements of 4.1 to 4.35. Where fixed tables (or dining counters) where food is consumed but there is no service are provided, at least 5 percent, but not less than one, of the fixed tables (or a portion of the dining counter) shall be accessible and shall comply with 4.32 as required in 4.1.3(18). In establishments where separate areas are designated for smoking and non-smoking patrons, the required number of accessible fixed tables (or counters) shall be proportionally distributed between the smoking and non-smoking areas. In new construction, and where practicable in alterations, accessible fixed tables (or counters) shall be distributed throughout the space or facility.

5.2 Counters and Bars. Where food or drink is served at counters exceeding 34 in (865 mm) in height for consumption by customers seated on stools or standing at the counter, a portion of the main counter which is 60 in (1525 mm) in length minimum shall be provided in compliance with 4.32 or service shall be available at accessible tables within the same area.

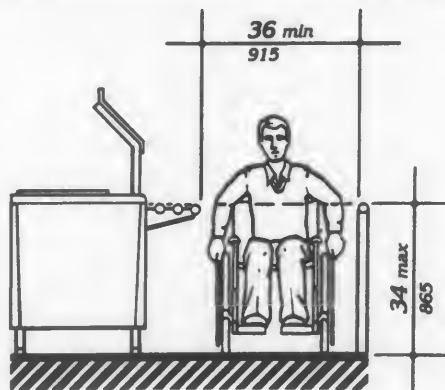

Fig. 53
Food Service Lines

5.3 Access Aisles. All accessible fixed tables shall be accessible by means of an access aisle at least 36 in (915 mm) clear between parallel edges of tables or between a wall and the table edges.

5.4 Dining Areas. In new construction, all dining areas, including raised or sunken dining areas, loggias, and outdoor seating areas, shall be accessible. In non-elevator buildings, an accessible means of vertical access to the mezzanine is not required under the following conditions: 1) the area of mezzanine seating measures no more than 33 percent of the area of the total accessible seating area; 2) the same services and decor are provided in an accessible space usable by the general public; and, 3) the accessible areas are not restricted to use by people with disabilities. In alterations, accessibility to raised or sunken dining areas, or to all parts of outdoor seating areas is not required provided that the same services and decor are provided in an accessible space usable by the general public and are not restricted to use by people with disabilities.

5.5 Food Service Lines. Food service lines shall have a minimum clear width of 36 in (915 mm), with a preferred clear width of 42 in (1065 mm) to allow passage around a person using a wheelchair. Tray slides shall be mounted no higher than 34 in (865 mm) above the floor (see Fig. 53). If self-service shelves

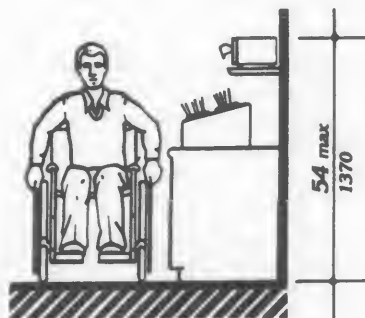

Fig. 54
Tableware Areas

6.0 Medical Care Facilities

are provided, at least 50 percent of each type must be within reach ranges specified in 4.2.5 and 4.2.6.

5.6 Tableware and Condiment Areas.

Self-service shelves and dispensing devices for tableware, dishware, condiments, food and beverages shall be installed to comply with 4.2 (see Fig. 54).

5.7 Raised Platforms. In banquet rooms or spaces where a head table or speaker's lectern is located on a raised platform, the platform shall be accessible in compliance with 4.8 or 4.11. Open edges of a raised platform shall be protected by placement of tables or by a curb.

5.8 Vending Machines and Other Equipment. Spaces for vending machines and other equipment shall comply with 4.2 and shall be located on an accessible route.

5.9 Quiet Areas. (Reserved).

6. MEDICAL CARE FACILITIES.

6.1 General. Medical care facilities included in this section are those in which people receive physical or medical treatment or care and where persons may need assistance in responding to an emergency and where the period of stay may exceed twenty-four hours. In addition to the requirements of 4.1 through 4.35, medical care facilities and buildings shall comply with 6.

(1) Hospitals - general purpose hospitals, psychiatric facilities, detoxification facilities — At least 10 percent of patient bedrooms and toilets, and all public use and common use areas are required to be designed and constructed to be accessible.

(2) Hospitals and rehabilitation facilities that specialize in treating conditions that affect mobility, or units within either that specialize in treating conditions that affect mobility — All patient bedrooms and toilets, and all public use and common use areas are required to be designed and constructed to be accessible.

(3) Long term care facilities, nursing homes — At least 50 percent of patient bedrooms and toilets, and all public use and common use areas are required to be designed and constructed to be accessible.

(4) Alterations to patient bedrooms.

(a) When patient bedrooms are being added or altered as part of a planned renovation of an entire wing, a department, or other discrete area of an existing medical facility, a percentage of the patient bedrooms that are being added or altered shall comply with 6.3. The percentage of accessible rooms provided shall be consistent with the percentage of rooms required to be accessible by the applicable requirements of 6.1(1), 6.1(2), or 6.1(3), until the number of accessible patient bedrooms in the facility equals the overall number that would be required if the facility were newly constructed. (For example, if 20 patient bedrooms are being altered in the obstetrics department of a hospital, 2 of the altered rooms must be made accessible. If, within the same hospital, 20 patient bedrooms are being altered in a unit that specializes in treating mobility impairments, all of the altered rooms must be made accessible.) Where toilet/bath rooms are part of patient bedrooms which are added or altered and required to be accessible, each such patient toilet/bathroom shall comply with 6.4.

(b) When patient bedrooms are being added or altered individually, and not as part of an alteration of the entire area, the altered patient bedrooms shall comply with 6.3, unless either: a) the number of accessible rooms provided in the department or area containing the altered patient bedroom equals the number of accessible patient bedrooms that would be required if the percentage requirements of 6.1(1), 6.1(2), or 6.1(3) were applied to that department or area; or b) the number of accessible patient bedrooms in the facility equals the overall number that would be required if the facility were newly constructed. Where toilet/bathrooms are part of patient bedrooms which are added or altered and required to be accessible, each such toilet/bathroom shall comply with 6.4.

7.0 Business and Mercantile

6.2 Entrances. At least one accessible entrance that complies with 4.14 shall be protected from the weather by canopy or roof overhang. Such entrances shall incorporate a passenger loading zone that complies with 4.6.6.

6.3 Patient Bedrooms. Provide accessible patient bedrooms in compliance with 4.1 through 4.35. Accessible patient bedrooms shall comply with the following:

(1) Each bedroom shall have a door that complies with 4.13.

EXCEPTION: Entry doors to acute care hospital bedrooms for in-patients shall be exempted from the requirement in 4.13.6 for maneuvering space at the latch side of the door if the door is at least 44 in (1120 mm) wide.

(2) Each bedroom shall have adequate space to provide a maneuvering space that complies with 4.2.3. In rooms with 2 beds, it is preferable that this space be located between beds.

(3) Each bedroom shall have adequate space to provide a minimum clear floor space of 36 in (915 mm) along each side of the bed and to provide an accessible route complying with 4.3.3 to each side of each bed.

6.4 Patient Toilet Rooms. Where toilet/bath rooms are provided as a part of a patient bedroom, each patient bedroom that is required to be accessible shall have an accessible toilet/bath room that complies with 4.22 or 4.23 and shall be on an accessible route.

7. BUSINESS AND MERCANTILE.

7.1 General. In addition to the requirements of 4.1 to 4.35, the design of all areas used for business transactions with the public shall comply with 7.

7.2 Sales and Service Counters, Teller Windows, Information Counters.

(1) In department stores and miscellaneous retail stores where counters have cash registers and are provided for sales or distribution of goods or services to the public, at least one of each type shall have a portion of the counter which is at least 36 in (915 mm) in length with a maximum height of 36 in (915 mm) above the finish floor. It shall be on an accessible route complying with 4.3. The accessible counters must be dispersed throughout the building or facility. In alterations where it is technically infeasible to provide an accessible counter, an auxiliary counter meeting these requirements may be provided.

(2) At ticketing counters, teller stations in a bank, registration counters in hotels and motels, box office ticket counters, and other counters that may not have a cash register but at which goods or services are sold or distributed, either:

(i) a portion of the main counter which is a minimum of 36 in (915 mm) in length shall be provided with a maximum height of 36 in (915 mm); or

(ii) an auxiliary counter with a maximum height of 36 in (915 mm) in close proximity to the main counter shall be provided; or

(iii) equivalent facilitation shall be provided (e.g., at a hotel registration counter, equivalent facilitation might consist of: (1) provision of a folding shelf attached to the main counter on which an individual with disabilities can write, and (2) use of the space on the side of the counter or at the concierge desk, for handing materials back and forth).

All accessible sales and service counters shall be on an accessible route complying with 4.3.

(3)* Assistive Listening Devices. (Reserved)

8.0 Libraries

7.3* Check-out Aisles.

(1) In new construction, accessible check-out aisles shall be provided in conformance with the table below:

| Total Check-out Aisles of Each Design | Minimum Number of Accessible Check-out Aisles (of each design) |
|---------------------------------------|--|
| 1 - 4 | 1 |
| 5 - 8 | 2 |
| 8 - 15 | 3 |
| over 15 | 3, plus 20% of additional aisles |

EXCEPTION: In new construction, where the selling space is under 5000 square feet, only one check-out aisle is required to be accessible.

EXCEPTION: In alterations, at least one check-out aisle shall be accessible in facilities under 5000 square feet of selling space. In facilities of 5000 or more square feet of selling space, at least one of each design of check-out aisle shall be made accessible when altered until the number of accessible check-out aisles of each design equals the number required in new construction.

Examples of check-out aisles of different "design" include those which are specifically designed to serve different functions. Different "design" includes but is not limited to the following features - length of belt or no belt; or permanent signage designating the aisle as an express lane.

(2) Clear aisle width for accessible check-out aisles shall comply with 4.2.1 and maximum adjoining counter height shall not exceed 38 in (965 mm) above the finish floor. The top of the lip shall not exceed 40 in (1015 mm) above the finish floor.

(3) Signage identifying accessible check-out aisles shall comply with 4.30.7 and shall be mounted above the check-out aisle in the same location where the check-out number or type of check-out is displayed.

7.4 Security Bollards. Any device used to prevent the removal of shopping carts from store premises shall not prevent access or egress to people in wheelchairs. An alternate

entry that is equally convenient to that provided for the ambulatory population is acceptable.

8. LIBRARIES.

8.1 General. In addition to the requirements of 4.1 to 4.35, the design of all public areas of a library shall comply with 8, including reading and study areas, stacks, reference rooms, reserve areas, and special facilities or collections.

8.2 Reading and Study Areas. At least 5 percent or a minimum of one of each element of fixed seating, tables, or study carrels shall comply with 4.2 and 4.32. Clearances between fixed accessible tables and between study carrels shall comply with 4.3.

8.3 Check-Out Areas. At least one lane at each check-out area shall comply with 7.2(1). Any traffic control or book security gates or turnstiles shall comply with 4.13.

8.4 Card Catalogs and Magazine Displays. Minimum clear aisle space at card catalogs and magazine displays shall comply with Fig. 55. Maximum reach height shall comply with 4.2, with a height of 48 in (1220 mm) preferred irrespective of approach allowed.

8.5 Stacks. Minimum clear aisle width between stacks shall comply with 4.3, with a minimum clear aisle width of 42 in (1065 mm) preferred where possible. Shelf height in stack areas is unrestricted (see Fig. 56).

9.0 Accessible Transient Lodging

9. ACCESSIBLE TRANSIENT LODGING.

(1) Except as specified in the special technical provisions of this section, accessible transient lodging shall comply with the applicable requirements of 4.1 through 4.35. Transient lodging includes facilities or portions thereof used for sleeping accommodations, when not classed as a medical care facility.

9.1 Hotels, Motels, Inns, Boarding Houses, Dormitories, Resorts and Other Similar Places of Transient Lodging.

9.1.1 General. All public use and common use areas are required to be designed and constructed to comply with section 4 (Accessible Elements and Spaces: Scope and Technical Requirements).

EXCEPTION: Sections 9.1 through 9.4 do not apply to an establishment located within a building that contains not more than five rooms for rent or hire and that is actually occupied by the proprietor of such establishment as the residence of such proprietor.

9.1.2 Accessible Units, Sleeping Rooms, and Suites. Accessible sleeping rooms or suites that comply with the requirements of 9.2 (Requirements for Accessible Units, Sleeping Rooms, and Suites) shall be provided in conformance with the table below. In addition, in hotels, of 50 or more sleeping rooms or suites, additional accessible sleeping rooms or suites that include a roll-in shower shall also be provided in conformance with the table below. Such accommodations shall comply with the requirements of 9.2, 4.21, and Figure 57(a) or (b).

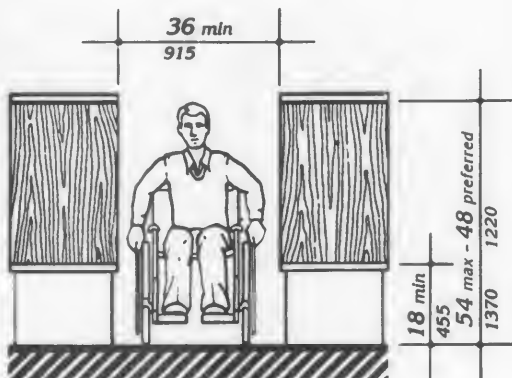

Fig. 55
Card Catalog

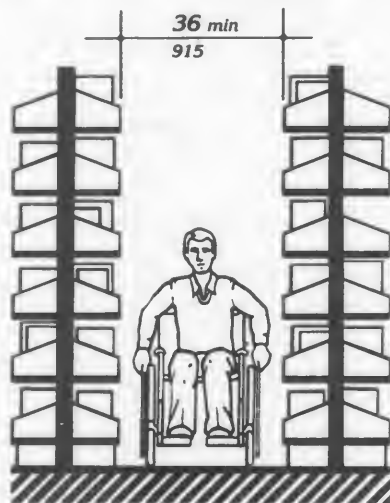

Fig. 56
Stacks

9.1.3 Sleeping Accommodations for Persons with Hearing Impairments

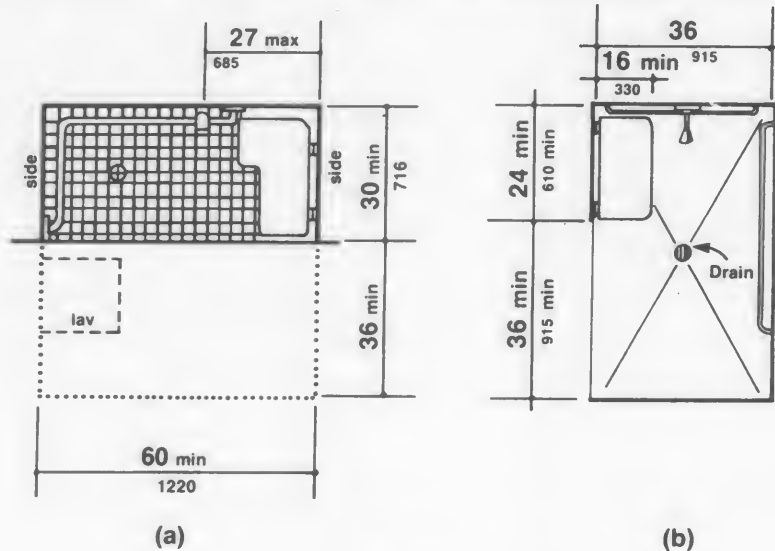

Fig. 57
Roll-in Shower with Folding Seat

| Number of Rooms | Accessible Rooms | Rooms with Roll-in Showers |
|-----------------|----------------------------------|---|
| 1 to 25 | 1 | |
| 26 to 50 | 2 | |
| 51 to 75 | 3 | 1 |
| 76 to 100 | 4 | 1 |
| 101 to 150 | 5 | 2 |
| 151 to 200 | 6 | 2 |
| 201 to 300 | 7 | 3 |
| 301 to 400 | 8 | 4 |
| 401 to 500 | 9 | 4 plus one for each additional 100 over 400 |
| 501 to 1000 | 2% of total | |
| 1001 and over | 20 plus 1 for each 100 over 1000 | |

and suites that comply with 9.3 (Visual Alarms, Notification Devices, and Telephones) shall be provided in conformance with the following table:

| Number of Elements | Accessible Elements |
|--------------------|----------------------------------|
| 1 to 25 | 1 |
| 26 to 50 | 2 |
| 51 to 75 | 3 |
| 76 to 100 | 4 |
| 101 to 150 | 5 |
| 151 to 200 | 6 |
| 201 to 300 | 7 |
| 301 to 400 | 8 |
| 401 to 500 | 9 |
| 501 to 1000 | 2% of total |
| 1001 and over | 20 plus 1 for each 100 over 1000 |

9.1.3 Sleeping Accommodations for Persons with Hearing Impairments.

In addition to those accessible sleeping rooms and suites required by 9.1.2, sleeping rooms

9.2 Requirements for Accessible Units, Sleeping Rooms and Suites

9.1.4 Classes of Sleeping Accommodations.

(1) In order to provide persons with disabilities a range of options equivalent to those available to other persons served by the facility, sleeping rooms and suites required to be accessible by 9.1.2 shall be dispersed among the various classes of sleeping accommodations available to patrons of the place of transient lodging. Factors to be considered include room size, cost, amenities provided, and the number of beds provided.

(2) **Equivalent Facilitation.** For purposes of this section, it shall be deemed equivalent facilitation if the operator of a facility elects to limit construction of accessible rooms to those intended for multiple occupancy, provided that such rooms are made available at the cost of a single-occupancy room to an individual with disabilities who requests a single-occupancy room.

9.1.5. Alterations to Accessible Units, Sleeping Rooms, and Suites. When sleeping rooms are being altered in an existing facility, or portion thereof, subject to the requirements of this section, at least one sleeping room or suite that complies with the requirements of 9.2 (Requirements for Accessible Units, Sleeping Rooms, and Suites) shall be provided for each 25 sleeping rooms, or fraction thereof, of rooms being altered until the number of such rooms provided equals the number required to be accessible with 9.1.2. In addition, at least one sleeping room or suite that complies with the requirements of 9.3 (Visual Alarms, Notification Devices, and Telephones) shall be provided for each 25 sleeping rooms, or fraction thereof, of rooms being altered until the number of such rooms equals the number required to be accessible by 9.1.3.

9.2 Requirements for Accessible Units, Sleeping Rooms and Suites.

9.2.1 General. Units, sleeping rooms, and suites required to be accessible by 9.1 shall comply with 9.2.

9.2.2 Minimum Requirements. An accessible unit, sleeping room or suite shall be on an

accessible route complying with 4.3 and have the following accessible elements and spaces.

(1) Accessible sleeping rooms shall have a 36 in (915 mm) clear width maneuvering space located along both sides of a bed, except that where two beds are provided, this requirement can be met by providing a 36 in (915 mm) wide maneuvering space located between the two beds.

(2) An accessible route complying with 4.3 shall connect all accessible spaces and elements, including telephones, within the unit, sleeping room, or suite. This is not intended to require an elevator in multi-story units as long as the spaces identified in 9.2.2(6) and (7) are on accessible levels and the accessible sleeping area is suitable for dual occupancy.

(3) Doors and doorways designed to allow passage into and within all sleeping rooms, suites or other covered units shall comply with 4.13.

(4) If fixed or built-in storage facilities such as cabinets, shelves, closets, and drawers are provided in accessible spaces, at least one of each type provided shall contain storage space complying with 4.25. Additional storage may be provided outside of the dimensions required by 4.25.

(5) All controls in accessible units, sleeping rooms, and suites shall comply with 4.27.

(6) Where provided as part of an accessible unit, sleeping room, or suite, the following spaces shall be accessible and shall be on an accessible route:

- (a) the living area.
- (b) the dining area.
- (c) at least one sleeping area.
- (d) patios, terraces, or balconies.

EXCEPTION: The requirements of 4.13.8 and 4.3.8 do not apply where it is necessary to utilize a higher door threshold or a change in level to protect the integrity of the unit from wind/water damage. Where this exception results in patios, terraces or balconies that are not at an accessible level, equivalent facilitation

9.3 Visual Alarms, Notification Devices and Telephones

shall be provided. (E.g., equivalent facilitation at a hotel patio or balcony might consist of providing raised decking or a ramp to provide accessibility.)

(e) at least one full bathroom (i.e., one with a water closet, a lavatory, and a bathtub or shower).

(f) if only half baths are provided, at least one half bath.

(g) carports, garages or parking spaces.

(7) Kitchens, Kitchenettes, or Wet Bars. When provided as accessory to a sleeping room or suite, kitchens, kitchenettes, wet bars, or similar amenities shall be accessible. Clear floor space for a front or parallel approach to cabinets, counters, sinks, and appliances shall be provided to comply with 4.2.4. Countertops and sinks shall be mounted at a maximum height of 34 in (865 mm) above the floor. At least fifty percent of shelf space in cabinets or refrigerator/freezers shall be within the reach ranges of 4.2.5 or 4.2.6 and space shall be designed to allow for the operation of cabinet and/or appliance doors so that all cabinets and appliances are accessible and usable. Controls and operating mechanisms shall comply with 4.27.

(8) Sleeping room accommodations for persons with hearing impairments required by 9.1 and complying with 9.3 shall be provided in the accessible sleeping room or suite.

9.3 Visual Alarms, Notification Devices and Telephones.

9.3.1 General. In sleeping rooms required to comply with this section, auxiliary visual alarms shall be provided and shall comply with 4.28.4. Visual notification devices shall also be provided in units, sleeping rooms and suites to alert room occupants of incoming telephone calls and a door knock or bell. Notification devices shall not be connected to auxiliary visual alarm signal appliances. Permanently installed telephones shall have volume controls complying with 4.31.5; an accessible electrical outlet within 4 ft (1220 mm) of a telephone connection shall be provided to facilitate the use of a text telephone.

9.3.2 Equivalent Facilitation. For purposes of this section, equivalent facilitation shall include the installation of electrical outlets (including outlets connected to a facility's central alarm system) and telephone wiring in sleeping rooms and suites to enable persons with hearing impairments to utilize portable visual alarms and communication devices provided by the operator of the facility.

9.4 Other Sleeping Rooms and Suites. Doors and doorways designed to allow passage into and within all sleeping units or other covered units shall comply with 4.13.5.

9.5 Transient Lodging in Homeless Shelters, Halfway Houses, Transient Group Homes, and Other Social Service Establishments.

9.5.1 New Construction. In new construction all public use and common use areas are required to be designed and constructed to comply with section 4. At least one of each type of amenity (such as washers, dryers and similar equipment installed for the use of occupants) in each common area shall be accessible and shall be located on an accessible route to any accessible unit or sleeping accommodation.

EXCEPTION: Where elevators are not provided as allowed in 4.1.3(5), accessible amenities are not required on inaccessible floors as long as one of each type is provided in common areas on accessible floors.

9.5.2 Alterations.

(1) Social service establishments which are not homeless shelters:

(a) The provisions of 9.5.3 and 9.1.5 shall apply to sleeping rooms and beds.

(b) Alteration of other areas shall be consistent with the new construction provisions of 9.5.1.

(2) Homeless shelters. If the following elements are altered, the following requirements apply:

10.0 Transportation Facilities

(a) at least one public entrance shall allow a person with mobility impairments to approach, enter and exit including a minimum clear door width of 32 in (815 mm).

(b) sleeping space for homeless persons as provided in the scoping provisions of 9.1.2 shall include doors to the sleeping area with a minimum clear width of 32 in (815 mm) and maneuvering space around the beds for persons with mobility impairments complying with 9.2.2(1).

(c) at least one toilet room for each gender or one unisex toilet room shall have a minimum clear door width of 32 in (815 mm), minimum turning space complying with 4.2.3, one water closet complying with 4.16, one lavatory complying with 4.19 and the door shall have a privacy latch; and, if provided, at least one tub or shower shall comply with 4.20 or 4.21, respectively.

(d) at least one common area which a person with mobility impairments can approach, enter and exit including a minimum clear door width of 32 in (815 mm).

(e) at least one route connecting elements (a), (b), (c) and (d) which a person with mobility impairments can use including minimum clear width of 36 in (915 mm), passing space complying with 4.3.4, turning space complying with 4.2.3 and changes in levels complying with 4.3.8.

(f) homeless shelters can comply with the provisions of (a)-(e) by providing the above elements on one accessible floor.

9.5.3. Accessible Sleeping Accommodations in New Construction. Accessible sleeping rooms shall be provided in conformance with the table in 9.1.2 and shall comply with 9.2 Accessible Units, Sleeping Rooms and Suites (where the items are provided). Additional sleeping rooms that comply with 9.3 Sleeping Accommodations for Persons with Hearing Impairments shall be provided in conformance with the table provided in 9.1.3.

In facilities with multi-bed rooms or spaces, a percentage of the beds equal to the table provided in 9.1.2 shall comply with 9.2.2(1).

10. TRANSPORTATION FACILITIES. (Reserved).

APPENDIX

This appendix contains materials of an advisory nature and provides additional information that should help the reader to understand the minimum requirements of the guidelines or to design buildings or facilities for greater accessibility. The paragraph numbers correspond to the sections or paragraphs of the guideline to which the material relates and are therefore not consecutive (for example, A4.2.1 contains additional information relevant to 4.2.1). Sections of the guidelines for which additional material appears in this appendix have been indicated by an asterisk. Nothing in this appendix shall in any way obviate any obligation to comply with the requirements of the guidelines itself.

A2.2 Equivalent Facilitation. Specific examples of equivalent facilitation are found in the following sections:

| | |
|-------------|--|
| 4.1.6(3)(c) | Elevators in Alterations |
| 4.31.9 | Text Telephones |
| 7.2 | Sales and Service Counters, Teller Windows, Information Counters |
| 9.1.4 | Classes of Sleeping Accommodations |
| 9.2.2(6)(d) | Requirements for Accessible Units, Sleeping Rooms, and Suites |

A4.1.1 Application.

A4.1.1(3) Areas Used Only by Employees as Work Areas. Where there are a series of individual work stations of the same type (e.g., laboratories, service counters, ticket booths), 5%, but not less than one, of each type of work station should be constructed so that an individual with disabilities can maneuver within the work stations. Rooms housing individual offices in a typical office building must meet the requirements of the guidelines concerning doors, accessible routes, etc. but do not need to allow for maneuvering space around individual desks. Modifications required to permit maneuvering within the work area may be accomplished as a reasonable accommodation to individual employees with disabilities under Title I of the ADA. Consideration should also be given to placing shelves in employee work areas at a

convenient height for accessibility or installing commercially available shelving that is adjustable so that reasonable accommodations can be made in the future.

If work stations are made accessible they should comply with the applicable provisions of 4.2 through 4.35.

A4.1.2 Accessible Sites and Exterior Facilities: New Construction.

A4.1.2(5)(e) Valet Parking. Valet parking is not always usable by individuals with disabilities. For instance, an individual may use a type of vehicle controls that render the regular controls inoperable or the driver's seat in a van may be removed. In these situations, another person cannot park the vehicle. It is recommended that some self-parking spaces be provided at valet parking facilities for individuals whose vehicles cannot be parked by another person and that such spaces be located on an accessible route to the entrance of the facility.

A4.1.3 Accessible Buildings: New Construction.

A4.1.3(5) Only full passenger elevators are covered by the accessibility provisions of 4.10. Materials and equipment hoists, freight elevators not intended for passenger use, dumbwaiters, and construction elevators are not covered by these guidelines. If a building is exempt from the elevator requirement, it is not necessary to provide a platform lift or other means of vertical access in lieu of an elevator.

Under Exception 4, platform lifts are allowed where existing conditions make it impractical to install a ramp or elevator. Such conditions generally occur where it is essential to provide access to small raised or lowered areas where space may not be available for a ramp. Examples include, but are not limited to, raised pharmacy platforms, commercial offices raised above a sales floor, or radio and news booths.

A4.1.3(9) Supervised automatic sprinkler systems have built in signals for monitoring features of the system such as the opening and closing of water control valves, the power supplies for needed pumps, water tank levels, and for indicating conditions that will impair the satisfactory operation of the sprinkler system.

A4.2 Space Allowances and Reach Ranges

Because of these monitoring features, supervised automatic sprinkler systems have a high level of satisfactory performance and response to fire conditions.

A4.1.3(10) If an odd number of drinking fountains is provided on a floor, the requirement in 4.1.3(10)(b) may be met by rounding down the odd number to an even number and calculating 50% of the even number. When more than one drinking fountain on a floor is required to comply with 4.15, those fountains should be dispersed to allow wheelchair users convenient access. For example, in a large facility such as a convention center that has water fountains at several locations on a floor, the accessible water fountains should be located so that wheelchair users do not have to travel a greater distance than other people to use a drinking fountain.

A4.1.3(17)(b) In addition to the requirements of section 4.1.3(17)(b), the installation of additional volume controls is encouraged. Volume controls may be installed on any telephone.

A4.1.3(19)(a) Readily removable or folding seating units may be installed in lieu of providing an open space for wheelchair users. Folding seating units are usually two fixed seats that can be easily folded into a fixed center bar to allow for one or two open spaces for wheelchair users when necessary. These units are more easily adapted than removable seats which generally require the seat to be removed in advance by the facility management.

Either a sign or a marker placed on seating with removable or folding arm rests is required by this section. Consideration should be given for ensuring identification of such seats in a darkened theater. For example, a marker which contrasts (light on dark or dark on light) and which also reflects light could be placed on the side of such seating so as to be visible in a lighted auditorium and also to reflect light from a flashlight.

A4.1.6 Accessible Buildings: Alterations.

A4.1.6(1)(h) When an entrance is being altered, it is preferable that those entrances being altered be made accessible to the extent feasible.

A4.2 Space Allowances and Reach Ranges.

A4.2.1 Wheelchair Passage Width.

(1) Space Requirements for Wheelchairs. Many persons who use wheelchairs need a 30 in (760 mm) clear opening width for doorways, gates, and the like, when the latter are entered head-on. If the person is unfamiliar with a building, if competing traffic is heavy, if sudden or frequent movements are needed, or if the wheelchair must be turned at an opening, then greater clear widths are needed. For most situations, the addition of an inch of leeway on either side is sufficient. Thus, a minimum clear width of 32 in (815 mm) will provide adequate clearance. However, when an opening or a restriction in a passageway is more than 24 in (610 mm) long, it is essentially a passageway and must be at least 36 in (915 mm) wide.

(2) Space Requirements for Use of Walking Aids. Although people who use walking aids can maneuver through clear width openings of 32 in (815 mm), they need 36 in (915 mm) wide passageways and walks for comfortable gaits. Crutch tips, often extending down at a wide angle, are a hazard in narrow passageways where they might not be seen by other pedestrians. Thus, the 36 in (915 mm) width provides a safety allowance both for the person with a disability and for others.

(3) Space Requirements for Passing. Able-bodied persons in winter clothing, walking

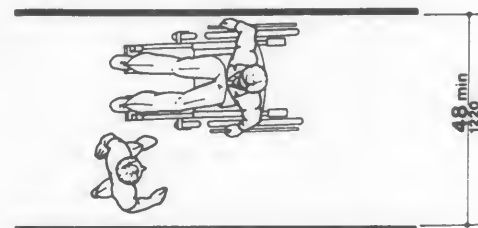

Fig. A1
Minimum Passage Width for One Wheelchair
and One Ambulatory Person

A4.2 Space Allowances and Reach Ranges

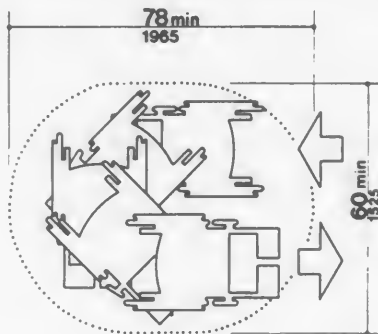
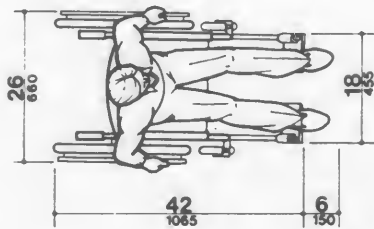
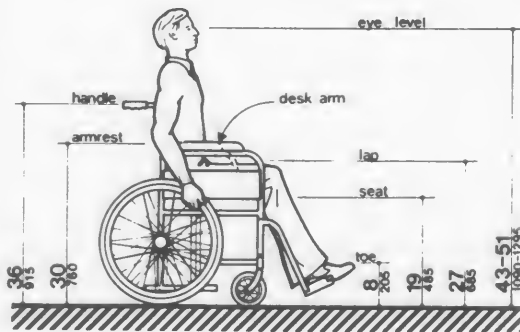

Fig. A2
Space Needed for Smooth U-Turn in a Wheelchair

straight ahead with arms swinging, need 32 in (815 mm) of width, which includes 2 in (50 mm) on either side for sway, and another 1 in (25 mm) tolerance on either side for clearing nearby objects or other pedestrians. Almost all wheelchair users and those who use walking aids can also manage within this 32 in (815 mm) width for short distances. Thus, two streams of traffic can pass in 64 in (1625 mm) in a comfortable flow. Sixty inches (1525 mm) provides a minimum width for a somewhat more restricted flow. If the clear width is less than 60 in (1525 mm), two wheelchair users will not be able to pass but will have to seek a wider place for passing. Forty-eight inches (1220 mm) is the minimum width needed for an ambulatory person to pass a nonambulatory or semi-ambulatory person. Within this 48 in (1220 mm) width, the ambulatory person will have to twist to pass a wheelchair user, a person with a *service animal*, or a



NOTE: Footrests may extend further for tall people

Fig. A3
Dimensions of Adult-Sized Wheelchairs

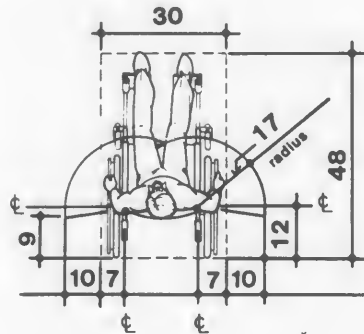
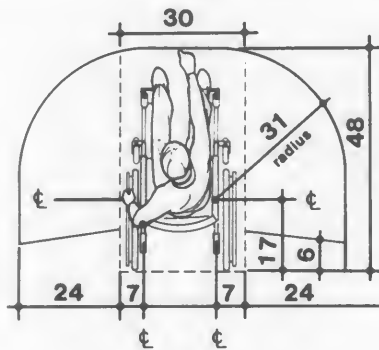

Fig. A3 (a)

A4.3 Accessible Route

semi-ambulatory person. There will be little leeway for swaying or missteps (see Fig. A1).

A4.2.3 Wheelchair Turning Space.

These guidelines specify a minimum space of 60 in (1525 mm) diameter or a 60 in by 60 in (1525 mm by 1525 mm) T-shaped space for a pivoting 180-degree turn of a wheelchair. This space is usually satisfactory for turning around, but many people will not be able to turn without repeated tries and bumping into surrounding objects. The space shown in Fig. A2 will allow most wheelchair users to complete U-turns without difficulty.

A4.2.4 Clear Floor or Ground Space for Wheelchairs. The wheelchair and user shown in Fig. A3 represent typical dimensions for a large adult male. The space requirements in this guideline are based upon maneuvering clearances that will accommodate most wheelchairs. Fig. A3 provides a uniform reference for design not covered by this guideline.

A4.2.5 & A4.2.6 Reach. Reach ranges for persons seated in wheelchairs may be further clarified by Fig. A3(a). These drawings approximate in the plan view the information shown in Fig. 4, 5, and 6.

A4.3 Accessible Route.

A4.3.1 General.

(1) **Travel Distances.** Many people with mobility impairments can move at only very slow speeds; for many, traveling 200 ft (61 m) could take about 2 minutes. This assumes a rate of about 1.5 ft/s (455 mm/s) on level ground. It also assumes that the traveler would move continuously. However, on trips over 100 ft (30 m), disabled people are apt to rest frequently, which substantially increases their trip times. Resting periods of 2 minutes for every 100 ft (30 m) can be used to estimate travel times for people with severely limited stamina. In inclement weather, slow progress and resting can greatly increase a disabled person's exposure to the elements.

(2) **Sites.** Level, indirect routes or those with running slopes lower than 1:20 can sometimes provide more convenience than direct routes with maximum allowable slopes or with ramps.

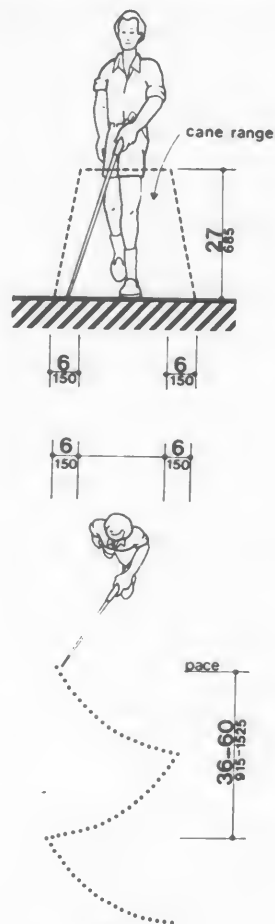

Fig. A4
Cane Technique

A4.3.10 Egress. Because people with disabilities may visit, be employed or be a resident in any building, emergency management plans with specific provisions to ensure their safe evacuation also play an essential role in fire safety and life safety.

A4.3.11.3 Stairway Width. A 48 inch (1220 mm) wide exit stairway is needed to allow assisted evacuation (e.g., carrying a person in a wheelchair) without encroaching on the exit path for ambulatory persons.

A4.5 Ground and Floor Surfaces

A4.3.11.4 Two-way Communication. *It is essential that emergency communication not be dependent on voice communications alone because the safety of people with hearing or speech impairments could be jeopardized. The visible signal requirement could be satisfied with something as simple as a button in the area of rescue assistance that lights, indicating that help is on the way, when the message is answered at the point of entry.*

A4.4 Protruding Objects.

A4.4.1 General. *Service animals are trained to recognize and avoid hazards. However, most people with severe impairments of vision use the long cane as an aid to mobility. The two principal cane techniques are the touch technique, where the cane arcs from side to side and touches points outside both shoulders; and the diagonal technique, where the cane is held in a stationary position diagonally across the body with the cane tip touching or just above the ground at a point outside one shoulder and the handle or grip extending to a point outside the other shoulder. The touch technique is used primarily in uncontrolled areas, while the diagonal technique is used primarily in certain limited, controlled, and familiar environments. Cane users are often trained to use both techniques.*

Potential hazardous objects are noticed only if they fall within the detection range of canes (see Fig. A4). Visually impaired people walking toward an object can detect an overhang if its lowest surface is not higher than 27 in (685 mm). When walking alongside protruding objects, they cannot detect overhangs. Since proper cane and service animal techniques keep people away from the edge of a path or from walls, a slight overhang of no more than 4 in (100 mm) is not hazardous.

A4.5 Ground and Floor Surfaces.

A4.5.1 General. *People who have difficulty walking or maintaining balance or who use crutches, canes, or walkers, and those with restricted gaits are particularly sensitive to slipping and tripping hazards. For such people, a stable and regular surface is necessary for safe walking, particularly on stairs. Wheelchairs can be propelled most easily on surfaces that are hard, stable, and regular. Soft loose*

surfaces such as shag carpet, loose sand or gravel, wet clay, and irregular surfaces such as cobblestones can significantly impede wheelchair movement.

Slip resistance is based on the frictional force necessary to keep a shoe heel or crutch tip from slipping on a walking surface under conditions likely to be found on the surface. While the dynamic coefficient of friction during walking varies in a complex and non-uniform way, the static coefficient of friction, which can be measured in several ways, provides a close approximation of the slip resistance of a surface. Contrary to popular belief, some slippage is necessary to walking, especially for persons with restricted gaits; a truly "non-slip" surface could not be negotiated.

The Occupational Safety and Health Administration recommends that walking surfaces have a static coefficient of friction of 0.5. A research project sponsored by the Architectural and Transportation Barriers Compliance Board (Access Board) conducted tests with persons with disabilities and concluded that a higher coefficient of friction was needed by such persons. A static coefficient of friction of 0.6 is recommended for accessible routes and 0.8 for ramps.

It is recognized that the coefficient of friction varies considerably due to the presence of contaminants, water, floor finishes, and other factors not under the control of the designer or builder and not subject to design and construction guidelines and that compliance would be difficult to measure on the building site. Nevertheless, many common building materials suitable for flooring are now labeled with information on the static coefficient of friction. While it may not be possible to compare one product directly with another, or to guarantee a constant measure, builders and designers are encouraged to specify materials with appropriate values. As more products include information on slip resistance, improved uniformity in measurement and specification is likely. The Access Board's advisory guidelines on Slip Resistant Surfaces provides additional information on this subject.

Cross slopes on walks and ground or floor surfaces can cause considerable difficulty in propelling a wheelchair in a straight line.

A4.6 Parking and Passenger Loading Zones

A4.5.3 Carpet. Much more needs to be done in developing both quantitative and qualitative criteria for carpeting (*i.e.*, *problems associated with texture and weave need to be studied*). However, certain functional characteristics are well established. When both carpet and padding are used, it is desirable to have minimum movement (preferably none) between the floor and the pad and the pad and the carpet which would allow the carpet to hump or warp. In heavily trafficked areas, a thick, soft (plush) pad or cushion, particularly in combination with long carpet pile, makes it difficult for individuals in wheelchairs and those with other ambulatory disabilities to get about. Firm carpeting can be achieved through proper selection and combination of pad and carpet, sometimes with the elimination of the pad or cushion, and with proper installation. *Carpeting designed with a weave that causes a zig-zag effect when wheeled across is strongly discouraged.*

A4.6 Parking and Passenger Loading Zones.

A4.6.3 Parking Spaces. *The increasing use of vans with side-mounted lifts or ramps by persons with disabilities has necessitated some revisions in specifications for parking spaces and adjacent access aisles. The typical accessible parking space is 96 in (2440 mm) wide with an adjacent 60 in (1525 mm) access aisle. However, this aisle does not permit lifts or ramps to be deployed and still leave room for a person using a wheelchair or other mobility aid to exit the lift platform or ramp. In tests conducted with actual lift/van/wheelchair combinations, (under a Board-sponsored Accessible Parking and Loading Zones Project) researchers found that a space and aisle totaling almost 204 in (5180 mm) wide was needed to deploy a lift and exit conveniently. The "van accessible" parking space required by these guidelines provides a 96 in (2440 mm) wide space with a 96 in (2440 mm) adjacent access aisle which is just wide enough to maneuver and exit from a side mounted lift. If a 96 in (2440 mm) access aisle is placed between two spaces, two "van accessible" spaces are created. Alternatively, if the wide access aisle is provided at the end of a row (an area often unused), it may be possible to provide the wide access aisle without additional space (see Fig. A5(a)).*

A sign is needed to alert van users to the presence of the wider aisle, but the space is not intended to be restricted only to vans.

"Universal" Parking Space Design. An alternative to the provision of a percentage of spaces with a wide aisle, and the associated need to include additional signage, is the use of what has been called the "universal" parking space design. Under this design, all accessible spaces are 132 in (3350 mm) wide with a 60 in (1525 mm) access aisle (see Fig. A5(b)). One

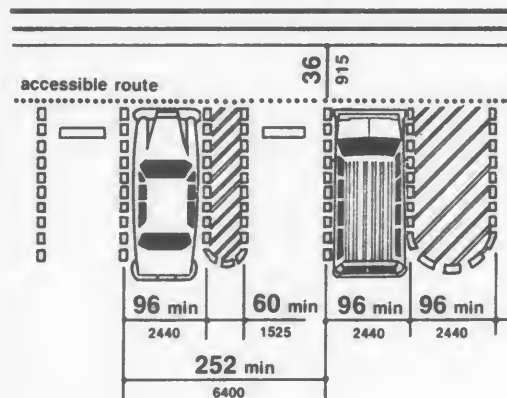

(a)
Van Accessible Space at End Row

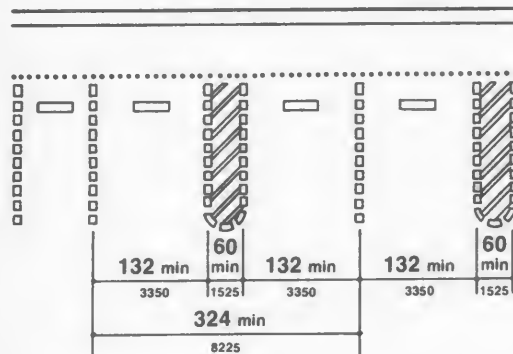

(b)
Universal Parking Space Design

Fig. A5
Parking Space Alternatives

A4.8 Ramps

advantage to this design is that no additional signage is needed because all spaces can accommodate a van with a side-mounted lift or ramp. Also, there is no competition between cars and vans for spaces since all spaces can accommodate either. Furthermore, the wider space permits vehicles to park to one side or the other within the 132 in (3350 mm) space to allow persons to exit and enter the vehicle on either the driver or passenger side, although, in some cases, this would require exiting or entering without a marked access aisle.

An essential consideration for any design is having the access aisle level with the parking space. Since a person with a disability, using a lift or ramp, must maneuver within the access aisle, the aisle cannot include a ramp or sloped area. The access aisle must be connected to an accessible route to the appropriate accessible entrance of a building or facility. The parking access aisle must either blend with the accessible route or have a curb ramp complying with 4.7. Such a curb ramp opening must be located within the access aisle boundaries, not within the parking space boundaries. Unfortunately, many facilities are designed with a ramp that is blocked when any vehicle parks in the accessible space. Also, the required dimensions of the access aisle cannot be restricted by planters, curbs or wheel stops.

A4.6.4 Signage. Signs designating parking places for disabled people can be seen from a driver's seat if the signs are mounted high enough above the ground and located at the front of a parking space.

A4.6.5 Vertical Clearance. High-top vans, which disabled people or transportation services often use, require higher clearances in parking garages than automobiles.

A4.8 Ramps.

A4.8.1 General. Ramps are essential for wheelchair users if elevators or lifts are not available to connect different levels. However, some people who use walking aids have difficulty with ramps and prefer stairs.

A4.8.2 Slope and Rise. Ramp slopes between 1:16 and 1:20 are preferred. The ability to manage an incline is related to both its slope and its length. Wheelchair users with

disabilities affecting their arms or with low stamina have serious difficulty using inclines. Most ambulatory people and most people who use wheelchairs can manage a slope of 1:16. Many people cannot manage a slope of 1:12 for 30 ft (9 m).

A4.8.4 Landings. Level landings are essential toward maintaining an aggregate slope that complies with these guidelines. A ramp landing that is not level causes individuals using wheelchairs to tip backward or bottom out when the ramp is approached.

A4.8.5 Handrails. The requirements for stair and ramp handrails in this guideline are for adults. When children are principal users in a building or facility, a second set of handrails at an appropriate height can assist them and aid in preventing accidents.

A4.9 Stairs.

A4.9.1 Minimum Number. Only interior and exterior stairs connecting levels that are not connected by an elevator, ramp, or other accessible means of vertical access have to comply with 4.9.

A4.10 Elevators.

A4.10.6 Door Protective and Reopening Device. The required door reopening device would hold the door open for 20 seconds if the doorway remains obstructed. After 20 seconds, the door may begin to close. However, if designed in accordance with ASME A17.1-1990, the door closing movement could still be stopped if a person or object exerts sufficient force at any point on the door edge.

A4.10.7 Door and Signal Timing for Hall Calls. This paragraph allows variation in the location of call buttons, advance time for warning signals, and the door-holding period used to meet the time requirement.

A4.10.12 Car Controls. Industry-wide standardization of elevator control panel design would make all elevators significantly more convenient for use by people with severe visual impairments. In many cases, it will be possible to locate the highest control on elevator panels within 48 in (1220 mm) from the floor.

A4.11 Platform Lifts (Wheelchair Lifts)

A4.10.13 Car Position Indicators. A special button may be provided that would activate the audible signal within the given elevator only for the desired trip, rather than maintaining the audible signal in constant operation.

A4.10.14 Emergency Communications. A device that requires no handset is easier to use by people who have difficulty reaching. Also, small handles on handset compartment doors are not usable by people who have difficulty grasping.

Ideally, emergency two-way communication systems should provide both voice and visual display intercommunication so that persons with hearing impairments and persons with vision impairments can receive information regarding the status of a rescue. A voice intercommunication system cannot be the only means of communication because it is not accessible to people with speech and hearing impairments. While a voice intercommunication system is not required, at a minimum, the system should provide both an audio and visual indication that a rescue is on the way.

A4.11 Platform Lifts (Wheelchair Lifts)

A4.11.2 Other Requirements. Inclined stairway chairlifts, and inclined and vertical platform lifts (wheelchair lifts) are available for short-distance, vertical transportation of people with disabilities. Care should be taken in selecting lifts as some lifts are not equally suitable for use by both wheelchair users and semi-ambulatory individuals.

A4.12 Windows.

A4.12.1 General. Windows intended to be operated by occupants in accessible spaces should comply with 4.12.

A4.12.2 Window Hardware. Windows requiring pushing, pulling, or lifting to open (for example, double-hung, sliding, or casement and awning units without cranks) should require no more than 5 lbf (22.2 N) to open or close. Locks, cranks, and other window hardware should comply with 4.27.

A4.13 Doors.

A4.13.8 Thresholds at Doorways. Thresholds and surface height changes in doorways are particularly inconvenient for wheelchair users who also have low stamina or restrictions in arm movement because complex maneuvering is required to get over the level change while operating the door.

A4.13.9 Door Hardware. Some disabled persons must push against a door with their chair or walker to open it. Applied kickplates on doors with closers can reduce required maintenance by withstanding abuse from wheelchairs and canes. To be effective, they should cover the door width, less approximately 2 in (51 mm), up to a height of 16 in (405 mm) from its bottom edge and be centered across the width of the door.

A4.13.10 Door Closers. Closers with delayed action features give a person more time to maneuver through doorways. They are particularly useful on frequently used interior doors such as entrances to toilet rooms.

A4.13.11 Door Opening Force. Although most people with disabilities can exert at least 5 lbf (22.2N), both pushing and pulling from a stationary position, a few people with severe disabilities cannot exert 3 lbf (13.13N). Although some people cannot manage the allowable forces in this guideline and many others have difficulty, door closers must have certain minimum closing forces to close doors satisfactorily. Forces for pushing or pulling doors open are measured with a push-pull scale under the following conditions:

(1) Hinged doors: Force applied perpendicular to the door at the door opener or 30 in (760 mm) from the hinged side, whichever is farther from the hinge.

(2) Sliding or folding doors: Force applied parallel to the door at the door pull or latch.

(3) Application of force: Apply force gradually so that the applied force does not exceed the resistance of the door. In high-rise buildings, air-pressure differentials may require a modification of this specification in order to meet the functional intent.

A4.15 Drinking Fountains and Water Coolers

A4.13.12 Automatic Doors and Power-Assisted Doors. Sliding automatic doors do not need guard rails and are more convenient for wheelchair users and visually impaired people to use. If slowly opening automatic doors can be reactivated before their closing cycle is completed, they will be more convenient in busy doorways.

A4.15 Drinking Fountains and Water Coolers.

A4.15.2 Spout Height. Two drinking fountains, mounted side by side or on a single post, are usable by people with disabilities and people who find it difficult to bend over.

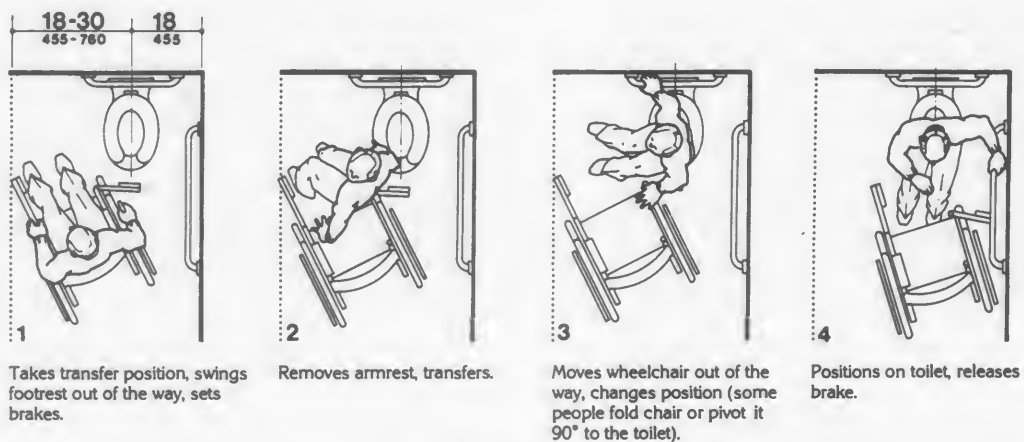

(a) Diagonal Approach

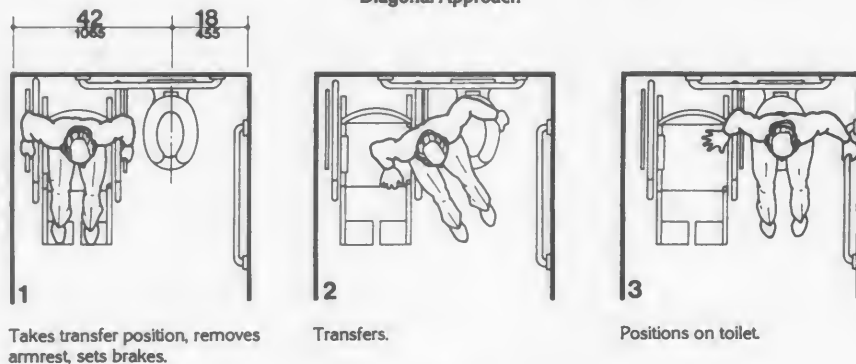

(b) Side Approach

Fig. A6
Wheelchair Transfers

A4.16 Water Closets**A4.16 Water Closets.**

A4.16.3 Height. Height preferences for toilet seats vary considerably among disabled people. Higher seat heights may be an advantage to some ambulatory disabled people, but are often a disadvantage for wheelchair users and others. Toilet seats 18 in (455 mm) high seem to be a reasonable compromise. Thick seats and filler rings are available to adapt standard fixtures to these requirements.

A4.16.4 Grab Bars. Fig. A6(a) and (b) show the diagonal and side approaches most commonly used to transfer from a wheelchair to a water closet. Some wheelchair users can transfer from the front of the toilet while others use a 90-degree approach. Most people who use the two additional approaches can also use either the diagonal approach or the side approach.

A4.16.5 Flush Controls. Flush valves and related plumbing can be located behind walls or to the side of the toilet, or a toilet seat lid can be provided if plumbing fittings are directly behind the toilet seat. Such designs reduce the chance of injury and imbalance caused by leaning back against the fittings. Flush controls for tank-type toilets have a standardized mounting location on the left side of the tank (facing the tank). Tanks can be obtained by special order with controls mounted on the right side. If administrative authorities require flush controls for flush valves to be located in a position that conflicts with the location of the rear grab bar, then that bar may be split or shifted toward the wide side of the toilet area.

A4.17 Toilet Stalls.

A4.17.3 Size and Arrangement. This section requires use of the 60 in (1525 mm) standard stall (Figure 30(a)) and permits the 36 in (915 mm) or 48 in (1220 mm) wide alternate stall (Figure 30(b)) only in alterations where provision of the standard stall is technically infeasible or where local plumbing codes prohibit reduction in the number of fixtures. A standard stall provides a clear space on one side of the water closet to enable persons who use wheelchairs to perform a side or diagonal transfer from the wheelchair to the water closet. However, some persons with disabilities who use mobility aids such as walkers, canes or crutches

are better able to use the two parallel grab bars in the 36 in (915 mm) wide alternate stall to achieve a standing position.

In large toilet rooms, where six or more toilet stalls are provided, it is therefore required that a 36 in (915 mm) wide stall with parallel grab bars be provided *in addition* to the standard stall required in new construction. The 36 in (915 mm) width is necessary to achieve proper use of the grab bars; wider stalls would position the grab bars too far apart to be easily used and narrower stalls would position the grab bars too close to the water closet. Since the stall is primarily intended for use by persons using canes, crutches and walkers, rather than wheelchairs, the length of the stall could be conventional. The door, however, must swing outward to ensure a usable space for people who use crutches or walkers.

A4.17.5 Doors. To make it easier for wheelchair users to close toilet stall doors, doors can be provided with closers, spring hinges, or a pull bar mounted on the inside surface of the door near the hinge side.

A4.19 Lavatories and Mirrors.

A4.19.6 Mirrors. If mirrors are to be used by both ambulatory people and wheelchair users, then they must be at least 74 in (1880 mm) high at their topmost edge. A single full length mirror can accommodate all people, including children.

A4.21 Shower Stalls.

A4.21.1 General. Shower stalls that are 36 in by 36 in (915 mm by 915 mm) wide provide additional safety to people who have difficulty maintaining balance because all grab bars and walls are within easy reach. Seated people use the walls of 36 in by 36 in (915 mm by 915 mm) showers for back support. Shower stalls that are 60 in (1525 mm) wide and have no curb may increase usability of a bathroom by wheelchair users because the shower area provides additional maneuvering space.

A4.22 Toilet Rooms.

A4.22.3 Clear Floor Space. In many small facilities, single-user restrooms may be the only

A4.22 Toilet Rooms

facilities provided for all building users. In addition, the guidelines allow the use of "unisex" or "family" accessible toilet rooms in alterations when technical infeasibility can be demonstrated. Experience has shown that the provision of accessible "unisex" or single-user restrooms is a reasonable way to provide access for wheelchair users and any attendants, especially when attendants are of the opposite sex. Since these facilities have proven so useful, it is often considered advantageous to install a "unisex" toilet room in new facilities in addition to making the multi-stall restrooms accessible, especially in shopping malls, large auditoriums, and convention centers.

Figure 28 (section 4.16) provides minimum clear floor space dimensions for toilets in accessible "unisex" toilet rooms. The dotted lines designate the minimum clear floor space, depending on the direction of approach, required for wheelchair users to transfer onto the water closet. The dimensions of 48 in (1220 mm) and 60 in (1525 mm), respectively, correspond to the space required for the two common transfer approaches utilized by wheelchair users (see Fig. A6). It is important to keep in mind that the placement of the lavatory to the immediate side of the water closet will preclude the side approach transfer illustrated in Figure A6(b).

To accommodate the side transfer, the space adjacent to the water closet must remain clear of obstruction for 42 in (1065 mm) from the centerline of the toilet (Figure 28) and the lavatory must not be located within this clear space. A turning circle or T-turn, the clear floor space at the lavatory, and maneuvering space at the door must be considered when determining the possible wall locations. A privacy latch or other accessible means of ensuring privacy during use should be provided at the door.

RECOMMENDATIONS:

1. In new construction, accessible single-user restrooms may be desirable in some situations because they can accommodate a wide variety of building users. However, they cannot be used in lieu of making the multi-stall toilet rooms accessible as required.
2. Where strict compliance to the guidelines for accessible toilet facilities is technically infeasible in the alteration of existing facilities, accessible "unisex" toilets are a reasonable alternative.
3. In designing accessible single-user restrooms, the provisions of adequate space to allow a side transfer will provide accommodation to the largest number of wheelchair users.

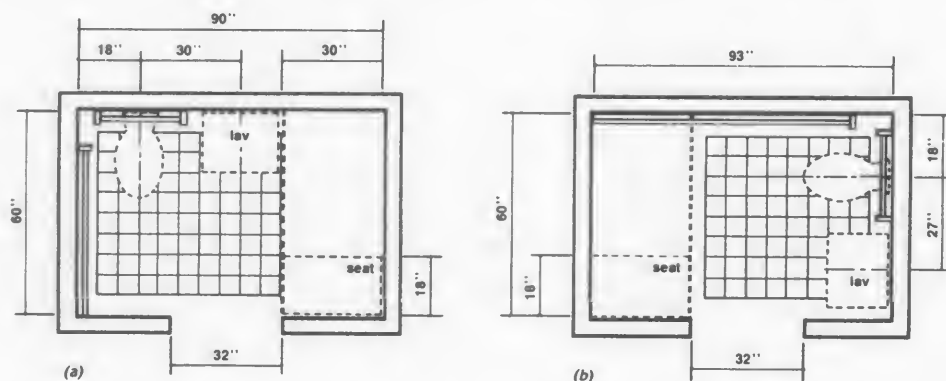

Fig. A7

A4.23 Bathrooms, Bathing Facilities, and Shower Rooms

A4.23 Bathrooms, Bathing Facilities, and Shower Rooms.

A4.23.3 Clear Floor Space. Figure A7 shows two possible configurations of a toilet room with a roll-in shower. The specific shower shown is designed to fit exactly within the dimensions of a standard bathtub. Since the shower does not have a lip, the floor space can be used for required maneuvering space. This would permit a toilet room to be smaller than would be permitted with a bathtub and still provide enough floor space to be considered accessible. This design can provide accessibility in facilities where space is at a premium (i.e., hotels and medical care facilities). The alternate roll-in shower (Fig. 57b) also provides sufficient room for the "T-turn" and does not require plumbing to be on more than one wall.

A4.23.9 Medicine Cabinets. Other alternatives for storing medical and personal care items are very useful to disabled people. Shelves, drawers, and floor-mounted cabinets can be provided within the reach ranges of disabled people.

A4.26 Handrails, Grab Bars, and Tub and Shower Seats.

A4.26.1 General. Many disabled people rely heavily upon grab bars and handrails to maintain balance and prevent serious falls. Many people brace their forearms between supports and walls to give them more leverage and stability in maintaining balance or for lifting. The grab bar clearance of 1-1/2 in (38 mm) required in this guideline is a safety clearance to prevent injuries resulting from arms slipping through the openings. It also provides adequate gripping room.

A4.26.2 Size and Spacing of Grab Bars and Handrails. This specification allows for alternate shapes of handrails as long as they allow an opposing grip similar to that provided by a circular section of 1-1/4 in to 1-1/2 in (32 mm to 38 mm).

A4.27 Controls and Operating Mechanisms.

A4.27.3 Height. Fig. A8 further illustrates

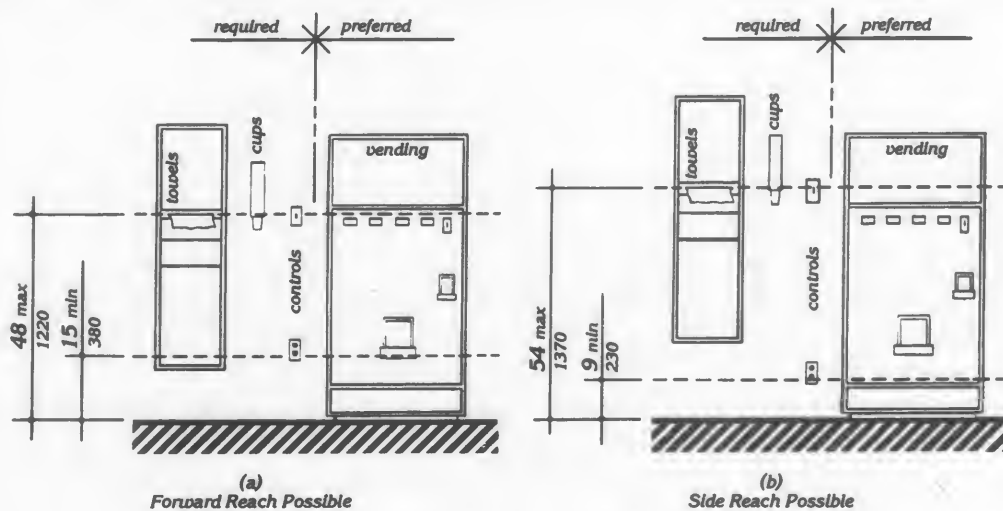

Fig. A8
Control Reach Limitations

A4.28 Alarms

mandatory and advisory control mounting height provisions for typical equipment.

Electrical receptacles installed to serve individual appliances and not intended for regular or frequent use by building occupants are not required to be mounted within the specified reach ranges. Examples would be receptacles installed specifically for wall-mounted clocks, refrigerators, and microwave ovens.

A4.28 Alarms.

A4.28.2 Audible Alarms. Audible emergency signals must have an intensity and frequency that can attract the attention of individuals who have partial hearing loss. People over 60 years of age generally have difficulty perceiving frequencies higher than 10,000 Hz. An alarm signal which has a periodic element to its signal, such as single stroke bells (clang-pause-clang-pause), hi-low (up-down-up-down) and fast whoop (on-off-on-off) are best. Avoid continuous or reverberating tones. Select a signal which has a sound characterized by three or four clear tones without a great deal of "noise" in between.

A4.28.3 Visual Alarms. The specifications in this section do not preclude the use of zoned or coded alarm systems.

A4.28.4 Auxiliary Alarms. Locating visual emergency alarms in rooms where persons who are deaf may work or reside alone can ensure that they will always be warned when an emergency alarm is activated. To be effective, such devices must be located and oriented so that they will spread signals and reflections throughout a space or raise the overall light level sharply. However, visual alarms alone are not necessarily the best means to alert sleepers. A study conducted by Underwriters Laboratory (UL) concluded that a flashing light more than seven times brighter was required (110 candela v. 15 candela, at the same distance) to awaken sleepers as was needed to alert awake subjects in a normal daytime illuminated room.

For hotel and other rooms where people are likely to be asleep, a signal-activated vibrator placed between mattress and box spring or under a pillow was found by UL to be much more effective in alerting sleepers. Many readily available devices are sound-activated so that they could respond to an alarm clock, clock

radio, wake-up telephone call or room smoke detector. Activation by a building alarm system can either be accomplished by a separate circuit activating an auditory alarm which would, in turn, trigger the vibrator or by a signal transmitted through the ordinary 110-volt outlet. Transmission of signals through the power line is relatively simple and is the basis of common, inexpensive remote light control systems sold in many department and electronic stores for home use. So-called "wireless" intercoms operate on the same principal.

A4.29 Detectable Warnings.

A4.29.2 Detectable Warnings on Walking Surfaces. The material used to provide contrast should contrast by at least 70%. Contrast in percent is determined by:

$$\text{Contrast} = [(B_1 - B_2) / B_1] \times 100$$

where B_1 = light reflectance value (LRV) of the lighter area
and B_2 = light reflectance value (LRV) of the darker area.

Note that in any application both white and black are never absolute; thus, B_1 never equals 100 and B_2 is always greater than 0.

A4.30 Signage.

A4.30.1 General. In building complexes where finding locations independently on a routine basis may be a necessity (for example, college campuses), tactile maps or prerecorded instructions can be very helpful to visually impaired people. Several maps and auditory instructions have been developed and tested for specific applications. The type of map or instructions used must be based on the information to be communicated, which depends highly on the type of buildings or users.

Landmarks that can easily be distinguished by visually impaired individuals are useful as orientation cues. Such cues include changes in illumination level, bright colors, unique patterns, wall murals, location of special equipment or other architectural features.

Many people with disabilities have limitations in movement of their heads and reduced peripheral vision. Thus, signage positioned

A4.30 Signage

perpendicular to the path of travel is easiest for them to notice. People can generally distinguish signage within an angle of 30 degrees to either side of the centerlines of their faces without moving their heads.

A4.30.2 Character Proportion. The legibility of printed characters is a function of the viewing distance, character height, the ratio of the stroke width to the height of the character, the contrast of color between character and background, and print font. The size of characters must be based upon the intended viewing distance. A severely nearsighted person may have to be much closer to recognize a character of a given size than a person with normal visual acuity.

A4.30.4 Raised and Brailled Characters and Pictorial Symbol Signs (Pictograms). The standard dimensions for literary Braille are as follows:

| | |
|-------------------------------------|----------|
| Dot diameter | .059 in. |
| Inter-dot spacing | .090 in. |
| Horizontal separation between cells | .241 in. |
| Vertical separation between cells | .395 in. |

Raised borders around signs containing raised characters may make them confusing to read unless the border is set far away from the characters. Accessible signage with descriptive materials about public buildings, monuments, and objects of cultural interest may not provide sufficiently detailed and meaningful information. Interpretive guides, audio tape devices, or other methods may be more effective in presenting such information.

A4.30.5 Finish and Contrast. An eggshell finish (11 to 19 degree gloss on 60 degree glossimeter) is recommended. Research indicates that signs are more legible for persons with low vision when characters contrast with their background by at least 70 percent. Contrast in percent shall be determined by:

$$\text{Contrast} = [(B_1 - B_2) / B_1] \times 100$$

where B_1 = light reflectance value (LRV) of the lighter area
and B_2 = light reflectance value (LRV) of the darker area.

Note that in any application both white and black are never absolute; thus, B_1 never equals 100 and B_2 is always greater than 0.

The greatest readability is usually achieved through the use of light-colored characters or symbols on a dark background.

A4.30.7 Symbols of Accessibility for Different Types of Listening Systems. Paragraph 4 of this section requires signage indicating the availability of an assistive listening system. An appropriate message should be displayed with the international symbol of access for hearing loss since this symbol conveys general accessibility for people with hearing loss. Some suggestions are:

INFRARED
ASSISTIVE LISTENING SYSTEM
AVAILABLE
—PLEASE ASK—

AUDIO LOOP IN USE
TURN T-SWITCH FOR
BETTER HEARING
—OR ASK FOR HELP—

FM
ASSISTIVE LISTENING
SYSTEM AVAILABLE
—PLEASE ASK—

The symbol may be used to notify persons of the availability of other auxiliary aids and services such as: real time captioning, captioned note taking, sign language interpreters, and oral interpreters.

A4.30.8 Illumination Levels. Illumination levels on the sign surface shall be in the 100 to 300 lux range (10 to 30 footcandles) and shall be uniform over the sign surface. Signs shall be located such that the illumination level on the surface of the sign is not significantly exceeded by the ambient light or visible bright lighting source behind or in front of the sign.

A4.31 Telephones

A4.31 Telephones.

A4.31.3 Mounting Height. In localities where the dial-tone first system is in operation, calls can be placed at a coin telephone through the operator without inserting coins. The operator button is located at a height of 46 in (1170 mm) if the coin slot of the telephone is at 54 in (1370 mm). A generally available public telephone with a coin slot mounted lower on the equipment would allow universal installation of telephones at a height of 48 in (1220 mm) or less to all operable parts.

A4.31.9 Text Telephones. A public text telephone may be an integrated text telephone pay phone unit or a conventional portable text telephone that is permanently affixed within, or adjacent to, the telephone enclosure. In order to be usable with a pay phone, a text telephone which is not a single integrated text telephone pay phone unit will require a shelf large enough (10 in (255mm) wide by 10 in (255 mm) deep with a 6 in (150 mm) vertical clearance minimum) to accommodate the device, an electrical outlet, and a power cord. Movable or portable text telephones may be used to provide equivalent facilitation. A text telephone should be readily available so that a person using it may access the text telephone easily and conveniently. As currently designed pocket-type text telephones for personal use do not accommodate a wide range of users. Such devices would not be considered substantially equivalent to conventional text telephones. However, in the future as technology develops this could change.

A4.32 Fixed or Built-in Seating and Tables.

A4.32.4 Height of Tables or Counters. Different types of work require different table or counter heights for comfort and optimal performance. Light detailed work such as writing requires a table or counter close to elbow height for a standing person. Heavy manual work such as rolling dough requires a counter or table height about 10 in (255 mm) below elbow height for a standing person. This principle of high/low table or counter heights also applies for seated persons; however, the limiting condition for seated manual work is clearance under the table or counter.

Table A1 shows convenient counter heights for seated persons. The great variety of heights for comfort and optimal performance indicates a need for alternatives or a compromise in height if people who stand and people who sit will be using the same counter area.

Table A1
Convenient Heights of Tables
and Counters for Seated People¹

| Conditions of Use | Short Women in mm | Tall Men in mm |
|--|----------------------|---------------------|
| Seated in a wheelchair: | | |
| Manual work- | | |
| Desk or removable armrests | 26 660 | 30 760 |
| Fixed, full-size armrests ² | 32 ³ 815 | 32 ³ 815 |
| Light detailed work: | | |
| Desk or removable armrests | 29 735 | 34 865 |
| Fixed, full-size armrests ² | 32 ³ 815 | 34 865 |
| Seated in a 16-in. (405-mm) | | |
| High chair: | | |
| Manual work | 26 660 | 27 685 |
| Light detailed work | 28 710 | 31 785 |

¹ All dimensions are based on a work-surface thickness of 1 1/2 in (38 mm) and a clearance of 1 1/2 in (38 mm) between legs and the underside of a work surface.

² This type of wheelchair arm does not interfere with the positioning of a wheelchair under a work surface.

³ This dimension is limited by the height of the armrests: a lower height would be preferable. Some people in this group prefer lower work surfaces, which require positioning the wheelchair back from the edge of the counter.

A4.33 Assembly Areas.**A4.33.2 Size of Wheelchair Locations.**

Spaces large enough for two wheelchairs allow people who are coming to a performance together to sit together.

A4.33.3 Placement of Wheelchair

Locations. The location of wheelchair areas can be planned so that a variety of positions

Table A2. Summary of Assistive Listening Devices

within the seating area are provided. This will allow choice in viewing and price categories.

Building/life safety codes set minimum distances between rows of fixed seats with consideration of the number of seats in a row, the exit aisle width and arrangement, and the location of exit doors. "Continental" seating, with a greater number of seats per row and a

commensurate increase in row spacing and exit doors, facilitates emergency egress for all people and increases ease of access to mid-row seats especially for people who walk with difficulty. Consideration of this positive attribute of "continental" seating should be included along with all other factors in the design of fixed seating areas.

Table A2. Summary of Assistive Listening Devices

| System | Advantages | Disadvantages | Typical Applications |
|---|--|---|--|
| <p>Induction Loop Transmitter: Transducer wired to induction loop around listening area. Receiver: Self-contained induction receiver or personal hearing aid with telecoil.</p> | <p>Cost-Effective Low Maintenance Easy to use Unobtrusive May be possible to integrate into existing public address system. Some hearing aids can function as receivers.</p> | <p>Signal spills over to adjacent rooms. Susceptible to electrical interference. Limited portability Inconsistent signal strength. Head position affects signal strength. Lack of standards for induction coil performance.</p> | <p>Meeting areas Theaters Churches and Temples Conference rooms Classrooms TV viewing</p> |
| <p>FM Transmitter: Flashlight-sized worn by speaker. Receiver: With personal hearing aid via DAI or induction neck-loop and telecoil; or self-contained with earphone(s).</p> | <p>Highly portable Different channels allow use by different groups within the same room. High user mobility Variable for large range of hearing losses.</p> | <p>High cost of receivers Equipment fragile Equipment obtrusive High maintenance Expensive to maintain Custom fitting to individual user may be required.</p> | <p>Classrooms Tour groups Meeting areas Outdoor events One-on-one</p> |
| <p>Infrared Transmitter: Emitter in line-of-sight with receiver. Receiver: Self-contained. Or with personal hearing aid via DAI or induction neckloop and telecoil.</p> | <p>Easy to use Insures privacy or confidentiality Moderate cost Can often be integrated into existing public address system.</p> | <p>Line-of-sight required between emitter and receiver. Ineffective outdoors Limited portability Requires installation</p> | <p>Theaters Churches and Temples Auditoriums Meetings requiring confidentiality TV viewing</p> |

Source: Rehab Brief, National Institute on Disability and Rehabilitation Research, Washington, DC, Vol. XII, No. 10, (1990).

A5.0 Restaurants and Cafeterias**A4.33.6 Placement of Listening**

Systems. A distance of 50 ft (15 m) allows a person to distinguish performers' facial expressions.

A4.33.7 Types of Listening Systems. An assistive listening system appropriate for an assembly area for a group of persons or where the specific individuals are not known in advance, such as a playhouse, lecture hall or movie theater, may be different from the system appropriate for a particular individual provided as an auxiliary aid or as part of a reasonable accommodation. The appropriate device for an individual is the type that individual can use, whereas the appropriate system for an assembly area will necessarily be geared toward the "average" or aggregate needs of various individuals. A listening system that can be used from any seat in a seating area is the most flexible way to meet this specification. Ear-phone jacks with variable volume controls can benefit only people who have slight hearing loss and do not help people who use hearing aids. At the present time, magnetic induction loops are the most feasible type of listening system for people who use hearing aids equipped with "T-coils," but people without hearing aids or those with hearing aids not equipped with inductive pick-ups cannot use them without special receivers. Radio frequency systems can be extremely effective and inexpensive. People without hearing aids can use them, but people with hearing aids need a special receiver to use them as they are presently designed. If hearing aids had a jack to allow a by-pass of microphones, then radio frequency systems would be suitable for people with and without hearing aids. Some listening systems may be subject to interference from other equipment and feedback from hearing aids of people who are using the systems. Such interference can be controlled by careful engineering design that anticipates feedback sources in the surrounding area.

Table A2, reprinted from a National Institute of Disability and Rehabilitation Research "Rehab Brief," shows some of the advantages and

disadvantages of different types of assistive listening systems. In addition, the Architectural and Transportation Barriers Compliance Board (Access Board) has published a pamphlet on Assistive Listening Systems which lists demonstration centers across the country where technical assistance can be obtained in selecting and installing appropriate systems. The state of New York has also adopted a detailed technical specification which may be useful.

A5.0 Restaurants and Cafeterias.

A5.1 General. Dining counters (where there is no service) are typically found in small carry-out restaurants, bakeries, or coffee shops and may only be a narrow eating surface attached to a wall. This section requires that where such a dining counter is provided, a portion of the counter shall be at the required accessible height.

A7.0 Business and Mercantile.**A7.2(3) Assistive Listening Devices.**

At all sales and service counters, teller windows, box offices, and information kiosks where a physical barrier separates service personnel and customers, it is recommended that at least one permanently installed assistive listening device complying with 4.33 be provided at each location or series. Where assistive listening devices are installed, signage should be provided identifying those stations which are so equipped.

A7.3 Check-out Aisles. Section 7.2 refers to counters without aisles; section 7.3 concerns check-out aisles. A counter without an aisle (7.2) can be approached from more than one direction such as in a convenience store. In order to use a check-out aisle (7.3), customers must enter a defined area (an aisle) at a particular point, pay for goods, and exit at a particular point.

federal register

Friday
July 26, 1991

Part III

Department of Justice

Office of the Attorney General

28 CFR Part 36

**Nondiscrimination on the Basis of
Disability by Public Accommodations and
In Commercial Facilities; Final Rule**

DEPARTMENT OF JUSTICE**Office of the Attorney General****28 CFR Part 36**

[Order No. 1513-91]

Nondiscrimination on the Basis of Disability by Public Accommodations and in Commercial Facilities**AGENCY:** Department of Justice.**ACTION:** Final rule.

SUMMARY: This rule implements title III of the Americans with Disabilities Act, Public Law 101-336, which prohibits discrimination on the basis of disability by private entities in places of public accommodation, requires that all new places of public accommodation and commercial facilities be designed and constructed so as to be readily accessible to and usable by persons with disabilities, and requires that examinations or courses related to licensing or certification for professional and trade purposes be accessible to persons with disabilities.

EFFECTIVE DATE: January 26, 1992.

FOR FURTHER INFORMATION CONTACT: Barbara S. Drake, Deputy Assistant Attorney General, Civil Rights Division; Stewart B. Oneglia, Chief, Coordination and Review Section, Civil Rights Division; and John Wodatch, Director, Office on the Americans with Disabilities Act, Civil Rights Division; all of the U.S. Department of Justice, Washington, DC 20530. They may be contacted through the Division's ADA Information Line at (202) 514-0301 (Voice), (202) 514-0381 (TDD), or (202) 514-0383 (TDD). These telephone numbers are not toll-free numbers.

Copies of this rule are available in the following alternate formats: large print, Braille, electronic file on computer disk, and audio-tape. Copies may be obtained from the Office on the Americans with Disabilities Act at (202) 514-0301 (Voice) or (202) 514-0381 (TDD). The rule is also available on electronic bulletin board at (202) 514-6193. These telephone numbers are not toll-free numbers.

SUPPLEMENTARY INFORMATION:**Background**

The landmark Americans with Disabilities Act ("ADA" or "the Act"), enacted on July 26, 1990, provides comprehensive civil rights protections to individuals with disabilities in the areas of employment, public accommodations, State and local government services, and telecommunications.

The legislation was originally developed by the National Council on Disability, an independent Federal

agency that reviews and makes recommendations concerning Federal laws, programs, and policies affecting individuals with disabilities. In its 1988 study, "Toward Independence," the National Council on Disability recognized the inadequacy of the existing, limited patchwork of protections for individuals with disabilities, and recommended the enactment of a comprehensive civil rights law requiring equal opportunity for individuals with disabilities throughout American life. Although the 100th Congress did not act on the legislation, which was first introduced in 1988, then-Vice-President George Bush endorsed the concept of comprehensive disability rights legislation during his presidential campaign and became a dedicated advocate of the ADA.

The ADA was reintroduced in modified form in May 1989 for consideration by the 101st Congress. In June 1989, Attorney General Dick Thornburgh, in testimony before the Senate Committee on Labor and Human Resources, reiterated the Bush Administration's support for the ADA and suggested changes in the proposed legislation. After extensive negotiations between Senate sponsors and the Administration, the Senate passed an amended version of the ADA on September 7, 1989, by a vote of 76-8.

In the House, jurisdiction over the ADA was divided among four committees, each of which conducted extensive hearings and issued detailed committee reports: the Committee on Education and Labor, the Committee on the Judiciary, the Committee on Public Works and Transportation, and the Committee on Energy and Commerce. On October 12, 1989, the Attorney General testified in favor of the legislation before the Committee on the Judiciary. The Civil Rights Division, on February 22, 1990, provided testimony to the Committee on Small Business, which although technically without jurisdiction over the bill, conducted hearings on the legislation's impact on small business.

After extensive committee consideration and floor debate, the House of Representatives passed an amended version of the Senate bill on May 22, 1990, by a vote of 403-20. After resolving their differences in conference, the Senate and House took final action on the bill—the House passing it by a vote of 377-28 on July 12, 1990, and the Senate, a day later, by a vote of 91-6. The ADA was enacted into law with the President's signature at a White House ceremony on July 26, 1990.

Rulemaking History

On February 22, 1991, the Department of Justice published a notice of proposed rulemaking (NPRM) implementing title III of the ADA in the *Federal Register* (56 FR 7452). On February 28, 1991, the Department published a notice of proposed rulemaking implementing subtitle A of title II of the ADA in the *Federal Register* (56 FR 8538). Each NPRM solicited comments on the definitions, standards, and procedures of the proposed rules. By the April 29, 1991, close of the comment period of the NPRM for title II, the Department had received 2,718 comments on the two proposed rules. Following the close of the comment period, the Department received an additional 222 comments.

In order to encourage public participation in the development of the Department's rules under the ADA, the Department held four public hearings. Hearings were held in Dallas, Texas on March 4-5, 1991; in Washington, DC on March 13-14-15, 1991; in San Francisco, California on March 18-19, 1991; and in Chicago, Illinois on March 27-28, 1991. At these hearings, 329 persons testified and 1,567 pages of testimony were compiled. Transcripts of the hearings were included in the Department's rulemaking docket.

The comments that the Department received occupy almost six feet of shelf space and contain over 10,000 pages. The Department received comments from individuals from all fifty States and the District of Columbia. Nearly 75% of the comments came from individuals and from organizations representing the interests of persons with disabilities. The Department received 292 comments from entities covered by the ADA and trade associations representing businesses in the private sector, and 67 from government units, such as mayors' offices, public school districts, and various State agencies working with individuals with disabilities.

The Department received one comment from a consortium of 511 organizations representing a broad spectrum of persons with disabilities. In addition, at least another 25 commenters endorsed the position expressed by this consortium or submitted identical comments on one or both proposed regulations.

An organization representing persons with hearing impairments submitted a large number of comments. This organization presented the Department with 479 individual comments, each providing in chart form a detailed representation of what type of auxiliary aid or service would be useful in the

various categories of places of public accommodation.

The Department received a number of comments based on almost ten different form letters. For example, individuals who have a heightened sensitivity to a variety of chemical substances submitted 266 postcards detailing how exposure to various environmental conditions restricts their access to places of public accommodation and to commercial facilities. Another large group of form letters came from groups affiliated with independent living centers.

The vast majority of the comments addressed the Department's proposal implementing title III. Just over 100 comments addressed only issues presented in the proposed title II regulation.

The Department read and analyzed each comment that was submitted in a timely fashion. Transcripts of the four hearings were analyzed along with the written comments. The decisions that the Department has made in response to these comments, however, were not made on the basis of the number of commenters addressing any one point but on a thorough consideration of the merits of the points of view expressed in the comments. Copies of the written comments, including transcripts of the four hearings, will remain available for public inspection in room 854 of the HOLC Building, 320 First Street, NW., Washington, DC from 10 a.m. to 5 p.m., Monday through Friday, except for legal holidays, until August 30, 1991.

The Americans with Disabilities Act gives to individuals with disabilities civil rights protections with respect to discrimination that are parallel to those provided to individuals on the basis of race, color, national origin, sex, and religion. It combines in its own unique formula elements drawn principally from two key civil rights statutes—the Civil Rights Act of 1964 and title V of the Rehabilitation Act of 1973. The ADA generally employs the framework of titles II (42 U.S.C. 2000a to 2000a-6) and VII (42 U.S.C. 2000e to 2000e-16) of the Civil Rights Act of 1964 for coverage and enforcement and the terms and concepts of section 504 of the Rehabilitation Act of 1973 (29 U.S.C. 794) for what constitutes discrimination.

Other recently enacted legislation will facilitate compliance with the ADA. As amended in 1990, the Internal Revenue Code allows a deduction of up to \$15,000 per year for expenses associated with the removal of qualified architectural and transportation barriers. The 1990 amendment also permits eligible small businesses to receive a tax credit for certain costs of compliance with the

ADA. An eligible small business is one whose gross receipts do not exceed \$1,000,000 or whose workforce does not consist of more than 30 full-time workers. Qualifying businesses may claim a credit of up to 50 percent of eligible access expenditures that exceed \$250 but do not exceed \$10,250. Examples of eligible access expenditures include the necessary and reasonable costs of removing barriers, providing auxiliary aids, and acquiring or modifying equipment or devices.

In addition, the Communications Act of 1934 has been amended by the Television Decoder Circuitry Act of 1990, Public Law 101-431, to require as of July 1, 1993, that all televisions with screens of 13 inches or wider have built-in decoder circuitry for displaying closed captions. This new law will eventually lessen dependence on the use of portable decoders in achieving compliance with the auxiliary aids and services requirements of the rule.

Overview of the Rule

The final rule establishes standards and procedures for the implementation of title III of the Act, which addresses discrimination by private entities in places of public accommodation, commercial facilities, and certain examinations and courses. The careful consideration Congress gave title III is reflected in the detailed statutory provisions and the expansive reports of the Senate Committee on Labor and Human Resources and the House Committees on the Judiciary, and Education and Labor. The final rule follows closely the language of the Act and supplements it, where appropriate, with interpretive material found in the committee reports.

The rule is organized into six subparts. Subpart A, "General," includes the purpose and application sections, describes the relationship of the Act to other laws, and defines key terms used in the regulation.

Subpart B, "General Requirements," contains material derived from what the statute calls the "General Rule," and the "General Prohibition," in sections 302(a) and 302(b)(1), respectively, of the Act. Topics addressed by this subpart include discriminatory denials of access or participation, landlord and tenant obligations, the provision of unequal benefits, indirect discrimination through contracting, the participation of individuals with disabilities in the most integrated setting appropriate to their needs, and discrimination based on association with individuals with disabilities. Subpart B also contains a number of "miscellaneous" provisions derived from title V of the Act that

involve issues such as retaliation and coercion for asserting ADA rights, illegal drug use, insurance, and restrictions on smoking in places of public accommodation. Finally, subpart B contains additional general provisions regarding direct threats to health or safety, maintenance of accessible features of facilities and equipment, and the coverage of places of public accommodation located in private residences.

Subpart C, "Specific Requirements," addresses the "Specific Prohibitions" in section 302(b)(2) of the Act. Included in this subpart are topics such as discriminatory eligibility criteria; reasonable modifications in policies, practices or procedures; auxiliary aids and services; the readily achievable removal of barriers and alternatives to barrier removal; the extent to which inventories of accessible or special goods are required; seating in assembly areas; personal devices and services; and transportation provided by public accommodations. Subpart C also incorporates the requirements of section 309 of title III relating to examinations and courses.

Subpart D, "New Construction and Alterations," sets forth the requirements for new construction and alterations based on section 303 of the Act. It addresses such issues as what facilities are covered by the new construction requirements, what an alteration is, the application of the elevator exception, the path of travel obligations resulting from an alteration to a primary function area, requirements for commercial facilities located in private residences, and the application of alterations requirements to historic buildings and facilities.

Subpart E, "Enforcement," describes the Act's title III enforcement procedures, including private actions, as well as investigations and litigation conducted by the Attorney General. These provisions are based on sections 308 and 310(b) of the Act.

Subpart F, "Certification of State Laws or Local Building Codes," establishes procedures for the certification of State or local building accessibility ordinances that meet or exceed the new construction and alterations requirements of the ADA. These provisions are based on section 308(b)(1)(A)(ii) of the Act.

The section-by-section analysis of the rule explains in detail the provisions of each of these subparts.

The Department is also today publishing a final rule for the implementation and enforcement of subtitle A of title II of the Act. This rule

prohibits discrimination on the basis of disability against qualified individuals with disabilities in all services, programs, or activities of State and local government.

Regulatory Process Matters

This final rule has been reviewed by the Office of Management and Budget (OMB) under Executive Order 12291. The Department is preparing a regulatory impact analysis (RIA) of this rule, and the Architectural and Transportation Barriers Compliance Board is preparing an RIA for its Americans with Disabilities Act Accessibility Guidelines for Buildings and Facilities (ADAAG) that are incorporated in Appendix A of the Department's final rule. Draft copies of both preliminary RIAs are available for comment; the Department will provide copies of these documents to the public upon request. Commenters are urged to provide additional information as to the costs and benefits associated with this rule. This will facilitate the development of a final RIA by January 1, 1992.

The Department's RIA will evaluate the economic impact of the final rule. Included among those title III provisions that are likely to result in significant economic impact are the requirements for auxiliary aids, barrier removal in existing facilities, and readily accessible new construction and alterations. An analysis of the costs of these provisions will be included in the RIA.

The preliminary RIA prepared for the notice of proposed rulemaking contained all of the available information that would have been included in a preliminary regulatory flexibility analysis, had one been prepared under the Regulatory Flexibility Act, concerning the rule's impact on small entities. The final RIA will contain all of the information that is required in a final regulatory flexibility analysis, and will serve as such an analysis. Moreover, the extensive notice and comment procedure followed by the Department in the promulgation of this rule, which included public hearings, dissemination of materials, and provision of speakers to affected groups, clearly provided any interested small entities with the notice and opportunity for comment provided for under the Regulatory Flexibility Act procedures.

This final rule will preempt State laws affecting entities subject to the ADA only to the extent that those laws directly conflict with the statutory requirements of the ADA. Therefore, this rule is not subject to Executive Order 12612, and a Federalism Assessment is not required.

The reporting and recordkeeping requirements described in subpart F of the rule are considered to be information collection requirements as that term is defined by the Office of Management and Budget in 5 CFR part 1320. Accordingly, those information collection requirements have been submitted to OMB for review pursuant to the Paperwork Reduction Act.

Section-By-Section Analysis and Response to Comments

Subpart A—General

Section 36.101 Purpose

Section 36.101 states the purpose of the rule, which is to effectuate title III of the Americans with Disabilities Act of 1990. This title prohibits discrimination on the basis of disability by public accommodations, requires places of public accommodation and commercial facilities to be designed, constructed, and altered in compliance with the accessibility standards established by this part, and requires that examinations or courses related to licensing or certification for professional or trade purposes be accessible to persons with disabilities.

Section 36.102 Application

Section 36.102 specifies the range of entities and facilities that have obligations under the final rule. The rule applies to any public accommodation or commercial facility as those terms are defined in § 36.104. It also applies, in accordance with section 309 of the ADA, to private entities that offer examinations or courses related to applications, licensing, certification, or credentialing for secondary or postsecondary education, professional, or trade purposes. Except as provided in § 36.206, "Retaliation or coercion," this part does not apply to individuals other than public accommodations or to public entities. Coverage of private individuals and public entities is discussed in the preamble to § 36.206.

As defined in § 36.104, a public accommodation is a private entity that owns, leases or leases to, or operates a place of public accommodation. Section 36.102(b)(2) emphasizes that the general and specific public accommodations requirements of subparts B and C obligate a public accommodation only with respect to the operations of a place of public accommodation. This distinction is drawn in recognition of the fact that a private entity that meets the regulatory definition of public accommodation could also own, lease or lease to, or operate facilities that are not places of public accommodation. The rule would exceed the reach of the ADA

if it were to apply the public accommodations requirements of subparts B and C to the operations of a private entity that do not involve a place of public accommodation. Similarly, § 36.102(b)(3) provides that the new construction and alterations requirements of subpart D obligate a public accommodation only with respect to facilities used as, or designed or constructed for use as, places of public accommodation or commercial facilities.

On the other hand, as mandated by the ADA and reflected in § 36.102(c), the new construction and alterations requirements of subpart D apply to a commercial facility whether or not the facility is a place of public accommodation, or is owned, leased, leased to, or operated by a public accommodation.

Section 36.102(e) states that the rule does not apply to any private club, religious entity, or public entity. Each of these terms is defined in § 36.104. The exclusion of private clubs and religious entities is derived from section 307 of the ADA; and the exclusion of public entities is based on the statutory definition of public accommodation in section 301(7) of the ADA, which excludes entities other than private entities from coverage under title III of the ADA.

Section 36.103 Relationship to Other Laws

Section 36.103 is derived from sections 501 (a) and (b) of the ADA. Paragraph (a) provides that, except as otherwise specifically provided by this part, the ADA is not intended to apply lesser standards than are required under title V of the Rehabilitation Act of 1973, as amended (29 U.S.C. 790-794), or the regulations implementing that title. The standards of title V of the Rehabilitation Act apply for purposes of the ADA to the extent that the ADA has not explicitly adopted a different standard from title V. Where the ADA explicitly provides a different standard from section 504, the ADA standard applies to the ADA, but not to section 504. For example, section 504 requires that all federally assisted programs and activities be readily accessible to and usable by individuals with handicaps, even if major structural alterations are necessary to make a program accessible. Title III of the ADA, in contrast, only requires alterations to existing facilities if the modifications are "readily achievable," that is, able to be accomplished easily and without much difficulty or expense. A public accommodation that is covered under both section 504 and the ADA is still

required to meet the "program accessibility" standard in order to comply with section 504, but would not be in violation of the ADA unless it failed to make "readily achievable" modifications. On the other hand, an entity covered by the ADA is required to make "readily achievable" modifications, even if the program can be made accessible without any architectural modifications. Thus, an entity covered by both section 504 and title III of the ADA must meet both the "program accessibility" requirement and the "readily achievable" requirement.

Paragraph (b) makes explicit that the rule does not affect the obligation of recipients of Federal financial assistance to comply with the requirements imposed under section 504 of the Rehabilitation Act of 1973.

Paragraph (c) makes clear that Congress did not intend to displace any of the rights or remedies provided by other Federal laws or other State or local laws (including State common law) that provide greater or equal protection to individuals with disabilities. A plaintiff may choose to pursue claims under a State law that does not confer greater substantive rights, or even confers fewer substantive rights, if the alleged violation is protected under the alternative law and the remedies are greater. For example, assume that a person with a physical disability seeks damages under a State law that allows compensatory and punitive damages for discrimination on the basis of physical disability, but does not allow them on the basis of mental disability. In that situation, the State law would provide narrower coverage, by excluding mental disabilities, but broader remedies, and an individual covered by both laws could choose to bring an action under both laws. Moreover, State tort claims confer greater remedies and are not preempted by the ADA. A plaintiff may join a State tort claim to a case brought under the ADA. In such a case, the plaintiff must, of course, prove all the elements of the State tort claim in order to prevail under that cause of action.

A commenter had concerns about privacy requirements for banking transactions using telephone relay services. Title IV of the Act provides adequate protections for ensuring the confidentiality of communications using the relay services. This issue is more appropriately addressed by the Federal Communications Commission in its regulation implementing title IV of the Act.

Section 36.104 Definitions

"Act." The word "Act" is used in the regulation to refer to the Americans with

Disabilities Act of 1990, Pub. L. 101-336, which is also referred to as the "ADA."

"Commerce." The definition of "commerce" is identical to the statutory definition provided in section 301(l) of the ADA. It means travel, trade, traffic, commerce, transportation, or communication among the several States, between any foreign country or any territory or possession and any State, or between points in the same State but through another State or foreign country. Commerce is defined in the same manner as in title II of the Civil Rights Act of 1964, which prohibits racial discrimination in public accommodations.

The term "commerce" is used in the definition of "place of public accommodation." According to that definition, one of the criteria that an entity must meet before it can be considered a place of public accommodation is that its operations affect commerce. The term "commerce" is similarly used in the definition of "commercial facility."

The use of the phrase "operations affect commerce" applies the full scope of coverage of the Commerce Clause of the Constitution in enforcing the ADA. The Constitution gives Congress broad authority to regulate interstate commerce, including the activities of local business enterprises (e.g., a physician's office, a neighborhood restaurant, a laundromat, or a bakery) that affect interstate commerce through the purchase or sale of products manufactured in other States, or by providing services to individuals from other States. Because of the integrated nature of the national economy, the ADA and this final rule will have extremely broad application.

"Commercial facilities" are those facilities that are intended for nonresidential use by a private entity and whose operations affect commerce. As explained under § 36.401, "New construction," the new construction and alteration requirements of subpart D of the rule apply to all commercial facilities, whether or not they are places of public accommodation. Those commercial facilities that are not places of public accommodation are not subject to the requirements of subparts B and C (e.g., those requirements concerning auxiliary aids and general nondiscrimination provisions).

Congress recognized that the employees within commercial facilities would generally be protected under title I (employment) of the Act. However, as the House Committee on Education and Labor pointed out, "[t]o the extent that new facilities are built in a manner that make[s] them accessible to all

individuals, including potential employees, there will be less of a need for individual employers to engage in reasonable accommodations for particular employees." H.R. Rep. No. 485, 101st Cong., 2d Sess., pt. 2, at 117 (1990) [hereinafter "Education and Labor report"]. While employers of fewer than 15 employees are not covered by title I's employment discrimination provisions, there is no such limitation with respect to new construction covered under title III. Congress chose not to so limit the new construction provisions because of its desire for a uniform requirement of accessibility in new construction, because accessibility can be accomplished easily in the design and construction stage, and because future expansion of a business or sale or lease of the property to a larger employer or to a business that is a place of public accommodation is always a possibility.

The term "commercial facilities" is not intended to be defined by dictionary or common industry definitions. Included in this category are factories, warehouses, office buildings, and other buildings in which employment may occur. The phrase, "whose operations affect commerce," is to be read broadly, to include all types of activities reached under the commerce clause of the Constitution.

Privately operated airports are also included in the category of commercial facilities. They are not, however, places of public accommodation because they are not terminals used for "specified public transportation." (Transportation by aircraft is specifically excluded from the statutory definition of "specified public transportation.") Thus, privately operated airports are subject to the new construction and alteration requirements of this rule (subpart D) but not to subparts B and C. (Airports operated by public entities are covered by title II of the Act.) Places of public accommodation located within airports, such as restaurants, shops, lounges, or conference centers, however, are covered by subparts B and C of this part.

The statute's definition of "commercial facilities" specifically includes only facilities "that are intended for nonresidential use" and specifically exempts those facilities that are covered or expressly exempted from coverage under the Fair Housing Act of 1968, as amended (42 U.S.C. 3601-3631). The interplay between the Fair Housing Act and the ADA with respect to those facilities that are "places of public accommodation" was the subject of many comments and is addressed in the

preamble discussion of the definition of "place of public accommodation."

"Current illegal use of drugs." The phrase "current illegal use of drugs" is used in § 36.209. Its meaning is discussed in the preamble for that section.

"Disability." The definition of the term "disability" is comparable to the definition of the term "individual with handicaps" in section 7(8)(B) of the Rehabilitation Act and section 802(h) of the Fair Housing Act. The Education and Labor Committee report makes clear that the analysis of the term "individual with handicaps" by the Department of Health, Education, and Welfare in its regulations implementing section 504 (42 FR 22685 (May 4, 1977)) and the analysis by the Department of Housing and Urban Development in its regulation implementing the Fair Housing Amendments Act of 1988 (54 FR 3232 (Jan. 23, 1989)) should also apply fully to the term "disability" (Education and Labor report at 50).

The use of the term "disability" instead of "handicap" and the term "individual with a disability" instead of "individual with handicaps" represents an effort by the Congress to make use of up-to-date, currently accepted terminology. The terminology applied to individuals with disabilities is a very significant and sensitive issue. As with racial and ethnic terms, the choice of words to describe a person with a disability is overlaid with stereotypes, patronizing attitudes, and other emotional connotations. Many individuals with disabilities, and organizations representing such individuals, object to the use of such terms as "handicapped person" or "the handicapped." In other recent legislation, Congress also recognized this shift in terminology, e.g., by changing the name of the National Council on the Handicapped to the National Council on Disability (Pub. L. 100-630).

In enacting the Americans with Disabilities Act, Congress concluded that it was important for the current legislation to use terminology most in line with the sensibilities of most Americans with disabilities. No change in definition or substance is intended nor should be attributed to this change in phraseology.

The term "disability" means, with respect to an individual—

(A) A physical or mental impairment that substantially limits one or more of the major life activities of such individual;

(B) A record of such an impairment; or

(C) Being regarded as having such an impairment.

If an individual meets any one of these three tests, he or she is considered to be an individual with a disability for purposes of coverage under the Americans with Disabilities Act.

Congress adopted this same basic definition of "disability," first used in the Rehabilitation Act of 1973 and in the Fair Housing Amendments Act of 1988, for a number of reasons. It has worked well since it was adopted in 1974. There is a substantial body of administrative interpretation and judicial precedent on this definition. Finally, it would not be possible to guarantee comprehensiveness by providing a list of specific disabilities, especially because new disorders may be recognized in the future, as they have since the definition was first established in 1974.

Test A—A Physical or Mental Impairment That Substantially Limits One or More of the Major Life Activities of Such Individual

Physical or mental impairment. Under the first test, an individual must have a physical or mental impairment. As explained in paragraph (1) (i) of the definition, "impairment" means any physiological disorder or condition, cosmetic disfigurement, or anatomical loss affecting one or more of the following body systems: Neurological; musculoskeletal; special sense organs (including speech organs that are not respiratory, such as vocal cords, soft palate, and tongue); respiratory, including speech organs; cardiovascular; reproductive; digestive; genitourinary; hemic and lymphatic; skin; and endocrine. It also means any mental or psychological disorder, such as mental retardation, organic brain syndrome, emotional or mental illness, and specific learning disabilities. This list closely tracks the one used in the regulations for section 504 of the Rehabilitation Act of 1973 (see, e.g., 45 CFR 84.3(j)(2)(i)).

Many commenters asked that "traumatic brain injury" be added to the list in paragraph (1)(i). Traumatic brain injury is already included because it is a physiological condition affecting one of the listed body systems, i.e., "neurological." Therefore, it was unnecessary for the Department to add the term to the regulation.

It is not possible to include a list of all the specific conditions, contagious and noncontagious diseases, or infections that would constitute physical or mental impairments because of the difficulty of ensuring the comprehensiveness of such a list, particularly in light of the fact that other conditions or disorders may be identified in the future. However, the list of examples in paragraph (1)(iii) of the

definition includes: Orthopedic, visual, speech and hearing impairments; cerebral palsy; epilepsy, muscular dystrophy, multiple sclerosis, cancer, heart disease, diabetes, mental retardation, emotional illness, specific learning disabilities, HIV disease (symptomatic or asymptomatic), tuberculosis, drug addiction, and alcoholism.

The examples of "physical or mental impairments" in paragraph (1)(iii) are the same as those contained in many section 504 regulations, except for the addition of the phrase "contagious and noncontagious" to describe the types of diseases and conditions included, and the addition of "HIV disease (symptomatic or asymptomatic)" and "tuberculosis" to the list of examples. These additions are based on the ADA committee reports, caselaw, and official legal opinions interpreting section 504. In *School Board of Nassau County v. Arline*, 480 U.S. 273 (1987), a case involving an individual with tuberculosis, the Supreme Court held that people with contagious diseases are entitled to the protections afforded by section 504. Following the *Arline* decision, this Department's Office of Legal Counsel issued a legal opinion that concluded that symptomatic HIV disease is an impairment that substantially limits a major life activity; therefore it has been included in the definition of disability under this part. The opinion also concluded that asymptomatic HIV disease is an impairment that substantially limits a major life activity, either because of its actual effect on the individual with HIV disease or because the reactions of other people to individuals with HIV disease cause such individuals to be treated as though they are disabled. See Memorandum from Douglas W. Kmiec, Acting Assistant Attorney General, Office of Legal Counsel, Department of Justice, to Arthur B. Culvahouse, Jr., Counsel to the President (Sept. 27, 1988), reprinted in Hearings on S. 933, the Americans with Disabilities Act, Before the Subcomm. on the Handicapped of the Senate Comm. on Labor and Human Resources, 101st Cong., 1st Sess. 346 (1989). The phrase "symptomatic or asymptomatic" was inserted in the final rule after "HIV disease" in response to commenters who suggested that the clarification was necessary to give full meaning to the Department's opinion.

Paragraph (1)(iv) of the definition states that the phrase "physical or mental impairment" does not include homosexuality or bisexuality. These conditions were never considered impairments under other Federal

disability laws. Section 511(a) of the statute makes clear that they are likewise not to be considered impairments under the Americans with Disabilities Act.

Physical or mental impairment does not include simple physical characteristics, such as blue eyes or black hair. Nor does it include environmental, cultural, economic, or other disadvantages, such as having a prison record, or being poor. Nor is age a disability. Similarly, the definition does not include common personality traits such as poor judgment or a quick temper where these are not symptoms of a mental or psychological disorder. However, a person who has these characteristics and also has a physical or mental impairment may be considered as having a disability for purposes of the Americans with Disabilities Act based on the impairment.

Substantial limitation of a major life activity. Under Test A, the impairment must be one that "substantially limits a major life activity." Major life activities include such things as caring for one's self, performing manual tasks, walking, seeing, hearing, speaking, breathing, learning, and working. For example, a person who is paraplegic is substantially limited in the major life activity of walking, a person who is blind is substantially limited in the major life activity of seeing, and a person who is mentally retarded is substantially limited in the major life activity of learning. A person with traumatic brain injury is substantially limited in the major life activities of caring for one's self, learning, and working because of memory deficit, confusion, contextual difficulties, and inability to reason appropriately.

A person is considered an individual with a disability for purposes of Test A, the first prong of the definition, when the individual's important life activities are restricted as to the conditions, manner, or duration under which they can be performed in comparison to most people. A person with a minor, trivial impairment, such as a simple infected finger, is not impaired in a major life activity. A person who can walk for 10 miles continuously is not substantially limited in walking merely because, on the eleventh mile, he or she begins to experience pain, because most people would not be able to walk eleven miles without experiencing some discomfort.

The Department received many comments on the proposed rule's inclusion of the word "temporary" in the definition of "disability." The preamble indicated that impairments are not necessarily excluded from the definition

of "disability" simply because they are temporary, but that the duration, or expected duration, of an impairment is one factor that may properly be considered in determining whether the impairment substantially limits a major life activity. The preamble recognized, however, that temporary impairments, such as a broken leg, are not commonly regarded as disabilities, and only in rare circumstances would the degree of the limitation and its expected duration be substantial: Nevertheless, many commenters objected to inclusion of the word "temporary" both because it is not in the statute and because it is not contained in the definition of "disability" set forth in the title I regulations of the Equal Employment Opportunity Commission (EEOC). The word "temporary" has been deleted from the final rule to conform with the statutory language. The question of whether a temporary impairment is a disability must be resolved on a case-by-case basis, taking into consideration both the duration (or expected duration) of the impairment and the extent to which it actually limits a major life activity of the affected individual.

The question of whether a person has a disability should be assessed without regard to the availability of mitigating measures, such as reasonable modifications or auxiliary aids and services. For example, a person with hearing loss is substantially limited in the major life activity of hearing, even though the loss may be improved through the use of a hearing aid. Likewise, persons with impairments, such as epilepsy or diabetes, that substantially limit a major life activity, are covered under the first prong of the definition of disability, even if the effects of the impairment are controlled by medication.

Many commenters asked that environmental illness (also known as multiple chemical sensitivity) as well as allergy to cigarette smoke be recognized as disabilities. The Department, however, declines to state categorically that these types of allergies or sensitivities are disabilities, because the determination as to whether an impairment is a disability depends on whether, given the particular circumstances at issue, the impairment substantially limits one or more major life activities (or has a history of, or is regarded as having such an effect).

Sometimes respiratory or neurological functioning is so severely affected that an individual will satisfy the requirements to be considered disabled under the regulation. Such an individual would be entitled to all of the protections afforded by the Act and this

part. In other cases, individuals may be sensitive to environmental elements or to smoke but their sensitivity will not rise to the level needed to constitute a disability. For example, their major life activity of breathing may be somewhat, but not substantially, impaired. In such circumstances, the individuals are not disabled and are not entitled to the protections of the statute despite their sensitivity to environmental agents.

In sum, the determination as to whether allergies to cigarette smoke, or allergies or sensitivities characterized by the commenters as environmental illness are disabilities covered by the regulation must be made using the same case-by-case analysis that is applied to all other physical or mental impairments. Moreover, the addition of specific regulatory provisions relating to environmental illness in the final rule would be inappropriate at this time pending future consideration of the issue by the Architectural and Transportation Barriers Compliance Board, the Environmental Protection Agency, and the Occupational Safety and Health Administration of the Department of Labor.

Test B—A Record of Such an Impairment

This test is intended to cover those who have a record of an impairment. As explained in paragraph (3) of the rule's definition of disability, this includes a person who has a history of an impairment that substantially limited a major life activity, such as someone who has recovered from an impairment. It also includes persons who have been misclassified as having an impairment.

This provision is included in the definition in part to protect individuals who have recovered from a physical or mental impairment that previously substantially limited them in a major life activity. Discrimination on the basis of such a past impairment is prohibited. Frequently occurring examples of the first group (those who have a history of an impairment) are persons with histories of mental or emotional illness, heart disease, or cancer; examples of the second group (those who have been misclassified as having an impairment) are persons who have been misclassified as having mental retardation or mental illness.

Test C—Being Regarded as Having Such an Impairment

This test, as contained in paragraph (4) of the definition, is intended to cover persons who are treated by a private entity or public accommodation as having a physical or mental impairment

that substantially limits a major life activity. It applies when a person is treated as if he or she has an impairment that substantially limits a major life activity, regardless of whether that person has an impairment.

The Americans with Disabilities Act uses the same "regarded as" test set forth in the regulations implementing section 504 of the Rehabilitation Act. See, e.g., 28 CFR 42.540(k)(2)(iv), which provides:

(iv) "Is regarded as having an impairment" means (A) Has a physical or mental impairment that does not substantially limit major life activities but that is treated by a recipient as constituting such a limitation; (B) Has a physical or mental impairment that substantially limits major life activities only as a result of the attitudes of others toward such impairment; or (C) Has none of the impairments defined in paragraph (k)(2)(i) of this section but is treated by a recipient as having such an impairment.

The perception of the private entity or public accommodation is a key element of this test. A person who perceives himself or herself to have an impairment, but does not have an impairment, and is not treated as if he or she has an impairment, is not protected under this test. A person would be covered under this test if a restaurant refused to serve that person because of a fear of "negative reactions" of others to that person. A person would also be covered if a public accommodation refused to serve a patron because it perceived that the patron had an impairment that limited his or her enjoyment of the goods or services being offered.

For example, persons with severe burns often encounter discrimination in community activities, resulting in substantial limitation of major life activities. These persons would be covered under this test based on the attitudes of others towards the impairment, even if they did not view themselves as "impaired."

The rationale for this third test, as used in the Rehabilitation Act of 1973, was articulated by the Supreme Court in *Arline*, 480 U.S. 273 (1987). The Court noted that, although an individual may have an impairment that does not in fact substantially limit a major life activity, the reaction of others may prove just as disabling. "Such an impairment might not diminish a person's physical or mental capabilities, but could nevertheless substantially limit that person's ability to work as a result of the negative reactions of others to the impairment." *Id.* at 283. The Court concluded that, by including this test in the Rehabilitation Act's definition, "Congress acknowledged that society's

accumulated myths and fears about disability and disease are as handicapping as are the physical limitations that flow from actual impairment." *Id.* at 284.

Thus, a person who is not allowed into a public accommodation because of the myths, fears, and stereotypes associated with disabilities would be covered under this third test whether or not the person's physical or mental condition would be considered a disability under the first or second test in the definition.

If a person is refused admittance on the basis of an actual or perceived physical or mental condition, and the public accommodation can articulate no legitimate reason for the refusal (such as failure to meet eligibility criteria), a perceived concern about admitting persons with disabilities could be inferred and the individual would qualify for coverage under the "regarded as" test. A person who is covered because of being regarded as having an impairment is not required to show that the public accommodation's perception is inaccurate (e.g., that he will be accepted by others, or that insurance rates will not increase) in order to be admitted to the public accommodation.

Paragraph (5) of the definition lists certain conditions that are not included within the definition of "disability." The excluded conditions are: transvestism, transsexualism, pedophilia, exhibitionism, voyeurism, gender identity disorders not resulting from physical impairments, other sexual behavior disorders, compulsive gambling, kleptomania, pyromania, and psychoactive substance use disorders resulting from current illegal use of drugs. Unlike homosexuality and bisexuality, which are not considered impairments under either the Americans with Disabilities Act (see the definition of "disability," paragraph (1)(iv) or section 504, the conditions listed in paragraph (5), except for transvestism, are not necessarily excluded as impairments under section 504. (Transvestism was excluded from the definition of disability for section 504 by the Fair Housing Amendments Act of 1988, Pub. L. 100-430, § 6(b).) The phrase "current illegal use of drugs" used in this definition is explained in the preamble to § 36.209.

"Drug." The definition of the term "drug" is taken from section 510(d)(2) of the ADA.

"Facility." "Facility" means all or any portion of buildings, structures, sites, complexes, equipment, rolling stock or other conveyances, roads, walks, passageways, parking lots, or other real or personal property, including the site

where the building, property, structure, or equipment is located. Committee reports made clear that the definition of facility was drawn from the definition of facility in current Federal regulations (see, e.g., Education and Labor report at 114). It includes both indoor and outdoor areas where human-constructed improvements, structures, equipment, or property have been added to the natural environment.

The term "rolling stock or other conveyances" was not included in the definition of facility in the proposed rule. However, commenters raised questions about the applicability of this part to places of public accommodation operated in mobile facilities (such as cruise ships, floating restaurants, or mobile health units). Those places of public accommodation are covered under this part, and would be included in the definition of "facility." Thus the requirements of subparts B and C would apply to those places of public accommodation. For example, a covered entity could not discriminate on the basis of disability in the full and equal enjoyment of the facilities (§ 36.201). Similarly, a cruise line could not apply eligibility criteria to potential passengers in a manner that would screen out individuals with disabilities, unless the criteria are "necessary," as provided in § 36.301.

However, standards for new construction and alterations of such facilities are not yet included in the Americans with Disabilities Act Accessibility Guidelines for Buildings and Facilities (ADAAG) adopted by § 36.406 and incorporated in Appendix A. The Department therefore will not interpret the new construction and alterations provisions of subpart D to apply to the types of facilities discussed here, pending further development of specific requirements.

Requirements pertaining to accessible transportation services provided by public accommodations are included in § 36.310 of this part; standards pertaining to accessible vehicles will be issued by the Secretary of Transportation pursuant to section 306 of the Act, and will be codified at 49 CFR part 37.

A public accommodation has obligations under this rule with respect to a cruise ship to the extent that its operations are subject to the laws of the United States.

The definition of "facility" only includes the site over which the private entity may exercise control or on which a place of public accommodation or a commercial facility is located. It does not include, for example, adjacent roads

or walks controlled by a public entity that is not subject to this part. Public entities are subject to the requirements of title II of the Act. The Department's regulation implementing title II, which will be codified at 28 CFR part 35, addresses the obligations of public entities to ensure accessibility by providing curb ramps at pedestrian walkways.

"Illegal use of drugs." The definition of "illegal use of drugs" is taken from section 510(d)(1) of the Act and clarifies that the term includes the illegal use of one or more drugs.

"Individual with a disability" means a person who has a disability but does not include an individual who is currently illegally using drugs, when the public accommodation acts on the basis of such use. The phrase "current illegal use of drugs" is explained in the preamble to § 36.209.

"Place of public accommodation." The term "place of public accommodation" is an adaptation of the statutory definition of "public accommodation" in section 301(7) of the ADA and appears as an element of the regulatory definition of public accommodation. The final rule defines "place of public accommodation" as a facility, operated by a private entity, whose operations affect commerce and fall within at least one of 12 specified categories. The term "public accommodation," on the other hand, is reserved by the final rule for the private entity that owns, leases (or leases to), or operates a place of public accommodation. It is the public accommodation, and not the place of public accommodation, that is subject to the regulation's nondiscrimination requirements. Placing the obligation not to discriminate on the public accommodation, as defined in the rule, is consistent with section 302(a) of the ADA, which places the obligation not to discriminate on any person who owns, leases (or leases to), or operates a place of public accommodation.

Facilities operated by government agencies or other public entities as defined in this section do not qualify as places of public accommodation. The actions of public entities are governed by title II of the ADA and will be subject to regulations issued by the Department of Justice under that title. The receipt of government assistance by a private entity does not by itself preclude a facility from being considered as a place of public accommodation.

The definition of place of public accommodation incorporates the 12 categories of facilities represented in the statutory definition of public accommodation in section 301(7) of the ADA:

1. Places of lodging.
2. Establishments serving food or drink.
3. Places of exhibition or entertainment.
4. Places of public gathering.
5. Sales or rental establishments.
6. Service establishments.
7. Stations used for specified public transportation.
8. Places of public display or collection.
9. Places of recreation.
10. Places of education.
11. Social service center establishments.
12. Places of exercise or recreation.

In order to be a place of public accommodation, a facility must be operated by a private entity, its operations must affect commerce, and it must fall within one of these 12 categories. While the list of categories is exhaustive, the representative examples of facilities within each category are not. Within each category only a few examples are given. The category of social service center establishments would include not only the types of establishments listed, day care centers, senior citizen centers, homeless shelters, food banks, adoption agencies, but also establishments such as substance abuse treatment centers, rape crisis centers, and halfway houses. As another example, the category of sales or rental establishments would include an innumerable array of facilities that would sweep far beyond the few examples given in the regulation. For example, other retail or wholesale establishments selling or renting items, such as bookstores, videotape rental stores, car rental establishment, pet stores, and jewelry stores would also be covered under this category, even though they are not specifically listed.

Several commenters requested clarification as to the coverage of wholesale establishments under the category of "sales or rental establishments." The Department intends for wholesale establishments to be covered under this category as places of public accommodation except in cases where they sell exclusively to other businesses and not to individuals. For example, a company that grows food produce and supplies its crops exclusively to food processing corporations on a wholesale basis does not become a public accommodation because of these transactions. If this company operates a road side stand where its crops are sold to the public, the road side stand would be a sales establishment covered by the ADA. Conversely, a sales establishment that markets its goods as "wholesale to the

public" and sells to individuals would not be exempt from ADA coverage despite its use of the word "wholesale" as a marketing technique.

Of course, a company that operates a place of public accommodation is subject to this part only in the operation of that place of public accommodation. In the example given above, the wholesale produce company that operates a road side stand would be a public accommodation only for the purposes of the operation of that stand. The company would be prohibited from discriminating on the basis of disability in the operation of the road side stand, and it would be required to remove barriers to physical access to the extent that it is readily achievable to do so (see § 36.304); however, in the event that it is not readily achievable to remove barriers, for example, by replacing a gravel surface or regrading the area around the stand to permit access by persons with mobility impairments, the company could meet its obligations through alternative methods of making its goods available, such as delivering produce to a customer in his or her car (see § 36.305). The concepts of readily achievable barrier removal and alternatives to barrier removal are discussed further in the preamble discussion of §§ 36.304 and 36.305.

Even if a facility does not fall within one of the 12 categories, and therefore does not qualify as a place of public accommodation, it still may be a commercial facility as defined in § 36.104 and be subject to the new construction and alterations requirements of subpart D.

A number of commenters questioned the treatment of residential hotels and other residential facilities in the Department's proposed rule. These commenters were essentially seeking resolution of the relationship between the Fair Housing Act and the ADA concerning facilities that are both residential in nature and engage in activities that would cause them to be classified as "places of public accommodation" under the ADA. The ADA's express exemption relating to the Fair Housing Act applies only to "commercial facilities" and not to "places of public accommodation."

A facility whose operations affect interstate commerce is a place of public accommodation for purposes of the ADA to the extent that its operations include those types of activities engaged in or services provided by the facilities contained on the list of 12 categories in section 301(7) of the ADA. Thus, a facility that provides social services would be considered a "social service

center establishment." Similarly, the category "places of lodging" would exclude solely residential facilities because the nature of a place of lodging contemplates the use of the facility for short-term stays.

Many facilities, however, are mixed use facilities. For example, in a large hotel that has a separate residential apartment wing, the residential wing would not be covered by the ADA because of the nature of the occupancy of that part of the facility. This residential wing would, however, be covered by the Fair Housing Act. The separate nonresidential accommodations in the rest of the hotel would be a place of lodging, and thus a public accommodation subject to the requirements of this final rule. If a hotel allows both residential and short-term stays, but does not allocate space for these different uses in separate, discrete units, both the ADA and the Fair Housing Act may apply to the facility. Such determinations will need to be made on a case-by-case basis. Any place of lodging of the type described in paragraph (1) of the definition of place of public accommodation and that is an establishment located within a building that contains not more than five rooms for rent or hire and is actually occupied by the proprietor of the establishment as his or her residence is not covered by the ADA. (This exclusion from coverage does not apply to other categories of public accommodations, for example, professional offices or homeless shelters, that are located in a building that is also occupied as a private residence.)

A number of commenters noted that the term "residential hotel" may also apply to a type of hotel commonly known as a "single room occupancy hotel." Although such hotels or portions of such hotels may fall under the Fair Housing Act when operated or used as long-term residences, they are also considered "places of lodging" under the ADA when guests of such hotels are free to use them on a short-term basis. In addition, "single room occupancy hotels" may provide social services to their guests, often through the operation of Federal or State grant programs. In such a situation, the facility would be considered a "social service center establishment" and thus covered by the ADA as a place of public accommodation, regardless of the length of stay of the occupants.

A similar analysis would also be applied to other residential facilities that provide social services, including homeless shelters, shelters for people seeking refuge from domestic violence,

nursing homes, residential care facilities, and other facilities where persons may reside for varying lengths of time. Such facilities should be analyzed under the Fair Housing Act to determine the application of that statute. The ADA, however, requires a separate and independent analysis. For example, if the facility, or a portion of the facility, is intended for or permits short-term stays, or if it can appropriately be categorized as a service establishment or as a social service establishment, then the facility or that portion of the facility used for the covered purpose is a place of public accommodation under the ADA. For example, a homeless shelter that is intended and used only for long-term residential stays and that does not provide social services to its residents would not be covered as a place of public accommodation. However, if this facility permitted short-term stays or provided social services to its residents, it would be covered under the ADA either as a "place of lodging" or as a "social service center establishment," or as both.

A private home, by itself, does not fall within any of the 12 categories. However, it can be covered as a place of public accommodation to the extent that it is used as a facility that would fall within one of the 12 categories. For example, if a professional office of a dentist, doctor, or psychologist is located in a private home, the portion of the home dedicated to office use (including areas used both for the residence and the office, e.g., the entrance to the home that is also used as the entrance to the professional office) would be considered a place of public accommodation. Places of public accommodation located in residential facilities are specifically addressed in § 36.207.

If a tour of a commercial facility that is not otherwise a place of public accommodation, such as, for example, a factory or a movie studio production set, is open to the general public, the route followed by the tour is a place of public accommodation and the tour must be operated in accordance with the rule's requirements for public accommodations. The place of public accommodation defined by the tour does not include those portions of the commercial facility that are merely viewed from the tour route. Hence, the barrier removal requirements of § 36.304 only apply to the physical route followed by the tour participants and not to work stations or other areas that are merely adjacent to, or within view of, the tour route. If the tour is not open to the general public, but rather is

conducted, for example, for selected business colleagues, partners, customers, or consultants, the tour route is not a place of public accommodation and the tour is not subject to the requirements for public accommodations.

Public accommodations that receive Federal financial assistance are subject to the requirements of section 504 of the Rehabilitation Act as well as the requirements of the ADA.

Private schools, including elementary and secondary schools, are covered by the rule as places of public accommodation. The rule itself, however, does not require a private school to provide a free appropriate education or develop an individualized education program in accordance with regulations of the Department of Education implementing section 504 of the Rehabilitation Act of 1973, as amended (34 CFR part 104), and regulations implementing the Individuals with Disabilities Education Act (34 CFR part 300). The receipt of Federal assistance by a private school, however, would trigger application of the Department of Education's regulations to the extent mandated by the particular type of assistance received.

"Private club." The term "private club" is defined in accordance with section 307 of the ADA as a private club or establishment exempted from coverage under title II of the Civil Rights Act of 1964. Title II of the 1964 Act exempts any "private club or other establishment not in fact open to the public, except to the extent that the facilities of such establishment are made available to the customers or patrons of [a place of public accommodation as defined in title II]." The rule, therefore, as reflected in § 36.102(e) of the application section, limits the coverage of private clubs accordingly. The obligations of a private club that rents space to any other private entity for the operation of a place of public accommodation are discussed further in connection with § 36.201.

In determining whether a private entity qualifies as a private club under title II, courts have considered such factors as the degree of member control of club operations, the selectivity of the membership selection process, whether substantial membership fees are charged, whether the entity is operated on a nonprofit basis, the extent to which the facilities are open to the public, the degree of public funding, and whether the club was created specifically to avoid compliance with the Civil Rights

Act. See *e.g.*, *Tillman v. Wheaton-Haven Recreation Ass'n*, 410 U.S. 431 (1973); *Daniel v. Paul*, 395 U.S. 298 (1969); *Olzman v. Lake Hills Swim Club, Inc.*, 495 F.2d 1333 (2d Cir. 1974); *Anderson v. Pass Christian Isles Golf Club, Inc.*, 488 F.2d 855 (5th Cir. 1974); *Smith v. YMCA*, 462 F.2d 634 (5th Cir. 1972); *Stout v. YMCA*, 404 F.2d 687 (5th Cir. 1968); *United States v. Richberg*, 398 F.2d 523 (5th Cir. 1968); *Nesmith v. YMCA*, 397 F.2d 96 (4th Cir. 1968); *United States v. Lansdowne Swim Club*, 713 F. Supp. 785 (E.D. Pa. 1989); *Durham v. Red Lake Fishing and Hunting Club, Inc.*, 666 F. Supp. 954 (W.D. Tex. 1987); *New York v. Ocean Club, Inc.*, 602 F. Supp. 489 (E.D.N.Y. 1984); *Brown v. Loudoun Golf and Country Club, Inc.*, 573 F. Supp. 399 (E.D. Va. 1983); *United States v. Trustees of Fraternal Order of Eagles*, 472 F. Supp. 1174 (E.D. Wis. 1979); *Cornelius v. Benevolent Protective Order of Elks*, 382 F. Supp. 1182 (D. Conn. 1974).

"Private entity." The term "private entity" is defined as any individual or entity other than a public entity. It is used as part of the definition of "public accommodation" in this section.

The definition adds "individual" to the statutory definition of private entity (see section 301(6) of the ADA). This addition clarifies that an individual may be a private entity and, therefore, may be considered a public accommodation if he or she owns, leases (or leases to), or operates a place of public accommodation. The explicit inclusion of individuals under the definition of private entity is consistent with section 302(a) of the ADA, which broadly prohibits discrimination on the basis of disability by any person who owns, leases (or leases to), or operates a place of public accommodation.

"Public accommodation." The term "public accommodation" means a private entity that owns, leases (or leases to), or operates a place of public accommodation. The regulatory term, "public accommodation," corresponds to the statutory term, "person," in section 302(a) of the ADA. The ADA prohibits discrimination "by any person who owns, leases (or leases to), or operates a place of public accommodation." The text of the regulation consequently places the ADA's nondiscrimination obligations on "public accommodations" rather than on "persons" or on "places of public accommodation."

As stated in § 36.102(b)(2), the requirements of subparts B and C obligate a public accommodation only with respect to the operations of a place of public accommodation. A public accommodation must also meet the

requirements of subpart D with respect to facilities used as, or designed or constructed for use as, places of public accommodation or commercial facilities.

"Public entity." The term "public entity" is defined in accordance with section 201(1) of the ADA as any State or local government; any department, agency, special purpose district, or other instrumentality of a State or States or local government; and the National Railroad Passenger Corporation, and any commuter authority (as defined in section 103(8) of the Rail Passenger Service Act). It is used in the definition of "private entity" in § 36.104. Public entities are excluded from the definition of private entity and therefore cannot qualify as public accommodations under this regulation. However, the actions of public entities are covered by title II of the ADA and by the Department's title II regulations codified at 28 CFR part 35.

"Qualified interpreter." The Department received substantial comment regarding the lack of a definition of "qualified interpreter." The proposed rule defined auxiliary aids and services to include the statutory term, "qualified interpreters" (§ 36.303(b)), but did not define that term. Section 36.303 requires the use of a qualified interpreter where necessary to achieve effective communication, unless an undue burden or fundamental alteration would result. Commenters stated that a lack of guidance on what the term means would create confusion among those trying to secure interpreting services and often result in less than effective communication.

Many commenters were concerned that, without clear guidance on the issue of "qualified" interpreter, the rule would be interpreted to mean "available, rather than qualified" interpreters. Some claimed that few public accommodations would understand the difference between a qualified interpreter and a person who simply knows a few signs or how to fingerspell.

In order to clarify what is meant by "qualified interpreter" the Department has added a definition of the term to the final rule. A qualified interpreter means an interpreter who is able to interpret effectively, accurately, and impartially both receptively and expressively, using any necessary specialized vocabulary. This definition focuses on the actual ability of the interpreter in a particular interpreting context to facilitate effective communication between the public accommodation and the individual with disabilities.

Public comment also revealed that public accommodations have at times asked persons who are deaf to provide family members or friends to interpret.

In certain circumstances, notwithstanding that the family member or friend is able to interpret or is a certified interpreter, the family member or friend may not be qualified to render the necessary interpretation because of factors such as emotional or personal involvement or considerations of confidentiality that may adversely affect the ability to interpret "effectively, accurately, and impartially."

"Readily achievable." The definition of "readily achievable" follows the statutory definition of that term in section 301(9) of the ADA. Readily achievable means easily accomplishable and able to be carried out without much difficulty or expense. The term is used as a limitation on the obligation to remove barriers under §§ 36.304(a), 36.305(a), 36.308(a), and 36.310(b). Further discussion of the meaning and application of the term "readily achievable" may be found in the preamble section for § 36.304.

The definition lists factors to be considered in determining whether barrier removal is readily achievable in any particular circumstance. A significant number of commenters objected to § 36.306 of the proposed rule, which listed identical factors to be considered for determining "readily achievable" and "undue burden" together in one section. They asserted that providing a consolidated section blurred the distinction between the level of effort required by a public accommodation under the two standards. The readily achievable standard is a "lower" standard than the "undue burden" standard in terms of the level of effort required, but the factors used in determining whether an action is readily achievable or would result in an undue burden are identical (See Education and Labor report at 109). Although the preamble to the proposed rule clearly delineated the relationship between the two standards, to eliminate any confusion the Department has deleted § 36.306 of the proposed rule. That section, in any event, as other commenters noted, had merely repeated the lists of factors contained in the definitions of readily achievable and undue burden.

The list of factors included in the definition is derived from section 301(9) of the ADA. It reflects the congressional intention that a wide range of factors be considered in determining whether an action is readily achievable. It also takes into account that many local facilities are owned or operated by parent corporations or entities that conduct operations at many different sites. This section makes clear that, in

some instances, resources beyond those of the local facility where the barrier must be removed may be relevant in determining whether an action is readily achievable. One must also evaluate the degree to which any parent entity has resources that may be allocated to the local facility.

The statutory list of factors in section 301(9) of the Act uses the term "covered entity" to refer to the larger entity of which a particular facility may be a part. "Covered entity" is not a defined term in the ADA and is not used consistently throughout the Act. The definition, therefore, substitutes the term "parent entity" in place of "covered entity" in paragraphs (3), (4), and (5) when referring to the larger private entity whose overall resources may be taken into account. This usage is consistent with the House Judiciary Committee's use of the term "parent company" to describe the larger entity of which the local facility is a part (H.R. Rep. No. 485, 101st Cong., 2d Sess., pt. 3, at 40-41, 54-55 (1990) (hereinafter "Judiciary report"))).

A number of commenters asked for more specific guidance as to when and how the resources of a parent corporation or entity are to be taken into account in determining what is readily achievable. The Department believes that this complex issue is most appropriately resolved on a case-by-case basis. As the comments reflect, there is a wide variety of possible relationships between the site in question and any parent corporation or other entity. It would be unwise to posit legal ramifications under the ADA of even generic relationships (e.g., banks involved in foreclosures or insurance companies operating as trustees or in other similar fiduciary relationships), because any analysis will depend so completely on the detailed fact situations and the exact nature of the legal relationships involved. The final rule does, however, reorder the factors to be considered. This shift and the addition of the phrase "if applicable" make clear that the line of inquiry concerning factors will start at the site involved in the action itself. This change emphasizes that the overall resources, size, and operations of the parent corporation or entity should be considered to the extent appropriate in light of "the geographic separateness, and the administrative or fiscal relationship of the site or sites in question to any parent corporation or entity."

Although some commenters sought more specific numerical guidance on the definition of readily achievable, the

Department has declined to establish in the final rule any kind of numerical formula for determining whether an action is readily achievable. It would be difficult to devise a specific ceiling on compliance costs that would take into account the vast diversity of enterprises covered by the ADA's public accommodations requirements and the economic situation that any particular entity would find itself in at any moment. The final rule, therefore, implements the flexible case-by-case approach chosen by Congress.

A number of commenters requested that security considerations be explicitly recognized as a factor in determining whether a barrier removal action is readily achievable. The Department believes that legitimate safety requirements, including crime prevention measures, may be taken into account so long as they are based on actual risks and are necessary for safe operation of the public accommodation. This point has been included in the definition.

Some commenters urged the Department not to consider acts of barrier removal in complete isolation from each other in determining whether they are readily achievable. The Department believes that it is appropriate to consider the cost of other barrier removal actions as one factor in determining whether a measure is readily achievable.

"Religious entity." The term "religious entity" is defined in accordance with section 307 of the ADA as a religious organization or entity controlled by a religious organization, including a place of worship. Section 36.102(e) of the rule states that the rule does not apply to any religious entity.

The ADA's exemption of religious organizations and religious entities controlled by religious organizations is very broad, encompassing a wide variety of situations. Religious organizations and entities controlled by religious organizations have no obligations under the ADA. Even when a religious organization carries out activities that would otherwise make it a public accommodation, the religious organization is exempt from ADA coverage. Thus, if a church itself operates a day care center, a nursing home, a private school, or a diocesan school system, the operations of the center, home, school, or schools would not be subject to the requirements of the ADA or this part. The religious entity would not lose its exemption merely because the services provided were open to the general public. The test is whether the church or other religious

organization operates the public accommodation, not which individuals receive the public accommodation's services.

Religious entities that are controlled by religious organizations are also exempt from the ADA's requirements. Many religious organizations in the United States use lay boards and other secular or corporate mechanisms to operate schools and an array of social services. The use of a lay board or other mechanism does not itself remove the ADA's religious exemption. Thus, a parochial school, having religious doctrine in its curriculum and sponsored by a religious order, could be exempt either as a religious organization or as an entity controlled by a religious organization, even if it has a lay board. The test remains a factual one—whether the church or other religious organization controls the operations of the school or of the service or whether the school or service is itself a religious organization.

Although a religious organization or a religious entity that is controlled by a religious organization has no obligations under the rule, a public accommodation that is not itself a religious organization, but that operates a place of public accommodation in leased space on the property of a religious entity, which is not a place of worship, is subject to the rule's requirements if it is not under control of a religious organization. When a church rents meeting space, which is not a place of worship, to a local community group or to a private, independent day care center, the ADA applies to the activities of the local community group and day care center if a lease exists and consideration is paid.

"Service animal." The term "service animal" encompasses any guide dog, signal dog, or other animal individually trained to provide assistance to an individual with a disability. The term is used in § 36.302(c), which requires public accommodations generally to modify policies, practices, and procedures to accommodate the use of service animals in places of public accommodation.

"Specified public transportation." The definition of "specified public transportation" is identical to the statutory definition in section 301(10) of the ADA. The term means transportation by bus, rail, or any other conveyance (other than by aircraft) that provides the general public with general or special service (including charter service) on a regular and continuing basis. It is used in category (7) of the definition of "place of public accommodation," which includes

stations used for specified public transportation.

The effect of this definition, which excludes transportation by aircraft, is that it excludes privately operated airports from coverage as places of public accommodation. However, places of public accommodation located within airports would be covered by this part. Airports that are operated by public entities are covered by title II of the ADA and, if they are operated as part of a program receiving Federal financial assistance, by section 504 of the Rehabilitation Act. Privately operated airports are similarly covered by section 504 if they are operated as part of a program receiving Federal financial assistance. The operations of any portion of any airport that are under the control of an air carrier are covered by the Air Carrier Access Act. In addition, airports are covered as commercial facilities under this rule.

"State." The definition of "State" is identical to the statutory definition in section 3(3) of the ADA. The term is used in the definitions of "commerce" and "public entity" in § 36.104.

"Undue burden." The definition of "undue burden" is analogous to the statutory definition of "undue hardship" in employment under section 101(10) of the ADA. The term undue burden means "significant difficulty or expense" and serves as a limitation on the obligation to provide auxiliary aids and services under § 36.303 and §§ 36.309 (b)(3) and (c)(3). Further discussion of the meaning and application of the term undue burden may be found in the preamble discussion of § 36.303.

The definition lists factors considered in determining whether provision of an auxiliary aid or service in any particular circumstance would result in an undue burden. The factors to be considered in determining whether an action would result in an undue burden are identical to those to be considered in determining whether an action is readily achievable. However, "readily achievable" is a lower standard than "undue burden" in that it requires a lower level of effort on the part of the public accommodation (see Education and Labor report at 109).

Further analysis of the factors to be considered in determining undue burden may be found in the preamble discussion of the definition of the term "readily achievable."

Subpart B—General Requirements

Subpart B includes general prohibitions restricting a public accommodation from discriminating against people with disabilities by denying them the opportunity to benefit from goods or services, by giving them

unequal goods or services, or by giving them different or separate goods or services. These general prohibitions are patterned after the basic, general prohibitions that exist in other civil rights laws that prohibit discrimination on the basis of race, sex, color, religion, or national origin.

Section 36.201 General

Section 36.201(a) contains the general rule that prohibits discrimination on the basis of disability in the full and equal enjoyment of goods, services, facilities, privileges, advantages, and accommodations of any place of public accommodation.

Full and equal enjoyment means the right to participate and to have an equal opportunity to obtain the same results as others to the extent possible with such accommodations as may be required by the Act and these regulations. It does not mean that an individual with a disability must achieve an identical result or level of achievement as persons without a disability. For example, an exercise class cannot exclude a person who uses a wheelchair because he or she cannot do all of the exercises and derive the same result from the class as persons without a disability.

Section 302(a) of the ADA states that the prohibition against discrimination applies to "any person who owns, leases (or leases to), or operates a place of public accommodation," and this language is reflected in § 36.201(a). The coverage is quite extensive and would include sublessees, management companies, and any other entity that owns, leases, leases to, or operates a place of public accommodation, even if the operation is only for a short time.

The first sentence of paragraph (b) of § 36.201 reiterates the general principle that both the landlord that owns the building that houses the place of public accommodation, as well as the tenant that owns or operates the place of public accommodation, are public accommodations subject to the requirements of this part. Although the statutory language could be interpreted as placing equal responsibility on all private entities, whether lessor, lessee, or operator of a public accommodation, the committee reports suggest that liability may be allocated. Section 36.201(b) of that section of the proposed rule attempted to allocate liability in the regulation itself. Paragraph (b)(2) of that section made a specific allocation of liability for the obligation to take readily achievable measures to remove barriers, and paragraph (b)(3) made a specific allocation for the obligation to provide auxiliary aids.

Numerous commenters pointed out that these allocations would not apply in all situations. Some asserted that paragraph (b)(2) of the proposed rule only addressed the situation when a lease gave the tenant the right to make alterations with permission of the landlord, but failed to address other types of leases, e.g., those that are silent on the right to make alterations, or those in which the landlord is not permitted to enter a tenant's premises to make alterations. Several commenters noted that many leases contain other clauses more relevant to the ADA than the alterations clause. For example, many leases contain a "compliance clause," a clause which allocates responsibility to a particular party for compliance with all relevant Federal, State, and local laws. Many commenters pointed out various types of relationships that were left unaddressed by the regulation, e.g., sale and leaseback arrangements where the landlord is a financial institution with no control or responsibility for the building; franchises; subleases; and management companies which, at least in the hotel industry, often have control over operations but are unable to make modifications to the premises.

Some commenters raised specific questions as to how the barrier removal allocation would work as a practical matter. Paragraph (b)(2) of the proposed rule provided that the burden of making readily achievable modifications within the tenant's place of public accommodation would shift to the landlord when the modifications were not readily achievable for the tenant or when the landlord denied a tenant's request for permission to make such modifications. Commenters noted that the rule did not specify exactly when the burden would actually shift from tenant to landlord and whether the landlord would have to accept a tenant's word that a particular action is not readily achievable. Others questioned if the tenant should be obligated to use alternative methods of barrier removal before the burden shifts. In light of the fact that readily achievable removal of barriers can include such actions as moving of racks and displays, some commenters doubted the appropriateness of requiring a landlord to become involved in day-to-day operations of its tenants' businesses.

The Department received widely differing comments in response to the preamble question asking whether landlord and tenant obligations should vary depending on the length of time remaining on an existing lease. Many suggested that tenants should have no responsibilities in "shorter leases,"

which commenters defined as ranging anywhere from 90 days to three years. Other commenters pointed out that the time remaining on the lease should not be a factor in the rule's allocation of responsibilities, but is relevant in determining what is readily achievable for the tenant. The Department agrees with this latter approach and will interpret the rule in that manner.

In recognition of the somewhat limited applicability of the allocation scheme contained in the proposed rule, paragraphs (b)(2) and (b)(3) have been deleted from the final rule. The Department has substituted instead a statement that allocation of responsibility as between the parties for taking readily achievable measures to remove barriers and to provide auxiliary aids and services both in common areas and within places of public accommodation may be determined by the lease or other contractual relationships between the parties. The ADA was not intended to change existing landlord/tenant responsibilities as set forth in the lease. By deleting specific provisions from the rule, the Department gives full recognition to this principle. As between the landlord and tenant, the extent of responsibility for particular obligations may be, and in many cases probably will be, determined by contract.

The suggested allocation of responsibilities contained in the proposed rule may be used if appropriate in a particular situation. Thus, the landlord would generally be held responsible for making readily achievable changes and providing auxiliary aids and services in common areas and for modifying policies, practices, or procedures applicable to all tenants, and the tenant would generally be responsible for readily achievable changes, provision of auxiliary aids, and modification of policies within its own place of public accommodation.

Many commenters objected to the proposed rule's allocation of responsibility for providing auxiliary aids and services solely to the tenant, pointing out that this exclusive allocation may not be appropriate in the case of larger public accommodations that operate their businesses by renting space out to smaller public accommodations. For example, large theaters often rent to smaller traveling companies and hospitals often rely on independent contractors to provide childbirth classes. Groups representing persons with disabilities objected to the proposed rule because, in their view, it permitted the large theater or hospital to evade ADA responsibilities by leasing

to independent smaller entities. They suggested that these types of public accommodations are not really landlords because they are in the business of providing a service, rather than renting space, as in the case of a shopping center or office building landlord. These commenters believed that responsibility for providing auxiliary aids should shift to the landlord, if the landlord relies on a smaller public accommodation or independent contractor to provide services closely related to those of the larger public accommodation, and if the needed auxiliary aids prove to be an undue burden for the smaller public accommodation. The final rule no longer lists specific allocations to specific parties but, rather, leaves allocation of responsibilities to the lease negotiations. Parties are, therefore, free to allocate the responsibility for auxiliary aids.

Section 36.201(b)(4) of the proposed rule, which provided that alterations by a tenant on its own premises do not trigger a path of travel obligation on the landlord, has been moved to § 36.403(d) of the final rule.

An entity that is not in and of itself a public accommodation, such as a trade association or performing artist, may become a public accommodation when it leases space for a conference or performance at a hotel, convention center, or stadium. For an entity to become a public accommodation when it is the lessee of space, however, the Department believes that consideration in some form must be given. Thus, a Boy Scout troop that accepts donated space does not become a public accommodation because the troop has not "leased" space, as required by the ADA.

As a public accommodation, the trade association or performing artist will be responsible for compliance with this part. Specific responsibilities should be allocated by contract, but, generally, the lessee should be responsible for providing auxiliary aids and services (which could include interpreters, Braille programs, etc.) for the participants in its conference or performance as well as for assuring that displays are accessible to individuals with disabilities.

Some commenters suggested that the rule should allocate responsibilities for areas other than removal of barriers and auxiliary aids. The final rule leaves allocation of all areas to the lease negotiations. However, in general landlords should not be given responsibility for policies a tenant applies in operating its business, if such policies are solely those of the tenant. Thus, if a restaurant tenant

discriminates by refusing to seat a patron, it would be the tenant, and not the landlord, who would be responsible, because the discriminatory policy is imposed solely by the tenant and not by the landlord. If, however, a tenant refuses to modify a "no pets" rule to allow service animals in its restaurant because the landlord mandates such a rule, then both the landlord and the tenant would be liable for violation of the ADA when a person with a service dog is refused entrance. The Department wishes to emphasize, however, that the parties are free to allocate responsibilities in any way they choose.

Private clubs are also exempt from the ADA. However, consistent with title II of the Civil Rights Act (42 U.S.C. 2000a(e)), a private club is considered a public accommodation to the extent that "the facilities of such establishment are made available to the customers or patrons" of a place of public accommodation. Thus, if a private club runs a day care center that is open exclusively to its own members, the club, like the church in the example above, would have no responsibility for compliance with the ADA. Nor would the day care center have any responsibilities because it is part of the private club exempt from the ADA.

On the other hand, if the private club rents to a day care center that is open to the public, then the private club would have the same obligations as any other public accommodation that functions as a landlord with respect to compliance with title III within the day care center. In such a situation, both the private club that "leases to" a public accommodation and the public accommodation lessee (the day care center) would be subject to the ADA. This same principle would apply if the private club were to rent to, for example, a bar association, which is not generally a public accommodation but which, as explained above, becomes a public accommodation when it leases space for a conference.

Section 36.202 Activities

Section 36.202 sets out the general forms of discrimination prohibited by title III of the ADA. These general prohibitions are further refined by the specific prohibitions in subpart C. Section 36.213 makes clear that the limitations on the ADA's requirements contained in subpart C, such as "necessity" (§ 36.301(a)) and "safety" (§ 36.301(b)), are applicable to the prohibitions in § 36.202. Thus, it is unnecessary to add these limitations to § 36.202 as has been requested by some commenters. In addition, the language of § 36.202 very closely tracks the language

of section 302(b)(1)(A) of the Act, and that statutory provision does not expressly contain these limitations.

Deny participation—Section 36.202(a) provides that it is discriminatory to deny a person with a disability the right to participate in or benefit from the goods, services, facilities, privileges, advantages, or accommodations of a place of public accommodation.

A public accommodation may not exclude persons with disabilities on the basis of disability for reasons other than those specifically set forth in this part. For example, a public accommodation cannot refuse to serve a person with a disability because its insurance company conditions coverage or rates on the absence of persons with disabilities. This is a frequent basis of exclusion from a variety of community activities and is prohibited by this part.

Unequal benefit—Section 36.202(b) prohibits services or accommodations that are not equal to those provided others. For example, persons with disabilities must not be limited to certain performances at a theater.

Separate benefit—Section 36.202(c) permits different or separate benefits or services only when necessary to provide persons with disabilities opportunities as effective as those provided others. This paragraph permitting separate benefits "when necessary" should be read together with § 36.203(a), which requires integration in "the most integrated setting appropriate to the needs of the individual." The preamble to that section provides further guidance on separate programs. Thus, this section would not prohibit the designation of parking spaces for persons with disabilities.

Each of the three paragraphs (a)–(c) prohibits discrimination against an individual or class of individuals "either directly or through contractual, licensing, or other arrangements." The intent of the contractual prohibitions of these paragraphs is to prohibit a public accommodation from doing indirectly, through a contractual relationship, what it may not do directly. Thus, the "individual or class of individuals" referenced in the three paragraphs is intended to refer to the clients and customers of the public accommodation that entered into a contractual arrangement. It is not intended to encompass the clients or customers of other entities. A public accommodation, therefore, is not liable under this provision for discrimination that may be practiced by those with whom it has a contractual relationship, when that discrimination is not directed against its own clients or customers. For example, if an amusement park contracts with a

food service company to operate its restaurants at the park, the amusement park is not responsible for other operations of the food service company that do not involve clients or customers of the amusement park. Section 36.202(d) makes this clear by providing that the term "individual or class of individuals" refers to the clients or customers of the public accommodation that enters into the contractual, licensing, or other arrangement.

Section 36.203 Integrated Settings

Section 36.203 addresses the integration of persons with disabilities. The ADA recognizes that the provision of goods and services in an integrated manner is a fundamental tenet of nondiscrimination on the basis of disability. Providing segregated accommodations and services relegates persons with disabilities to the status of second-class citizens. For example, it would be a violation of this provision to require persons with mental disabilities to eat in the back room of a restaurant or to refuse to allow a person with a disability the full use of a health spa because of stereotypes about the person's ability to participate. Section 36.203(a) states that a public accommodation shall afford goods, services, facilities, privileges, advantages, and accommodations to an individual with a disability in the most integrated setting appropriate to the needs of the individual. Section 36.203(b) specifies that, notwithstanding the existence of separate or different programs or activities provided in accordance with this section, an individual with a disability shall not be denied the opportunity to participate in such programs or activities that are not separate or different. Section 306.203(c), which is derived from section 501(d) of the Americans with Disabilities Act, states that nothing in this part shall be construed to require an individual with a disability to accept an accommodation, aid, service, opportunity, or benefit that he or she chooses not to accept.

Taken together, these provisions are intended to prohibit exclusion and segregation of individuals with disabilities and the denial of equal opportunities enjoyed by others, based on, among other things, presumptions, patronizing attitudes, fears, and stereotypes about individuals with disabilities. Consistent with these standards, public accommodations are required to make decisions based on facts applicable to individuals and not on the basis of presumptions as to what a class of individuals with disabilities can or cannot do.

Sections 36.203 (b) and (c) make clear that individuals with disabilities cannot be denied the opportunity to participate in programs that are not separate or different. This is an important and overarching principle of the Americans with Disabilities Act. Separate, special, or different programs that are designed to provide a benefit to persons with disabilities cannot be used to restrict the participation of persons with disabilities in general, integrated activities.

For example, a person who is blind may wish to decline participating in a special museum tour that allows persons to touch sculptures in an exhibit and instead tour the exhibit at his or her own pace with the museum's recorded tour. It is not the intent of this section to require the person who is blind to avail himself or herself of the special tour. Modified participation for persons with disabilities must be a choice, not a requirement.

Further, it would not be a violation of this section for an establishment to offer recreational programs specially designed for children with mobility impairments in those limited circumstances. However, it would be a violation of this section if the entity then excluded these children from other recreational services made available to nondisabled children, or required children with disabilities to attend only designated programs.

Many commenters asked that the Department clarify a public accommodation's obligations within the integrated program when it offers a separate program, but an individual with a disability chooses not to participate in the separate program. It is impossible to make a blanket statement as to what level of auxiliary aids or modifications are required in the integrated program. Rather, each situation must be assessed individually. Assuming the integrated program would be appropriate for a particular individual, the extent to which that individual must be provided with modifications will depend not only on what the individual needs but also on the limitations set forth in subpart C. For example, it may constitute an undue burden for a particular public accommodation, which provides a full-time interpreter in its special guided tour for individuals with hearing impairments, to hire an additional interpreter for those individuals who choose to attend the integrated program. The Department cannot identify categorically the level of assistance or aid required in the integrated program.

The preamble to the proposed rule contained a statement that some

interpreted as encouraging the continuation of separate schools, sheltered workshops, special recreational programs, and other similar programs. It is important to emphasize that § 36.202(c) only calls for separate programs when such programs are "necessary" to provide as effective an opportunity to individuals with disabilities as to other individuals. Likewise, § 36.203(a) only permits separate programs when a more integrated setting would not be "appropriate." Separate programs are permitted, then, in only limited circumstances. The sentence at issue has been deleted from the preamble because it was too broadly stated and had been erroneously interpreted as Departmental encouragement of separate programs without qualification.

The proposed rule's reference in § 36.203(b) to separate programs or activities provided in accordance with "this section" has been changed to "this subpart" in recognition of the fact that separate programs or activities may, in some limited circumstances, be permitted not only by § 36.203(a) but also by § 36.202(c).

In addition, some commenters suggested that the individual with the disability is the only one who can decide whether a setting is "appropriate" and what the "needs" are. Others suggested that only the public accommodation can make these determinations. The regulation does not give exclusive responsibility to either party. Rather, the determinations are to be made based on an objective view, presumably one which would take into account views of both parties.

Some commenters expressed concern that § 36.203(c), which states that nothing in the rule requires an individual with a disability to accept special accommodations and services provided under the ADA, could be interpreted to allow guardians of infants or older people with disabilities to refuse medical treatment for their wards. Section 36.203(c) has been revised to make it clear that paragraph (c) is inapplicable to the concern of the commenters. A new paragraph (c)(2) has been added stating that nothing in the regulation authorizes the representative or guardian of an individual with a disability to decline food, water, medical treatment, or medical services for that individual. New paragraph (c) clarifies that neither the ADA nor the regulation alters current Federal law ensuring the rights of incompetent individuals with disabilities to receive food, water, and medical treatment. See, e.g., Child Abuse Amendments of 1984

(42 U.S.C. 5106a(b)(10), 5106g(10)); Rehabilitation Act of 1973, as amended (29 U.S.C. 794); Developmentally Disabled Assistance and Bill of Rights Act (42 U.S.C. 6042).

Sections 36.203(c) (1) and (2) are based on section 501(d) of the ADA. Section § 501(d) was designed to clarify that nothing in the ADA requires individuals with disabilities to accept special accommodations and services for individuals with disabilities that may segregate them:

The Committee added this section (501(d)) to clarify that nothing in the ADA is intended to permit discriminatory treatment on the basis of disability, even when such treatment is rendered under the guise of providing an accommodation, service, aid or benefit to the individual with disability. For example, a blind individual may choose not to avail himself or herself of the right to go to the front of a line, even if a particular public accommodation has chosen to offer such a modification of a policy for blind individuals. Or, a blind individual may choose to decline to participate in a special museum tour that allows persons to touch sculptures in an exhibit and instead tour the exhibits at his or her own pace with the museum's recorded tour.

(Judiciary report at 71-72.) The Act is not to be construed to mean that an individual with disabilities must accept special accommodations and services for individuals with disabilities when that individual chooses to participate in the regular services already offered. Because medical treatment, including treatment for particular conditions, is not a special accommodation or service for individuals with disabilities under section 501(d), neither the Act nor this part provides affirmative authority to suspend such treatment. Section 501(d) is intended to clarify that the Act is not designed to foster discrimination through mandatory acceptance of special services when other alternatives are provided; this concern does not reach to the provision of medical treatment for the disabling condition itself.

Section 36.213 makes clear that the limitations contained in subpart C are to be read into subpart B. Thus, the integration requirement is subject to the various defenses contained in subpart C, such as safety, if eligibility criteria are at issue (§ 36.301(b)), or fundamental alteration and undue burden, if the concern is provision of auxiliary aids (§ 36.303(a)).

Section 36.204 Administrative Methods

Section 36.204 specifies that an individual or entity shall not, directly, or through contractual or other arrangements, utilize standards or criteria or methods of administration

that have the effect of discriminating on the basis of disability or that perpetuate the discrimination of others who are subject to common administrative control. The preamble discussion of § 36.301 addresses eligibility criteria in detail.

Section 36.204 is derived from section 302(b)(1)(D) of the Americans with Disabilities Act, and it uses the same language used in the employment section of the ADA (section 102(b)(3)). Both sections incorporate a disparate impact standard to ensure the effectiveness of the legislative mandate to end discrimination. This standard is consistent with the interpretation of section 504 by the U.S. Supreme Court in *Alexander v. Choate*, 469 U.S. 287 (1985). The Court in *Choate* explained that members of Congress made numerous statements during passage of section 504 regarding eliminating architectural barriers, providing access to transportation, and eliminating discriminatory effects of job qualification procedures. The Court then noted: "These statements would ring hollow if the resulting legislation could not rectify the harms resulting from action that discriminated by effect as well as by design." *Id* at 297 (footnote omitted).

Of course, § 36.204 is subject to the various limitations contained in subpart C including, for example, necessity (§ 36.301(a)), safety (§ 36.301(b)), fundamental alteration (§ 36.302(a)), readily achievable (§ 36.304(a)), and undue burden (§ 36.303(a)).

Section 36.205 Association

Section 36.205 implements section 302(b)(1)(E) of the Act, which provides that a public accommodation shall not exclude or otherwise deny equal goods, services, facilities, privileges, advantages, accommodations, or other opportunities to an individual or entity because of the known disability of an individual with whom the individual or entity is known to have a relationship or association. This section is unchanged from the proposed rule.

The individuals covered under this section include any individuals who are discriminated against because of their known association with an individual with a disability. For example, it would be a violation of this part for a day care center to refuse admission to a child because his or her brother has HIV disease.

This protection is not limited to those who have a familial relationship with the individual who has a disability. If a place of public accommodation refuses admission to a person with cerebral

palsy and his or her companions, the companions have an independent right of action under the ADA and this section.

During the legislative process, the term "entity" was added to section 302(b)(1)(E) to clarify that the scope of the provision is intended to encompass not only persons who have a known association with a person with a disability, but also entities that provide services to or are otherwise associated with such individuals. This provision was intended to ensure that entities such as health care providers, employees of social service agencies, and others who provide professional services to persons with disabilities are not subjected to discrimination because of their professional association with persons with disabilities. For example, it would be a violation of this section to terminate the lease of an entity operating an independent living center for persons with disabilities, or to seek to evict a health care provider because that individual or entity provides services to persons with mental impairments.

Section 36.206 Retaliation or Coercion

Section 36.206 implements section 503 of the ADA, which prohibits retaliation against any individual who exercises his or her rights under the Act. This section is unchanged from the proposed rule. Paragraph (a) of § 36.206 provides that no private entity or public entity shall discriminate against any individual because that individual has exercised his or her right to oppose any act or practice made unlawful by this part, or because that individual made a charge, testified, assisted, or participated in any manner in an investigation, proceeding, or hearing under the Act or this part.

Paragraph (b) provides that no private entity or public entity shall coerce, intimidate, threaten, or interfere with any individual in the exercise of his or her rights under this part or because that individual aided or encouraged any other individual in the exercise or enjoyment of any right granted or protected by the Act or this part.

Illustrations of practices prohibited by this section are contained in paragraph (c), which is modeled on a similar provision in the regulations issued by the Department of Housing and Urban Development to implement the Fair Housing Act (see 24 CFR 100.400(c)(1)). Prohibited actions may include:

(1) Coercing an individual to deny or limit the benefits, services, or advantages to which he or she is entitled under the Act or this part;

(2) Threatening, intimidating, or interfering with an individual who is seeking to obtain or use the goods,

services, facilities, privileges, advantages, or accommodations of a public accommodation;

(3) Intimidating or threatening any person because that person is assisting or encouraging an individual or group entitled to claim the rights granted or protected by the Act or this part to exercise those rights; or

(4) Retaliating against any person because that person has participated in any investigation or action to enforce the Act or this part.

This section protects not only individuals who allege a violation of the Act or this part, but also any individuals who support or assist them. This section applies to all investigations or proceedings initiated under the Act or this part without regard to the ultimate resolution of the underlying allegations. Because this section prohibits any act of retaliation or coercion in response to an individual's effort to exercise rights established by the Act and this part (or to support the efforts of another individual), the section applies not only to public accommodations that are otherwise subject to this part, but also to individuals other than public accommodations or to public entities. For example, it would be a violation of the Act and this part for a private individual, e.g., a restaurant customer, to harass or intimidate an individual with a disability in an effort to prevent that individual from patronizing the restaurant. It would, likewise, be a violation of the Act and this part for a public entity to take adverse action against an employee who appeared as a witness on behalf of an individual who sought to enforce the Act.

Section 36.207 Places of Public Accommodation Located in Private Residences

A private home used exclusively as a residence is not covered by title III because it is neither a "commercial facility" nor a "place of public accommodation." In some situations, however, a private home is not used exclusively as a residence, but houses a place of public accommodation in all or part of a home (e.g., an accountant who meets with his or her clients at his or her residence). Section 36.207(a) provides that those portions of the private residence used in the operation of the place of public accommodation are covered by this part.

For instance, a home or a portion of a home may be used as a day care center during the day and a residence at night. If all parts of the house are used for the day care center, then the entire residence is a place of public accommodation because no part of the

house is used exclusively as a residence. If an accountant uses one room in the house solely as his or her professional office, then a portion of the house is used exclusively as a place of public accommodation and a portion is used exclusively as a residence. Section 36.207 provides that when a portion of a residence is used exclusively as a residence, that portion is not covered by this part. Thus, the portions of the accountant's house, other than the professional office and areas and spaces leading to it, are not covered by this part. All of the requirements of this rule apply to the covered portions, including requirements to make reasonable modifications in policies, eliminate discriminatory eligibility criteria, take readily achievable measures to remove barriers or provide readily achievable alternatives (e.g., making house calls), provide auxiliary aids and services and undertake only accessible new construction and alterations.

Paragraph (b) was added in response to comments that sought clarification on the extent of coverage of the private residence used as the place of public accommodation. The final rule makes clear that the place of accommodation extends to all areas of the home used by clients and customers of the place of public accommodation. Thus, the ADA would apply to any door or entry way, hallways, a restroom, if used by customers and clients; and any other portion of the residence, interior or exterior, used by customers or clients of the public accommodation. This interpretation is simply an application of the general rule for all public accommodations, which extends statutory requirements to all portions of the facility used by customers and clients, including, if applicable, restrooms, hallways, and approaches to the public accommodation. As with other public accommodations, barriers at the entrance and on the sidewalk leading up to the public accommodation, if the sidewalk is under the control of the public accommodation, must be removed if doing so is readily achievable.

The Department recognizes that many businesses that operate out of personal residences are quite small, often employing only the homeowner and having limited total revenues. In these circumstances the effect of ADA coverage would likely be quite minimal. For example, because the obligation to remove existing architectural barriers is limited to those that are easily accomplishable without much difficulty or expense (see § 36.304), the range of required actions would be quite modest.

It might not be readily achievable for such a place of public accommodation to remove any existing barriers. If it is not readily achievable to remove existing architectural barriers, a public accommodation located in a private residence may meet its obligations under the Act and this part by providing its goods or services to clients or customers with disabilities through the use of alternative measures, including delivery of goods or services in the home of the customer or client, to the extent that such alternative measures are readily achievable (*See* § 36.305).

Some commenters asked for clarification as to how the new construction and alteration standards of subpart D will apply to residences. The new construction standards only apply to the extent that the residence or portion of the residence was designed or intended for use as a public accommodation. Thus, for example, if a portion of a home is designed or constructed for use exclusively as a lawyer's office or for use both as a lawyer's office and for residential purposes, then it must be designed in accordance with the new construction standards in the appendix. Likewise, if a homeowner is undertaking alterations to convert all or part of his residence to a place of public accommodation, that work must be done in compliance with the alterations standards in the appendix.

The preamble to the proposed rule addressed the applicable requirements when a commercial facility is located in a private residence. That situation is now addressed in § 36.401(b) of subpart D.

Section 36.208 Direct Threat

Section 36.208(a) implements section 302(b)(3) of the Act by providing that this part does not require a public accommodation to permit an individual to participate in or benefit from the goods, services, facilities, privileges, advantages and accommodations of the public accommodation, if that individual poses a direct threat to the health or safety of others. This section is unchanged from the proposed rule.

The Department received a significant number of comments on this section. Commenters representing individuals with disabilities generally supported this provision, but suggested revisions to further limit its application. Commenters representing public accommodations generally endorsed modifications that would permit a public accommodation to exercise its own judgment in determining whether an individual poses a direct threat.

The inclusion of this provision is not intended to imply that persons with disabilities pose risks to others. It is intended to address concerns that may arise in this area. It establishes a strict standard that must be met before denying service to an individual with a disability or excluding that individual from participation.

Paragraph (b) of this section explains that a "direct threat" is a significant risk to the health or safety of others that cannot be eliminated by a modification of policies, practices, or procedures, or by the provision of auxiliary aids and services. This paragraph codifies the standard first applied by the Supreme Court in *School Board of Nassau County v. Arline*, 480 U.S. 273 (1987), in which the Court held that an individual with a contagious disease may be an "individual with handicaps" under section 504 of the Rehabilitation Act. In *Arline*, the Supreme Court recognized that there is a need to balance the interests of people with disabilities against legitimate concerns for public safety. Although persons with disabilities are generally entitled to the protection of this part, a person who poses a significant risk to others may be excluded if reasonable modifications to the public accommodation's policies, practices, or procedures will not eliminate that risk. The determination that a person poses a direct threat to the health or safety of others may not be based on generalizations or stereotypes about the effects of a particular disability; it must be based on an individual assessment that conforms to the requirements of paragraph (c) of this section.

Paragraph (c) establishes the test to use in determining whether an individual poses a direct threat to the health or safety of others. A public accommodation is required to make an individualized assessment, based on reasonable judgment that relies on current medical evidence or on the best available objective evidence, to determine: The nature, duration, and severity of the risk; the probability that the potential injury will actually occur; and whether reasonable modifications of policies, practices, or procedures will mitigate the risk. This is the test established by the Supreme Court in *Arline*. Such an inquiry is essential if the law is to achieve its goal of protecting disabled individuals from discrimination based on prejudice, stereotypes, or unfounded fear, while giving appropriate weight to legitimate concerns, such as the need to avoid exposing others to significant health and safety risks. Making this assessment will not usually

require the services of a physician. Sources for medical knowledge include guidance from public health authorities, such as the U.S. Public Health Service, the Centers for Disease Control, and the National Institutes of Health, including the National Institute of Mental Health.

Many of the commenters sought clarification of the inquiry requirement. Some suggested that public accommodations should be prohibited from making any inquiries to determine if an individual with a disability would pose a direct threat to other persons. The Department believes that to preclude all such inquiries would be inappropriate. Under § 36.301 of this part, a public accommodation is permitted to establish eligibility criteria necessary for the safe operation of the place of public accommodation. Implicit in that right is the right to ask if an individual meets the criteria. However, any eligibility or safety standard established by a public accommodation must be based on actual risk, not on speculation or stereotypes; it must be applied to all clients or customers of the place of public accommodation; and inquiries must be limited to matters necessary to the application of the standard.

Some commenters suggested that the test established in the *Arline* decision, which was developed in the context of an employment case, is too stringent to apply in a public accommodations context where interaction between the public accommodation and its client or customer is often very brief. One suggested alternative was to permit public accommodations to exercise "good faith" judgment in determining whether an individual poses a direct threat, particularly when a public accommodation is dealing with a client or customer engaged in disorderly or disruptive behavior.

The Department believes that the ADA clearly requires that any determination to exclude an individual from participation must be based on an objective standard. A public accommodation may establish neutral eligibility criteria as a condition of receiving its goods or services. As long as these criteria are necessary for the safe provision of the public accommodation's goods and services and applied neutrally to all clients or customers, regardless of whether they are individuals with disabilities, a person who is unable to meet the criteria may be excluded from participation without inquiry into the underlying reason for the inability to comply. In places of public accommodation such as restaurants,

theaters, or hotels, where the contact between the public accommodation and its clients is transitory, the uniform application of an eligibility standard precluding violent or disruptive behavior by any client or customer should be sufficient to enable a public accommodation to conduct its business in an orderly manner.

Some other commenters asked for clarification of the application of this provision to persons, particularly children, who have short-term, contagious illnesses, such as fevers, influenza, or the common cold. It is common practice in schools and day care settings to exclude persons with such illnesses until the symptoms subside. The Department believes that these commenters misunderstand the scope of this rule. The ADA only prohibits discrimination against an individual with a disability. Under the ADA and this part, a "disability" is defined as a physical or mental impairment that substantially limits one or more major life activities. Common, short-term illnesses that predictably resolve themselves within a matter of days do not "substantially limit" a major life activity; therefore, it is not a violation of this part to exclude an individual from receiving the services of a public accommodation because of such transitory illness. However, this part does apply to persons who have long-term illnesses. Any determination with respect to a person who has a chronic or long-term illness must be made in compliance with the requirements of this section.

Section 36.209 Illegal Use of Drugs

Section 36.209 effectuates section 510 of the ADA, which clarifies the Act's application to people who use drugs illegally. Paragraph (a) provides that this part does not prohibit discrimination based on an individual's current illegal use of drugs.

The Act and the regulation distinguish between illegal use of drugs and the legal use of substances, whether or not those substances are "controlled substances," as defined in the Controlled Substances Act (21 U.S.C. 812). Some controlled substances are prescription drugs that have legitimate medical uses. Section 36.209 does not affect use of controlled substances pursuant to a valid prescription, under supervision by a licensed health care professional, or other use that is authorized by the Controlled Substances Act or any other provision of Federal law. It does apply to illegal use of those substances, as well as to illegal use of controlled substances that are not prescription drugs. The key question is

whether the individual's use of the substance is illegal, not whether the substance has recognized legal uses. Alcohol is not a controlled substance, so use of alcohol is not addressed by § 36.209. Alcoholics are individuals with disabilities, subject to the protections of the statute.

A distinction is also made between the use of a substance and the status of being addicted to that substance. Addiction is a disability, and addicts are individuals with disabilities protected by the Act. The protection, however, does not extend to actions based on the illegal use of the substance. In other words, an addict cannot use the fact of his or her addiction as a defense to an action based on illegal use of drugs. This distinction is not artificial. Congress intended to deny protection to people who engage in the illegal use of drugs, whether or not they are addicted, but to provide protection to addicts so long as they are not currently using drugs.

A third distinction is the difficult one between current use and former use. The definition of "current illegal use of drugs" in § 36.104, which is based on the report of the Conference Committee, H.R. Conf. Rep. No. 596, 101st Cong., 2d Sess. 64 (1990), is "illegal use of drugs that occurred recently enough to justify a reasonable belief that a person's drug use is current or that continuing use is a real and ongoing problem."

Paragraph (a)(2)(i) specifies that an individual who has successfully completed a supervised drug rehabilitation program or has otherwise been rehabilitated successfully and who is not engaging in current illegal use of drugs is protected. Paragraph (a)(2)(ii) clarifies that an individual who is currently participating in a supervised rehabilitation program and is not engaging in current illegal use of drugs is protected. Paragraph (a)(2)(iii) provides that a person who is erroneously regarded as engaging in current illegal use of drugs, but who is not engaging in such use, is protected.

Paragraph (b) provides a limited exception to the exclusion of current illegal users of drugs from the protections of the Act. It prohibits denial of health services, or services provided in connection with drug rehabilitation, to an individual on the basis of current illegal use of drugs, if the individual is otherwise entitled to such services. As explained further in the discussion of § 36.302, a health care facility that specializes in a particular type of treatment, such as care of burn victims, is not required to provide drug rehabilitation services, but it cannot refuse to treat an individual's burns on

the grounds that the individual is illegally using drugs.

A commenter argued that health care providers should be permitted to use their medical judgment to postpone discretionary medical treatment of individuals under the influence of alcohol or drugs. The regulation permits a medical practitioner to take into account an individual's use of drugs in determining appropriate medical treatment. Section 36.209 provides that the prohibitions on discrimination in this part do not apply when the public accommodation acts on the basis of current illegal use of drugs. Although those prohibitions do apply under paragraph (b), the limitations established under this part also apply. Thus, under § 36.208, a health care provider or other public accommodation covered under § 36.209(b) may exclude an individual whose current illegal use of drugs poses a direct threat to the health or safety of others, and, under § 36.301, a public accommodation may impose or apply eligibility criteria that are necessary for the provision of the services being offered, and may impose legitimate safety requirements that are necessary for safe operation. These same limitations also apply to individuals with disabilities who use alcohol or prescription drugs. The Department believes that these provisions address this commenter's concerns.

Other commenters pointed out that abstinence from the use of drugs is an essential condition for participation in some drug rehabilitation programs, and may be a necessary requirement in inpatient or residential settings. The Department believes that this comment is well-founded. Congress clearly did not intend to exclude from drug treatment programs the very individuals who need such programs because of their use of drugs. In such a situation, however, once an individual has been admitted to a program, abstinence may be a necessary and appropriate condition to continued participation. The final rule therefore provides that a drug rehabilitation or treatment program may deny participation to individuals who use drugs while they are in the program.

Paragraph (c) expresses Congress' intention that the Act be neutral with respect to testing for illegal use of drugs. This paragraph implements the provision in section 510(b) of the Act that allows entities "to adopt or administer reasonable policies or procedures, including but not limited to drug testing," that ensure an individual who is participating in a supervised

rehabilitation program, or who has completed such a program or otherwise been rehabilitated successfully, is no longer engaging in the illegal use of drugs. Paragraph (c) is not to be construed to encourage, prohibit, restrict, or authorize the conducting of testing for the illegal use of drugs.

Paragraph (c) of § 36.209 clarifies that it is not a violation of this part to adopt or administer reasonable policies or procedures to ensure that an individual who formerly engaged in the illegal use of drugs is not currently engaging in illegal use of drugs. Any such policies or procedures must, of course, be reasonable, and must be designed to identify accurately the illegal use of drugs. This paragraph does not authorize inquiries, tests, or other procedures that would disclose use of substances that are not controlled substances or are taken under supervision by a licensed health care professional, or other uses authorized by the Controlled Substances Act or other provisions of Federal law, because such uses are not included in the definition of "illegal use of drugs."

One commenter argued that the rule should permit testing for lawful use of prescription drugs, but most favored the explanation that tests must be limited to *unlawful* use in order to avoid revealing the use of prescription medicine used to treat disabilities. Tests revealing legal use of prescription drugs might violate the prohibition in § 36.301 of attempts to unnecessarily identify the existence of a disability.

Section 36.210 Smoking

Section 36.210 restates the clarification in section 501(b) of the Act that the Act does not preclude the prohibition of, or imposition of restrictions on, smoking. Some commenters argued that § 36.210 does not go far enough, and that the regulation should prohibit smoking in all places of public accommodation. The reference to smoking in section 501 merely clarifies that the Act does not require public accommodations to accommodate smokers by permitting them to smoke in places of public accommodations.

Section 36.211 Maintenance of Accessible Features

Section 36.211 provides that a public accommodation shall maintain in operable working condition those features of facilities and equipment that are required to be readily accessible to and usable by persons with disabilities by the Act or this part. The Act requires that, to the maximum extent feasible, facilities must be accessible to, and

usable by, individuals with disabilities. This section recognizes that it is not sufficient to provide features such as accessible routes, elevators, or ramps, if those features are not maintained in a manner that enables individuals with disabilities to use them. Inoperable elevators, locked accessible doors, or "accessible" routes that are obstructed by furniture, filing cabinets, or potted plants are neither "accessible to" nor "usable by" individuals with disabilities.

Some commenters objected that this section appeared to establish an absolute requirement and suggested that language from the preamble be included in the text of the regulation. It is, of course, impossible to guarantee that mechanical devices will never fail to operate. Paragraph (b) of the final regulation provides that this section does not prohibit isolated or temporary interruptions in service or access due to maintenance or repairs. This paragraph is intended to clarify that temporary obstructions or isolated instances of mechanical failure would not be considered violations of the Act or this part. However, allowing obstructions or "out of service" equipment to persist beyond a reasonable period of time would violate this part, as would repeated mechanical failures due to improper or inadequate maintenance. Failure of the public accommodation to ensure that accessible routes are properly maintained and free of obstructions, or failure to arrange prompt repair of inoperable elevators or other equipment intended to provide access, would also violate this part.

Other commenters requested that this section be expanded to include specific requirements for inspection and maintenance of equipment, for training staff in the proper operation of equipment, and for maintenance of specific items. The Department believes that this section properly establishes the general requirement for maintaining access and that further, more detailed requirements are not necessary.

Section 36.212 Insurance

The Department received numerous comments on proposed § 36.212. Most supported the proposed regulation but felt that it did not go far enough in protecting individuals with disabilities and persons associated with them from discrimination. Many commenters argued that language from the preamble to the proposed regulation should be included in the text of the final regulation. Other commenters argued that even that language was not strong enough, and that more stringent standards should be established. Only a

few commenters argued that the Act does not apply to insurance underwriting practices or the terms of insurance contracts. These commenters cited language from the Senate committee report (S. Rep. No. 116, 101st Cong., 1st Sess., at 84-86 (1989) (hereinafter "Senate report")), indicating that Congress did not intend to affect existing insurance practices.

The Department has decided to adopt the language of the proposed rule without change. Sections 36.212 (a) and (b) restate section 501(c) of the Act, which provides that the Act shall not be construed to restrict certain insurance practices on the part of insurance companies and employers, as long as such practices are not used to evade the purposes of the Act. Section 36.212(c) is a specific application of § 36.202(a), which prohibits denial of participation on the basis of disability. It provides that a public accommodation may not refuse to serve an individual with a disability because of limitations on coverage or rates in its insurance policies (see Judiciary report at 56).

Many commenters supported the requirements of § 36.212(c) in the proposed rule because it addressed an important reason for denial of services by public accommodations. One commenter argued that services could be denied if the insurance coverage required exclusion of people whose disabilities were reasonably related to the risks involved in that particular place of public accommodation. Sections 36.208 and 36.301 establish criteria for denial of participation on the basis of legitimate safety concerns. This paragraph does not prohibit consideration of such concerns in insurance policies, but provides that any exclusion on the basis of disability must be based on the permissible criteria, rather than on the terms of the insurance contract.

Language in the committee reports indicates that Congress intended to reach insurance practices by prohibiting differential treatment of individuals with disabilities in insurance offered by public accommodations unless the differences are justified. "Under the ADA, a person with a disability cannot be denied insurance or be subject to different terms or conditions of insurance based on disability alone, if the disability does not pose increased risks" (Senate report at 84; Education and Labor report at 136). Section 501(c) (1) of the Act was intended to emphasize that "insurers may continue to sell to and underwrite individuals applying for life, health, or other insurance on an individually

underwritten basis, or to service such insurance products, *so long as the standards used are based on sound actuarial data and not on speculation*" (Judiciary report at 70 (emphasis added); see also Senate report at 85; Education and Labor report at 137).

The committee reports indicate that underwriting and classification of risks must be "based on sound actuarial principles or be related to actual or reasonably anticipated experience" (see, e.g., Judiciary report at 71). Moreover, "while a plan which limits certain kinds of coverage based on classification of risk would be allowed * * *, the plan may not refuse to insure, or refuse to continue to insure, or limit the amount, extent, or kind of coverage available to an individual, or charge a different rate for the same coverage solely because of a physical or mental impairment, except where the refusal, limitation, or rate differential is based on sound actuarial principles or is related to actual or reasonably anticipated experience" (Senate report at 85; Education and Labor report at 136-37; Judiciary report at 71). The ADA, therefore, does not prohibit use of legitimate actuarial considerations to justify differential treatment of individuals with disabilities in insurance.

The committee reports provide some guidance on how nondiscrimination principles in the disability rights area relate to insurance practices. For example, a person who is blind may not be denied coverage based on blindness independent of actuarial risk classification. With respect to group health insurance coverage, an individual with a pre-existing condition may be denied coverage for that condition for the period specified in the policy, but cannot be denied coverage for illness or injuries unrelated to the pre-existing condition. Also, a public accommodation may offer insurance policies that limit coverage for certain procedures or treatments, but may not entirely deny coverage to a person with a disability.

The Department requested comment on the extent to which data that would establish statistically sound correlations are available. Numerous commenters cited pervasive problems in the availability and cost of insurance for individuals with disabilities and parents of children with disabilities. No commenters cited specific data, or sources of data, to support specific exclusionary practices. Several commenters reported that, even when statistics are available, they are often outdated and do not reflect current

medical technology and treatment methods. Concern was expressed that adequate efforts are not made to distinguish those individuals who are high users of health care from individuals in the same diagnostic groups who may be low users of health care. One insurer reported that "hard data and actuarial statistics are not available to provide precise numerical justifications for every underwriting determination," but argued that decisions may be based on "logical principles generally accepted by actuarial science and fully consistent with state insurance laws." The commenter urged that the Department recognize the validity of information other than statistical data as a basis for insurance determinations.

The most frequent comment was a recommendation that the final regulation should require the insurance company to provide a copy of the actuarial data on which its actions are based when requested by the applicant. Such a requirement would be beyond anything contemplated by the Act or by Congress and has therefore not been included in the Department's final rule. Because the legislative history of the ADA clarifies that different treatment of individuals with disabilities in insurance may be justified by sound actuarial data, such actuarial data will be critical to any potential litigation on this issue. This information would presumably be obtainable in a court proceeding where the insurer's actuarial data was the basis for different treatment of persons with disabilities. In addition, under some State regulatory schemes, insurers may have to file such actuarial information with the State regulatory agency and this information may be obtainable at the State level.

A few commenters representing the insurance industry conceded that underwriting practices in life and health insurance are clearly covered, but argued that property and casualty insurance are not covered. The Department sees no reason for this distinction. Although life and health insurance are the areas where the regulation will have its greatest application, the Act applies equally to unjustified discrimination in all types of insurance provided by public accommodations. A number of commenters, for example, reported difficulties in obtaining automobile insurance because of their disabilities, despite their having good driving records.

Section 36.213 Relationship of Subpart 8 to Subparts C and D

This section explains that subpart B sets forth the general principles of nondiscrimination applicable to all entities subject to this regulation, while subparts C and D provide guidance on the application of this part to specific situations. The specific provisions in subparts C and D, including the limitations on those provisions, control over the general provisions in circumstances where both specific and general provisions apply. Resort to the general provisions of subpart B is only appropriate where there are no applicable specific rules of guidance in subparts C or D. This interaction between the specific requirements and the general requirements operates with regard to contractual obligations as well.

One illustration of this principle is its application to the obligation of a public accommodation to provide access to services by removal of architectural barriers or by alternatives to barrier removal. The general requirement, established in subpart B by § 36.203, is that a public accommodation must provide its services to individuals with disabilities in the most integrated setting appropriate. This general requirement would appear to categorically prohibit "segregated" seating for persons in wheelchairs. Section 36.304, however, only requires removal of architectural barriers to the extent that removal is "readily achievable." If providing access to all areas of a restaurant, for example, would not be "readily achievable," a public accommodation may provide access to selected areas only. Also, § 36.305 provides that, where barrier removal is not readily achievable, a public accommodation may use alternative, readily achievable methods of making services available, such as curbside service or home delivery. Thus, in this manner, the specific requirements of §§ 36.304 and 36.305 control over the general requirement of § 36.203.

Subpart C—Specific Requirements

In general, subpart C implements the "specific prohibitions" that comprise section 302(b)(2) of the ADA. It also addresses the requirements of section 309 of the ADA regarding examinations and courses.

Section 36.301 Eligibility Criteria

Section 36.301 of the rule prohibits the imposition or application of eligibility criteria that screen out or tend to screen out an individual with a disability or any class of individuals with disabilities from fully and equally enjoying any

goods, services, facilities, privileges, advantages, and accommodations, unless such criteria can be shown to be necessary for the provision of the goods, services, facilities, privileges, advantages, or accommodations being offered. This prohibition is based on section 302(b)(2)(A)(i) of the ADA.

It would violate this section to establish exclusive or segregative eligibility criteria that would bar, for example, all persons who are deaf from playing on a golf course or all individuals with cerebral palsy from attending a movie theater, or limit the seating of individuals with Down's syndrome to only particular areas of a restaurant. The wishes, tastes, or preferences of other customers may not be asserted to justify criteria that would exclude or segregate individuals with disabilities.

Section 36.301 also prohibits attempts by a public accommodation to unnecessarily identify the existence of a disability; for example, it would be a violation of this section for a retail store to require an individual to state on a credit application whether the applicant has epilepsy, mental illness, or any other disability, or to inquire unnecessarily whether an individual has HIV disease.

Section 36.301 also prohibits policies that unnecessarily impose requirements or burdens on individuals with disabilities that are not placed on others. For example, public accommodations may not require that an individual with a disability be accompanied by an attendant. As provided by § 36.306, however, a public accommodation is not required to provide services of a personal nature including assistance in toileting, eating, or dressing.

Paragraph (c) of § 36.301 provides that public accommodations may not place a surcharge on a particular individual with a disability or any group of individuals with disabilities to cover the costs of measures, such as the provision of auxiliary aids and services, barrier removal, alternatives to barrier removal, and reasonable modifications in policies, practices, and procedures, that are required to provide that individual or group with the nondiscriminatory treatment required by the Act or this part.

A number of commenters inquired as to whether deposits required for the use of auxiliary aids, such as assistive listening devices, are prohibited surcharges. It is the Department's view that reasonable, completely refundable, deposits are not to be considered surcharges prohibited by this section. Requiring deposits is an important means of ensuring the availability of

equipment necessary to ensure compliance with the ADA.

Other commenters sought clarification as to whether § 36.301(c) prohibits professionals from charging for the additional time that it may take in certain cases to provide services to an individual with disabilities. The Department does not intend § 36.301(c) to prohibit professionals who bill on the basis of time from charging individuals with disabilities on that basis. However, fees may not be charged for the provision of auxiliary aids and services, barrier removal, alternatives to barrier removal, reasonable modifications in policies, practices, and procedures, or any other measures necessary to ensure compliance with the ADA.

Other commenters inquired as to whether day care centers may charge for extra services provided to individuals with disabilities. As stated above, § 36.302(c) is intended only to prohibit charges for measures necessary to achieve compliance with the ADA.

Another commenter asserted that charges may be assessed for home delivery provided as an alternative to barrier removal under § 36.305, when home delivery is provided to all customers for a fee. Charges for home delivery are permissible if home delivery is not considered an alternative to barrier removal. If the public accommodation offers an alternative, such as curb, carry-out, or sidewalk service for which no surcharge is assessed, then it may charge for home delivery in accordance with its standard pricing for home delivery.

In addition, § 36.301 prohibits the imposition of criteria that "tend to" screen out an individual with a disability. This concept, which is derived from current regulations under section 504 (see, e.g., 45 CFR 84.13), makes it discriminatory to impose policies or criteria that, while not creating a direct bar to individuals with disabilities, indirectly prevent or limit their ability to participate. For example, requiring presentation of a driver's license as the sole means of identification for purposes of paying by check would violate this section in situations where, for example, individuals with severe vision impairments or developmental disabilities or epilepsy are ineligible to receive a driver's license and the use of an alternative means of identification, such as another photo I.D. or credit card, is feasible.

A public accommodation may, however, impose neutral rules and criteria that screen out, or tend to screen out, individuals with disabilities, if the criteria are necessary for the safe

operation of the public accommodation. Examples of safety qualifications that would be justifiable in appropriate circumstances would include height requirements for certain amusement park rides or a requirement that all participants in a recreational rafting expedition be able to meet a necessary level of swimming proficiency. Safety requirements must be based on actual risks and not on speculation, stereotypes, or generalizations about individuals with disabilities.

Section 36.302 Modifications in Policies, Practices, or Procedures

Section 36.302 of the rule prohibits the failure to make reasonable modifications in policies, practices, and procedures when such modifications may be necessary to afford any goods, services, facilities, privileges, advantages, or accommodations, unless the entity can demonstrate that making such modifications would fundamentally alter the nature of such goods, services, facilities, privileges, advantages, or accommodations. This prohibition is based on section 302(b)(2)(A)(ii) of the ADA.

For example, a parking facility would be required to modify a rule barring all vans or all vans with raised roofs, if an individual who uses a wheelchair-accessible van wishes to park in that facility, and if overhead structures are high enough to accommodate the height of the van. A department store may need to modify a policy of only permitting one person at a time in a dressing room, if an individual with mental retardation needs and requests assistance in dressing from a companion. Public accommodations may need to revise operational policies to ensure that services are available to individuals with disabilities. For instance, a hotel may need to adopt a policy of keeping an accessible room unoccupied until an individual with a disability arrives at the hotel, assuming the individual has properly reserved the room.

One example of application of this principle is specifically included in a new § 36.302(d) on check-out aisles. That paragraph provides that a store with check-out aisles must ensure that an adequate number of accessible check-out aisles is kept open during store hours, or must otherwise modify its policies and practices, in order to ensure that an equivalent level of convenient service is provided to individuals with disabilities as is provided to others. For example, if only one check-out aisle is accessible, and it is generally used for express service,

one way of providing equivalent service is to allow persons with mobility impairments to make all of their purchases at that aisle. This principle also applies with respect to other accessible elements and services. For example, a particular bank may be in compliance with the accessibility guidelines for new construction incorporated in appendix A with respect to automated teller machines (ATM) at a new branch office by providing one accessible walk-up machine at that location, even though an adjacent walk-up ATM is not accessible and the drive-up ATM is not accessible. However, the bank would be in violation of this section if the accessible ATM was located in a lobby that was locked during evening hours while the drive-up ATM was available to customers without disabilities during those same hours. The bank would need to ensure that the accessible ATM was available to customers during the hours that any of the other ATM's was available.

A number of commenters inquired as to the relationship between this section and § 36.307, "Accessible or special goods." Under § 36.307, a public accommodation is not required to alter its inventory to include accessible or special goods that are designed for, or facilitate use by, individuals with disabilities. The rule enunciated in § 36.307 is consistent with the "fundamental alteration" defense to the reasonable modifications requirement of § 36.302. Therefore, § 36.302 would not require the inventory of goods provided by a public accommodation to be altered to include goods with accessibility features. For example, § 36.302 would not require a bookstore to stock Brailled books or order Brailled books, if it does not do so in the normal course of its business.

The rule does not require modifications to the legitimate areas of specialization of service providers. Section 36.302(b) provides that a public accommodation may refer an individual with a disability to another public accommodation, if that individual is seeking, or requires, treatment or services outside of the referring public accommodation's area of specialization, and if, in the normal course of its operations, the referring public accommodation would make a similar referral for an individual without a disability who seeks or requires the same treatment or services.

For example, it would not be discriminatory for a physician who specializes only in burn treatment to refer an individual who is deaf to another physician for treatment of an

injury other than a burn injury. To require a physician to accept patients outside of his or her specialty would fundamentally alter the nature of the medical practice and, therefore, not be required by this section.

A clinic specializing exclusively in drug rehabilitation could similarly refuse to treat a person who is not a drug addict, but could not refuse to treat a person who is a drug addict simply because the patient tests positive for HIV. Conversely, a clinic that specializes in the treatment of individuals with HIV could refuse to treat an individual that does not have HIV, but could not refuse to treat a person for HIV infection simply because that person is also a drug addict.

Some commenters requested clarification as to how this provision would apply to situations where manifestations of the disability in question, itself, would raise complications requiring the expertise of a different practitioner. It is not the Department's intention in § 36.302(b) to prohibit a physician from referring an individual with a disability to another physician, if the disability itself creates specialized complications for the patient's health that the physician lacks the experience or knowledge to address (see Education and Labor report at 106).

Section 36.302(c)(1) requires that a public accommodation modify its policies, practices, or procedures to permit the use of a service animal by an individual with a disability in any area open to the general public. The term "service animal" is defined in § 36.104 to include guide dogs, signal dogs, or any other animal individually trained to provide assistance to an individual with a disability.

A number of commenters pointed to the difficulty of making the distinction required by the proposed rule between areas open to the general public and those that are not. The ambiguity and uncertainty surrounding these provisions has led the Department to adopt a single standard for all public accommodations.

Section 36.302(c)(1) of the final rule now provides that "[g]enerally, a public accommodation shall modify policies, practices, and procedures to permit the use of a service animal by an individual with a disability." This formulation reflects the general intent of Congress that public accommodations take the necessary steps to accommodate service animals and to ensure that individuals with disabilities are not separated from their service animals. It is intended that the broadest feasible access be provided to service animals in all places of public

accommodation, including movie theaters, restaurants, hotels, retail stores, hospitals, and nursing homes (see Education and Labor report at 106; Judiciary report at 59). The section also acknowledges, however, that, in rare circumstances, accommodation of service animals may not be required because a fundamental alteration would result in the nature of the goods, services, facilities, privileges, or accommodations offered or provided, or the safe operation of the public accommodation would be jeopardized.

As specified in § 36.302(c)(2), the rule does not require a public accommodation to supervise or care for any service animal. If a service animal must be separated from an individual with a disability in order to avoid a fundamental alteration or a threat to safety, it is the responsibility of the individual with the disability to arrange for the care and supervision of the animal during the period of separation.

A museum would not be required by § 36.302 to modify a policy barring the touching of delicate works of art in order to enhance the participation of individuals who are blind, if the touching threatened the integrity of the work. Damage to a museum piece would clearly be a fundamental alteration that is not required by this section.

Section 36.303 Auxiliary Aids and Services.

Section 36.303 of the final rule requires a public accommodation to take such steps as may be necessary to ensure that no individual with a disability is excluded, denied services, segregated or otherwise treated differently than other individuals because of the absence of auxiliary aids and services, unless the public accommodation can demonstrate that taking such steps would fundamentally alter the nature of the goods, services, facilities, advantages, or accommodations being offered or would result in an undue burden. This requirement is based on section 302(b)(2)(A)(iii) of the ADA.

Implicit in this duty to provide auxiliary aids and services is the underlying obligation of a public accommodation to communicate effectively with its customers, clients, patients, or participants who have disabilities affecting hearing, vision, or speech. To give emphasis to this underlying obligation, § 36.303(c) of the rule incorporates language derived from section 504 regulations for federally conducted programs (see *e.g.*, 28 CFR 39.160(a)) that requires that appropriate auxiliary aids and services be furnished

to ensure that communication with persons with disabilities is as effective as communication with others.

Auxiliary aids and services include a wide range of services and devices for ensuring effective communication. Use of the most advanced technology is not required so long as effective communication is ensured. The Department's proposed § 36.303(b) provided a list of examples of auxiliary aids and services that was taken from the definition of auxiliary aids and services in section 3(1) of the ADA and was supplemented by examples from regulations implementing section 504 in federally conducted programs (see *e.g.*, 28 CFR 39.103). A substantial number of commenters suggested that additional examples be added to this list. The Department has added several items to this list but wishes to clarify that the list is not an all-inclusive or exhaustive catalogue of possible or available auxiliary aids or services. It is not possible to provide an exhaustive list, and such an attempt would omit new devices that will become available with emerging technology.

The Department has added videotext displays, computer-aided transcription services, and open and closed captioning to the list of examples. Videotext displays have become an important means of accessing auditory communications through a public address system. Transcription services are used to relay aurally delivered material almost simultaneously in written form to persons who are deaf or hard of hearing. This technology is often used at conferences, conventions, and hearings. While the proposed rule expressly included television decoder equipment as an auxiliary aid or service, it did not mention captioning itself. The final rule rectifies this omission by mentioning both closed and open captioning.

In this section, the Department has changed the proposed rule's phrase, "orally delivered materials," to the phrase, "aurally delivered materials." This new phrase tracks the language in the definition of "auxiliary aids and services" in section 3 of the ADA and is meant to include nonverbal sounds and alarms and computer-generated speech.

Several persons and organizations requested that the Department replace the term "telecommunications devices for deaf persons" or "TDD's" with the term "text telephone." The Department has declined to do so. The Department is aware that the Architectural and Transportation Barriers Compliance Board has used the phrase "text telephone" in lieu of the statutory term "TDD" in its final accessibility

guidelines. Title IV of the ADA, however, uses the term "Telecommunications Device for the Deaf," and the Department believes it would be inappropriate to abandon this statutory term at this time.

Paragraph (b)(2) lists examples of aids and services for making visually delivered materials accessible to persons with visual impairments. Many commenters proposed additional examples such as signage or mapping, audio description services, secondary auditory programs (SAP), telebrailers, and reading machines. While the Department declines to add these items to the list in the regulation, they may be considered appropriate auxiliary aids and services.

Paragraph (b)(3) refers to the acquisition or modification of equipment or devices. For example, tape players used for an audio-guided tour of a museum exhibit may require the addition of Brailled adhesive labels to the buttons on a reasonable number of the tape players to facilitate their use by individuals who are blind. Similarly, permanent or portable assistive listening systems for persons with hearing impairments may be required at a hotel conference center.

Several commenters suggested the addition of current technological innovations in microelectronics and computerized control systems (*e.g.*, voice recognition systems, automatic dialing telephones, and infrared elevator and light control systems) to the list of auxiliary aids and services. The Department interprets auxiliary aids and services as those aids and services designed to provide effective communications, *i. e.*, making aurally and visually delivered information available to persons with hearing, speech, and vision impairments. Methods of making services, programs, or activities accessible to, or usable by, individuals with mobility or manual dexterity impairments are addressed by other sections of this part, including the requirements for modifications in policies, practices, or procedures (§ 36.302), the elimination of existing architectural barriers (§ 36.304), and the provision of alternatives to barriers removal (§ 36.305).

Paragraph (b)(4) refers to other similar services and actions. Several commenters asked for clarification that "similar services and actions" include retrieving items from shelves, assistance in reaching a marginally accessible seat, pushing a barrier aside in order to provide an accessible route, or assistance in removing a sweater or coat. While retrieving an item from a shelf might be an "auxiliary aid or

service" for a blind person who could not locate the item without assistance, it might be a readily achievable alternative to barrier removal for a person using a wheelchair who could not reach the shelf, or a reasonable modification to a self-service policy for an individual who lacked the ability to grasp the item. (Of course, a store would not be required to provide a personal shopper.) As explained above, auxiliary aids and services are those aids and services required to provide effective communications. Other forms of assistance are more appropriately addressed by other provisions of the final rule.

The auxiliary aid requirement is a flexible one. A public accommodation can choose among various alternatives as long as the result is effective communication. For example, a restaurant would not be required to provide menus in Braille for patrons who are blind, if the waiters in the restaurant are made available to read the menu. Similarly, a clothing boutique would not be required to have Brailled price tags if sales personnel provide price information orally upon request; and a bookstore would not be required to make available a sign language interpreter, because effective communication can be conducted by notepad.

A critical determination is what constitutes an effective auxiliary aid or service. The Department's proposed rule recommended that, in determining what auxiliary aid to use, the public accommodation consult with an individual before providing him or her with a particular auxiliary aid or service. This suggestion sparked a significant volume of public comment. Many persons with disabilities, particularly persons who are deaf or hard of hearing, recommended that the rule should require that public accommodations give "primary consideration" to the "expressed choice" of an individual with a disability. These commenters asserted that the proposed rule was inconsistent with congressional intent of the ADA, with the Department's proposed rule implementing title II of the ADA, and with longstanding interpretations of section 504 of the Rehabilitation Act.

Based upon a careful review of the ADA legislative history, the Department believes that Congress did not intend under title III to impose upon a public accommodation the requirement that it give primary consideration to the request of the individual with a disability. To the contrary, the legislative history demonstrates

congressional intent to strongly encourage consulting with persons with disabilities. In its analysis of the ADA's auxiliary aids requirement for public accommodations, the House Education and Labor Committee stated that it "expects" that "public accommodation(s) will consult with the individual with a disability before providing a particular auxiliary aid or service" (Education and Labor report at 107). Some commenters also cited a different committee statement that used mandatory language as evidence of legislative intent to require primary consideration. However, this statement was made in the context of reasonable accommodations required by title I with respect to employment (Education and Labor report at 67). Thus, the Department finds that strongly encouraging consultation with persons with disabilities, in lieu of mandating primary consideration of their expressed choice, is consistent with congressional intent.

The Department wishes to emphasize that public accommodations must take steps necessary to ensure that an individual with a disability will not be excluded, denied services, segregated or otherwise treated differently from other individuals because of the use of inappropriate or ineffective auxiliary aids. In those situations requiring an interpreter, the public accommodations must secure the services of a qualified interpreter, unless an undue burden would result.

In the analysis of § 36.303(c) in the proposed rule, the Department gave as an example the situation where a note pad and written materials were insufficient to permit effective communication in a doctor's office when the matter to be decided was whether major surgery was necessary. Many commenters objected to this statement, asserting that it gave the impression that only decisions about major surgery would merit the provision of a sign language interpreter. The statement would, as the commenters also claimed, convey the impression to other public accommodations that written communications would meet the regulatory requirements in all but the most extreme situations. The Department, when using the example of major surgery, did not intend to limit the provision of interpreter services to the most extreme situations.

Other situations may also require the use of interpreters to ensure effective communication depending on the facts of the particular case. It is not difficult to imagine a wide range of communications involving areas such as

health, legal matters, and finances that would be sufficiently lengthy or complex to require an interpreter for effective communication. In some situations, an effective alternative to use of a notepad or an interpreter may be the use of a computer terminal upon which the representative of the public accommodation and the customer or client can exchange typewritten messages.

Section 36.303(d) specifically addresses requirements for TDD's. Partly because of the availability of telecommunications relay services to be established under title IV of the ADA, § 36.303(d)(2) provides that a public accommodation is not required to use a telecommunication device for the deaf (TDD) in receiving or making telephone calls incident to its operations. Several commenters were concerned that relay services would not be sufficient to provide effective access in a number of situations. Commenters argued that relay systems (1) do not provide effective access to the automated systems that require the caller to respond by pushing a button on a touch tone phone, (2) cannot operate fast enough to convey messages on answering machines, or to permit a TDD user to leave a recorded message, and (3) are not appropriate for calling crisis lines relating to such matters as rape, domestic violence, child abuse, and drugs where confidentiality is a concern. The Department believes that it is more appropriate for the Federal Communications Commission to address these issues in its rulemaking under title IV.

A public accommodation is, however, required to make a TDD available to an individual with impaired hearing or speech, if it customarily offers telephone service to its customers, clients, patients, or participants on more than an incidental convenience basis. Where entry to a place of public accommodation requires use of a security entrance telephone, a TDD or other effective means of communication must be provided for use by an individual with impaired hearing or speech.

In other words, individual retail stores, doctors' offices, restaurants, or similar establishments are not required by this section to have TDD's, because TDD users will be able to make inquiries, appointments, or reservations with such establishments through the relay system established under title IV of the ADA. The public accommodation will likewise be able to contact TDD users through the relay system. On the other hand, hotels, hospitals, and other

similar establishments that offer nondisabled individuals the opportunity to make outgoing telephone calls on more than an incidental convenience basis must provide a TDD on request.

Section 36.303(e) requires places of lodging that provide televisions in five or more guest rooms and hospitals to provide, upon request, a means for decoding closed captions for use by an individual with impaired hearing. Hotels should also provide a TDD or similar device at the front desk in order to take calls from guests who use TDD's in their rooms. In this way guests with hearing impairments can avail themselves of such hotel services as making inquiries of the front desk and ordering room service. The term "hospital" is used in its general sense and should be interpreted broadly.

Movie theaters are not required by § 36.303 to present open-captioned films. However, other public accommodations that impart verbal information through soundtracks on films, video tapes, or slide shows are required to make such information accessible to persons with hearing impairments. Captioning is one means to make the information accessible to individuals with disabilities.

The rule specifies that auxiliary aids and services include the acquisition or modification of equipment or devices. For example, tape players used for an audio-guided tour of a museum exhibit may require the addition of Brailled adhesive labels to the buttons on a reasonable number of the tape players to facilitate their use by individuals who are blind. Similarly, a hotel conference center may need to provide permanent or portable assistive listening systems for persons with hearing impairments.

As provided in § 36.303(f), a public accommodation is not required to provide any particular aid or service that would result either in a fundamental alteration in the nature of the goods, services, facilities, privileges, advantages, or accommodations offered or in an undue burden. Both of these statutory limitations are derived from existing regulations and caselaw under section 504 and are to be applied on a case-by-case basis (see, e.g., 28 CFR 39.160(d) and *Southeastern Community College v. Davis*, 442 U.S. 397 (1979)). Congress intended that "undue burden" under § 36.303 and "undue hardship," which is used in the employment provisions of title I of the ADA, should be determined on a case-by-case basis under the same standards and in light of the same factors (Judiciary report at 59). The rule, therefore, in accordance with the definition of undue hardship in

section 101(10) of the ADA, defines undue burden as "significant difficulty or expense" (see §§ 36.104 and 36.303(a)) and requires that undue burden be determined in light of the factors listed in the definition in 36.104.

Consistent with regulations implementing section 504 in federally conducted programs (see, e.g., 28 CFR 39.160(d)), § 36.303(f) provides that the fact that the provision of a particular auxiliary aid or service would result in an undue burden does not relieve a public accommodation from the duty to furnish an alternative auxiliary aid or service, if available, that would not result in such a burden.

Section 36.303(g) of the proposed rule has been deleted from this section and included in a new § 36.306. That new section continues to make clear that the auxiliary aids requirement does not mandate the provision of individually prescribed devices, such as prescription eyeglasses or hearing aids.

The costs of compliance with the requirements of this section may not be financed by surcharges limited to particular individuals with disabilities or any group of individuals with disabilities (§ 36.301(c)).

Section 36.304 Removal of Barriers

Section 36.304 requires the removal of architectural barriers and communication barriers that are structural in nature in existing facilities, where such removal is readily achievable, i.e., easily accomplishable and able to be carried out without much difficulty or expense. This requirement is based on section 302(b)(2)(A)(iv) of the ADA.

A number of commenters interpreted the phrase "communication barriers that are structural in nature" broadly to encompass the provision of communications devices such as TDD's, telephone handset amplifiers, assistive listening devices, and digital check-out displays. The statute, however, as read by the Department, limits the application of the phrase "communications barriers that are structural in nature" to those barriers that are an integral part of the physical structure of a facility. In addition to the communications barriers posed by permanent signage and alarm systems noted by Congress (see Education and Labor report at 110), the Department would also include among the communications barriers covered by § 36.304 the failure to provide adequate sound buffers, and the presence of physical partitions that hamper the passage of sound waves between employees and customers. Given that § 36.304's proper focus is on the removal

of physical barriers, the Department believes that the obligation to provide communications equipment and devices such as TDD's, telephone handset amplifiers, assistive listening devices, and digital check-out displays is more appropriately determined by the requirements for auxiliary aids and services under § 36.303 (see Education and Labor report at 107-108). The obligation to remove communications barriers that are structural in nature under § 36.304, of course, is independent of any obligation to provide auxiliary aids and services under § 36.303.

The statutory provision also requires the readily achievable removal of certain barriers in existing vehicles and rail passenger cars. This transportation requirement is not included in § 36.304, but rather in § 36.310(b) of the rule.

In striking a balance between guaranteeing access to individuals with disabilities and recognizing the legitimate cost concerns of businesses and other private entities, the ADA establishes different standards for existing facilities and new construction. In existing facilities, which are the subject of § 36.304, where retrofitting may prove costly, a less rigorous degree of accessibility is required than in the case of new construction and alterations (see §§ 36.401-36.406) where accessibility can be more conveniently and economically incorporated in the initial stages of design and construction.

For example, a bank with existing automatic teller machines (ATM's) would have to remove barriers to the use of the ATM's, if it is readily achievable to do so. Whether or not it is necessary to take actions such as ramping a few steps or raising or lowering an ATM would be determined by whether the actions can be accomplished easily and without much difficulty or expense.

On the other hand, a newly constructed bank with ATM's would be required by § 36.401 to have an ATM that is "readily accessible to and usable by" persons with disabilities in accordance with accessibility guidelines incorporated under § 36.406.

The requirement to remove architectural barriers includes the removal of physical barriers of any kind. For example, § 36.304 requires the removal, when readily achievable, of barriers caused by the location of temporary or movable structures, such as furniture, equipment, and display racks. In order to provide access to individuals who use wheelchairs, for example, restaurants may need to rearrange tables and chairs, and department stores may need to reconfigure display racks and shelves.

As stated in § 36.304(f), such actions are not readily achievable to the extent that they would result in a significant loss of selling or serving space. If the widening of all aisles in selling or serving areas is not readily achievable, then selected widening should be undertaken to maximize the amount of merchandise or the number of tables accessible to individuals who use wheelchairs. Access to goods and services provided in any remaining inaccessible areas must be made available through alternative methods to barrier removal, as required by § 36.305.

Because the purpose of title III of the ADA is to ensure that public accommodations are accessible to their customers, clients, or patrons (as opposed to their employees, who are the focus of title I), the obligation to remove barriers under § 36.304 does not extend to areas of a facility that are used exclusively as employee work areas.

Section 36.304(b) provides a wide-ranging list of the types of modest measures that may be taken to remove barriers and that are likely to be readily achievable. The list includes examples of measures, such as adding raised letter markings on elevator control buttons and installing flashing alarm lights, that would be used to remove communications barriers that are structural in nature. It is not an exhaustive list, but merely an illustrative one. Moreover, the inclusion of a measure on this list does not mean that it is readily achievable in all cases. Whether or not any of these measures is readily achievable is to be determined on a case-by-case basis in light of the particular circumstances presented and the factors listed in the definition of readily achievable (§ 36.104).

A public accommodation generally would not be required to remove a barrier to physical access posed by a flight of steps, if removal would require extensive ramping or an elevator. Ramping a single step, however, will likely be readily achievable, and ramping several steps will in many circumstances also be readily achievable. The readily achievable standard does not require barrier removal that requires extensive restructuring or burdensome expense. Thus, where it is not readily achievable to do, the ADA would not require a restaurant to provide access to a restroom reachable only by a flight of stairs.

Like § 36.405, this section permits deference to the national interest in preserving significant historic structures. Barrier removal would not be considered "readily achievable" if it

would threaten or destroy the historic significance of a building or facility that is eligible for listing in the National Register of Historic Places under the National Historic Preservation Act (16 U.S.C. 470, *et seq.*), or is designated as historic under State or local law.

The readily achievable defense requires a less demanding level of exertion by a public accommodation than does the undue burden defense to the auxiliary aids requirements of § 36.303. In that sense, it can be characterized as a "lower" standard than the undue burden standard. The readily achievable defense is also less demanding than the undue hardship defense in section 102(b)(5) of the ADA, which limits the obligation to make reasonable accommodation in employment. Barrier removal measures that are not easily accomplishable and are not able to be carried out without much difficulty or expense are not required under the readily achievable standard, even if they do not impose an undue burden or an undue hardship.

Section 36.304(f)(1) of the proposed rule, which stated that "barrier removal is not readily achievable if it would result in significant loss of profit or significant loss of efficiency of operation," has been deleted from the final rule. Many commenters objected to this provision because it impermissibly introduced the notion of profit into a statutory standard that did not include it. Concern was expressed that, in order for an action not to be considered readily achievable, a public accommodation would inappropriately have to show, for example, not only that the action could not be done without "much difficulty or expense", but that a significant loss of profit would result as well. In addition, some commenters asserted use of the word "significant," which is used in the definition of undue hardship under title I (the standard for interpreting the meaning of undue burden as a defense to title III's auxiliary aids requirements) (see §§ 36.104, 36.303(f)), blurs the fact that the readily achievable standard requires a lower level of effort on the part of a public accommodation than does the undue burden standard.

The obligation to engage in readily achievable barrier removal is a continuing one. Over time, barrier removal that initially was not readily achievable may later be required because of changed circumstances. Many commenters expressed support for the Department's position that the obligation to comply with § 36.304 is continuing in nature. Some urged that the rule require public accommodations

to assess their compliance on at least an annual basis in light of changes in resources and other factors that would be relevant to determining what barrier removal measures would be readily achievable.

Although the obligation to engage in readily achievable barrier removal is clearly a continuing duty, the Department has declined to establish any independent requirement for an annual assessment or self-evaluation. It is best left to the public accommodations subject to § 36.304 to establish policies to assess compliance that are appropriate to the particular circumstances faced by the wide range of public accommodations covered by the ADA. However, even in the absence of an explicit regulatory requirement for periodic self-evaluations, the Department still urges public accommodations to establish procedures for an ongoing assessment of their compliance with the ADA's barrier removal requirements. The Department recommends that this process include appropriate consultation with individuals with disabilities or organizations representing them. A serious effort at self-assessment and consultation can diminish the threat of litigation and save resources by identifying the most efficient means of providing required access.

The Department has been asked for guidance on the best means for public accommodations to comply voluntarily with this section. Such information is more appropriately part of the Department's technical assistance effort and will be forthcoming over the next several months. The Department recommends, however, the development of an implementation plan designed to achieve compliance with the ADA's barrier removal requirements before they become effective on January 26, 1992. Such a plan, if appropriately designed and diligently executed, could serve as evidence of a good faith effort to comply with the requirements of § 36.104. In developing an implementation plan for readily achievable barrier removal, a public accommodation should consult with local organizations representing persons with disabilities and solicit their suggestions for cost-effective means of making individual places of public accommodation accessible. Such organizations may also be helpful in allocating scarce resources and establishing priorities. Local associations of businesses may want to encourage this process and serve as the forum for discussions on the local level

between disability rights organizations and local businesses.

Section 36.304(c) recommends priorities for public accommodations in removing barriers in existing facilities. Because the resources available for barrier removal may not be adequate to remove all existing barriers at any given time, § 36.304(c) suggests priorities for determining which types of barriers should be mitigated or eliminated first. The purpose of these priorities is to facilitate long-term business planning and to maximize, in light of limited resources, the degree of effective access that will result from any given level of expenditure.

Although many commenters expressed support for the concept of establishing priorities, a significant number objected to their mandatory nature in the proposed rule. The Department shares the concern of these commenters that mandatory priorities would increase the likelihood of litigation and inappropriately reduce the discretion of public accommodations to determine the most effective mix of barrier removal measures to undertake in particular circumstances. Therefore, in the final rule the priorities are no longer mandatory.

In response to comments that the priorities failed to address communications issues, the Department wishes to emphasize that the priorities encompass the removal of communications barriers that are structural in nature. It would be counter to the ADA's carefully wrought statutory scheme to include in this provision the wide range of communication devices that are required by the ADA's provisions on auxiliary aids and services. The final rule explicitly includes Brailled and raised letter signage and visual alarms among the examples of steps to remove barriers provided in § 36.304(c)(2).

Section 36.304(c)(1) places the highest priority on measures that will enable individuals with disabilities to physically enter a place of public accommodation. This priority on "getting through the door" recognizes that providing actual physical access to a facility from public sidewalks, public transportation, or parking is generally preferable to any alternative arrangements in terms of both business efficiency and the dignity of individuals with disabilities.

The next priority, which is established in § 36.304(c)(2), is for measures that provide access to those areas of a place of public accommodation where goods and services are made available to the public. For example, in a hardware

store, to the extent that it is readily achievable to do so, individuals with disabilities should be given access not only to assistance at the front desk, but also access, like that available to other customers, to the retail display areas of the store.

The Department agrees with those commenters who argued that access to the areas where goods and services are provided is generally more important than the provision of restrooms. Therefore, the final rule reverses priorities two and three of the proposed rule in order to give lower priority to accessible restrooms. Consequently, the third priority in the final rule (§ 36.304(c)(3)) is for measures to provide access to restroom facilities and the last priority is placed on any remaining measures required to remove barriers.

Section 36.304(d) requires that measures taken to remove barriers under § 36.304 be subject to subpart D's requirements for alterations (except for the path of travel requirements in § 36.403). It only permits deviations from the subpart D requirements when compliance with those requirements is not readily achievable. In such cases, § 36.304(d) permits measures to be taken that do not fully comply with the subpart D requirements, so long as the measures do not pose a significant risk to the health or safety of individuals with disabilities or others.

This approach represents a change from the proposed rule which stated that "readily achievable" measures taken solely to remove barriers under § 36.304 are exempt from the alterations requirements of subpart D. The intent of the proposed rule was to maximize the flexibility of public accommodations in undertaking barrier removal by allowing deviations from the technical standards of subpart D. It was thought that allowing slight deviations would provide access and release additional resources for expanding the amount of barrier removal that could be obtained under the readily achievable standard.

Many commenters, however, representing both businesses and individuals with disabilities, questioned this approach because of the likelihood that unsafe or ineffective measures would be taken in the absence of the subpart D standards for alterations as a reference point. Some advocated a rule requiring strict compliance with the subpart D standard.

The Department in the final rule has adopted the view of many commenters that (1) public accommodations should in the first instance be required to comply with the subpart D standards for alterations where it is readily

achievable to do so and (2) safe, readily achievable measures must be taken when compliance with the subpart D standards is not readily achievable. Reference to the subpart D standards in this manner will promote certainty and good design at the same time that permitting slight deviations will expand the amount of barrier removal that may be achieved under § 36.304.

Because of the inconvenience to individuals with disabilities and the safety problems involved in the use of portable ramps, § 36.304(e) permits the use of a portable ramp to comply with § 36.304(a) only when installation of a permanent ramp is not readily achievable. In order to promote safety, § 36.304(e) requires that due consideration be given to the incorporation of features such as nonslip surfaces, railings, anchoring, and strength of materials in any portable ramp that is used.

Temporary facilities brought in for use at the site of a natural disaster are subject to the barrier removal requirements of § 36.304.

A number of commenters requested clarification regarding how to determine when a public accommodation has discharged its obligation to remove barriers in existing facilities. For example, is a hotel required by § 36.304 to remove barriers in all of its guest rooms? Or is some lesser percentage adequate? A new paragraph (g) has been added to § 36.304 to address this issue. The Department believes that the degree of barrier removal required under § 36.304 may be less, but certainly would not be required to exceed, the standards for alterations under the ADA Accessibility Guidelines incorporated by subpart D of this part (ADAAG). The ADA's requirements for readily achievable barrier removal in existing facilities are intended to be substantially less rigorous than those for new construction and alterations. It, therefore, would be obviously inappropriate to require actions under § 36.304 that would exceed the ADAAG requirements. Hotels, then, in order to satisfy the requirements of § 36.304, would not be required to remove barriers in a higher percentage of rooms than required by ADAAG. If relevant standards for alterations are not provided in ADAAG, then reference should be made to the standards for new construction.

Section 36.305 Alternatives to Barrier Removal

Section 36.305 specifies that where a public accommodation can demonstrate that removal of a barrier is not readily achievable, the public accommodation

must make its goods, services, facilities, privileges, advantages, or accommodations available through alternative methods, if such methods are readily achievable. This requirement is based on section 302(b)(2)(A)(v) of the ADA.

For example, if it is not readily achievable for a retail store to raise, lower, or remove shelves or to rearrange display racks to provide accessible aisles, the store must, if readily achievable, provide a clerk or take other alternative measures to retrieve inaccessible merchandise. Similarly, if it is not readily achievable to ramp a long flight of stairs leading to the front door of a restaurant or a pharmacy, the restaurant or the pharmacy must take alternative measures, if readily achievable, such as providing curb service or home delivery. If, within a restaurant, it is not readily achievable to remove physical barriers to a certain section of a restaurant, the restaurant must, where it is readily achievable to do so, offer the same menu in an accessible area of the restaurant.

Where alternative methods are used to provide access, a public accommodation may not charge an individual with a disability for the costs associated with the alternative method (see § 36.301(c)). Further analysis of the issue of charging for alternative measures may be found in the preamble discussion of § 36.301(c).

In some circumstances, because of security considerations, some alternative methods may not be readily achievable. The rule does not require a cashier to leave his or her post to retrieve items for individuals with disabilities, if there are no other employees on duty.

Section 36.305(c) of the proposed rule has been deleted and the requirements have been included in a new § 36.306. That section makes clear that the alternative methods requirement does not mandate the provision of personal devices, such as wheelchairs, or services of a personal nature.

In the final rule, § 36.305(c) provides specific requirements regarding alternatives to barrier removal in multiscreen cinemas. In some situations, it may not be readily achievable to remove enough barriers to provide access to all of the theaters of a multiscreen cinema. If that is the case, § 36.305(c) requires the cinema to establish a film rotation schedule that provides reasonable access for individuals who use wheelchairs to films being presented by the cinema. It further requires that reasonable notice be provided to the public as to the

location and time of accessible showings. Methods for providing notice include appropriate use of the international accessibility symbol in a cinema's print advertising and the addition of accessibility information to a cinema's recorded telephone information line.

Section 36.306 Personal Devices and Services

The final rule includes a new § 36.306, entitled "Personal devices and services." Section 36.306 of the proposed rule, "Readily achievable and undue burden: Factors to be considered," was deleted for the reasons described in the preamble discussion of the definition of the term "readily achievable" in § 36.104. In place of §§ 36.303(g) and 36.305(c) of the proposed rule, which addressed the issue of personal devices and services in the contexts of auxiliary aids and alternatives to barrier removal, § 36.306 provides a general statement that the regulation does not require the provision of personal devices and services. This section states that a public accommodation is not required to provide its customers, clients, or participants with personal devices, such as wheelchairs; individually prescribed devices, such as prescription eyeglasses or hearing aids; or services of a personal nature including assistance in eating, toileting, or dressing.

This statement serves as a limitation on all the requirements of the regulation. The personal devices and services limitation was intended to have general application in the proposed rule in all contexts where it was relevant. The final rule, therefore, clarifies, this point by including a general provision that will explicitly apply not just to auxiliary aids and services and alternatives to barrier removal, but across-the-board to include such relevant areas as modifications in policies, practices, and procedures (§ 36.302) and examinations and courses (§ 36.309), as well.

The Department wishes to clarify that measures taken as alternatives to barrier removal, such as retrieving items from shelves or providing curb service or home delivery, are not to be considered personal services. Similarly, minimal actions that may be required as modifications in policies, practices, or procedures under § 36.302, such as a waiter's removing the cover from a customer's straw, a kitchen's cutting up food into smaller pieces, or a bank's filling out a deposit slip, are not services of a personal nature within the meaning of § 36.306. (Of course, such modifications may be required under § 36.302 only if they are "reasonable.") Similarly, this section does not preclude

the short-term loan of personal receivers that are part of an assistive listening system.

Of course, if personal services are customarily provided to the customers or clients of a public accommodation, e.g., in a hospital or senior citizen center, then these personal services should also be provided to persons with disabilities using the public accommodation.

Section 36.307 Accessible or Special Goods

Section 36.307 establishes that the rule does not require a public accommodation to alter its inventory to include accessible or special goods with accessibility features that are designed for, or facilitate use by, individuals with disabilities. As specified in § 36.307(c), accessible or special goods include such items as Brailled versions of books, books on audio-cassettes, closed captioned video tapes, special sizes or lines of clothing, and special foods to meet particular dietary needs.

The purpose of the ADA's public accommodations requirements is to ensure accessibility to the goods offered by a public accommodation, not to alter the nature or mix of goods that the public accommodation has typically provided. In other words, a bookstore, for example, must make its facilities and sales operations accessible to individuals with disabilities, but is not required to stock Brailled or large print books. Similarly, a video store must make its facilities and rental operations accessible, but is not required to stock closed-captioned video tapes. The Department has been made aware, however, that the most recent titles in video-tape rental establishments are, in fact, closed captioned.

Although a public accommodation is not required by § 36.307(a) to modify its inventory, it is required by § 36.307(b), at the request of an individual with disabilities, to order accessible or special goods that it does not customarily maintain in stock if, in the normal course of its operation, it makes special orders for unstocked goods, and if the accessible or special goods can be obtained from a supplier with whom the public accommodation customarily does business. For example, a clothing store would be required to order specially-sized clothing at the request of an individual with a disability, if it customarily makes special orders for clothing that it does not keep in stock, and if the clothing can be obtained from one of the store's customary suppliers.

One commenter asserted that the proposed rule could be interpreted to require a store to special order

accessible or special goods of all types, even if only one type is specially ordered in the normal course of its business. The Department, however, intends for § 36.307(b) to require special orders only of those particular types of goods for which a public accommodation normally makes special orders. For example, a book and recording store would not have to specially order Brailled books if, in the normal course of its business, it only specially orders recordings and not books.

Section 36.308 Seating in Assembly Areas

Section 36.308 establishes specific requirements for removing barriers to physical access in assembly areas, which include such facilities as theaters, concert halls, auditoriums, lecture halls, and conference rooms. This section does not address the provision of auxiliary aids or the removal of communications barriers that are structural in nature. These communications requirements are the focus of other provisions of the regulation (see §§ 36.303-36.304).

Individuals who use wheelchairs historically have been relegated to inferior seating in the back of assembly areas separate from accompanying family members and friends. The provisions of § 36.308 are intended to promote integration and equality in seating.

In some instances it may not be readily achievable for auditoriums or theaters to remove seats to allow individuals with wheelchairs to sit next to accompanying family members or friends. In these situations, the final rule retains the requirement that the public accommodation provide portable chairs or other means to allow the accompanying individuals to sit with the persons in wheelchairs. Persons in wheelchairs should have the same opportunity to enjoy movies, plays, and similar events with their families and friends, just as other patrons do. The final rule specifies that portable chairs or other means to permit family members or companions to sit with individuals who use wheelchairs must be provided only when it is readily achievable to do so.

In order to facilitate seating of wheelchair users who wish to transfer to existing seating, paragraph (a)(1) of the final rule adds a requirement that, to the extent readily achievable, a reasonable number of seats with removable aisle-side armrests must be provided. Many persons in wheelchairs are able to transfer to existing seating with this relatively minor modification. This

solution avoids the potential safety hazard created by the use of portable chairs and fosters integration. The final ADA Accessibility Guidelines incorporated by subpart D (ADAAG) also add a requirement regarding aisle seating that was not in the proposed guidelines. In situations when a person in a wheelchair transfers to existing seating, the public accommodation shall provide assistance in handling the wheelchair of the patron with the disability.

Likewise, consistent with ADAAG, the final rule adds in § 36.308(a)(1)(ii)(B) a requirement that, to the extent readily achievable, wheelchair seating provide lines of sight and choice of admission prices comparable to those for members of the general public.

Finally, because Congress intended that the requirements for barrier removal in existing facilities be substantially less rigorous than those required for new construction and alterations, the final rule clarifies in § 36.308(a)(3) that in no event can the requirements for existing facilities be interpreted to exceed the standards for alterations under ADAAG. For example, § 4.33 of ADAAG only requires wheelchair spaces to be provided in more than one location when the seating capacity of the assembly area exceeds 300. Therefore, paragraph (a) of § 36.308 may not be interpreted to require readily achievable dispersal of wheelchair seating in assembly areas with 300 or fewer seats. Similarly, § 4.1.3(19) of ADAAG requires six accessible wheelchair locations in an assembly area with 301 to 500 seats. The reasonable number of wheelchair locations required by paragraph (a), therefore, may be less than six, but may not be interpreted to exceed six.

Proposed Section 36.309 Purchase of Furniture and Equipment

Section 36.309 of the proposed rule would have required that newly purchased furniture or equipment made available for use at a place of public accommodation be accessible, to the extent such furniture or equipment is available, unless this requirement would fundamentally alter the goods, services, facilities, privileges, advantages, or accommodations offered, or would not be readily achievable. Proposed § 36.309 has been omitted from the final rule because the Department has determined that its requirements are more properly addressed under other sections, and because there are currently no appropriate accessibility standards addressing many types of furniture and equipment.

Some types of equipment will be required to meet the accessibility requirements of subpart D. For example, ADAAG establishes technical and scoping requirements in new construction and alterations for automated teller machines and telephones. Purchase or modification of equipment is required in certain instances by the provisions in §§ 36.201 and 36.202. For example, an arcade may need to provide accessible video machines in order to ensure full and equal enjoyment of the facilities and to provide an opportunity to participate in the services and facilities it provides. The barrier removal requirements of § 36.304 will apply as well to furniture and equipment (lowering shelves, rearranging furniture, adding Braille labels to a vending machine).

Section 36.309 Examinations and Courses

Section 36.309(a) sets forth the general rule that any private entity that offers examinations or courses related to applications, licensing, certification, or credentialing for secondary or postsecondary education, professional, or trade purposes shall offer such examinations or courses in a place and manner accessible to persons with disabilities or offer alternative accessible arrangements for such individuals.

Paragraph (a) restates section 309 of the Americans with Disabilities Act. Section 309 is intended to fill the gap that is created when licensing, certification, and other testing authorities are not covered by section 504 of the Rehabilitation Act or title II of the ADA. Any such authority that is covered by section 504, because of the receipt of Federal money, or by title II, because it is a function of a State or local government, must make all of its programs accessible to persons with disabilities, which includes physical access as well as modifications in the way the test is administered, e.g., extended time, written instructions, or assistance of a reader.

Many licensing, certification, and testing authorities are not covered by section 504, because no Federal money is received; nor are they covered by title II of the ADA because they are not State or local agencies. However, States often require the licenses provided by such authorities in order for an individual to practice a particular profession or trade. Thus, the provision was included in the ADA in order to assure that persons with disabilities are not foreclosed from educational, professional, or trade opportunities because an examination or course is conducted in an

inaccessible site or without needed modifications.

As indicated in the "Application" section of this part (§ 36.102), § 36.309 applies to any private entity that offers the specified types of examinations or courses. This is consistent with section 309 of the Americans with Disabilities Act, which states that the requirements apply to "any person" offering examinations or courses.

The Department received a large number of comments on this section, reflecting the importance of ensuring that the key gateways to education and employment are open to individuals with disabilities. The most frequent comments were objections to the fundamental alteration and undue burden provisions in §§ 36.309 (b)(3) and (c)(3) and to allowing courses and examinations to be provided through alternative accessible arrangements, rather than in an integrated setting.

Although section 309 of the Act does not refer to a fundamental alteration or undue burden limitation, those limitations do appear in section 302(b)(2)(A)(iii) of the Act, which establishes the obligation of public accommodations to provide auxiliary aids and services. The Department, therefore, included it in the paragraphs of § 36.309 requiring the provision of auxiliary aids. One commenter argued that similar limitations should apply to all of the requirements of § 36.309, but the Department did not consider this extension appropriate.

Commenters who objected to permitting "alternative accessible arrangements" argued that such arrangements allow segregation and should not be permitted, unless they are the least restrictive available alternative, for example, for someone who cannot leave home. Some commenters made a distinction between courses, where interaction is an important part of the educational experience, and examinations, where it may be less important. Because the statute specifically authorizes alternative accessible arrangements as a method of meeting the requirements of section 309, the Department has not adopted this suggestion. The Department notes, however, that, while examinations of the type covered by § 36.309 may not be covered elsewhere in the regulation, courses will generally be offered in a "place of education," which is included in the definition of "place of public accommodation" in § 36.104, and, therefore, will be subject to the integrated setting requirement of § 36.203.

Section 36.309(b) sets forth specific requirements for examinations. Examinations covered by this section would include a bar exam or the Scholastic Aptitude Test prepared by the Educational Testing Service. Paragraph (b)(1) is adopted from the Department of Education's section 504 regulation on admission tests to postsecondary educational programs (34 CFR 104.42(b)(3)). Paragraph (b)(1)(i) requires that a private entity offering an examination covered by the section must assure that the examination is selected and administered so as to best ensure that the examination accurately reflects an individual's aptitude or achievement level or other factor the examination purports to measure, rather than reflecting the individual's impaired sensory, manual, or speaking skills (except where those skills are the factors that the examination purports to measure).

Paragraph (b)(1)(ii) requires that any examination specially designed for individuals with disabilities be offered as often and in as timely a manner as other examinations. Some commenters noted that persons with disabilities may be required to travel long distances when the locations for examinations for individuals with disabilities are limited, for example, to only one city in a State instead of a variety of cities. The Department has therefore revised this paragraph to add a requirement that such examinations be offered at locations that are as convenient as the location of other examinations.

Commenters representing organizations that administer tests wanted to be able to require individuals with disabilities to provide advance notice and appropriate documentation, at the applicants' expense, of their disabilities and of any modifications or aids that would be required. The Department agrees that such requirements are permissible, provided that they are not unreasonable and that the deadline for such notice is no earlier than the deadline for others applying to take the examination. Requiring individuals with disabilities to file earlier applications would violate the requirement that examinations designed for individuals with disabilities be offered in as timely a manner as other examinations.

Examiners may require evidence that an applicant is entitled to modifications or aids as required by this section, but requests for documentation must be reasonable and must be limited to the need for the modification or aid requested. Appropriate documentation might include a letter from a physician

or other professional, or evidence of a prior diagnosis or accommodation, such as eligibility for a special education program. The applicant may be required to bear the cost of providing such documentation, but the entity administering the examination cannot charge the applicant for the cost of any modifications or auxiliary aids, such as interpreters, provided for the examination.

Paragraph (b)(1)(iii) requires that examinations be administered in facilities that are accessible to individuals with disabilities or alternative accessible arrangements are made.

Paragraph (b)(2) gives examples of modifications to examinations that may be necessary in order to comply with this section. These may include providing more time for completion of the examination or a change in the manner of giving the examination, e.g., reading the examination to the individual.

Paragraph (b)(3) requires the provision of auxiliary aids and services, unless the private entity offering the examination can demonstrate that offering a particular auxiliary aid would fundamentally alter the examination or result in an undue burden. Examples of auxiliary aids include taped examinations, interpreters or other effective methods of making aurally delivered materials available to individuals with hearing impairments, readers for individuals with visual impairments or learning disabilities, and other similar services and actions. The suggestion that individuals with learning disabilities may need readers is included, although it does not appear in the Department of Education regulation, because, in fact, some individuals with learning disabilities have visual perception problems and would benefit from a reader.

Many commenters pointed out the importance of ensuring that modifications provide the individual with a disability an equal opportunity to demonstrate his or her knowledge or ability. For example, a reader who is unskilled or lacks knowledge of specific terminology used in the examination may be unable to convey the information in the questions or to follow the applicant's instructions effectively. Commenters pointed out that, for persons with visual impairments who read Braille, Braille provides the closest functional equivalent to a printed test. The Department has, therefore, added Brailled examinations to the examples of auxiliary aids and services that may be required. For similar reasons, the

Department also added to the list of examples of auxiliary aids and services large print examinations and answer sheets; "qualified" readers; and transcribers to write answers.

A commenter suggested that the phrase "fundamentally alter the examination" in this paragraph of the proposed rule be revised to more accurately reflect the function affected. In the final rule the Department has substituted the phrase "fundamentally alter the measurement of the skills or knowledge the examination is intended to test."

Paragraph (b)(4) gives examples of alternative accessible arrangements. For instance, the private entity might be required to provide the examination at an individual's home with a proctor. Alternative arrangements must provide conditions for individuals with disabilities that are comparable to the conditions under which other individuals take the examinations. In other words, an examination cannot be offered to an individual with a disability in a cold, poorly lit basement, if other individuals are given the examination in a warm, well lit classroom.

Some commenters who provide examinations for licensing or certification for particular occupations or professions urged that they be permitted to refuse to provide modifications or aids for persons seeking to take the examinations if those individuals, because of their disabilities, would be unable to perform the essential functions of the profession or occupation for which the examination is given, or unless the disability is reasonably determined in advance as not being an obstacle to certification. The Department has not changed its rule based on this comment. An examination is one stage of a licensing or certification process. An individual should not be barred from attempting to pass that stage of the process merely because he or she might be unable to meet other requirements of the process. If the examination is not the first stage of the qualification process, an applicant may be required to complete the earlier stages prior to being admitted to the examination. On the other hand, the applicant may not be denied admission to the examination on the basis of doubts about his or her abilities to meet requirements that the examination is not designed to test.

Paragraph (c) sets forth specific requirements for courses. Paragraph (c)(1) contains the general rule that any course covered by this section must be modified to ensure that the place and manner in which the course is given is

accessible. Paragraph (c)(2) gives examples of possible modifications that might be required, including extending the time permitted for completion of the course, permitting oral rather than written delivery of an assignment by a person with a visual impairment, or adapting the manner in which the course is conducted (i.e., providing cassettes of class handouts to an individual with a visual impairment). In response to comments, the Department has added to the examples in paragraph (c)(2) specific reference to distribution of course materials. If course materials are published and available from other sources, the entity offering the course may give advance notice of what materials will be used so as to allow an individual to obtain them in Braille or on tape but materials provided by the course offerer must be made available in alternative formats for individuals with disabilities.

In language similar to that of paragraph (b), paragraph (c)(3) requires auxiliary aids and services, unless a fundamental alteration or undue burden would result, and paragraph (c)(4) requires that courses be administered in accessible facilities. Paragraph (c)(5) gives examples of alternative accessible arrangements. These may include provision of the course through videotape, cassettes, or prepared notes. Alternative arrangements must provide comparable conditions to those provided to others, including similar lighting, room temperature, and the like. An entity offering a variety of courses, to fulfill continuing education requirements for a profession, for example, may not limit the selection or choice of courses available to individuals with disabilities.

Section 36.310 Transportation Provided by Public Accommodations

Section 36.310 contains specific provisions relating to public accommodations that provide transportation to their clients or customers. This section has been substantially revised in order to coordinate the requirements of this section with the requirements applicable to these transportation systems that will be contained in the regulations issued by the Secretary of Transportation pursuant to section 306 of the ADA, to be codified at 49 CFR part 37. The Department notes that, although the responsibility for issuing regulations applicable to transportation systems operated by public accommodations is divided between this Department and the Department of Transportation, enforcement authority is assigned only to the Department of Justice.

The Department received relatively few comments on this section of the proposed rule. Most of the comments addressed issues that are not specifically addressed in this part, such as the standards for accessible vehicles and the procedure for determining whether equivalent service is provided. Those standards will be contained in the regulation issued by the Department of Transportation. Other commenters raised questions about the types of transportation that will be subject to this section. In response to these inquiries, the Department has revised the list of examples contained in the regulation.

Paragraph (a)(1) states the general rule that covered public accommodations are subject to all of the specific provisions of subparts B, C, and D, except as provided in § 36.310. Examples of operations covered by the requirements are listed in paragraph (a)(2). The stated examples include hotel and motel airport shuttle services, customer shuttle bus services operated by private companies and shopping centers, student transportation, and shuttle operations of recreational facilities such as stadiums, zoos, amusement parks, and ski resorts. This brief list is not exhaustive. The section applies to any fixed route or demand responsive transportation system operated by a public accommodation for the benefit of its clients or customers. The section does not apply to transportation services provided only to employees. Employee transportation will be subject to the regulations issued by the Equal Employment Opportunity Commission to implement title I of the Act. However, if employees and customers or clients are served by the same transportation system, the provisions of this section will apply.

Paragraph (b) specifically provides that a public accommodation shall remove transportation barriers in existing vehicles to the extent that it is readily achievable to do so, but that the installation of hydraulic or other lifts is not required.

Paragraph (c) provides that public accommodations subject to this section shall comply with the requirements for transportation vehicles and systems contained in the regulations issued by the Secretary of Transportation.

Subpart D—New Construction and Alterations

Subpart D implements section 303 of the Act, which requires that newly constructed or altered places of public accommodation or commercial facilities be readily accessible to and usable by individuals with disabilities. This

requirement contemplates a high degree of convenient access. It is intended to ensure that patrons and employees of places of public accommodation and employees of commercial facilities are able to get to, enter, and use the facility.

Potential patrons of places of public accommodation, such as retail establishments, should be able to get to a store, get into the store, and get to the areas where goods are being provided. Employees should have the same types of access, although those individuals require access to and around the employment area as well as to the area in which goods and services are provided.

The ADA is geared to the future—its goal being that, over time, access will be the rule, rather than the exception. Thus, the Act only requires modest expenditures, of the type addressed in § 36.304 of this part, to provide access to existing facilities not otherwise being altered, but requires all new construction and alterations to be accessible.

The Act does not require new construction or alterations; it simply requires that, when a public accommodation or other private entity undertakes the construction or alteration of a facility subject to the Act, the newly constructed or altered facility must be made accessible. This subpart establishes the requirements for new construction and alterations.

As explained under the discussion of the definition of "facility," § 36.104, pending development of specific requirements, the Department will not apply this subpart to places of public accommodation located in mobile units, boats, or other conveyances.

Section 36.401 New Construction General

Section 36.401 implements the new construction requirements of the ADA. Section 303 (a)(1) of the Act provides that discrimination for purposes of section 302(a) of the Act includes a failure to design and construct facilities for first occupancy later than 30 months after the date of enactment (i.e., after January 26, 1993) that are readily accessible to and usable by individuals with disabilities.

Paragraph 36.401(a)(1) restates the general requirement for accessible new construction. The proposed rule stated that "any public accommodation or other private entity responsible for design and construction" must ensure that facilities conform to this requirement. Various commenters suggested that the proposed language

was not consistent with the statute because it substituted "private entity responsible for design and construction" for the statutory language; because it did not address liability on the part of architects, contractors, developers, tenants, owners, and other entities; and because it limited the liability of entities responsible for commercial facilities. In response, the Department has revised this paragraph to repeat the language of section 303(a) of the ADA. The Department will interpret this section in a manner consistent with the intent of the statute and with the nature of the responsibilities of the various entities for design, for construction, or for both.

Designed and Constructed for First Occupancy

According to paragraph (a)(2), a facility is subject to the new construction requirements only if a completed application for a building permit or permit extension is filed after January 26, 1992, and the facility is occupied after January 26, 1993.

The proposed rule set forth for comment two alternative ways by which to determine what facilities are subject to the Act and what standards apply. Paragraph (a)(2) of the final rule is a slight variation on Option One in the proposed rule. The reasons for the Department's choice of Option One are discussed later in this section.

Paragraph (a)(2) acknowledges that Congress did not contemplate having actual occupancy be the sole trigger for the accessibility requirements, because the statute prohibits a failure to "design and construct for first occupancy," rather than requiring accessibility in facilities actually occupied after a particular date.

The commenters overwhelmingly agreed with the Department's proposal to use a date certain; many cited the reasons given in the preamble to the proposed rule. First, it is helpful for designers and builders to have a fixed date for accessible design, so that they can determine accessibility requirements early in the planning and design stage. It is difficult to determine accessibility requirements in anticipation of the actual date of first occupancy because of unpredictable and uncontrollable events (e.g., strikes affecting suppliers or labor, or natural disasters) that may delay occupancy. To redesign or reconstruct portions of a facility if it begins to appear that occupancy will be later than anticipated would be quite costly. A fixed date also assists those responsible for enforcing, or monitoring compliance with, the statute, and those protected by it.

The Department considered using as a trigger date for application of the accessibility standards the date on which a permit is granted. The Department chose instead the date on which a complete permit application is certified as received by the appropriate government entity. Almost all commenters agreed with this choice of a trigger date. This decision is based partly on information that several months or even years can pass between application for a permit and receipt of a permit. Design is virtually complete at the time an application is complete (i.e., certified to contain all the information required by the State, county, or local government). After an application is filed, delays may occur before the permit is granted due to numerous factors (not necessarily relating to accessibility): for example, hazardous waste discovered on the property, flood plain requirements, zoning disputes, or opposition to the project from various groups. These factors should not require redesign for accessibility if the application was completed before January 26, 1992. However, if the facility must be redesigned for other reasons, such as a change in density or environmental preservation, and the final permit is based on a new application, the rule would require accessibility if that application was certified complete after January 26, 1992.

The certification of receipt of a complete application for a building permit is an appropriate point in the process because certifications are issued in writing by governmental authorities. In addition, this approach presents a clear and objective standard.

However, a few commenters pointed out that in some jurisdictions it is not possible to receive a "certification" that an application is complete, and suggested that in those cases the fixed date should be the date on which an application for a permit is received by the government agency. The Department has included such a provision in § 36.401(a)(2)(i).

The date of January 26, 1992, is relevant only with respect to the last application for a permit or permit extension for a facility. Thus, if an entity has applied for only a "foundation" permit, the date of that permit application has no effect, because the entity must also apply for and receive a permit at a later date for the actual superstructure. In this case, it is the date of the later application that would control, unless construction is not completed within the time allowed by the permit, in which case a third permit would be issued and the date of the

application for that permit would be determinative for purposes of the rule.

Choice of Option One for Defining "Designed and Constructed for First Occupancy"

Under the option the Department has chosen for determining applicability of the new construction standards, a building would be considered to be "for first occupancy" after January 26, 1993, only (1) if the last application for a building permit or permit extension for the facility is certified to be complete (or, in some jurisdictions, received) by a State, county, or local government after January 26, 1992, and (2) if the first certificate of occupancy is issued after January 26, 1993. The Department also asked for comment on an Option Two, which would have imposed new construction requirements if a completed application for a building permit or permit extension was filed after the enactment of the ADA (July 26, 1990), and the facility was occupied after January 26, 1993.

The request for comment on this issue drew a large number of comments expressing a wide range of views. Most business groups and some disability rights groups favored Option One, and some business groups and most disability rights groups favored Option Two. Individuals and government entities were equally divided; several commenters proposed other options.

Those favoring Option One pointed out that it is more reasonable in that it allows time for those subject to the new construction requirements to anticipate those requirements and to receive technical assistance pursuant to the Act. Numerous commenters said that time frames for designing and constructing some types of facilities (for example, health care facilities) can range from two to four years or more. They expressed concerns that Option Two, which would apply to some facilities already under design or construction as of the date the Act was signed, and to some on which construction began shortly after enactment, could result in costly redesign or reconstruction of those facilities. In the same vein, some Option One supporters found Option Two objectionable on due process grounds. In their view, Option Two would mean that in July 1991 (upon issuance of the final DOJ rule) the responsible entities would learn that ADA standards had been in effect since July 26, 1990, and this would amount to retroactive application of standards. Numerous commenters characterized Option Two as having no support in the

statute and Option One as being more consistent with congressional intent.

Those who favored Option Two pointed out that it would include more facilities within the coverage of the new construction standards. They argued that because similar accessibility requirements are in effect under State laws, no hardship would be imposed by this option. Numerous commenters said that hardship would also be eliminated in light of their view that the ADA requires compliance with the Uniform Federal Accessibility Standards (UFAS) until issuance of DOJ standards. Those supporting Option Two claimed that it was more consistent with the statute and its legislative history.

The Department has chosen Option One rather than Option Two, primarily on the basis of the language of three relevant sections of the statute. First, section 303(a) requires compliance with accessibility standards set forth, or incorporated by reference in, regulations to be issued by the Department of Justice. Standing alone, this section cannot be read to require compliance with the Department's standards before those standards are issued (through this rulemaking). Second, according to section 310 of the statute, section 303 becomes effective on January 26, 1992. Thus, section 303 cannot impose requirements on the design of buildings before that date. Third, while section 306(d) of the Act requires compliance with UFAS if final regulations have not been issued, that provision cannot reasonably be read to take effect until July 26, 1991, the date by which the Department of Justice must issue final regulations under title III.

Option Two was based on the premise that the interim standards in section 306(d) take effect as of the ADA's enactment (July 26, 1990), rather than on the date by which the Department of Justice regulations are due to be issued (July 26, 1991). The initial clause of section 306(d)(1) itself is silent on this question:

If final regulations have not been issued pursuant to this section, for new construction for which a * * * building permit is obtained prior to the issuance of final regulations * * * (interim standards apply).

The approach in Option Two relies partly on the language of section 310 of the Act, which provides that section 306, the interim standards provision, takes effect on the date of enactment. Under this interpretation the interim standards provision would prevail over the operative provision, section 303, which requires that new construction be accessible and which becomes effective January 26, 1992. This approach would

also require construing the language of section 306(d)(1) to take effect before the Department's standards are due to be issued. The preferred reading of section 306 is that it would require that, if the Department's final standards had not been issued by July 26, 1991, UFAS would apply to certain buildings until such time as the Department's standards were issued.

General Substantive Requirements of the New Construction Provisions

The rule requires, as does the statute, that covered newly constructed facilities be readily accessible to and usable by individuals with disabilities. The phrase "readily accessible to and usable by individuals with disabilities" is a term that, in slightly varied formulations, has been used in the Architectural Barriers Act of 1968, the Fair Housing Act, the regulations implementing section 504 of the Rehabilitation Act of 1973, and current accessibility standards. It means, with respect to a facility or a portion of a facility, that it can be approached, entered, and used by individuals with disabilities (including mobility, sensory, and cognitive impairments) easily and conveniently. A facility that is constructed to meet the requirements of the rule's accessibility standards will be considered readily accessible and usable with respect to construction. To the extent that a particular type or element of a facility is not specifically addressed by the standards, the language of this section is the safest guide.

A private entity that renders an "accessible" building inaccessible in its operation, through policies or practices, may be in violation of section 302 of the Act. For example, a private entity can render an entrance to a facility inaccessible by keeping an accessible entrance open only during certain hours (whereas the facility is available to others for a greater length of time). A facility could similarly be rendered inaccessible if a person with disabilities is significantly limited in her or his choice of a range of accommodations.

Ensuring access to a newly constructed facility will include providing access to the facility from the street or parking lot, to the extent the responsible entity has control over the route from those locations. In some cases, the private entity will have no control over access at the point where streets, curbs, or sidewalks already exist, and in those instances the entity is encouraged to request modifications to a sidewalk, including installation of curb cuts, from a public entity responsible for them. However, as some commenters pointed out, there is no obligation for a

private entity subject to title III of the ADA to seek or ensure compliance by a public entity with title II. Thus, although a locality may have an obligation under title II of the Act to install curb cuts at a particular location, that responsibility is separate from the private entity's title III obligation, and any involvement by a private entity in seeking cooperation from a public entity is purely voluntary in this context.

Work Areas

Proposed paragraph 36.401(b) addressed access to employment areas, rather than to the areas where goods or services are being provided. The preamble noted that the proposed paragraph provided guidance for new construction and alterations until more specific guidance was issued by the ATBCB and reflected in this Department's regulation. The entire paragraph has been deleted from this section in the final rule. The concepts of paragraphs (b) (1), (2), and (5) of the proposed rule are included, with modifications and expansion, in ADAAG. Paragraphs (3) and (4) of the proposed rule, concerning fixtures and equipment, are not included in the rule or in ADAAG.

Some commenters asserted that questions relating to new construction and alterations of work areas should be addressed by the EEOC under title I, as employment concerns. However, the legislative history of the statute clearly indicates that the new construction and alterations requirements of title III were intended to ensure accessibility of new facilities to all individuals, including employees. The language of section 303 sweeps broadly in its application to all public accommodations and commercial facilities. EEOC's title I regulations will address accessibility requirements that come into play when "reasonable accommodation" to individual employees or applicants with disabilities is mandated under title I.

The issues dealt with in proposed § 36.401(b) (1) and (2) are now addressed in ADAAG section 4.1.1(3). The Department's proposed paragraphs would have required that areas that will be used only by employees as work stations be constructed so that individuals with disabilities could approach, enter, and exit the areas. They would not have required that all individual work stations be constructed or equipped (for example, with shelves that are accessible or adaptable) to be accessible. This approach was based on the theory that, as long as an employee with disabilities could enter the building and get to and around the employment

area, modifications in a particular work station could be instituted as a "reasonable accommodation" to that employee if the modifications were necessary and they did not constitute an undue hardship.

Almost all of the commenters agreed with the proposal to require access to a work area but not to require accessibility of each individual work station. This principle is included in ADAAG 4.1.1(3). Several of the comments related to the requirements of the proposed ADAAG and have been addressed in the accessibility standards.

Proposed paragraphs (b) (3) and (4) would have required that consideration be given to placing fixtures and equipment at accessible heights in the first instance, and to purchasing new equipment and fixtures that are adjustable. These paragraphs have not been included in the final rule because the rule in most instances does not establish accessibility standards for purchased equipment. (See discussion elsewhere in the preamble of proposed § 36.309.) While the Department encourages entities to consider providing accessible or adjustable fixtures and equipment for employees, this rule does not require them to do so.

Paragraph (b)(5) of proposed § 36.401 clarified that proposed paragraph (b) did not limit the requirement that employee areas other than individual work stations must be accessible. For example, areas that are employee "common use" areas and are not solely used as work stations (e.g., employee lounges, cafeterias, health units, exercise facilities) are treated no differently under this regulation than other parts of a building; they must be constructed or altered in compliance with the accessibility standards. This principle is not stated in § 36.401 but is implicit in the requirements of this section and ADAAG.

Commercial Facilities in Private Residences

Section 36.401(b) of the final rule is a new provision relating to commercial facilities located in private residences. The proposed rule addressed these requirements in the preamble to § 36.207, "Places of public accommodation located in private residences." The preamble stated that the approach for commercial facilities would be the same as that for places of public accommodation, i.e., those portions used exclusively as a commercial facility or used as both a commercial facility and for residential purposes would be covered. Because commercial facilities are only subject to new construction and alterations

requirements, however, the covered portions would only be subject to subpart D. This approach is reflected in § 36.401(b)(1).

The Department is aware that the statutory definition of "commercial facility" excludes private residences because they are "expressly exempted from coverage under the Fair Housing Act of 1968, as amended." However, the Department interprets that exemption as applying only to facilities that are exclusively residential. When a facility is used as both a residence and a commercial facility, the exemption does not apply.

Paragraph (b)(2) is similar to the new paragraph (b) under § 36.207, "Places of public accommodation located in private residences." The paragraph clarifies that the covered portion includes not only the space used as a commercial facility, but also the elements used to enter the commercial facility, e.g., the homeowner's front sidewalk, if any; the doorway; the hallways; the restroom, if used by employees or visitors of the commercial facility; and any other portion of the residence, interior or exterior, used by employees or visitors of the commercial facility.

As in the case of public accommodations located in private residences, the new construction standards only apply to the extent that a portion of the residence is designed or intended for use as a commercial facility. Likewise, if a homeowner alters a portion of his home to convert it to a commercial facility, that work must be done in compliance with the alterations standards in appendix A.

Structural Impracticability

Proposed § 36.401(c) is included in the final rule with minor changes. It details a statutory exception to the new construction requirement: the requirement that new construction be accessible does not apply where an entity can demonstrate that it is structurally impracticable to meet the requirements of the regulation. This provision is also included in ADAAG, at section 4.1.1(5)(a).

Consistent with the legislative history of the ADA, this narrow exception will apply only in rare and unusual circumstances where unique characteristics of terrain make accessibility unusually difficult. Such limitations for topographical problems are analogous to an acknowledged limitation in the application of the accessibility requirements of the Fair Housing Amendments Act (FHAA) of 1988.

Almost all commenters supported this interpretation. Two commenters argued that the DOJ requirement is too limiting and would not exempt some buildings that should be exempted because of soil conditions, terrain, and other unusual site conditions. These commenters suggested consistency with HUD's Fair Housing Accessibility Guidelines (50 FR 9472 (1991)), which generally would allow exceptions from accessibility requirements, or allow compliance with less stringent requirements, on sites with slopes exceeding 10%.

The Department is aware of the provisions in HUD's guidelines, which were issued on March 6, 1991, after passage of the ADA and publication of the Department's proposed rule. The approach taken in these guidelines, which apply to different types of construction and implement different statutory requirements for new construction, does not bind this Department in regulating under the ADA. The Department has included in the final rule the substance of the proposed provision, which is faithful to the intent of the statute, as expressed in the legislative history. (See Senate report at 70-71; Education and Labor report at 120.)

The limited structural impracticability exception means that it is acceptable to deviate from accessibility requirements only where unique characteristics of terrain prevent the incorporation of accessibility features and where providing accessibility would destroy the physical integrity of a facility. A situation in which a building must be built on stilts because of its location in marshlands or over water is an example of one of the few situations in which the exception for structural impracticability would apply.

This exception to accessibility requirements should not be applied to situations in which a facility is located in "hilly" terrain or on a plot of land upon which there are steep grades. In such circumstances, accessibility can be achieved without destroying the physical integrity of a structure, and is required in the construction of new facilities.

Some commenters asked for clarification concerning when and how to apply the ADA rules or the Fair Housing Accessibility Guidelines, especially when a facility may be subject to both because of mixed use. Guidance on this question is provided in the discussion of the definitions of place of public accommodation and commercial facility. With respect to the structural impracticability exception, a mixed-use facility could not take

advantage of the Fair Housing exemption, to the extent that it is less stringent than the ADA exemption, except for those portions of the facility that are subject only to the Fair Housing Act.

As explained in the preamble to the proposed rule, in those rare circumstances in which it is structurally impracticable to achieve full compliance with accessibility requirements under the ADA, places of public accommodation and commercial facilities should still be designed and constructed to incorporate accessibility features to the extent that the features are structurally practicable. The accessibility requirements should not be viewed as an all-or-nothing proposition in such circumstances.

If it is structurally impracticable for a facility in its entirety to be readily accessible to and usable by people with disabilities, then those portions that can be made accessible should be made accessible. If a building cannot be constructed in compliance with the full range of accessibility requirements because of structural impracticability, then it should still incorporate those features that are structurally practicable. If it is structurally impracticable to make a particular facility accessible to persons who have particular types of disabilities, it is still appropriate to require it to be made accessible to persons with other types of disabilities. For example, a facility that is of necessity built on stilts and cannot be made accessible to persons who use wheelchairs because it is structurally impracticable to do so, must be made accessible for individuals with vision or hearing impairments or other kinds of disabilities.

Elevator Exemption

Section 36.401(d) implements the "elevator exemption" for new construction in section 303(b) of the ADA. The elevator exemption is an exception to the general requirement that new facilities be readily accessible to and usable by individuals with disabilities. Generally, an elevator is the most common way to provide individuals who use wheelchairs "ready access" to floor levels above or below the ground floor of a multi-story building. Congress, however, chose not to require elevators in new small buildings, that is, those with less than three stories or less than 3,000 square feet per story. In buildings eligible for the exemption, therefore, "ready access" from the building entrance to a floor above or below the ground floor is not required, because the statute does not require that an elevator be installed in such buildings. The elevator exemption

does not apply, however, to a facility housing a shopping center, a shopping mall, or the professional office of a health care provider, or other categories of facilities as determined by the Attorney General. For example, a new office building that will have only two stories, with no elevator planned, will not be required to have an elevator, even if each story has 20,000 square feet. In other words, having either less than 3000 square feet per story or less than three stories qualifies a facility for the exemption; it need not qualify for the exemption on both counts. Similarly, a facility that has five stories of 2800 square feet each qualifies for the exemption. If a facility has three or more stories at any point, it is not eligible for the elevator exemption unless all the stories are less than 3000 square feet.

The terms "shopping center or shopping mall" and "professional office of a health care provider" are defined in this section. They are substantively identical to the definitions included in the proposed rule in § 36.104, "Definitions." They have been moved to this section because, as commenters pointed out, they are relevant only for the purposes of the elevator exemption, and inclusion in the general definitions section could give the incorrect impression that an office of a health care provider is not covered as a place of public accommodation under other sections of the rule, unless the office falls within the definition.

For purposes of § 36.401, a "shopping center or shopping mall" is (1) a building housing five or more sales or rental establishments, or (2) a series of buildings on a common site, either under common ownership or common control or developed either as one project or as a series of related projects, housing five or more sales or rental establishments. The term "shopping center or shopping mall" only includes floor levels containing at least one sales or rental establishment, or any floor level that was designed or intended for use by at least one sales or rental establishment.

Any sales or rental establishment of the type that is included in paragraph (5) of the definition of "place of public accommodation" (for example, a bakery, grocery store, clothing store, or hardware store) is considered a sales or rental establishment for purposes of this definition; the other types of public accommodations (e.g., restaurants, laundromats, banks, travel services, health spas) are not.

In the preamble to the proposed rule, the Department sought comment on whether the definition of "shopping center or mall" should be expanded to

include any of these other types of public accommodations. The Department also sought comment on whether a series of buildings should fall within the definition only if they are physically connected.

Most of those responding to the first question (overwhelmingly groups representing people with disabilities, or individual commenters) urged that the definition encompass more places of public accommodation, such as restaurants, motion picture houses, laundromats, dry cleaners, and banks. They pointed out that often it is not known what types of establishments will be tenants in a new facility. In addition, they noted that malls are advertised as entities, that their appeal is in the "package" of services offered to the public, and that this package often includes the additional types of establishments mentioned.

Commenters representing business groups sought to exempt banks, travel services, grocery stores, drug stores, and freestanding retail stores from the elevator requirement. They based this request on the desire to continue the practice in some locations of incorporating mezzanines housing administrative offices, raised pharmacist areas, and raised areas in the front of supermarkets that house safes and are used by managers to oversee operations of check-out aisles and other functions. Many of these concerns are adequately addressed by ADAAG. Apart from those addressed by ADAAG, the Department sees no reason to treat a particular type of sales or rental establishment differently from any other. Although banks and travel services are not included as "sales or rental establishments," because they do not fall under paragraph (5) of the definition of place of public accommodation, grocery stores and drug stores are included.

The Department has declined to include places of public accommodation other than sales or rental establishments in the definition. The statutory definition of "public accommodation" (section 301(7)) lists 12 types of establishments that are considered public accommodations. Category (E) includes "a bakery, grocery store, clothing store, hardware store, shopping center, or other sales or rental establishment." This arrangement suggests that it is only these types of establishments that would make up a shopping center for purposes of the statute. To include all types of places of public accommodation, or those from 6 or 7 of the categories, as commenters suggest, would overly limit the elevator

exemption; the universe of facilities covered by the definition of "shopping center" could well exceed the number of multitenant facilities *not* covered, which would render the exemption almost meaningless.

For similar reasons, the Department is retaining the requirement that a building or series of buildings must house five or more sales or rental establishments before it falls within the definition of "shopping center." Numerous commenters objected to the number and requested that the number be lowered from five to three or four. Lowering the number in this manner would include an inordinately large number of two-story multitenant buildings within the category of those required to have elevators.

The responses to the question concerning whether a series of buildings should be connected in order to be covered were varied. Generally, disability rights groups and some government agencies said a series of buildings should not have to be connected, and pointed to a trend in some areas to build shopping centers in a garden or village setting. The Department agrees that this design choice should not negate the elevator requirement for new construction. Some business groups answered the question in the affirmative, and some suggested a different definition of shopping center. For example, one commenter recommended the addition of a requirement that the five or more establishments be physically connected on the non-ground floors by a common pedestrian walkway or pathway, because otherwise a series of stand-alone facilities would have to comply with the elevator requirement, which would be unduly burdensome and perhaps infeasible. Another suggested use of what it characterized as the standard industry definition: "A group of retail stores and related business facilities, the whole planned, developed, operated and managed as a unit." While the rule's definition would reach a series of related projects that are under common control but were not developed as a single project, the Department considers such a facility to be a shopping center within the meaning of the statute. However, in light of the hardship that could confront a series of existing small stand-alone buildings if elevators were required in alterations, the Department has included a common access route in the definition of shopping center or shopping mall for purposes of § 36.404.

Some commenters suggested that access to restrooms and other shared

facilities open to the public should be required even if those facilities were not on a shopping floor. Such a provision with respect to toilet or bathing facilities is included in the elevator exception in final ADAAG 4.1.3(5).

For purposes of this subpart, the rule does not distinguish between a "shopping mall" (usually a building with a roofed-over common pedestrian area serving more than one tenant in which a majority of the tenants have a main entrance from the common pedestrian area) and a "shopping center" (e.g., a "shopping strip"). Any facility housing five or more of the types of sales or rental establishments described, regardless of the number of other types of places of public accommodation housed there (e.g., offices, movie theatres, restaurants), is a shopping center or shopping mall.

For example, a two-story facility built for mixed-use occupancy on both floors (e.g., by sales and rental establishments, a movie theater, restaurants, and general office space) is a shopping center or shopping mall if it houses five or more sales or rental establishments. If none of these establishments is located on the second floor, then only the ground floor, which contains the sales or rental establishments, would be a "shopping center or shopping mall," unless the second floor was designed or intended for use by at least one sales or rental establishment. In determining whether a floor was intended for such use, factors to be considered include the types of establishments that first occupied the floor, the nature of the developer's marketing strategy, i.e., what types of establishments were sought, and inclusion of any design features particular to rental and sales establishments.

A "professional office of a health care provider" is defined as a location where a person or entity regulated by a State to provide professional services related to the physical or mental health of an individual makes such services available to the public. In a two-story development that houses health care providers only on the ground floor, the "professional office of a health care provider" is limited to the ground floor unless the second floor was designed or intended for use by a health care provider. In determining if a floor was intended for such use, factors to be considered include whether the facility was constructed with special plumbing, electrical, or other features needed by health care providers, whether the developer marketed the facility as a medical office center, and whether any of the establishments that first occupied

the floor was, in fact, a health care provider.

In addition to requiring that a building that is a shopping center, shopping mall, or the professional office of a health care provider have an elevator regardless of square footage or number of floors, the ADA (section 303(b)) provides that the Attorney General may determine that a particular category of facilities requires the installation of elevators based on the usage of the facilities. The Department, as it proposed to do, has added to the nonexempt categories terminals, depots, or other stations used for specified public transportation, and airport passenger terminals. Numerous commenters in all categories endorsed this proposal; none opposed it. It is not uncommon for an airport passenger terminal or train station, for example, to have only two floors, with gates on both floors. Because of the significance of transportation, because a person with disabilities could be arriving or departing at any gate, and because inaccessible facilities could result in a total denial of transportation services, it is reasonable to require that newly constructed transit facilities be accessible, regardless of square footage or number of floors. One comment suggested an amendment that would treat terminals and stations similarly to shopping centers, by requiring an accessible route only to those areas used for passenger loading and unloading and for other passenger services. Paragraph (d)(2)(ii) has been modified accordingly.

Some commenters suggested that other types of facilities (e.g., educational facilities, libraries, museums, commercial facilities, and social service facilities) should be included in the category of nonexempt facilities. The Department has not found adequate justification for including any other types of facilities in the nonexempt category at this time.

Section 36.401(d)(2) establishes the operative requirements concerning the elevator exemption and its application to shopping centers and malls, professional offices of health care providers, transit stations, and airport passenger terminals. Under the rule's framework, it is necessary first to determine if a new facility (including one or more buildings) houses places of public accommodation or commercial facilities that are in the categories for which elevators are required. If so, and the facility is a shopping center or shopping mall, or a professional office of a health care provider, then any area housing such an office or a sales or

rental establishment or the professional office of a health care provider is not entitled to the elevator exemption.

The following examples illustrate the application of these principles:

1. A shopping mall has an upper and a lower level. There are two "anchor stores" (in this case, major department stores at either end of the mall, both with exterior entrances and an entrance on each level from the common area). In addition, there are 30 stores (sales or rental establishments) on the upper level, all of which have entrances from a common central area. There are 30 stores on the lower level, all of which have entrances from a common central area. According to the rule, elevator access must be provided to each store and to each level of the anchor stores. This requirement could be satisfied with respect to the 60 stores through elevators connecting the two pedestrian levels, provided that an individual could travel from the elevator to any other point on that level (i.e., into any store through a common pedestrian area) on an accessible path.

2. A commercial (nonresidential) "townhouse" development is composed of 20 two-story attached buildings. The facility is developed as one project, with common ownership, and the space will be leased to retailers. Each building has one accessible entrance from a pedestrian walk to the first floor. From that point, one can enter a store on the first floor, or walk up a flight of stairs to a store on the second floor. All 40 stores must be accessible at ground floor level or by accessible vertical access from that level. This does not mean, however, that 20 elevators must be installed. Access could be provided to the second floor by an elevator from the pedestrian area on the lower level to an upper walkway connecting all the areas on the second floor.

3. In the same type of development, it is planned that retail stores will be housed exclusively on the ground floor, with only office space (not professional offices of health care providers) on the second. Elevator access need not be provided to the second floor because all the sales or rental establishments (the entities that make the facility a shopping center) are located on an accessible ground floor.

4. In the same type of development, the space is designed and marketed as medical or office suites, or as a medical office facility. Accessible vertical access must be provided to all areas, as described in example 2.

Some commenters suggested that building owners who knowingly lease or rent space to nonexempt places of public accommodation would violate

§ 36.401. However, the Department does not consider leasing or renting inaccessible space in itself to constitute a violation of this part. Nor does a change in use of a facility, with no accompanying alterations (e.g., if a psychiatrist replaces an attorney as a tenant in a second-floor office, but no alterations are made to the office) trigger accessibility requirements.

Entities cannot evade the requirements of this section by constructing facilities in such a way that no story is intended to constitute a "ground floor." For example, if a private entity constructs a building whose main entrance leads only to stairways or escalators that connect with upper or lower floors, the Department would consider at least one level of the facility a ground story.

The rule requires in § 36.401(d)(3), consistent with the proposed rule, that, even if a building falls within the elevator exemption, the floor or floors other than the ground floor must nonetheless be accessible, except for elevator access, to individuals with disabilities, including people who use wheelchairs. This requirement applies to buildings that do not house sales or rental establishments or the professional offices of a health care provider as well as to those in which such establishments or offices are all located on the ground floor. In such a situation, little added cost is entailed in making the second floor accessible, because it is similar in structure and floor plan to the ground floor.

There are several reasons for this provision. First, some individuals who are mobility impaired may work on a building's second floor, which they can reach by stairs and the use of crutches; however, the same individuals, once they reach the second floor, may then use a wheelchair that is kept in the office. Secondly, because the first floor will be accessible, there will be little additional cost entailed in making the second floor, with the same structure and generally the same floor plan, accessible. In addition, the second floor must be accessible to those persons with disabilities who do not need elevators for level changes (for example, persons with sight or hearing impairments and those with certain mobility impairments). Finally, if an elevator is installed in the future for any reason, full access to the floor will be facilitated.

One commenter asserted that this provision goes beyond the Department's authority under the Act, and disagreed with the Department's claim that little additional cost would be entailed in compliance. However, the provision is taken directly from the legislative

history (see Education and Labor report at 114).

One commenter said that where an elevator is not required, platform lifts should be required. Two commenters pointed out that the elevator exemption is really an exemption from the requirement for providing an accessible route to a second floor not served by an elevator. The Department agrees with the latter comment. Lifts to provide access between floors are not required in buildings that are not required to have elevators. This point is specifically addressed in the appendix to ADAAG (§ 4.1.3(5)). ADAAG also addresses in detail the situations in which lifts are permitted or required.

Section 36.402 Alterations

Sections 36.402-36.405 implement section 303(a)(2) of the Act, which requires that alterations to existing facilities be made in a way that ensures that the altered portion is readily accessible to and usable by individuals with disabilities. This part does not require alterations; it simply provides that when alterations are undertaken, they must be made in a manner that provides access.

Section 36.402(a)(1) provides that any alteration to a place of public accommodation or a commercial facility, after January 26, 1992, shall be made so as to ensure that, to the maximum extent feasible, the altered portions of the facility are readily accessible to and usable by individuals with disabilities, including individuals who use wheelchairs.

The proposed rule provided that an alteration would be deemed to be undertaken after January 26, 1992, if the physical alteration of the property is in progress after that date. Commenters pointed out that this provision would, in some cases, produce an unjust result by requiring the redesign or retrofitting of projects initiated before this part established the ADA accessibility standards. The Department agrees that the proposed rule would, in some instances, unfairly penalize projects that were substantially completed before the effective date. Therefore, paragraph (a)(2) has been revised to specify that an alteration will be deemed to be undertaken after January 26, 1992, if the physical alteration of the property begins after that date. As a matter of interpretation, the Department will construe this provision to apply to alterations that require a permit from a State, County or local government, if physical alterations pursuant to the terms of the permit begin after January 26, 1992. The Department recognizes that

this application of the effective date may require redesign of some facilities that were planned prior to the publication of this part, but no retrofitting will be required of facilities on which the physical alterations were initiated prior to the effective date of the Act. Of course, nothing in this section in any way alters the obligation of any facility to remove architectural barriers in existing facilities to the extent that such barrier removal is readily achievable.

Paragraph (b) provides that, for the purposes of this part, an "alteration" is a change to a place of public accommodation or a commercial facility that affects or could affect the usability of the building or facility or any part thereof. One commenter suggested that the concept of usability should apply only to those changes that affect access by persons with disabilities. The Department remains convinced that the Act requires the concept of "usability" to be read broadly to include any change that affects the usability of the facility, not simply changes that relate directly to access by individuals with disabilities.

The Department received a significant number of comments on the examples provided in paragraphs (b)(1) and (b)(2) of the proposed rule. Some commenters urged the Department to limit the application of this provision to major structural modifications, while others asserted that it should be expanded to include cosmetic changes such as painting and wallpapering. The Department believes that neither approach is consistent with the legislative history, which requires this Department's regulation to be consistent with the accessibility guidelines (ADAAG) developed by the Architectural and Transportation Barriers Compliance Board (ATBCB). Although the legislative history contemplates that, in some instances, the ADA accessibility standards will exceed the current MGRAD requirements, it also clearly indicates the view of the drafters that "minor changes such as painting or papering walls * * * do not affect usability" (Education and Labor report at 111, Judiciary report at 64), and, therefore, are not alterations. The proposed rule was based on the existing MGRAD definition of "alteration." The language of the final rule has been revised to be consistent with ADAAG, incorporated as appendix A to this part.

Some commenters sought clarification of the intended scope of this section. The proposed rule contained illustrations of changes that affect

usability and those that do not. The intent of the illustrations was to explain the scope of the alterations requirement; the effect was to obscure it. As a result of the illustrations, some commenters concluded that any alteration to a facility, even a minor alteration such as relocating an electrical outlet, would trigger an extensive obligation to provide access throughout an entire facility. That result was never contemplated.

Therefore, in this final rule paragraph (b)(1) has been revised to include the major provisions of paragraphs (b)(1) and (b)(2) of the proposed rule. The examples in the proposed rule have been deleted. Paragraph (b)(1) now provides that alterations include, but are not limited to, remodeling, renovation, rehabilitation, reconstruction, historic restoration, changes or rearrangement in structural parts or elements, and changes or rearrangement in the plan configuration of walls and full-height partitions. Normal maintenance, reroofing, painting or wallpapering, asbestos removal, or changes to mechanical and electrical systems are not alterations unless they affect the usability of building or facility.

Paragraph (b)(2) of this final rule was added to clarify the scope of the alterations requirement. Paragraph (b)(2) provides that if existing elements, spaces, or common areas are altered, then each such altered element, space, or area shall comply with the applicable provisions of appendix A (ADAAG). As provided in § 36.403, if an altered space or area is an area of the facility that contains a primary function, then the requirements of that section apply.

Therefore, when an entity undertakes a minor alteration to a place of public accommodation or commercial facility, such as moving an electrical outlet, the new outlet must be installed in compliance with ADAAG. (Alteration of the elements listed in § 36.403(c)(2) cannot trigger a path of travel obligation.) If the alteration is to an area, such as an employee lounge or locker room, that is not an area of the facility that contains a primary function, that area must comply with ADAAG. It is only when an alteration affects access to or usability of an area containing a primary function, as opposed to other areas or the elements listed in § 36.403(c)(2), that the path of travel to the altered area must be made accessible.

The Department received relatively few comments on paragraph (c), which explains the statutory phrase "to the maximum extent feasible." Some commenters suggested that the

regulation should specify that cost is a factor in determining whether it is feasible to make an altered area accessible. The legislative history of the ADA indicates that the concept of feasibility only reaches the question of whether it is possible to make the alteration accessible in compliance with this part. Costs are to be considered only when an alteration to an area containing a primary function triggers an additional requirement to make the path of travel to the altered area accessible.

Section 36.402(c) is, therefore, essentially unchanged from the proposed rule. At the recommendation of a commenter, the Department has inserted the word "virtually" to modify "impossible" to conform to the language of the legislative history. It explains that the phrase "to the maximum extent feasible" as used in this section applies to the occasional case where the nature of an existing facility makes it virtually impossible to comply fully with applicable accessibility standards through a planned alteration. In the occasional cases in which full compliance is impossible, alterations shall provide the maximum physical accessibility feasible. Any features of the facility that are being altered shall be made accessible unless it is technically infeasible to do so. If providing accessibility in conformance with this section to individuals with certain disabilities (e.g., those who use wheelchairs) would not be feasible, the facility shall be made accessible to persons with other types of disabilities (e.g., those who use crutches or who have impaired vision or hearing, or those who have other types of impairments).

Section 36.403 Alterations: Path of Travel

Section 36.403 implements the statutory requirement that any alteration that affects or could affect the usability of or access to an area of a facility that contains a primary function shall be made so as to ensure that, to the maximum extent feasible, the path of travel to the altered area, and the restrooms, telephones, and drinking fountains serving the altered area, are readily accessible to and usable by individuals with disabilities, including individuals who use wheelchairs, unless the cost and scope of such alterations is disproportionate to the cost of the overall alteration. Paragraph (a) restates this statutory requirement.

Paragraph (b) defines a "primary function" as a major activity for which the facility is intended. This paragraph is unchanged from the proposed rule.

Areas that contain a primary function include, but are not limited to, the customer services lobby of a bank, the dining area of a cafeteria, the meeting rooms in a conference center, as well as offices and all other work areas in which the activities of the public accommodation or other private entities using the facility are carried out. The concept of "areas containing a primary function" is analogous to the concept of "functional spaces" in § 3.5 of the existing Uniform Federal Accessibility Standards, which defines "functional spaces" as "[t]he rooms and spaces in a building or facility that house the major activities for which the building or facility is intended."

Paragraph (b) provides that areas such as mechanical rooms, boiler rooms, supply storage rooms, employee lounges and locker rooms, janitorial closets, entrances, corridors, and restrooms are not areas containing a primary function. There may be exceptions to this general rule. For example, the availability of public restrooms at a place of public accommodation at a roadside rest stop may be a major factor affecting customers' decisions to patronize the public accommodation. In that case, a restroom would be considered to be an "area containing a primary function" of the facility.

Most of the commenters who addressed this issue supported the approach taken by the Department; but a few commenters suggested that areas not open to the general public or those used exclusively by employees should be excluded from the definition of primary function. The preamble to the proposed rule noted that the Department considered an alternative approach to the definition of "primary function," under which a primary function of a commercial facility would be defined as a major activity for which the facility was intended, while a primary function of a place of public accommodation would be defined as an activity which involves providing significant goods, services, facilities, privileges, advantages, or accommodations. However, the Department concluded that, although portions of the legislative history of the ADA support this alternative, the better view is that the language now contained in § 36.403(b) most accurately reflects congressional intent. No commenter made a persuasive argument that the Department's interpretation of the legislative history is incorrect.

When the ADA was introduced, the requirement to make alterations accessible was included in section 302 of the Act, which identifies the practices

that constitute discrimination by a public accommodation. Because section 302 applies only to the operation of a place of public accommodation, the alterations requirement was intended only to provide access to clients and customers of a public accommodation. It was anticipated that access would be provided to employees with disabilities under the "reasonable accommodation" requirements of title I. However, during its consideration of the ADA, the House Judiciary Committee amended the bill to move the alterations provision from section 302 to section 303, which applies to commercial facilities as well as public accommodations. The Committee report accompanying the bill explains that:

New construction and alterations of both public accommodations and commercial facilities must be made readily accessible to and usable by individuals with disabilities * * *. Essentially, [this requirement] is designed to ensure that patrons and employees of public accommodations and commercial facilities are able to get to, enter and use the facility * * *. The rationale for making new construction accessible applies with equal force to alterations.

Judiciary report at 62-63 (emphasis added).

The ADA, as enacted, contains the language of section 303 as it was reported out of the Judiciary Committee. Therefore, the Department has concluded that the concept of "primary function" should be applied in the same manner to places of public accommodation and to commercial facilities, thereby including employee work areas in places of public accommodation within the scope of this section.

Paragraph (c) provides examples of alterations that affect the usability of or access to an area containing a primary function. The examples include: Remodeling a merchandise display area or employee work areas in a department store; installing a new floor surface to replace an inaccessible surface in the customer service area or employee work areas of a bank; redesigning the assembly line area of a factory; and installing a computer center in an accounting firm. This list is illustrative, not exhaustive. Any change that affects the usability of or access to an area containing a primary function triggers the statutory obligation to make the path of travel to the altered area accessible.

When the proposed rule was drafted, the Department believed that the rule made it clear that the ADA would require alterations to the path of travel only when such alterations are not disproportionate to the alteration to the primary function area. However, the comments that the Department received

indicated that many commenters believe that even minor alterations to individual elements would require additional alterations to the path of travel. To address the concern of these commenters, a new paragraph (c)(2) has been added to the final rule to provide that alterations to such elements as windows, hardware, controls (e.g. light switches or thermostats), electrical outlets, or signage will not be deemed to be alterations that affect the usability of or access to an area containing a primary function. Of course, each element that is altered must comply with ADAAG (appendix A). The cost of alterations to individual elements would be included in the overall cost of an alteration for purposes of determining disproportionality and would be counted when determining the aggregate cost of a series of small alterations in accordance with § 36.401(h) if the area is altered in a manner that affects access to or usability of an area containing a primary function.

Paragraph (d) concerns the respective obligations of landlords and tenants in the cases of alterations that trigger the path of travel requirement under § 36.403. This paragraph was contained in the landlord/tenant section of the proposed rule, § 36.201(b). If a tenant is making alterations upon its premises pursuant to terms of a lease that grant it the authority to do so (even if they constitute alterations that trigger the path of travel requirement), and the landlord is not making alterations to other parts of the facility, then the alterations by the tenant on its own premises do not trigger a path of travel obligation upon the landlord in areas of the facility under the landlord's authority that are not otherwise being altered. The legislative history makes clear that the path of travel requirement applies only to the entity that is already making the alteration, and thus the Department has not changed the final rule despite numerous comments suggesting that the tenant be required to provide a path of travel.

Paragraph (e) defines a "path of travel" as a continuous, unobstructed way of pedestrian passage by means of which an altered area may be approached, entered, and exited; and which connects the altered area with an exterior approach (including sidewalks, streets, and parking areas), an entrance to the facility, and other parts of the facility. This concept of an accessible path of travel is analogous to the concepts of "accessible route" and "circulation path" contained in section 3.5 of the current UFAS. Some commenters suggested that this

paragraph should address emergency egress. The Department disagrees. "Path of travel" as it is used in this section is a term of art under the ADA that relates only to the obligation of the public accommodation or commercial facility to provide additional accessible elements when an area containing a primary function is altered. The Department recognizes that emergency egress is an important issue, but believes that it is appropriately addressed in ADAAG (appendix A), not in this paragraph. Furthermore, ADAAG does not require changes to emergency egress areas in alterations.

Paragraph (e)(2) is drawn from section 3.5 of UFAS. It provides that an accessible path of travel may consist of walks and sidewalks, curb ramps and other interior or exterior pedestrian ramps; clear floor paths through lobbies, corridors, rooms, and other improved areas; parking access aisles; elevators and lifts; or a combination of such elements. Paragraph (e)(3) provides that, for the purposes of this part, the term "path of travel" also includes the restrooms, telephones, and drinking fountains serving an altered area.

Although the Act establishes an expectation that an accessible path of travel should generally be included when alterations are made to an area containing a primary function, Congress recognized that, in some circumstances, providing an accessible path of travel to an altered area may be sufficiently burdensome in comparison to the alteration being undertaken to the area containing a primary function as to render this requirement unreasonable. Therefore, Congress provided, in section 303(a)(2) of the Act, that alterations to the path of travel that are disproportionate in cost and scope to the overall alteration are not required.

The Act requires the Attorney General to determine at what point the cost of providing an accessible path of travel becomes disproportionate. The proposed rule provided three options for making this determination.

Two committees of Congress specifically addressed this issue: the House Committee on Education and Labor and the House Committee on the Judiciary. The reports issued by each committee suggested that accessibility alterations to a path of travel might be "disproportionate" if they exceed 30% of the alteration costs (Education and Labor report at 113; Judiciary report at 64). Because the Department believed that smaller percentage rates might be appropriate, the proposed rule sought comments on three options: 10%, 20%, or 30%.

The Department received a significant number of comments on this section. Commenters representing individuals with disabilities generally supported the use of 30% (or more); commenters representing covered entities supported a figure of 10% (or less). The Department believes that alterations made to provide an accessible path of travel to the altered area should be deemed disproportionate to the overall alteration when the cost exceeds 20% of the cost of the alteration to the primary function area. This approach appropriately reflects the intent of Congress to provide access for individuals with disabilities without causing economic hardship for the covered public accommodations and commercial facilities.

The Department has determined that the basis for this cost calculation shall be the cost of the alterations to the area containing the primary function. This approach will enable the public accommodation or other private entity that is making the alteration to calculate its obligation as a percentage of a clearly ascertainable base cost, rather than as a percentage of the "total" cost, an amount that will change as accessibility alterations to the path of travel are made.

Paragraph (f)(2) (paragraph (e)(2) in the proposed rule) is unchanged. It provides examples of costs that may be counted as expenditures required to provide an accessible path of travel. They include:

- Costs associated with providing an accessible entrance and an accessible route to the altered area, for example, the cost of widening doorways or installing ramps;
- Costs associated with making restrooms accessible, such as installing grab bars, enlarging toilet stalls, insulating pipes, or installing accessible faucet controls;
- Costs associated with providing accessible telephones, such as relocating telephones to an accessible height, installing amplification devices, or installing telecommunications devices for deaf persons (TDD's);
- Costs associated with relocating an inaccessible drinking fountain.

Paragraph (f)(1) of the proposed rule provided that when the cost of alterations necessary to make the path of travel serving an altered area fully accessible is disproportionate to the cost of the overall alteration, the path of travel shall be made accessible to the maximum extent feasible. In response to the suggestion of a commenter, the Department has made an editorial change in the final rule (paragraph (g)(1)) to clarify that if the cost of

providing a fully accessible path of travel is disproportionate, the path of travel shall be made accessible "to the extent that it can be made accessible without incurring disproportionate costs."

Paragraph (g)(2) (paragraph (f)(2) in the NPRM) establishes that priority should be given to those elements that will provide the greatest access, in the following order: An accessible entrance; an accessible route to the altered area; at least one accessible restroom for each sex or a single unisex restroom; accessible telephones; accessible drinking fountains; and, whenever possible, additional accessible elements such as parking, storage, and alarms. This paragraph is unchanged from the proposed rule.

Paragraph (h) (paragraph (g) in the proposed rule) provides that the obligation to provide an accessible path of travel may not be evaded by performing a series of small alterations to the area served by a single path of travel if those alterations could have been performed as a single undertaking. If an area containing a primary function has been altered without providing an accessible path of travel to serve that area, and subsequent alterations of that area, or a different area on the same path of travel, are undertaken within three years of the original alteration, the total cost of alterations to primary function areas on that path of travel during the preceding three year period shall be considered in determining whether the cost of making the path of travel serving that area accessible is disproportionate. Only alterations undertaken after January 26, 1992, shall be considered in determining if the cost of providing accessible features is disproportionate to the overall cost of the alterations.

Section 36.404 Alterations: Elevator Exemption

Section 36.404 implements the elevator exemption in section 303(b) of the Act as it applies to altered facilities. The provisions of section 303(b) are discussed in the preamble to § 36.401(d) above. The statute applies the same exemption to both new construction and alterations. The principal difference between the requirements of § 36.401(d) and § 36.404 is that, in altering an existing facility that is not eligible for the statutory exemption, the public accommodation or other private entity responsible for the alteration is not required to install an elevator if the installation of an elevator would be disproportionate in cost and scope to the cost of the overall alteration as

provided in § 36.403(f)(1). In addition, the standards referenced in § 36.406 (ADAAG) provide that installation of an elevator in an altered facility is not required if it is "technically infeasible."

This section has been revised to define the terms "professional office of a health care provider" and "shopping center or shopping mall" for the purposes of this section. The definition of "professional office of a health care provider" is identical to the definition included in § 36.401(d).

It has been brought to the attention of the Department that there is some misunderstanding about the scope of the elevator exemption as it applies to the professional office of a health care provider. A public accommodation, such as the professional office of a health care provider, is required to remove architectural barriers to its facility to the extent that such barrier removal is readily achievable (see § 36.304), but it is not otherwise required by this part to undertake new construction or alterations. This part does not require that an existing two story building that houses the professional office of a health care provider be altered for the purpose of providing elevator access. If, however, alterations to the area housing the office of the health care provider are undertaken for other purposes, the installation of an elevator might be required, but only if the cost of the elevator is not disproportionate to the cost of the overall alteration. Neither the Act nor this part prohibits a health care provider from locating his or her professional office in an existing facility that does not have an elevator.

Because of the unique challenges presented in altering existing facilities, the Department has adopted a definition of "shopping center or shopping mall" for the purposes of this section that is slightly different from the definition adopted under § 36.401(d). For the purposes of this section, a "shopping center or shopping mall" is (1) a building housing five or more sales or rental establishments, or (2) a series of buildings on a common site, connected by a common pedestrian access route above or below the ground floor, either under common ownership or common control or developed either as one project or as a series of related projects, housing five or more sales or rental establishments. As is the case with new construction, the term "shopping center or shopping mall" only includes floor levels housing at least one sales or rental establishment, or any floor level that was designed or intended for use by at least one sales or rental establishment.

The Department believes that it is appropriate to use a different definition of "shopping center or shopping mall" for this section than for § 36.401, in order to make it clear that a series of existing buildings on a common site that is altered for the use of sales or rental establishments does not become a "shopping center or shopping mall" required to install an elevator, unless there is a common means of pedestrian access above or below the ground floor. Without this exemption, separate, but adjacent, buildings that were initially designed and constructed independently of each other could be required to be retrofitted with elevators, if they were later renovated for a purpose not contemplated at the time of construction.

Like § 36.401(d), § 36.404 provides that the exemptions in this paragraph do not obviate or limit in any way the obligation to comply with the other accessibility requirements established in this subpart. For example, alterations to floors above or below the ground floor must be accessible regardless of whether the altered facility has an elevator. If a facility that is not required to install an elevator nonetheless has an elevator, that elevator shall meet, to the maximum extent feasible, the accessibility requirements of this section.

Section 36.405 Alterations: Historic Preservation

Section 36.405 gives effect to the intent of Congress, expressed in section 504(c) of the Act, that this part recognize the national interest in preserving significant historic structures. Commenters criticized the Department's use of descriptive terms in the proposed rule that are different from those used in the ADA to describe eligible historic properties. In addition, some commenters criticized the Department's decision to use the concept of "substantially impairing" the historic features of a property, which is a concept employed in regulations implementing section 504 of the Rehabilitation Act of 1973. Those commenters recommended that the Department adopt the criteria of "adverse effect" published by the Advisory Council on Historic Preservation under the National Historic Preservation Act (36 CFR 800.9) as the standard for determining whether an historic property may be altered.

The Department agrees with these comments to the extent that they suggest that the language of the rule should conform to the language employed by Congress in the ADA. Therefore, the language of this section has been

revised to make it clear that this provision applies to buildings or facilities that are eligible for listing in the National Register of Historic Places under the National Historic Preservation Act (16 U.S.C. 470 *et seq.*) and to buildings or facilities that are designated as historic under State or local law. The Department believes, however, that the criteria of adverse effect employed under the National Historic Preservation Act are inappropriate for this rule because section 504(c) of the ADA specifies that special alterations provisions shall apply only when an alteration would "threaten or destroy the historic significance of qualified historic buildings and facilities."

The Department intends that the exception created by this section be applied only in those very rare situations in which it is not possible to provide access to an historic property using the special access provisions in ADAAG. Therefore, paragraph (a) of § 36.405 has been revised to provide that alterations to historic properties shall comply, to the maximum extent feasible, with section 4.1.7 of ADAAG. Paragraph (b) of this section has been revised to provide that if it has been determined, under the procedures established in ADAAG, that it is not feasible to provide physical access to an historic property that is a place of public accommodation in a manner that will not threaten or destroy the historic significance of the property, alternative methods of access shall be provided pursuant to the requirements of Subpart C.

Section 36.406 Standards for New Construction and Alterations

Section 36.406 implements the requirements of sections 306(b) and 306(c) of the Act, which require the Attorney General to promulgate standards for accessible design for buildings and facilities subject to the Act and this part that are consistent with the supplemental minimum guidelines and requirements for accessible design published by the Architectural and Transportation Barriers Compliance Board (ATBCB or Board) pursuant to section 504 of the Act. This section of the rule provides that new construction and alterations subject to this part shall comply with the standards for accessible design published as appendix A to this part.

Appendix A contains the Americans with Disabilities Act Accessibility Guidelines for Buildings and Facilities (ADAAG) which is being published by the ATBCB as a final rule elsewhere in

this issue of the **Federal Register**. As proposed in this Department's proposed rule, § 36.406(a) adopts ADAAG as the accessibility standard applicable under this rule.

Paragraph (b) was not included in the proposed rule. It provides, in chart form, guidance for using ADAAG together with subparts A through D of this part when determining requirements for a particular facility. This chart is intended solely as guidance for the user; it has no effect for purposes of compliance or enforcement. It does not necessarily provide complete or mandatory information.

Proposed § 36.406(b) is not included in the final rule. That provision, which would have taken effect only if the final rule had followed the proposed Option Two for § 36.401(a), is unnecessary because the Department has chosen Option One, as explained in the preamble for that section.

Section 504(a) of the ADA requires the ATBCB to issue minimum guidelines to supplement the existing Minimum Guidelines and Requirements for Accessible Design (MGRAD) (36 CFR part 1190) for purposes of title III. According to section 504(b) of the Act, the guidelines are to establish additional requirements, consistent with the Act, "to ensure that buildings and facilities are accessible, in terms of architecture and design, . . . and communication, to individuals with disabilities." Section 306(c) of the Act requires that the accessibility standards included in the Department's regulations be consistent with the minimum guidelines, in this case ADAAG.

As explained in the ATBCB's preamble to ADAAG, the substance and form of the guidelines are drawn from several sources. They use as their model the 1984 Uniform Federal Accessibility Standards (UFAS) (41 CFR part 101, subpart 101-19.6, appendix), which are the standards implementing the Architectural Barriers Act. UFAS is based on the Board's 1982 MGRAD. ADAAG follows the numbering system and format of the private sector American National Standard Institute's ANSI A117.1 standards. (American National Specifications for Making Buildings and Facilities Accessible to and Usable by Physically Handicapped People (ANSI A117-1980) and American National Standard for Buildings and Facilities—Providing Accessibility and Usability for Physically Handicapped People (ANSI A117.1-1986).) ADAAG supplements MGRAD. In developing ADAAG, the Board made every effort to be consistent with MGRAD and the current and proposed ANSI Standards, to the extent consistent with the ADA.

ADAAG consists of nine main sections and a separate appendix. Sections 1 through 3 contain general provisions and definitions. Section 4 contains scoping provisions and technical specifications applicable to all covered buildings and facilities. The scoping provisions are listed separately for new construction of sites and exterior facilities; new construction of buildings; additions; alterations; and alterations to historic properties. The technical specifications generally reprint the text and illustrations of the ANSI A117.1 standard, except where differences are noted by italics. Sections 5 through 9 of the guidelines are special application sections and contain additional requirements for restaurants and cafeterias, medical care facilities, business and mercantile facilities, libraries, and transient lodging. The appendix to the guidelines contains additional information to aid in understanding the technical specifications. The section numbers in the appendix correspond to the sections of the guidelines to which they relate. An asterisk after a section number indicates that additional information appears in the appendix.

ADAAG's provisions are further explained under Summary of ADAAG below.

General Comments

One commenter urged the Department to move all or portions of subpart D, New Construction and Alterations, to the appendix (ADAAG) or to duplicate portions of subpart D in the appendix. The commenter correctly pointed out that subpart D is inherently linked to ADAAG, and that a self-contained set of rules would be helpful to users. The Department has attempted to simplify use of the two documents by deleting some paragraphs from subpart D (e.g., those relating to work areas), because they are included in ADAAG. However, the Department has retained in subpart D those sections that are taken directly from the statute or that give meaning to specific statutory concepts (e.g., structural impracticability, path of travel). While some of the subpart D provisions are duplicated in ADAAG, others are not. For example, issues relating to path of travel and disproportionality in alterations are not addressed in detail in ADAAG. (The structure and contents of the two documents are addressed below under Summary of ADAAG.) While the Department agrees that it would be useful to have one self-contained document, the different focuses of this rule and ADAAG do not permit this result at this time. However, the chart

included in § 36.406(b) should assist users in applying the provisions of subparts A through D, and ADAAG together.

Numerous business groups have urged the Department not to adopt the proposed ADAAG as the accessibility standards, because the requirements established are too high, reflect the "state of the art," and are inflexible, rigid, and impractical. Many of these objections have been lodged on the basis that ADAAG exceeds the statutory mandate to establish "minimum" guidelines. In the view of the Department, these commenters have misconstrued the meaning of the term "minimum guidelines." The statute clearly contemplates that the guidelines establish a level of access—a minimum—that the standards must meet or exceed. The guidelines are not to be "minimal" in the sense that they would provide for a low level of access. To the contrary, Congress emphasized that the ADA requires a "high degree of convenient access." Education and Labor report at 117-18. The legislative history explains that the guidelines may not "reduce, weaken, narrow or set less accessibility standards than those included in existing MGRAD" and should provide greater guidance in communication accessibility for individuals with hearing and vision impairments. Id. at 139. Nor did Congress contemplate a set of guidelines less detailed than ADAAG; the statute requires that the ADA guidelines supplement the existing MGRAD. When it established the statutory scheme, Congress was aware of the content and purpose of the 1982 MGRAD; as ADAAG does with respect to ADA, MGRAD establishes a minimum level of access that the Architectural Barriers Act standards (i.e., UFAS) must meet or exceed, and includes a high level of detail.

Many of the same commenters urged the Department to incorporate as its accessibility standards the ANSI standard's technical provisions and to adopt the proposed scoping provisions under development by the Council of American Building Officials' Board for the Coordination of Model Codes (BCMC). They contended that the ANSI standard is familiar to and accepted by professionals, and that both documents are developed through consensus. They suggested that ADAAG will not stay current, because it does not follow an established cyclical review process, and that it is not likely to be adopted by nonfederal jurisdictions in State and local codes. They urged the Department and the Board to coordinate the

ADAAG provisions and any substantive changes to them with the ANSI A117 committee in order to maintain a consistent and uniform set of accessibility standards that can be efficiently and effectively implemented at the State and local level through the existing building regulatory processes.

The Department shares the commenters' goal of coordination between the private sector and Federal standards, to the extent that coordination can lead to substantive requirements consistent with the ADA. A single accessibility standard, or consistent accessibility standards, that can be used for ADA purposes and that can be incorporated or referenced by State and local governments, would help to ensure that the ADA requirements are routinely implemented at the design stage. The Department plans to work toward this goal.

The Department, however, must comply with the requirements of the ADA, the Federal Advisory Committee Act (5 U.S.C. app. 1 *et seq.*) and the Administrative Procedure Act (5 U.S.C. 551 *et seq.*). Neither the Department nor the Board can adopt private requirements wholesale. Furthermore, neither the 1991 ANSI A117 Standard revision nor the BCMC process is complete. Although the ANSI and BCMC provisions are not final, the Board has carefully considered both the draft BCMC scoping provisions and draft ANSI technical standards and included their language in ADAAG wherever consistent with the ADA.

Some commenters requested that, if the Department did not adopt ANSI by reference, the Department declare compliance with ANSI/BCMC to constitute equivalency with the ADA standards. The Department has not adopted this recommendation but has instead worked as a member of the ATBCB to ensure that its accessibility standards are practical and usable. In addition, as explained under subpart F, Certification of State Laws or Local Building Codes, the proper forum for further evaluation of this suggested approach would be in conjunction with the certification process.

Some commenters urged the Department to allow an additional comment period after the Board published its guidelines in final form, for purposes of affording the public a further opportunity to evaluate the appropriateness of including them as the Department's accessibility standards. Such an additional comment period is unnecessary and would unduly delay the issuance of final regulations. The Department put the public on notice, through the proposed rule, of its

intention to adopt the proposed ADAAG, with any changes made by the Board, as the accessibility standards. As a member of the Board and of its ADA Task Force, the Department participated actively in the public hearings held on the proposed guidelines and in preparation of both the proposed and final versions of ADAAG. Many individuals and groups commented directly to the Department's docket, or at its public hearings, about ADAAG. The comments received on ADAAG, whether by the Board or by this Department, were thoroughly analyzed and considered by the Department in the context of whether the proposed ADAAG was consistent with the ADA and suitable for adoption as both guidelines and standards. The Department is convinced that ADAAG as adopted in its final form is appropriate for these purposes. The final guidelines, adopted here as standards, will ensure the high level of access contemplated by Congress, consistent with the ADA's balance between the interests of people with disabilities and the business community.

A few commenters, citing the Senate report (at 70) and the Education and Labor report (at 119), asked the Department to include in the regulations a provision stating that departures from particular technical and scoping requirements of the accessibility standards will be permitted so long as the alternative methods used will provide substantially equivalent or greater access to and utilization of the facility. Such a provision is found in ADAAG 2.2 and by virtue of that fact is included in these regulations.

Comments on specific provisions of proposed ADAAG

During the course of accepting comments on its proposed rule, the Department received numerous comments on ADAAG. Those areas that elicited the heaviest response included assistive listening systems, automated teller machines, work areas, parking, areas of refuge, telephones (scoping for TDD's and volume controls) and visual alarms. Strenuous objections were raised by some business commenters to the proposed provisions of the guidelines concerning check-out aisles, counters, and scoping for hotels and nursing facilities. All these comments were considered in the same manner as other comments on the Department's proposed rule and, in the Department's view, have been addressed adequately in the final ADAAG.

Largely in response to comments, the Board made numerous changes from its proposal, including the following:

- Generally, at least 50% of public entrances to new buildings must be accessible, rather than all entrances, as would often have resulted from the proposed approach.

- Not all check-out aisles are required to be accessible.

- The final guidelines provide greater flexibility in providing access to sales counters, and no longer require a portion of every counter to be accessible.

- Scoping for TDD's or text telephones was increased. One TDD or text telephone, for speech and hearing impaired persons, must be provided at locations with 4, rather than 6, pay phones, and in hospitals and shopping malls. Use of portable (less expensive) TDD's is allowed.

- Dispersal of wheelchair seating areas in theaters will be required only where there are more than 300 seats, rather than in all cases. Seats with removable armrests (i.e., seats into which persons with mobility impairments can transfer) will also be required.

- Areas of refuge (areas with direct access to a stairway, and where people who cannot use stairs may await assistance during an emergency evacuation) will be required, as proposed, but the final provisions are based on the Uniform Building Code. Such areas are not required in alterations.

- Rather than requiring 5% of new hotel rooms to be accessible to people with mobility impairments, between 2 and 4% accessibility (depending on total number of rooms) is required. In addition, 1% of the rooms must have roll-in showers.

- The proposed rule reserved the provisions on alterations to homeless shelters. The final guidelines apply alterations requirements to homeless shelters, but the requirements are less stringent than those applied to other types of facilities.

- Parking spaces that can be used by people in vans (with lifts) will be required.

- As mandated by the ADA, the Board has established a procedure to be followed with respect to alterations to historic facilities.

Summary of ADAAG

This section of the preamble summarizes the structure of ADAAG, and highlights the more important portions.

Sections 1 Through 3

Sections 1 through 3 contain general requirements, including definitions.

• *Section 4.1.1, Application*

Section 4 contains scoping requirements. Section 4.1.1, Application, provides that all areas of newly designed or newly constructed buildings and facilities and altered portions of existing buildings and facilities required to be accessible by § 4.1.6 must comply with the guidelines unless otherwise provided in § 4.1.1 or a special application section. It addresses areas used only by employees as work areas, temporary structures, and general exceptions.

Section 4.1.1(3) preserves the basic principle of the proposed rule: Areas that may be used by employees with disabilities shall be designed and constructed so that an individual with a disability can approach, enter, and exit the area. The language has been clarified to provide that it applies to any area used only as a work area (not just to areas "that may be used by employees with disabilities"), and that the guidelines do not require that any area used as an individual work station be designed with maneuvering space or equipped to be accessible. The appendix to ADAAG explains that work areas must meet the guidelines' requirements for doors and accessible routes, and recommends, but does not require, that 5% of individual work stations be designed to permit a person using a wheelchair to maneuver within the space.

Further discussion of work areas is found in the preamble concerning proposed § 36.401(b).

Section 4.1.1(5)(a) includes an exception for structural impracticability that corresponds to the one found in § 36.401(c) and discussed in that portion of the preamble.

• *Section 4.1.2, Accessible Sites and Exterior Facilities: New Construction*

This section addresses exterior features, elements, or spaces such as parking, portable toilets, and exterior signage, in new construction. Interior elements and spaces are covered by § 4.1.3.

The final rule retains the UFAS scoping for parking but also requires that at least one of every eight accessible parking spaces be designed with adequate adjacent space to deploy a lift used with a van. These spaces must have a sign indicating that they are van-accessible, but they are not to be reserved exclusively for van users.

• *Section 4.1.3, Accessible Buildings: New Construction*

This section establishes scoping requirements for new construction of buildings and facilities.

Sections 4.1.3 (1) through (4) cover accessible routes, protruding objects, ground and floor surfaces, and stairs.

Section 4.1.3(5) generally requires elevators to serve each level in a newly constructed building, with four exceptions included in the subsection. Exception 1 is the "elevator exception" established in § 36.401(d), which must be read with this section. Exception 4 allows the use of platform lifts under certain conditions.

Section 4.1.3(6), Windows, is reserved. Section 4.1.3(7) applies to doors.

Under § 4.1.3(8), at least 50% of all public entrances must be accessible. In addition, if a building is designed to provide access to enclosed parking, pedestrian tunnels, or elevated walkways, at least one entrance that serves each such function must be accessible. Each tenancy in a building must be served by an accessible entrance. Where local regulations (e.g., fire codes) require that a minimum number of exits be provided, an equivalent number of accessible entrances must be provided. (The latter provision does not require a greater number of entrances than otherwise planned.)

ADAAG Section 4.1.3(9), with accompanying technical requirements in Section 4.3, requires an area of rescue assistance (*i.e.*, an area with direct access to an exit stairway and where people who are unable to use stairs may await assistance during an emergency evacuation) to be established on each floor of a multi-story building. This was one of the most controversial provisions in the guidelines. The final ADAAG is based on current Uniform Building Code requirements and retains the requirement that areas of refuge (renamed "areas of rescue assistance") be provided, but specifies that this requirement does not apply to buildings that have a supervised automatic sprinkler system. Areas of refuge are not required in alterations.

The next seven subsections deal with drinking fountains (§ 4.1.3(10)); toilet facilities (§ 4.1.3(11)); storage, shelving, and display units (§ 4.1.3(12)), controls and operating mechanisms (§ 4.1.3(13)), emergency warning systems (§ 4.1.3(14)), detectable warnings (§ 4.1.3(15)), and building signage (§ 4.1.3(16)). Paragraph 11 requires that toilet facilities comply with § 4.22, which requires one accessible toilet stall (60" x 60") in each newly constructed restroom. In response

to public comments, the final rule requires that a second accessible stall (36" x 60") be provided in restrooms that have six or more stalls.

ADAAG Section 4.1.3(17) establishes requirements for accessibility of pay phones to persons with mobility impairments, hearing impairments (requiring some phones with volume controls), and those who cannot use voice telephones. It requires one interior "text telephone" to be provided at any facility that has a total of four or more public pay phones. (The term "text telephone" has been adopted to reflect current terminology and changes in technology.) In addition, text telephones will be required in specific locations, such as covered shopping malls, hospitals (in emergency rooms, waiting rooms, and recovery areas), and convention centers.

Paragraph 18 of Section 4.1.3 generally requires that at least five percent of fixed or built-in seating or tables be accessible.

Paragraph 19, covering assembly areas, specifies the number of wheelchair seating spaces and types and numbers of assistive listening systems required. It requires dispersal of wheelchair seating locations in facilities where there are more than 300 seats. The guidelines also require that at least one percent of all fixed seats be aisle seats without armrests (or with moveable armrests) on the aisle side to increase accessibility for persons with mobility impairments who prefer to transfer from their wheelchairs to fixed seating. In addition, the final ADAAG requires that fixed seating for a companion be located adjacent to each wheelchair location.

Paragraph 20 requires that where automated teller machines are provided, at least one must comply with section 4.34, which, among other things, requires accessible controls, and instructions and other information that are accessible to persons with sight impairments.

Under paragraph 21, where dressing rooms are provided, five percent or at least one must comply with section 4.35.

• *Section 4.1.5, Additions*

Each addition to an existing building or facility is regarded as an alteration subject to §§ 36.402 through 36.406 of subpart D, including the date established in § 36.402(a). But additions also have attributes of new construction, and to the extent that a space or element in the addition is newly constructed, each new space or element must comply with the applicable scoping provisions of sections 4.1.1 to 4.1.3 for new construction, the applicable

technical specifications of sections 4.2 through 4.34, and any applicable special provisions in sections 5 through 10. For instance, if a restroom is provided in the addition, it must comply with the requirements for new construction. Construction of an addition does not, however, create an obligation to retrofit the entire existing building or facility to meet requirements for new construction. Rather, the addition is to be regarded as an alteration and to the extent that it affects or could affect the usability of or access to an area containing a primary function, the requirements in section 4.1.6(2) are triggered with respect to providing an accessible path of travel to the altered area and making the restrooms, telephones, and drinking fountains serving the altered area accessible. For example, if a museum adds a new wing that does not have a separate entrance as part of the addition, an accessible path of travel would have to be provided through the existing building or facility unless it is disproportionate to the overall cost and scope of the addition as established in § 36.403(f).

• *Section 4.1.6, Alterations*

An alteration is a change to a building or facility that affects or could affect the usability of or access to the building or facility or any part thereof. There are three general principles for alterations. First, if any existing element or space is altered, the altered element or space must meet new construction requirements (section 4.1.6(1)(b)). Second, if alterations to the elements in a space when considered together amount to an alteration of the space, the entire space must meet new construction requirements (section 4.1.6(1)(c)). Third, if the alteration affects or could affect the usability of or access to an area containing a primary function, the path of travel to the altered area and the restrooms, drinking fountains, and telephones serving the altered area must be made accessible unless it is disproportionate to the overall alterations in terms of cost and scope as determined under criteria established by the Attorney General (§ 4.1.6(2)).

Section 4.1.6 should be read with §§ 36.402 through 36.405. Requirements concerning alterations to an area serving a primary function are addressed with greater detail in the latter sections than in section 4.1.6(2). Section 4.1.6(1)(j) deals with technical infeasibility. Section 4.1.6(3) contains special technical provisions for alterations to existing buildings and facilities.

• *Section 4.1.7, Historic Preservation*

This section contains scoping provisions and alternative requirements for alterations to qualified historic buildings and facilities. It clarifies the procedures under the National Historic Preservation Act and their application to alterations covered by the ADA. An individual seeking to alter a facility that is subject to the ADA guidelines and to State or local historic preservation statutes shall consult with the State Historic Preservation Officer to determine if the planned alteration would threaten or destroy the historic significance of the facility.

• *Sections 4.2 Through 4.35*

Sections 4.2 through 4.35 contain the technical specifications for elements and spaces required to be accessible by the scoping provisions (sections 4.1 through 4.1.7) and special application sections (sections 5 through 10). The technical specifications are the same as the 1980 version of ANSI A117.1 standard, except as noted in the text by italics.

• *Sections 5 Through 9*

These are special application sections and contain additional requirements for restaurants and cafeterias, medical care facilities, business and mercantile facilities, libraries, and transient lodging. For example, at least 5 percent, but not less than one, of the fixed tables in a restaurant must be accessible.

In section 7, Business and Mercantile, paragraph 7.2 (Sales and Service Counters, Teller Windows, Information Counters) has been revised to provide greater flexibility in new construction than did the proposed rule. At least one of each type of sales or service counter where a cash register is located shall be made accessible. Accessible counters shall be dispersed throughout the facility. At counters such as bank teller windows or ticketing counters, alternative methods of compliance are permitted. A public accommodation may lower a portion of the counter, provide an auxiliary counter, or provide equivalent facilitation through such means as installing a folding shelf on the front of the counter at an accessible height to provide a work surface for a person using a wheelchair.

Section 7.3., Check-out Aisles, provides that, in new construction, a certain number of each design of check-out aisle, as listed in a chart based on the total number of check-out aisles of each design, shall be accessible. The percentage of check-outs required to be accessible generally ranges from 20% to 40%. In a newly constructed or altered

facility with less than 5,000 square feet of selling space, at least one of each type of check-out aisle must be accessible. In altered facilities with 5,000 or more square feet of selling space, at least one of each design of check-out aisle must be made accessible when altered, until the number of accessible aisles of each design equals the number that would be required for new construction.

• *Section 9, Accessible Transient Lodging*

Section 9 addresses two types of transient lodging: hotels, motels, inns, boarding houses, dormitories, resorts, and other similar places (sections 9.1 through 9.4); and homeless shelters, halfway houses, transient group homes, and other social service establishments (section 9.5). The interplay of the ADA and Fair Housing Act with respect to such facilities is addressed in the preamble discussion of the definition of "place of public accommodation" in § 36.104.

The final rule establishes scoping requirements for accessibility of newly constructed hotels. Four percent of the first hundred rooms, and roughly two percent of rooms in excess of 100, must meet certain requirements for accessibility to persons with mobility or hearing impairments, and an additional identical percentage must be accessible to persons with hearing impairments. An additional 1% of the available rooms must be equipped with roll-in showers, raising the actual scoping for rooms accessible to persons with mobility impairments to 5% of the first hundred rooms and 3% thereafter. The final ADAAG also provides that when a hotel is being altered, one fully accessible room and one room equipped with visual alarms, notification devices, and amplified telephones shall be provided for each 25 rooms being altered until the number of accessible rooms equals that required under the new construction standard. Accessible rooms must be dispersed in a manner that will provide persons with disabilities with a choice of single or multiple-bed accommodations.

In new construction, homeless shelters and other social service entities must comply with ADAAG; at least one type of amenity in each common area must be accessible. In a facility that is not required to have an elevator, it is not necessary to provide accessible amenities on the inaccessible floors if at least one of each type of amenity is provided in accessible common areas. The percentage of accessible sleeping accommodations required is the same as

that required for other places of transient lodging. Requirements for facilities altered for use as a homeless shelter parallel the current MGRAD accessibility requirements for leased buildings. A shelter located in an altered facility must have at least one accessible entrance, accessible sleeping accommodations in a number equivalent to that established for new construction, at least one accessible toilet and bath, at least one accessible common area, and an accessible route connecting all accessible areas. All accessible areas in a homeless shelter in an altered facility may be located on one level.

Section 10, Transportation Facilities

Section 10 of ADAAG is reserved. On March 20, 1991, the ATBCB published a supplemental notice of proposed rulemaking (56 FR 11874) to establish special access requirements for transportation facilities. The Department anticipates that when the ATBCB issues final guidelines for transportation facilities, this part will be amended to include those provisions.

Subpart E—Enforcement

Because the Department of Justice does not have authority to establish procedures for judicial review and enforcement, subpart E generally restates the statutory procedures for enforcement.

Section 36.501 describes the procedures for private suits by individuals and the judicial remedies available. In addition to the language in section 308(a)(1) of the Act, § 36.501(a) of this part includes the language from section 204(a) of the Civil Rights Act of 1964 (42 U.S.C. 2000a-3(a)) which is incorporated by reference in the ADA. A commenter noted that the proposed rule did not include the provision in section 204(a) allowing the court to appoint an attorney for the complainant and authorize the commencement of the civil action without the payment of fees, costs, or security. That provision has been included in the final rule.

Section 308(a)(1) of the ADA permits a private suit by an individual who has reasonable grounds for believing that he or she is "about to be" subjected to discrimination in violation of section 303 of the Act (subpart D of this part), which requires that new construction and alterations be readily accessible to and usable by individuals with disabilities. Authorizing suits to prevent construction of facilities with architectural barriers will avoid the necessity of costly retrofitting that might be required if suits were not permitted until after the facilities were completed. To avoid unnecessary suits, this section

requires that the individual bringing the suit have "reasonable grounds" for believing that a violation is about to occur, but does not require the individual to engage in a futile gesture if he or she has notice that a person or organization covered by title III of the Act does not intend to comply with its provisions.

Section 36.501(b) restates the provisions of section 308(a)(2) of the Act, which states that injunctive relief for the failure to remove architectural barriers in existing facilities or the failure to make new construction and alterations accessible "shall include" an order to alter these facilities to make them readily accessible to and usable by persons with disabilities to the extent required by title III. The Report of the Energy and Commerce Committee notes that "an order to make a facility readily accessible to and usable by individuals with disabilities is mandatory" under this standard. H.R. Rep. No. 485, 101st Cong., 2d Sess, pt 4, at 64 (1990). Also, injunctive relief shall include, where appropriate, requiring the provision of an auxiliary aid or service, modification of a policy, or provision of alternative methods, to the extent required by title III of the Act and this part.

Section 36.502 is based on section 308(b)(1)(A)(i) of the Act, which provides that the Attorney General shall investigate alleged violations of title III and undertake periodic reviews of compliance of covered entities. Although the Act does not establish a comprehensive administrative enforcement mechanism for investigation and resolution of all complaints received, the legislative history notes that investigation of alleged violations and periodic compliance reviews are essential to effective enforcement of title III, and that the Attorney General is expected to engage in active enforcement and to allocate sufficient resources to carry out this responsibility. Judiciary Report at 67.

Many commenters argued for inclusion of more specific provisions for administrative resolution of disputes arising under the Act and this part in order to promote voluntary compliance and avoid the need for litigation. Administrative resolution is far more efficient and economical than litigation, particularly in the early stages of implementation of complex legislation when the specific requirements of the statute are not widely understood. The Department has added a new paragraph (c) to this section authorizing the Attorney General to initiate a compliance review where he or she has

reason to believe there may be a violation of this rule.

Section 36.503 describes the procedures for suits by the Attorney General set out in section 308(b)(1)(B) of the Act. If the Department has reasonable cause to believe that any person or group of persons is engaged in a pattern or practice of resistance to the full enjoyment of any of the rights granted by title III or that any person or group of persons has been denied any of the rights granted by title III and such denial raises an issue of general public importance, the Attorney General may commence a civil action in any appropriate United States district court. The proposed rule provided for suit by the Attorney General "or his or her designee." The reference to a "designee" has been omitted in the final rule because it is unnecessary. The Attorney General has delegated enforcement authority under the ADA to the Assistant Attorney General for Civil Rights. 55 FR 40653 (October 4, 1990) (to be codified at 28 CFR 0.50(l)).

Section 36.504 describes the relief that may be granted in a suit by the Attorney General under section 308(b)(2) of the Act. In such an action, the court may grant any equitable relief it considers to be appropriate, including granting temporary, preliminary, or permanent relief, providing an auxiliary aid or service, modification of policy or alternative method, or making facilities readily accessible to and usable by individuals with disabilities, to the extent required by title III. In addition, a court may award such other relief as the court considers to be appropriate, including monetary damages to persons aggrieved, when requested by the Attorney General.

Furthermore, the court may vindicate the public interest by assessing a civil penalty against the covered entity in an amount not exceeding \$50,000 for a first violation and not exceeding \$100,000 for any subsequent violation. Section 36.504(b) of the rule adopts the standard of section 308(b)(3) of the Act. This section makes it clear that, in counting the number of previous determinations of violations for determining whether a "first" or "subsequent" violation has occurred, determinations in the same action that the entity has engaged in more than one discriminatory act are to be counted as a single violation. A "second violation" would not accrue to that entity until the Attorney General brought another suit against the entity and the entity was again held in violation. Again, all of the violations found in the second suit would be

cumulatively considered as a "subsequent violation."

Section 36.504(c) clarifies that the terms "monetary damages" and "other relief" do not include punitive damages. They do include, however, all forms of compensatory damages, including out-of-pocket expenses and damages for pain and suffering.

Section 36.504(a)(3) is based on section 308(b)(2)(C) of the Act, which provides that, "to vindicate the public interest," a court may assess a civil penalty against the entity that has been found to be in violation of the Act in suits brought by the Attorney General. In addition, § 36.504(d), which is taken from section 308(b)(5) of the Act, further provides that, in considering what amount of civil penalty, if any, is appropriate, the court shall give consideration to "any good faith effort or attempt to comply with this part." In evaluating such good faith, the court shall consider "among other factors it deems relevant, whether the entity could have reasonably anticipated the need for an appropriate type of auxiliary aid needed to accommodate the unique needs of a particular individual with a disability."

The "good faith" standard referred to in this section is not intended to imply a willful or intentional standard—that is, an entity cannot demonstrate good faith simply by showing that it did not willfully, intentionally, or recklessly disregard the law. At the same time, the absence of such a course of conduct would be a factor a court should weigh in determining the existence of good faith.

Section 36.505 states that courts are authorized to award attorneys fees, including litigation expenses and costs, as provided in section 505 of the Act. Litigation expenses include items such as expert witness fees, travel expenses, etc. The Judiciary Committee Report specifies that such items are included under the rubric of "attorneys fees" and not "costs" so that such expenses will be assessed against a plaintiff only under the standard set forth in *Christiansburg Garment Co. v. Equal Employment Opportunity Commission*, 434 U.S. 412 (1978). (Judiciary report at 73.)

Section 36.506 restates section 513 of the Act, which encourages use of alternative means of dispute resolution. Section 36.507 explains that, as provided in section 506(e) of the Act, a public accommodation or other private entity is not excused from compliance with the requirements of this part because of any failure to receive technical assistance.

Section 36.305 Effective Date

In general, title III is effective 18 months after enactment of the Americans with Disabilities Act, i.e., January 26, 1992. However, there are several exceptions to this general rule contained throughout title III. Section 36.508 sets forth all of these exceptions in one place.

Paragraph (b) contains the rule on civil actions. It states that, except with respect to new construction and alterations, no civil action shall be brought for a violation of this part that occurs before July 26, 1992, against businesses with 25 or fewer employees and gross receipts of \$1,000,000 or less; and before January 26, 1993, against businesses with 10 or fewer employees and gross receipts of \$500,000 or less. In determining what constitutes gross receipts, it is appropriate to exclude amounts collected for sales taxes.

Paragraph (c) concerns transportation services provided by public accommodations not primarily engaged in the business of transporting people. The 18-month effective date applies to all of the transportation provisions except those requiring newly purchased or leased vehicles to be accessible. Vehicles subject to that requirement must be accessible to and usable by individuals with disabilities if the solicitation for the vehicle is made on or after August 26, 1990.

Subpart F—Certification of State Labs or Local Building Codes

Subpart F establishes procedures to implement section 308(b)(1)(A)(ii) of the Act, which provides that, on the application of a State or local government, the Attorney General may certify that a State law or local building code or similar ordinance meets or exceeds the minimum accessibility requirements of the Act. In enforcement proceedings, this certification will constitute rebuttable evidence that the law or code meets or exceeds the ADA's requirements.

Three significant changes, further explained below, were made from the proposed subpart, in response to comments. First, the State or local jurisdiction is required to hold a public hearing on its proposed request for certification and to submit to the Department, as part of the information and materials in support of a request for certification, a transcript of the hearing. Second, the time allowed for interested persons and organizations to comment on the request filed with the Department (§ 36.605(a)(1)) has been changed from 30 to 60 days. Finally, a new § 36.608,

Guidance concerning model codes, has been added.

Section 36.601 establishes the definitions to be used for purposes of this subpart. Two of the definitions have been modified, and a definition of "model code" has been added. First, in response to a comment, a reference to a code "or part thereof" has been added to the definition of "code." The purpose of this addition is to clarify that an entire code need not be submitted if only part of it is relevant to accessibility, or if the jurisdiction seeks certification of only some of the portions that concern accessibility. The Department does not intend to encourage "piecemeal" requests for certification by a single jurisdiction. In fact, the Department expects that in some cases, rather than certifying portions of a particular code and refusing to certify others, it may notify a submitting jurisdiction of deficiencies and encourage a reapplication that cures those deficiencies, so that the entire code can be certified eventually. Second, the definition of "submitting official" has been modified. The proposed rule defined the submitting official to be the State or local official who has principal responsibility for administration of a code. Commenters pointed out that in some cases more than one code within the same jurisdiction is relevant for purposes of certification. It was also suggested that the Department allow a State to submit a single application on behalf of the State, as well as on behalf of any local jurisdictions required to follow the State accessibility requirements. Consistent with these comments, the Department has added to the definition language clarifying that the official can be one authorized to submit a code on behalf of a jurisdiction.

A definition of "model code" has been added in light of new § 36.608.

Most commenters generally approved of the proposed certification process. Some approved of what they saw as the Department's attempt to bring State and local codes into alignment with the ADA. A State agency said that this section will be the backbone of the intergovernmental cooperation essential if the accessibility provisions of the ADA are to be effective.

Some comments disapproved of the proposed process as timeconsuming and laborious for the Department, although some of these comments pointed out that, if the Attorney General certified model codes on which State and local codes are based, many perceived problems would be alleviated. (This

point is further addressed by new § 36.608.)

Many of the comments received from business organizations, as well as those from some individuals and disability rights groups, addressed the relationship of the ADA requirements and their enforcement, to existing State and local codes and code enforcement systems. These commenters urged the Department to use existing code-making bodies for interpretations of the ADA, and to actively participate in the integration of the ADA into the text of the national model codes that are adopted by State and local enforcement agencies. These issues are discussed in preamble section 36.406 under General comments.

Many commenters urged the Department to evaluate or certify the entire code enforcement system (including any process for hearing appeals from builders of denials by the building code official of requests for variances, waivers, or modifications). Some urged that certification not be allowed in jurisdictions where waivers can be granted, unless there is a clearly identified decision-making process, with written rulings and notice to affected parties of any waiver or modification request. One commenter urged establishment of a dispute resolution mechanism, providing for interpretation (usually through a building official) and an administrative appeals mechanism (generally called Boards of Appeal, Boards of Construction Appeals, or Boards of Review), before certification could be granted.

The Department thoroughly considered these proposals but has declined to provide for certification of processes of enforcement or administration of State and local codes. The statute clearly authorizes the Department to certify the codes themselves for equivalency with the statute; it would be ill-advised for the Department at this point to inquire beyond the face of the code and written interpretations of it. It would be inappropriate to require those jurisdictions that grant waivers or modifications to establish certain procedures before they can apply for certification, or to insist that no deviations can be permitted. In fact, the Department expects that many jurisdictions will allow slight variations from a particular code, consistent with ADAAG itself. ADAAG includes in § 2.2 a statement allowing departures from particular requirements where substantially equivalent or greater access and usability is provided. Several sections specifically allow for

alternative methods providing equivalent facilitation and, in some cases, provide examples. (See, e.g., section 4.31.9, Text Telephones; section 7.2(2) (iii), Sales and Service Counters.) Section 4.1.6 includes less stringent requirements that are permitted in alterations, in certain circumstances.

However, in an attempt to ensure that it does not certify a code that in practice has been or will be applied in a manner that defeats its equivalency with the ADA, the Department will require that the submitting official include, with the application for certification, any relevant manuals, guides, or any other interpretive information issued that pertain to the code. (§ 36.603(c)(1).) The requirement that this information be provided is in addition to the NPRM's requirement that the official provide any pertinent formal opinions of the State Attorney General or the chief legal officer of the jurisdiction.

The first step in the certification process is a request for certification, filed by a "submitting official" (§ 36.603). The Department will not accept requests for certification until after January 26, 1992, the effective date of this part. The Department received numerous comments from individuals and organizations representing a variety of interests, urging that the hearing required to be held by the Assistant Attorney General in Washington, DC, after a preliminary determination of equivalency (§ 36.605(a)(2)), be held within the State or locality requesting certification, in order to facilitate greater participation by all interested parties. While the Department has not modified the requirement that it hold a hearing in Washington, it has added a new subparagraph 36.603(b)(3) requiring a hearing within the State or locality before a request for certification is filed. The hearing must be held after adequate notice to the public and must be on the record; a transcript must be provided with the request for certification. This procedure will insure input from the public at the State or local level and will also insure a Washington, DC, hearing as mentioned in the legislative history.

The request for certification, along with supporting documents (§ 36.603(c)), must be filed in duplicate with the office of the Assistant Attorney General for Civil Rights. The Assistant Attorney General may request further information. The request and supporting materials will be available for public examination at the office of the Assistant Attorney General and at the office of the State or local agency charged with administration and enforcement of the code. The submitting

official must publish public notice of the request for certification.

Next, under § 36.604, the Assistant Attorney General's office will consult with the ATBCB and make a preliminary determination to either (1) find that the code is equivalent (make a "preliminary determination of equivalency") or (2) deny certification. The next step depends on which of these preliminary determinations is made.

If the preliminary determination is to find equivalency, the Assistant Attorney General, under § 36.605, will inform the submitting official in writing of the preliminary determination and publish a notice in the *Federal Register* informing the public of the preliminary determination and inviting comment for 60 days. (This time period has been increased from 30 days in light of public comment pointing out the need for more time within which to evaluate the code.) After considering the information received in response to the comments, the Department will hold an hearing in Washington. This hearing will not be subject to the formal requirements of the Administrative Procedure Act. In fact, this requirement could be satisfied by a meeting with interested parties. After the hearing, the Assistant Attorney General's office will consult again with the ATBCB and make a final determination of equivalency or a final determination to deny the request for certification, with a notice of the determination published in the *Federal Register*.

If the preliminary determination is to deny certification, there will be no hearing (§ 36.606). The Department will notify the submitting official of the preliminary determination, and may specify how the code could be modified in order to receive a preliminary determination of equivalency. The Department will allow at least 15 days for the submitting official to submit relevant material in opposition to the preliminary denial. If none is received, no further action will be taken. If more information is received, the Department will consider it and make either a final decision to deny certification or a preliminary determination of equivalency. If at that stage the Assistant Attorney General makes a preliminary determination of equivalency, the hearing procedures set out in § 36.605 will be followed.

Section 36.607 addresses the effect of certification. First, certification will only be effective concerning those features or elements that are both (1) covered by the certified code and (2) addressed by the regulations against which they are being certified. For example, if

children's facilities are not addressed by the Department's standards, and the building in question is a private elementary school, certification will not be effective for those features of the building to be used by children. And if the Department's regulations addressed equipment but the local code did not, a building's equipment would not be covered by the certification.

In addition, certification will be effective only for the particular edition of the code that is certified. Amendments will not automatically be considered certified, and a submitting official will need to reapply for certification of the changed or additional provisions.

Certification will not be effective in those situations where a State or local building code official allows a facility to be constructed or altered in a manner that does not follow the technical or scoping provisions of the certified code. Thus, if an official either waives an accessible element or feature or allows a change that does not provide equivalent facilitation, the fact that the Department has certified the code itself will not stand as evidence that the facility has been constructed or altered in accordance with the minimum accessibility requirements of the ADA. The Department's certification of a code is effective only with respect to the standards in the code; it is not to be interpreted to apply to a State or local government's application of the code. The fact that the Department has certified a code with provisions concerning waivers, variances, or equivalent facilitation shall not be interpreted as an endorsement of actions taken pursuant to those provisions.

The final rule includes a new § 36.608 concerning model codes. It was drafted in response to concerns raised by numerous commenters, many of which have been discussed under General comments (§ 36.406). It is intended to assist in alleviating the difficulties posed by attempting to certify possibly tens of thousands of codes. It is included in recognition of the fact that many codes are based on, or incorporate, model or consensus standards developed by nationally recognized organizations (e.g., the American National Standards Institute (ANSI); Building Officials and Code Administrators (BOCA) International; Council of American Building Officials (CABO) and its Board for the Coordination of Model Codes (BCMC); Southern Building Code Congress International (SBCCI)). While the Department will not certify or

"precertify" model codes, as urged by some commenters, it does wish to encourage the continued viability of the consensus and model code process consistent with the purposes of the ADA.

The new section therefore allows an authorized representative of a private entity responsible for developing a model code to apply to the Assistant Attorney General for review of the code. The review process will be informal and will not be subject to the procedures of §§ 36.602 through 36.607. The result of the review will take the form of guidance from the Assistant Attorney General as to whether and in what respects the model code is consistent with the ADA's requirements. The guidance will not be binding on any entity or on the Department; it will assist in evaluations of individual State or local codes and may serve as a basis for establishing priorities for consideration of individual codes. The Department anticipates that this approach will foster further cooperation among various government levels, the private entities developing standards, and individuals with disabilities.

List of Subjects in 28 CFR Part 36

Administrative practice and procedure, Alcoholism, Americans with disabilities, Buildings, Business and industry, Civil rights, Consumer protection, Drug abuse, Handicapped, Historic preservation, Reporting and recordkeeping requirements.

By the authority vested in me as Attorney General by 28 U.S.C. 509, 510, 5 U.S.C. 301, and section 306(b) of the Americans with Disabilities Act, Public Law 101-336, and for the reasons set forth in the preamble, Chapter I of title 28 of the Code of Federal Regulations is amended by adding a new part 36 to read as follows:

PART 36—NONDISCRIMINATION ON THE BASIS OF DISABILITY BY PUBLIC ACCOMMODATIONS AND IN COMMERCIAL FACILITIES

Subpart A—General

| Sec. | Purpose. |
|---------------|-----------------------------|
| 36.101 | Purpose. |
| 36.102 | Application. |
| 36.103 | Relationship to other laws. |
| 36.104 | Definitions. |
| 36.105-36.200 | [Reserved] |

Subpart B—General Requirements

| | |
|--------|--------------------------|
| 36.201 | General. |
| 36.202 | Activities. |
| 36.203 | Integrated settings. |
| 36.204 | Administrative methods. |
| 36.205 | Association. |
| 36.206 | Retaliation or coercion. |

| | |
|---------------|--|
| 36.207 | Places of public accommodations located in private residences. |
| 36.208 | Direct threat. |
| 36.209 | Illegal use of drugs. |
| 36.210 | Smoking. |
| 36.211 | Maintenance of accessible features. |
| 36.212 | Insurance. |
| 36.213 | Relationship of subpart B to subparts C and D of this part. |
| 36.214-36.300 | [Reserved] |

Subpart C—Specific Requirements

| | |
|---------------|--|
| 36.301 | Eligibility criteria. |
| 36.302 | Modifications in policies, practices, or procedures. |
| 36.303 | Auxiliary aids and services. |
| 36.304 | Removal of barriers. |
| 36.305 | Alternatives to barrier removal. |
| 36.306 | Personal devices and services. |
| 36.307 | Accessible or special goods. |
| 36.308 | Seating in assembly areas. |
| 36.309 | Examinations and courses. |
| 36.310 | Transportation provided by public accommodations. |
| 36.311-36.400 | [Reserved] |

Subpart D—New Construction and Alterations

| | |
|---------------|---|
| 36.401 | New construction. |
| 36.402 | Alterations. |
| 36.403 | Alterations: Path of travel. |
| 36.404 | Alterations: Elevator exemption. |
| 36.405 | Alterations: Historic preservation. |
| 36.406 | Standards for new construction and alterations. |
| 36.407-36.500 | [Reserved] |

Subpart E—Enforcement

| | |
|---------------|---|
| 36.501 | Private suits. |
| 36.502 | Investigations and compliance reviews. |
| 36.503 | Suit by the Attorney General. |
| 36.504 | Relief. |
| 36.505 | Attorneys fees. |
| 36.506 | Alternative means of dispute resolution. |
| 36.507 | Effect of unavailability of technical assistance. |
| 36.508 | Effective date. |
| 36.509-36.600 | [Reserved] |

Subpart F—Certification of State Laws or Local Building Codes

| | |
|---------------|---|
| 36.601 | Definitions. |
| 36.602 | General rule. |
| 36.603 | Filing a request for certification. |
| 36.604 | Preliminary determination. |
| 36.605 | Procedure following preliminary determination of equivalency. |
| 36.606 | Procedure following preliminary denial of certification. |
| 36.607 | Effect of certification. |
| 36.608 | Guidance concerning model codes. |
| 36.609-36.999 | [Reserved] |

Appendix A to Part 36—Standards for Accessible Design

Appendix B to Part 36—Preamble to Regulation on Nondiscrimination on the Basis of Disability by Public Accommodations and in Commercial Facilities (Published July 26, 1991)

Authority: 5 U.S.C. 301; 28 U.S.C. 509, 510; Pub. L. 101-336, 42 U.S.C. 12186.

Subpart A—General**§ 36.101 Purpose.**

The purpose of this part is to implement title III of the Americans with Disabilities Act of 1990 (42 U.S.C. 12181), which prohibits discrimination on the basis of disability by public accommodations and requires places of public accommodation and commercial facilities to be designed, constructed, and altered in compliance with the accessibility standards established by this part.

§ 36.102 Application.

(a) *General.* This part applies to any—

- (1) Public accommodation;
- (2) Commercial facility; or
- (3) Private entity that offers

examinations or courses related to applications, licensing, certification, or credentialing for secondary or postsecondary education, professional, or trade purposes.

(b) *Public accommodations.* (1) The requirements of this part applicable to public accommodations are set forth in subparts B, C, and D of this part.

(2) The requirements of subparts B and C of this part obligate a public accommodation only with respect to the operations of a place of public accommodation.

(3) The requirements of subpart D of this part obligate a public accommodation only with respect to—

- (i) A facility used as, or designed or constructed for use as, a place of public accommodation; or
- (ii) A facility used as, or designed and constructed for use as, a commercial facility.

(c) *Commercial facilities.* The requirements of this part applicable to commercial facilities are set forth in subpart D of this part.

(d) *Examinations and courses.* The requirements of this part applicable to private entities that offer examinations or courses as specified in paragraph (a) of this section are set forth in § 36.309.

(e) *Exemptions and exclusions.* This part does not apply to any private club (except to the extent that the facilities of the private club are made available to customers or patrons of a place of public accommodation), or to any religious entity or public entity.

§ 36.103 Relationship to other laws.

(a) *Rule of interpretation.* Except as otherwise provided in this part, this part shall not be construed to apply a lesser standard than the standards applied under title V of the Rehabilitation Act of 1973 (29 U.S.C. 791) or the regulations issued by Federal agencies pursuant to that title.

(b) *Section 504.* This part does not affect the obligations of a recipient of Federal financial assistance to comply with the requirements of section 504 of the Rehabilitation Act of 1973 (29 U.S.C. 794) and regulations issued by Federal agencies implementing section 504.

(c) *Other laws.* This part does not invalidate or limit the remedies, rights, and procedures of any other Federal laws, or State or local laws (including State common law) that provide greater or equal protection for the rights of individuals with disabilities or individuals associated with them.

§ 36.104 Definitions.

For purposes of this part, the term—
Act means the Americans with Disabilities Act of 1990 (Pub. L. 101-336, 104 Stat. 327, 42 U.S.C. 12101-12213 and 47 U.S.C. 225 and 611).

Commerce means travel, trade, traffic, commerce, transportation, or communication—

- (1) Among the several States;
- (2) Between any foreign country or any territory or possession and any State; or
- (3) Between points in the same State but through another State or foreign country.

Commercial facilities means facilities—

- (1) Whose operations will affect commerce;
- (2) That are intended for nonresidential use by a private entity; and
- (3) That are not—

(i) Facilities that are covered or expressly exempted from coverage under the Fair Housing Act of 1968, as amended (42 U.S.C. 3601-3631);

(ii) Aircraft; or

(iii) Railroad locomotives, railroad freight cars, railroad cabooses, commuter or intercity passenger rail cars (including coaches, dining cars, sleeping cars, lounge cars, and food service cars), any other railroad cars described in section 242 of the Act or covered under title II of the Act, or railroad rights-of-way. For purposes of this definition, "rail" and "railroad" have the meaning given the term "railroad" in section 202(e) of the Federal Railroad Safety Act of 1970 (45 U.S.C. 431(e)).

Current illegal use of drugs means illegal use of drugs that occurred recently enough to justify a reasonable belief that a person's drug use is current or that continuing use is a real and ongoing problem.

Disability means, with respect to an individual, a physical or mental impairment that substantially limits one or more of the major life activities of

such individual; a record of such an impairment; or being regarded as having such an impairment.

(1) The phrase *physical or mental impairment* means—

(i) Any physiological disorder or condition, cosmetic disfigurement, or anatomical loss affecting one or more of the following body systems: neurological; musculoskeletal; special sense organs; respiratory, including speech organs; cardiovascular; reproductive; digestive; genitourinary; hemic and lymphatic; skin; and endocrine;

(ii) Any mental or psychological disorder such as mental retardation, organic brain syndrome, emotional or mental illness, and specific learning disabilities;

(iii) The phrase *physical or mental impairment* includes, but is not limited to, such contagious and noncontagious diseases and conditions as orthopedic, visual, speech, and hearing impairments, cerebral palsy, epilepsy, muscular dystrophy, multiple sclerosis, cancer, heart disease, diabetes, mental retardation, emotional illness, specific learning disabilities, HIV disease (whether symptomatic or asymptomatic), tuberculosis, drug addiction, and alcoholism;

(iv) The phrase *physical or mental impairment* does not include homosexuality or bisexuality.

(2) The phrase *major life activities* means functions such as caring for one's self, performing manual tasks, walking, seeing, hearing speaking, breathing, learning, and working.

(3) The phrase *has a record of such an impairment* means has a history of, or has been misclassified as having, a mental or physical impairment that substantially limits one or more major life activities.

(4) The phrase *is regarded as having an impairment* means—

(i) Has a physical or mental impairment that does not substantially limit major life activities but that is treated by a private entity as constituting such a limitation;

(ii) Has a physical or mental impairment that substantially limits major life activities only as a result of the attitudes of others toward such impairment; or

(iii) Has none of the impairments defined in paragraph (1) of this definition but is treated by a private entity as having such an impairment.

(5) The term *disability* does not include—

(i) Transvestism, transsexualism, pedophilia, exhibitionism, voyeurism, gender identity disorders not resulting

from physical impairments, or other sexual behavior disorders;

(ii) Compulsive gambling, kleptomania, or pyromania; or

(iii) Psychoactive substance use disorders resulting from current illegal use of drugs.

Drug means a controlled substance, as defined in schedules I through V of section 202 of the Controlled Substances Act (21 U.S.C. 812).

Facility means all or any portion of buildings, structures, sites, complexes, equipment, rolling stock or other conveyances, roads, walks, passageways, parking lots, or other real or personal property, including the site where the building, property, structure, or equipment is located.

Illegal use of drugs means the use of one or more drugs, the possession or distribution of which is unlawful under the Controlled Substances Act (21 U.S.C. 812). The term "illegal use of drugs" does not include the use of a drug taken under supervision by a licensed health care professional, or other uses authorized by the Controlled Substances Act or other provisions of Federal law.

Individual with a disability means a person who has a disability. The term "individual with a disability" does not include an individual who is currently engaging in the illegal use of drugs, when the private entity acts on the basis of such use.

Place of public accommodation means a facility, operated by a private entity, whose operations affect commerce and fall within at least one of the following categories—

(1) An inn, hotel, motel, or other place of lodging, except for an establishment located within a building that contains not more than five rooms for rent or hire and that is actually occupied by the proprietor of the establishment as the residence of the proprietor;

(2) A restaurant, bar, or other establishment serving food or drink;

(3) A motion picture house, theater, concert hall, stadium, or other place of exhibition or entertainment;

(4) An auditorium, convention center, lecture hall, or other place of public gathering;

(5) A bakery, grocery store, clothing store, hardware store, shopping center, or other sales or rental establishment;

(6) A laundromat, dry-cleaner, bank, barber shop, beauty shop, travel service, shoe repair service, funeral parlor, gas station, office of an accountant or lawyer, pharmacy, insurance office, professional office of a health care provider, hospital, or other service establishment;

(7) A terminal, depot, or other station used for specified public transportation;

(8) A museum, library, gallery, or other place of public display or collection;

(9) A park, zoo, amusement park, or other place of recreation;

(10) A nursery, elementary, secondary, undergraduate, or postgraduate private school, or other place of education;

(11) A day care center, senior citizen center, homeless shelter, food bank, adoption agency, or other social service center establishment; and

(12) A gymnasium, health spa, bowling alley, golf course, or other place of exercise or recreation.

Private club means a private club or establishment exempted from coverage under title II of the Civil Rights Act of 1964 (42 U.S.C. 2000a(e)).

Private entity means a person or entity other than a public entity.

Public accommodation means a private entity that owns, leases (or leases to), or operates a place of public accommodation.

Public entity means—

(1) Any State or local government;

(2) Any department, agency, special purpose district, or other instrumentality of a State or States or local government; and

(3) The National Railroad Passenger Corporation, and any commuter authority (as defined in section 103(8) of the Rail Passenger Service Act). (45 U.S.C. 541)

Qualified interpreter means an interpreter who is able to interpret effectively, accurately and impartially both receptively and expressively, using any necessary specialized vocabulary.

Readily achievable means easily accomplishable and able to be carried out without much difficulty or expense. In determining whether an action is readily achievable factors to be considered include—

(1) The nature and cost of the action needed under this part;

(2) The overall financial resources of the site or sites involved in the action; the number of persons employed at the site; the effect on expenses and resources; legitimate safety requirements that are necessary for safe operation, including crime prevention measures; or the impact otherwise of the action upon the operation of the site;

(3) The geographic separateness, and the administrative or fiscal relationship of the site or sites in question to any parent corporation or entity;

(4) If applicable, the overall financial resources of any parent corporation or entity; the overall size of the parent corporation or entity with respect to the number of its employees; the number, type, and location of its facilities; and

(5) If applicable, the type of operation or operations of any parent corporation or entity, including the composition, structure, and functions of the workforce of the parent corporation or entity.

Religious entity means a religious organization, including a place of worship.

Service animal means any guide dog, signal dog, or other animal individually trained to do work or perform tasks for the benefit of an individual with a disability, including, but not limited to, guiding individuals with impaired vision, alerting individuals with impaired hearing to intruders or sounds, providing minimal protection or rescue work, pulling a wheelchair, or fetching dropped items.

Specified public transportation means transportation by bus, rail, or any other conveyance (other than by aircraft) that provides the general public with general or special service (including charter service) on a regular and continuing basis.

State means each of the several States, the District of Columbia, the Commonwealth of Puerto Rico, Guam, American Samoa, the Virgin Islands, the Trust Territory of the Pacific Islands, and the Commonwealth of the Northern Mariana Islands.

Undue burden means significant difficulty or expense. In determining whether an action would result in an undue burden, factors to be considered include—

(1) The nature and cost of the action needed under this part;

(2) The overall financial resources of the site or sites involved in the action; the number of persons employed at the site; the effect on expenses and resources; legitimate safety requirements that are necessary for safe operation, including crime prevention measures; or the impact otherwise of the action upon the operation of the site;

(3) The geographic separateness, and the administrative or fiscal relationship of the site or sites in question to any parent corporation or entity;

(4) If applicable, the overall financial resources of any parent corporation or entity; the overall size of the parent corporation or entity with respect to the number of its employees; the number, type, and location of its facilities; and

(5) If applicable, the type of operation or operations of any parent corporation or entity, including the composition, structure, and functions of the workforce of the parent corporation or entity.

§§ 36.105-36.200 [Reserved]

Subpart B—General Requirements**§ 36.201 General.**

(a) *Prohibition of discrimination.* No individual shall be discriminated against on the basis of disability in the full and equal enjoyment of the goods, services, facilities, privileges, advantages, or accommodations of any place of public accommodation by any private entity who owns, leases (or leases to), or operates a place of public accommodation.

(b) *Landlord and tenant responsibilities.* Both the landlord who owns the building that houses a place of public accommodation and the tenant who owns or operates the place of public accommodation are public accommodations subject to the requirements of this part. As between the parties, allocation of responsibility for complying with the obligations of this part may be determined by lease or other contract.

§ 36.202 Activities.

(a) *Denial of participation.* A public accommodation shall not subject an individual or class of individuals on the basis of a disability or disabilities of such individual or class, directly, or through contractual, licensing, or other arrangements, to a denial of the opportunity of the individual or class to participate in or benefit from the goods, services, facilities, privileges, advantages, or accommodations of a place of public accommodation.

(b) *Participation in unequal benefit.* A public accommodation shall not afford an individual or class of individuals, on the basis of a disability or disabilities of such individual or class, directly, or through contractual, licensing, or other arrangements, with the opportunity to participate in or benefit from a good, service, facility, privilege, advantage, or accommodation that is not equal to that afforded to other individuals.

(c) *Separate benefit.* A public accommodation shall not provide an individual or class of individuals, on the basis of a disability or disabilities of such individual or class, directly, or through contractual, licensing, or other arrangements with a good, service, facility, privilege, advantage, or accommodation that is different or separate from that provided to other individuals, unless such action is necessary to provide the individual or class of individuals with a good, service, facility, privilege, advantage, or accommodation, or other opportunity that is as effective as that provided to others.

(d) *Individual or class of individuals.* For purposes of paragraphs (a) through (c) of this section, the term "individual or class of individuals" refers to the clients or customers of the public accommodation that enters into the contractual, licensing, or other arrangement.

§ 36.203 Integrated settings.

(a) *General.* A public accommodation shall afford goods, services, facilities, privileges, advantages, and accommodations to an individual with a disability in the most integrated setting appropriate to the needs of the individual.

(b) *Opportunity to participate.* Notwithstanding the existence of separate or different programs or activities provided in accordance with this subpart, a public accommodation shall not deny an individual with a disability an opportunity to participate in such programs or activities that are not separate or different.

(c) *Accommodations and services.* (1) Nothing in this part shall be construed to require an individual with a disability to accept an accommodation, aid, service, opportunity, or benefit available under this part that such individual chooses not to accept.

(2) Nothing in the Act or this part authorizes the representative or guardian of an individual with a disability to decline food, water, medical treatment, or medical services for that individual.

§ 36.204 Administrative methods.

A public accommodation shall not, directly or through contractual or other arrangements, utilize standards or criteria or methods of administration that have the effect of discriminating on the basis of disability, or that perpetuate the discrimination of others who are subject to common administrative control.

§ 36.205 Association.

A public accommodation shall not exclude or otherwise deny equal goods, services, facilities, privileges, advantages, accommodations, or other opportunities to an individual or entity because of the known disability of an individual with whom the individual or entity is known to have a relationship or association.

§ 36.206 Retaliation or coercion.

(a) No private or public entity shall discriminate against any individual because that individual has opposed any act or practice made unlawful by this part, or because that individual made a charge, testified, assisted, or

participated in any manner in an investigation, proceeding, or hearing under the Act or this part.

(b) No private or public entity shall coerce, intimidate, threaten, or interfere with any individual in the exercise or enjoyment of, or on account of his or her having exercised or enjoyed, or on account of his or her having aided or encouraged any other individual in the exercise or enjoyment of, any right granted or protected by the Act or this part.

(c) Illustrations of conduct prohibited by this section include, but are not limited to:

(1) Coercing an individual to deny or limit the benefits, services, or advantages to which he or she is entitled under the Act or this part;

(2) Threatening, intimidating, or interfering with an individual with a disability who is seeking to obtain or use the goods, services, facilities, privileges, advantages, or accommodations of a public accommodation;

(3) Intimidating or threatening any person because that person is assisting or encouraging an individual or group entitled to claim the rights granted or protected by the Act or this part to exercise those rights; or

(4) Retaliating against any person because that person has participated in any investigation or action to enforce the Act or this part.

§ 36.207 Places of public accommodation located in private residences.

(a) When a place of public accommodation is located in a private residence, the portion of the residence used exclusively as a residence is not covered by this part, but that portion used exclusively in the operation of the place of public accommodation or that portion used both for the place of public accommodation and for residential purposes is covered by this part.

(b) The portion of the residence covered under paragraph (a) of this section extends to those elements used to enter the place of public accommodation, including the homeowner's front sidewalk, if any, the door or entryway, and hallways; and those portions of the residence, interior or exterior, available to or used by customers or clients, including restrooms.

§ 36.208 Direct threat.

(a) This part does not require a public accommodation to permit an individual to participate in or benefit from the goods, services, facilities, privileges, advantages and accommodations of that

public accommodation when that individual poses a direct threat to the health or safety of others.

(b) *Direct threat* means a significant risk to the health or safety of others that cannot be eliminated by a modification of policies, practices, or procedures, or by the provision of auxiliary aids or services.

(c) In determining whether an individual poses a direct threat to the health or safety of others, a public accommodation must make an individualized assessment, based on reasonable judgment that relies on current medical knowledge or on the best available objective evidence, to ascertain: the nature, duration, and severity of the risk; the probability that the potential injury will actually occur; and whether reasonable modifications of policies, practices, or procedures will mitigate the risk.

§ 36.209 Illegal use of drugs.

(a) *General.* (1) Except as provided in paragraph (b) of this section, this part does not prohibit discrimination against an individual based on that individual's current illegal use of drugs.

(2) A public accommodation shall not discriminate on the basis of illegal use of drugs against an individual who is not engaging in current illegal use of drugs and who—

(i) Has successfully completed a supervised drug rehabilitation program or has otherwise been rehabilitated successfully;

(ii) Is participating in a supervised rehabilitation program; or

(iii) Is erroneously regarded as engaging in such use.

(b) *Health and drug rehabilitation services.* (1) A public accommodation shall not deny health services, or services provided in connection with drug rehabilitation, to an individual on the basis of that individual's current illegal use of drugs, if the individual is otherwise entitled to such services.

(2) A drug rehabilitation or treatment program may deny participation to individuals who engage in illegal use of drugs while they are in the program.

(c) *Drug testing.* (1) This part does not prohibit a public accommodation from adopting or administering reasonable policies or procedures, including but not limited to drug testing, designed to ensure that an individual who formerly engaged in the illegal use of drugs is not now engaging in current illegal use of drugs.

(2) Nothing in this paragraph (c) shall be construed to encourage, prohibit, restrict, or authorize the conducting of testing for the illegal use of drugs.

§ 36.210 Smoking.

This part does not preclude the prohibition of, or the imposition of restrictions on, smoking in places of public accommodation.

§ 36.211 Maintenance of accessible features.

(a) A public accommodation shall maintain in operable working condition those features of facilities and equipment that are required to be readily accessible to and usable by persons with disabilities by the Act or this part.

(b) This section does not prohibit isolated or temporary interruptions in service or access due to maintenance or repairs.

§ 36.212 Insurance.

(a) This part shall not be construed to prohibit or restrict—

(1) An insurer, hospital or medical service company, health maintenance organization, or any agent, or entity that administers benefit plans, or similar organizations from underwriting risks, classifying risks, or administering such risks that are based on or not inconsistent with State law; or

(2) A person or organization covered by this part from establishing, sponsoring, observing or administering the terms of a bona fide benefit plan that are based on underwriting risks, classifying risks, or administering such risks that are based on or not inconsistent with State law; or

(3) A person or organization covered by this part from establishing, sponsoring, observing or administering the terms of a bona fide benefit plan that is not subject to State laws that regulate insurance.

(b) Paragraphs (a) (1), (2), and (3) of this section shall not be used as a subterfuge to evade the purposes of the Act or this part.

(c) A public accommodation shall not refuse to serve an individual with a disability because its insurance company conditions coverage or rates on the absence of individuals with disabilities.

§ 36.213 Relationship of subpart B to subparts C and D of this part.

Subpart B of this part sets forth the general principles of nondiscrimination applicable to all entities subject to this part. Subparts C and D of this part provide guidance on the application of the statute to specific situations. The specific provisions, including the limitations on those provisions, control over the general provisions in circumstances where both specific and general provisions apply.

§§ 36.214–36.300 [Reserved]

Subpart C—Specific Requirements

§ 36.301 Eligibility criteria.

(a) *General.* A public accommodation shall not impose or apply eligibility criteria that screen out or tend to screen out an individual with a disability or any class of individuals with disabilities from fully and equally enjoying any goods, services, facilities, privileges, advantages, or accommodations, unless such criteria can be shown to be necessary for the provision of the goods, services, facilities, privileges, advantages, or accommodations being offered.

(b) *Safety.* A public accommodation may impose legitimate safety requirements that are necessary for safe operation. Safety requirements must be based on actual risks and not on mere speculation, stereotypes, or generalizations about individuals with disabilities.

(c) *Charges.* A public accommodation may not impose a surcharge on a particular individual with a disability or any group of individuals with disabilities to cover the costs of measures, such as the provision of auxiliary aids, barrier removal, alternatives to barrier removal, and reasonable modifications in policies, practices, or procedures, that are required to provide that individual or group with the nondiscriminatory treatment required by the Act or this part.

§ 36.302 Modifications in policies, practices, or procedures.

(a) *General.* A public accommodation shall make reasonable modifications in policies, practices, or procedures, when the modifications are necessary to afford goods, services, facilities, privileges, advantages, or accommodations to individuals with disabilities, unless the public accommodation can demonstrate that making the modifications would fundamentally alter the nature of the goods, services, facilities, privileges, advantages, or accommodations.

(b) *Specialties—(1) General.* A public accommodation may refer an individual with a disability to another public accommodation, if that individual is seeking, or requires, treatment or services outside of the referring public accommodation's area of specialization, and if, in the normal course of its operations, the referring public accommodation would make a similar referral for an individual without a disability who seeks or requires the same treatment or services.

(2) *Illustration—medical specialties.* A health care provider may refer an individual with a disability to another provider, if that individual is seeking, or requires, treatment or services outside of the referring provider's area of specialization, and if the referring provider would make a similar referral for an individual without a disability who seeks or requires the same treatment or services. A physician who specializes in treating only a particular condition cannot refuse to treat an individual with a disability for that condition, but is not required to treat the individual for a different condition.

(c) *Service animals—(1) General.* Generally, a public accommodation shall modify policies, practices, or procedures to permit the use of a service animal by an individual with a disability.

(2) *Care or supervision of service animals.* Nothing in this part requires a public accommodation to supervise or care for a service animal.

(d) *Check-out aisles.* A store with check-out aisles shall ensure that an adequate number of accessible check-out aisles are kept open during store hours, or shall otherwise modify its policies and practices, in order to ensure that an equivalent level of convenient service is provided to individuals with disabilities as is provided to others. If only one check-out aisle is accessible, and it is generally used for express service, one way of providing equivalent service is to allow persons with mobility impairments to make all their purchases at that aisle.

§ 36.303 Auxiliary aids and services.

(a) *General.* A public accommodation shall take those steps that may be necessary to ensure that no individual with a disability is excluded, denied services, segregated or otherwise treated differently than other individuals because of the absence of auxiliary aids and services, unless the public accommodation can demonstrate that taking those steps would fundamentally alter the nature of the goods, services, facilities, privileges, advantages, or accommodations being offered or would result in an undue burden, i.e., significant difficulty or expense.

(b) *Examples.* The term "auxiliary aids and services" includes—

(1) Qualified interpreters, notetakers, computer-aided transcription services, written materials, telephone handset amplifiers, assistive listening devices, assistive listening systems, telephones compatible with hearing aids, closed caption decoders, open and closed captioning, telecommunications devices

for deaf persons (TDD's), videotext displays, or other effective methods of making aurally delivered materials available to individuals with hearing impairments;

(2) Qualified readers, taped texts, audio recordings, Brailled materials, large print materials, or other effective methods of making visually delivered materials available to individuals with visual impairments;

(3) Acquisition or modification of equipment or devices; and

(4) Other similar services and actions.

(c) *Effective communication.* A public accommodation shall furnish appropriate auxiliary aids and services where necessary to ensure effective communication with individuals with disabilities.

(d) *Telecommunication devices for the deaf (TDD's).* (1) A public accommodation that offers a customer, client, patient, or participant the opportunity to make outgoing telephone calls on more than an incidental convenience basis shall make available, upon request, a TDD for the use of an individual who has impaired hearing or a communication disorder.

(2) This part does not require a public accommodation to use a TDD for receiving or making telephone calls incident to its operations.

(e) *Closed caption decoders.* Places of lodging that provide televisions in five or more guest rooms and hospitals that provide televisions for patient use shall provide, upon request, a means for decoding captions for use by an individual with impaired hearing.

(f) *Alternatives.* If provision of a particular auxiliary aid or service by a public accommodation would result in a fundamental alteration in the nature of the goods, services, facilities, privileges, advantages, or accommodations being offered or in an undue burden, i.e., significant difficulty or expense, the public accommodation shall provide an alternative auxiliary aid or service, if one exists, that would not result in an alteration or such burden but would nevertheless ensure that, to the maximum extent possible, individuals with disabilities receive the goods, services, facilities, privileges, advantages, or accommodations offered by the public accommodation.

§ 36.304 Removal of barriers.

(a) *General.* A public accommodation shall remove architectural barriers in existing facilities, including communication barriers that are structural in nature, where such removal is readily achievable, i.e., easily accomplishable and able to be carried out without much difficulty or expense.

(b) *Examples.* Examples of steps to remove barriers include, but are not limited to, the following actions—

(1) Installing ramps;

(2) Making curb cuts in sidewalks and entrances;

(3) Repositioning shelves;

(4) Rearranging tables, chairs, vending machines, display racks, and other furniture;

(5) Repositioning telephones;

(6) Adding raised markings on

elevator control buttons;

(7) Installing flashing alarm lights;

(8) Widening doors;

(9) Installing offset hinges to widen

doorways;

(10) Eliminating a turnstile or

providing an alternative accessible path;

(11) Installing accessible door

hardware;

(12) Installing grab bars in toilet stalls;

(13) Rearranging toilet partitions to

increase maneuvering space;

(14) Insulating lavatory pipes under

sinks to prevent burns;

(15) Installing a raised toilet seat;

(16) Installing a full-length bathroom

mirror;

(17) Repositioning the paper towel

dispenser in a bathroom;

(18) Creating designated accessible

parking spaces;

(19) Installing an accessible paper cup

dispenser at an existing inaccessible

water fountain;

(20) Removing high pile, low density

carpeting; or

(21) Installing vehicle hand controls.

(c) *Priorities.* A public

accommodation is urged to take

measures to comply with the barrier

removal requirements of this section in

accordance with the following order of

priorities.

(1) First, a public accommodation should take measures to provide access to a place of public accommodation from public sidewalks, parking, or public transportation. These measures include, for example, installing an entrance ramp, widening entrances, and providing accessible parking spaces.

(2) Second, a public accommodation should take measures to provide access to those areas of a place of public accommodation where goods and services are made available to the public. These measures include, for example, adjusting the layout of display racks, rearranging tables, providing Brailled and raised character signage, widening doors, providing visual alarms, and installing ramps.

(3) Third, a public accommodation should take measures to provide access to restroom facilities. These measures include, for example, removal of

obstructing furniture or vending machines, widening of doors, installation of ramps, providing accessible signage, widening of toilet stalls, and installation of grab bars.

(4) Fourth, a public accommodation should take any other measures necessary to provide access to the goods, services, facilities, privileges, advantages, or accommodations of a place of public accommodation.

(d) *Relationship to alterations requirements of subpart D of this part.*

(1) Except as provided in paragraph (d)(2) of this section, measures taken to comply with the barrier removal requirements of this section shall comply with the applicable requirements for alterations in § 36.402 and §§ 36.404–36.406 of this part for the element being altered. The path of travel requirements of § 36.403 shall not apply to measures taken solely to comply with the barrier removal requirements of this section.

(2) If, as a result of compliance with the alterations requirements specified in paragraph (d)(1) of this section, the measures required to remove a barrier would not be readily achievable, a public accommodation may take other readily achievable measures to remove the barrier that do not fully comply with the specified requirements. Such measures include, for example, providing a ramp with a steeper slope or widening a doorway to a narrower width than that mandated by the alterations requirements. No measure shall be taken, however, that poses a significant risk to the health or safety of individuals with disabilities or others.

(e) *Portable ramps.* Portable ramps should be used to comply with this section only when installation of a permanent ramp is not readily achievable. In order to avoid any significant risk to the health or safety of individuals with disabilities or others in using portable ramps, due consideration shall be given to safety features such as nonslip surfaces, railings, anchoring, and strength of materials.

(f) *Selling or serving space.* The rearrangement of temporary or movable structures, such as furniture, equipment, and display racks is not readily achievable to the extent that it results in a significant loss of selling or serving space.

(g) *Limitation on barrier removal obligations.* (1) The requirements for barrier removal under § 36.304 shall not be interpreted to exceed the standards for alterations in subpart D of this part.

(2) To the extent that relevant standards for alterations are not provided in subpart D of this part, then the requirements of § 36.304 shall not be

interpreted to exceed the standards for new construction in subpart D of this part.

(3) This section does not apply to rolling stock and other conveyances to the extent that § 36.310 applies to rolling stock and other conveyances.

§ 36.305 Alternatives to barrier removal.

(a) *General.* Where a public accommodation can demonstrate that barrier removal is not readily achievable, the public accommodation shall not fail to make its goods, services, facilities, privileges, advantages, or accommodations available through alternative methods, if those methods are readily achievable.

(b) *Examples.* Examples of alternatives to barrier removal include, but are not limited to, the following actions—

(1) Providing curb service or home delivery;

(2) Retrieving merchandise from inaccessible shelves or racks;

(3) Relocating activities to accessible locations;

(c) *Multiscreen cinemas.* If it is not readily achievable to remove barriers to provide access by persons with mobility impairments to all of the theaters of a multiscreen cinema, the cinema shall establish a film rotation schedule that provides reasonable access for individuals who use wheelchairs to all films. Reasonable notice shall be provided to the public as to the location and time of accessible showings.

§ 36.306 Personal devices and services.

This part does not require a public accommodation to provide its customers, clients, or participants with personal devices, such as wheelchairs; individually prescribed devices, such as prescription eyeglasses or hearing aids; or services of a personal nature including assistance in eating, toileting, or dressing.

§ 36.307 Accessible or special goods.

(a) This part does not require a public accommodation to alter its inventory to include accessible or special goods that are designed for, or facilitate use by, individuals with disabilities.

(b) A public accommodation shall order accessible or special goods at the request of an individual with disabilities, if, in the normal course of its operation, it makes special orders on request for unstocked goods, and if the accessible or special goods can be obtained from a supplier with whom the public accommodation customarily does business.

(c) Examples of accessible or special goods include items such as Brailled

versions of books, books on audio cassettes, closed-captioned video tapes, special sizes or lines of clothing, and special foods to meet particular dietary needs.

§ 36.308 Seating in assembly areas.

(a) *Existing facilities.* (1) To the extent that it is readily achievable, a public accommodation in assembly areas shall—

(i) Provide a reasonable number of wheelchair seating spaces and seats with removable aisle-side arm rests; and

(ii) Locate the wheelchair seating spaces so that they—

(A) Are dispersed throughout the seating area;

(B) Provide lines of sight and choice of admission prices comparable to those for members of the general public;

(C) Adjoin an accessible route that also serves as a means of egress in case of emergency; and

(D) Permit individuals who use wheelchairs to sit with family members or other companions.

(2) If removal of seats is not readily achievable, a public accommodation shall provide, to the extent that it is readily achievable to do so, a portable chair or other means to permit a family member or other companion to sit with an individual who uses a wheelchair.

(3) The requirements of paragraph (a) of this section shall not be interpreted to exceed the standards for alterations in subpart D of this part.

(b) *New construction and alterations.* The provision and location of wheelchair seating spaces in newly constructed or altered assembly areas shall be governed by the standards for new construction and alterations in subpart D of this part.

§ 36.309 Examinations and courses.

(a) *General.* Any private entity that offers examinations or courses related to applications, licensing, certification, or credentialing for secondary or postsecondary education, professional, or trade purposes shall offer such examinations or courses in a place and manner accessible to persons with disabilities or offer alternative accessible arrangements for such individuals.

(b) *Examinations.* (1) Any private entity offering an examination covered by this section must assure that—

(i) The examination is selected and administered so as to best ensure that, when the examination is administered to an individual with a disability that impairs sensory, manual, or speaking skills, the examination results accurately reflect the individual's

aptitude or achievement level or whatever other factor the examination purports to measure, rather than reflecting the individual's impaired sensory, manual, or speaking skills (except where those skills are the factors that the examination purports to measure);

(ii) An examination that is designed for individuals with impaired sensory, manual, or speaking skills is offered at equally convenient locations, as often, and in as timely a manner as are other examinations; and

(iii) The examination is administered in facilities that are accessible to individuals with disabilities or alternative accessible arrangements are made.

(2) Required modifications to an examination may include changes in the length of time permitted for completion of the examination and adaptation of the manner in which the examination is given.

(3) A private entity offering an examination covered by this section shall provide appropriate auxiliary aids for persons with impaired sensory, manual, or speaking skills, unless that private entity can demonstrate that offering a particular auxiliary aid would fundamentally alter the measurement of the skills or knowledge the examination is intended to test or would result in an undue burden. Auxiliary aids and services required by this section may include taped examinations, interpreters or other effective methods of making orally delivered materials available to individuals with hearing impairments, Brailled or large print examinations and answer sheets or qualified readers for individuals with visual impairments, transcribers for individuals with manual impairments, and other similar services and actions.

(4) Alternative accessible arrangements may include, for example, provision of an examination at an individual's home with a proctor if accessible facilities or equipment are unavailable. Alternative arrangements must provide comparable conditions to those provided for nondisabled individuals.

(c) *Courses.* (1) Any private entity that offers a course covered by this section must make such modifications to that course as are necessary to ensure that the place and manner in which the course is given are accessible to individuals with disabilities.

(2) Required modifications may include changes in the length of time permitted for the completion of the course, substitution of specific requirements, or adaptation of the manner in which the course is

conducted or course materials are distributed.

(3) A private entity that offers a course covered by this section shall provide appropriate auxiliary aids and services for persons with impaired sensory, manual, or speaking skills, unless the private entity can demonstrate that offering a particular auxiliary aid or service would fundamentally alter the course or would result in an undue burden. Auxiliary aids and services required by this section may include taped texts, interpreters or other effective methods of making orally delivered materials available to individuals with hearing impairments, Brailled or large print texts or qualified readers for individuals with visual impairments and learning disabilities, classroom equipment adapted for use by individuals with manual impairments, and other similar services and actions.

(4) Courses must be administered in facilities that are accessible to individuals with disabilities or alternative accessible arrangements must be made.

(5) Alternative accessible arrangements may include, for example, provision of the course through videotape, cassettes, or prepared notes. Alternative arrangements must provide comparable conditions to those provided for nondisabled individuals.

§ 36.310 Transportation provided by public accommodations.

(a) *General.* (1) A public accommodation that provides transportation services, but that is not primarily engaged in the business of transporting people, is subject to the general and specific provisions in subparts B, C, and D of this part for its transportation operations, except as provided in this section.

(2) *Examples.* Transportation services subject to this section include, but are not limited to, shuttle services operated between transportation terminals and places of public accommodation, customer shuttle bus services operated by private companies and shopping centers, student transportation systems, and transportation provided within recreational facilities such as stadiums, zoos, amusement parks, and ski resorts.

(b) *Barrier removal.* A public accommodation subject to this section shall remove transportation barriers in existing vehicles and rail passenger cars used for transporting individuals (not including barriers that can only be removed through the retrofitting of vehicles or rail passenger cars by the installation of a hydraulic or other lift)

where such removal is readily achievable.

(c) *Requirements for vehicles and systems.* A public accommodation subject to this section shall comply with the requirements pertaining to vehicles and transportation systems in the regulations issued by the Secretary of Transportation pursuant to section 306 of the Act.

§§ 36.311-36.400 [Reserved]

Subpart D—New Construction and Alterations

§ 36.401 New construction.

(a) *General.* (1) Except as provided in paragraphs (b) and (c) of this section, discrimination for purposes of this part includes a failure to design and construct facilities for first occupancy after January 26, 1993, that are readily accessible to and usable by individuals with disabilities.

(2) For purposes of this section, a facility is designed and constructed for first occupancy after January 26, 1993, only—

(i) If the last application for a building permit or permit extension for the facility is certified to be complete, by a State, County, or local government after January 26, 1992 (or, in those jurisdictions where the government does not certify completion of applications, if the last application for a building permit or permit extension for the facility is received by the State, County, or local government after January 26, 1992); and

(ii) If the first certificate of occupancy for the facility is issued after January 26, 1993.

(b) *Commercial facilities located in private residences.* (1) When a commercial facility is located in a private residence, the portion of the residence used exclusively as a residence is not covered by this subpart, but that portion used exclusively in the operation of the commercial facility or that portion used both for the commercial facility and for residential purposes is covered by the new construction and alterations requirements of this subpart.

(2) The portion of the residence covered under paragraph (b)(1) of this section extends to those elements used to enter the commercial facility, including the homeowner's front sidewalk, if any, the door or entryway, and hallways; and those portions of the residence, interior or exterior, available to or used by employees or visitors of the commercial facility, including restrooms.

(c) *Exception for structural impracticability.* (1) Full compliance

with the requirements of this section is not required where an entity can demonstrate that it is structurally impracticable to meet the requirements. Full compliance will be considered structurally impracticable only in those rare circumstances when the unique characteristics of terrain prevent the incorporation of accessibility features.

(2) If full compliance with this section would be structurally impracticable, compliance with this section is required to the extent that it is not structurally impracticable. In that case, any portion of the facility that can be made accessible shall be made accessible to the extent that it is not structurally impracticable.

(3) If providing accessibility in conformance with this section to individuals with certain disabilities (e.g., those who use wheelchairs) would be structurally impracticable, accessibility shall nonetheless be ensured to persons with other types of disabilities (e.g., those who use crutches or who have sight, hearing, or mental impairments) in accordance with this section.

(d) *Elevator exemption.* (1) For purposes of this paragraph (d)—

(i) *Professional office of a health care provider* means a location where a person or entity regulated by a State to provide professional services related to the physical or mental health of an individual makes such services available to the public. The facility housing the "professional office of a health care provider" only includes floor levels housing at least one health care provider, or any floor level designed or intended for use by at least one health care provider.

(ii) *Shopping center or shopping mall means*—

(A) A building housing five or more sales or rental establishments; or

(B) A series of buildings on a common site, either under common ownership or common control or developed either as one project or as a series of related projects, housing five or more sales or rental establishments. For purposes of this section, places of public accommodation of the types listed in paragraph (5) of the definition of "place of public accommodation" in section § 36.104 are considered sales or rental establishments. The facility housing a "shopping center or shopping mall" only includes floor levels housing at least one sales or rental establishment, or any floor level designed or intended for use by at least one sales or rental establishment.

(2) This section does not require the installation of an elevator in a facility that is less than three stories or has less than 3000 square feet per story, except

with respect to any facility that houses one or more of the following:

(i) A shopping center or shopping mall, or a professional office of a health care provider.

(ii) A terminal, depot, or other station used for specified public transportation, or an airport passenger terminal. In such a facility, any area housing passenger services, including boarding and debarking, loading and unloading, baggage claim, dining facilities, and other common areas open to the public, must be on an accessible route from an accessible entrance.

(3) The elevator exemption set forth in this paragraph (d) does not obviate or limit, in any way the obligation to comply with the other accessibility requirements established in paragraph (a) of this section. For example, in a facility that houses a shopping center or shopping mall, or a professional office of a health care provider, the floors that are above or below an accessible ground floor and that do not house sales or rental establishments or a professional office of a health care provider, must meet the requirements of this section but for the elevator.

§ 36.402 Alterations.

(a) *General.* (1) Any alteration to a place of public accommodation or a commercial facility, after January 26, 1992, shall be made so as to ensure that, to the maximum extent feasible, the altered portions of the facility are readily accessible to and usable by individuals with disabilities, including individuals who use wheelchairs.

(2) An alteration is deemed to be undertaken after January 26, 1992, if the physical alteration of the property begins after that date.

(b) *Alteration.* For the purposes of this part, an alteration is a change to a place of public accommodation or a commercial facility that affects or could affect the usability of the building or facility or any part thereof.

(1) Alterations include, but are not limited to, remodeling, renovation, rehabilitation, reconstruction, historic restoration, changes or rearrangement in structural parts or elements, and changes or rearrangement in the plan configuration of walls and full-height partitions. Normal maintenance, reroofing, painting or wallpapering, asbestos removal, or changes to mechanical and electrical systems are not alterations unless they affect the usability of the building or facility.

(2) If existing elements, spaces, or common areas are altered, then each such altered element, space, or area shall comply with the applicable provisions of appendix A to this part.

(c) *To the maximum extent feasible.* The phrase "to the maximum extent feasible," as used in this section, applies to the occasional case where the nature of an existing facility makes it virtually impossible to comply fully with applicable accessibility standards through a planned alteration. In these circumstances, the alteration shall provide the maximum physical accessibility feasible. Any altered features of the facility that can be made accessible shall be made accessible. If providing accessibility in conformance with this section to individuals with certain disabilities (e.g., those who use wheelchairs) would not be feasible, the facility shall be made accessible to persons with other types of disabilities (e.g., those who use crutches, those who have impaired vision or hearing, or those who have other impairments).

§ 36.403 Alterations: Path of travel.

(a) *General.* An alteration that affects or could affect the usability of or access to an area of a facility that contains a primary function shall be made so as to ensure that, to the maximum extent feasible, the path of travel to the altered area and the restrooms, telephones, and drinking fountains serving the altered area, are readily accessible to and usable by individuals with disabilities, including individuals who use wheelchairs, unless the cost and scope of such alterations is disproportionate to the cost of the overall alteration.

(b) *Primary function.* A "primary function" is a major activity for which the facility is intended. Areas that contain a primary function include, but are not limited to, the customer services lobby of a bank, the dining area of a cafeteria, the meeting rooms in a conference center, as well as offices and other work areas in which the activities of the public accommodation or other private entity using the facility are carried out. Mechanical rooms, boiler rooms, supply storage rooms, employee lounges or locker rooms, janitorial closets, entrances, corridors, and restrooms are not areas containing a primary function.

(c) *Alterations to an area containing a primary function.* (1) Alterations that affect the usability of or access to an area containing a primary function include, but are not limited to—

(i) Remodeling merchandise display areas or employee work areas in a department store;

(ii) Replacing an inaccessible floor surface in the customer service or employee work areas of a bank;

(iii) Redesigning the assembly line area of a factory; or

(iv) Installing a computer center in an accounting firm.

(2) For the purposes of this section, alterations to windows, hardware, controls, electrical outlets, and signage shall not be deemed to be alterations that affect the usability of or access to an area containing a primary function.

(d) *Landlord/tenant*: If a tenant is making alterations as defined in § 36.402 that would trigger the requirements of this section, those alterations by the tenant in areas that only the tenant occupies do not trigger a path of travel obligation upon the landlord with respect to areas of the facility under the landlord's authority, if those areas are not otherwise being altered.

(e) *Path of travel*. (1) A "path of travel" includes a continuous, unobstructed way of pedestrian passage by means of which the altered area may be approached, entered, and exited, and which connects the altered area with an exterior approach (including sidewalks, streets, and parking areas), an entrance to the facility, and other parts of the facility.

(2) An accessible path of travel may consist of walks and sidewalks, curb ramps and other interior or exterior pedestrian ramps; clear floor paths through lobbies, corridors, rooms, and other improved areas; parking access aisles; elevators and lifts; or a combination of these elements.

(3) For the purposes of this part, the term "path of travel" also includes the restrooms, telephones, and drinking fountains serving the altered area.

(f) *Disproportionality*. (1) Alterations made to provide an accessible path of travel to the altered area will be deemed disproportionate to the overall alteration when the cost exceeds 20% of the cost of the alteration to the primary function area.

(2) Costs that may be counted as expenditures required to provide an accessible path of travel may include:

(i) Costs associated with providing an accessible entrance and an accessible route to the altered area, for example, the cost of widening doorways or installing ramps;

(ii) Costs associated with making restrooms accessible, such as installing grab bars, enlarging toilet stalls, insulating pipes, or installing accessible faucet controls;

(iii) Costs associated with providing accessible telephones, such as relocating the telephone to an accessible height, installing amplification devices, or installing a telecommunications device for deaf persons (TDD);

(iv) Costs associated with relocating an inaccessible drinking fountain.

(g) *Duty to provide accessible features in the event of disproportionality*. (1) When the cost of alterations necessary to make the path of travel to the altered area fully accessible is disproportionate to the cost of the overall alteration, the path of travel shall be made accessible to the extent that it can be made accessible without incurring disproportionate costs.

(2) In choosing which accessible elements to provide, priority should be given to those elements that will provide the greatest access, in the following order:

- (i) An accessible entrance;
- (ii) An accessible route to the altered area;
- (iii) At least one accessible restroom for each sex or a single unisex restroom;
- (iv) Accessible telephones;
- (v) Accessible drinking fountains; and
- (vi) When possible, additional accessible elements such as parking, storage, and alarms.

(h) *Series of smaller alterations*. (1) The obligation to provide an accessible path of travel may not be evaded by performing a series of small alterations to the area served by a single path of travel if those alterations could have been performed as a single undertaking.

(2) (i) If an area containing a primary function has been altered without providing an accessible path of travel to that area, and subsequent alterations of that area, or a different area on the same path of travel, are undertaken within three years of the original alteration, the total cost of alterations to the primary function areas on that path of travel during the preceding three year period shall be considered in determining whether the cost of making that path of travel accessible is disproportionate.

(ii) Only alterations undertaken after January 26, 1992, shall be considered in determining if the cost of providing an accessible path of travel is disproportionate to the overall cost of the alterations.

§ 36.404 Alterations: Elevator exemption.

(a) This section does not require the installation of an elevator in an altered facility that is less than three stories or has less than 3,000 square feet per story, except with respect to any facility that houses a shopping center, a shopping mall, the professional office of a health care provider, a terminal, depot, or other station used for specified public transportation, or an airport passenger terminal.

(1) For the purposes of this section, "professional office of a health care provider" means a location where a person or entity regulated by a State to

provide professional services related to the physical or mental health of an individual makes such services available to the public. The facility that houses a "professional office of a health care provider" only includes floor levels housing by at least one health care provider, or any floor level designed or intended for use by at least one health care provider.

(2) For the purposes of this section, shopping center or shopping mall means—

(i) A building housing five or more sales or rental establishments; or

(ii) A series of buildings on a common site, connected by a common pedestrian access route above or below the ground floor, that is either under common ownership or common control or developed either as one project or as a series of related projects, housing five or more sales or rental establishments. For purposes of this section, places of public accommodation of the types listed in paragraph (5) of the definition of "place of public accommodation" in § 36.104 are considered sales or rental establishments. The facility housing a "shopping center or shopping mall" only includes floor levels housing at least one sales or rental establishment, or any floor level designed or intended for use by at least one sales or rental establishment.

(b) The exemption provided in paragraph (a) of this section does not obviate or limit in any way the obligation to comply with the other accessibility requirements established in this subpart. For example, alterations to floors above or below the accessible ground floor must be accessible regardless of whether the altered facility has an elevator.

§ 36.405 Alterations: Historic preservation.

(a) Alterations to buildings or facilities that are eligible for listing in the National Register of Historic Places under the National Historic Preservation Act (16 U.S.C. 470 *et seq.*), or are designated as historic under State or local law, shall comply to the maximum extent feasible with section 4.1.7 of appendix A to this part.

(b) If it is determined under the procedures set out in section 4.1.7 of appendix A that it is not feasible to provide physical access to an historic property that is a place of public accommodation in a manner that will not threaten or destroy the historic significance of the building or facility, alternative methods of access shall be provided pursuant to the requirements of subpart C of this part.

§ 36.406 Standards for new construction and alterations.

(a) New construction and alterations subject to this part shall comply with the standards for accessible design published as appendix A to this part (ADAAG).

(b) The chart in the appendix to this section provides guidance to the user in reading appendix A to this part (ADAAG) together with subparts A through D of this part, when determining requirements for a particular facility.

Appendix to § 36.406

This chart has no effect for purposes of compliance or enforcement. It does not necessarily provide complete or mandatory information.

| | Subparts A-D | ADAAG |
|-----------------------|--|--|
| Application, General. | 36.102(b)(3): public accommodations. 36.102(c): commercial facilities. 36.102(e): public entities. 36.103 (other laws). 36.401 ("for first occupancy"). 36.402(a) (alterations). | 1, 2, 3, 4.1.1. |
| Definitions..... | 36.104: commercial facilities, facility, place of public accommodation, private club, public accommodation, public entity, religious entity. 36.401(d)(1)(ii), 36.404(a)(2): shopping center or shopping mall. 36.401(d)(1)(i), 36.404(a)(1): professional office of a health care provider. 36.402: alteration; usability. 36.402(c): to the maximum extent feasible. 36.401(a) General. | 3.5 Definitions, including: addition, alteration, building, element, facility, space, story. 4.1.6(j), technical infeasibility. 4.1.2. |
| New Construction.. | | |

| | Subparts A-D | ADAAG |
|--|--|------------------------------------|
| General..... | 36.401(b) Commercial facilities in private residences. 36.207 Places of public accommodation in private residences. | 4.1.3. |
| Work Areas..... | | 4.1.1(3). |
| Structural Impracticability. | 36.401(c)..... | 4.1.1(5)(a). |
| Elevator Exemption. | 36.401(d)..... | 4.1.3(5). |
| Other Exceptions. | 36.404..... | 4.1.1(5), 4.1.3(5) and throughout. |
| Alterations: General. | 36.401(b): commercial facilities in private residences. 36.402..... 36.403..... | 4.1.6(1). 4.1.6(2). |
| Alterations Affecting an Area Containing A Primary Function; Path of Travel; Disproportionality. | | 4.1.6(3). |
| Alterations: Special Technical Provisions. | | 4.1.5. |
| Additions..... | 36.401-36.405..... | 4.1.7. |
| Historic Preservation. | | 4.2 through 4.35. |
| Technical Provisions. | | 5. |
| Restaurants and Cafeterias. | | 6. |
| Medical Care Facilities. | | 7. |
| Business and Mercantile. | | 6. |
| Libraries..... | | 9. |
| Transient Lodging (Hotels, Homeless Shelters, Etc.). | | [10, Reserved]. |
| Transportation Facilities. | | |

§§ 36.407-36.500 [Reserved]

Subpart E—Enforcement

§-36.501 Private suits.

(a) *General.* Any person who is being subjected to discrimination on the basis of disability in violation of the Act or this part or who has reasonable grounds for believing that such person is about to be subjected to discrimination in violation of section 303 of the Act or subpart D of this part may institute a civil action for preventive relief, including an application for a permanent

or temporary injunction, restraining order, or other order. Upon timely application, the court may, in its discretion, permit the Attorney General to intervene in the civil action if the Attorney General or his or her designee certifies that the case is of general public importance. Upon application by the complainant and in such circumstances as the court may deem just, the court may appoint an attorney for such complainant and may authorize the commencement of the civil action without the payment of fees, costs, or security. Nothing in this section shall require a person with a disability to engage in a futile gesture if the person has actual notice that a person or organization covered by title III of the Act or this part does not intend to comply with its provisions.

(b) *Injunctive relief.* In the case of violations of § 36.304, § 36.308, § 36.310(b), § 36.401, § 36.402, § 36.403, and § 36.405 of this part, injunctive relief shall include an order to alter facilities to make such facilities readily accessible to and usable by individuals with disabilities to the extent required by the Act or this part. Where appropriate, injunctive relief shall also include requiring the provision of an auxiliary aid or service, modification of a policy, or provision of alternative methods, to the extent required by the Act or this part.

§ 36.502 Investigations and compliance reviews.

(a) The Attorney General shall investigate alleged violations of the Act or this part.

(b) Any individual who believes that he or she or a specific class of persons has been subjected to discrimination prohibited by the Act or this part may request the Department to institute an investigation.

(c) Where the Attorney General has reason to believe that there may be a violation of this part, he or she may initiate a compliance review.

§ 36.503 Suit by the Attorney General.

Following a compliance review or investigation under § 36.502, or at any other time in his or her discretion, the Attorney General may commence a civil action in any appropriate United States district court if the Attorney General has reasonable cause to believe that—

(a) Any person or group of persons is engaged in a pattern or practice of discrimination in violation of the Act or this part; or

(b) Any person or group of persons has been discriminated against in violation of the Act or this part and the

discrimination raises an issue of general public importance.

§ 36.504 Relief.

(a) *Authority of court.* In a civil action under § 36.503, the court—

(1) May grant any equitable relief that such court considers to be appropriate, including, to the extent required by the Act or this part—

(i) Granting temporary, preliminary, or permanent relief;

(ii) Providing an auxiliary aid or service, modification of policy, practice, or procedure, or alternative method; and

(iii) Making facilities readily accessible to and usable by individuals with disabilities;

(2) May award other relief as the court considers to be appropriate, including monetary damages to persons aggrieved when requested by the Attorney General; and

(3) May, to vindicate the public interest, assess a civil penalty against the entity in an amount

(i) Not exceeding \$50,000 for a first violation; and

(ii) Not exceeding \$100,000 for any subsequent violation.

(b) *Single violation.* For purposes of paragraph (a) (3) of this section, in determining whether a first or subsequent violation has occurred, a determination in a single action, by judgment or settlement, that the covered entity has engaged in more than one discriminatory act shall be counted as a single violation.

(c) *Punitive damages.* For purposes of paragraph (a)(2) of this section, the terms "monetary damages" and "such other relief" do not include punitive damages.

(d) *Judicial consideration.* In a civil action under § 36.503, the court, when considering what amount of civil penalty, if any, is appropriate, shall give consideration to any good faith effort or attempt to comply with this part by the entity. In evaluating good faith, the court shall consider, among other factors it deems relevant, whether the entity could have reasonably anticipated the need for an appropriate type of auxiliary aid needed to accommodate the unique needs of a particular individual with a disability.

§ 36.505 Attorneys fees.

In any action or administrative proceeding commenced pursuant to the Act or this part, the court or agency, in its discretion, may allow the prevailing party, other than the United States, a reasonable attorney's fee, including litigation expenses, and costs, and the United States shall be liable for the

foregoing the same as a private individual.

§ 36.506 Alternative means of dispute resolution.

Where appropriate and to the extent authorized by law, the use of alternative means of dispute resolution, including settlement negotiations, conciliation, facilitation, mediation, factfinding, minitrials, and arbitration, is encouraged to resolve disputes arising under the Act and this part.

§ 36.507 Effect of unavailability of technical assistance.

A public accommodation or other private entity shall not be excused from compliance with the requirements of this part because of any failure to receive technical assistance, including any failure in the development or dissemination of any technical assistance manual authorized by the Act.

§ 36.508 Effective date.

(a) *General.* Except as otherwise provided in this section and in this part, this part shall become effective on January 26, 1992.

(b) *Civil actions.* Except for any civil action brought for a violation of section 303 of the Act, no civil action shall be brought for any act or omission described in section 302 of the Act that occurs—

(1) Before July 26, 1992, against businesses with 25 or fewer employees and gross receipts of \$1,000,000 or less.

(2) Before January 26, 1993, against businesses with 10 or fewer employees and gross receipts of \$500,000 or less.

(c) *Transportation services provided by public accommodations.* Newly purchased or leased vehicles required to be accessible by § 36.310 must be readily accessible to and usable by individuals with disabilities, including individuals who use wheelchairs, if the solicitation for the vehicle is made after August 25, 1990.

§§ 36.509–36.600 [Reserved]

Subpart F—Certification of State Laws or Local Building Codes

§ 36.601 Definitions.

Assistant Attorney General means the Assistant Attorney General for Civil Rights or his or her designee.

Certification of equivalency means a final certification that a code meets or exceeds the minimum requirements of title III of the Act for accessibility and usability of facilities covered by that title.

Code means a State law or local building code or similar ordinance, or

part thereof, that establishes accessibility requirements.

Model code means a nationally recognized document developed by a private entity for use by State or local jurisdictions in developing codes as defined in this section. A model code is intended for incorporation by reference or adoption in whole or in part, with or without amendment, by State or local jurisdictions.

Preliminary determination of equivalency means a preliminary determination that a code appears to meet or exceed the minimum requirements of title III of the Act for accessibility and usability of facilities covered by that title.

Submitting official means the State or local official who—

(1) Has principal responsibility for administration of a code, or is authorized to submit a code on behalf of a jurisdiction; and

(2) Files a request for certification under this subpart.

§ 36.602 General rule.

On the application of a State or local government, the Assistant Attorney General may certify that a code meets or exceeds the minimum requirements of the Act for the accessibility and usability of places of public accommodation and commercial facilities under this part by issuing a certification of equivalency. At any enforcement proceeding under title III of the Act, such certification shall be rebuttable evidence that such State law or local ordinance does meet or exceed the minimum requirements of title III.

§ 36.603 Filing request for certification.

(a) A submitting official may file a request for certification of a code under this subpart.

(b) Before filing a request for certification of a code, the submitting official shall ensure that—

(1) Adequate public notice of intention to file a request for certification, notice of a hearing, and notice of the location at which the request and materials can be inspected is published within the relevant jurisdiction;

(2) Copies of the proposed request and supporting materials are made available for public examination and copying at the office of the State or local agency charged with administration and enforcement of the code; and

(3) The local or State jurisdiction holds a public hearing on the record, in the State or locality, at which the public is invited to comment on the proposed request for certification.

(c) The submitting official shall include the following materials and information in support of the request:

(1) The text of the jurisdiction's code; any standard, regulation, code, or other relevant document incorporated by reference or otherwise referenced in the code; the law creating and empowering the agency; any relevant manuals, guides, or any other interpretive information issued that pertain to the code; and any formal opinions of the State Attorney General or the chief legal officer of the jurisdiction that pertain to the code;

(2) Any model code or statute on which the pertinent code is based, and an explanation of any differences between the model and the pertinent code;

(3) A transcript of the public hearing required by paragraph (b)(3) of this section; and

(4) Any additional information that the submitting official may wish to be considered.

(d) The submitting official shall file the original and one copy of the request and of supporting materials with the Assistant Attorney General. The submitting official shall clearly label the request as a "request for certification" of a code. A copy of the request and supporting materials will be available for public examination and copying at the offices of the Assistant Attorney General in Washington, DC. The submitting official shall ensure that copies of the request and supporting materials are available for public examination and copying at the office of the State or local agency charged with administration and enforcement of the code. The submitting official shall ensure that adequate public notice of the request for certification and of the location at which the request and materials can be inspected is published within the relevant jurisdiction.

(e) Upon receipt of a request for certification, the Assistant Attorney General may request further information that he or she considers relevant to the determinations required to be made under this subpart.

§ 36.604 Preliminary determination.

After consultation with the Architectural and Transportation Barriers Compliance Board, the Assistant Attorney General shall make a preliminary determination of

equivalency or a preliminary determination to deny certification.

§ 36.605 Procedure following preliminary determination of equivalency.

(a) If the Assistant Attorney General makes a preliminary determination of equivalency under § 36.604, he or she shall inform the submitting official, in writing, of that preliminary determination. The Assistant Attorney General shall also—

(1) Publish a notice in the *Federal Register* that advises the public of the preliminary determination of equivalency with respect to the particular code, and invite interested persons and organizations, including individuals with disabilities, during a period of at least 60 days following publication of the notice, to file written comments relevant to whether a final certification of equivalency should be issued;

(2) After considering the information received in response to the notice described in paragraph (a) of this section, and after publishing a separate notice in the *Federal Register*, hold an informal hearing in Washington, DC at which interested persons, including individuals with disabilities, are provided an opportunity to express their views with respect to the preliminary determination of equivalency; and

(b) The Assistant Attorney General, after consultation with the Architectural and Transportation Barriers Compliance Board, and consideration of the materials and information submitted pursuant to this section and § 36.603, shall issue either a certification of equivalency or a final determination to deny the request for certification. He or she shall publish notice of the certification of equivalency or denial of certification in the *Federal Register*.

§ 36.606 Procedure following preliminary denial of certification.

(a) If the Assistant Attorney General makes a Preliminary determination to deny certification of a code under § 36.604, he or she shall notify the submitting official of the determination. The notification may include specification of the manner in which the code could be amended in order to qualify for certification.

(b) The Assistant Attorney General shall allow the submitting official not less than 15 days to submit data, views, and arguments in opposition to the preliminary determination to deny

certification. If the submitting official does not submit materials, the Assistant Attorney General shall not be required to take any further action. If the submitting official submits materials, the Assistant Attorney General shall evaluate those materials and any other relevant information. After evaluation of any newly submitted materials, the Assistant Attorney General shall make either a final denial of certification or a preliminary determination of equivalency.

§ 36.607 Effect of certification.

(a)(1) A certification shall be considered a certification of equivalency only with respect to those features or elements that are both covered by the certified code and addressed by the standards against which equivalency is measured.

(2) For example, if certain equipment is not covered by the code, the determination of equivalency cannot be used as evidence with respect to the question of whether equipment in a building built according to the code satisfies the Act's requirements with respect to such equipment. By the same token, certification would not be relevant to construction of a facility for children, if the regulations against which equivalency is measured do not address children's facilities.

(b) A certification of equivalency is effective only with respect to the particular edition of the code for which certification is granted. Any amendments or other changes to the code after the date of the certified edition are not considered part of the certification.

(c) A submitting official may reapply for certification of amendments or other changes to a code that has already received certification.

§ 36.608 Guidance concerning model codes.

Upon application by an authorized representative of a private entity responsible for developing a model code, the Assistant Attorney General may review the relevant model code and issue guidance concerning whether and in what respects the model code is consistent with the minimum requirements of the Act for the accessibility and usability of places of public accommodation and commercial facilities under this part.

§§ 36.609–36.999 [Reserved]

BILLING CODE 4410-01-M

Appendix A to Part 36—Standards for Accessible Design

**ADA ACCESSIBILITY GUIDELINES
FOR BUILDINGS AND FACILITIES
TABLE OF CONTENTS**

| | |
|--|----------|
| 1. PURPOSE | 1 |
| 2. GENERAL | 1 |
| 2.1 Provisions for Adults | 1 |
| 2.2 Equivalent Facilitation | 1 |
| 3. MISCELLANEOUS INSTRUCTIONS AND DEFINITIONS | 1 |
| 3.1 Graphic Conventions | 1 |
| 3.2 Dimensional Tolerances | 2 |
| 3.3 Notes | 2 |
| 3.4 General Terminology | 2 |
| 3.5 Definitions | 2 |
| 4. ACCESSIBLE ELEMENTS AND SPACES: SCOPE AND TECHNICAL REQUIREMENTS | 5 |
| 4.1 Minimum Requirements | 5 |
| 4.1.1. Application | 5 |
| 4.1.2. Accessible Sites and Exterior Facilities: New Construction | 5 |
| 4.1.3. Accessible Buildings: New Construction | 7 |
| 4.1.4. (Reserved) | 10 |
| 4.1.5. Accessible Buildings: Additions | 10 |
| 4.1.6. Accessible Buildings: Alterations | 11 |
| 4.1.7. Accessible Buildings: Historic Preservation | 13 |
| 4.2 Space Allowance and Reach Ranges | 14 |
| 4.3 Accessible Route | 15 |
| 4.4 Protruding Objects | 21 |
| 4.5 Ground and Floor Surfaces | 22 |
| 4.6 Parking and Passenger Loading Zones | 24 |
| 4.7 Curb Ramps | 26 |
| 4.8 Ramps | 27 |
| 4.9 Stairs | 30 |
| 4.10 Elevators | 30 |

| | |
|---|-----------|
| 4.11 Platform Lifts (Wheelchair Lifts) | 36 |
| 4.12 Windows | 36 |
| 4.13 Doors | 36 |
| 4.14 Entrances | 40 |
| 4.15 Drinking Fountains and Water Coolers | 40 |
| 4.16 Water Closets | 40 |
| 4.17 Toilet Stalls..... | 41 |
| 4.18 Urinals | 44 |
| 4.19 Lavatories and Mirrors | 44 |
| 4.20 Bathtubs | 45 |
| 4.21 Shower Stalls..... | 45 |
| 4.22 Toilet Rooms | 45 |
| 4.23 Bathrooms, Bathing Facilities, and Shower Rooms..... | 48 |
| 4.24 Sinks | 49 |
| 4.25 Storage | 49 |
| 4.26 Handrails, Grab Bars, and Tub and Shower Seats | 50 |
| 4.27 Controls and Operating Mechanisms | 51 |
| 4.28 Alarms | 52 |
| 4.29 Detectable Warnings | 53 |
| 4.30 Signage..... | 53 |
| 4.31 Telephones | 54 |
| 4.32 Fixed or Built-in Seating and Tables | 56 |
| 4.33 Assembly Areas | 56 |
| 4.34 Automated Teller Machines | 58 |
| 4.35 Dressing and Fitting Rooms | 58 |
| 5. RESTAURANTS AND CAFETERIAS. | 59 |
| 6. MEDICAL CARE FACILITIES | 60 |
| 7. BUSINESS AND MERCANTILE | 61 |
| 8. LIBRARIES | 62 |
| 9. ACCESSIBLE TRANSIENT LODGING | 63 |
| 10. TRANSPORTATION FACILITIES | 67 |
| APPENDIX | A1 |

1. PURPOSE.

This document sets guidelines for accessibility to places of public accommodation and commercial facilities by individuals with disabilities. These guidelines are to be applied during the design, construction, and alteration of such buildings and facilities to the extent required by regulations issued by Federal agencies, including the Department of Justice, under the Americans with Disabilities Act of 1990.

The technical specifications 4.2 through 4.35, of these guidelines are the same as those of the American National Standard Institute's document A117.1-1980, except as noted in this text by italics. However, sections 4.1.1 through 4.1.7 and sections 5 through 10 are different from ANSI A117.1 in their entirety and are printed in standard type.

The illustrations and text of ANSI A117.1 are reproduced with permission from the American National Standards Institute. Copies of the standard may be purchased from the American National Standards Institute at 1430 Broadway, New York, New York 10018.

2. GENERAL.







2.1 Provisions for Adults. *The specifications in these guidelines are based upon adult dimensions and anthropometrics.*

2.2* Equivalent Facilitation. *Departures from particular technical and scoping requirements of this guideline by the use of other designs and technologies are permitted where the alternative designs and technologies used will provide substantially equivalent or greater access to and usability of the facility.*

3. MISCELLANEOUS INSTRUCTIONS AND DEFINITIONS.

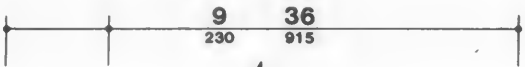
3.1 Graphic Conventions. Graphic conventions are shown in Table 1. Dimensions that are not marked minimum or maximum are absolute, unless otherwise indicated in the text or captions.

Table 1
Graphic Conventions

| Convention | Description |
|---|--|
|  | Typical dimension line showing U.S. customary units (in inches) above the line and SI units (in millimeters) below |
|  | Dimensions for short distances indicated on extended line |
|  | Dimension line showing alternate dimensions required |
|  | Direction of approach |
| max | Maximum |
| min | Minimum |
|  | Boundary of clear floor area |
|  | Centerline |

3.4 General Terminology

3.2 Dimensional Tolerances. All dimensions are subject to conventional building industry tolerances for field conditions.

3.3 Notes. The text of *these guidelines* does not contain notes or footnotes. Additional information, explanations, and advisory materials are located in the Appendix. Paragraphs marked with an asterisk have related, non-mandatory material in the Appendix. In the Appendix, the corresponding paragraph numbers are preceded by an A.

3.4 General Terminology.

comply with. Meet one or more specifications of *these guidelines*.

if... then. Denotes a specification that applies only when the conditions described are present.

may. Denotes an option or alternative.

shall. Denotes a mandatory specification or requirement.

should. Denotes an advisory specification or recommendation.

3.5 Definitions.

Access Aisle. An accessible pedestrian space between elements, such as parking spaces, seating, and desks, that provides clearances appropriate for use of the elements.

Accessible. Describes a site, building, facility, or portion thereof that complies with *these guidelines*.

Accessible Element. An *element* specified by *these guidelines* (for example, telephone, controls, and the like).

Accessible Route. A continuous unobstructed path connecting all accessible elements and spaces of a building or facility. Interior accessible routes may include corridors, floors, ramps, elevators, lifts, and clear floor space at fixtures. Exterior accessible routes may include parking access aisles, curb ramps, *crosswalks at vehicular ways*, walks, ramps, and lifts.

Accessible Space. Space that complies with *these guidelines*.

Adaptability. The ability of certain building spaces and elements, such as kitchen counters, sinks, and grab bars, to be added or altered so as to accommodate the needs of *individuals with or without disabilities* or to accommodate the needs of persons with different types or degrees of disability.

Addition. An expansion, extension, or increase in the gross floor area of a building or facility.

Administrative Authority. A governmental agency that adopts or enforces regulations and *guidelines* for the design, construction, or alteration of buildings and facilities.

Alteration. An alteration is a change to a building or facility made by, on behalf of, or for the use of a public accommodation or commercial facility, that affects or could affect the usability of the building or facility or part thereof. Alterations include, but are not limited to, remodeling, renovation, rehabilitation, reconstruction, historic restoration, changes or rearrangement of the structural parts or elements, and changes or rearrangement in the plan configuration of walls and full-height partitions. Normal maintenance, reroofing, painting or wallpapering, or changes to mechanical and electrical systems are not alterations unless they affect the usability of the building or facility.

Area of Rescue Assistance. An area, which has direct access to an exit, where people who are unable to use stairs may remain temporarily in safety to await further instructions or assistance during emergency evacuation.

Assembly Area. A room or space accommodating a group of individuals for recreational, educational, political, social, or amusement purposes, or for the consumption of food and drink.

Automatic Door. A door equipped with a power-operated mechanism and controls that open and close the door automatically upon receipt of a momentary actuating signal. The switch that begins the automatic cycle may be a photoelectric device, floor mat, or manual switch (see power-assisted door).

3.5 Definitions

Building. Any structure used and intended for supporting or sheltering any use or occupancy.

Circulation Path. An exterior or interior way of passage from one place to another for pedestrians, including, but not limited to, walks, hallways, courtyards, stairways, and stair landings.

Clear. Unobstructed.

Clear Floor Space. The minimum unobstructed floor or ground space required to accommodate a single, stationary wheelchair and occupant.

Closed Circuit Telephone. A telephone with dedicated line(s) such as a house phone, courtesy phone or phone that must be used to gain entrance to a facility.

Common Use. Refers to those interior and exterior rooms, spaces, or elements that are made available for the use of a restricted group of people (for example, occupants of a homeless shelter, the occupants of an office building, or the guests of such occupants).

Cross Slope. The slope that is perpendicular to the direction of travel (see running slope).

Curb Ramp. A short ramp cutting through a curb or built up to it.

Detectable Warning. A standardized surface feature built in or applied to walking surfaces or other elements to warn visually impaired people of hazards on a circulation path.

Dwelling Unit. A single unit which provides a kitchen or food preparation area, in addition to rooms and spaces for living, bathing, sleeping, and the like. Dwelling units include a single family home or a townhouse used as a transient group home; an apartment building used as a shelter; guestrooms in a hotel that provide sleeping accommodations and food preparation areas; and other similar facilities used on a transient basis. For purposes of these guidelines, use of the term "Dwelling Unit" does not imply the unit is used as a residence.

Egress Means of. A continuous and unobstructed way of exit travel from any point in a building or facility to a public way. A means of egress comprises vertical and horizontal travel

and may include intervening room spaces, doorways, hallways, corridors, passageways, balconies, ramps, stairs, enclosures, lobbies, horizontal exits, courts and yards. An accessible means of egress is one that complies with these guidelines and does not include stairs, steps, or escalators. Areas of rescue assistance or evacuation elevators may be included as part of accessible means of egress.

Element. An architectural or mechanical component of a building, facility, space, or site, e.g., telephone, curb ramp, door, drinking fountain, seating, or water closet.

Entrance. Any access point to a building or portion of a building or facility used for the purpose of entering. An entrance includes the approach walk, the vertical access leading to the entrance platform, the entrance platform itself, vestibules if provided, the entry door(s) or gate(s), and the hardware of the entry door(s) or gate(s).

Facility. All or any portion of buildings, structures, site improvements, complexes, equipment, roads, walks, passageways, parking lots, or other real or personal property located on a site.

Ground Floor. Any occupiable floor less than one story above or below grade with direct access to grade. A building or facility always has at least one ground floor and may have more than one ground floor as where a split level entrance has been provided or where a building is built into a hillside.

Mezzanine or Mezzanine Floor. That portion of a story which is an intermediate floor level placed within the story and having occupiable space above and below its floor.

Marked Crossing. A crosswalk or other identified path intended for pedestrian use in crossing a vehicular way.

Multifamily Dwelling. Any building containing more than two dwelling units.

Occupiable. A room or enclosed space designed for human occupancy in which individuals congregate for amusement, educational or similar purposes, or in which occupants are engaged at labor, and which is equipped with means of egress, light, and ventilation.

3.5 Definitions

Operable Part. A part of a piece of equipment or appliance used to insert or withdraw objects, or to activate, deactivate, or adjust the equipment or appliance (for example, coin slot, pushbutton, handle).

Path of Travel. (Reserved).

Power-assisted Door. A door used for human passage with a mechanism that helps to open the door, or relieves the opening resistance of a door, upon the activation of a switch or a continued force applied to the door itself.

Public Use. Describes interior or exterior rooms or spaces that are made available to the general public. Public use may be provided at a building or facility that is privately or publicly owned.

Ramp. A walking surface which has a running slope greater than 1:20.

Running Slope. The slope that is parallel to the direction of travel (see cross slope).

Service Entrance. An entrance intended primarily for delivery of goods or services.

Signage. Displayed verbal, symbolic, tactile, and pictorial information.

Site. A parcel of land bounded by a property line or a designated portion of a public right-of-way.

Site Improvement. Landscaping, paving for pedestrian and vehicular ways, outdoor lighting, recreational facilities, and the like, added to a site.

Sleeping Accommodations. Rooms in which people sleep; for example, dormitory and hotel or motel guest rooms or suites.

Space. A definable area, e.g., room, toilet room, hall, assembly area, entrance, storage room, alcove, courtyard, or lobby.

Story. That portion of a building included between the upper surface of a floor and upper surface of the floor or roof next above. If such

portion of a building does not include occupiable space, it is not considered a story for purposes of these guidelines. There may be more than one floor level within a story as in the case of a mezzanine or mezzanines.

Structural Frame. The structural frame shall be considered to be the columns and the girders, beams, trusses and spandrels having direct connections to the columns and all other members which are essential to the stability of the building as a whole.

Tactile. Describes an object that can be perceived using the sense of touch.

Text Telephone. Machinery or equipment that employs interactive graphic (i.e., typed) communications through the transmission of coded signals across the standard telephone network. Text telephones can include, for example, devices known as TDD's (telecommunication display devices or telecommunication devices for deaf persons) or computers.

Transient Lodging. A building, facility, or portion thereof, excluding inpatient medical care facilities, that contains one or more dwelling units or sleeping accommodations. Transient lodging may include, but is not limited to, resorts, group homes, hotels, motels, and dormitories.

Vehicular Way. A route intended for vehicular traffic, such as a street, driveway, or parking lot.

Walk. An exterior pathway with a prepared surface intended for pedestrian use, including general pedestrian areas such as plazas and courts.

NOTE: Sections 4.1.1 through 4.1.7 are different from ANSI A117.1 in their entirety and are printed in standard type (ANSI A117.1 does not include scoping provisions).

4.0 Accessible Elements and Spaces: Scope and Technical Requirements**4. ACCESSIBLE ELEMENTS AND SPACES: SCOPE AND TECHNICAL REQUIREMENTS.****4.1 Minimum Requirements****4.1.1* Application.**

(1) General. All areas of newly designed or newly constructed buildings and facilities required to be accessible by 4.1.2 and 4.1.3 and altered portions of existing buildings and facilities required to be accessible by 4.1.6 shall comply with these guidelines, 4.1 through 4.35, unless otherwise provided in this section or as modified in a special application section.

(2) Application Based on Building Use. Special application sections 5 through 10 provide additional requirements for restaurants and cafeterias, medical care facilities, business and mercantile, libraries, accessible transient lodging, and transportation facilities. When a building or facility contains more than one use covered by a special application section, each portion shall comply with the requirements for that use.

(3)* Areas Used Only by Employees as Work Areas. Areas that are used only as work areas shall be designed and constructed so that individuals with disabilities can approach, enter, and exit the areas. These guidelines do not require that any areas used only as work areas be constructed to permit maneuvering within the work area or be constructed or equipped (i.e., with racks or shelves) to be accessible.

(4) Temporary Structures. These guidelines cover temporary buildings or facilities as well as permanent facilities. Temporary buildings and facilities are not of permanent construction but are extensively used or are essential for public use for a period of time. Examples of temporary buildings or facilities covered by these guidelines include, but are not limited to: reviewing stands, temporary classrooms, bleacher areas, exhibit areas, temporary banking facilities, temporary health screening services, or temporary safe pedestrian passageways around a construction site. Structures,

sites and equipment directly associated with the actual processes of construction, such as scaffolding, bridging, materials hoists, or construction trailers are not included.

(5) General Exceptions.

(a) In new construction, a person or entity is not required to meet fully the requirements of these guidelines where that person or entity can demonstrate that it is structurally impracticable to do so. Full compliance will be considered structurally impracticable only in those rare circumstances when the unique characteristics of terrain prevent the incorporation of accessibility features. If full compliance with the requirements of these guidelines is structurally impracticable, a person or entity shall comply with the requirements to the extent it is not structurally impracticable. Any portion of the building or facility which can be made accessible shall comply to the extent that it is not structurally impracticable.

(b) Accessibility is not required to (i) observation galleries used primarily for security purposes; or (ii) in non-occupiable spaces accessed only by ladders, catwalks, crawl spaces, very narrow passageways, or freight (non-passenger) elevators, and frequented only by service personnel for repair purposes; such spaces include, but are not limited to, elevator pits, elevator penthouses, piping or equipment catwalks.

4.1.2 Accessible Sites and Exterior Facilities: New Construction. An accessible site shall meet the following minimum requirements:

(1) At least one accessible route complying with 4.3 shall be provided within the boundary of the site from public transportation stops, accessible parking spaces, passenger loading zones if provided, and public streets or sidewalks, to an accessible building entrance.

(2) At least one accessible route complying with 4.3 shall connect accessible buildings, accessible facilities, accessible elements, and accessible spaces that are on the same site.

(3) All objects that protrude from surfaces or posts into circulation paths shall comply with 4.4.

4.1.2 Accessible Sites and Exterior Facilities: New Construction

(4) Ground surfaces along accessible routes and in accessible spaces shall comply with 4.5.

(5) (a) If parking spaces are provided for self-parking by employees or visitors, or both, then accessible spaces complying with 4.6 shall be provided in each such parking area in conformance with the table below. Spaces required by the table need not be provided in the particular lot. They may be provided in a different location if equivalent or greater accessibility, in terms of distance from an accessible entrance, cost and convenience is ensured.

| Total Parking in Lot | Required Minimum Number of Accessible Spaces |
|----------------------|--|
| 1 to 25 | 1 |
| 26 to 50 | 2 |
| 51 to 75 | 3 |
| 76 to 100 | 4 |
| 101 to 150 | 5 |
| 151 to 200 | 6 |
| 201 to 300 | 7 |
| 301 to 400 | 8 |
| 401 to 500 | 9 |
| 501 to 1000 | 2 percent of total |
| 1001 and over | 20 plus 1 for each 100 over 1000 |

Except as provided in (b), access aisles adjacent to accessible spaces shall be 60 in (1525 mm) wide minimum.

(b) One in every eight accessible spaces, but not less than one, shall be served by an access aisle 96 in (2440 mm) wide minimum and shall be designated "van accessible" as required by 4.6.4. The vertical clearance at such spaces shall comply with 4.6.5. All such spaces may be grouped on one level of a parking structure.

EXCEPTION: Provision of all required parking spaces in conformance with "Universal Parking Design" (see appendix A4.6.3) is permitted.

(c) If passenger loading zones are provided, then at least one passenger loading zone shall comply with 4.6.6.

(d) At facilities providing medical care and other services for persons with mobility impairments, parking spaces complying with 4.6 shall

be provided in accordance with 4.1.2(5)(a) except as follows:

(i) Outpatient units and facilities: 10 percent of the total number of parking spaces provided serving each such outpatient unit or facility;

(ii) Units and facilities that specialize in treatment or services for persons with mobility impairments: 20 percent of the total number of parking spaces provided serving each such unit or facility.

(e)*Valet parking: Valet parking facilities shall provide a passenger loading zone complying with 4.6.6 located on an accessible route to the entrance of the facility. Paragraphs 5(a), 5(b), and 5(d) of this section do not apply to valet parking facilities.

(6) If toilet facilities are provided on a site, then each such public or common use toilet facility shall comply with 4.22. If bathing facilities are provided on a site, then each such public or common use bathing facility shall comply with 4.23.

For single user portable toilet or bathing units clustered at a single location, at least 5% but no less than one toilet unit or bathing unit complying with 4.22 or 4.23 shall be installed at each cluster whenever typical inaccessible units are provided. Accessible units shall be identified by the International Symbol of Accessibility.

EXCEPTION: Portable toilet units at construction sites used exclusively by construction personnel are not required to comply with 4.1.2(6).

(7) Building Signage. Signs which designate permanent rooms and spaces shall comply with 4.30.1, 4.30.4, 4.30.5 and 4.30.6. Other signs which provide direction to, or information about, functional spaces of the building shall comply with 4.30.1, 4.30.2, 4.30.3, and 4.30.5. Elements and spaces of accessible facilities which shall be identified by the International Symbol of Accessibility and which shall comply with 4.30.7 are:

(a) Parking spaces designated as reserved for individuals with disabilities;

4.1.3 Accessible Buildings: New Construction

(b) Accessible passenger loading zones;

(c) Accessible entrances when not all are accessible (inaccessible entrances shall have directional signage to indicate the route to the nearest accessible entrance);

(d) Accessible toilet and bathing facilities when not all are accessible.

4.1.3 Accessible Buildings: New Construction. Accessible buildings and facilities shall meet the following minimum requirements:

(1) At least one accessible route complying with 4.3 shall connect accessible building or facility entrances with all accessible spaces and elements within the building or facility.

(2) All objects that overhang or protrude into circulation paths shall comply with 4.4.

(3) Ground and floor surfaces along accessible routes and in accessible rooms and spaces shall comply with 4.5.

(4) Interior and exterior stairs connecting levels that are not connected by an elevator, ramp, or other accessible means of vertical access shall comply with 4.9.

(5)* One passenger elevator complying with 4.10 shall serve each level, including mezzanines, in all multi-story buildings and facilities unless exempted below. If more than one elevator is provided, each full passenger elevator shall comply with 4.10.

EXCEPTION 1: Elevators are not required in facilities that are less than three stories or that have less than 3000 square feet per story unless the building is a shopping center, a shopping mall, or the professional office of a health care provider, or another type of facility as determined by the Attorney General. The elevator exemption set forth in this paragraph does not obviate or limit in any way the obligation to comply with the other accessibility requirements established in section 4.1.3. For example, floors above or below the accessible ground floor must meet the requirements of this section except for elevator service. If toilet or bathing facilities are provided on a level not served by an elevator, then toilet or bathing facilities must be provided on the accessible

ground floor. In new construction if a building or facility is eligible for this exemption but a full passenger elevator is nonetheless planned, that elevator shall meet the requirements of 4.10 and shall serve each level in the building. A full passenger elevator that provides service from a garage to only one level of a building or facility is not required to serve other levels.

EXCEPTION 2: Elevator pits, elevator penthouses, mechanical rooms, piping or equipment catwalks are exempted from this requirement.

EXCEPTION 3: Accessible ramps complying with 4.8 may be used in lieu of an elevator.

EXCEPTION 4: Platform lifts (wheelchair lifts) complying with 4.11 of this guideline and applicable state or local codes may be used in lieu of an elevator only under the following conditions:

(a) To provide an accessible route to a performing area in an assembly occupancy.

(b) To comply with the wheelchair viewing position line-of-sight and dispersion requirements of 4.33.3.

(c) To provide access to incidental occupiable spaces and rooms which are not open to the general public and which house no more than five persons, including but not limited to equipment control rooms and projection booths.

(d) To provide access where existing site constraints or other constraints make use of a ramp or an elevator infeasible.

(6) Windows: (Reserved).

(7) Doors:

(a) At each accessible entrance to a building or facility, at least one door shall comply with 4.13.

(b) Within a building or facility, at least one door at each accessible space shall comply with 4.13.

(c) Each door that is an element of an accessible route shall comply with 4.13.

4.1.3 Accessible Buildings: New Construction

(d) Each door required by 4.3.10, Egress, shall comply with 4.13.

(8) In new construction, at a minimum, the requirements in (a) and (b) below shall be satisfied independently:

(a)(i) At least 50% of all public entrances (excluding those in (b) below) must be accessible. At least one must be a ground floor entrance. Public entrances are any entrances that are not loading or service entrances.

(ii) Accessible entrances must be provided in a number at least equivalent to the number of exits required by the applicable building/fire codes. (This paragraph does not require an increase in the total number of entrances planned for a facility.)

(iii) An accessible entrance must be provided to each tenancy in a facility (for example, individual stores in a strip shopping center).

One entrance may be considered as meeting more than one of the requirements in (a). Where feasible, accessible entrances shall be the entrances used by the majority of people visiting or working in the building.

(b)(i) In addition, if direct access is provided for pedestrians from an enclosed parking garage to the building, at least one direct entrance from the garage to the building must be accessible.

(ii) If access is provided for pedestrians from a pedestrian tunnel or elevated walkway, one entrance to the building from each tunnel or walkway must be accessible.

One entrance may be considered as meeting more than one of the requirements in (b).

Because entrances also serve as emergency exits whose proximity to all parts of buildings and facilities is essential, it is preferable that all entrances be accessible.

(c) If the only entrance to a building, or tenancy in a facility, is a service entrance, that entrance shall be accessible.

(d) Entrances which are not accessible shall have directional signage complying with 4.30.1,

4.30.2, 4.30.3, and 4.30.5, which indicates the location of the nearest accessible entrance.

(9)* In buildings or facilities, or portions of buildings or facilities, required to be accessible, accessible means of egress shall be provided in the same number as required for exits by local building/life safety regulations. Where a required exit from an occupiable level above or below a level of accessible exit discharge is not accessible, an area of rescue assistance shall be provided on each such level (in a number equal to that of inaccessible required exits). Areas of rescue assistance shall comply with 4.3.11. A horizontal exit, meeting the requirements of local building/life safety regulations, shall satisfy the requirement for an area of rescue assistance.

EXCEPTION: Areas of rescue assistance are not required in buildings or facilities having a supervised automatic sprinkler system.

(10)* Drinking Fountains:

(a) Where only one drinking fountain is provided on a floor there shall be a drinking fountain which is accessible to individuals who use wheelchairs in accordance with 4.15 and one accessible to those who have difficulty bending or stooping. (This can be accommodated by the use of a "hi-lo" fountain; by providing one fountain accessible to those who use wheelchairs and one fountain at a standard height convenient for those who have difficulty bending; by providing a fountain accessible under 4.15 and a water cooler; or by such other means as would achieve the required accessibility for each group on each floor.)

(b) Where more than one drinking fountain or water cooler is provided on a floor, 50% of those provided shall comply with 4.15 and shall be on an accessible route.

(11) Toilet Facilities: If toilet rooms are provided, then each public and common use toilet room shall comply with 4.22. Other toilet rooms provided for the use of occupants of specific spaces (i.e., a private toilet room for the occupant of a private office) shall be adaptable. If bathing rooms are provided, then each public and common use bathroom shall comply with 4.23. Accessible toilet rooms and bathing facilities shall be on an accessible route.

4.1.3 Accessible Buildings: New Construction

(12) Storage, Shelving and Display Units:

(a) If fixed or built-in storage facilities such as cabinets, shelves, closets, and drawers are provided in accessible spaces, at least one of each type provided shall contain storage space complying with 4.25. Additional storage may be provided outside of the dimensions required by 4.25.

(b) Shelves or display units allowing self-service by customers in mercantile occupancies shall be located on an accessible route complying with 4.3. Requirements for accessible reach range do not apply.

(13) Controls and operating mechanisms in accessible spaces, along accessible routes, or as parts of accessible elements (for example, light switches and dispenser controls) shall comply with 4.27.

(14) If emergency warning systems are provided, then they shall include both audible alarms and visual alarms complying with 4.28. Sleeping accommodations required to comply with 9.3 shall have an alarm system complying with 4.28. Emergency warning systems in medical care facilities may be modified to suit standard health care alarm design practice.

(15) Detectable warnings shall be provided at locations as specified in 4.29.

(16) Building Signage:

(a) Signs which designate permanent rooms and spaces shall comply with 4.30.1, 4.30.4, 4.30.5 and 4.30.6.

(b) Other signs which provide direction to or information about functional spaces of the building shall comply with 4.30.1, 4.30.2, 4.30.3, and 4.30.5.

EXCEPTION: Building directories, menus, and all other signs which are temporary are not required to comply.

(17) Public Telephones:

(a) If public pay telephones, public closed circuit telephones, or other public telephones are provided, then they shall comply with 4.31.2 through 4.31.8 to the extent required by the following table:

| Number of each type of telephones provided on each floor | Number of telephones required to comply with 4.31.2 through 4.31.8 ¹ |
|--|---|
| 1 or more single unit | 1 per floor |
| 1 bank ² | 1 per floor |
| 2 or more banks ² | 1 per bank. Accessible unit may be installed as a single unit in proximity (either visible or with signage) to the bank. At least one public telephone per floor shall meet the requirements for a forward reach telephone ³ . |

¹ Additional public telephones may be installed at any height. Unless otherwise specified, accessible telephones may be either forward or side reach telephones.

² A bank consists of two or more adjacent public telephones, often installed as a unit.

³ EXCEPTION: For exterior installations only, if dial tone first service is available, then a side reach telephone may be installed instead of the required forward reach telephone (i.e., one telephone in proximity to each bank shall comply with 4.31).

(b)* All telephones required to be accessible and complying with 4.31.2 through 4.31.8 shall be equipped with a volume control. In addition, 25 percent, but never less than one, of all other public telephones provided shall be equipped with a volume control and shall be dispersed among all types of public telephones, including closed circuit telephones, throughout the building or facility. Signage complying with applicable provisions of 4.30.7 shall be provided.

(c) The following shall be provided in accordance with 4.31.9:

(i) if a total number of four or more public pay telephones (including both interior and exterior phones) is provided at a site, and at least one is in an interior location, then at least one interior public text telephone shall be provided.

(ii) if an interior public pay telephone is provided in a stadium or arena, in a convention center, in a hotel with a convention center, or

4.1.3 Accessible Buildings: New Construction

in a covered mall, at least one interior public text telephone shall be provided in the facility.

(iii) If a public pay telephone is located in or adjacent to a hospital emergency room, hospital recovery room, or hospital waiting room, one public text telephone shall be provided at each such location.

(d) Where a bank of telephones in the interior of a building consists of three or more public pay telephones, at least one public pay telephone in each such bank shall be equipped with a shelf and outlet in compliance with 4.31.9(2).

(18) If fixed or built-in seating or tables (including, but not limited to, study carrels and student laboratory stations), are provided in accessible public or common use areas, at least five percent (5%), but not less than one, of the fixed or built-in seating areas or tables shall comply with 4.32. An accessible route shall lead to and through such fixed or built-in seating areas, or tables.

(19)* Assembly areas:

(a) In places of assembly with fixed seating accessible wheelchair locations shall comply with 4.33.2, 4.33.3, and 4.33.4 and shall be provided consistent with the following table:

| Capacity of Seating in Assembly Areas | Number of Required Wheelchair Locations |
|---------------------------------------|--|
| 4 to 25 | 1 |
| 26 to 50 | 2 |
| 51 to 300 | 4 |
| 301 to 500 | 6 |
| over 500 | 6, plus 1 additional space for each total seating capacity increase of 100 |

In addition, one percent, but not less than one, of all fixed seats shall be aisle seats with no armrests on the aisle side, or removable or folding armrests on the aisle side. Each such seat shall be identified by a sign or marker. Signage notifying patrons of the availability of such seats shall be posted at the ticket office. Aisle seats are not required to comply with 4.33.4.

(b) This paragraph applies to assembly areas where audible communications are integral to the use of the space (e.g., concert and lecture halls, playhouses and movie theaters, meeting rooms, etc.). Such assembly areas, if (1) they accommodate at least 50 persons, or if they have audio-amplification systems, and (2) they have fixed seating, shall have a permanently installed assistive listening system complying with 4.33. For other assembly areas, a permanently installed assistive listening system, or an adequate number of electrical outlets or other supplementary wiring necessary to support a portable assistive listening system shall be provided. The minimum number of receivers to be provided shall be equal to 4 percent of the total number of seats, but in no case less than two. Signage complying with applicable provisions of 4.30 shall be installed to notify patrons of the availability of a listening system.

(20) Where automated teller machines (ATMs) are provided, each ATM shall comply with the requirements of 4.34 except where two or more are provided at a location, then only one must comply.

EXCEPTION: Drive-up-only automated teller machines are not required to comply with 4.27.2, 4.27.3 and 4.34.3.

(21) Where dressing and fitting rooms are provided for use by the general public, patients, customers or employees, 5 percent, but never less than one, of dressing rooms for each type of use in each cluster of dressing rooms shall be accessible and shall comply with 4.35.

Examples of types of dressing rooms are those serving different genders or distinct and different functions as in different treatment or examination facilities.

4.1.4 (Reserved).

4.1.5 Accessible Buildings: Additions.

Each addition to an existing building or facility shall be regarded as an alteration. Each space or element added to the existing building or facility shall comply with the applicable provisions of 4.1.1 to 4.1.3, Minimum Requirements (for New Construction) and the applicable technical specifications of 4.2 through 4.35 and sections 5 through 10. Each addition that

4.1.6 Accessible Buildings: Alterations

affects or could affect the usability of an area containing a primary function shall comply with 4.1.6(2).

4.1.6 Accessible Buildings: Alterations.

(1) General. Alterations to existing buildings and facilities shall comply with the following:

(a) No alteration shall be undertaken which decreases or has the effect of decreasing accessibility or usability of a building or facility below the requirements for new construction at the time of alteration.

(b) If existing elements, spaces, or common areas are altered, then each such altered element, space, feature, or area shall comply with the applicable provisions of 4.1.1 to 4.1.3 Minimum Requirements (for New Construction). If the applicable provision for new construction requires that an element, space, or common area be on an accessible route, the altered element, space, or common area is not required to be on an accessible route except as provided in 4.1.6(2) (Alterations to an Area Containing a Primary Function.)

(c) If alterations of single elements, when considered together, amount to an alteration of a room or space in a building or facility, the entire space shall be made accessible.

(d) No alteration of an existing element, space, or area of a building or facility shall impose a requirement for greater accessibility than that which would be required for new construction. For example, if the elevators and stairs in a building are being altered and the elevators are, in turn, being made accessible, then no accessibility modifications are required to the stairs connecting levels connected by the elevator. If stair modifications to correct unsafe conditions are required by other codes, the modifications shall be done in compliance with these guidelines unless technically infeasible.

(e) At least one interior public text telephone complying with 4.31.9 shall be provided if:

(i) alterations to existing buildings or facilities with less than four exterior or interior public pay telephones would increase the total number to four or more telephones with at least one in an interior location; or

(ii) alterations to one or more exterior or interior public pay telephones occur in an existing building or facility with four or more public telephones with at least one in an interior location.

(f) If an escalator or stair is planned or installed where none existed previously and major structural modifications are necessary for such installation, then a means of accessible vertical access shall be provided that complies with the applicable provisions of 4.7, 4.8, 4.10, or 4.11.

(g) In alterations, the requirements of 4.1.3(9), 4.3.10 and 4.3.11 do not apply.

(h)*Entrances: If a planned alteration entails alterations to an entrance, and the building has an accessible entrance, the entrance being altered is not required to comply with 4.1.3(8), except to the extent required by 4.1.6(2). If a particular entrance is not made accessible, appropriate accessible signage indicating the location of the nearest accessible entrance(s) shall be installed at or near the inaccessible entrance, such that a person with disabilities will not be required to retrace the approach route from the inaccessible entrance.

(i) If the alteration work is limited solely to the electrical, mechanical, or plumbing system, or to hazardous material abatement, or automatic sprinkler retrofitting, and does not involve the alteration of any elements or spaces required to be accessible under these guidelines, then 4.1.6(2) does not apply.

(j) EXCEPTION: In alteration work, if compliance with 4.1.6 is technically infeasible, the alteration shall provide accessibility to the maximum extent feasible. Any elements or features of the building or facility that are being altered and can be made accessible shall be made accessible within the scope of the alteration.

Technically Infeasible. Means, with respect to an alteration of a building or a facility, that it has little likelihood of being accomplished because existing structural conditions would require removing or altering a load-bearing member which is an essential part of the structural frame; or because other existing physical or site constraints prohibit modification or

4.1.6 Accessible Buildings: Alterations

addition of elements, spaces, or features which are in full and strict compliance with the minimum requirements for new construction and which are necessary to provide accessibility.

(k) EXCEPTION:

(i) These guidelines do not require the installation of an elevator in an altered facility that is less than three stories or has less than 3,000 square feet per story unless the building is a shopping center, a shopping mall, the professional office of a health care provider, or another type of facility as determined by the Attorney General.

(ii) The exemption provided in paragraph (i) does not obviate or limit in any way the obligation to comply with the other accessibility requirements established in these guidelines. For example, alterations to floors above or below the ground floor must be accessible regardless of whether the altered facility has an elevator. If a facility subject to the elevator exemption set forth in paragraph (i) nonetheless has a full passenger elevator, that elevator shall meet, to the maximum extent feasible, the accessibility requirements of these guidelines.

(2) Alterations to an Area Containing a Primary Function: In addition to the requirements of 4.1.6(1), an alteration that affects or could affect the usability of or access to an area containing a primary function shall be made so as to ensure that, to the maximum extent feasible, the path of travel to the altered area and the restrooms, telephones, and drinking fountains serving the altered area, are readily accessible to and usable by individuals with disabilities, unless such alterations are disproportionate to the overall alterations in terms of cost and scope (as determined under criteria established by the Attorney General).

(3) Special Technical Provisions for Alterations to Existing Buildings and Facilities:

(a) Ramps: Curb ramps and interior or exterior ramps to be constructed on sites or in existing buildings or facilities where space limitations prohibit the use of a 1:12 slope or less may have slopes and rises as follows:

(i) A slope between 1:10 and 1:12 is allowed for a maximum rise of 6 inches.

(ii) A slope between 1:8 and 1:10 is allowed for a maximum rise of 3 inches. A slope steeper than 1:8 is not allowed.

(b) Stairs: Full extension of handrails at stairs shall not be required in alterations where such extensions would be hazardous or impossible due to plan configuration.

(c) Elevators:

(i) If safety door edges are provided in existing automatic elevators, automatic door reopening devices may be omitted (see 4.10.6).

(ii) Where existing shaft configuration or technical infeasibility prohibits strict compliance with 4.10.9, the minimum car plan dimensions may be reduced by the minimum amount necessary, but in no case shall the inside car area be smaller than 48 in by 48 in.

(iii) Equivalent facilitation may be provided with an elevator car of different dimensions when usability can be demonstrated and when all other elements required to be accessible comply with the applicable provisions of 4.10. For example, an elevator of 47 in by 69 in (1195 mm by 1755 mm) with a door opening on the narrow dimension, could accommodate the standard wheelchair clearances shown in Figure 4.

(d) Doors:

(i) Where it is technically infeasible to comply with clear opening width requirements of 4.13.5, a projection of 5/8 in maximum will be permitted for the latch side stop.

(ii) If existing thresholds are 3/4 in high or less, and have (or are modified to have) a beveled edge on each side, they may remain.

(e) Toilet Rooms:

(i) Where it is technically infeasible to comply with 4.22 or 4.23, the installation of at least one unisex toilet/bathroom per floor, located in the same area as existing toilet facilities, will be permitted in lieu of modifying existing toilet facilities to be accessible. Each unisex toilet room shall contain one water closet complying with 4.16 and one lavatory complying with 4.19, and the door shall have a privacy latch.

4.1.7 Accessible Buildings: Historic Preservation

(ii) Where it is technically infeasible to install a required standard stall (Fig. 30(a)), or where other codes prohibit reduction of the fixture count (i.e., removal of a water closet in order to create a double-wide stall), either alternate stall (Fig. 30(b)) may be provided in lieu of the standard stall.

(iii) When existing toilet or bathing facilities are being altered and are not made accessible, signage complying with 4.30.1, 4.30.2, 4.30.3, 4.30.5, and 4.30.7 shall be provided indicating the location of the nearest accessible toilet or bathing facility within the facility.

(f) Assembly Areas:

(i) Where it is technically infeasible to disperse accessible seating throughout an altered assembly area, accessible seating areas may be clustered. Each accessible seating area shall have provisions for companion seating and shall be located on an accessible route that also serves as a means of emergency egress.

(ii) Where it is technically infeasible to alter all performing areas to be on an accessible route, at least one of each type of performing area shall be made accessible.

(g) Platform Lifts (Wheelchair Lifts): In alterations, platform lifts (wheelchair lifts) complying with 4.11 and applicable state or local codes may be used as part of an accessible route. The use of lifts is not limited to the four conditions in exception 4 of 4.1.3(5).

(h) Dressing Rooms: In alterations where technical infeasibility can be demonstrated, one dressing room for each sex on each level shall be made accessible. Where only unisex dressing rooms are provided, accessible unisex dressing rooms may be used to fulfill this requirement.

4.1.7 Accessible Buildings: Historic Preservation.**(1) Applicability:**

(a) General Rule. Alterations to a qualified historic building or facility shall comply with 4.1.6 Accessible Buildings: Alterations, the applicable technical specifications of 4.2

through 4.35 and the applicable special application sections 5 through 10 unless it is determined in accordance with the procedures in 4.1.7(2) that compliance with the requirements for accessible routes (exterior and interior), ramps, entrances, or toilets would threaten or destroy the historic significance of the building or facility in which case the alternative requirements in 4.1.7(3) may be used for the feature.

EXCEPTION: (Reserved).

(b) Definition. A qualified historic building or facility is a building or facility that is:

(i) Listed in or eligible for listing in the National Register of Historic Places; or

(ii) Designated as historic under an appropriate State or local law.

(2) Procedures:

(a) Alterations to Qualified Historic Buildings and Facilities Subject to Section 106 of the National Historic Preservation Act:

(i) Section 106 Process. Section 106 of the National Historic Preservation Act (16 U.S.C. 470 f) requires that a Federal agency with jurisdiction over a Federal, federally assisted, or federally licensed undertaking consider the effects of the agency's undertaking on buildings and facilities listed in or eligible for listing in the National Register of Historic Places and give the Advisory Council on Historic Preservation a reasonable opportunity to comment on the undertaking prior to approval of the undertaking.

(ii) ADA Application. Where alterations are undertaken to a qualified historic building or facility that is subject to section 106 of the National Historic Preservation Act, the Federal agency with jurisdiction over the undertaking shall follow the section 106 process. If the State Historic Preservation Officer or Advisory Council on Historic Preservation agrees that compliance with the requirements for accessible routes (exterior and interior); ramps, entrances, or toilets would threaten or destroy the historic significance of the building or facility, the alternative requirements in 4.1.7(3) may be used for the feature.

4.2 Space Allowance and Reach Ranges

(b) Alterations to Qualified Historic Buildings and Facilities Not Subject to Section 106 of the National Historic Preservation Act. Where alterations are undertaken to a qualified historic building or facility that is not subject to section 106 of the National Historic Preservation Act, if the entity undertaking the alterations believes that compliance with the requirements for accessible routes (exterior and interior), ramps, entrances, or toilets would threaten or destroy the historic significance of the building or facility and that the alternative requirements in 4.1.7(3) should be used for the feature, the entity should consult with the State Historic Preservation Officer. If the State Historic Preservation Officer agrees that compliance with the accessibility requirements for accessible routes (exterior and interior), ramps, entrances or toilets would threaten or destroy the historical significance of the building or facility, the alternative requirements in 4.1.7(3) may be used.

(c) Consultation With Interested Persons. Interested persons should be invited to participate in the consultation process, including State or local accessibility officials, individuals with disabilities, and organizations representing individuals with disabilities.

(d) Certified Local Government Historic Preservation Programs. Where the State Historic Preservation Officer has delegated the consultation responsibility for purposes of this section to a local government historic preservation program that has been certified in accordance with section 101(c) of the National Historic Preservation Act of 1966 (16 U.S.C. 470a (c)) and implementing regulations (36 CFR 61.5), the responsibility may be carried out by the appropriate local government body or official.

(3) Historic Preservation: Minimum Requirements:

(a) At least one accessible route complying with 4.3 from a site access point to an accessible entrance shall be provided.

EXCEPTION: A ramp with a slope no greater than 1:6 for a run not to exceed 2 ft (610 mm) may be used as part of an accessible route to an entrance.

(b) At least one accessible entrance complying with 4.14 which is used by the public shall be provided.

EXCEPTION: If it is determined that no entrance used by the public can comply with 4.14, then access at any entrance not used by the general public but open (unlocked) with directional signage at the primary entrance may be used. The accessible entrance shall also have a notification system. Where security is a problem, remote monitoring may be used.

(c) If toilets are provided, then at least one toilet facility complying with 4.22 and 4.1.6 shall be provided along an accessible route that complies with 4.3. Such toilet facility may be unisex in design.

(d) Accessible routes from an accessible entrance to all publicly used spaces on at least the level of the accessible entrance shall be provided. Access shall be provided to all levels of a building or facility in compliance with 4.1 whenever practical.

(e) Displays and written information, documents, etc., should be located where they can be seen by a seated person. Exhibits and signage displayed horizontally (e.g., open books), should be no higher than 44 in (1120 mm) above the floor surface.

NOTE: The technical provisions of sections 4.2 through 4.35 are the same as those of the American National Standard Institute's document A117.1-1980, except as noted in the text.

4.2 Space Allowance and Reach Ranges.

4.2.1* Wheelchair Passage Width. The minimum clear width for single wheelchair passage shall be 32 in (815 mm) at a point and 36 in (915 mm) continuously (see Fig. 1 and 24(e)).

4.2.2 Width for Wheelchair Passing. The minimum width for two wheelchairs to pass is 60 in (1525 mm) (see Fig. 2).

4.2.3* Wheelchair Turning Space. The space required for a wheelchair to make a 180-degree turn is a clear space of 60 in (1525 mm)

4.2.4* Clear Floor or Ground Space for Wheelchairs

diameter (see Fig. 3(a)) or a T-shaped space (see Fig. 3(b)).

4.2.4* Clear Floor or Ground Space for Wheelchairs.

4.2.4.1 Size and Approach. The minimum clear floor or ground space required to accommodate a single, stationary wheelchair and occupant is 30 in by 48 in (760 mm by 1220 mm) (see Fig. 4(a)). The minimum clear floor or ground space for wheelchairs may be positioned for forward or parallel approach to an object (see Fig. 4(b) and (c)). Clear floor or ground space for wheelchairs may be part of the knee space required under some objects.

4.2.4.2 Relationship of Maneuvering Clearance to Wheelchair Spaces. One full unobstructed side of the clear floor or ground space for a wheelchair shall adjoin or overlap an accessible route or adjoin another wheelchair clear floor space. If a clear floor space is located in an alcove or otherwise confined on all or part of three sides, additional maneuvering clearances shall be provided as shown in Fig. 4(d) and (e).

4.2.4.3 Surfaces for Wheelchair Spaces. Clear floor or ground spaces for wheelchairs shall comply with 4.5.

4.2.5* Forward Reach. If the clear floor space only allows forward approach to an object, the maximum high forward reach allowed shall be 48 in (1220 mm) (see Fig. 5(a)). The minimum low forward reach is 15 in (380 mm). If the high forward reach is over an obstruction, reach and clearances shall be as shown in Fig. 5(b).

4.2.6* Side Reach. If the clear floor space allows parallel approach by a person in a wheelchair, the maximum high side reach allowed shall be 54 in (1370 mm) and the low side reach shall be no less than 9 in (230 mm) above the floor (Fig. 6(a) and (b)). If the side reach is over an obstruction, the reach and clearances shall be as shown in Fig 6(c).

4.3 Accessible Route.

4.3.1* General. All walks, halls, corridors, aisles, skywalks, tunnels, and other spaces

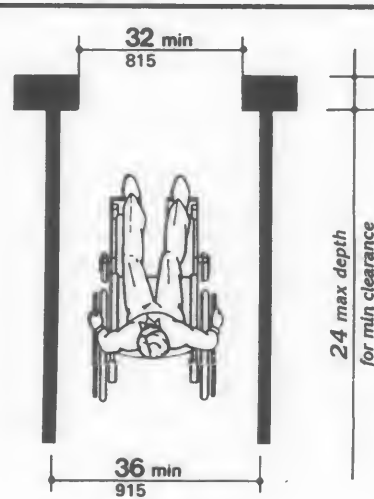

Fig. 1
Minimum Clear Width
for Single Wheelchair

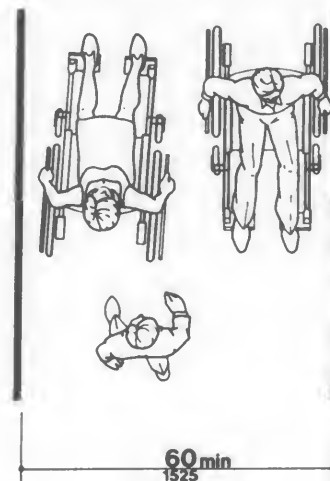

Fig. 2
Minimum Clear Width
for Two Wheelchairs

4.3 Accessible Route

that are part of an accessible route shall comply with 4.3.

4.3.2 Location.

(1) At least one accessible route *within the boundary of the site* shall be provided from public transportation stops, accessible parking, and accessible passenger loading zones, and public streets or sidewalks to the accessible building entrance they serve. *The accessible route shall, to the maximum extent feasible, coincide with the route for the general public.*

(2) At least one accessible route shall connect accessible buildings, facilities, elements, and spaces that are on the same site.

(3) At least one accessible route shall connect accessible building or facility entrances with all accessible spaces and elements and with all accessible dwelling units within the building or facility.

(4) An accessible route shall connect at least one accessible entrance of each accessible

dwelling unit with those exterior and interior spaces and facilities that serve the accessible dwelling unit.

4.3.3 Width. The minimum clear width of an accessible route shall be 36 in (915 mm) except at doors (see 4.13.5 and 4.13.6). If a person in a wheelchair must make a turn around an obstruction, the minimum clear width of the accessible route shall be as shown in Fig. 7(a) and (b).

4.3.4 Passing Space. If an accessible route has less than 60 in (1525 mm) clear width, then passing spaces at least 60 in by 60 in (1525 mm by 1525 mm) shall be located at reasonable intervals not to exceed 200 ft (61 m). A T-intersection of two corridors or walks is an acceptable passing place.

4.3.5 Head Room. Accessible routes shall comply with 4.4.2.

4.3.6 Surface Textures. The surface of an accessible route shall comply with 4.5.

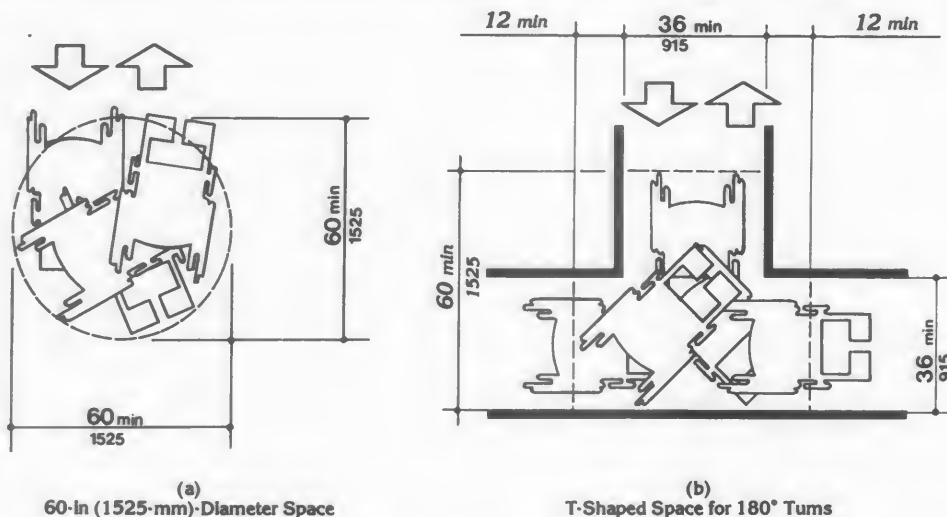

Fig. 3
Wheelchair Turning Space

4.3 Accessible Route

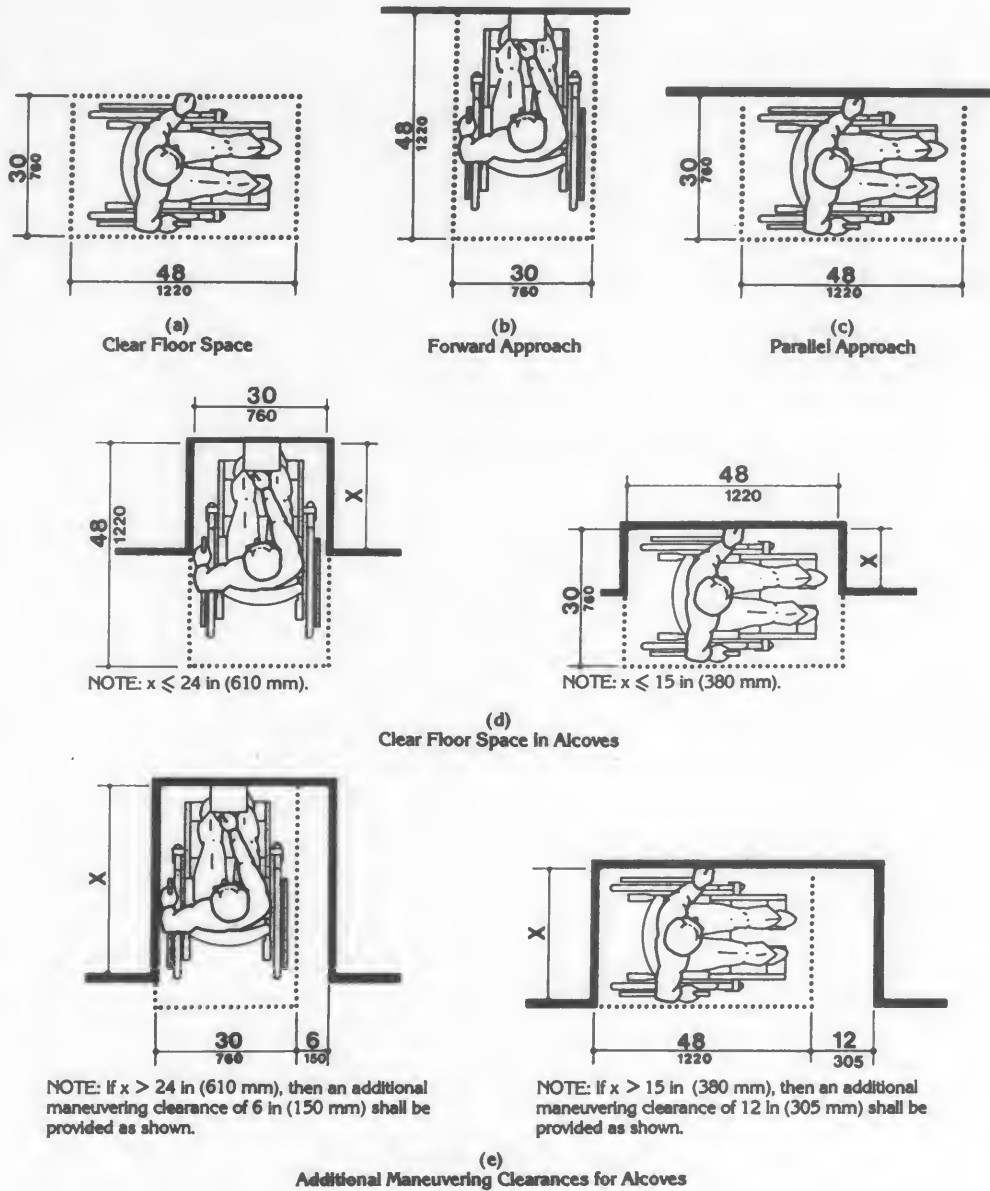
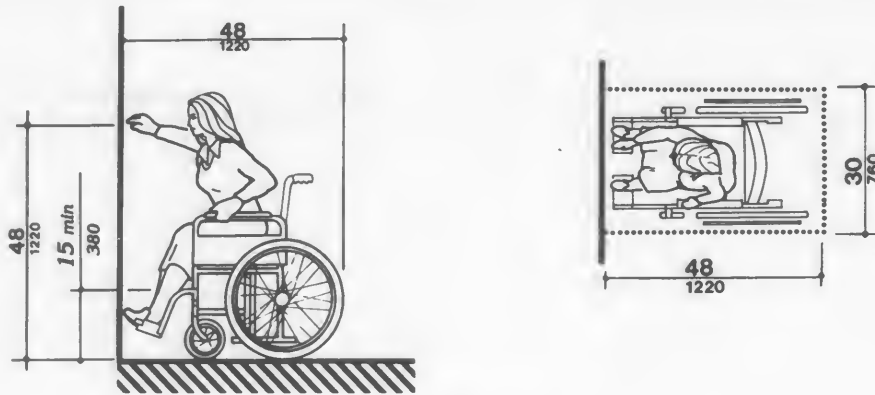
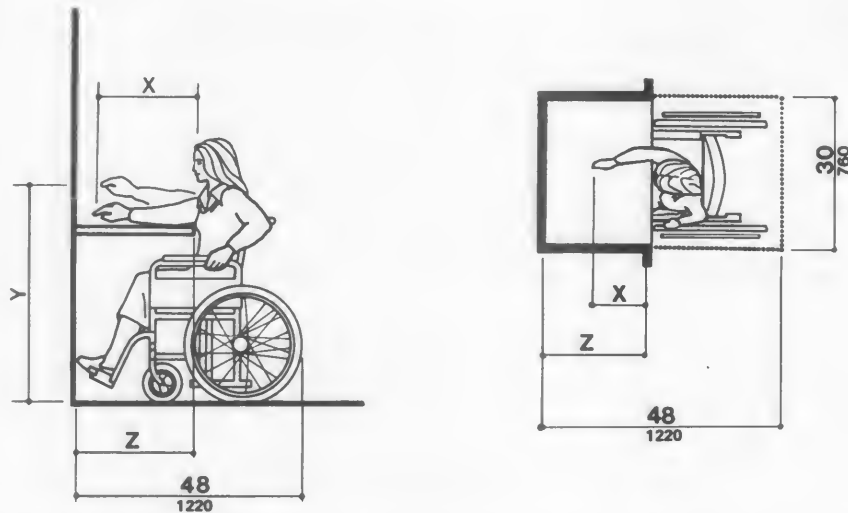

Fig. 4
Minimum Clear Floor Space for Wheelchairs

4.3 Accessible Route



(a)
High Forward Reach Limit



NOTE: x shall be ≤ 25 in (635 mm); z shall be $\geq x$. When $x < 20$ in (510 mm), then y shall be 48 in (1220 mm) maximum. When x is 20 to 25 in (510 to 635 mm), then y shall be 44 in (1120 mm) maximum.

(b)
Maximum Forward Reach over an Obstruction

Fig. 5
Forward Reach

4.3.7 Slope

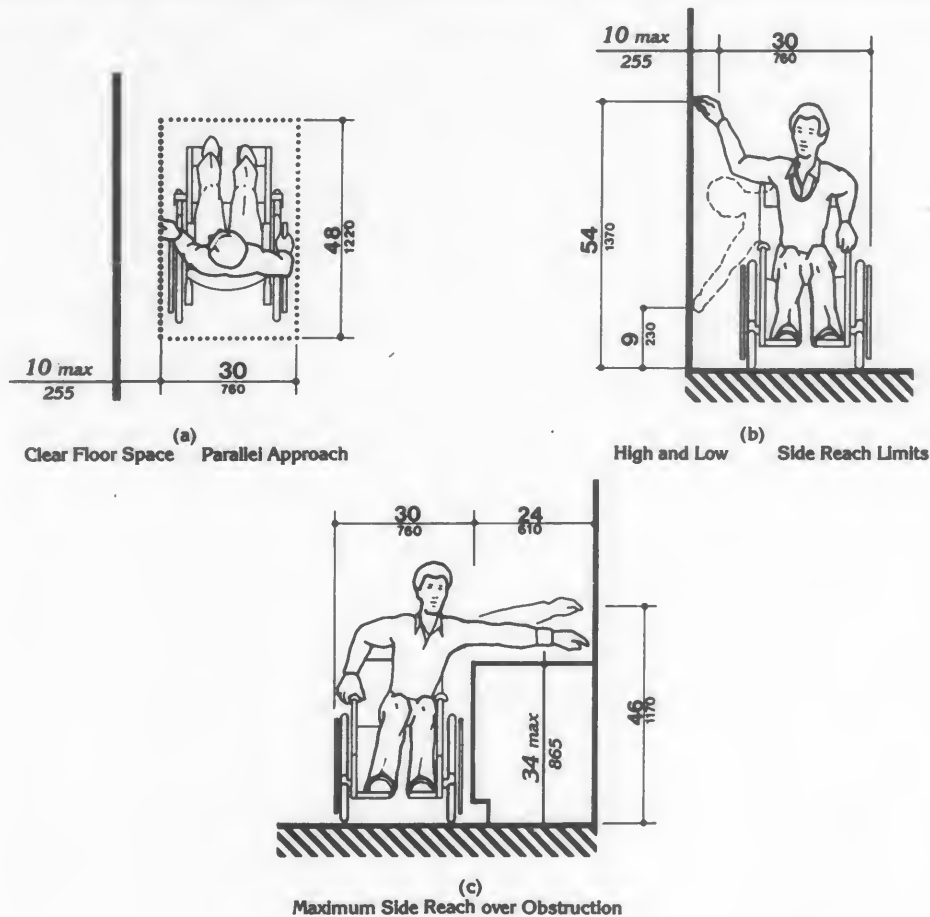

Fig. 6
Side Reach

4.3.7 Slope. An accessible route with a running slope greater than 1:20 is a ramp and shall comply with 4.8. Nowhere shall the cross slope of an accessible route exceed 1:50.

4.3.8 Changes in Levels. Changes in levels along an accessible route shall comply with 4.5.2. If an accessible route has changes in level greater than 1/2 in (13 mm), then a curb

ramp, ramp, elevator, or platform lift (as permitted in 4.1.3 and 4.1.6) shall be provided that complies with 4.7, 4.8, 4.10, or 4.11, respectively. An accessible route does not include stairs, steps, or escalators. See definition of "egress, means of" in 3.5.

4.3.9 Doors. Doors along an accessible route shall comply with 4.13.

4.3.10* Egress

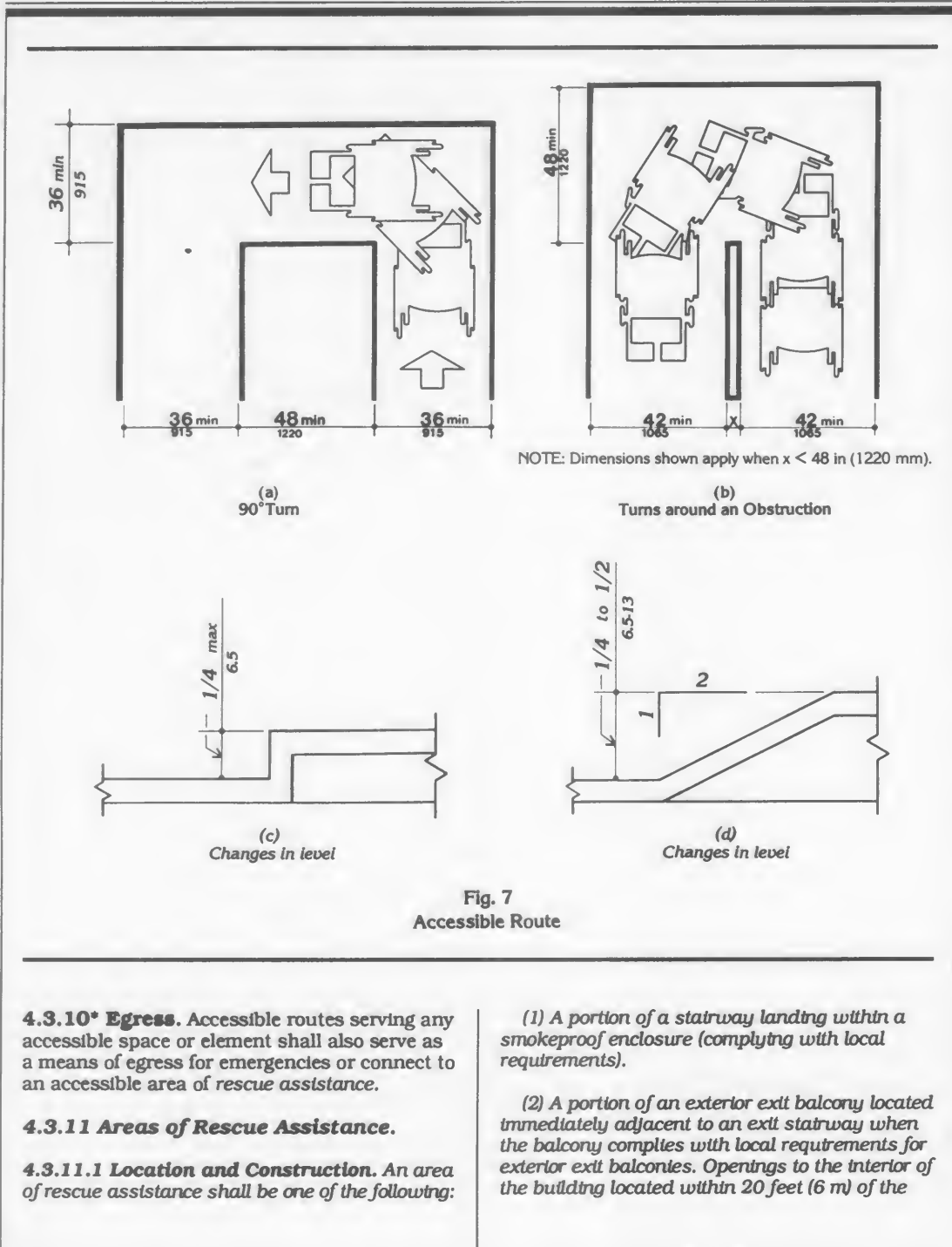

4.3.10* Egress. Accessible routes serving any accessible space or element shall also serve as a means of egress for emergencies or connect to an accessible area of rescue assistance.

4.3.11 Areas of Rescue Assistance.

4.3.11.1 Location and Construction. An area of rescue assistance shall be one of the following:

(1) A portion of a stairway landing within a smokeproof enclosure (complying with local requirements).

(2) A portion of an exterior exit balcony located immediately adjacent to an exit stairway when the balcony complies with local requirements for exterior exit balconies. Openings to the interior of the building located within 20 feet (6 m) of the

4.4 Protruding Objects

area of rescue assistance shall be protected with fire assemblies having a three-fourths hour fire protection rating.

(3) A portion of a one-hour fire-resistive corridor (complying with local requirements for fire-resistive construction and for openings) located immediately adjacent to an exit enclosure.

(4) A vestibule located immediately adjacent to an exit enclosure and constructed to the same fire-resistive standards as required for corridors and openings.

(5) A portion of a stairway landing within an exit enclosure which is vented to the exterior and is separated from the interior of the building with not less than one-hour fire-resistive doors.

(6) When approved by the appropriate local authority, an area or a room which is separated from other portions of the building by a smoke barrier. Smoke barriers shall have a fire-resistive rating of not less than one hour and shall completely enclose the area or room. Doors in the smoke barrier shall be tight-fitting smoke and draft-control assemblies having a fire-protection rating of not less than 20 minutes and shall be self-closing or automatic closing. The area or room shall be provided with an exit directly to an exit enclosure. Where the room or area exits into an exit enclosure which is required to be of more than one-hour fire-resistive construction, the room or area shall have the same fire-resistive construction, including the same opening protection, as required for the adjacent exit enclosure.

(7) An elevator lobby when elevator shafts and adjacent lobbies are pressurized as required for smokeproof enclosures by local regulations and when complying with requirements herein for size, communication, and signage. Such pressurization system shall be activated by smoke detectors on each floor located in a manner approved by the appropriate local authority. Pressurization equipment and its duct work within the building shall be separated from other portions of the building by a minimum two-hour fire-resistive construction.

4.3.11.2 Size. Each area of rescue assistance shall provide at least two accessible areas each being not less than 30 inches by 48 inches (760 mm by 1220 mm). The area of rescue

assistance shall not encroach on any required exit width. The total number of such 30-inch by 48-inch (760 mm by 1220 mm) areas per story shall be not less than one for every 200 persons of calculated occupant load served by the area of rescue assistance.

EXCEPTION: The appropriate local authority may reduce the minimum number of 30-inch by 48-inch (760 mm by 1220 mm) areas to one for each area of rescue assistance on floors where the occupant load is less than 200.

4.3.11.3* Stairway Width. Each stairway adjacent to an area of rescue assistance shall have a minimum clear width of 48 inches between handrails.

4.3.11.4* Two-way Communication. A method of two-way communication, with both visible and audible signals, shall be provided between each area of rescue assistance and the primary entry. The fire department or appropriate local authority may approve a location other than the primary entry.

4.3.11.5 Identification. Each area of rescue assistance shall be identified by a sign which states "AREA OF RESCUE ASSISTANCE" and displays the international symbol of accessibility. The sign shall be illuminated when exit sign illumination is required. Signage shall also be installed at all inaccessible exits and where otherwise necessary to clearly indicate the direction to areas of rescue assistance. In each area of rescue assistance, instructions on the use of the area under emergency conditions shall be posted adjoining the two-way communication system.

4.4 Protruding Objects.

4.4.1* General. Objects projecting from walls (for example, telephones) with their leading edges between 27 in and 80 in (685 mm and 2030 mm) above the finished floor shall protrude no more than 4 in (100 mm) into walks, halls, corridors, passageways, or aisles (see Fig. 8(a)). Objects mounted with their leading edges at or below 27 in (685 mm) above the finished floor may protrude any amount (see Fig. 8(a) and (b)). Free-standing objects mounted on posts or pylons may overhang 12 in (305 mm) maximum from 27 in to 80 in (685 mm to 2030 mm) above the ground or

4.4 Protruding Objects

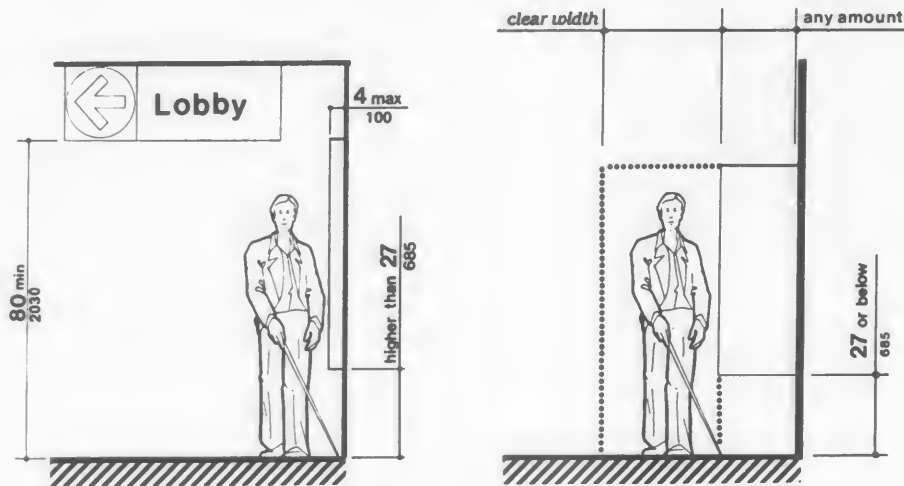

Fig. 8 (a)
Walking Parallel to a Wall



Fig. 8 (b)
Walking Perpendicular to a Wall

Fig. 8
Protruding Objects

finished floor (see Fig. 8(c) and (d)). Protruding objects shall not reduce the clear width of an accessible route or maneuvering space (see Fig. 8(c)).

4.4.2 Head Room. Walks, halls, corridors, passageways, aisles, or other circulation spaces shall have 80 in (2030 mm) minimum clear head room (see Fig. 8(a)). If vertical clearance of an area adjoining an accessible route is reduced to less than 80 in (nominal dimension), a barrier to warn blind or visually-impaired persons shall be provided (see Fig. 8(c-1)).

4.5 Ground and Floor Surfaces.

4.5.1* General. Ground and floor surfaces along accessible routes and in accessible rooms and spaces including floors, walks, ramps, stairs, and curb ramps, shall be stable, firm, slip-resistant, and shall comply with 4.5.

4.5.2 Changes in Level. Changes in level up to 1/4 in (6 mm) may be vertical and without edge treatment (see Fig. 7(c)). Changes in level between 1/4 in and 1/2 in (6 mm and 13 mm)

4.4 Protruding Objects

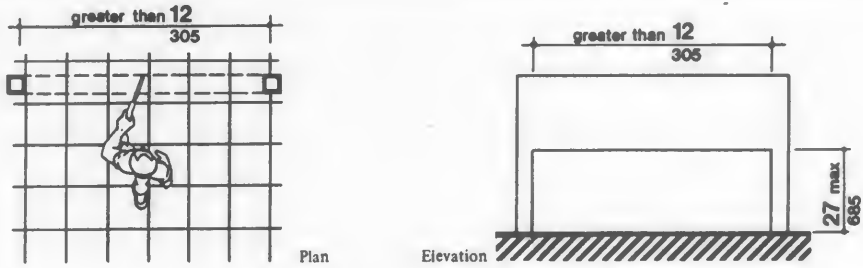

Fig. 8 (c) Free-Standing Overhanging Objects

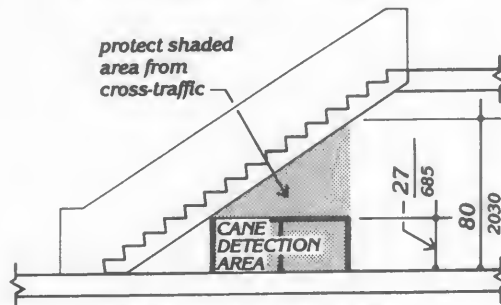

Fig. 8 (c-1) Overhead Hazards

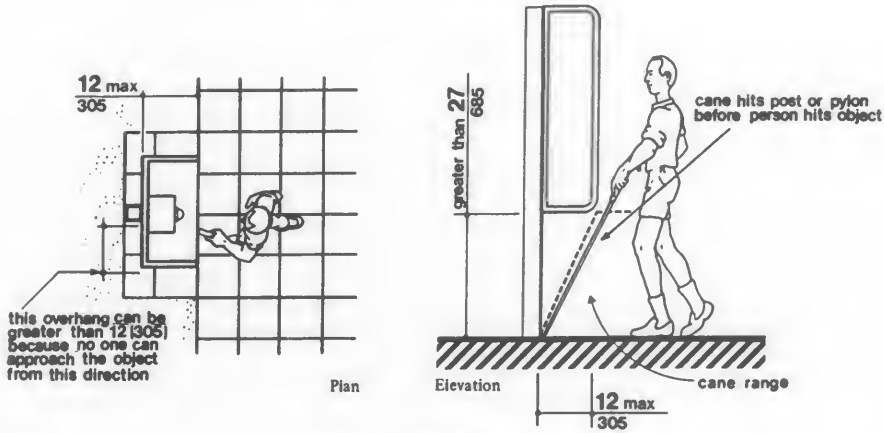

Fig. 8 (d)
Objects Mounted on Posts or Pylons

Fig. 8
Protruding Objects (Continued)

4.5 Ground and Floor Surfaces

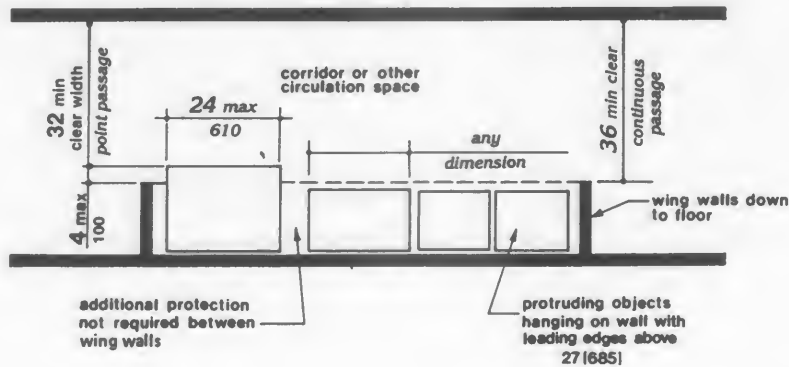

Fig. 8 (e)
Example of Protection around Wall-Mounted Objects and Measurements of Clear Widths

Fig. 8
Protruding Objects (Continued)

shall be beveled with a slope no greater than 1:2 (see Fig. 7(d)). Changes in level greater than 1/2 in (13 mm) shall be accomplished by means of a ramp that complies with 4.7 or 4.8.

4.5.3* Carpet. If carpet or carpet tile is used on a ground or floor surface, then it shall be securely attached; have a firm cushion, pad, or backing, or no cushion or pad; and have a level loop, textured loop, level cut pile, or level cut/uncut pile texture. The maximum pile thickness shall be 1/2 in (13 mm) (see Fig. 8(f)). Exposed edges of carpet shall be fastened to floor surfaces and have trim along the entire length of the exposed edge. Carpet edge trim shall comply with 4.5.2.

4.5.4 Gratings. If gratings are located in walking surfaces, then they shall have spaces no greater than 1/2 in (13 mm) wide in one direction (see Fig. 8(g)). If gratings have elongated openings, then they shall be placed so that the long dimension is perpendicular to the dominant direction of travel (see Fig. 8(h)).

4.6 Parking and Passenger Loading Zones.

4.6.1 Minimum Number. Parking spaces required to be accessible by 4.1 shall comply with 4.6.2 through 4.6.5. Passenger loading zones required to be accessible by 4.1 shall comply with 4.6.5 and 4.6.6.

4.6 Parking and Passenger Loading Zones

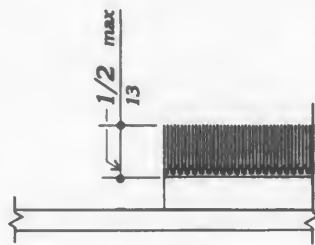

Fig. 8 (f)
Carpet Pile Thickness

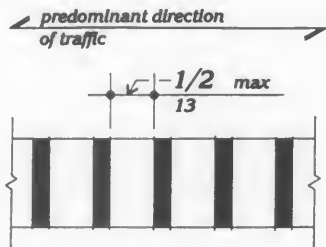

Fig. 8 (g)
Gratings

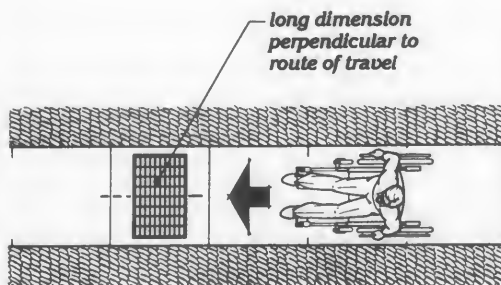

Fig. 8 (h)
Grating Orientation

4.6.2 Location. Accessible parking spaces serving a particular building shall be located on the shortest accessible route of travel from adjacent parking to an accessible entrance. In parking facilities that do not serve a particular building, accessible parking shall be located on the shortest accessible route of travel to an accessible pedestrian entrance of the parking facility. In buildings with multiple accessible entrances with adjacent parking, accessible parking spaces shall be dispersed and located closest to the accessible entrances.

4.6.3* Parking Spaces. Accessible parking spaces shall be at least 96 in (2440 mm) wide. Parking access aisles shall be part of an accessible route to the building or facility entrance and shall comply with 4.3. Two accessible parking spaces may share a common access aisle (see Fig. 9). Parked vehicle overhangs shall not reduce the clear width of an accessible route. Parking spaces and access aisles shall be level with surface slopes not exceeding 1:50 (2%) in all directions.

4.6.4* Signage. Accessible parking spaces shall be designated as reserved by a sign showing the symbol of accessibility (see 4.30.7). Spaces complying with 4.1.2(5)(b) shall have an additional sign "Van-Accessible" mounted below the symbol of accessibility. Such signs shall be located so they cannot be obscured by a vehicle parked in the space.

4.6.5* Vertical Clearance. Provide minimum vertical clearance of 114 in (2895 mm) at accessible passenger loading zones and along at least one vehicle access route to such areas from site entrance(s) and exit(s). At parking spaces complying with 4.1.2(5)(b), provide minimum vertical clearance of 98 in (2490 mm) at the parking space and along at least one vehicle access route to such spaces from site entrance(s) and exit(s).

4.6.6 Passenger Loading Zones. Passenger loading zones shall provide an access aisle at least 60 in (1525 mm) wide and 20 ft (240 in) (6100 mm) long adjacent and parallel to the vehicle pull-up space (see Fig. 10). If there are curbs between the access aisle and the vehicle pull-up space, then a curb ramp complying with 4.7 shall be provided. Vehicle standing spaces and access aisles shall be level with

4.7 Curb Ramps

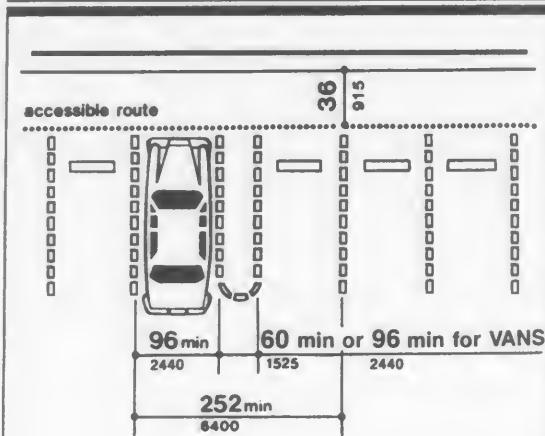

Fig. 9
Dimensions of Parking Spaces

surface slopes not exceeding 1:50 (2%) in all directions.

4.7 Curb Ramps.

4.7.1 Location. Curb ramps complying with 4.7 shall be provided wherever an accessible route crosses a curb.

4.7.2 Slope. Slopes of curb ramps shall comply with 4.8.2. The slope shall be measured as shown in Fig. 11. *Transitions from ramps to walks, gutters, or streets shall be flush and free of abrupt changes. Maximum slopes of adjoining gutters, road surface immediately adjacent to the curb ramp, or accessible route shall not exceed 1:20.*

4.7.3 Width. The minimum width of a curb ramp shall be 36 in (915 mm), exclusive of flared sides.

4.7.4 Surface. Surfaces of curb ramps shall comply with 4.5.

4.7.5 Sides of Curb Ramps. If a curb ramp is located where pedestrians must walk across the ramp, or where it is not protected by handrails or guardrails, it shall have flared sides; the maximum slope of the flare shall be 1:10 (see Fig. 12(a)). Curb ramps with returned curbs

may be used where pedestrians would not normally walk across the ramp (see Fig. 12(b)).

4.7.6 Built-up Curb Ramps. Built-up curb ramps shall be located so that they do not project into vehicular traffic lanes (see Fig. 13).

4.7.7 Detectable Warnings. A curb ramp shall have a detectable warning complying with 4.29.2. *The detectable warning shall extend the full width and depth of the curb ramp.*

4.7.8 Obstructions. Curb ramps shall be located or protected to prevent their obstruction by parked vehicles.

4.7.9 Location at Marked Crossings. Curb ramps at marked crossings shall be wholly contained within the markings, excluding any flared sides (see Fig. 15).

4.7.10 Diagonal Curb Ramps. If diagonal (or corner type) curb ramps have returned curbs or other well-defined edges, such edges shall be parallel to the direction of pedestrian flow. The bottom of diagonal curb ramps shall have 48 in (1220 mm) minimum clear space as shown in Fig. 15(c) and (d). If diagonal curb ramps are provided at marked crossings, the 48 in (1220 mm) clear space shall be within the markings (see Fig. 15(c) and (d)). If diagonal curb ramps have flared sides, they shall also have at least a 24 in (610 mm) long segment of straight curb located on each side of the curb ramp and within the marked crossing (see Fig. 15(c)).

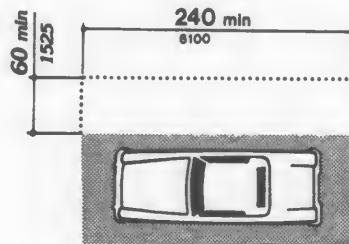

Fig. 10
Access Aisle at Passenger Loading Zones

4.8 Ramps

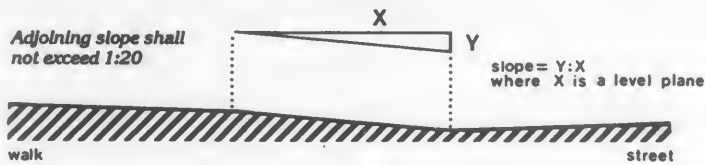

Fig. 11
Measurement of Curb Ramp Slopes

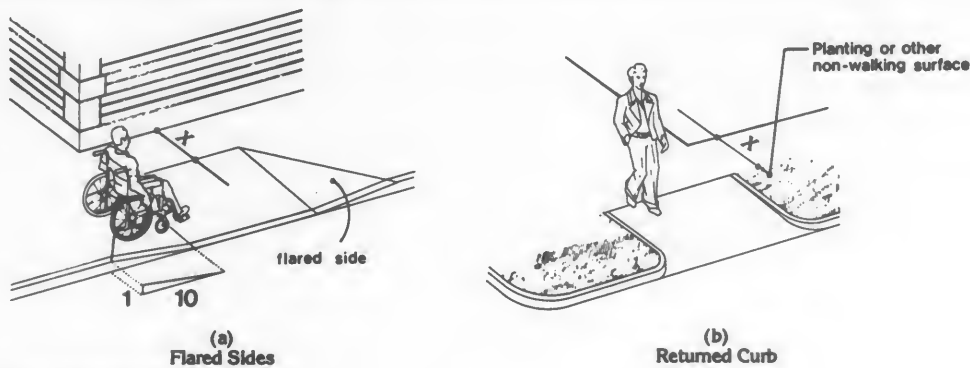

Fig. 12
Sides of Curb Ramps

4.7.11 Islands. Any raised islands in crossings shall be cut through level with the street or have curb ramps at both sides and a level area at least 48 in (1220 mm) long between the curb ramps in the part of the island intersected by the crossings (see Fig. 15(a) and (b)).

4.8 Ramps.

4.8.1* General. Any part of an accessible route with a slope greater than 1:20 shall be considered a ramp and shall comply with 4.8.

4.8.2* Slope and Rise. The least possible slope shall be used for any ramp. The maximum slope of a ramp in new construction shall be 1:12. The maximum rise for any run shall be 30 in (760 mm) (see Fig. 16). Curb ramps

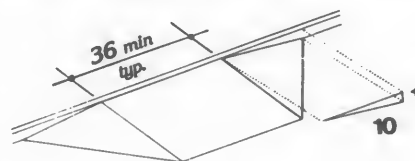
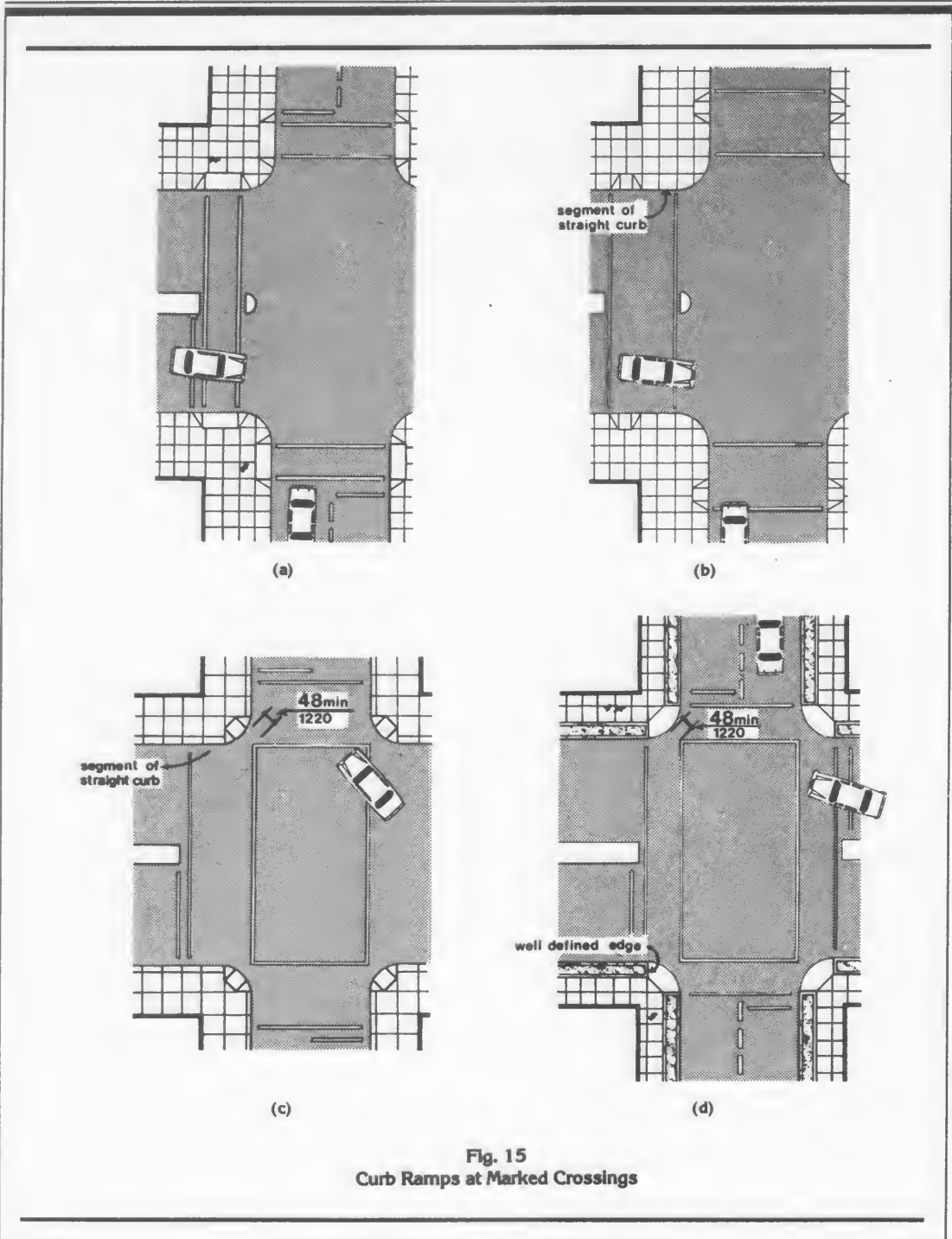

Fig. 13
Built-Up Curb Ramp

and ramps to be constructed on existing sites or in existing buildings or facilities may have slopes and rises as allowed in 4.1.6(3)(a) if space limitations prohibit the use of a 1:12 slope or less.

4.8 Ramps



4.8 Ramps

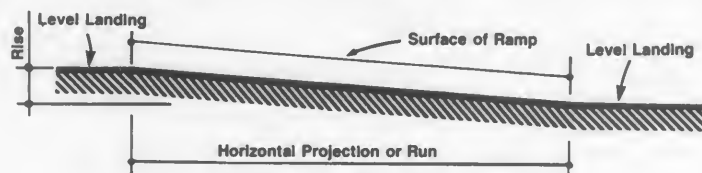

| Slope | Maximum Rise | | Maximum Horizontal Projection | |
|----------------|--------------|-----|-------------------------------|----|
| | in | mm | ft | m |
| 1:12 to < 1:16 | 30 | 760 | 30 | 9 |
| 1:16 to < 1:20 | 30 | 760 | 40 | 12 |

Fig. 16

Components of a Single Ramp Run and Sample Ramp Dimensions

4.8.3 Clear Width. The minimum clear width of a ramp shall be 36 in (915 mm).

4.8.4* Landings. Ramps shall have level landings at bottom and top of each ramp and each ramp run. Landings shall have the following features:

- (1) The landing shall be at least as wide as the ramp run leading to it.
- (2) The landing length shall be a minimum of 60 in (1525 mm) clear.
- (3) If ramps change direction at landings, the minimum landing size shall be 60 in by 60 in (1525 mm by 1525 mm).
- (4) If a doorway is located at a landing, then the area in front of the doorway shall comply with 4.13.6.

4.8.5* Handrails. If a ramp run has a rise greater than 6 in (150 mm) or a horizontal projection greater than 72 in (1830 mm), then it shall have handrails on both sides. Handrails are not required on curb ramps or adjacent to seating in assembly areas. Handrails shall comply with 4.26 and shall have the following features:

(1) Handrails shall be provided along both sides of ramp segments. The inside handrail on switchback or dogleg ramps shall always be continuous.

(2) If handrails are not continuous, they shall extend at least 12 in (305 mm) beyond the top and bottom of the ramp segment and shall be parallel with the floor or ground surface (see Fig. 17).

(3) The clear space between the handrail and the wall shall be 1 - 1/2 in (38 mm).

(4) Gripping surfaces shall be continuous.

(5) Top of handrail gripping surfaces shall be mounted between 34 in and 38 in (865 mm and 965 mm) above ramp surfaces.

(6) Ends of handrails shall be either rounded or returned smoothly to floor, wall, or post.

(7) Handrails shall not rotate within their fittings.

4.8.6 Cross Slope and Surfaces. The cross slope of ramp surfaces shall be no greater than 1:50. Ramp surfaces shall comply with 4.5.

4.9 Stairs

4.8.7 Edge Protection. Ramps and landings with drop-offs shall have curbs, walls, railings, or projecting surfaces that prevent people from slipping off the ramp. Curbs shall be a minimum of 2 in (50 mm) high (see Fig. 17).

4.8.8 Outdoor Conditions. Outdoor ramps and their approaches shall be designed so that water will not accumulate on walking surfaces.

4.9 Stairs.

4.9.1* Minimum Number. Stairs required to be accessible by 4.1 shall comply with 4.9.

4.9.2 Treads and Risers. On any given flight of stairs, all steps shall have uniform riser heights and uniform tread widths. Stair treads shall be no less than 11 in (280 mm) wide, measured from riser to riser (see Fig. 18(a)). *Open risers are not permitted.*

4.9.3 Nosings. The undersides of nosings shall not be abrupt. The radius of curvature at the leading edge of the tread shall be no greater than 1/2 in (13 mm). Risers shall be sloped or the underside of the nosing shall have an angle not less than 60 degrees from the horizontal. Nosings shall project no more than 1-1/2 in (38 mm) (see Fig. 18).

4.9.4 Handrails. Stairways shall have handrails at both sides of all stairs. Handrails shall comply with 4.26 and shall have the following features:

(1) Handrails shall be continuous along both sides of stairs. The inside handrail on switchback or dogleg stairs shall always be continuous (see Fig. 19(a) and (b)).

(2) If handrails are not continuous, they shall extend at least 12 in (305 mm) beyond the top riser and at least 12 in (305 mm) plus the width of one tread beyond the bottom riser. At the top, the extension shall be parallel with the floor or ground surface. At the bottom, the handrail shall continue to slope for a distance of the width of one tread from the bottom riser; the remainder of the extension shall be horizontal (see Fig. 19(c) and (d)). Handrail extensions shall comply with 4.4.

(3) The clear space between handrails and wall shall be 1-1/2 in (38 mm).

(4) Gripping surfaces shall be uninterrupted by newel posts, other construction elements, or obstructions.

(5) *Top of handrail gripping surface shall be mounted between 34 in and 38 in (865 mm and 965 mm) above stair nosings.*

(6) *Ends of handrails shall be either rounded or returned smoothly to floor, wall or post.*

(7) *Handrails shall not rotate within their fittings.*

4.9.5 Detectable Warnings at Stairs. (Reserved).

4.9.6 Outdoor Conditions. Outdoor stairs and their approaches shall be designed so that water will not accumulate on walking surfaces.

4.10 Elevators.

4.10.1 General. Accessible elevators shall be on an accessible route and shall comply with 4.10 and with the ASME A17.1-1990, Safety Code for Elevators and Escalators. *Freight elevators shall not be considered as meeting the requirements of this section unless the only elevators provided are used as combination passenger and freight elevators for the public and employees.*

4.10.2 Automatic Operation. Elevator operation shall be automatic. Each car shall be equipped with a self-leveling feature that will automatically bring the car to floor landings within a tolerance of 1/2 in (13 mm) under rated loading to zero loading conditions. This self-leveling feature shall be automatic and independent of the operating device and shall correct the overtravel or undertravel.

4.10.3 Hall Call Buttons. Call buttons in elevator lobbies and halls shall be centered at 42 in (1065 mm) above the floor. Such call buttons shall have visual signals to indicate when each call is registered and when each call is answered. Call buttons shall be a minimum of 3/4 in (19 mm) in the smallest dimension. The button designating the up direction shall be on top. (See Fig. 20.) *Buttons shall be raised or flush. Objects mounted beneath hall call buttons shall not project into the elevator lobby more than 4 in (100 mm).*

4.10 Elevators

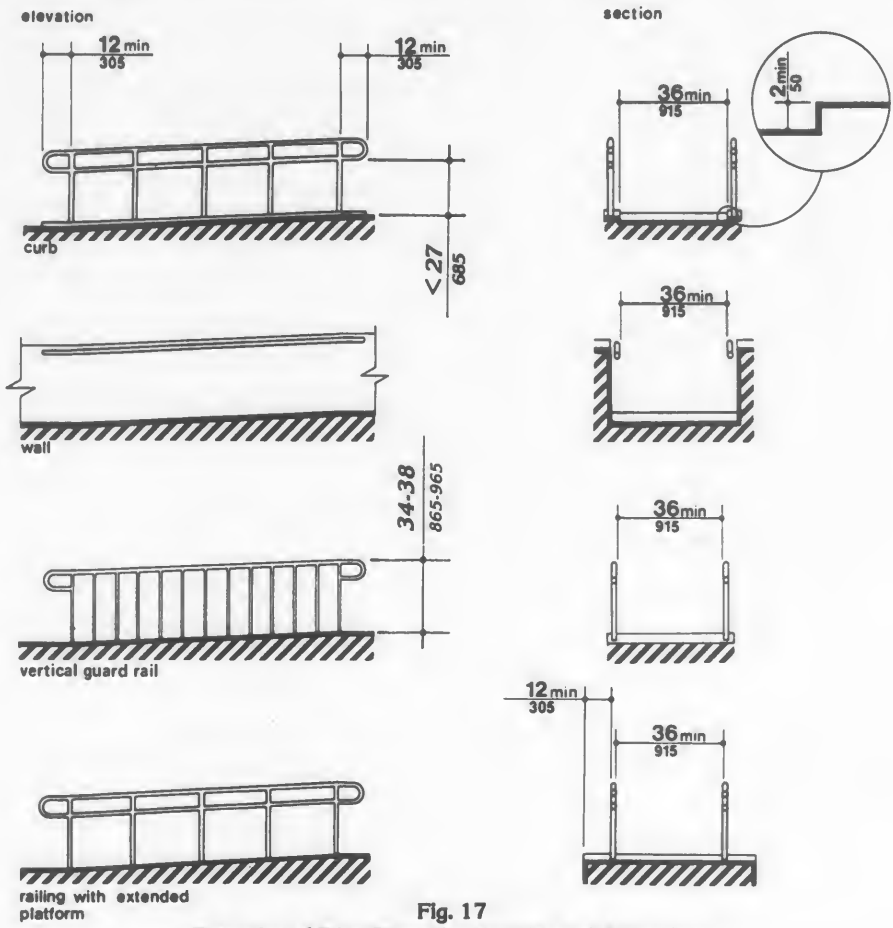

Fig. 17
Examples of Edge Protection and Handrail Extensions

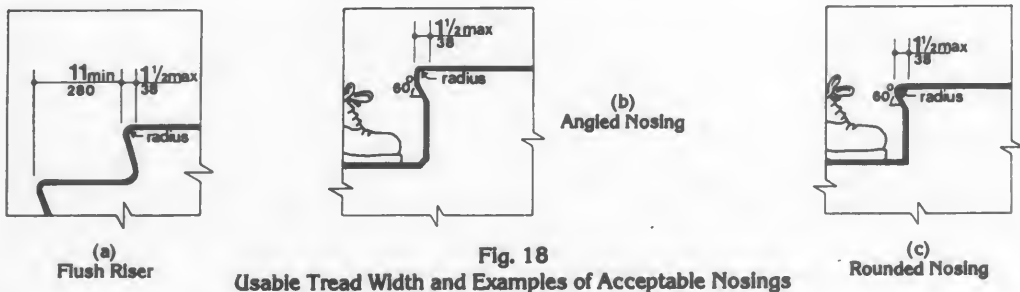
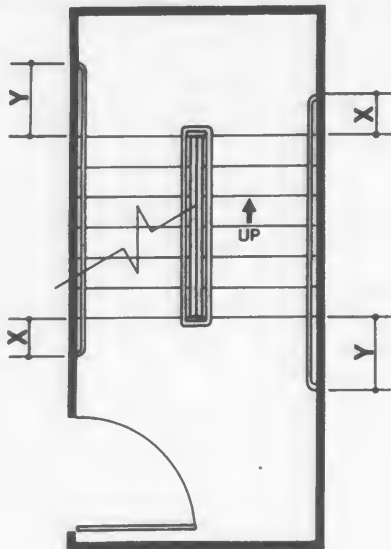
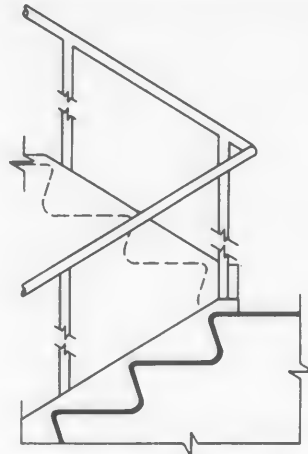
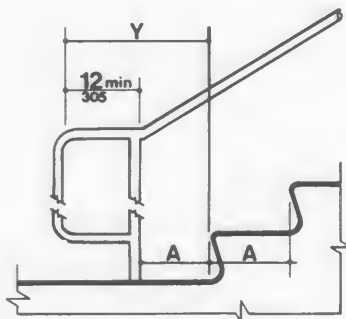
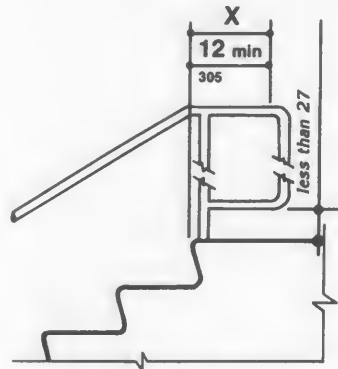

Fig. 18
Usable Tread Width and Examples of Acceptable Nosings

4.10 Elevators

(a)
Plan(b)
Elevation of Center Handrail(c)
Extension at Bottom of Run(d)
Extension at Top of Run**NOTE:**

X is the 12 in minimum handrail extension required at each top riser.

Y is the minimum handrail extension of 12 in plus the width of one tread that is required at each bottom riser.

Fig. 19
Stair Handrails

4.10 Elevators

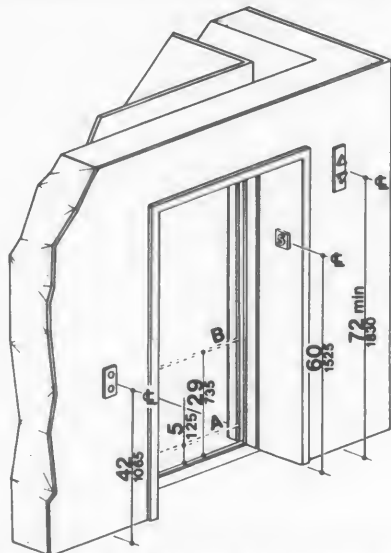

NOTE: The automatic door reopening device is activated if an object passes through either line A or line B. Line A and line B represent the vertical locations of the door reopening device not requiring contact.

Fig. 20
Hoistway and Elevator Entrances

4.10.4 Hall Lanterns. A visible and audible signal shall be provided at each hoistway entrance to indicate which car is answering a call. Audible signals shall sound once for the up direction and twice for the down direction or shall have verbal annunciators that say "up" or "down." Visible signals shall have the following features:

- (1) Hall lantern fixtures shall be mounted so that their centerline is at least 72 in (1830 mm) above the lobby floor. (See Fig. 20.)
- (2) Visual elements shall be at least 2-1/2 in (64 mm) in the smallest dimension.
- (3) Signals shall be visible from the vicinity of the hall call button (see Fig. 20). In-car lanterns located in cars, visible from the vicinity of hall call buttons, and conforming to the above requirements, shall be acceptable.

4.10.5 Raised and Braille Characters on Hoistway Entrances. All elevator hoistway entrances shall have *raised and Braille* floor designations provided on both jambs. The centerline of the characters shall be 60 in (1525 mm) above finish floor. Such characters shall be 2 in (50 mm) high and shall comply with 4.30.4. Permanently applied plates are acceptable if they are permanently fixed to the jambs. (See Fig. 20).

4.10.6* Door Protective and Reopening Device. Elevator doors shall open and close automatically. They shall be provided with a reopening device that will stop and reopen a car door and hoistway door automatically if the door becomes obstructed by an object or person. The device shall be capable of completing these operations without requiring contact for an obstruction passing through the opening at heights of 5 in and 29 in (125 mm and 735 mm) above finish floor (see Fig. 20). Door reopening devices shall remain effective for at least 20 seconds. After such an interval, doors may close in accordance with the requirements of ASME A17.1-1990.

4.10.7* Door and Signal Timing for Hall Calls. The minimum acceptable time from notification that a car is answering a call until the doors of that car start to close shall be calculated from the following equation:

$$T = D/(1.5 \text{ ft/s}) \text{ or } T = D/(445 \text{ mm/s})$$

where T total time in seconds and D distance (in feet or millimeters) from a point in the lobby or corridor 60 in (1525 mm) directly in front of the farthest call button controlling that car to the centerline of its hoistway door (see Fig. 21). For cars with in-car lanterns, T begins when the lantern is visible from the vicinity of hall call buttons and an audible signal is sounded. *The minimum acceptable notification time shall be 5 seconds.*

4.10.8 Door Delay for Car Calls. The minimum time for elevator doors to remain fully open in response to a car call shall be 3 seconds.

4.10.9 Floor Plan of Elevator Cars. The floor area of elevator cars shall provide space for wheelchair users to enter the car, maneuver

4.10.12 Car Controls

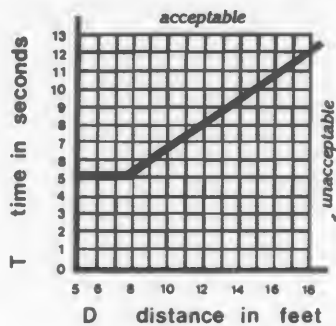

Fig. 21
Graph of Timing Equation

within reach of controls, and exit from the car. Acceptable door opening and inside dimensions shall be as shown in Fig. 22. The clearance between the car platform sill and the edge of any hoistway landing shall be no greater than 1-1/4 in (32 mm).

4.10.10 Floor Surfaces. Floor surfaces shall comply with 4.5.

4.10.11 Illumination Levels. The level of illumination at the car controls, platform, and car threshold and landing sill shall be at least 5 footcandles (53.8 lux).

4.10.12* Car Controls. Elevator control panels shall have the following features:

(1) Buttons. All control buttons shall be at least 3/4 in (19 mm) in their smallest dimension. They shall be raised or flush.

(2) Tactile, Braille, and Visual Control Indicators. All control buttons shall be designated by Braille and by raised standard alphabet characters for letters, arabic characters for numerals, or standard symbols as shown in Fig. 23(a), and as required in ASME A17.1-1990. Raised and Braille characters and symbols shall comply with 4.30. The call button for the main entry floor shall be designated by a raised star at the left of the floor designation (see Fig. 23(a)). All raised designations for control buttons shall be placed immediately to the left of the button to which they apply. Applied plates,

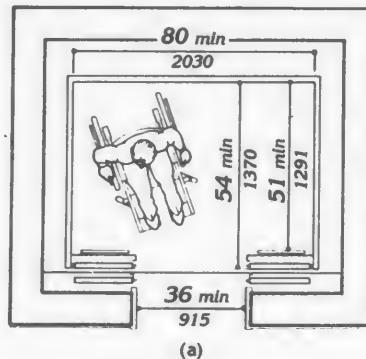

(a)

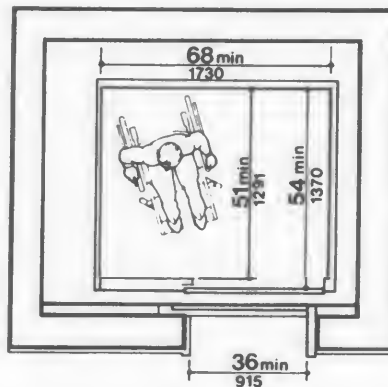

(b)

Fig. 22

Minimum Dimensions of Elevator Cars

permanently attached, are an acceptable means to provide raised control designations. Floor buttons shall be provided with visual indicators to show when each call is registered. The visual indicators shall be extinguished when each call is answered.

(3) Height. All floor buttons shall be no higher than 54 in (1370 mm) above the finish floor for side approach and 48 in (1220 mm) for front approach. Emergency controls, including the emergency alarm and emergency stop, shall be grouped at the bottom of the panel and shall have their centerlines no less than 35 in (890 mm) above the finish floor (see Fig. 23(a) and (b)).

4.10.13* Car Position Indicators

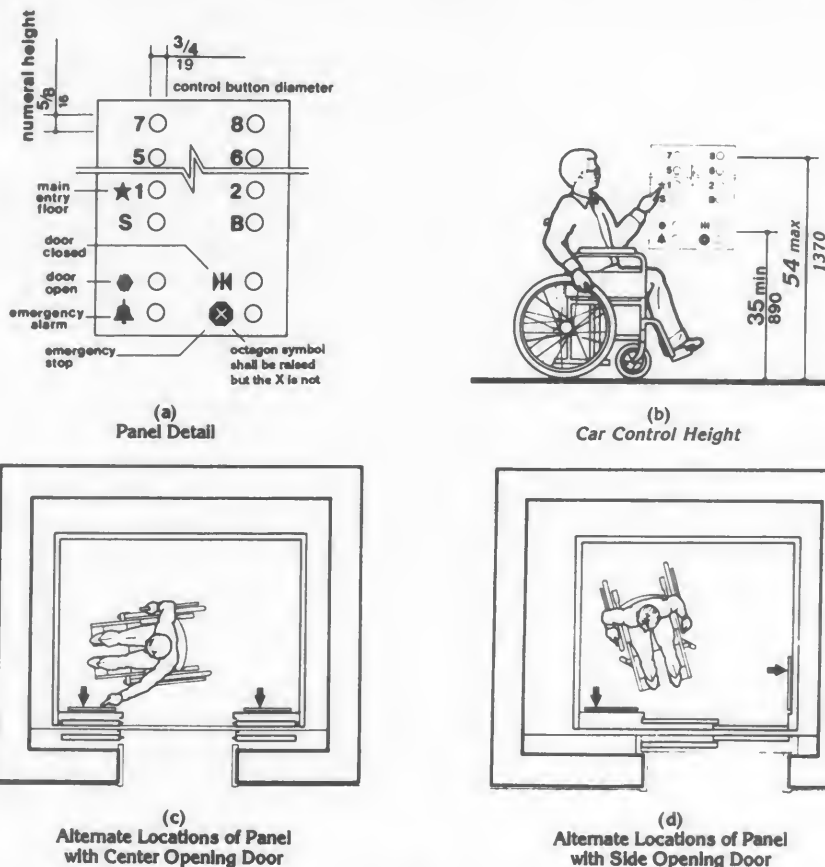

Fig. 23
Car Controls

(4) Location. Controls shall be located on a front wall if cars have center opening doors, and at the side wall or at the front wall next to the door if cars have side opening doors (see Fig. 23(c) and (d)).

4.10.13* Car Position Indicators. In elevator cars, a visual car position indicator shall be provided above the car control panel or over the door to show the position of the elevator in the hoistway. As the car passes or stops at a floor served by the elevators, the corresponding numerals shall illuminate,

and an audible signal shall sound. Numerals shall be a minimum of 1/2 in (13 mm) high. The audible signal shall be no less than 20 decibels with a frequency no higher than 1500 Hz. An automatic verbal announcement of the floor number at which a car stops or which a car passes may be substituted for the audible signal.

4.10.14* Emergency Communications. If provided, emergency two-way communication systems between the elevator and a point outside the hoistway shall comply with ASME

4.11 Platform Lifts (Wheelchair Lifts)

A17.1-1990. The highest operable part of a two-way communication system shall be a maximum of 48 in (1220 mm) from the floor of the car. It shall be identified by a raised symbol and lettering complying with 4.30 and located adjacent to the device. If the system uses a handset then the length of the cord from the panel to the handset shall be at least 29 in (735 mm). *If the system is located in a closed compartment the compartment door hardware shall conform to 4.27, Controls and Operating Mechanisms. The emergency inter-communication system shall not require voice communication.*

4.11 Platform Lifts (Wheelchair Lifts)

4.11.1 Location. Platform lifts (wheelchair lifts) permitted by 4.1 shall comply with the requirements of 4.11.

4.11.2* Other Requirements. If platform lifts (wheelchair lifts) are used, they shall comply with 4.2.4, 4.5, 4.27, and ASME A17.1 Safety Code for Elevators and Escalators, Section XX, 1990.

4.11.3 Entrance. If platform lifts are used then they shall facilitate unassisted entry, operation, and exit from the lift in compliance with 4.11.2.

4.12 Windows.

4.12.1* General. (Reserved).

4.12.2* Window Hardware. (Reserved).

4.13 Doors.

4.13.1 General. Doors required to be accessible by 4.1 shall comply with the requirements of 4.13.

4.13.2 Revolving Doors and Turnstiles. Revolving doors or turnstiles shall not be the only means of passage at an accessible entrance or along an accessible route. An accessible gate or door shall be provided adjacent to the turnstile or revolving door and shall be so designed as to facilitate the same use pattern.

4.13.3 Gates. Gates, including ticket gates, shall meet all applicable specifications of 4.13.

4.13.4 Double-Leaf Doorways. If doorways have two *independently operated* door leaves, then at least one leaf shall meet the specifications in 4.13.5 and 4.13.6. That leaf shall be an active leaf.

4.13.5 Clear Width. Doorways shall have a minimum clear opening of 32 in (815 mm) with the door open 90 degrees, measured between the face of the door and the *opposite* stop (see Fig. 24(a), (b), (c), and (d)). Openings more than 24 in (610 mm) in depth shall comply with 4.2.1 and 4.3.3 (see Fig. 24(e)).

EXCEPTION: Doors not requiring full user passage, such as shallow closets, may have the clear opening reduced to 20 in (510 mm) minimum.

4.13.6 Maneuvering Clearances at Doors. Minimum maneuvering clearances at doors that are not automatic or power-assisted shall be as shown in Fig. 25. The floor or ground area within the required clearances shall be level and clear.

EXCEPTION: Entry doors to acute care hospital bedrooms for in-patients shall be exempted from the requirement for space at the latch side of the door (see dimension "x" in Fig. 25) if the door is at least 44 in (1120 mm) wide.

4.13.7 Two Doors in Series. The minimum space between two hinged or pivoted doors in series shall be 48 in (1220 mm) plus the width of any door swinging into the space. Doors in series shall swing either in the same direction or away from the space between the doors (see Fig. 26).

4.13.8* Thresholds at Doorways. Thresholds at doorways shall not exceed 3/4 in (19 mm) in height for exterior sliding doors or 1/2 in (13 mm) for other types of doors. Raised thresholds and floor level changes at accessible doorways shall be beveled with a slope no greater than 1:2 (see 4.5.2).

4.13.9* Door Hardware. Handles, pulls, latches, locks, and other operating devices on accessible doors shall have a shape that is easy

4.13 Doors

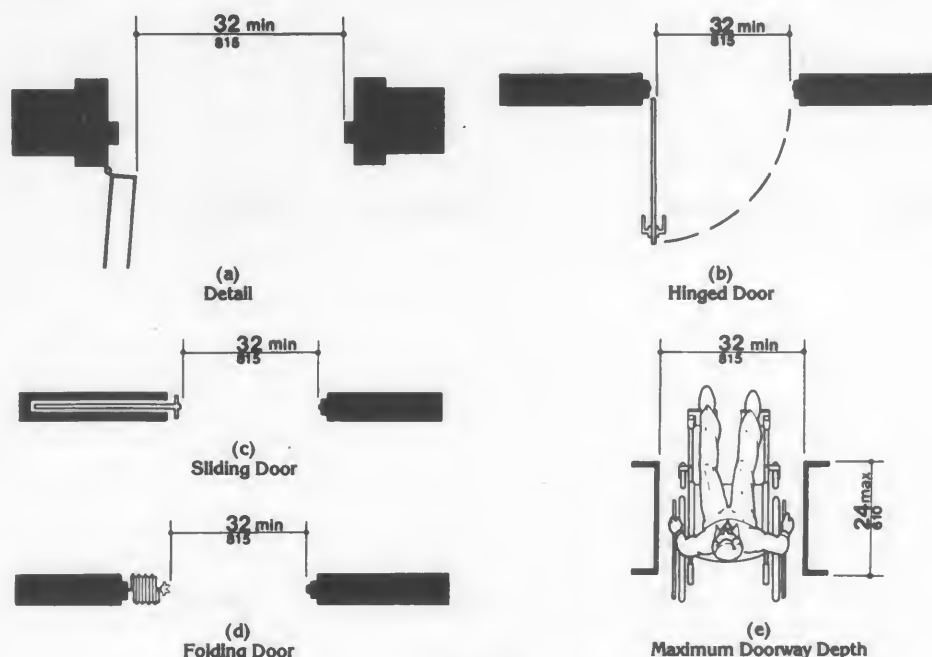

Fig. 24
Clear Doorway Width and Depth

to grasp with one hand and does not require tight grasping, tight pinching, or twisting of the wrist to operate. Lever-operated mechanisms, push-type mechanisms, and U-shaped handles are acceptable designs. When sliding doors are fully open, operating hardware shall be exposed and usable from both sides. *Hardware required for accessible door passage shall be mounted no higher than 48 in (1220 mm) above finished floor.*

4.13.10* Door Closers. If a door has a closer, then the sweep period of the closer shall be adjusted so that from an open position of 70 degrees, the door will take at least 3 seconds to move to a point 3 in (75 mm) from the latch, measured to the leading edge of the door.

4.13.11* Door Opening Force. The maximum force for pushing or pulling open a door shall be as follows:

(1) Fire doors shall have the minimum opening force allowable by the appropriate administrative authority.

(2) Other doors.

(a) exterior hinged doors: *(Reserved)*.

(b) interior hinged doors: 5 lbf (22.2N)

(c) sliding or folding doors: 5 lbf (22.2N)

These forces do not apply to the force required to retract latch bolts or disengage other devices that may hold the door in a closed position.

4.13 Doors

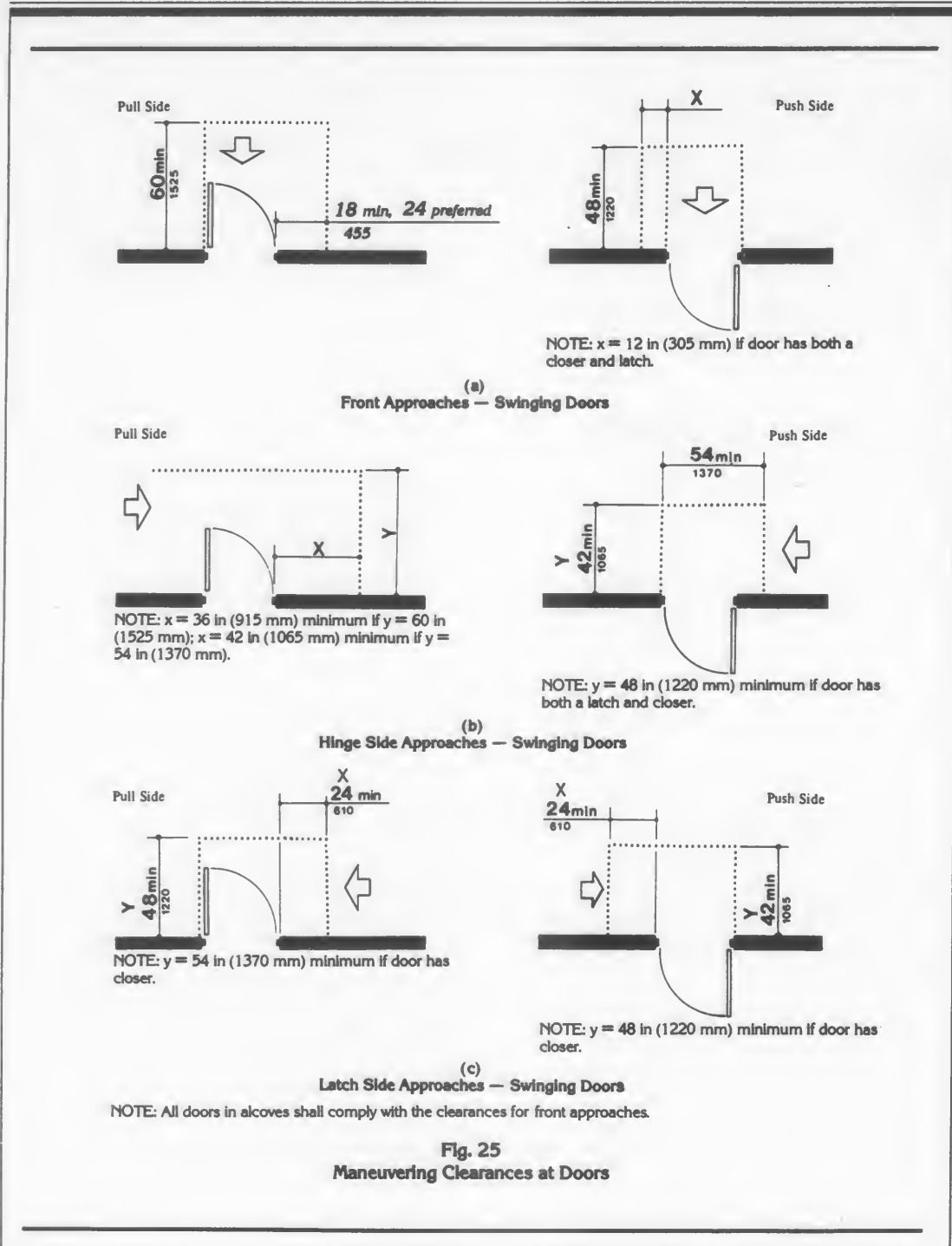

4.13 Doors

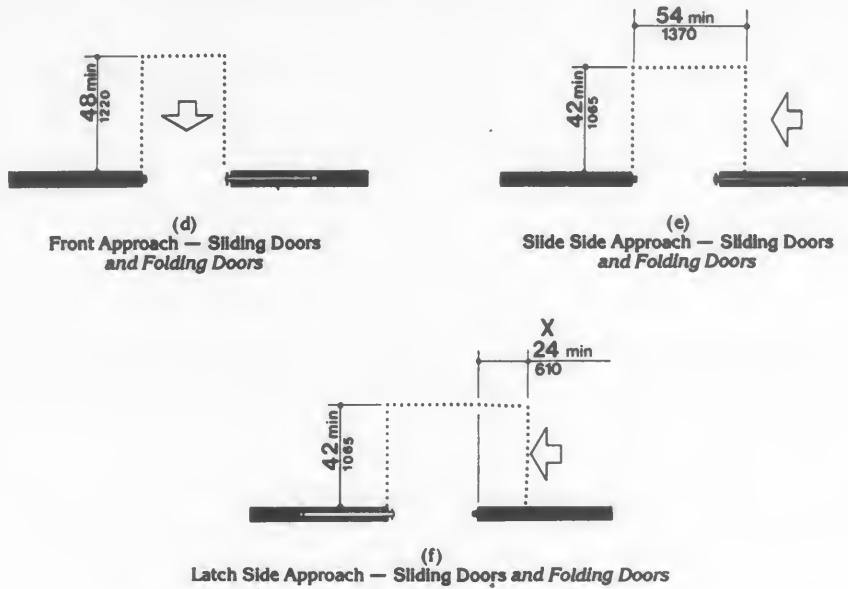

NOTE: All doors in alcoves shall comply with the clearances for front approaches.

Fig. 25
Maneuvering Clearances at Doors (Continued)

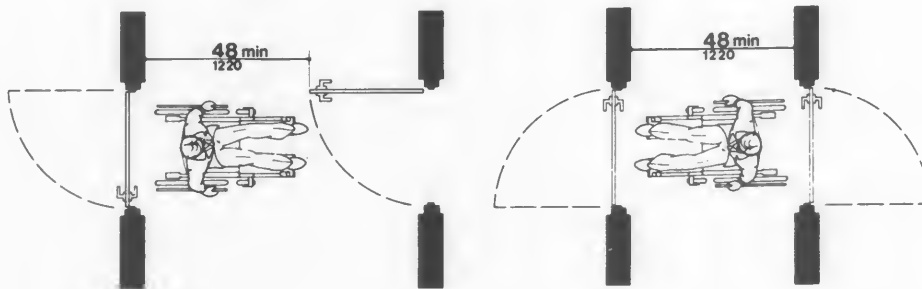

Fig. 26
Two Hinged Doors in Series

4.14 Entrances

4.13.12* Automatic Doors and Power-Assisted Doors. If an automatic door is used, then it shall comply with ANSI/BHMA A156.10-1985. Slowly opening, low-powered, automatic doors shall comply with ANSI A156.19-1984. Such doors shall not open to back check faster than 3 seconds and shall require no more than 15 lbf (66.6N) to stop door movement. If a power-assisted door is used, its door-opening force shall comply with 4.13.11 and its closing shall conform to the requirements in ANSI A156.19-1984.

4.14 Entrances.

4.14.1 Minimum Number. Entrances required to be accessible by 4.1 shall be part of an accessible route complying with 4.3. Such entrances shall be connected by an accessible route to public transportation stops, to accessible parking and passenger loading zones, and to public streets or sidewalks if available (see 4.3.2(1)). They shall also be connected by an accessible route to all accessible spaces or elements within the building or facility.

4.14.2 Service Entrances. A service entrance shall not be the sole accessible entrance unless it is the only entrance to a building or facility (for example, in a factory or garage).

4.15 Drinking Fountains and Water Coolers.

4.15.1 Minimum Number. Drinking fountains or water coolers required to be accessible by 4.1 shall comply with 4.15.

4.15.2* Spout Height. Spouts shall be no higher than 36 in (915 mm), measured from the floor or ground surfaces to the spout outlet (see Fig. 27(a)).

4.15.3 Spout Location. The spouts of drinking fountains and water coolers shall be at the front of the unit and shall direct the water flow in a trajectory that is parallel or nearly parallel to the front of the unit. The spout shall provide a flow of water at least 4 in (100 mm) high so as to allow the insertion of a cup or glass under the flow of water. *On an accessible drinking fountain with a round or*

oval bowl, the spout must be positioned so the flow of water is within 3 in (75 mm) of the front edge of the fountain.

4.15.4 Controls. Controls shall comply with 4.27.4. *Unit controls shall be front mounted or side mounted near the front edge.*

4.15.5 Clearances.

(1) Wall- and post-mounted cantilevered units shall have a clear knee space between the bottom of the apron and the floor or ground at least 27 in (685 mm) high, 30 in (760 mm) wide, and 17 in to 19 in (430 mm to 485 mm) deep (see Fig. 27(a) and (b)). Such units shall also have a minimum clear floor space 30 in by 48 in (760 mm by 1220 mm) to allow a person in a wheelchair to approach the unit facing forward.

(2) Free-standing or built-in units not having a clear space under them shall have a clear floor space at least 30 in by 48 in (760 mm by 1220 mm) that allows a person in a wheelchair to make a parallel approach to the unit (see Fig. 27(c) and (d)). This clear floor space shall comply with 4.2.4.

4.16 Water Closets.

4.16.1 General. Accessible water closets shall comply with 4.16.

4.16.2 Clear Floor Space. Clear floor space for water closets not in stalls shall comply with Fig. 28. Clear floor space may be arranged to allow either a left-handed or right-handed approach.

4.16.3* Height. The height of water closets shall be 17 in to 19 in (430 mm to 485 mm), measured to the top of the toilet seat (see Fig. 29(b)). *Seats shall not be sprung to return to a lifted position.*

4.16.4* Grab Bars. Grab bars for water closets not located in stalls shall comply with 4.26 and Fig. 29. *The grab bar behind the water closet shall be 36 in (915 mm) minimum.*

4.16.5* Flush Controls. Flush controls shall be hand operated or automatic and shall comply with 4.27.4. Controls for flush valves

4.17 Toilet Stalls

shall be mounted on the wide side of toilet areas no more than 44 in (1120 mm) above the floor.

4.16.6 Dispensers. Toilet paper dispensers shall be installed within reach, as shown in Fig. 29(b). Dispensers that control delivery, or that do not permit continuous paper flow, shall not be used.

4.17 Toilet Stalls.

4.17.1 Location. Accessible toilet stalls shall be on an accessible route and shall meet the requirements of 4.17.

4.17.2 Water Closets. Water closets in accessible stalls shall comply with 4.16.

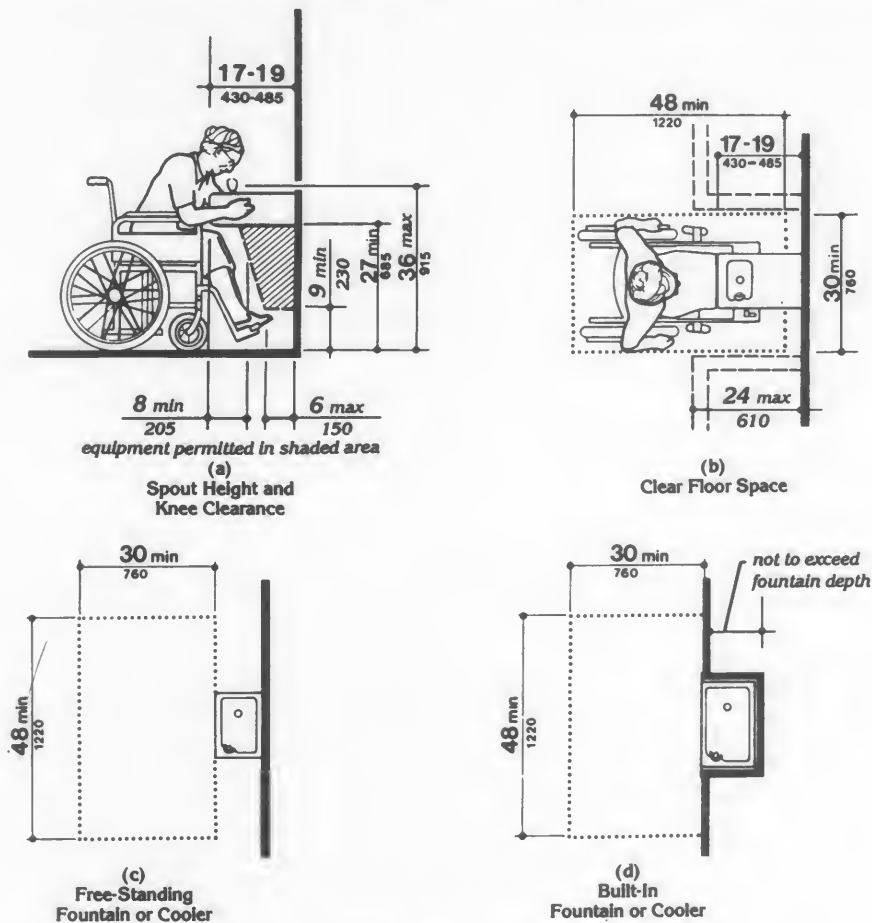

Fig. 27
Drinking Fountains and Water Coolers

4.17 Toilet Stalls

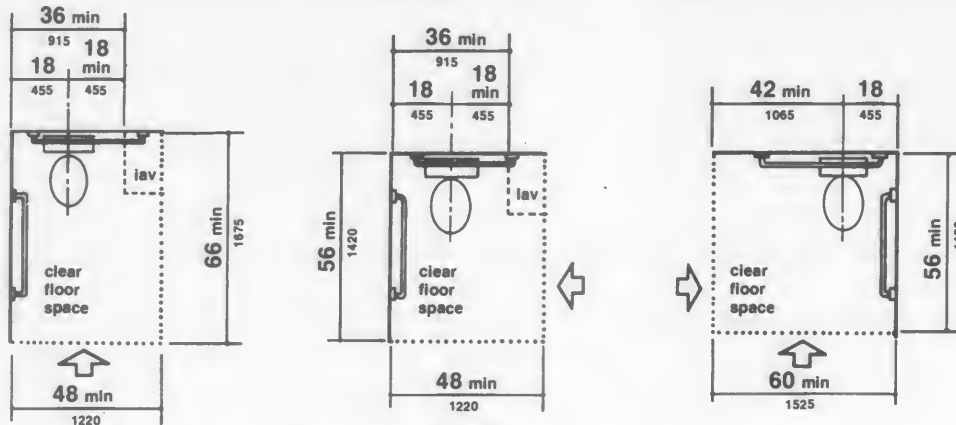

Fig. 28
Clear Floor Space at Water Closets

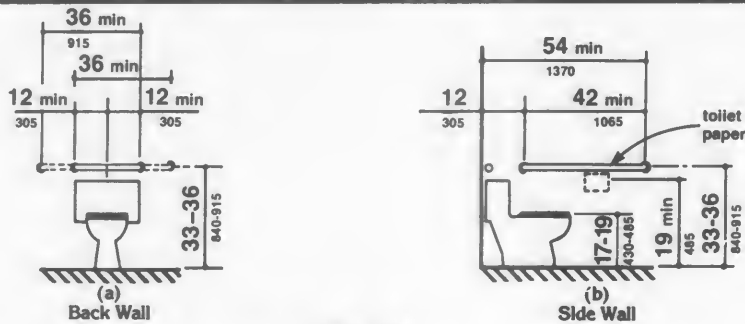

Fig. 29
Grab Bars at Water Closets

4.17.3* Size and Arrangement. The size and arrangement of the standard toilet stall shall comply with Fig. 30(a), *Standard Stall*. Standard toilet stalls with a minimum depth of 56 in (1420 mm) (see Fig. 30(a)) shall have wall-mounted water closets. If the depth of a standard toilet stall is increased at least 3 in (75 mm), then a floor-mounted water closet may be used. Arrangements shown for standard toilet stalls may be reversed to allow either a left- or right-hand approach. Additional stalls shall be provided in conformance with 4.22.4.

EXCEPTION: In instances of alteration work where provision of a standard stall (Fig. 30(a))

is technically infeasible or where plumbing code requirements prevent combining existing stalls to provide space, either alternate stall (Fig. 30(b)) may be provided in lieu of the standard stall.

4.17.4 Toe Clearances. In standard stalls, the front partition and at least one side partition shall provide a toe clearance of at least 9 in (230 mm) above the floor. If the depth of the stall is greater than 60 in (1525 mm), then the toe clearance is not required.

4.17.5* Doors. Toilet stall doors, including door hardware, shall comply with 4.13. If toilet stall approach is from the latch side of the stall door, clearance between the door side of the

4.17 Toilet Stalls

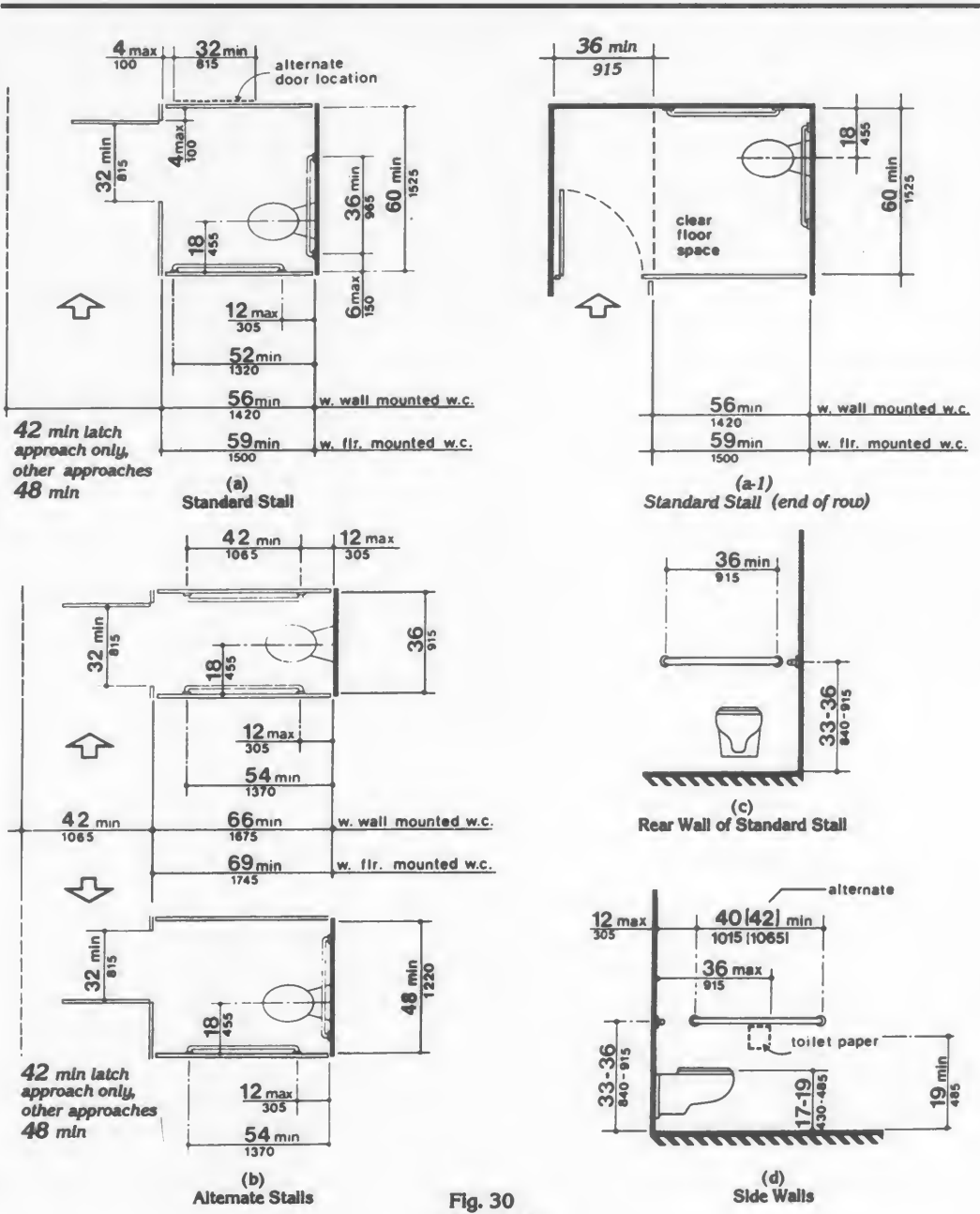

Fig. 30 Toilet Stalls

4.19 Lavatories and Mirrors

stall and any obstruction may be reduced to a minimum of 42 in (1065 mm) (Fig. 30).

4.17.6 Grab Bars. Grab bars complying with the length and positioning shown in Fig. 30(a), (b), (c), and (d) shall be provided. Grab bars may be mounted with any desired method as long as they have a gripping surface at the locations shown and do not obstruct the required clear floor area. Grab bars shall comply with 4.26.

4.18 Urinals.

4.18.1 General. Accessible urinals shall comply with 4.18.

4.18.2 Height. Urinals shall be stall-type or wall-hung with an elongated rim at a maximum of 17 in (430 mm) above the finish floor.

4.18.3 Clear Floor Space. A clear floor space 30 in by 48 in (760 mm by 1220 mm) shall be provided in front of urinals to allow forward approach. This clear space shall adjoin or overlap an accessible route and shall comply with 4.2.4. *Urinal shields that do not extend beyond the front edge of the urinal rim may be provided with 29 in (735 mm) clearance between them.*

4.18.4 Flush Controls. Flush controls shall be hand operated or automatic, and shall comply with 4.27.4, and shall be mounted no more than 44 in (1120 mm) above the finish floor.

4.19 Lavatories and Mirrors.

4.19.1 General. The requirements of 4.19 shall apply to lavatory fixtures, vanities, and built-in lavatories.

4.19.2 Height and Clearances. Lavatories shall be mounted with the rim or counter surface no higher than 34 in (865 mm) above the finish floor. Provide a clearance of at least 29 in (735 mm) above the finish floor to the bottom of the apron. Knee and toe clearance shall comply with Fig. 31.

4.19.3 Clear Floor Space. A clear floor space 30 in by 48 in (760 mm by 1220 mm) complying with 4.2.4 shall be provided in front of a lavatory to allow forward approach. Such

clear floor space shall adjoin or overlap an accessible route and shall extend a maximum of 19 in (485 mm) underneath the lavatory (see Fig. 32).

4.19.4 Exposed Pipes and Surfaces. Hot water and drain pipes under lavatories shall be insulated or otherwise configured to protect against contact. There shall be no sharp or abrasive surfaces under lavatories.

4.19.5 Faucets. Faucets shall comply with 4.27.4. Lever-operated, push-type, and electronically controlled mechanisms are examples of acceptable designs. *If self-closing valves are*

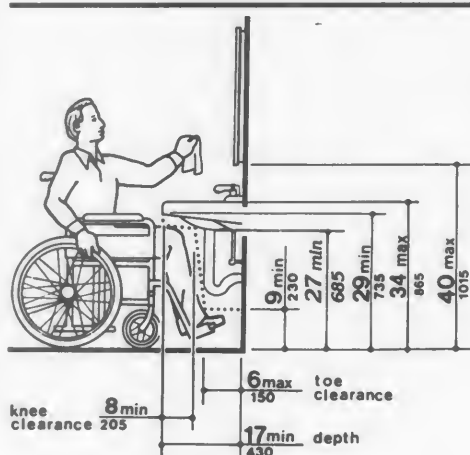

Fig. 31
Lavatory Clearances

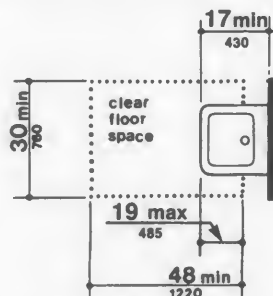

Fig. 32
Clear Floor Space at Lavatories

4.20 Bathtubs

used the faucet shall remain open for at least 10 seconds.

4.19.6* Mirrors. Mirrors shall be mounted with the bottom edge of the reflecting surface no higher than 40 in (1015 mm) above the finish floor (see Fig. 31).

4.20 Bathtubs.

4.20.1 General. Accessible bathtubs shall comply with 4.20.

4.20.2 Floor Space. Clear floor space in front of bathtubs shall be as shown in Fig. 33.

4.20.3 Seat. An in-tub seat or a seat at the head end of the tub shall be provided as shown in Fig. 33 and 34. The structural strength of seats and their attachments shall comply with 4.26.3. Seats shall be mounted securely and shall not slip during use.

4.20.4 Grab Bars. Grab bars complying with 4.26 shall be provided as shown in Fig. 33 and 34.

4.20.5 Controls. Faucets and other controls complying with 4.27.4 shall be located as shown in Fig. 34.

4.20.6 Shower Unit. A shower spray unit with a hose at least 60 in (1525 mm) long that can be used both as a fixed shower head and as a hand-held shower shall be provided.

4.20.7 Bathtub Enclosures. If provided, enclosures for bathtubs shall not obstruct controls or transfer from wheelchairs onto bathtub seats or into tubs. Enclosures on bathtubs shall not have tracks mounted on their rims.

4.21 Shower Stalls.

4.21.1* General. Accessible shower stalls shall comply with 4.21.

4.21.2 Size and Clearances. Except as specified in 9.1.2, shower stall size and clear floor space shall comply with Fig. 35(a) or (b). The shower stall in Fig. 35(a) shall be 36 in by 36 in (915 mm by 915 mm). Shower stalls required by 9.1.2 shall comply with Fig. 57(a)

or (b). The shower stall in Fig. 35(b) will fit into the space required for a bathtub.

4.21.3 Seat. A seat shall be provided in shower stalls 36 in by 36 in (915 mm by 915 mm) and shall be as shown in Fig. 36. The seat shall be mounted 17 in to 19 in (430 mm to 485 mm) from the bathroom floor and shall extend the full depth of the stall. In a 36 in by 36 in (915 mm by 915 mm) shower stall, the seat shall be on the wall opposite the controls. Where a fixed seat is provided in a 30 in by 60 in minimum (760 mm by 1525 mm) shower stall, it shall be a folding type and shall be mounted on the wall adjacent to the controls as shown in Fig. 57. The structural strength of seats and their attachments shall comply with 4.26.3.

4.21.4 Grab Bars. Grab bars complying with 4.26 shall be provided as shown in Fig. 37.

4.21.5 Controls. Faucets and other controls complying with 4.27.4 shall be located as shown in Fig. 37. In shower stalls 36 in by 36 in (915 mm by 915 mm), all controls, faucets, and the shower unit shall be mounted on the side wall opposite the seat.

4.21.6 Shower Unit. A shower spray unit with a hose at least 60 in (1525 mm) long that can be used both as a fixed shower head and as a hand-held shower shall be provided.

EXCEPTION: In unmonitored facilities where vandalism is a consideration, a fixed shower head mounted at 48 in (1220 mm) above the shower floor may be used in lieu of a hand-held shower head.

4.21.7 Curbs. If provided, curbs in shower stalls 36 in by 36 in (915 mm by 915 mm) shall be no higher than 1/2 in (13 mm). Shower stalls that are 30 in by 60 in (760 mm by 1525 mm) minimum shall not have curbs.

4.21.8 Shower Enclosures. If provided, enclosures for shower stalls shall not obstruct controls or obstruct transfer from wheelchairs onto shower seats.

4.22 Toilet Rooms.

4.22.1 Minimum Number. Toilet facilities required to be accessible by 4.1 shall comply

4.21 Shower Stalls

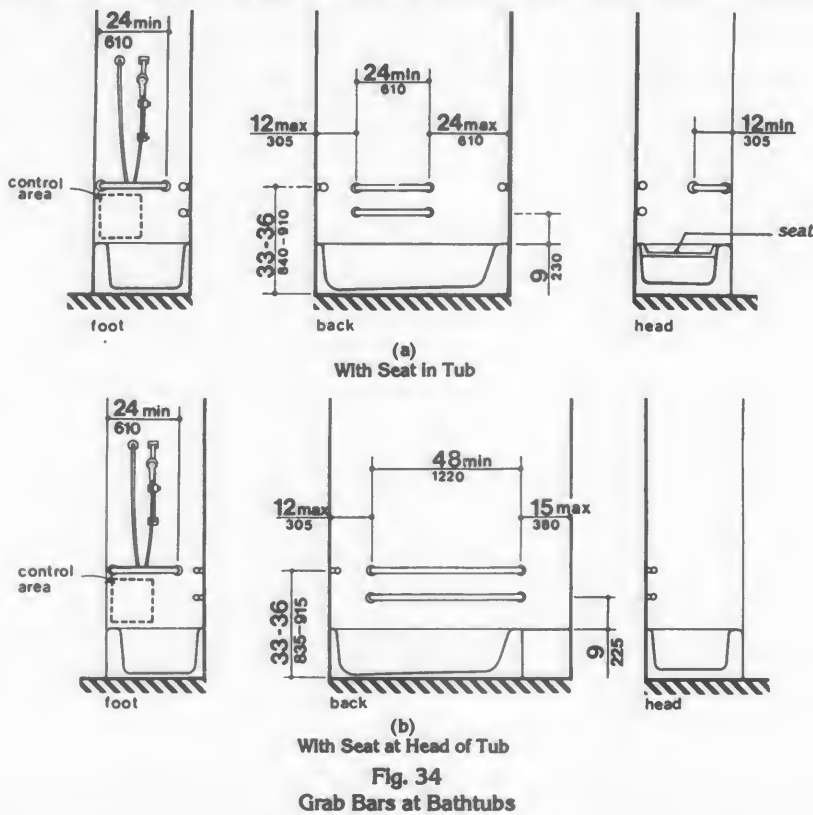
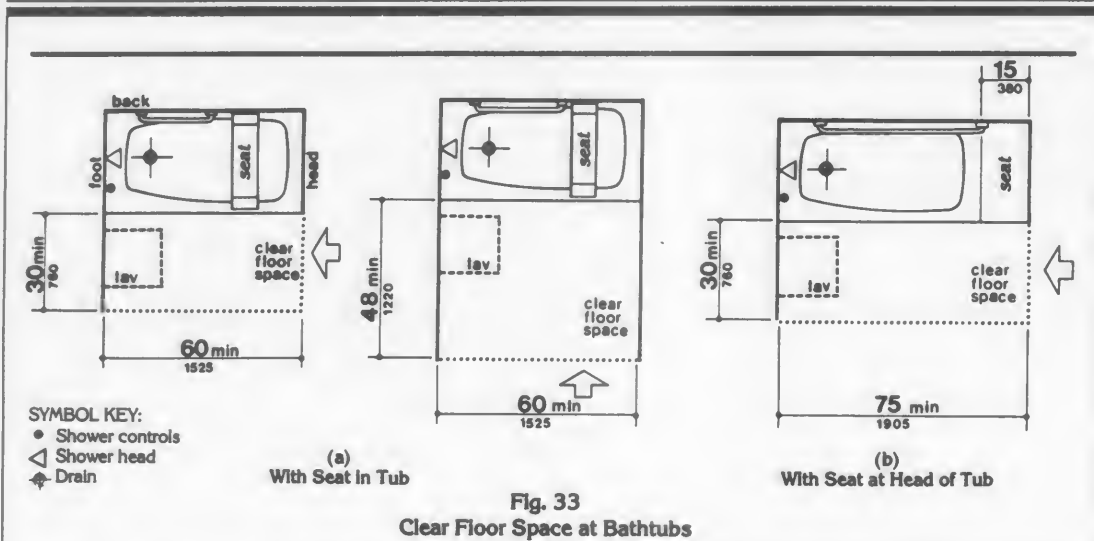

4.22 Toilet Rooms

with 4.22. Accessible toilet rooms shall be on an accessible route.

4.22.2 Doors. All doors to accessible toilet rooms shall comply with 4.13. Doors shall not swing into the clear floor space required for any fixture.

4.22.3* Clear Floor Space. The accessible fixtures and controls required in 4.22.4, 4.22.5, 4.22.6, and 4.22.7 shall be on an accessible route. An unobstructed turning space complying with 4.2.3 shall be provided within an accessible toilet room. The clear floor space at fixtures and controls, the accessible route, and the turning space may overlap.

4.22.4 Water Closets. If toilet stalls are provided, then at least one shall be a standard

toilet stall complying with 4.17; where 6 or more stalls are provided, in addition to the stall complying with 4.17.3, at least one stall 36 in (915 mm) wide with an outward swinging, self-closing door and parallel grab bars complying with Fig. 30(d) and 4.26 shall be provided. Water closets in such stalls shall comply with 4.16. If water closets are not in stalls, then at least one shall comply with 4.16.

4.22.5 Urinals. If urinals are provided, then at least one shall comply with 4.18.

4.22.6 Lavatories and Mirrors. If lavatories and mirrors are provided, then at least one of each shall comply with 4.19.

4.22.7 Controls and Dispensers. If controls, dispensers, receptacles, or other

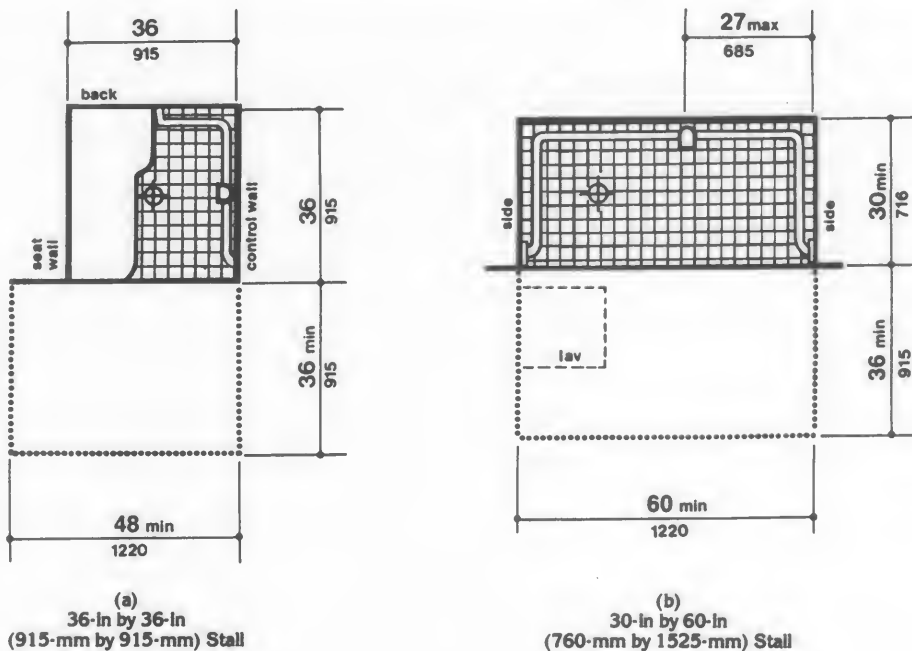

Fig. 35
Shower Size and Clearances

4.23 Bathrooms, Bathing Facilities, and Shower Rooms

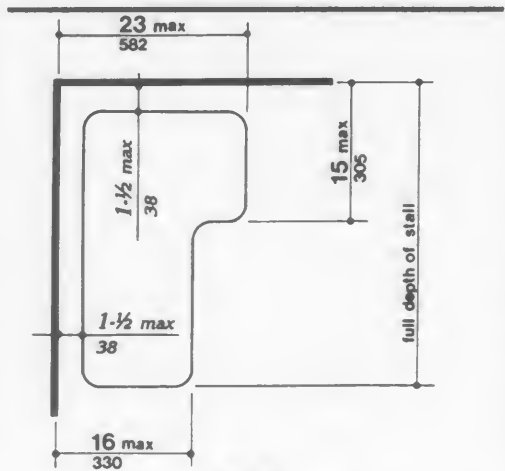

Fig. 36
Shower Seat Design

equipment are provided, then at least one of each shall be on an accessible route and shall comply with 4.27.

4.23 Bathrooms, Bathing Facilities, and Shower Rooms.

4.23.1 Minimum Number. Bathrooms, bathing facilities, or shower rooms required to be accessible by 4.1 shall comply with 4.23 and shall be on an accessible route.

4.23.2 Doors. Doors to accessible bathrooms shall comply with 4.13. Doors shall not swing into the floor space required for any fixture.

4.23.3* Clear Floor Space. The accessible fixtures and controls required in 4.23.4, 4.23.5, 4.23.6, 4.23.7, 4.23.8, and 4.23.9 shall be on an accessible route. An unobstructed turning

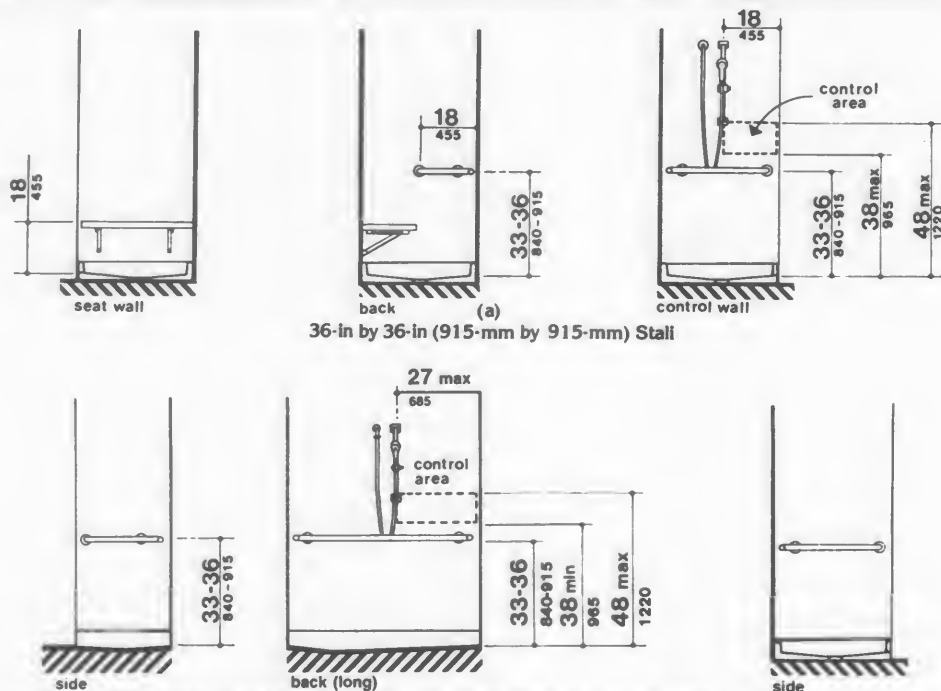

(b)
30-in by 60-in (760-mm by 1525-mm) Stall

Fig. 37
Grab Bars at Shower Stalls

4.24 Sinks

space complying with 4.2.3 shall be provided within an accessible bathroom. The clear floor spaces at fixtures and controls, the accessible route, and the turning space may overlap.

4.23.4 Water Closets. If toilet stalls are provided, then at least one shall be a standard toilet stall complying with 4.17; where 6 or more stalls are provided, in addition to the stall complying with 4.17.3, at least one stall 36 in (915 mm) wide with an outward swinging, self-closing door and parallel grab bars complying with Fig. 30(d) and 4.26 shall be provided. Water closets in such stalls shall comply with 4.16. If water closets are not in stalls, then at least one shall comply with 4.16.

4.23.5 Urinals. If urinals are provided, then at least one shall comply with 4.18.

4.23.6 Lavatories and Mirrors. If lavatories and mirrors are provided, then at least one of each shall comply with 4.19.

4.23.7 Controls and Dispensers. If controls, dispensers, receptacles, or other equipment are provided, then at least one of each shall be on an accessible route and shall comply with 4.27.

4.23.8 Bathing and Shower Facilities. If tubs or showers are provided, then at least one accessible tub that complies with 4.20 or at least one accessible shower that complies with 4.21 shall be provided.

4.23.9* Medicine Cabinets. If medicine cabinets are provided, at least one shall be located with a usable shelf no higher than 44 in (1120 mm) above the floor space. The floor space shall comply with 4.2.4.

4.24 Sinks.

4.24.1 General. Sinks required to be accessible by 4.1 shall comply with 4.24.

4.24.2 Height. Sinks shall be mounted with the counter or rim no higher than 34 in (865 mm) above the finish floor.

4.24.3 Knee Clearance. Knee clearance that is at least 27 in (685 mm) high, 30 in (760 mm) wide, and 19 in (485 mm) deep shall be pro-

vided underneath sinks.

4.24.4 Depth. Each sink shall be a maximum of 6-1/2 in (165 mm) deep.

4.24.5 Clear Floor Space. A clear floor space at least 30 in by 48 in (760 mm by 1220 mm) complying with 4.2.4 shall be provided in front of a sink to allow forward approach. The clear floor space shall be on an accessible route and shall extend a maximum of 19 in (485 mm) underneath the sink (see Fig. 32).

4.24.6 Exposed Pipes and Surfaces. Hot water and drain pipes exposed under sinks shall be insulated or otherwise configured so as to protect against contact. There shall be no sharp or abrasive surfaces under sinks.

4.24.7 Faucets. Faucets shall comply with 4.27.4. Lever-operated, push-type, touch-type, or electronically controlled mechanisms are acceptable designs.

4.25 Storage.

4.25.1 General. Fixed storage facilities such as cabinets, shelves, closets, and drawers required to be accessible by 4.1 shall comply with 4.25.

4.25.2 Clear Floor Space. A clear floor space at least 30 in by 48 in (760 mm by 1220 mm) complying with 4.2.4 that allows either a forward or parallel approach by a person using a wheelchair shall be provided at accessible storage facilities.

4.25.3 Height. Accessible storage spaces shall be within at least one of the reach ranges specified in 4.2.5 and 4.2.6 (see Fig. 5 and Fig. 6). Clothes rods or shelves shall be a maximum of 54 in (1370 mm) above the finish floor for a side approach. Where the distance from the wheelchair to the clothes rod or shelf exceeds 10 in (255 mm) (as in closets without accessible doors) the height and depth to the rod or shelf shall comply with Fig. 38(a) and Fig. 38(b).

4.25.4 Hardware. Hardware for accessible storage facilities shall comply with 4.27.4. Touch latches and U-shaped pulls are acceptable.

4.26 Handrails, Grab Bars, and Tub and Shower Seats

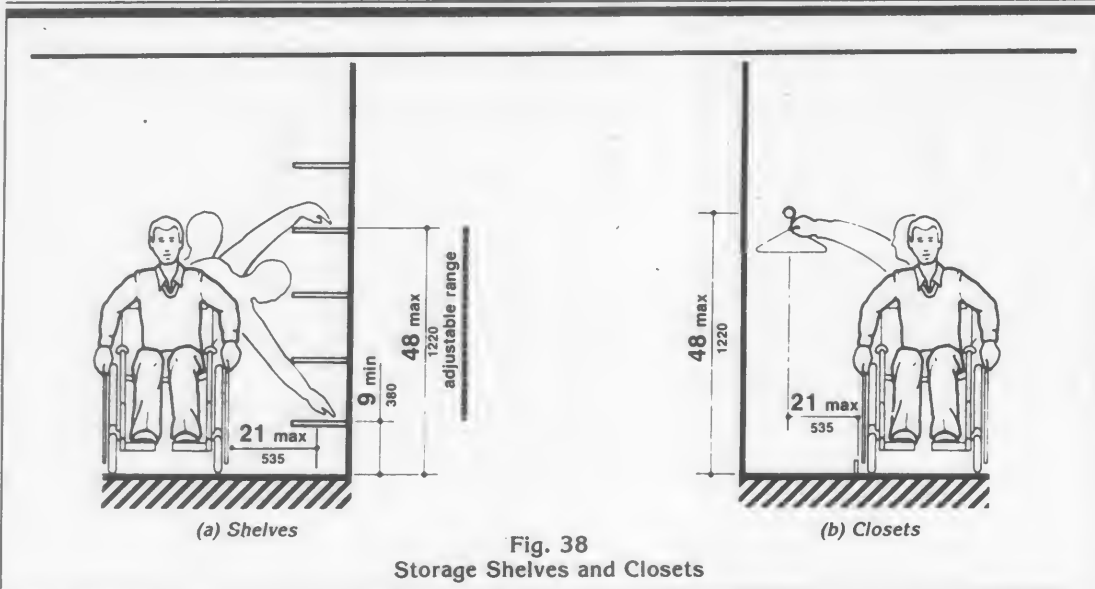

Fig. 38
Storage Shelves and Closets

4.26 Handrails, Grab Bars, and Tub and Shower Seats.

4.26.1* General. All handrails, grab bars, and tub and shower seats *required to be accessible* by 4.1, 4.8, 4.9, 4.16, 4.17, 4.20 or 4.21 shall comply with 4.26.

4.26.2* Size and Spacing of Grab Bars and Handrails. The diameter or width of the gripping surfaces of a handrail or grab bar shall be 1-1/4 in to 1-1/2 in (32 mm to 38 mm), or the shape shall provide an equivalent gripping surface. If handrails or grab bars are mounted adjacent to a wall, the space between the wall and the grab bar shall be 1-1/2 in (38 mm) (see Fig. 39(a), (b), (c), and (e)). Handrails may be located in a recess if the recess is a maximum of 3 in (75 mm) deep and extends at least 18 in (455 mm) above the top of the rail (see Fig. 39(d)).

4.26.3 Structural Strength. The structural strength of grab bars, tub and shower seats, fasteners, and mounting devices shall meet the following specification:

(1) Bending stress in a grab bar or seat induced by the maximum bending moment from the application of 250 lbf (1112N) shall

be less than the allowable stress for the material of the grab bar or seat.

(2) Shear stress induced in a grab bar or seat by the application of 250 lbf (1112N) shall be less than the allowable shear stress for the material of the grab bar or seat. If the connection between the grab bar or seat and its mounting bracket or other support is considered to be fully restrained, then direct and torsional shear stresses shall be totaled for the combined shear stress, which shall not exceed the allowable shear stress.

(3) Shear force induced in a fastener or mounting device from the application of 250 lbf (1112N) shall be less than the allowable lateral load of either the fastener or mounting device or the supporting structure, whichever is the smaller allowable load.

(4) Tensile force induced in a fastener by a direct tension force of 250 lbf (1112N) plus the maximum moment from the application of 250 lbf (1112N) shall be less than the allowable withdrawal load between the fastener and the supporting structure.

(5) Grab bars shall not rotate within their fittings.

4.26 Handrails, Grab Bars, and Tub and Shower Seats

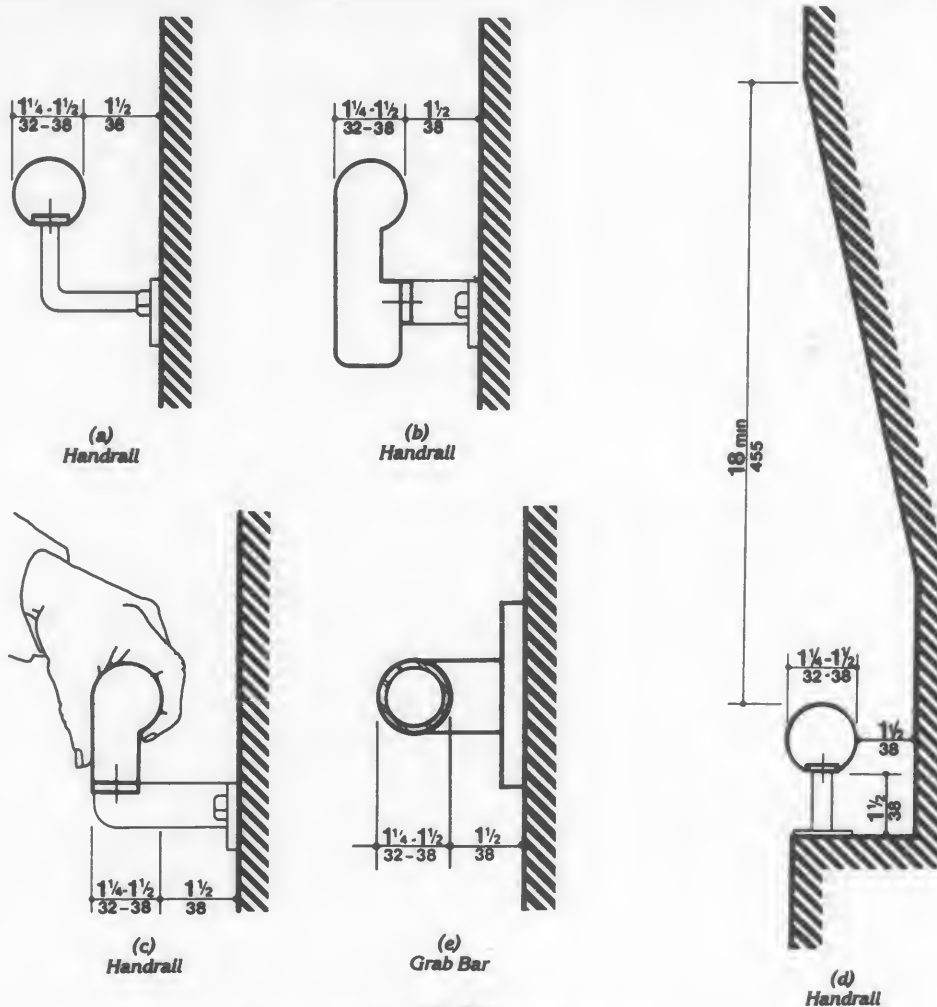

Fig. 39
Size and Spacing of Handrails and Grab Bars

4.26.4 Eliminating Hazards. A handrail or grab bar and any wall or other surface adjacent to it shall be free of any sharp or abrasive elements. Edges shall have a minimum radius of 1/8 in (3.2 mm).

4.27 Controls and Operating Mechanisms.

4.27.1 General. Controls and operating mechanisms required to be accessible by 4.1 shall comply with 4.27.

4.28 Alarms

4.27.2 Clear Floor Space. Clear floor space complying with 4.2.4 that allows a forward or a parallel approach by a person using a wheelchair shall be provided at controls, dispensers, receptacles, and other operable equipment.

4.27.3* Height. The highest operable part of controls, dispensers, receptacles, and other operable equipment shall be placed within at least one of the reach ranges specified in 4.2.5 and 4.2.6. Electrical and communications system receptacles on walls shall be mounted no less than 15 in (380 mm) above the floor.

EXCEPTION: These requirements do not apply where the use of special equipment dictates otherwise or where electrical and communications systems receptacles are not normally intended for use by building occupants.

4.27.4 Operation. Controls and operating mechanisms shall be operable with one hand and shall not require tight grasping, pinching, or twisting of the wrist. The force required to activate controls shall be no greater than 5 lbf (22.2 N).

4.28 Alarms.

4.28.1 General. Alarm systems required to be accessible by 4.1 shall comply with 4.28. At a minimum, visual signal appliances shall be provided in buildings and facilities in each of the following areas: restrooms and any other general usage areas (e.g., meeting rooms), hallways, lobbies, and any other area for common use.

4.28.2* Audible Alarms. If provided, audible emergency alarms shall produce a sound that exceeds the prevailing equivalent sound level in the room or space by at least 15 dbA or exceeds any maximum sound level with a duration of 60 seconds by 5 dbA, whichever is louder. Sound levels for alarm signals shall not exceed 120 dbA.

4.28.3* Visual Alarms. Visual alarm signal appliances shall be integrated into the building or facility alarm system. If single station audible alarms are provided then single station visual alarm signals shall be provided. Visual alarm signals shall have the following minimum photometric and location features:

(1) The lamp shall be a xenon strobe type or equivalent.

(2) The color shall be clear or nominal white (i.e., unfiltered or clear filtered white light).

(3) The maximum pulse duration shall be two-tenths of one second (0.2 sec) with a maximum duty cycle of 40 percent. The pulse duration is defined as the time interval between initial and final points of 10 percent of maximum signal.

(4) The intensity shall be a minimum of 75 candela.

(5) The flash rate shall be a minimum of 1 Hz and a maximum of 3 Hz.

(6) The appliance shall be placed 80 in (2030 mm) above the highest floor level within the space or 6 in (152 mm) below the ceiling, whichever is lower.

(7) In general, no place in any room or space required to have a visual signal appliance shall be more than 50 ft (15 m) from the signal (in the horizontal plane). In large rooms and spaces exceeding 100 ft (30 m) across, without obstructions 6 ft (2 m) above the finish floor, such as auditoriums, devices may be placed around the perimeter, spaced a maximum 100 ft (30 m) apart, in lieu of suspending appliances from the ceiling.

(8) No place in common corridors or hallways in which visual alarm signalling appliances are required shall be more than 50 ft (15 m) from the signal.

4.28.4* Auxiliary Alarms. Units and sleeping accommodations shall have a visual alarm connected to the building emergency alarm system or shall have a standard 110-volt electrical receptacle into which such an alarm can be connected and a means by which a signal from the building emergency alarm system can trigger such an auxiliary alarm. When visual alarms are in place the signal shall be visible in all areas of the unit or room. Instructions for use of the auxiliary alarm or receptacle shall be provided.

4.29 Detectable Warnings

4.29 Detectable Warnings.

4.29.1 General. Detectable warnings required by 4.1 and 4.7 shall comply with 4.29.

4.29.2* Detectable Warnings on Walking Surfaces. Detectable warnings shall consist of raised truncated domes with a diameter of nominal 0.9 in (23 mm), a height of nominal 0.2 in (5 mm) and a center-to-center spacing of nominal 2.35 in (60 mm) and shall contrast visually with adjoining surfaces, either light-on-dark, or dark-on-light.

The material used to provide contrast shall be an integral part of the walking surface. Detectable warnings used on interior surfaces shall differ from adjoining walking surfaces in resiliency or sound-on-cane contact.

4.29.3 Detectable Warnings on Doors To Hazardous Areas. (Reserved).

4.29.4 Detectable Warnings at Stairs. (Reserved).

4.29.5 Detectable Warnings at Hazardous Vehicular Areas. If a walk crosses or adjoins a vehicular way, and the walking surfaces are not separated by curbs, railings, or other elements between the pedestrian areas and vehicular areas, the boundary between the areas shall be defined by a continuous detectable warning which is 36 in (915 mm) wide, complying with 4.29.2.

4.29.6 Detectable Warnings at Reflecting Pools. The edges of reflecting pools shall be protected by railings, walls, curbs, or detectable warnings complying with 4.29.2.

4.29.7 Standardization. (Reserved).

4.30 Signage.

4.30.1* General. Signage required to be accessible by 4.1 shall comply with the applicable provisions of 4.30.

4.30.2* Character Proportion. Letters and numbers on signs shall have a width-to-height ratio between 3:5 and 1:1 and a stroke-width-to-height ratio between 1:5 and 1:10.

4.30.3 Character Height. Characters and numbers on signs shall be sized according to the viewing distance from which they are to be read. The minimum height is measured using an upper case X. Lower case characters are permitted.

| Height Above Finished Floor | Minimum Character Height |
|--|--------------------------|
| Suspended or Projected Overhead in compliance with 4.4.2 | 3 in. (75 mm) minimum |

4.30.4* Raised and Brailled Characters and Pictorial Symbol Signs (Pictograms). Letters and numerals shall be raised 1/32 in, upper case, sans serif or simple serif type and shall be accompanied with Grade 2 Braille. Raised characters shall be at least 5/8 in (16 mm) high, but no higher than 2 in (50 mm). Pictograms shall be accompanied by the equivalent verbal description placed directly below the pictogram. The border dimension of the pictogram shall be 6 in (152 mm) minimum in height.

4.30.5* Finish and Contrast. The characters and background of signs shall be eggshell, matte, or other non-glare finish. Characters and symbols shall contrast with their background — either light characters on a dark background or dark characters on a light background.

4.30.6 Mounting Location and Height. Where permanent identification is provided for rooms and spaces, signs shall be installed on the wall adjacent to the latch side of the door. Where there is no wall space to the latch side of the door, including at double leaf doors, signs shall be placed on the nearest adjacent wall. Mounting height shall be 60 in (1525 mm) above the finish floor to the centerline of the sign. Mounting location for such signage shall be so that a person may approach within 3 in (76 mm) of signage without encountering protruding objects or standing within the swing of a door.

4.30.7* Symbols of Accessibility.

(1) Facilities and elements required to be identified as accessible by 4.1 shall use the international symbol of accessibility. The

4.30 Signage

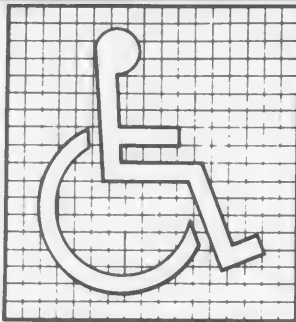

(a)
Proportions
International Symbol of Accessibility



(b)
Display Conditions
International Symbol of Accessibility



(c)
International TDD Symbol



(d)
International Symbol of Access for Hearing Loss

Fig. 43
International Symbols

symbol shall be displayed as shown in Fig. 43(a) and (b).

(2) **Volume Control Telephones.** Telephones required to have a volume control by 4.1.3(17)(b) shall be identified by a sign containing a depiction of a telephone handset with radiating sound waves.

(3) **Text Telephones.** Text telephones required by 4.1.3 (17)(c) shall be identified by the international TDD symbol (Fig 43(c)). In addition, if a facility has a public text telephone, directional signage indicating the location of the nearest text telephone shall be placed adjacent to all banks of telephones which do not contain a text telephone. Such directional signage shall include the international TDD symbol. If a facility has no banks of telephones, the directional signage shall be provided at the entrance (e.g., in a building directory).

(4) **Assistive Listening Systems.** In assembly areas where permanently installed assistive listening systems are required by 4.1.3(19)(b) the availability of such systems shall be identified with signage that includes the international symbol of access for hearing loss (Fig 43(d)).

4.30.8* Illumination Levels. (Reserved).

4.31 Telephones.

4.31.1 General. Public telephones required to be accessible by 4.1 shall comply with 4.31.

4.31.2 Clear Floor or Ground Space. A clear floor or ground space at least 30 in by 48 in (760 mm by 1220 mm) that allows either a forward or parallel approach by a person using a wheelchair shall be provided at telephones (see Fig. 44). The clear floor or ground space shall comply with 4.2.4. Bases, enclosures, and fixed seats shall not impede approaches to telephones by people who use wheelchairs.

4.31.3* Mounting Height. The highest operable part of the telephone shall be within the reach ranges specified in 4.2.5 or 4.2.6.

4.31.4 Protruding Objects. Telephones shall comply with 4.4.

4.31 Telephones

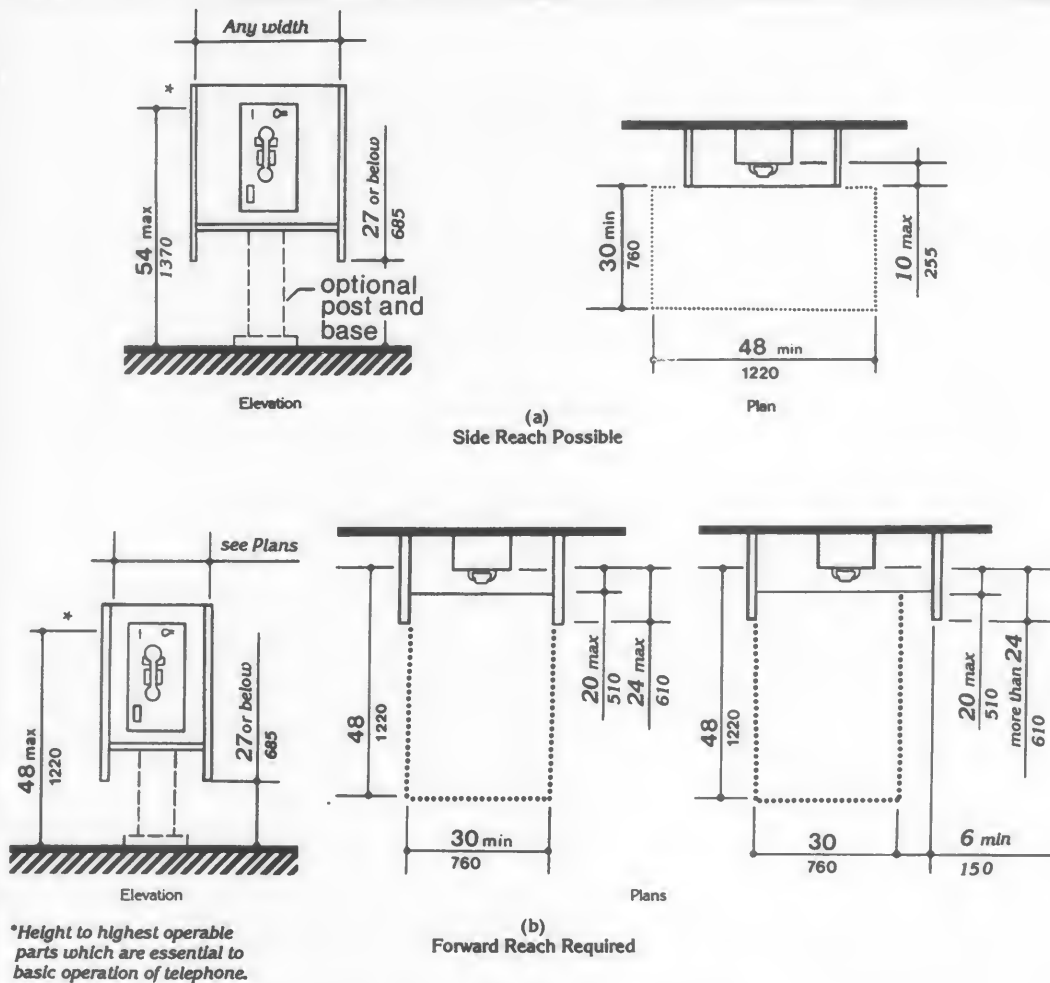

Fig. 44
Mounting Heights and Clearances for Telephones

4.31.5 Hearing Aid Compatible and Volume Control Telephones Required by 4.1.

(1) Telephones shall be hearing aid compatible.

(2) Volume controls, capable of a minimum of 12 dbA and a maximum of 18 dbA above

normal, shall be provided in accordance with 4.1.3. If an automatic reset is provided then 18 dbA may be exceeded.

4.31.6 Controls. Telephones shall have pushbutton controls where service for such equipment is available.

4.32 Fixed or Built-in Seating and Tables

4.31.7 Telephone Books. Telephone books, if provided, shall be located in a position that complies with the reach ranges specified in 4.2.5 and 4.2.6.

4.31.8 Cord Length. The cord from the telephone to the handset shall be at least 29 in (735 mm) long.

4.31.9* Text Telephones Required by 4.1.

(1) Text telephones used with a pay telephone shall be permanently affixed within, or adjacent to, the telephone enclosure. If an acoustic coupler is used, the telephone cord shall be sufficiently long to allow connection of the text telephone and the telephone receiver.

(2) Pay telephones designed to accommodate a portable text telephone shall be equipped with a shelf and an electrical outlet within or adjacent to the telephone enclosure. The telephone handset shall be capable of being placed flush on the surface of the shelf. The shelf shall be capable of accommodating a text telephone and shall have 6 in (152 mm) minimum vertical clearance in the area where the text telephone is to be placed.

(3) Equivalent facilitation may be provided. For example, a portable text telephone may be made available in a hotel at the registration desk if it is available on a 24-hour basis for use with nearby public pay telephones. In this instance, at least one pay telephone shall comply with paragraph 2 of this section. In addition, if an acoustic coupler is used, the telephone handset cord shall be sufficiently long so as to allow connection of the text telephone and the telephone receiver. Directional signage shall be provided and shall comply with 4.30.7.

4.32 Fixed or Built-in Seating and Tables.

4.32.1 Minimum Number. Fixed or built-in seating or tables required to be accessible by 4.1 shall comply with 4.32.

4.32.2 Seating. If seating spaces for people in wheelchairs are provided at fixed tables or counters, clear floor space complying with 4.2.4 shall be provided. Such clear floor space

shall not overlap knee space by more than 19 in (485 mm) (see Fig. 45).

4.32.3 Knee Clearances. If seating for people in wheelchairs is provided at tables or counters, knee spaces at least 27 in (685 mm) high, 30 in (760 mm) wide, and 19 in (485 mm) deep shall be provided (see Fig. 45).

4.32.4* Height of Tables or Counters. The tops of accessible tables and counters shall be from 28 in to 34 in (710 mm to 865 mm) above the finish floor or ground.

4.33 Assembly Areas.

4.33.1 Minimum Number. Assembly and associated areas required to be accessible by 4.1 shall comply with 4.33.

4.33.2* Size of Wheelchair Locations. Each wheelchair location shall provide minimum clear ground or floor spaces as shown in Fig. 46.

4.33.3* Placement of Wheelchair Locations. Wheelchair areas shall be an integral part of any fixed seating plan and shall be provided so as to provide people with physical disabilities a choice of admission prices and lines of sight comparable to those for members of the general public. They shall adjoin an accessible route that also serves as a means of egress in case of emergency. At least one companion fixed seat shall be provided next to each wheelchair seating area. When the seating capacity exceeds 300, wheelchair spaces shall be provided in more than one location. Readily removable seats may be installed in wheelchair spaces when the spaces are not required to accommodate wheelchair users.

EXCEPTION: Accessible viewing positions may be clustered for bleachers, balconies, and other areas having sight lines that require slopes of greater than 5 percent. Equivalent accessible viewing positions may be located on levels having accessible egress.

4.33.4 Surfaces. The ground or floor at wheelchair locations shall be level and shall comply with 4.5.

4.33 Assembly Areas

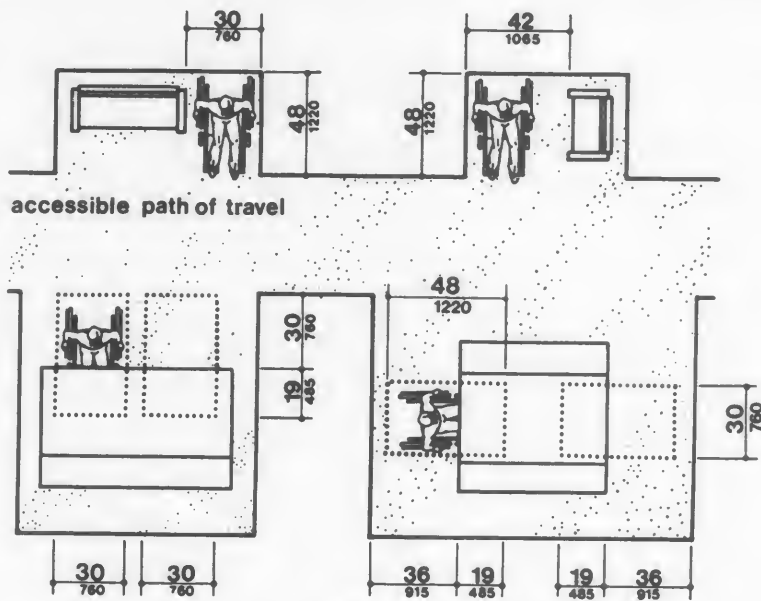

Fig. 45
Minimum Clearances for Seating and Tables

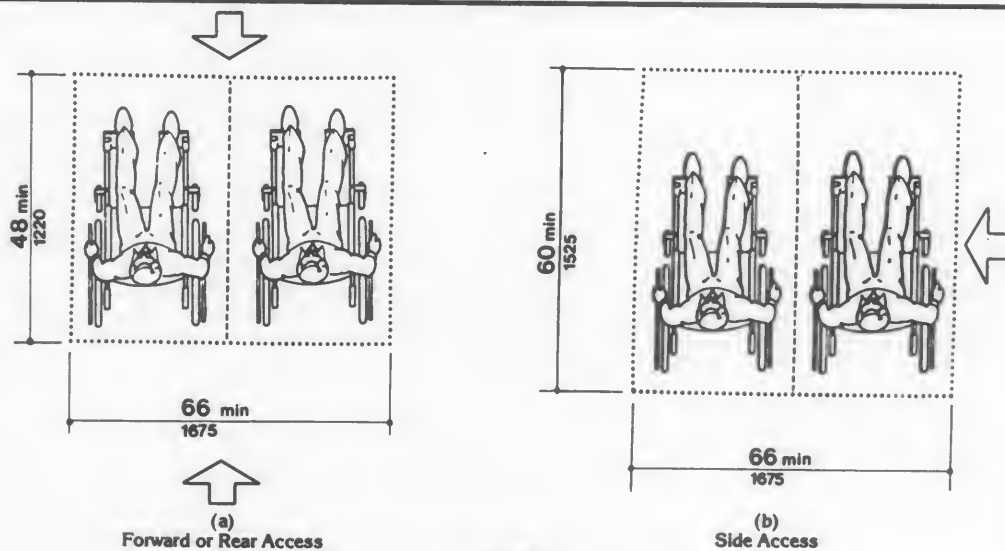

Fig. 46
Space Requirements for Wheelchair
Seating Spaces In Series

4.34 Automated Teller Machines

4.33.5 Access to Performing Areas.

An accessible route shall connect wheelchair seating locations with performing areas, including stages, arena floors, dressing rooms, locker rooms, and other spaces used by performers.

4.33.6* Placement of Listening Systems.

If the listening system provided serves individual fixed seats, then such seats shall be located within a 50 ft (15 m) viewing distance of the stage or playing area and shall have a complete view of the stage or playing area.

4.33.7* Types of Listening Systems.

Assistive listening systems (ALS) are intended to augment standard public address and audio systems by providing signals which can be received directly by persons with special receivers or their own hearing aids and which eliminate or filter background noise. The type of assistive listening system appropriate for a particular application depends on the characteristics of the setting, the nature of the program, and the intended audience. Magnetic induction loops, infra-red and radio frequency systems are types of listening systems which are appropriate for various applications.

4.34 Automated Teller Machines.

4.34.1 General. Each machine required to be accessible by 4.1.3 shall be on an accessible route and shall comply with 4.34.

4.34.2 Controls. Controls for user activation shall comply with the requirements of 4.27.

4.34.3 Clearances and Reach Range. Free standing or built-in units not having a clear space under them shall comply with 4.27.2 and 4.27.3 and provide for a parallel approach and both a forward and side reach to the unit allowing a person in a wheelchair to access the controls and dispensers.

4.34.4 Equipment for Persons with Vision Impairments. Instructions and all information for use shall be made accessible to and independently usable by persons with vision impairments.

4.35 Dressing and Fitting Rooms.

4.35.1 General. Dressing and fitting rooms required to be accessible by 4.1 shall comply with 4.35 and shall be on an accessible route.

4.35.2 Clear Floor Space. A clear floor space allowing a person using a wheelchair to make a 180-degree turn shall be provided in every accessible dressing room entered through a swinging or sliding door. No door shall swing into any part of the turning space. Turning space shall not be required in a private dressing room entered through a curtained opening at least 32 in (815 mm) wide if clear floor space complying with section 4.2 renders the dressing room usable by a person using a wheelchair.

4.35.3 Doors. All doors to accessible dressing rooms shall be in compliance with section 4.13.

4.35.4 Bench. Every accessible dressing room shall have a 24 in by 48 in (610 mm by 1220 mm) bench fixed to the wall along the longer dimension. The bench shall be mounted 17 in to 19 in (430 mm to 485 mm) above the finish floor. Clear floor space shall be provided alongside the bench to allow a person using a wheelchair to make a parallel transfer onto the bench. The structural strength of the bench and attachments shall comply with 4.26.3. Where installed in conjunction with showers, swimming pools, or other wet locations, water shall not accumulate upon the surface of the bench and the bench shall have a slip-resistant surface.

4.35.5 Mirror. Where mirrors are provided in dressing rooms of the same use, then in an accessible dressing room, a full-length mirror, measuring at least 18 in wide by 54 in high (460 mm by 1370 mm), shall be mounted in a position affording a view to a person on the bench as well as to a person in a standing position.

NOTE: Sections 4.1.1 through 4.1.7 and sections 5 through 10 are different from ANSI A117.1 in their entirety and are printed in standard type.

5.0 Restaurants and Cafeterias

5. RESTAURANTS AND CAFETERIAS.

5.1* General. Except as specified or modified in this section, restaurants and cafeterias shall comply with the requirements of 4.1 to 4.35. Where fixed tables (or dining counters where food is consumed but there is no service) are provided, at least 5 percent, but not less than one, of the fixed tables (or a portion of the dining counter) shall be accessible and shall comply with 4.32 as required in 4.1.3(18). In establishments where separate areas are designated for smoking and non-smoking patrons, the required number of accessible fixed tables (or counters) shall be proportionally distributed between the smoking and non-smoking areas. In new construction, and where practicable in alterations, accessible fixed tables (or counters) shall be distributed throughout the space or facility.

5.2 Counters and Bars. Where food or drink is served at counters exceeding 34 in (865 mm) in height for consumption by customers seated on stools or standing at the counter, a portion of the main counter which is 60 in (1525 mm) in length minimum shall be provided in compliance with 4.32 or service shall be available at accessible tables within the same area.

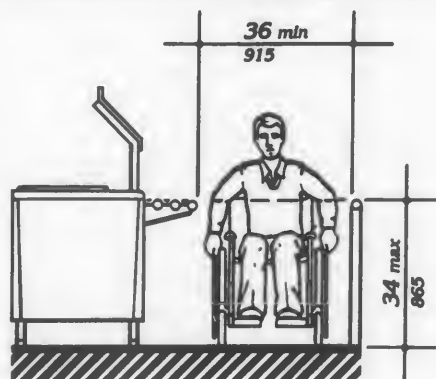

Fig. 53
Food Service Lines

5.3 Access Aisles. All accessible fixed tables shall be accessible by means of an access aisle at least 36 in (915 mm) clear between parallel edges of tables or between a wall and the table edges.

5.4 Dining Areas. In new construction, all dining areas, including raised or sunken dining areas, loggias, and outdoor seating areas, shall be accessible. In non-elevator buildings, an accessible means of vertical access to the mezzanine is not required under the following conditions: 1) the area of mezzanine seating measures no more than 33 percent of the area of the total accessible seating area; 2) the same services and decor are provided in an accessible space usable by the general public; and, 3) the accessible areas are not restricted to use by people with disabilities. In alterations, accessibility to raised or sunken dining areas, or to all parts of outdoor seating areas is not required provided that the same services and decor are provided in an accessible space usable by the general public and are not restricted to use by people with disabilities.

5.5 Food Service Lines. Food service lines shall have a minimum clear width of 36 in (915 mm), with a preferred clear width of 42 in (1065 mm) to allow passage around a person using a wheelchair. Tray slides shall be mounted no higher than 34 in (865 mm) above the floor (see Fig. 53). If self-service shelves

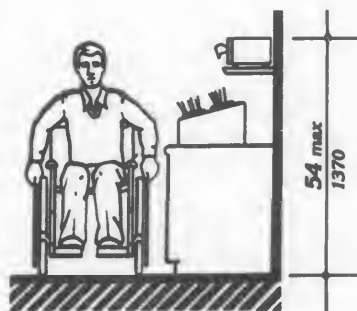

Fig. 54
Tableware Areas

6.0 Medical Care Facilities

are provided, at least 50 percent of each type must be within reach ranges specified in 4.2.5 and 4.2.6.

5.6 Tableware and Condiment Areas.

Self-service shelves and dispensing devices for tableware, dishware, condiments, food and beverages shall be installed to comply with 4.2 (see Fig. 54).

5.7 Raised Platforms. In banquet rooms or spaces where a head table or speaker's lectern is located on a raised platform, the platform shall be accessible in compliance with 4.8 or 4.11. Open edges of a raised platform shall be protected by placement of tables or by a curb.

5.8 Vending Machines and Other Equipment. Spaces for vending machines and other equipment shall comply with 4.2 and shall be located on an accessible route.

5.9 Quiet Areas. (Reserved).

6. MEDICAL CARE FACILITIES.

6.1 General. Medical care facilities included in this section are those in which people receive physical or medical treatment or care and where persons may need assistance in responding to an emergency and where the period of stay may exceed twenty-four hours. In addition to the requirements of 4.1 through 4.35, medical care facilities and buildings shall comply with 6.

(1) Hospitals - general purpose hospitals, psychiatric facilities, detoxification facilities — At least 10 percent of patient bedrooms and toilets, and all public use and common use areas are required to be designed and constructed to be accessible.

(2) Hospitals and rehabilitation facilities that specialize in treating conditions that affect mobility, or units within either that specialize in treating conditions that affect mobility — All patient bedrooms and toilets, and all public use and common use areas are required to be designed and constructed to be accessible.

(3) Long term care facilities, nursing homes — At least 50 percent of patient bedrooms and toilets, and all public use and common use areas are required to be designed and constructed to be accessible.

(4) Alterations to patient bedrooms.

(a) When patient bedrooms are being added or altered as part of a planned renovation of an entire wing, a department, or other discrete area of an existing medical facility, a percentage of the patient bedrooms that are being added or altered shall comply with 6.3. The percentage of accessible rooms provided shall be consistent with the percentage of rooms required to be accessible by the applicable requirements of 6.1(1), 6.1(2), or 6.1(3), until the number of accessible patient bedrooms in the facility equals the overall number that would be required if the facility were newly constructed. (For example, if 20 patient bedrooms are being altered in the obstetrics department of a hospital, 2 of the altered rooms must be made accessible. If, within the same hospital, 20 patient bedrooms are being altered in a unit that specializes in treating mobility impairments, all of the altered rooms must be made accessible.) Where toilet/bath rooms are part of patient bedrooms which are added or altered and required to be accessible, each such patient toilet/bathroom shall comply with 6.4.

(b) When patient bedrooms are being added or altered individually, and not as part of an alteration of the entire area, the altered patient bedrooms shall comply with 6.3, unless either: a) the number of accessible rooms provided in the department or area containing the altered patient bedroom equals the number of accessible patient bedrooms that would be required if the percentage requirements of 6.1(1), 6.1(2), or 6.1(3) were applied to that department or area; or b) the number of accessible patient bedrooms in the facility equals the overall number that would be required if the facility were newly constructed. Where toilet/bathrooms are part of patient bedrooms which are added or altered and required to be accessible, each such toilet/bathroom shall comply with 6.4.

7.0 Business and Mercantile

6.2 Entrances. At least one accessible entrance that complies with 4.14 shall be protected from the weather by canopy or roof overhang. Such entrances shall incorporate a passenger loading zone that complies with 4.6.6.

6.3 Patient Bedrooms. Provide accessible patient bedrooms in compliance with 4.1 through 4.35. Accessible patient bedrooms shall comply with the following:

(1) Each bedroom shall have a door that complies with 4.13.

EXCEPTION: Entry doors to acute care hospital bedrooms for in-patients shall be exempted from the requirement in 4.13.6 for maneuvering space at the latch side of the door if the door is at least 44 in (1120 mm) wide.

(2) Each bedroom shall have adequate space to provide a maneuvering space that complies with 4.2.3. In rooms with 2 beds, it is preferable that this space be located between beds.

(3) Each bedroom shall have adequate space to provide a minimum clear floor space of 36 in (915 mm) along each side of the bed and to provide an accessible route complying with 4.3.3 to each side of each bed.

6.4 Patient Toilet Rooms. Where toilet/bath rooms are provided as a part of a patient bedroom, each patient bedroom that is required to be accessible shall have an accessible toilet/bath room that complies with 4.22 or 4.23 and shall be on an accessible route.

7. BUSINESS AND MERCANTILE.

7.1 General. In addition to the requirements of 4.1 to 4.35, the design of all areas used for business transactions with the public shall comply with 7.

7.2 Sales and Service Counters, Teller Windows, Information Counters.

(1) In department stores and miscellaneous retail stores where counters have cash registers and are provided for sales or distribution of goods or services to the public, at least one of each type shall have a portion of the counter which is at least 36 in (915 mm) in length with a maximum height of 36 in (915 mm) above the finish floor. It shall be on an accessible route complying with 4.3. The accessible counters must be dispersed throughout the building or facility. In alterations where it is technically infeasible to provide an accessible counter, an auxiliary counter meeting these requirements may be provided.

(2) At ticketing counters, teller stations in a bank, registration counters in hotels and motels, box office ticket counters, and other counters that may not have a cash register but at which goods or services are sold or distributed, either:

(i) a portion of the main counter which is a minimum of 36 in (915 mm) in length shall be provided with a maximum height of 36 in (915 mm); or

(ii) an auxiliary counter with a maximum height of 36 in (915 mm) in close proximity to the main counter shall be provided; or

(iii) equivalent facilitation shall be provided (e.g., at a hotel registration counter, equivalent facilitation might consist of: (1) provision of a folding shelf attached to the main counter on which an individual with disabilities can write, and (2) use of the space on the side of the counter or at the concierge desk, for handing materials back and forth).

All accessible sales and service counters shall be on an accessible route complying with 4.3.

(3)* Assistive Listening Devices. (Reserved)

8.0 Libraries

7.3* Check-out Aisles.

(1) In new construction, accessible check-out aisles shall be provided in conformance with the table below:

| Total Check-out Aisles of Each Design | Minimum Number of Accessible Check-out Aisles (of each design) |
|---------------------------------------|--|
| 1 - 4 | 1 |
| 5 - 8 | 2 |
| 8 - 15 | 3 |
| over 15 | 3, plus 20% of additional aisles |

EXCEPTION: In new construction, where the selling space is under 5000 square feet, only one check-out aisle is required to be accessible.

EXCEPTION: In alterations, at least one check-out aisle shall be accessible in facilities under 5000 square feet of selling space. In facilities of 5000 or more square feet of selling space, at least one of each design of check-out aisle shall be made accessible when altered until the number of accessible check-out aisles of each design equals the number required in new construction.

Examples of check-out aisles of different "design" include those which are specifically designed to serve different functions. Different "design" includes but is not limited to the following features - length of belt or no belt; or permanent signage designating the aisle as an express lane.

(2) Clear aisle width for accessible check-out aisles shall comply with 4.2.1 and maximum adjoining counter height shall not exceed 38 in (965 mm) above the finish floor. The top of the lip shall not exceed 40 in (1015 mm) above the finish floor.

(3) Signage identifying accessible check-out aisles shall comply with 4.30.7 and shall be mounted above the check-out aisle in the same location where the check-out number or type of check-out is displayed.

7.4 Security Bollards. Any device used to prevent the removal of shopping carts from store premises shall not prevent access or egress to people in wheelchairs. An alternate

entry that is equally convenient to that provided for the ambulatory population is acceptable.

8. LIBRARIES.

8.1 General. In addition to the requirements of 4.1 to 4.35, the design of all public areas of a library shall comply with 8, including reading and study areas, stacks, reference rooms, reserve areas, and special facilities or collections.

8.2 Reading and Study Areas. At least 5 percent or a minimum of one of each element of fixed seating, tables, or study carrels shall comply with 4.2 and 4.32. Clearances between fixed accessible tables and between study carrels shall comply with 4.3.

8.3 Check-Out Areas. At least one lane at each check-out area shall comply with 7.2(1). Any traffic control or book security gates or turnstiles shall comply with 4.13.

8.4 Card Catalogs and Magazine Displays. Minimum clear aisle space at card catalogs and magazine displays shall comply with Fig. 55. Maximum reach height shall comply with 4.2, with a height of 48 in (1220 mm) preferred irrespective of approach allowed.

8.5 Stacks. Minimum clear aisle width between stacks shall comply with 4.3, with a minimum clear aisle width of 42 in (1065 mm) preferred where possible. Shelf height in stack areas is unrestricted (see Fig. 56).

9.0 Accessible Transient Lodging

9. ACCESSIBLE TRANSIENT LODGING.

(1) Except as specified in the special technical provisions of this section, accessible transient lodging shall comply with the applicable requirements of 4.1 through 4.35. Transient lodging includes facilities or portions thereof used for sleeping accommodations, when not classed as a medical care facility.

9.1 Hotels, Motels, Inns, Boarding Houses, Dormitories, Resorts and Other Similar Places of Transient Lodging.

9.1.1 General. All public use and common use areas are required to be designed and constructed to comply with section 4 (Accessible Elements and Spaces: Scope and Technical Requirements).

EXCEPTION: Sections 9.1 through 9.4 do not apply to an establishment located within a building that contains not more than five rooms for rent or hire and that is actually occupied by the proprietor of such establishment as the residence of such proprietor.

9.1.2 Accessible Units, Sleeping Rooms, and Suites. Accessible sleeping rooms or suites that comply with the requirements of 9.2 (Requirements for Accessible Units, Sleeping Rooms, and Suites) shall be provided in conformance with the table below. In addition, in hotels, of 50 or more sleeping rooms or suites, additional accessible sleeping rooms or suites that include a roll-in shower shall also be provided in conformance with the table below. Such accommodations shall comply with the requirements of 9.2, 4.21, and Figure 57(a) or (b).

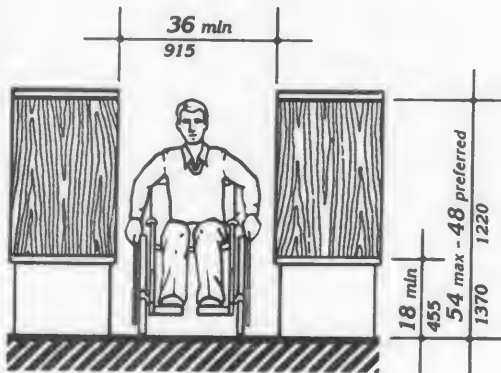

Fig. 55
Card Catalog

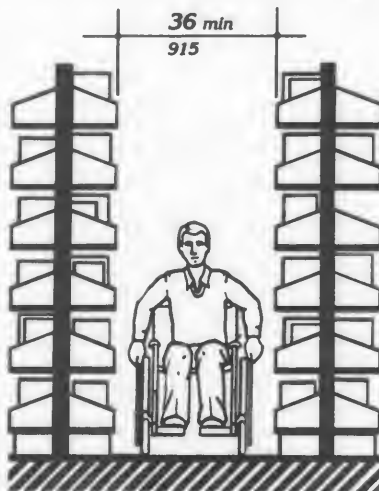

Fig. 56
Stacks

9.1.3 Sleeping Accommodations for Persons with Hearing Impairments

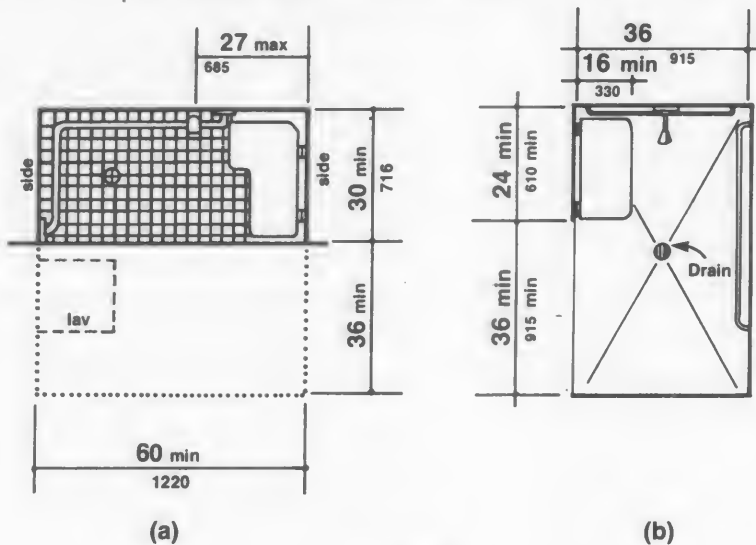

Fig. 57
Roll-in Shower with Folding Seat

| Number of Rooms | Accessible Rooms | Rooms with Roll-in Showers |
|-----------------|----------------------------------|---|
| 1 to 25 | 1 | |
| 26 to 50 | 2 | |
| 51 to 75 | 3 | 1 |
| 76 to 100 | 4 | 1 |
| 101 to 150 | 5 | 2 |
| 151 to 200 | 6 | 2 |
| 201 to 300 | 7 | 3 |
| 301 to 400 | 8 | 4 |
| 401 to 500 | 9 | 4 plus one for each additional 100 over 400 |
| 501 to 1000 | 2% of total | |
| 1001 and over | 20 plus 1 for each 100 over 1000 | |

and suites that comply with 9.3 (Visual Alarms, Notification Devices, and Telephones) shall be provided in conformance with the following table:

| Number of Elements | Accessible Elements |
|--------------------|----------------------------------|
| 1 to 25 | 1 |
| 26 to 50 | 2 |
| 51 to 75 | 3 |
| 76 to 100 | 4 |
| 101 to 150 | 5 |
| 151 to 200 | 6 |
| 201 to 300 | 7 |
| 301 to 400 | 8 |
| 401 to 500 | 9 |
| 501 to 1000 | 2% of total |
| 1001 and over | 20 plus 1 for each 100 over 1000 |

9.1.3 Sleeping Accommodations for Persons with Hearing Impairments.

In addition to those accessible sleeping rooms and suites required by 9.1.2, sleeping rooms

9.2 Requirements for Accessible Units, Sleeping Rooms and Suites

9.1.4 Classes of Sleeping Accommodations.

(1) In order to provide persons with disabilities a range of options equivalent to those available to other persons served by the facility, sleeping rooms and suites required to be accessible by 9.1.2 shall be dispersed among the various classes of sleeping accommodations available to patrons of the place of transient lodging. Factors to be considered include room size, cost, amenities provided, and the number of beds provided.

(2) **Equivalent Facilitation.** For purposes of this section, it shall be deemed equivalent facilitation if the operator of a facility elects to limit construction of accessible rooms to those intended for multiple occupancy, provided that such rooms are made available at the cost of a single-occupancy room to an individual with disabilities who requests a single-occupancy room.

9.1.5. Alterations to Accessible Units, Sleeping Rooms, and Suites. When sleeping rooms are being altered in an existing facility, or portion thereof, subject to the requirements of this section, at least one sleeping room or suite that complies with the requirements of 9.2 (Requirements for Accessible Units, Sleeping Rooms, and Suites) shall be provided for each 25 sleeping rooms, or fraction thereof, of rooms being altered until the number of such rooms provided equals the number required to be accessible with 9.1.2. In addition, at least one sleeping room or suite that complies with the requirements of 9.3 (Visual Alarms, Notification Devices, and Telephones) shall be provided for each 25 sleeping rooms, or fraction thereof, of rooms being altered until the number of such rooms equals the number required to be accessible by 9.1.3.

9.2 Requirements for Accessible Units, Sleeping Rooms and Suites.

9.2.1 General. Units, sleeping rooms, and suites required to be accessible by 9.1 shall comply with 9.2.

9.2.2 Minimum Requirements. An accessible unit, sleeping room or suite shall be on an

accessible route complying with 4.3 and have the following accessible elements and spaces.

(1) Accessible sleeping rooms shall have a 36 in (915 mm) clear width maneuvering space located along both sides of a bed, except that where two beds are provided, this requirement can be met by providing a 36 in (915 mm) wide maneuvering space located between the two beds.

(2) An accessible route complying with 4.3 shall connect all accessible spaces and elements, including telephones, within the unit, sleeping room, or suite. This is not intended to require an elevator in multi-story units as long as the spaces identified in 9.2.2(6) and (7) are on accessible levels and the accessible sleeping area is suitable for dual occupancy.

(3) Doors and doorways designed to allow passage into and within all sleeping rooms, suites or other covered units shall comply with 4.13.

(4) If fixed or built-in storage facilities such as cabinets, shelves, closets, and drawers are provided in accessible spaces, at least one of each type provided shall contain storage space complying with 4.25. Additional storage may be provided outside of the dimensions required by 4.25.

(5) All controls in accessible units, sleeping rooms, and suites shall comply with 4.27.

(6) Where provided as part of an accessible unit, sleeping room, or suite, the following spaces shall be accessible and shall be on an accessible route:

- (a) the living area.
- (b) the dining area.
- (c) at least one sleeping area.
- (d) patios, terraces, or balconies.

EXCEPTION: The requirements of 4.13.8 and 4.3.8 do not apply where it is necessary to utilize a higher door threshold or a change in level to protect the integrity of the unit from wind/water damage. Where this exception results in patios, terraces or balconies that are not at an accessible level, equivalent facilitation

9.3 Visual Alarms, Notification Devices and Telephones

shall be provided. (E.g., equivalent facilitation at a hotel patio or balcony might consist of providing raised decking or a ramp to provide accessibility.)

(e) at least one full bathroom (i.e., one with a water closet, a lavatory, and a bathtub or shower).

(f) if only half baths are provided, at least one half bath.

(g) carports, garages or parking spaces.

(7) Kitchens, Kitchenettes, or Wet Bars.

When provided as accessory to a sleeping room or suite, kitchens, kitchenettes, wet bars, or similar amenities shall be accessible. Clear floor space for a front or parallel approach to cabinets, counters, sinks, and appliances shall be provided to comply with 4.2.4. Countertops and sinks shall be mounted at a maximum height of 34 in (865 mm) above the floor. At least fifty percent of shelf space in cabinets or refrigerator/freezers shall be within the reach ranges of 4.2.5 or 4.2.6 and space shall be designed to allow for the operation of cabinet and/or appliance doors so that all cabinets and appliances are accessible and usable. Controls and operating mechanisms shall comply with 4.27.

(8) Sleeping room accommodations for persons with hearing impairments required by 9.1 and complying with 9.3 shall be provided in the accessible sleeping room or suite.

9.3 Visual Alarms, Notification Devices and Telephones.

9.3.1 General. In sleeping rooms required to comply with this section, auxiliary visual alarms shall be provided and shall comply with 4.28.4. Visual notification devices shall also be provided in units, sleeping rooms and suites to alert room occupants of incoming telephone calls and a door knock or bell. Notification devices shall not be connected to auxiliary visual alarm signal appliances. Permanently installed telephones shall have volume controls complying with 4.31.5; an accessible electrical outlet within 4 ft (1220 mm) of a telephone connection shall be provided to facilitate the use of a text telephone.

9.3.2 Equivalent Facilitation. For purposes of this section, equivalent facilitation shall include the installation of electrical outlets (including outlets connected to a facility's central alarm system) and telephone wiring in sleeping rooms and suites to enable persons with hearing impairments to utilize portable visual alarms and communication devices provided by the operator of the facility.

9.4 Other Sleeping Rooms and

Suites. Doors and doorways designed to allow passage into and within all sleeping units or other covered units shall comply with 4.13.5.

9.5 Transient Lodging in Homeless Shelters, Halfway Houses, Transient Group Homes, and Other Social Service Establishments.

9.5.1 New Construction. In new construction all public use and common use areas are required to be designed and constructed to comply with section 4. At least one of each type of amenity (such as washers, dryers and similar equipment installed for the use of occupants) in each common area shall be accessible and shall be located on an accessible route to any accessible unit or sleeping accommodation.

EXCEPTION: Where elevators are not provided as allowed in 4.1.3(5), accessible amenities are not required on inaccessible floors as long as one of each type is provided in common areas on accessible floors.

9.5.2 Alterations.

(1) Social service establishments which are not homeless shelters:

(a) The provisions of 9.5.3 and 9.1.5 shall apply to sleeping rooms and beds.

(b) Alteration of other areas shall be consistent with the new construction provisions of 9.5.1.

(2) Homeless shelters. If the following elements are altered, the following requirements apply:

10.0 Transportation Facilities

(a) at least one public entrance shall allow a person with mobility impairments to approach, enter and exit including a minimum clear door width of 32 in (815 mm).

(b) sleeping space for homeless persons as provided in the scoping provisions of 9.1.2 shall include doors to the sleeping area with a minimum clear width of 32 in (815 mm) and maneuvering space around the beds for persons with mobility impairments complying with 9.2.2(1).

(c) at least one toilet room for each gender or one unisex toilet room shall have a minimum clear door width of 32 in (815 mm), minimum turning space complying with 4.2.3, one water closet complying with 4.16, one lavatory complying with 4.19 and the door shall have a privacy latch; and, if provided, at least one tub or shower shall comply with 4.20 or 4.21, respectively.

(d) at least one common area which a person with mobility impairments can approach, enter and exit including a minimum clear door width of 32 in (815 mm).

(e) at least one route connecting elements (a), (b), (c) and (d) which a person with mobility impairments can use including minimum clear width of 36 in (915 mm), passing space complying with 4.3.4, turning space complying with 4.2.3 and changes in levels complying with 4.3.8.

(f) homeless shelters can comply with the provisions of (a)-(e) by providing the above elements on one accessible floor.

9.5.3. Accessible Sleeping Accommodations in New Construction. Accessible sleeping rooms shall be provided in conformance with the table in 9.1.2 and shall comply with 9.2 Accessible Units, Sleeping Rooms and Suites (where the items are provided). Additional sleeping rooms that comply with 9.3 Sleeping Accommodations for Persons with Hearing Impairments shall be provided in conformance with the table provided in 9.1.3.

In facilities with multi-bed rooms or spaces, a percentage of the beds equal to the table provided in 9.1.2 shall comply with 9.2.2(1).

10. TRANSPORTATION FACILITIES. (Reserved).

APPENDIX

This appendix contains *materials of an advisory nature* and provides additional information that should help the reader to understand the minimum requirements of the *guidelines* or to design buildings or facilities for greater accessibility. The paragraph numbers correspond to the sections or paragraphs of the *guideline* to which the material relates and are therefore not consecutive (for example, A4.2.1 contains additional information relevant to 4.2.1). Sections of the *guidelines* for which additional material appears in this appendix have been indicated by an asterisk. *Nothing in this appendix shall in any way obviate any obligation to comply with the requirements of the guidelines itself.*

A2.2 Equivalent Facilitation. *Specific examples of equivalent facilitation are found in the following sections:*

- | | |
|-------------|--|
| 4.1.6(3)(c) | Elevators in Alterations |
| 4.31.9 | Text Telephones |
| 7.2 | Sales and Service Counters, Teller Windows, Information Counters |
| 9.1.4 | Classes of Sleeping Accommodations |
| 9.2.2(6)(d) | Requirements for Accessible Units, Sleeping Rooms, and Suites |

A4.1.1 Application.

A4.1.1(3) Areas Used Only by Employees as Work Areas. *Where there are a series of individual work stations of the same type (e.g., laboratories, service counters, ticket booths), 5%, but not less than one, of each type of work station should be constructed so that an individual with disabilities can maneuver within the work stations. Rooms housing individual offices in a typical office building must meet the requirements of the guidelines concerning doors, accessible routes, etc. but do not need to allow for maneuvering space around individual desks. Modifications required to permit maneuvering within the work area may be accomplished as a reasonable accommodation to individual employees with disabilities under Title I of the ADA. Consideration should also be given to placing shelves in employee work areas at a*

convenient height for accessibility or installing commercially available shelving that is adjustable so that reasonable accommodations can be made in the future.

If work stations are made accessible they should comply with the applicable provisions of 4.2 through 4.35.

A4.1.2 Accessible Sites and Exterior Facilities: New Construction.

A4.1.2(5)(e) Valet Parking. *Valet parking is not always usable by individuals with disabilities. For instance, an individual may use a type of vehicle controls that render the regular controls inoperable or the driver's seat in a van may be removed. In these situations, another person cannot park the vehicle. It is recommended that some self-parking spaces be provided at valet parking facilities for individuals whose vehicles cannot be parked by another person and that such spaces be located on an accessible route to the entrance of the facility.*

A4.1.3 Accessible Buildings: New Construction.

A4.1.3(5) *Only full passenger elevators are covered by the accessibility provisions of 4.10. Materials and equipment hoists, freight elevators not intended for passenger use, dumbwaiters, and construction elevators are not covered by these guidelines. If a building is exempt from the elevator requirement, it is not necessary to provide a platform lift or other means of vertical access in lieu of an elevator.*

Under Exception 4, platform lifts are allowed where existing conditions make it impractical to install a ramp or elevator. Such conditions generally occur where it is essential to provide access to small raised or lowered areas where space may not be available for a ramp. Examples include, but are not limited to, raised pharmacy platforms, commercial offices raised above a sales floor, or radio and news booths.

A4.1.3(9) *Supervised automatic sprinkler systems have built in signals for monitoring features of the system such as the opening and closing of water control valves, the power supplies for needed pumps, water tank levels, and for indicating conditions that will impair the satisfactory operation of the sprinkler system.*

A4.2 Space Allowances and Reach Ranges

Because of these monitoring features, supervised automatic sprinkler systems have a high level of satisfactory performance and response to fire conditions.

A4.1.3(10) If an odd number of drinking fountains is provided on a floor, the requirement in 4.1.3(10)(b) may be met by rounding down the odd number to an even number and calculating 50% of the even number. When more than one drinking fountain on a floor is required to comply with 4.15, those fountains should be dispersed to allow wheelchair users convenient access. For example, in a large facility such as a convention center that has water fountains at several locations on a floor, the accessible water fountains should be located so that wheelchair users do not have to travel a greater distance than other people to use a drinking fountain.

A4.1.3(17)(b) In addition to the requirements of section 4.1.3(17)(b), the installation of additional volume controls is encouraged. Volume controls may be installed on any telephone.

A4.1.3(19)(a) Readily removable or folding seating units may be installed in lieu of providing an open space for wheelchair users. Folding seating units are usually two fixed seats that can be easily folded into a fixed center bar to allow for one or two open spaces for wheelchair users when necessary. These units are more easily adapted than removable seats which generally require the seat to be removed in advance by the facility management.

Either a sign or a marker placed on seating with removable or folding arm rests is required by this section. Consideration should be given for ensuring identification of such seats in a darkened theater. For example, a marker which contrasts (light on dark or dark on light) and which also reflects light could be placed on the side of such seating so as to be visible in a lighted auditorium and also to reflect light from a flashlight.

A4.1.6 Accessible Buildings: Alterations.

A4.1.6(1)(h) When an entrance is being altered, it is preferable that those entrances being altered be made accessible to the extent feasible.

A4.2 Space Allowances and Reach Ranges.

A4.2.1 Wheelchair Passage Width.

(1) Space Requirements for Wheelchairs. Many persons who use wheelchairs need a 30 in (760 mm) clear opening width for doorways, gates, and the like, when the latter are entered head-on. If the person is unfamiliar with a building, if competing traffic is heavy, if sudden or frequent movements are needed, or if the wheelchair must be turned at an opening, then greater clear widths are needed. For most situations, the addition of an inch of leeway on either side is sufficient. Thus, a minimum clear width of 32 in (815 mm) will provide adequate clearance. However, when an opening or a restriction in a passageway is more than 24 in (610 mm) long, it is essentially a passageway and must be at least 36 in (915 mm) wide.

(2) Space Requirements for Use of Walking Aids. Although people who use walking aids can maneuver through clear width openings of 32 in (815 mm), they need 36 in (915 mm) wide passageways and walks for comfortable gaits. Crutch tips, often extending down at a wide angle, are a hazard in narrow passageways where they might not be seen by other pedestrians. Thus, the 36 in (915 mm) width provides a safety allowance both for the person with a disability and for others.

(3) Space Requirements for Passing. Able-bodied persons in winter clothing, walking

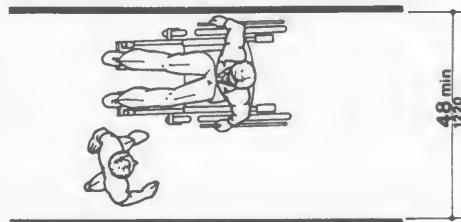

Fig. A1
Minimum Passage Width for One Wheelchair
and One Ambulatory Person

A4.2 Space Allowances and Reach Ranges

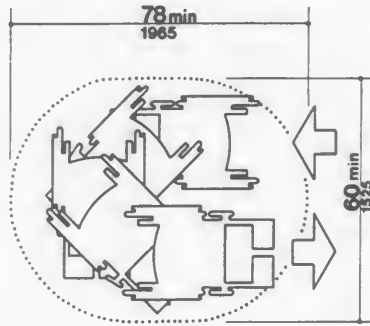
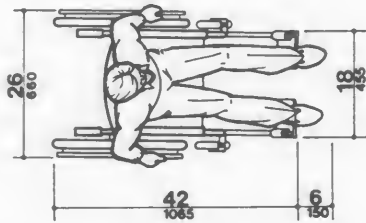
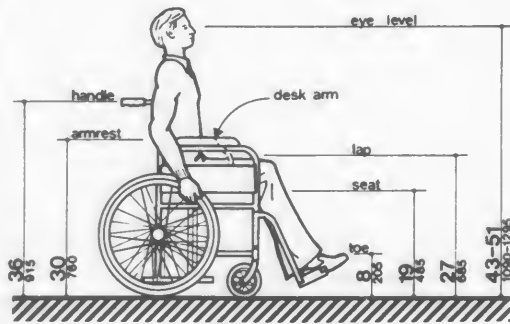

Fig. A2
Space Needed for Smooth U-Turn in a Wheelchair



NOTE: Footrests may extend further for tall people

Fig. A3
Dimensions of Adult-Sized Wheelchairs

straight ahead with arms swinging, need 32 in (815 mm) of width, which includes 2 in (50 mm) on either side for sway, and another 1 in (25 mm) tolerance on either side for clearing nearby objects or other pedestrians. Almost all wheelchair users and those who use walking aids can also manage within this 32 in (815 mm) width for short distances. Thus, two streams of traffic can pass in 64 in (1625 mm) in a comfortable flow. Sixty inches (1525 mm) provides a minimum width for a somewhat more restricted flow. If the clear width is less than 60 in (1525 mm), two wheelchair users will not be able to pass but will have to seek a wider place for passing. Forty-eight inches (1220 mm) is the minimum width needed for an ambulatory person to pass a nonambulatory or semi-ambulatory person. Within this 48 in (1220 mm) width, the ambulatory person will have to twist to pass a wheelchair user, a person with a *service animal*, or a

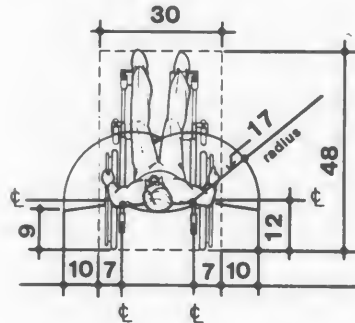
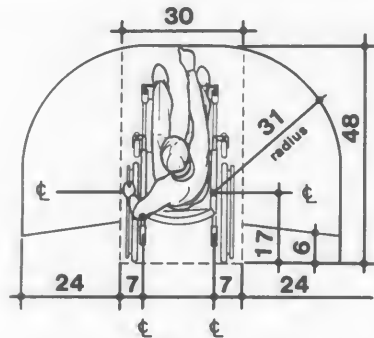

Fig. A3 (a)

A4.3 Accessible Route

semi-ambulatory person. There will be little leeway for swaying or missteps (see Fig. A1).

A4.2.3 Wheelchair Turning Space.

These guidelines specify a minimum space of 60 in (1525 mm) diameter or a 60 in by 60 in (1525 mm by 1525 mm) T-shaped space for a pivoting 180-degree turn of a wheelchair. This space is usually satisfactory for turning around, but many people will not be able to turn without repeated tries and bumping into surrounding objects. The space shown in Fig. A2 will allow most wheelchair users to complete U-turns without difficulty.

A4.2.4 Clear Floor or Ground Space for Wheelchairs. The wheelchair and user shown in Fig. A3 represent typical dimensions for a large adult male. The space requirements in this guideline are based upon maneuvering clearances that will accommodate most wheelchairs. Fig. A3 provides a uniform reference for design not covered by this guideline.

A4.2.5 & A4.2.6 Reach. Reach ranges for persons seated in wheelchairs may be further clarified by Fig. A3(a). These drawings approximate in the plan view the information shown in Fig. 4, 5, and 6.

A4.3 Accessible Route.

A4.3.1 General.

(1) **Travel Distances.** Many people with mobility impairments can move at only very slow speeds; for many, traveling 200 ft (61 m) could take about 2 minutes. This assumes a rate of about 1.5 ft/s (455 mm/s) on level ground. It also assumes that the traveler would move continuously. However, on trips over 100 ft (30 m), disabled people are apt to rest frequently, which substantially increases their trip times. Resting periods of 2 minutes for every 100 ft (30 m) can be used to estimate travel times for people with severely limited stamina. In inclement weather, slow progress and resting can greatly increase a disabled person's exposure to the elements.

(2) **Sites.** Level, indirect routes or those with running slopes lower than 1:20 can sometimes provide more convenience than direct routes with maximum allowable slopes or with ramps.

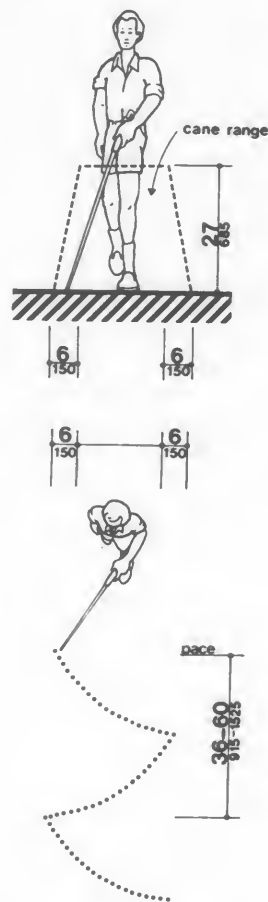

Fig. A4
Cane Technique

A4.3.10 Egress. Because people with disabilities may visit, be employed or be a resident in any building, emergency management plans with specific provisions to ensure their safe evacuation also play an essential role in fire safety and life safety.

A4.3.11.3 Stairway Width. A 48 inch (1220 mm) wide exit stairway is needed to allow assisted evacuation (e.g., carrying a person in a wheelchair) without encroaching on the exit path for ambulatory persons.

A4.5 Ground and Floor Surfaces

A4.3.11.4 Two-way Communication. *It is essential that emergency communication not be dependent on voice communications alone because the safety of people with hearing or speech impairments could be jeopardized. The visible signal requirement could be satisfied with something as simple as a button in the area of rescue assistance that lights, indicating that help is on the way, when the message is answered at the point of entry.*

A4.4 Protruding Objects.

A4.4.1 General. *Service animals are trained to recognize and avoid hazards. However, most people with severe impairments of vision use the long cane as an aid to mobility. The two principal cane techniques are the touch technique, where the cane arcs from side to side and touches points outside both shoulders; and the diagonal technique, where the cane is held in a stationary position diagonally across the body with the cane tip touching or just above the ground at a point outside one shoulder and the handle or grip extending to a point outside the other shoulder. The touch technique is used primarily in uncontrolled areas, while the diagonal technique is used primarily in certain limited, controlled, and familiar environments. Cane users are often trained to use both techniques.*

Potential hazardous objects are noticed only if they fall within the detection range of canes (see Fig. A4). Visually impaired people walking toward an object can detect an overhang if its lowest surface is not higher than 27 in (685 mm). When walking alongside protruding objects, they cannot detect overhangs. Since proper cane and *service animal* techniques keep people away from the edge of a path or from walls, a slight overhang of no more than 4 in (100 mm) is not hazardous.

A4.5 Ground and Floor Surfaces.

A4.5.1 General. *People who have difficulty walking or maintaining balance or who use crutches, canes, or walkers, and those with restricted gaits are particularly sensitive to slipping and tripping hazards. For such people, a stable and regular surface is necessary for safe walking, particularly on stairs. Wheelchairs can be propelled most easily on surfaces that are hard, stable, and regular. Soft loose*

surfaces such as shag carpet, loose sand or gravel, wet clay, and irregular surfaces such as cobblestones can significantly impede wheelchair movement.

Slip resistance is based on the frictional force necessary to keep a shoe heel or crutch tip from slipping on a walking surface under conditions likely to be found on the surface. While the dynamic coefficient of friction during walking varies in a complex and non-uniform way, the static coefficient of friction, which can be measured in several ways, provides a close approximation of the slip resistance of a surface. Contrary to popular belief, some slippage is necessary to walking, especially for persons with restricted gaits; a truly "non-slip" surface could not be negotiated.

The Occupational Safety and Health Administration recommends that walking surfaces have a static coefficient of friction of 0.5. A research project sponsored by the Architectural and Transportation Barriers Compliance Board (Access Board) conducted tests with persons with disabilities and concluded that a higher coefficient of friction was needed by such persons. A static coefficient of friction of 0.6 is recommended for accessible routes and 0.8 for ramps.

It is recognized that the coefficient of friction varies considerably due to the presence of contaminants, water, floor finishes, and other factors not under the control of the designer or builder and not subject to design and construction guidelines and that compliance would be difficult to measure on the building site. Nevertheless, many common building materials suitable for flooring are now labeled with information on the static coefficient of friction. While it may not be possible to compare one product directly with another, or to guarantee a constant measure, builders and designers are encouraged to specify materials with appropriate values. As more products include information on slip resistance, improved uniformity in measurement and specification is likely. The Access Board's advisory guidelines on Slip Resistant Surfaces provides additional information on this subject.

Cross slopes on walks and ground or floor surfaces can cause considerable difficulty in propelling a wheelchair in a straight line.

A4.6 Parking and Passenger Loading Zones

A4.5.3 Carpet. Much more needs to be done in developing both quantitative and qualitative criteria for carpeting (*i.e.*, problems associated with texture and weave need to be studied). However, certain functional characteristics are well established. When both carpet and padding are used, it is desirable to have minimum movement (preferably none) between the floor and the pad and the pad and the carpet which would allow the carpet to hump or warp. In heavily trafficked areas, a thick, soft (plush) pad or cushion, particularly in combination with long carpet pile, makes it difficult for individuals in wheelchairs and those with other ambulatory disabilities to get about. Firm carpeting can be achieved through proper selection and combination of pad and carpet, sometimes with the elimination of the pad or cushion, and with proper installation. Carpeting designed with a weave that causes a zig-zag effect when wheeled across is strongly discouraged.

A4.6 Parking and Passenger Loading Zones.

A4.6.3 Parking Spaces. The increasing use of vans with side-mounted lifts or ramps by persons with disabilities has necessitated some revisions in specifications for parking spaces and adjacent access aisles. The typical accessible parking space is 96 in (2440 mm) wide with an adjacent 60 in (1525 mm) access aisle. However, this aisle does not permit lifts or ramps to be deployed and still leave room for a person using a wheelchair or other mobility aid to exit the lift platform or ramp. In tests conducted with actual lift/van/wheelchair combinations, (under a Board-sponsored Accessible Parking and Loading Zones Project) researchers found that a space and aisle totaling almost 204 in (5180 mm) wide was needed to deploy a lift and exit conveniently. The "van accessible" parking space required by these guidelines provides a 96 in (2440 mm) wide space with a 96 in (2440 mm) adjacent access aisle which is just wide enough to maneuver and exit from a side mounted lift. If a 96 in (2440 mm) access aisle is placed between two spaces, two "van accessible" spaces are created. Alternatively, if the wide access aisle is provided at the end of a row (an area often unused), it may be possible to provide the wide access aisle without additional space (see Fig. A5(a)).

A sign is needed to alert van users to the presence of the wider aisle, but the space is not intended to be restricted only to vans.

"Universal" Parking Space Design. An alternative to the provision of a percentage of spaces with a wide aisle, and the associated need to include additional signage, is the use of what has been called the "universal" parking space design. Under this design, all accessible spaces are 132 in (3350 mm) wide with a 60 in (1525 mm) access aisle (see Fig. A5(b)). One

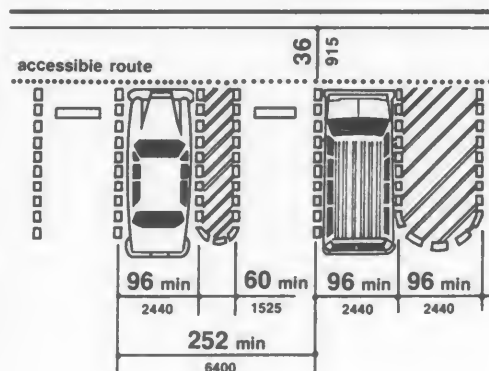

(a)
Van Accessible Space at End Row

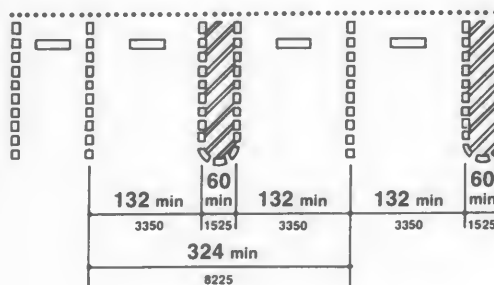

(b)
Universal Parking Space Design

Fig. A5
Parking Space Alternatives

A4.8 Ramps

advantage to this design is that no additional signage is needed because all spaces can accommodate a van with a side-mounted lift or ramp. Also, there is no competition between cars and vans for spaces since all spaces can accommodate either. Furthermore, the wider space permits vehicles to park to one side or the other within the 132 in (3350 mm) space to allow persons to exit and enter the vehicle on either the driver or passenger side, although, in some cases, this would require exiting or entering without a marked access aisle.

An essential consideration for any design is having the access aisle level with the parking space. Since a person with a disability, using a lift or ramp, must maneuver within the access aisle, the aisle cannot include a ramp or sloped area. The access aisle must be connected to an accessible route to the appropriate accessible entrance of a building or facility. The parking access aisle must either blend with the accessible route or have a curb ramp complying with 4.7. Such a curb ramp opening must be located within the access aisle boundaries, not within the parking space boundaries. Unfortunately, many facilities are designed with a ramp that is blocked when any vehicle parks in the accessible space. Also, the required dimensions of the access aisle cannot be restricted by planters, curbs or wheel stops.

A4.6.4 Signage. Signs designating parking places for disabled people can be seen from a driver's seat if the signs are mounted high enough above the ground and located at the front of a parking space.

A4.6.5 Vertical Clearance. High-top vans, which disabled people or transportation services often use, require higher clearances in parking garages than automobiles.

A4.8 Ramps.

A4.8.1 General. Ramps are essential for wheelchair users if elevators or lifts are not available to connect different levels. However, some people who use walking aids have difficulty with ramps and prefer stairs.

A4.8.2 Slope and Rise. Ramp slopes between 1:16 and 1:20 are preferred. The ability to manage an incline is related to both its slope and its length. Wheelchair users with

disabilities affecting *their* arms or with low stamina have serious difficulty using inclines. Most ambulatory people and most people who use wheelchairs can manage a slope of 1:16. Many people cannot manage a slope of 1:12 for 30 ft (9 m).

A4.8.4 Landings. Level landings are essential toward maintaining an aggregate slope that complies with these guidelines. A ramp landing that is not level causes individuals using wheelchairs to tip backward or bottom out when the ramp is approached.

A4.8.5 Handrails. The requirements for stair and ramp handrails in this guideline are for adults. When children are principal users in a building or facility, a second set of handrails at an appropriate height can assist them and aid in preventing accidents.

A4.9 Stairs.

A4.9.1 Minimum Number. Only interior and exterior stairs connecting levels that are not connected by an elevator, ramp, or other accessible means of vertical access have to comply with 4.9.

A4.10 Elevators.

A4.10.6 Door Protective and Reopening Device. The required door reopening device would hold the door open for 20 seconds if the doorway remains obstructed. After 20 seconds, the door may begin to close. However, if designed in accordance with ASME A17.1-1990, the door closing movement could still be stopped if a person or object exerts sufficient force at any point on the door edge.

A4.10.7 Door and Signal Timing for Hall Calls. This paragraph allows variation in the location of call buttons, advance time for warning signals, and the door-holding period used to meet the time requirement.

A4.10.12 Car Controls. Industry-wide standardization of elevator control panel design would make all elevators significantly more convenient for use by people with severe visual impairments. In many cases, it will be possible to locate the highest control on elevator panels within 48 in (1220 mm) from the floor.

A4.11 Platform Lifts (Wheelchair Lifts)

A4.10.13 Car Position Indicators. A special button may be provided that would activate the audible signal within the given elevator only for the desired trip, rather than maintaining the audible signal in constant operation.

A4.10.14 Emergency Communications. A device that requires no handset is easier to use by people who have difficulty reaching. Also, *small handles on handset compartment doors are not usable by people who have difficulty grasping.*

Ideally, emergency two-way communication systems should provide both voice and visual display intercommunication so that persons with hearing impairments and persons with vision impairments can receive information regarding the status of a rescue. A voice intercommunication system cannot be the only means of communication because it is not accessible to people with speech and hearing impairments. While a voice intercommunication system is not required, at a minimum, the system should provide both an audio and visual indication that a rescue is on the way.

A4.11 Platform Lifts (Wheelchair Lifts).

A4.11.2 Other Requirements. *Inclined stairway chairlifts, and inclined and vertical platform lifts (wheelchair lifts) are available for short-distance, vertical transportation of people with disabilities. Care should be taken in selecting lifts as some lifts are not equally suitable for use by both wheelchair users and semi-ambulatory individuals.*

A4.12 Windows.

A4.12.1 General. *Windows intended to be operated by occupants in accessible spaces should comply with 4.12.*

A4.12.2 Window Hardware. *Windows requiring pushing, pulling, or lifting to open (for example, double-hung, sliding, or casement and awning units without cranks) should require no more than 5 lbf (22.2 N) to open or close. Locks, cranks, and other window hardware should comply with 4.27.*

A4.13 Doors.

A4.13.8 Thresholds at Doorways. Thresholds and surface height changes in doorways are particularly inconvenient for wheelchair users who also have low stamina or restrictions in arm movement because complex maneuvering is required to get over the level change while operating the door.

A4.13.9 Door Hardware. Some disabled persons must push against a door with their chair or walker to open it. Applied kickplates on doors with closers can reduce required maintenance by withstanding abuse from wheelchairs and canes. To be effective, they should cover the door width, less approximately 2 in (51 mm), up to a height of 16 in (405 mm) from its bottom edge and be centered across the width of the door.

A4.13.10 Door Closers. Closers with delayed action features give a person more time to maneuver through doorways. They are particularly useful on frequently used interior doors such as entrances to toilet rooms.

A4.13.11 Door Opening Force. Although most people with disabilities can exert at least 5 lbf (22.2N), both pushing and pulling from a stationary position, a few people with severe disabilities cannot exert 3 lbf (13.13N). Although some people cannot manage the allowable forces in this guideline and many others have difficulty, door closers must have certain minimum closing forces to close doors satisfactorily. Forces for pushing or pulling doors open are measured with a push-pull scale under the following conditions:

(1) Hinged doors: Force applied perpendicular to the door at the door opener or 30 in (760 mm) from the hinged side, whichever is farther from the hinge.

(2) Sliding or folding doors: Force applied parallel to the door at the door pull or latch.

(3) Application of force: Apply force gradually so that the applied force does not exceed the resistance of the door. In high-rise buildings, air-pressure differentials may require a modification of this specification in order to meet the functional intent.

A4.15 Drinking Fountains and Water Coolers

A4.13.12 Automatic Doors and Power-Assisted Doors. Sliding automatic doors do not need guard rails and are more convenient for wheelchair users and visually impaired people to use. If slowly opening automatic doors can be reactivated before their closing cycle is completed, they will be more convenient in busy doorways.

A4.15 Drinking Fountains and Water Coolers.

A4.15.2 Spout Height. Two drinking fountains, mounted side by side or on a single post, are usable by people with disabilities and people who find it difficult to bend over.

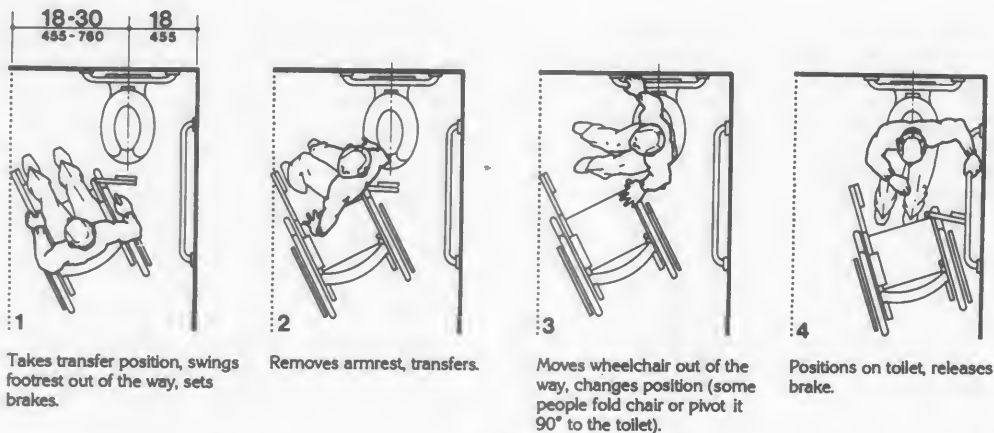

(a) Diagonal Approach

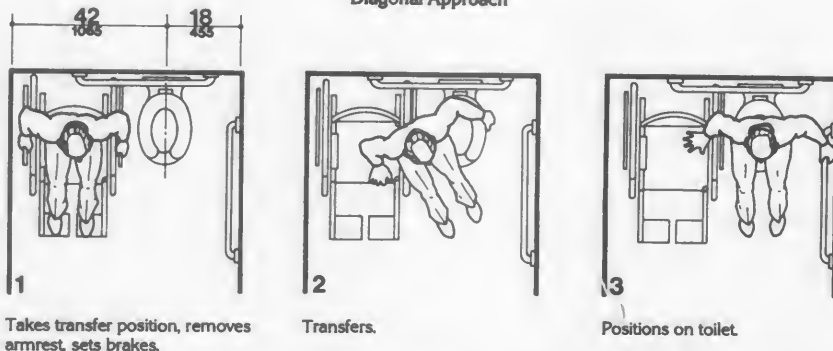

(b) Side Approach

**Fig. A6
Wheelchair Transfers**

A4.16 Water Closets

A4.16 Water Closets.

A4.16.3 Height. Height preferences for toilet seats vary considerably among disabled people. Higher seat heights may be an advantage to some ambulatory disabled people, but are often a disadvantage for wheelchair users and others. Toilet seats 18 in (455 mm) high seem to be a reasonable compromise. Thick seats and filler rings are available to adapt standard fixtures to these requirements.

A4.16.4 Grab Bars. Fig. A6(a) and (b) show the diagonal and side approaches most commonly used to transfer from a wheelchair to a water closet. Some wheelchair users can transfer from the front of the toilet while others use a 90-degree approach. Most people who use the two additional approaches can also use either the diagonal approach or the side approach.

A4.16.5 Flush Controls. Flush valves and related plumbing can be located behind walls or to the side of the toilet, or a toilet seat lid can be provided if plumbing fittings are directly behind the toilet seat. Such designs reduce the chance of injury and imbalance caused by leaning back against the fittings. Flush controls for tank-type toilets have a standardized mounting location on the left side of the tank (facing the tank). Tanks can be obtained by special order with controls mounted on the right side. If administrative authorities require flush controls for flush valves to be located in a position that conflicts with the location of the rear grab bar, then that bar may be split or shifted toward the wide side of the toilet area.

A4.17 Toilet Stalls.

A4.17.3 Size and Arrangement. This section requires use of the 60 in (1525 mm) standard stall (Figure 30(a)) and permits the 36 in (915 mm) or 48 in (1220 mm) wide alternate stall (Figure 30(b)) only in alterations where provision of the standard stall is technically infeasible or where local plumbing codes prohibit reduction in the number of fixtures. A standard stall provides a clear space on one side of the water closet to enable persons who use wheelchairs to perform a side or diagonal transfer from the wheelchair to the water closet. However, some persons with disabilities who use mobility aids such as walkers, canes or crutches

are better able to use the two parallel grab bars in the 36 in (915 mm) wide alternate stall to achieve a standing position.

In large toilet rooms, where six or more toilet stalls are provided, it is therefore required that a 36 in (915 mm) wide stall with parallel grab bars be provided in addition to the standard stall required in new construction. The 36 in (915 mm) width is necessary to achieve proper use of the grab bars; wider stalls would position the grab bars too far apart to be easily used and narrower stalls would position the grab bars too close to the water closet. Since the stall is primarily intended for use by persons using canes, crutches and walkers, rather than wheelchairs, the length of the stall could be conventional. The door, however, must swing outward to ensure a usable space for people who use crutches or walkers.

A4.17.5 Doors. To make it easier for wheelchair users to close toilet stall doors, doors can be provided with closers, spring hinges, or a pull bar mounted on the inside surface of the door near the hinge side.

A4.19 Lavatories and Mirrors.

A4.19.6 Mirrors. If mirrors are to be used by both ambulatory people and wheelchair users, then they must be at least 74 in (1880 mm) high at their topmost edge. A single full length mirror can accommodate all people, including children.

A4.21 Shower Stalls.

A4.21.1 General. Shower stalls that are 36 in by 36 in (915 mm by 915 mm) wide provide additional safety to people who have difficulty maintaining balance because all grab bars and walls are within easy reach. Seated people use the walls of 36 in by 36 in (915 mm by 915 mm) showers for back support. Shower stalls that are 60 in (1525 mm) wide and have no curb may increase usability of a bathroom by wheelchair users because the shower area provides additional maneuvering space.

A4.22 Toilet Rooms.

A4.22.3 Clear Floor Space. In many small facilities, single-user restrooms may be the only

A4.22 Toilet Rooms

facilities provided for all building users. In addition, the guidelines allow the use of "unisex" or "family" accessible toilet rooms in alterations when technical feasibility can be demonstrated. Experience has shown that the provision of accessible "unisex" or single-user restrooms is a reasonable way to provide access for wheelchair users and any attendants, especially when attendants are of the opposite sex. Since these facilities have proven so useful, it is often considered advantageous to install a "unisex" toilet room in new facilities in addition to making the multi-stall restrooms accessible, especially in shopping malls, large auditoriums, and convention centers.

Figure 28 (section 4.16) provides minimum clear floor space dimensions for toilets in accessible "unisex" toilet rooms. The dotted lines designate the minimum clear floor space, depending on the direction of approach, required for wheelchair users to transfer onto the water closet. The dimensions of 48 in (1220 mm) and 60 in (1525 mm), respectively, correspond to the space required for the two common transfer approaches utilized by wheelchair users (see Fig. A6). It is important to keep in mind that the placement of the lavatory to the immediate side of the water closet will preclude the side approach transfer illustrated in Figure A6(b).

To accommodate the side transfer, the space adjacent to the water closet must remain clear of obstruction for 42 in (1065 mm) from the centerline of the toilet (Figure 28) and the lavatory must not be located within this clear space. A turning circle or T-turn, the clear floor space at the lavatory, and maneuvering space at the door must be considered when determining the possible wall locations. A privacy latch or other accessible means of ensuring privacy during use should be provided at the door.

RECOMMENDATIONS:

1. In new construction, accessible single-user restrooms may be desirable in some situations because they can accommodate a wide variety of building users. However, they cannot be used in lieu of making the multi-stall toilet rooms accessible as required.
2. Where strict compliance to the guidelines for accessible toilet facilities is technically feasible in the alteration of existing facilities, accessible "unisex" toilets are a reasonable alternative.
3. In designing accessible single-user restrooms, the provisions of adequate space to allow a side transfer will provide accommodation to the largest number of wheelchair users.

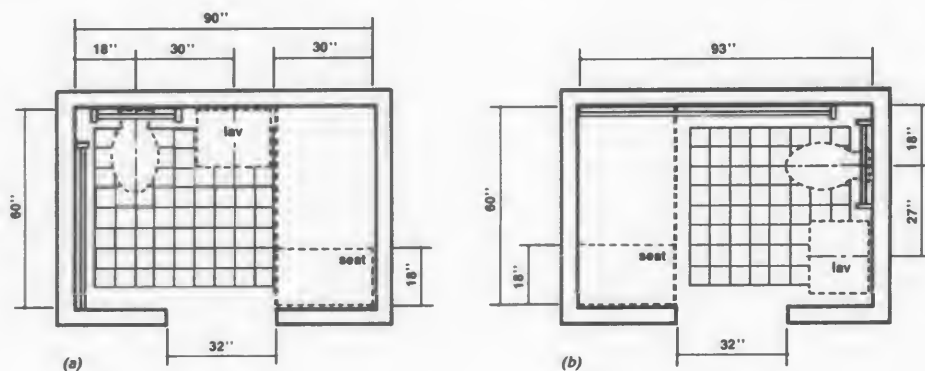

Fig. A7

A4.23 Bathrooms, Bathing Facilities, and Shower Rooms

A4.23 Bathrooms, Bathing Facilities, and Shower Rooms.

A4.23.3 Clear Floor Space. Figure A7 shows two possible configurations of a toilet room with a roll-in shower. The specific shower shown is designed to fit exactly within the dimensions of a standard bathtub. Since the shower does not have a lip, the floor space can be used for required maneuvering space. This would permit a toilet room to be smaller than would be permitted with a bathtub and still provide enough floor space to be considered accessible. This design can provide accessibility in facilities where space is at a premium (i.e., hotels and medical care facilities). The alternate roll-in shower (Fig. 57b) also provides sufficient room for the "T-turn" and does not require plumbing to be on more than one wall.

A4.23.9 Medicine Cabinets. Other alternatives for storing medical and personal care items are very useful to disabled people. Shelves, drawers, and floor-mounted cabinets can be provided within the reach ranges of disabled people.

A4.26 Handrails, Grab Bars, and Tub and Shower Seats.

A4.26.1 General. Many disabled people rely heavily upon grab bars and handrails to maintain balance and prevent serious falls. Many people brace their forearms between supports and walls to give them more leverage and stability in maintaining balance or for lifting. The grab bar clearance of 1-1/2 in (38 mm) required in this guideline is a safety clearance to prevent injuries resulting from arms slipping through the openings. It also provides adequate gripping room.

A4.26.2 Size and Spacing of Grab Bars and Handrails. This specification allows for alternate shapes of handrails as long as they allow an opposing grip similar to that provided by a circular section of 1-1/4 in to 1-1/2 in (32 mm to 38 mm).

A4.27 Controls and Operating Mechanisms.

A4.27.3 Height. Fig. A8 further illustrates

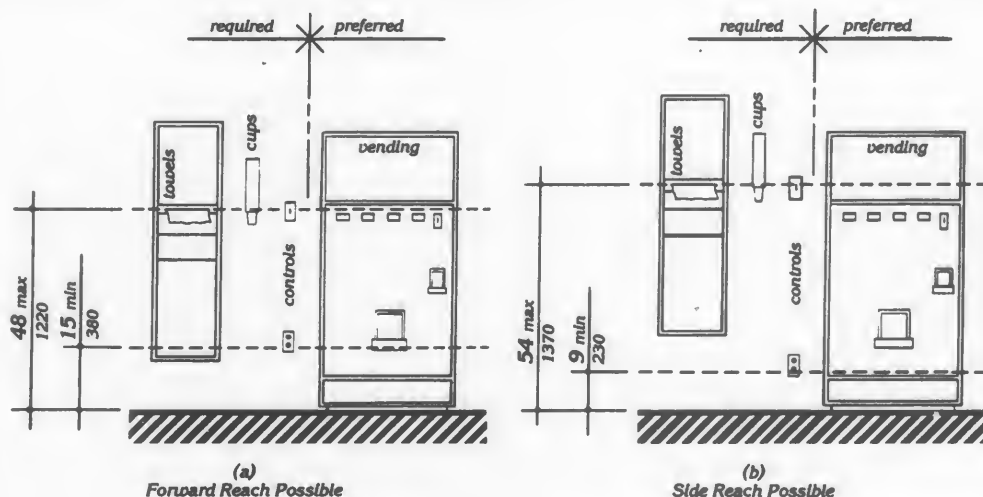

Fig. A8
Control Reach Limitations

A4.28 Alarms

mandatory and advisory control mounting height provisions for typical equipment.

Electrical receptacles installed to serve individual appliances and not intended for regular or frequent use by building occupants are not required to be mounted within the specified reach ranges. Examples would be receptacles installed specifically for wall-mounted clocks, refrigerators, and microwave ovens.

A4.28 Alarms.

A4.28.2 Audible Alarms. Audible emergency signals must have an intensity and frequency that can attract the attention of individuals who have partial hearing loss. People over 60 years of age generally have difficulty perceiving frequencies higher than 10,000 Hz. An alarm signal which has a periodic element to its signal, such as single stroke bells (clang-pause-clang-pause), hi-low (up-down-up-down) and fast whoop (on-off-on-off) are best. Avoid continuous or reverberating tones. Select a signal which has a sound characterized by three or four clear tones without a great deal of "noise" in between.

A4.28.3 Visual Alarms. The specifications in this section do not preclude the use of zoned or coded alarm systems.

A4.28.4 Auxiliary Alarms. Locating visual emergency alarms in rooms where persons who are deaf may work or reside alone can ensure that they will always be warned when an emergency alarm is activated. To be effective, such devices must be located and oriented so that they will spread signals and reflections throughout a space or raise the overall light level sharply. However, visual alarms alone are not necessarily the best means to alert sleepers. A study conducted by Underwriters Laboratory (UL) concluded that a flashing light more than seven times brighter was required (110 candela v. 15 candela, at the same distance) to awaken sleepers as was needed to alert awake subjects in a normal daytime illuminated room.

For hotel and other rooms where people are likely to be asleep, a signal-activated vibrator placed between mattress and box spring or under a pillow was found by UL to be much more effective in alerting sleepers. Many readily available devices are sound-activated so that they could respond to an alarm clock, clock

radio, wake-up telephone call or room smoke detector. Activation by a building alarm system can either be accomplished by a separate circuit activating an auditory alarm which would, in turn, trigger the vibrator or by a signal transmitted through the ordinary 110-volt outlet. Transmission of signals through the power line is relatively simple and is the basis of common, inexpensive remote light control systems sold in many department and electronic stores for home use. So-called "wireless" intercoms operate on the same principal.

A4.29 Detectable Warnings.

A4.29.2 Detectable Warnings on Walking Surfaces. The material used to provide contrast should contrast by at least 70%. Contrast in percent is determined by:

$$\text{Contrast} = [(B_1 - B_2) / B_1] \times 100$$

where B_1 = light reflectance value (LRV) of the lighter area
and B_2 = light reflectance value (LRV) of the darker area.

Note that in any application both white and black are never absolute; thus, B_1 never equals 100 and B_2 is always greater than 0.

A4.30 Signage.

A4.30.1 General. In building complexes where finding locations independently on a routine basis may be a necessity (for example, college campuses), tactile maps or prerecorded instructions can be very helpful to visually impaired people. Several maps and auditory instructions have been developed and tested for specific applications. The type of map or instructions used must be based on the information to be communicated, which depends highly on the type of buildings or users.

Landmarks that can easily be distinguished by visually impaired individuals are useful as orientation cues. Such cues include changes in illumination level, bright colors, unique patterns, wall murals, location of special equipment or other architectural features.

Many people with disabilities have limitations in movement of their heads and reduced peripheral vision. Thus, signage positioned

A4.30 Signage

perpendicular to the path of travel is easiest for them to notice. People can generally distinguish signage within an angle of 30 degrees to either side of the centerlines of their faces without moving their heads.

A4.30.2 Character Proportion. The legibility of printed characters is a function of the viewing distance, character height, the ratio of the stroke width to the height of the character, the contrast of color between character and background, and print font. The size of characters must be based upon the intended viewing distance. A severely nearsighted person may have to be much closer to recognize a character of a given size than a person with normal visual acuity.

A4.30.4 Raised and Brailled Characters and Pictorial Symbol Signs (Pictograms). The standard dimensions for literary Braille are as follows:

| | |
|-------------------------------------|----------|
| Dot diameter | .059 in. |
| Inter-dot spacing | .090 in. |
| Horizontal separation between cells | .241 in. |
| Vertical separation between cells | .395 in. |

Raised borders around signs containing raised characters may make them confusing to read unless the border is set far away from the characters. Accessible signage with descriptive materials about public buildings, monuments, and objects of cultural interest may not provide sufficiently detailed and meaningful information. Interpretive guides, audio tape devices, or other methods may be more effective in presenting such information.

A4.30.5 Finish and Contrast. An eggshell finish (11 to 19 degree gloss on 60 degree glossimeter) is recommended. Research indicates that signs are more legible for persons with low vision when characters contrast with their background by at least 70 percent. Contrast in percent shall be determined by:

$$\text{Contrast} = [(B_1 - B_2) / B_1] \times 100$$

where B_1 = light reflectance value (LRV) of the lighter area
and B_2 = light reflectance value (LRV) of the darker area.

Note that in any application both white and black are never absolute; thus, B_1 never equals 100 and B_2 is always greater than 0.

The greatest readability is usually achieved through the use of light-colored characters or symbols on a dark background.

A4.30.7 Symbols of Accessibility for Different Types of Listening Systems. Paragraph 4 of this section requires signage indicating the availability of an assistive listening system. An appropriate message should be displayed with the international symbol of access for hearing loss since this symbol conveys general accessibility for people with hearing loss. Some suggestions are:

INFRARED
ASSISTIVE LISTENING SYSTEM
AVAILABLE
—PLEASE ASK—

AUDIO LOOP IN USE
TURN T-SWITCH FOR
BETTER HEARING
—OR ASK FOR HELP—

FM
ASSISTIVE LISTENING
SYSTEM AVAILABLE
—PLEASE ASK—

The symbol may be used to notify persons of the availability of other auxiliary aids and services such as: real time captioning, captioned note taking, sign language interpreters, and oral interpreters.

A4.30.8 Illumination Levels. Illumination levels on the sign surface shall be in the 100 to 300 lux range (10 to 30 footcandles) and shall be uniform over the sign surface. Signs shall be located such that the illumination level on the surface of the sign is not significantly exceeded by the ambient light or visible bright lighting source behind or in front of the sign.

A4.31 Telephones

A4.31 Telephones.

A4.31.3 Mounting Height. In localities where the dial-tone first system is in operation, calls can be placed at a coin telephone through the operator without inserting coins. The operator button is located at a height of 46 in (1170 mm) if the coin slot of the telephone is at 54 in (1370 mm). A generally available public telephone with a coin slot mounted lower on the equipment would allow universal installation of telephones at a height of 48 in (1220 mm) or less to all operable parts.

A4.31.9 Text Telephones. A public text telephone may be an integrated text telephone pay phone unit or a conventional portable text telephone that is permanently affixed within, or adjacent to, the telephone enclosure. In order to be usable with a pay phone, a text telephone which is not a single integrated text telephone pay phone unit will require a shelf large enough (10 in (255mm) wide by 10 in (255 mm) deep with a 6 in (150 mm) vertical clearance minimum) to accommodate the device, an electrical outlet, and a power cord. Movable or portable text telephones may be used to provide equivalent facilitation. A text telephone should be readily available so that a person using it may access the text telephone easily and conveniently. As currently designed pocket-type text telephones for personal use do not accommodate a wide range of users. Such devices would not be considered substantially equivalent to conventional text telephones. However, in the future as technology develops this could change.

A4.32 Fixed or Built-in Seating and Tables.

A4.32.4 Height of Tables or Counters. Different types of work require different table or counter heights for comfort and optimal performance. Light detailed work such as writing requires a table or counter close to elbow height for a standing person. Heavy manual work such as rolling dough requires a counter or table height about 10 in (255 mm) below elbow height for a standing person. This principle of high/low table or counter heights also applies for seated persons; however, the limiting condition for seated manual work is clearance under the table or counter.

Table A1 shows convenient counter heights for seated persons. The great variety of heights for comfort and optimal performance indicates a need for alternatives or a compromise in height if people who stand and people who sit will be using the same counter area.

Table A1
Convenient Heights of Tables
and Counters for Seated People¹

| Conditions of Use | Short Women in mm | Tall Men in mm |
|---|----------------------|---------------------|
| Seated in a wheelchair: | | |
| Manual work— | | |
| Desk or removeable armrests | 26 660 | 30 760 |
| Fixed, full-size armrests ² | 32 ³ 815 | 32 ³ 815 |
| Light detailed work: | | |
| Desk or removable armrests | 29 735 | 34 865 |
| Fixed, full-size armrests ² | 32 ³ 815 | 34 865 |
| Seated in a 16-in. (405-mm) High chair: | | |
| Manual work | 26 660 | 27 685 |
| Light detailed work | 28 710 | 31 785 |

¹All dimensions are based on a work-surface thickness of 1 1/2 in (38 mm) and a clearance of 1 1/2 in (38 mm) between legs and the underside of a work surface.

²This type of wheelchair arm does not interfere with the positioning of a wheelchair under a work surface.

³This dimension is limited by the height of the armrests: a lower height would be preferable. Some people in this group prefer lower work surfaces, which require positioning the wheelchair back from the edge of the counter.

A4.33 Assembly Areas.

A4.33.2 Size of Wheelchair Locations. Spaces large enough for two wheelchairs allow people who are coming to a performance together to sit together.

A4.33.3 Placement of Wheelchair Locations. The location of wheelchair areas can be planned so that a variety of positions

Table A2. Summary of Assistive Listening Devices

| | |
|---|--|
| <p>within the seating area are provided. This will allow choice in viewing and price categories.</p> <p><i>Building/life safety codes set minimum distances between rows of fixed seats with consideration of the number of seats in a row, the exit aisle width and arrangement, and the location of exit doors. "Continental" seating, with a greater number of seats per row and a</i></p> | <p><i>commensurate increase in row spacing and exit doors, facilitates emergency egress for all people and increases ease of access to mid-row seats especially for people who walk with difficulty. Consideration of this positive attribute of "continental" seating should be included along with all other factors in the design of fixed seating areas.</i></p> |
|---|--|

Table A2. Summary of Assistive Listening Devices

| System | Advantages | Disadvantages | Typical Applications |
|--|---|--|--|
| <p>Induction Loop Transmitter: Transducer wired to induction loop around listening area. Receiver: Self-contained induction receiver or personal hearing aid with telecoil.</p> | <p>Cost-Effective Low Maintenance Easy to use Unobtrusive May be possible to integrate into existing public address system. Some hearing aids can function as receivers.</p> | <p>Signal spills over to adjacent rooms. Susceptible to electrical interference. Limited portability Inconsistent signal strength. Head position affects signal strength. Lack of standards for induction coil performance.</p> | <p>Meeting areas Theaters Churches and Temples Conference rooms Classrooms TV viewing</p> |
| <p>FM Transmitter: Flashlight-sized worn by speaker. Receiver: With personal hearing aid via DAI or induction neck-loop and telecoil; or self-contained with earphone(s).</p> | <p>Highly portable Different channels allow use by different groups within the same room. High user mobility Variable for large range of hearing losses.</p> | <p>High cost of receivers Equipment fragile Equipment obtrusive High maintenance Expensive to maintain Custom fitting to individual user may be required.</p> | <p>Classrooms Tour groups Meeting areas Outdoor events One-on-one</p> |
| <p>Infrared Transmitter: Emitter in line-of-sight with receiver. Receiver: Self-contained. Or with personal hearing aid via DAI or induction neckloop and telecoil.</p> | <p>Easy to use Insures privacy or confidentiality Moderate cost Can often be integrated into existing public address system.</p> | <p>Line-of-sight required between emitter and receiver. Ineffective outdoors Limited portability Requires installation</p> | <p>Theaters Churches and Temples Auditoriums Meetings requiring confidentiality TV viewing</p> |

Source: Rehab Brief, National Institute on Disability and Rehabilitation Research, Washington, DC, Vol. XII, No. 10, (1990).

A5.0 Restaurants and Cafeterias**A4.33.6 Placement of Listening**

Systems. A distance of 50 ft (15 m) allows a person to distinguish performers' facial expressions.

A4.33.7 Types of Listening Systems. An assistive listening system appropriate for an assembly area for a group of persons or where the specific individuals are not known in advance, such as a playhouse, lecture hall or movie theater, may be different from the system appropriate for a particular individual provided as an auxiliary aid or as part of a reasonable accommodation. The appropriate device for an individual is the type that individual can use, whereas the appropriate system for an assembly area will necessarily be geared toward the "average" or aggregate needs of various individuals. A listening system that can be used from any seat in a seating area is the most flexible way to meet this specification. Ear-phone jacks with variable volume controls can benefit only people who have slight hearing loss and do not help people who use hearing aids. At the present time, magnetic induction loops are the most feasible type of listening system for people who use hearing aids equipped with "T-coils," but people without hearing aids or those with hearing aids not equipped with inductive pick-ups cannot use them without special receivers. Radio frequency systems can be extremely effective and inexpensive. People without hearing aids can use them, but people with hearing aids need a special receiver to use them as they are presently designed. If hearing aids had a jack to allow a by-pass of microphones, then radio frequency systems would be suitable for people with and without hearing aids. Some listening systems may be subject to interference from other equipment and feedback from hearing aids of people who are using the systems. Such interference can be controlled by careful engineering design that anticipates feedback sources in the surrounding area.

Table A2, reprinted from a National Institute of Disability and Rehabilitation Research "Rehab Brief," shows some of the advantages and

disadvantages of different types of assistive listening systems. In addition, the Architectural and Transportation Barriers Compliance Board (Access Board) has published a pamphlet on Assistive Listening Systems which lists demonstration centers across the country where technical assistance can be obtained in selecting and installing appropriate systems. The state of New York has also adopted a detailed technical specification which may be useful.

A5.0 Restaurants and Cafeterias.

A5.1 General. Dining counters (where there is no service) are typically found in small carry-out restaurants, bakeries, or coffee shops and may only be a narrow eating surface attached to a wall. This section requires that where such a dining counter is provided, a portion of the counter shall be at the required accessible height.

A7.0 Business and Mercantile.**A7.2(3) Assistive Listening Devices.**

At all sales and service counters, teller windows, box offices, and information kiosks where a physical barrier separates service personnel and customers, it is recommended that at least one permanently installed assistive listening device complying with 4.33 be provided at each location or series. Where assistive listening devices are installed, signage should be provided identifying those stations which are so equipped.

A7.3 Check-out Aisles. Section 7.2 refers to counters without aisles; section 7.3 concerns check-out aisles. A counter without an aisle (7.2) can be approached from more than one direction such as in a convenience store. In order to use a check-out aisle (7.3), customers must enter a defined area (an aisle) at a particular point, pay for goods, and exit at a particular point.

Appendix B to Part 36—Preamble to Regulation on Nondiscrimination on the Basis of Disability by Public Accommodations and in Commercial Facilities (Published July 26, 1991)

Note: For the convenience of the reader, this appendix contains the text of the

preamble to the final regulation on nondiscrimination on the basis of disability by public accommodations and in commercial facilities beginning at the heading "Section-by-Section Analysis and Response to Comments" and ending before "List of Subjects in 28 CFR part 36" (56 FR

July 26, 1991).

Dated: July 17, 1991.

Dick Thornburgh,
Attorney General.

[FR Doc. 91-17482 Filed 7-25-91; 8:45 am]

BILLING CODE 4410-01-M

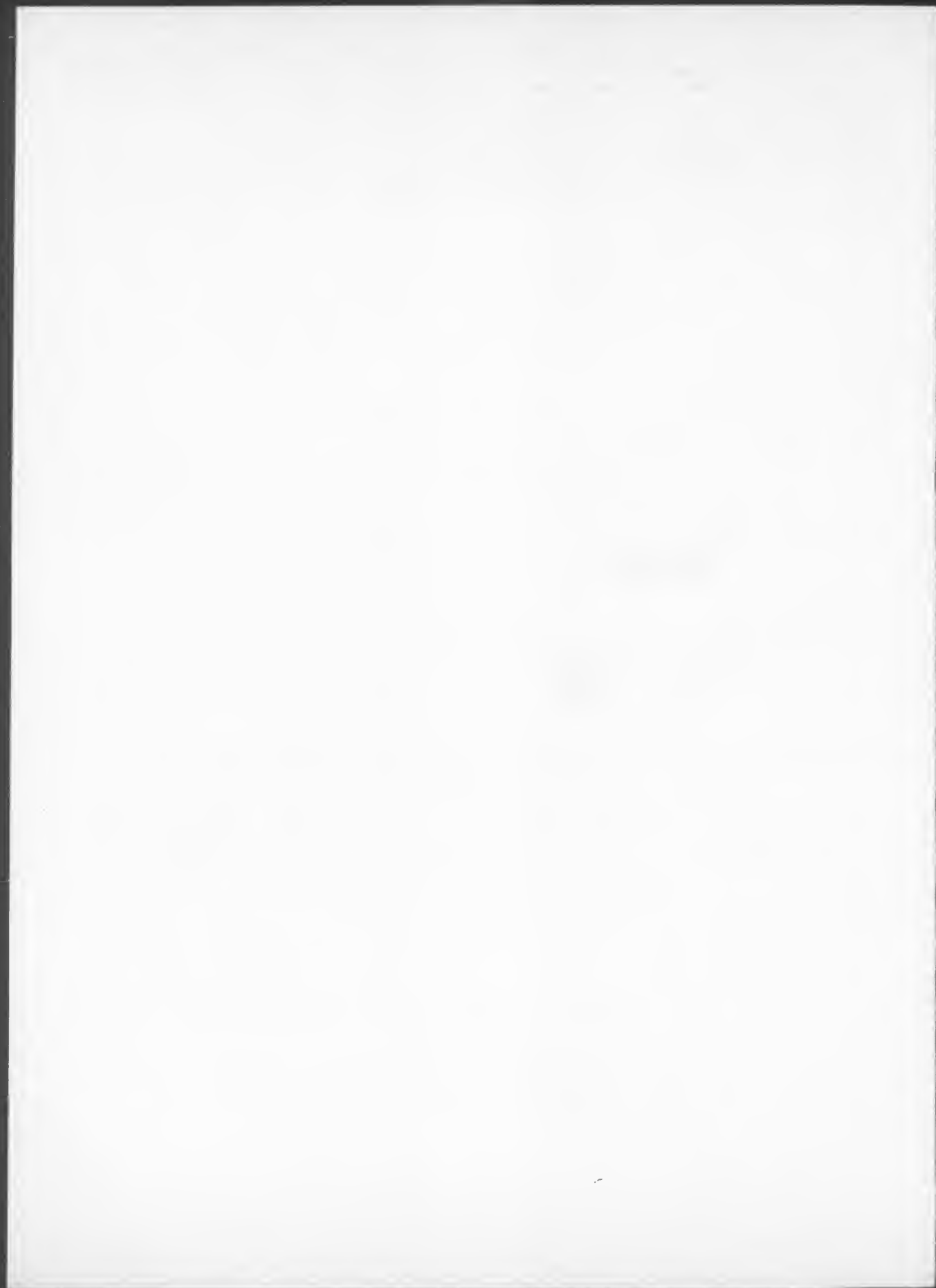

federal register

**Friday
July 26, 1991**

Part IV

**Department of
Justice**

Office of the Attorney General

28 CFR Part 35

**Nondiscrimination on the Basis of
Disability in State and Local Government
Services; Final Rule**

DEPARTMENT OF JUSTICE**28 CFR Part 35****[Order No. 1512-91]****Nondiscrimination on the Basis of Disability in State and Local Government Services****AGENCY:** Department of Justice.**ACTION:** Final rule.

SUMMARY: This rule implements subtitle A of title II of the Americans with Disabilities Act, Public Law 101-336, which prohibits discrimination on the basis of disability by public entities. Subtitle A protects qualified individuals with disabilities from discrimination on the basis of disability in the services, programs, or activities of all State and local governments. It extends the prohibition of discrimination in federally assisted programs established by section 504 of the Rehabilitation Act of 1973 to all activities of State and local governments, including those that do not receive Federal financial assistance, and incorporates specific prohibitions of discrimination on the basis of disability from titles I, III, and V of the Americans with Disabilities Act. This rule, therefore, adopts the general prohibitions of discrimination established under section 504, as well as the requirements for making programs accessible to individuals with disabilities and for providing equally effective communications. It also sets forth standards for what constitutes discrimination on the basis of mental or physical disability, provides a definition of disability and qualified individual with a disability, and establishes a complaint mechanism for resolving allegations of discrimination.

EFFECTIVE DATE: January 26, 1992.

FOR FURTHER INFORMATION CONTACT: Barbara S. Drake, Deputy Assistant Attorney General, Civil Rights Division; Stewart B. Oneglia, Chief, Coordination and Review Section, Civil Rights Division; John L. Wodatch, Director, Office on the Americans with Disabilities Act, Civil Rights Division; all of the U.S. Department of Justice, Washington, DC 20530. These individuals may be contacted through the Division's ADA Information Line at (202) 514-0301 (Voice), (202) 514-0381 (TDD), or (202) 514-0383 (TDD). These telephone numbers are not toll-free numbers.

SUPPLEMENTARY INFORMATION:**Background**

The landmark Americans with Disabilities Act ("ADA" or "the Act"),

enacted on July 26, 1990, provides comprehensive civil rights protections to individuals with disabilities in the areas of employment, public accommodations, State and local government services, and telecommunications.

This regulation implements subtitle A of title II of the ADA, which applies to State and local governments. Most programs and activities of State and local governments are recipients of Federal financial assistance from one or more Federal funding agencies and, therefore, are already covered by section 504 of the Rehabilitation Act of 1973, as amended (29 U.S.C. 794) ("section 504"), which prohibits discrimination on the basis of handicap in federally assisted programs and activities. Because title II of the ADA essentially extends the nondiscrimination mandate of section 504 to those State and local governments that do not receive Federal financial assistance, this rule hews closely to the provisions of existing section 504 regulations. This approach is also based on section 204 of the ADA, which provides that the regulations issued by the Attorney General to implement title II shall be consistent with the ADA and with the Department of Health, Education, and Welfare's coordination regulation, now codified at 28 CFR part 41, and, with respect to "program accessibility, existing facilities," and "communications," with the Department of Justice's regulation for its federally conducted programs and activities, codified at 28 CFR part 39.

The first regulation implementing section 504 was issued in 1977 by the Department of Health, Education, and Welfare (HEW) for the programs and activities to which it provided Federal financial assistance. The following year, pursuant to Executive Order 11914, HEW issued its coordination regulation for federally assisted programs, which served as the model for regulations issued by the other Federal agencies that administer grant programs. HEW's coordination authority, and the coordination regulation issued under that authority, were transferred to the Department of Justice by Executive Order 12250 in 1980.

In 1978, Congress extended application of section 504 to programs and activities conducted by Federal Executive agencies and the United States Postal Service. Pursuant to Executive Order 12250, the Department of Justice developed a prototype regulation to implement the 1978 amendment for federally conducted programs and activities. More than 80 Federal agencies have now issued final regulations based on that prototype,

prohibiting discrimination based on handicap in the programs and activities they conduct.

Despite the large number of regulations implementing section 504 for federally assisted and federally conducted programs and activities, there is very little variation in their substantive requirements, or even in their language. Major portions of this regulation, therefore, are taken directly from the existing regulations.

In addition, section 204(b) of the ADA requires that the Department's regulation implementing subtitle A of title II be consistent with the ADA. Thus, the Department's final regulation includes provisions and concepts from titles I and III of the ADA.

Rulemaking History

On February 22, 1991, the Department of Justice published a notice of proposed rulemaking (NPRM) implementing title III of the ADA in the *Federal Register*, 56 FR 7452. On February 28, 1991, the Department published a notice of proposed rulemaking implementing subtitle A of title II of the ADA in the *Federal Register*, 56 FR 8538. Each NPRM solicited comments on the definitions, standards, and procedures of the proposed rules. By the April 29, 1991, close of the comment period of the NPRM for title II, the Department had received 2,718 comments. Following the close of the comment period, the Department received an additional 222 comments.

In order to encourage public participation in the development of the Department's rules under the ADA, the Department held four public hearings. Hearings were held in Dallas, Texas on March 4-5, 1991, in Washington, DC on March 13-15, 1991, in San Francisco, California on March 18-19, 1991, and in Chicago, Illinois on March 27-28, 1991. At these hearings, 329 persons testified and 1,567 pages of testimony were compiled. Transcripts of the hearings were included in the Department's rulemaking docket.

The comments that the Department received occupy almost six feet of shelf space and contain over 10,000 pages. The Department received comments from individuals from all fifty States and the District of Columbia. Nearly 75% of the comments that the Department received came from individuals and from organizations representing the interests of persons with disabilities. The Department received 292 comments from entities covered by the ADA and trade associations representing businesses in the private sector, and 67 from government units, such as mayors'

offices, public school districts, and various State agencies working with individuals with disabilities.

The Department received one comment from a consortium of 540 organizations representing a broad spectrum of persons with disabilities. In addition, at least another 25 commenters endorsed the position expressed by this consortium, or submitted identical comments on one or both proposed regulations.

An organization representing persons with hearing impairments submitted a large number of comments. This organization presented the Department with 479 individual comments, each providing in chart form a detailed representation of what type of auxiliary aid or service would be useful in the various categories of places of public accommodation.

The Department received a number of comments based on almost ten different form letters. For example, individuals who have a heightened sensitivity to a variety of chemical substances submitted 268 post cards detailing how exposure to various environmental conditions restricts their access to public and commercial buildings. Another large group of form letters came from groups affiliated with independent living centers.

The vast majority of the comments addressed the Department's proposal implementing title III. Slightly more than 100 comments addressed only issues presented in the proposed title II regulation.

The Department read and analyzed each comment that was submitted in a timely fashion. Transcripts of the four hearings were analyzed along with the written comments. The decisions that the Department has made in response to these comments, however, were not made on the basis of the number of commenters addressing any one point but on a thorough consideration of the merits of the points of view expressed in the comments. Copies of the written comments, including transcripts of the four hearings, will remain available for public inspection in room 854 of the HOLC Building, 320 First Street, NW., Washington, DC from 10 a.m. to 5 p.m., Monday through Friday, except for legal holidays, until August 30, 1991.

Overview of the Rule

The rule is organized into seven subparts. Subpart A, "General," includes the purpose and application sections, describes the relationship of the Act to other laws, and defines key terms used in the regulation. It also includes administrative requirements adapted from section 504 regulations for

self-evaluations, notices, designation of responsible employees, and adoption of grievance procedures by public entities.

Subpart B, "General Requirements," contains the general prohibitions of discrimination based on the Act and the section 504 regulations. It also contains certain "miscellaneous" provisions derived from title V of the Act that involve issues such as retaliation and coercion against those asserting ADA rights, illegal use of drugs, and restrictions on smoking. These provisions are also included in the Department's proposed title III regulation, as is the general provision on maintenance of accessible features.

Subpart C addresses employment by public entities, which is also covered by title I of the Act. Subpart D, which is also based on the section 504 regulations, sets out the requirements for program accessibility in existing facilities and for new construction and alterations. Subpart E contains specific requirements relating to communications.

Subpart F establishes administrative procedures for enforcement of title II. As provided by section 203 of the Act, these are based on the procedures for enforcement of section 504, which, in turn, are based on the enforcement procedures for title VI of the Civil Rights Act of 1964 (42 U.S.C. 2000d to 2000d-4a). Subpart F also restates the provisions of title V of the ADA on attorneys fees, alternative means of dispute resolution, the effect of unavailability of technical assistance, and State immunity.

Subpart G designates the Federal agencies responsible for investigation of complaints under this part. It assigns enforcement responsibility for particular public entities, on the basis of their major functions, to eight Federal agencies that currently have substantial responsibilities for enforcing section 504. It provides that the Department of Justice would have enforcement responsibility for all State and local government entities not specifically assigned to other designated agencies, but that the Department may further assign specific functions to other agencies. The part would not, however, displace the existing enforcement authorities of the Federal funding agencies under section 504.

Regulatory Process Matters

This final rule has been reviewed by the Office of Management and Budget under Executive Order 12291. The Department is preparing a final regulatory impact analysis (RIA) of this rule and the Architectural and Transportation Barriers Compliance

Board is preparing an RIA for its Americans with Disabilities Act Accessibility Guidelines for Buildings and Facilities (ADAAG) that are incorporated in appendix A of the Department's final rule implementing title III of the ADA. Draft copies of both preliminary RIAs are available for comment; the Department will provide copies of these documents to the public upon request. Commenters are urged to provide additional information as to the costs and benefits associated with this rule. This will facilitate the development of a final RIA by January 1, 1992.

The Department's RIA will evaluate the economic impact of the final rule. Included among those title II provisions that are likely to result in significant economic impact are the requirements for auxiliary aids, barrier removal in existing facilities, and readily accessible new construction and alterations. An analysis of these costs will be included in the RIA.

The Preliminary RIA prepared for the notice of proposed rulemaking contained all of the available information that would have been included in a preliminary regulatory flexibility analysis, had one been prepared under the Regulatory Flexibility Act, concerning the rule's impact on small entities. The final RIA will contain all of the information that is required in a final regulatory flexibility analysis and will serve as such an analysis. Moreover, the extensive notice and comment procedure followed by the Department in the promulgation of this rule, which included public hearings, dissemination of materials, and provision of speakers to affected groups, clearly provided any interested small entities with the notice and opportunity for comment provided for under the Regulatory Flexibility Act procedures.

The Department is preparing a statement of the federalism impact of the rule under Executive Order 12612 and will provide copies of this statement on request.

The reporting and recordkeeping requirements described in the rule are considered to be information collection requirements as that term is defined by the Office of Management and Budget in 5 CFR part 1320. Accordingly, those information collection requirements have been submitted to OMB for review pursuant to the Paperwork Reduction Act.

Section-by-Section Analysis

Subpart A—General

Section 35.101 Purpose

Section 35.101 states the purpose of the rule, which is to effectuate subtitle A of title II of the Americans with Disabilities Act of 1990 (the Act), which prohibits discrimination on the basis of disability by public entities. This part does not, however, apply to matters within the scope of the authority of the Secretary of Transportation under subtitle B of title II of the Act.

Section 35.102 Application

This provision specifies that, except as provided in paragraph (b), the regulation applies to all services, programs, and activities provided or made available by public entities, as that term is defined in § 35.104. Section 504 of the Rehabilitation Act of 1973 (29 U.S.C. 794), which prohibits discrimination on the basis of handicap in federally assisted programs and activities, already covers those programs and activities of public entities that receive Federal financial assistance. Title II of the ADA extends this prohibition of discrimination to include all services, programs, and activities provided or made available by State and local governments or any of their instrumentalities or agencies, regardless of the receipt of Federal financial assistance. Except as provided in § 35.134, this part does not apply to private entities.

The scope of title II's coverage of public entities is comparable to the coverage of Federal Executive agencies under the 1978 amendment to section 504, which extended section 504's application to all programs and activities "conducted by" Federal Executive agencies, in that title II applies to anything a public entity does. Title II coverage, however, is not limited to "Executive" agencies, but includes activities of the legislative and judicial branches of State and local governments. All governmental activities of public entities are covered, even if they are carried out by contractors. For example, a State is obligated by title II to ensure that the services, programs, and activities of a State park inn operated under contract by a private entity are in compliance with title II's requirements. The private entity operating the inn would also be subject to the obligations of public accommodations under title III of the Act and the Department's title III regulations at 28 CFR part 36.

Aside from employment, which is also covered by title I of the Act, there are

two major categories of programs or activities covered by this regulation: those involving general public contact as part of ongoing operations of the entity and those directly administered by the entities for program beneficiaries and participants. Activities in the first category include communication with the public (telephone contacts, office walk-ins, or interviews) and the public's use of the entity's facilities. Activities in the second category include programs that provide State or local government services or benefits.

Paragraph (b) of § 35.102 explains that to the extent that the public transportation services, programs, and activities of public entities are covered by subtitle B of title II of the Act, they are subject to the regulation of the Department of Transportation (DOT) at 49 CFR part 37, and are not covered by this part. The Department of Transportation's ADA regulation establishes specific requirements for construction of transportation facilities and acquisition of vehicles. Matters not covered by subtitle B, such as the provision of auxiliary aids, are covered by this rule. For example, activities that are covered by the Department of Transportation's regulation implementing subtitle B are not required to be included in the self-evaluation required by § 35.105. In addition, activities not specifically addressed by DOT's ADA regulation may be covered by DOT's regulation implementing section 504 for its federally assisted programs and activities at 49 CFR part 27. Like other programs of public entities that are also recipients of Federal financial assistance, those programs would be covered by both the section 504 regulation and this part. Although airports operated by public entities are not subject to DOT's ADA regulation, they are subject to subpart A of title II and to this rule.

Some commenters asked for clarification about the responsibilities of public school systems under section 504 and the ADA with respect to programs, services, and activities that are not covered by the Individuals with Disabilities Education Act (IDEA), including, for example, programs open to parents or to the public, graduation ceremonies, parent-teacher organization meetings, plays and other events open to the public, and adult education classes. Public school systems must comply with the ADA in all of their services, programs, or activities, including those that are open to parents or to the public. For instance, public school systems must provide program accessibility to parents and guardians with disabilities to these programs, activities, or services, and

appropriate auxiliary aids and services whenever necessary to ensure effective communication, as long as the provision of the auxiliary aids results neither in an undue burden or in a fundamental alteration of the program.

Section 35.103 Relationship to Other Laws

Section 35.103 is derived from sections 501 (a) and (b) of the ADA. Paragraph (a) of this section provides that, except as otherwise specifically provided by this part, title II of the ADA is not intended to apply lesser standards than are required under title V of the Rehabilitation Act of 1973, as amended (29 U.S.C. 790-94), or the regulations implementing that title. The standards of title V of the Rehabilitation Act apply for purposes of the ADA to the extent that the ADA has not explicitly adopted a different standard than title V. Because title II of the ADA essentially extends the antidiscrimination prohibition embodied in section 504 to all actions of State and local governments, the standards adopted in this part are generally the same as those required under section 504 for federally assisted programs. Title II, however, also incorporates those provisions of titles I and III of the ADA that are not inconsistent with the regulations implementing section 504. Judiciary Committee report, H.R. Rep. No. 485, 101st Cong., 2d Sess., pt. 3, at 51 (1990) (hereinafter "Judiciary report"); Education and Labor Committee report, H.R. Rep. No. 485, 101st Cong., 2d Sess., pt. 2, at 84 (1990) (hereinafter "Education and Labor report"). Therefore, this part also includes appropriate provisions derived from the regulations implementing those titles. The inclusion of specific language in this part, however, should not be interpreted as an indication that a requirement is not included under a regulation implementing section 504.

Paragraph (b) makes clear that Congress did not intend to displace any of the rights or remedies provided by other Federal laws (including section 504) or other State laws (including State common law) that provide greater or equal protection to individuals with disabilities. As discussed above, the standards adopted by title II of the ADA for State and local government services are generally the same as those required under section 504 for federally assisted programs and activities. Subpart F of the regulation establishes compliance procedures for processing complaints covered by both this part and section 504.

With respect to State law, a plaintiff may choose to pursue claims under a State law that does not confer greater substantive rights, or even confers fewer substantive rights, if the alleged violation is protected under the alternative law and the remedies are greater. For example, a person with a physical disability could seek damages under a State law that allows compensatory and punitive damages for discrimination on the basis of physical disability, but not on the basis of mental disability. In that situation, the State law would provide narrower coverage, by excluding mental disabilities, but broader remedies, and an individual covered by both laws could choose to bring an action under both laws. Moreover, State tort claims confer greater remedies and are not preempted by the ADA. A plaintiff may join a State tort claim to a case brought under the ADA. In such a case, the plaintiff must, of course, prove all the elements of the State tort claim in order to prevail under that cause of action.

Section 35.104 Definitions

"Act." The word "Act" is used in this part to refer to the Americans with Disabilities Act of 1990, Public Law 101-336, which is also referred to as the "ADA."

"Assistant Attorney General." The term "Assistant Attorney General" refers to the Assistant Attorney General of the Civil Rights Division of the Department of Justice.

"Auxiliary aids and services." Auxiliary aids and services include a wide range of services and devices for ensuring effective communication. The proposed definition in § 35.104 provided a list of examples of auxiliary aids and services that were taken from the definition of auxiliary aids and services in section 3(1) of the ADA and were supplemented by examples from regulations implementing section 504 in federally conducted programs (see 28 CFR 39.103).

A substantial number of commenters suggested that additional examples be added to this list. The Department has added several items to this list but wishes to clarify that the list is not an all-inclusive or exhaustive catalogue of possible or available auxiliary aids or services. It is not possible to provide an exhaustive list, and an attempt to do so would omit the new devices that will become available with emerging technology.

Subparagraph (1) lists several examples, which would be considered auxiliary aids and services to make aurally delivered materials available to individuals with hearing impairments.

The Department has changed the phrase used in the proposed rules, "orally delivered materials," to the statutory phrase, "aurally delivered materials," to track section 3 of the ADA and to include non-verbal sounds and alarms, and computer generated speech.

The Department has added videotext displays, transcription services, and closed and open captioning to the list of examples. Videotext displays have become an important means of accessing auditory communications through a public address system. Transcription services are used to relay aurally delivered material almost simultaneously in written form to persons who are deaf or hearing-impaired. This technology is often used at conferences, conventions, and hearings. While the proposed rule expressly included television decoder equipment as an auxiliary aid or service, it did not mention captioning itself. The final rule rectifies this omission by mentioning both closed and open captioning.

Several persons and organizations requested that the Department replace the term "telecommunications devices for deaf persons" or "TDD's" with the term "text telephone." The Department has declined to do so. The Department is aware that the Architectural and Transportation Barriers Compliance Board (ATBCB) has used the phrase "text telephone" in lieu of the statutory term "TDD" in its final accessibility guidelines. Title IV of the ADA, however, uses the term "Telecommunications Device for the Deaf" and the Department believes it would be inappropriate to abandon this statutory term at this time.

Several commenters urged the Department to include in the definition of "auxiliary aids and services" devices that are now available or that may become available with emerging technology. The Department declines to do so in the rule. The Department, however, emphasizes that, although the definition would include "state of the art" devices, public entities are not required to use the newest or most advanced technologies as long as the auxiliary aid or service that is selected affords effective communication.

Subparagraph (2) lists examples of aids and services for making visually delivered materials accessible to persons with visual impairments. Many commenters proposed additional examples, such as signage or mapping, audio description services, secondary auditory programs, telebrailers, and reading machines. While the Department declines to add these items to the list, they are auxiliary aids and

services and may be appropriate depending on the circumstances.

Subparagraph (3) refers to acquisition or modification of equipment or devices. Several commenters suggested the addition of current technological innovations in microelectronics and computerized control systems (e.g., voice recognition systems, automatic dialing telephones, and infrared elevator and light control systems) to the list of auxiliary aids. The Department interprets auxiliary aids and services as those aids and services designed to provide effective communications, i.e., making aurally and visually delivered information available to persons with hearing, speech, and vision impairments. Methods of making services, programs, or activities accessible to, or usable by, individuals with mobility or manual dexterity impairments are addressed by other sections of this part, including the provision for modifications in policies, practices, or procedures (§ 35.130 (b)(7)).

Paragraph (b)(4) deals with other similar services and actions. Several commenters asked for clarification that "similar services and actions" include retrieving items from shelves, assistance in reaching a marginally accessible seat, pushing a barrier aside in order to provide an accessible route, or assistance in removing a sweater or coat. While retrieving an item from a shelf might be an "auxiliary aid or service" for a blind person who could not locate the item without assistance, it might be a method of providing program access for a person using a wheelchair who could not reach the shelf, or a reasonable modification to a self-service policy for an individual who lacked the ability to grasp the item. As explained above, auxiliary aids and services are those aids and services required to provide effective communications. Other forms of assistance are more appropriately addressed by other provisions of the final rule.

"Complete complaint." "Complete complaint" is defined to include all the information necessary to enable the Federal agency designated under subpart G as responsible for investigation of a complaint to initiate its investigation.

"Current illegal use of drugs." The phrase "current illegal use of drugs" is used in § 35.131. Its meaning is discussed in the preamble for that section.

"Designated agency." The term "designated agency" is used to refer to the Federal agency designated under subpart G of this rule as responsible for carrying out the administrative

enforcement responsibilities established by subpart F of the rule.

"Disability." The definition of the term "disability" is the same as the definition in the title III regulation codified at 28 CFR part 36. It is comparable to the definition of the term "individual with handicaps" in section 7(b) of the Rehabilitation Act and section 802(h) of the Fair Housing Act. The Education and Labor Committee report makes clear that the analysis of the term "individual with handicaps" by the Department of Health, Education, and Welfare (HEW) in its regulations implementing section 504 (42 FR 22685 (May 4, 1977)) and the analysis by the Department of Housing and Urban Development in its regulation implementing the Fair Housing Amendments Act of 1988 (54 FR 3232 (Jan. 23, 1989)) should also apply fully to the term "disability" (Education and Labor report at 50).

The use of the term "disability" instead of "handicap" and the term "individual with a disability" instead of "individual with handicaps" represents an effort by Congress to make use of up-to-date, currently accepted terminology. As with racial and ethnic epithets, the choice of terms to apply to a person with a disability is overlaid with stereotypes, patronizing attitudes, and other emotional connotations. Many individuals with disabilities, and organizations representing such individuals, object to the use of such terms as "handicapped person" or "the handicapped." In other recent legislation, Congress also recognized this shift in terminology, e.g., by changing the name of the National Council on the Handicapped to the National Council on Disability (Pub. L. 100-630).

In enacting the Americans with Disabilities Act, Congress concluded that it was important for the current legislation to use terminology most in line with the sensibilities of most Americans with disabilities. No change in definition or substance is intended nor should one be attributed to this change in phraseology.

The term "disability" means, with respect to an individual—

(A) A physical or mental impairment that substantially limits one or more of the major life activities of such individual;

(B) A record of such an impairment; or

(C) Being regarded as having such an impairment. If an individual meets any one of these three tests, he or she is considered to be an individual with a disability for purposes of coverage under the Americans with Disabilities Act.

Congress adopted this same basic definition of "disability," first used in the Rehabilitation Act of 1973 and in the Fair Housing Amendments Act of 1988, for a number of reasons. First, it has worked well since it was adopted in 1974. Second, it would not be possible to guarantee comprehensiveness by providing a list of specific disabilities, especially because new disorders may be recognized in the future, as they have since the definition was first established in 1974.

Test A—A physical or mental impairment that substantially limits one or more of the major life activities of such individual

Physical or mental impairment. Under the first test, an individual must have a physical or mental impairment. As explained in paragraph (1)(i) of the definition, "impairment" means any physiological disorder or condition, cosmetic disfigurement, or anatomical loss affecting one or more of the following body systems: neurological; musculoskeletal; special sense organs (which would include speech organs that are not respiratory such as vocal cords, soft palate, tongue, etc.); respiratory, including speech organs; cardiovascular; reproductive; digestive; genitourinary; hemic and lymphatic; skin; and endocrine. It also means any mental or psychological disorder, such as mental retardation, organic brain syndrome, emotional or mental illness, and specific learning disabilities. This list closely tracks the one used in the regulations for section 504 of the Rehabilitation Act of 1973 (see, e.g., 45 CFR 84.3(j)(2)(i)).

Many commenters asked that "traumatic brain injury" be added to the list in paragraph (1)(i). Traumatic brain injury is already included because it is a physiological condition affecting one of the listed body systems, i.e., "neurological." Therefore, it was unnecessary to add the term to the regulation, which only provides representative examples of physiological disorders.

It is not possible to include a list of all the specific conditions, contagious and noncontagious diseases, or infections that would constitute physical or mental impairments because of the difficulty of ensuring the comprehensiveness of such a list, particularly in light of the fact that other conditions or disorders may be identified in the future. However, the list of examples in paragraph (1)(ii) of the definition includes: orthopedic, visual, speech and hearing impairments, cerebral palsy, epilepsy, muscular dystrophy, multiple sclerosis, cancer, heart disease, diabetes, mental

retardation, emotional illness, specific learning disabilities, HIV disease (symptomatic or asymptomatic), tuberculosis, drug addiction, and alcoholism. The phrase "symptomatic or asymptomatic" was inserted in the final rule after "HIV disease" in response to commenters who suggested the clarification was necessary.

The examples of "physical or mental impairments" in paragraph (1)(ii) are the same as those contained in many section 504 regulations, except for the addition of the phrase "contagious and noncontagious" to describe the types of diseases and conditions included, and the addition of "HIV disease (symptomatic or asymptomatic)" and "tuberculosis" to the list of examples. These additions are based on the committee reports, caselaw, and official legal opinions interpreting section 504. In *School Board of Nassau County v. Arline*, 480 U.S. 273 (1987), a case involving an individual with tuberculosis, the Supreme Court held that people with contagious diseases are entitled to the protections afforded by section 504. Following the *Arline* decision, this Department's Office of Legal Counsel issued a legal opinion that concluded that symptomatic HIV disease is an impairment that substantially limits a major life activity; therefore it has been included in the definition of disability under this part. The opinion also concluded that asymptomatic HIV disease is an impairment that substantially limits a major life activity, either because of its actual effect on the individual with HIV disease or because the reactions of other people to individuals with HIV disease cause such individuals to be treated as though they are disabled. See Memorandum from Douglas W. Kmiec, Acting Assistant Attorney General, Office of Legal Counsel, Department of Justice, to Arthur B. Culvahouse, Jr., Counsel to the President (Sept. 27, 1988), reprinted in Hearings on S. 933, the Americans with Disabilities Act, Before the Subcomm. on the Handicapped of the Senate Comm. on Labor and Human Resources, 101st Cong., 1st Sess. 346 (1989).

Paragraph (1)(iii) states that the phrase "physical or mental impairment" does not include homosexuality or bisexuality. These conditions were never considered impairments under other Federal disability laws. Section 511(a) of the statute makes clear that they are likewise not to be considered impairments under the Americans with Disabilities Act.

Physical or mental impairment does not include simple physical

characteristics, such as blue eyes or black hair. Nor does it include environmental, cultural, economic, or other disadvantages, such as having a prison record, or being poor. Nor is age a disability. Similarly, the definition does not include common personality traits such as poor judgment or a quick temper where these are not symptoms of a mental or psychological disorder. However, a person who has these characteristics and also has a physical or mental impairment may be considered as having a disability for purposes of the Americans with Disabilities Act based on the impairment.

Substantial Limitation of a Major Life Activity. Under Test A, the impairment must be one that "substantially limits a major life activity." Major life activities include such things as caring for one's self, performing manual tasks, walking, seeing, hearing, speaking, breathing, learning, and working.

For example, a person who is paraplegic is substantially limited in the major life activity of walking, a person who is blind is substantially limited in the major life activity of seeing, and a person who is mentally retarded is substantially limited in the major life activity of learning. A person with traumatic brain injury is substantially limited in the major life activities of caring for one's self, learning, and working because of memory deficit, confusion, contextual difficulties, and inability to reason appropriately.

A person is considered an individual with a disability for purposes of Test A, the first prong of the definition, when the individual's important life activities are restricted as to the conditions, manner, or duration under which they can be performed in comparison to most people. A person with a minor, trivial impairment, such as a simple infected finger, is not impaired in a major life activity. A person who can walk for 10 miles continuously is not substantially limited in walking merely because, on the eleventh mile, he or she begins to experience pain, because most people would not be able to walk eleven miles without experiencing some discomfort.

The Department received many comments on the proposed rule's inclusion of the word "temporary" in the definition of "disability." The preamble indicated that impairments are not necessarily excluded from the definition of "disability" simply because they are temporary, but that the duration, or expected duration, of an impairment is one factor that may properly be considered in determining whether the impairment substantially limits a major life activity. The preamble recognized,

however, that temporary impairments, such as a broken leg, are not commonly regarded as disabilities, and only in rare circumstances would the degree of the limitation and its expected duration be substantial. Nevertheless, many commenters objected to inclusion of the word "temporary" both because it is not in the statute and because it is not contained in the definition of "disability" set forth in the title I regulations of the Equal Employment Opportunity Commission (EEOC). The word "temporary" has been deleted from the final rule to conform with the statutory language.

The question of whether a temporary impairment is a disability must be resolved on a case-by-case basis, taking into consideration both the duration (or expected duration) of the impairment and the extent to which it actually limits a major life activity of the affected individual.

The question of whether a person has a disability should be assessed without regard to the availability of mitigating measures, such as reasonable modification or auxiliary aids and services. For example, a person with hearing loss is substantially limited in the major life activity of hearing, even though the loss may be improved through the use of a hearing aid. Likewise, persons with impairments, such as epilepsy or diabetes, that substantially limit a major life activity, are covered under the first prong of the definition of disability, even if the effects of the impairment are controlled by medication.

Many commenters asked that environmental illness (also known as multiple chemical sensitivity) as well as allergy to cigarette smoke be recognized as disabilities. The Department, however, declines to state categorically that these types of allergies or sensitivities are disabilities, because the determination as to whether an impairment is a disability depends on whether, given the particular circumstances at issue, the impairment substantially limits one or more major life activities (or has a history of, or is regarded as having such an effect).

Sometimes respiratory or neurological functioning is so severely affected that an individual will satisfy the requirements to be considered disabled under the regulation. Such an individual would be entitled to all of the protections afforded by the Act and this part. In other cases, individuals may be sensitive to environmental elements or to smoke but their sensitivity will not rise to the level needed to constitute a disability. For example, their major life activity of breathing may be somewhat,

but not substantially, impaired. In such circumstances, the individuals are not disabled and are not entitled to the protections of the statute despite their sensitivity to environmental agents.

In sum, the determination as to whether allergies to cigarette smoke, or allergies or sensitivities characterized by the commenters as environmental illness are disabilities covered by the regulation must be made using the same case-by-case analysis that is applied to all other physical or mental impairments. Moreover, the addition of specific regulatory provisions relating to environmental illness in the final rule would be inappropriate at this time pending future consideration of the issue by the Architectural and Transportation Barriers Compliance Board, the Environmental Protection Agency, and the Occupational Safety and Health Administration of the Department of Labor.

Test B—A record of such an impairment

This test is intended to cover those who have a record of an impairment. As explained in paragraph (3) of the rule's definition of disability, this includes a person who has a history of an impairment that substantially limited a major life activity, such as someone who has recovered from an impairment. It also includes persons who have been misclassified as having an impairment.

This provision is included in the definition in part to protect individuals who have recovered from a physical or mental impairment that previously substantially limited them in a major life activity. Discrimination on the basis of such a past impairment is prohibited. Frequently occurring examples of the first group (those who have a history of an impairment) are persons with histories of mental or emotional illness, heart disease, or cancer; examples of the second group (those who have been misclassified as having an impairment) are persons who have been misclassified as having mental retardation or mental illness.

Test C—Being regarded as having such an impairment

This test, as contained in paragraph (4) of the definition, is intended to cover persons who are treated by a public entity as having a physical or mental impairment that substantially limits a major life activity. It applies when a person is treated as if he or she has an impairment that substantially limits a major life activity, regardless of whether that person has an impairment.

The Americans with Disabilities Act uses the same "regarded as" test set

forth in the regulations implementing section 504 of the Rehabilitation Act. See, e.g., 28 CFR 42.540(k)(2)(iv), which provides:

(iv) "Is regarded as having an impairment" means (A) Has a physical or mental impairment that does not substantially limit major life activities but that is treated by a recipient as constituting such a limitation; (B) Has a physical or mental impairment that substantially limits major life activities only as a result of the attitudes of others toward such impairment; or (C) Has none of the impairments defined in paragraph (k)(2)(i) of this section but is treated by a recipient as having such an impairment.

The perception of the covered entity is a key element of this test. A person who perceives himself or herself to have an impairment, but does not have an impairment, and is not treated as if he or she has an impairment, is not protected under this test.

A person would be covered under this test if a public entity refused to serve the person because it perceived that the person had an impairment that limited his or her enjoyment of the goods or services being offered.

For example, persons with severe burns often encounter discrimination in community activities, resulting in substantial limitation of major life activities. These persons would be covered under this test based on the attitudes of others towards the impairment, even if they did not view themselves as "impaired."

The rationale for this third test, as used in the Rehabilitation Act of 1973, was articulated by the Supreme Court in *Arline*, 480 U.S. 273 (1987). The Court noted that although an individual may have an impairment that does not in fact substantially limit a major life activity, the reaction of others may prove just as disabling. "Such an impairment might not diminish a person's physical or mental capabilities, but could nevertheless substantially limit that person's ability to work as a result of the negative reactions of others to the impairment." *Id.* at 283. The Court concluded that, by including this test in the Rehabilitation Act's definition, "Congress acknowledged that society's accumulated myths and fears about disability and diseases are as handicapping as are the physical limitations that flow from actual impairment." *Id.* at 284.

Thus, a person who is denied services or benefits by a public entity because of myths, fears, and stereotypes associated with disabilities would be covered under this third test whether or not the person's physical or mental condition would be considered a disability under the first or second test in the definition.

If a person is refused admittance on the basis of an actual or perceived physical or mental condition, and the public entity can articulate no legitimate reason for the refusal (such as failure to meet eligibility criteria), a perceived concern about admitting persons with disabilities could be inferred and the individual would qualify for coverage under the "regarded as" test. A person who is covered because of being regarded as having an impairment is not required to show that the public entity's perception is inaccurate (e.g., that he will be accepted by others) in order to receive benefits from the public entity.

Paragraph (5) of the definition lists certain conditions that are not included within the definition of "disability." The excluded conditions are: Transvestism, transsexualism, pedophilia, exhibitionism, voyeurism, gender identity disorders not resulting from physical impairments, other sexual behavior disorders, compulsive gambling, kleptomania, pyromania, and psychoactive substance use disorders resulting from current illegal use of drugs. Unlike homosexuality and bisexuality, which are not considered impairments under either section 504 or the Americans with Disabilities Act (see the definition of "disability," paragraph (1)(iv)), the conditions listed in paragraph (5), except for transvestism, are not necessarily excluded as impairments under section 504. (Transvestism was excluded from the definition of disability for section 504 by the Fair Housing Amendments Act of 1988, Pub. L. 100-430, section 6(b)).

"Drug." The definition of the term "drug" is taken from section 510(d)(2) of the ADA.

"Facility." "Facility" means all or any portion of buildings, structures, sites, complexes, equipment, rolling stock or other conveyances, roads, walks, passageways, parking lots, or other real or personal property, including the site where the building, property, structure, or equipment is located. It includes both indoor and outdoor areas where human-constructed improvements, structures, equipment, or property have been added to the natural environment.

Commenters raised questions about the applicability of this part to activities operated in mobile facilities, such as bookmobiles or mobile health screening units. Such activities would be covered by the requirement for program accessibility in § 35.150, and would be included in the definition of "facility" as "other real or personal property," although standards for new construction and alterations of such facilities are not yet included in the accessibility standards adopted by § 35.151. Sections

35.150 and 35.151 specifically address the obligations of public entities to ensure accessibility by providing curb ramps at pedestrian walkways.

"Historic preservation programs" and "Historic properties" are defined in order to aid in the interpretation of §§ 35.150 (a)(2) and (b)(2), which relate to accessibility of historic preservation programs, and § 35.151(d), which relates to the alteration of historic properties.

"Illegal use of drugs." The definition of "illegal use of drugs" is taken from section 510(d)(1) of the Act and clarifies that the term includes the illegal use of one or more drugs.

"Individual with a disability" means a person who has a disability but does not include an individual who is currently illegally using drugs, when the public entity acts on the basis of such use. The phrase "current illegal use of drugs" is explained in § 35.131.

"Public entity." The term "public entity" is defined in accordance with section 201(1) of the ADA as any State or local government; any department, agency, special purpose district, or other instrumentality of a State or States or local government; or the National Railroad Passenger Corporation, and any commuter authority (as defined in section 103(8) of the Rail Passenger Service Act).

"Qualified individual with a disability." The definition of "qualified individual with a disability" is taken from section 201(2) of the Act, which is derived from the definition of "qualified handicapped person" in the Department of Health and Human Services' regulation implementing section 504 (45 CFR § 84.3(k)). It combines the definition at 45 CFR 84.3(k)(1) for employment ("a handicapped person who, with reasonable accommodation, can perform the essential functions of the job in question") with the definition for other services at 45 CFR 84.3(k)(4) ("a handicapped person who meets the essential eligibility requirements for the receipt of such services").

Some commenters requested clarification of the term "essential eligibility requirements." Because of the variety of situations in which an individual's qualifications will be at issue, it is not possible to include more specific criteria in the definition. The "essential eligibility requirements" for participation in some activities covered under this part may be minimal. For example, most public entities provide information about their operations as a public service to anyone who requests it. In such situations, the only "eligibility requirement" for receipt of such information would be the request for it.

Where such information is provided by telephone, even the ability to use a voice telephone is not an "essential eligibility requirement," because § 35.161 requires a public entity to provide equally effective telecommunication systems for individuals with impaired hearing or speech.

For other activities, identification of the "essential eligibility requirements" may be more complex. Where questions of safety are involved, the principles established in § 36.208 of the Department's regulation implementing title III of the ADA, to be codified at 28 CFR, part 36, will be applicable. That section implements section 302(b)(3) of the Act, which provides that a public accommodation is not required to permit an individual to participate in or benefit from the goods, services, facilities, privileges, advantages and accommodations of the public accommodation, if that individual poses a direct threat to the health or safety of others.

A "direct threat" is a significant risk to the health or safety of others that cannot be eliminated by a modification of policies, practices, or procedures, or by the provision of auxiliary aids or services. In *School Board of Nassau County v. Arline*, 480 U.S. 273 (1987), the Supreme Court recognized that there is a need to balance the interests of people with disabilities against legitimate concerns for public safety. Although persons with disabilities are generally entitled to the protection of this part, a person who poses a significant risk to others will not be "qualified," if reasonable modifications to the public entity's policies, practices, or procedures will not eliminate that risk.

The determination that a person poses a direct threat to the health or safety of others may not be based on generalizations or stereotypes about the effects of a particular disability. It must be based on an individualized assessment, based on reasonable judgment that relies on current medical evidence or on the best available objective evidence, to determine: the nature, duration, and severity of the risk; the probability that the potential injury will actually occur; and whether reasonable modifications of policies, practices, or procedures will mitigate the risk. This is the test established by the Supreme Court in *Arline*. Such an inquiry is essential if the law is to achieve its goal of protecting disabled individuals from discrimination based on prejudice, stereotypes, or unfounded fear, while giving appropriate weight to legitimate concerns, such as the need to avoid exposing others to significant

health and safety risks. Making this assessment will not usually require the services of a physician. Sources for medical knowledge include guidance from public health authorities, such as the U.S. Public Health Service, the Centers for Disease Control, and the National Institutes of Health, including the National Institute of Mental Health.

"Qualified interpreter." The Department received substantial comment regarding the lack of a definition of "qualified interpreter." The proposed rule defined auxiliary aids and services to include the statutory term, "qualified interpreters" (§ 35.104), but did not define it. Section 35.160 requires the use of auxiliary aids including qualified interpreters and commenters stated that a lack of guidance on what the term means would create confusion among those trying to secure interpreting services and often result in less than effective communication.

Many commenters were concerned that, without clear guidance on the issue of "qualified" interpreter, the rule would be interpreted to mean "available, rather than qualified" interpreters. Some claimed that few public entities would understand the difference between a qualified interpreter and a person who simply knows a few signs or how to fingerspell.

In order to clarify what is meant by "qualified interpreter" the Department has added a definition of the term to the final rule. A qualified interpreter means an interpreter who is able to interpret effectively, accurately, and impartially both receptively and expressively, using any necessary specialized vocabulary. This definition focuses on the actual ability of the interpreter in a particular interpreting context to facilitate effective communication between the public entity and the individual with disabilities.

Public comment also revealed that public entities have at times asked persons who are deaf to provide family members or friends to interpret. In certain circumstances, notwithstanding that the family member or friend is able to interpret or is a certified interpreter, the family member or friend may not be qualified to render the necessary interpretation because of factors such as emotional or personal involvement or considerations of confidentiality that may adversely affect the ability to interpret "effectively, accurately, and impartially."

The definition of "qualified interpreter" in this rule does not invalidate or limit standards for interpreting services of any State or local law that are equal to or more

stringent than those imposed by this definition. For instance, the definition would not supersede any requirement of State law for use of a certified interpreter in court proceedings.

"Section 504." The Department added a definition of "section 504" because the term is used extensively in subpart F of this part.

"State." The definition of "State" is identical to the statutory definition in section 3(3) of the ADA.

Section 35.105 Self-evaluation

Section 35.105 establishes a requirement, based on the section 504 regulations for federally assisted and federally conducted programs, that a public entity evaluate its current policies and practices to identify and correct any that are not consistent with the requirements of this part. As noted in the discussion of § 35.102, activities covered by the Department of Transportation's regulation implementing subtitle B of title II are not required to be included in the self-evaluation required by this section.

Experience has demonstrated the self-evaluation process to be a valuable means of establishing a working relationship with individuals with disabilities, which has promoted both effective and efficient implementation of section 504. The Department expects that it will likewise be useful to public entities newly covered by the ADA.

All public entities are required to do a self-evaluation. However, only those that employ 50 or more persons are required to maintain the self-evaluation on file and make it available for public inspection for three years. The number 50 was derived from the Department of Justice's section 504 regulations for federally assisted programs, 28 CFR 42.505(c). The Department received comments critical of this limitation, some suggesting the requirement apply to all public entities and others suggesting that the number be changed from 50 to 15. The final rule has not been changed. Although many regulations implementing section 504 for federally assisted programs do use 15 employees as the cut-off for this record-keeping requirement, the Department believes that it would be inappropriate to extend it to those smaller public entities covered by this regulation that do not receive Federal financial assistance. This approach has the benefit of minimizing paperwork burdens on small entities.

Paragraph (d) provides that the self-evaluation required by this section shall apply only to programs not subject to section 504 or those policies and

practices, such as those involving communications access, that have not already been included in a self-evaluation required under an existing regulation implementing section 504. Because most self-evaluations were done from five to twelve years ago, however, the Department expects that a great many public entities will be reexamining all of their policies and programs. Programs and functions may have changed, and actions that were supposed to have been taken to comply with section 504 may not have been fully implemented or may no longer be effective. In addition, there have been statutory amendments to section 504 which have changed the coverage of section 504, particularly the Civil Rights Restoration Act of 1987, Public Law No. 100-259, 102 Stat. 28 (1988), which broadened the definition of a covered "program or activity."

Several commenters suggested that the Department clarify public entities' liability during the one-year period for compliance with the self-evaluation requirement. The self-evaluation requirement does not stay the effective date of the statute nor of this part. Public entities are, therefore, not shielded from discrimination claims during that time.

Other commenters suggested that the rule require that every self-evaluation include an examination of training efforts to assure that individuals with disabilities are not subjected to discrimination because of insensitivity, particularly in the law enforcement area. Although the Department has not added such a specific requirement to the rule, it would be appropriate for public entities to evaluate training efforts because, in many cases, lack of training leads to discriminatory practices, even when the policies in place are nondiscriminatory.

Section 35.106 Notice

Section 35.106 requires a public entity to disseminate sufficient information to applicants, participants, beneficiaries, and other interested persons to inform them of the rights and protections afforded by the ADA and this regulation. Methods of providing this information include, for example, the publication of information in handbooks, manuals, and pamphlets that are distributed to the public to describe a public entity's programs and activities; the display of informative posters in service centers and other public places; or the broadcast of information by television or radio. In providing the notice, a public entity must comply with the requirements for effective communication in § 35.160. The

preamble to that section gives guidance on how to effectively communicate with individuals with disabilities.

Section 35.107 Designation of Responsible Employee and Adoption of Grievance Procedures

Consistent with § 35.105, self-evaluation, the final rule requires that public entities with 50 or more employees designate a responsible employee and adopt grievance procedures. Most of the commenters who suggested that the requirement that self-evaluation be maintained on file for three years not be limited to those employing 50 or more persons made a similar suggestion concerning § 35.107. Commenters recommended either that all public entities be subject to § 35.107, or that "50 or more persons" be changed to "15 or more persons." As explained in the discussion of § 35.105, the Department has not adopted this suggestion.

The requirement for designation of an employee responsible for coordination of efforts to carry out responsibilities under this part is derived from the HEW regulation implementing section 504 in federally assisted programs. The requirement for designation of a particular employee and dissemination of information about how to locate that employee helps to ensure that individuals dealing with large agencies are able to easily find a responsible person who is familiar with the requirements of the Act and this part and can communicate those requirements to other individuals in the agency who may be unaware of their responsibilities. This paragraph in no way limits a public entity's obligation to ensure that all of its employees comply with the requirements of this part, but it ensures that any failure by individual employees can be promptly corrected by the designated employee.

Section 35.107(b) requires public entities with 50 or more employees to establish grievance procedures for resolving complaints of violations of this part. Similar requirements are found in the section 504 regulations for federally assisted programs (see, e.g., 45 CFR 84.7(b)). The rule, like the regulations for federally assisted programs, provides for investigation and resolution of complaints by a Federal enforcement agency. It is the view of the Department that public entities subject to this part should be required to establish a mechanism for resolution of complaints at the local level without requiring the complainant to resort to the Federal complaint procedures established under subpart F. Complainants would not, however, be required to exhaust the

public entity's grievance procedures before filing a complaint under subpart F. Delay in filing the complaint at the Federal level caused by pursuit of the remedies available under the grievance procedure would generally be considered good cause for extending the time allowed for filing under § 35.170(b).

Subpart B—General Requirements

Section 35.130 General Prohibitions Against Discrimination

The general prohibitions against discrimination in the rule are generally based on the prohibitions in existing regulations implementing section 504 and, therefore, are already familiar to State and local entities covered by section 504. In addition, § 35.130 includes a number of provisions derived from title III of the Act that are implicit to a certain degree in the requirements of regulations implementing section 504.

Several commenters suggested that this part should include the section of the proposed title III regulation that implemented section 309 of the Act, which requires that courses and examinations related to applications, licensing, certification, or credentialing be provided in an accessible place and manner or that alternative accessible arrangements be made. The Department has not adopted this suggestion. The requirements of this part, including the general prohibitions of discrimination in this section, the program access requirements of subpart D, and the communications requirements of subpart E, apply to courses and examinations provided by public entities. The Department considers these requirements to be sufficient to ensure that courses and examinations administered by public entities meet the requirements of section 309. For example, a public entity offering an examination must ensure that modifications of policies, practices, or procedures or the provision of auxiliary aids and services furnish the individual with a disability an equal opportunity to demonstrate his or her knowledge or ability. Also, any examination specially designed for individuals with disabilities must be offered as often and in as timely a manner as are other examinations. Further, under this part, courses and examinations must be offered in the most integrated setting appropriate. The analysis of § 35.130(d) is relevant to this determination.

A number of commenters asked that the regulation be amended to require training of law enforcement personnel to recognize the difference between criminal activity and the effects of

seizures or other disabilities such as mental retardation, cerebral palsy, traumatic brain injury, mental illness, or deafness. Several disabled commenters gave personal statements about the abuse they had received at the hands of law enforcement personnel. Two organizations that commented cited the Judiciary report at 50 as authority to require law enforcement training.

The Department has not added such a training requirement to the regulation. Discriminatory arrests and brutal treatment are already unlawful police activities. The general regulatory obligation to modify policies, practices, or procedures requires law enforcement to make changes in policies that result in discriminatory arrests or abuse of individuals with disabilities. Under this section law enforcement personnel would be required to make appropriate efforts to determine whether perceived strange or disruptive behavior or unconsciousness is the result of a disability. The Department notes that a number of States have attempted to address the problem of arresting disabled persons for noncriminal conduct resulting from their disability through adoption of the Uniform Duties to Disabled Persons Act, and encourages other jurisdictions to consider that approach.

Paragraph (a) restates the nondiscrimination mandate of section 202 of the ADA. The remaining paragraphs in § 35.130 establish the general principles for analyzing whether any particular action of the public entity violates this mandate.

Paragraph (b) prohibits overt denials of equal treatment of individuals with disabilities. A public entity may not refuse to provide an individual with a disability with an equal opportunity to participate in or benefit from its program simply because the person has a disability.

Paragraph (b)(1)(i) provides that it is discriminatory to deny a person with a disability the right to participate in or benefit from the aid, benefit, or service provided by a public entity. Paragraph (b)(1)(ii) provides that the aids, benefits, and services provided to persons with disabilities must be equal to those provided to others, and paragraph (b)(1)(iii) requires that the aids, benefits, or services provided to individuals with disabilities must be as effective in affording equal opportunity to obtain the same result, to gain the same benefit, or to reach the same level of achievement as those provided to others. These paragraphs are taken from the regulations implementing section 504 and simply restate principles long established under section 504.

Paragraph (b)(1)(iv) permits the public entity to develop separate or different aids, benefits, or services when necessary to provide individuals with disabilities with an equal opportunity to participate in or benefit from the public entity's programs or activities, but only when necessary to ensure that the aids, benefits, or services are as effective as those provided to others. Paragraph (b)(1)(iv) must be read in conjunction with paragraphs (b)(2), (d), and (e). Even when separate or different aids, benefits, or services would be more effective, paragraph (b)(2) provides that a qualified individual with a disability still has the right to choose to participate in the program that is not designed to accommodate individuals with disabilities. Paragraph (d) requires that a public entity administer services, programs, and activities in the most integrated setting appropriate to the needs of qualified individuals with disabilities.

Paragraph (b)(2) specifies that, notwithstanding the existence of separate or different programs or activities provided in accordance with this section, an individual with a disability shall not be denied the opportunity to participate in such programs or activities that are not separate or different. Paragraph (e), which is derived from section 501(d) of the Americans with Disabilities Act, states that nothing in this part shall be construed to require an individual with a disability to accept an accommodation, aid, service, opportunity, or benefit that he or she chooses not to accept.

Taken together, these provisions are intended to prohibit exclusion and segregation of individuals with disabilities and the denial of equal opportunities enjoyed by others, based on, among other things, presumptions, patronizing attitudes, fears, and stereotypes about individuals with disabilities. Consistent with these standards, public entities are required to ensure that their actions are based on facts applicable to individuals and not on presumptions as to what a class of individuals with disabilities can or cannot do.

Integration is fundamental to the purposes of the Americans with Disabilities Act. Provision of segregated accommodations and services relegates persons with disabilities to second-class status. For example, it would be a violation of this provision to require persons with disabilities to eat in the back room of a government cafeteria or to refuse to allow a person with a disability the full use of recreation or exercise facilities because of

stereotypes about the person's ability to participate.

Many commenters objected to proposed paragraphs (b)(1)(iv) and (d) as allowing continued segregation of individuals with disabilities. The Department recognizes that promoting integration of individuals with disabilities into the mainstream of society is an important objective of the ADA and agrees that, in most instances, separate programs for individuals with disabilities will not be permitted. Nevertheless, section 504 does permit separate programs in limited circumstances, and Congress clearly intended the regulations issued under title II to adopt the standards of section 504. Furthermore, Congress included authority for separate programs in the specific requirements of title III of the Act. Section 302(b)(1)(A)(iii) of the Act provides for separate benefits in language similar to that in § 35.130(b)(1)(iv), and section 302(b)(1)(B) includes the same requirement for "the most integrated setting appropriate" as in § 35.130(d).

Even when separate programs are permitted, individuals with disabilities cannot be denied the opportunity to participate in programs that are not separate or different. This is an important and overarching principle of the Americans with Disabilities Act. Separate, special, or different programs that are designed to provide a benefit to persons with disabilities cannot be used to restrict the participation of persons with disabilities in general, integrated activities.

For example, a person who is blind may wish to decline participating in a special museum tour that allows persons to touch sculptures in an exhibit and instead tour the exhibit at his or her own pace with the museum's recorded tour. It is not the intent of this section to require the person who is blind to avail himself or herself of the special tour. Modified participation for persons with disabilities must be a choice, not a requirement.

In addition, it would not be a violation of this section for a public entity to offer recreational programs specially designed for children with mobility impairments. However, it would be a violation of this section if the entity then excluded these children from other recreational services for which they are qualified to participate when these services are made available to nondisabled children, or if the entity required children with disabilities to attend only designated programs.

Many commenters asked that the Department clarify a public entity's

obligations within the integrated program when it offers a separate program but an individual with a disability chooses not to participate in the separate program. It is impossible to make a blanket statement as to what level of auxiliary aids or modifications would be required in the integrated program. Rather, each situation must be assessed individually. The starting point is to question whether the separate program is in fact necessary or appropriate for the individual. Assuming the separate program would be appropriate for a particular individual, the extent to which that individual must be provided with modifications in the integrated program will depend not only on what the individual needs but also on the limitations and defenses of this part. For example, it may constitute an undue burden for a public accommodation, which provides a full-time interpreter in its special guided tour for individuals with hearing impairments, to hire an additional interpreter for those individuals who choose to attend the integrated program. The Department cannot identify categorically the level of assistance or aid required in the integrated program.

Paragraph (b)(1)(v) provides that a public entity may not aid or perpetuate discrimination against a qualified individual with a disability by providing significant assistance to an agency, organization, or person that discriminates on the basis of disability in providing any aid, benefit, or service to beneficiaries of the public entity's program. This paragraph is taken from the regulations implementing section 504 for federally assisted programs.

Paragraph (b)(1)(vi) prohibits the public entity from denying a qualified individual with a disability the opportunity to participate as a member of a planning or advisory board.

Paragraph (b)(1)(vii) prohibits the public entity from limiting a qualified individual with a disability in the enjoyment of any right, privilege, advantage, or opportunity enjoyed by others receiving any aid, benefit, or service.

Paragraph (b)(3) prohibits the public entity from utilizing criteria or methods of administration that deny individuals with disabilities access to the public entity's services, programs, and activities or that perpetuate the discrimination of another public entity, if both public entities are subject to common administrative control or are agencies of the same State. The phrase "criteria or methods of administration" refers to official written policies of the public entity and to the actual practices of the public entity. This paragraph

prohibits both blatantly exclusionary policies or practices and nonessential policies and practices that are neutral on their face, but deny individuals with disabilities an effective opportunity to participate. This standard is consistent with the interpretation of section 504 by the U.S. Supreme Court in *Alexander v. Choate*, 469 U.S. 287 (1985). The Court in *Choate* explained that members of Congress made numerous statements during passage of section 504 regarding eliminating architectural barriers, providing access to transportation, and eliminating discriminatory effects of job qualification procedures. The Court then noted: "These statements would ring hollow if the resulting legislation could not rectify the harms resulting from action that discriminated by effect as well as by design." *Id.* at 297 (footnote omitted).

Paragraph (b)(4) specifically applies the prohibition enunciated in § 35.130(b)(3) to the process of selecting sites for construction of new facilities or selecting existing facilities to be used by the public entity. Paragraph (b)(4) does not apply to construction of additional buildings at an existing site.

Paragraph (b)(5) prohibits the public entity, in the selection of procurement contractors, from using criteria that subject qualified individuals with disabilities to discrimination on the basis of disability.

Paragraph (b)(6) prohibits the public entity from discriminating against qualified individuals with disabilities on the basis of disability in the granting of licenses or certification. A person is a "qualified individual with a disability" with respect to licensing or certification if he or she can meet the essential eligibility requirements for receiving the license or certification (see § 35.104).

A number of commenters were troubled by the phrase "essential eligibility requirements" as applied to State licensing requirements, especially those for health care professions. Because of the variety of types of programs to which the definition of "qualified individual with a disability" applies, it is not possible to use more specific language in the definition. The phrase "essential eligibility requirements," however, is taken from the definitions in the regulations implementing section 504, so caselaw under section 504 will be applicable to its interpretation. In *Southeastern Community College v. Davis*, 442 U.S. 397, for example, the Supreme Court held that section 504 does not require an institution to "lower or effect substantial modifications of standards to accommodate a handicapped person," 442 U.S. at 413, and that the school had

established that the plaintiff was not "qualified" because she was not able to "serve the nursing profession in all customary ways," *id.* Whether a particular requirement is "essential" will, of course, depend on the facts of the particular case.

In addition, the public entity may not establish requirements for the programs or activities of licensees or certified entities that subject qualified individuals with disabilities to discrimination on the basis of disability. For example, the public entity must comply with this requirement when establishing safety standards for the operations of licensees. In that case the public entity must ensure that standards that it promulgates do not discriminate against the employment of qualified individuals with disabilities in an impermissible manner.

Paragraph (b)(6) does not extend the requirements of the Act or this part directly to the programs or activities of licensees or certified entities themselves. The programs or activities of licensees or certified entities are not themselves programs or activities of the public entity merely by virtue of the license or certificate.

Paragraph (b)(7) is a specific application of the requirement under the general prohibitions of discrimination that public entities make reasonable modifications in policies, practices, or procedures where necessary to avoid discrimination on the basis of disability. Section 302(b)(2)(A)(ii) of the ADA sets out this requirement specifically for public accommodations covered by title III of the Act, and the House Judiciary Committee Report directs the Attorney General to include those specific requirements in the title II regulation to the extent that they do not conflict with the regulations implementing section 504. Judiciary report at 52.

Paragraph (b)(8), a new paragraph not contained in the proposed rule, prohibits the imposition or application of eligibility criteria that screen out or tend to screen out an individual with a disability or any class of individuals with disabilities from fully and equally enjoying any service, program, or activity, unless such criteria can be shown to be necessary for the provision of the service, program, or activity being offered. This prohibition is also a specific application of the general prohibitions of discrimination and is based on section 302(b)(2)(A)(i) of the ADA. It prohibits overt denials of equal treatment of individuals with disabilities, or establishment of exclusive or segregative criteria that would bar individuals with disabilities

from participation in services, benefits, or activities.

Paragraph (b)(8) also prohibits policies that unnecessarily impose requirements or burdens on individuals with disabilities that are not placed on others. For example, public entities may not require that a qualified individual with a disability be accompanied by an attendant. A public entity is not, however, required to provide attendant care, or assistance in toileting, eating, or dressing to individuals with disabilities, except in special circumstances, such as where the individual is an inmate of a custodial or correctional institution.

In addition, paragraph (b)(8) prohibits the imposition of criteria that "tend to" screen out an individual with a disability. This concept, which is derived from current regulations under section 504 (*see, e.g.*, 45 CFR 84.13), makes it discriminatory to impose policies or criteria that, while not creating a direct bar to individuals with disabilities, indirectly prevent or limit their ability to participate. For example, requiring presentation of a driver's license as the sole means of identification for purposes of paying by check would violate this section in situations where, for example, individuals with severe vision impairments or developmental disabilities or epilepsy are ineligible to receive a driver's license and the use of an alternative means of identification, such as another photo I.D. or credit card, is feasible.

A public entity may, however, impose neutral rules and criteria that screen out, or tend to screen out, individuals with disabilities if the criteria are necessary for the safe operation of the program in question. Examples of safety qualifications that would be justifiable in appropriate circumstances would include eligibility requirements for drivers' licenses, or a requirement that all participants in a recreational rafting expedition be able to meet a necessary level of swimming proficiency. Safety requirements must be based on actual risks and not on speculation, stereotypes, or generalizations about individuals with disabilities.

Paragraph (c) provides that nothing in this part prohibits a public entity from providing benefits, services, or advantages to individuals with disabilities, or to a particular class of individuals with disabilities, beyond those required by this part. It is derived from a provision in the section 504 regulations that permits programs conducted pursuant to Federal statute or Executive order that are designed to benefit only individuals with disabilities or a given class of individuals with

disabilities to be limited to those individuals with disabilities. Section 504 ensures that federally assisted programs are made available to all individuals, without regard to disabilities, unless the Federal program under which the assistance is provided is specifically limited to individuals with disabilities or a particular class of individuals with disabilities. Because coverage under this part is not limited to federally assisted programs, paragraph (c) has been revised to clarify that State and local governments may provide special benefits, beyond those required by the nondiscrimination requirements of this part, that are limited to individuals with disabilities or a particular class of individuals with disabilities, without thereby incurring additional obligations to persons without disabilities or to other classes of individuals with disabilities.

Paragraphs (d) and (e), previously referred to in the discussion of paragraph (b)(1)(iv), provide that the public entity must administer services, programs, and activities in the most integrated setting appropriate to the needs of qualified individuals with disabilities, *i.e.*, in a setting that enables individuals with disabilities to interact with nondisabled persons to the fullest extent possible, and that persons with disabilities must be provided the option of declining to accept a particular accommodation.

Some commenters expressed concern that § 35.130(e), which states that nothing in the rule requires an individual with a disability to accept special accommodations and services provided under the ADA, could be interpreted to allow guardians of infants or older people with disabilities to refuse medical treatment for their wards. Section 35.130(e) has been revised to make it clear that paragraph (e) is inapplicable to the concern of the commenters. A new paragraph (e)(2) has been added stating that nothing in the regulation authorizes the representative or guardian of an individual with a disability to decline food, water, medical treatment, or medical services for that individual. New paragraph (e) clarifies that neither the ADA nor the regulation alters current Federal law ensuring the rights of incompetent individuals with disabilities to receive food, water, and medical treatment. *See, e.g.*, Child Abuse Amendments of 1984 (42 U.S.C. 5106a(b)(10), 5106g(10)); Rehabilitation Act of 1973, as amended (29 U.S.C. 794); the Developmentally Disabled Assistance and Bill of Rights Act (42 U.S.C. 6042).

Sections 35.130(e) (1) and (2) are based on section 501(d) of the ADA.

Section 501(d) was designed to clarify that nothing in the ADA requires individuals with disabilities to accept special accommodations and services for individuals with disabilities that may segregate them:

The Committee added this section [501(d)] to clarify that nothing in the ADA is intended to permit discriminatory treatment on the basis of disability, even when such treatment is rendered under the guise of providing an accommodation, service, aid or benefit to the individual with disability. For example, a blind individual may choose not to avail himself or herself of the right to go to the front of a line, even if a particular public accommodation has chosen to offer such a modification of a policy for blind individuals. Or, a blind individual may choose to decline to participate in a special museum tour that allows persons to touch sculptures in an exhibit and instead tour the exhibits at his or her own pace with the museum's recorded tour.

Judiciary report at 71-72. The Act is not to be construed to mean that an individual with disabilities must accept special accommodations and services for individuals with disabilities when that individual can participate in the regular services already offered. Because medical treatment, including treatment for particular conditions, is not a special accommodation or service for individuals with disabilities under section 501(d), neither the Act nor this part provides affirmative authority to suspend such treatment. Section 501(d) is intended to clarify that the Act is not designed to foster discrimination through mandatory acceptance of special services when other alternatives are provided; this concern does not reach to the provision of medical treatment for the disabling condition itself.

Paragraph (f) provides that a public entity may not place a surcharge on a particular individual with a disability, or any group of individuals with disabilities, to cover any costs of measures required to provide that individual or group with the nondiscriminatory treatment required by the Act or this part. Such measures may include the provision of auxiliary aids or of modifications required to provide program accessibility.

Several commenters asked for clarification that the costs of interpreter services may not be assessed as an element of "court costs." The Department has already recognized that imposition of the cost of courtroom interpreter services is impermissible under section 504. The preamble to the Department's section 504 regulation for its federally assisted programs states that where a court system has an

obligation to provide qualified interpreters, "it has the corresponding responsibility to pay for the services of the interpreters." (45 FR 37630 (June 3, 1980)). Accordingly, recouping the costs of interpreter services by assessing them as part of court costs would also be prohibited.

Paragraph (g), which prohibits discrimination on the basis of an individual's or entity's known relationship or association with an individual with a disability, is based on sections 102(b)(4) and 302(b)(1)(E) of the ADA. This paragraph was not contained in the proposed rule. The individuals covered under this paragraph are any individuals who are discriminated against because of their known association with an individual with a disability. For example, it would be a violation of this paragraph for a local government to refuse to allow a theater company to use a school auditorium on the grounds that the company had recently performed for an audience of individuals with HIV disease.

This protection is not limited to those who have a familial relationship with the individual who has a disability. Congress considered, and rejected, amendments that would have limited the scope of this provision to specific associations and relationships. Therefore, if a public entity refuses admission to a person with cerebral palsy and his or her companions, the companions have an independent right of action under the ADA and this section.

During the legislative process, the term "entity" was added to section 302(b)(1)(E) to clarify that the scope of the provision is intended to encompass not only persons who have a known association with a person with a disability, but also entities that provide services to or are otherwise associated with such individuals. This provision was intended to ensure that entities such as health care providers, employees of social service agencies, and others who provide professional services to persons with disabilities are not subjected to discrimination because of their professional association with persons with disabilities.

Section 35.131 Illegal Use of Drugs

Section 35.131 effectuates section 510 of the ADA, which clarifies the Act's application to people who use drugs illegally. Paragraph (a) provides that this part does not prohibit discrimination based on an individual's current illegal use of drugs.

The Act and the regulation distinguish between illegal use of drugs and the legal use of substances, whether or not

those substances are "controlled substances," as defined in the Controlled Substances Act (21 U.S.C. 812). Some controlled substances are prescription drugs that have legitimate medical uses. Section 35.131 does not affect use of controlled substances pursuant to a valid prescription under supervision by a licensed health care professional, or other use that is authorized by the Controlled Substances Act or any other provision of Federal law. It does apply to illegal use of those substances, as well as to illegal use of controlled substances that are not prescription drugs. The key question is whether the individual's use of the substance is illegal, not whether the substance has recognized legal uses. Alcohol is not a controlled substance, so use of alcohol is not addressed by § 35.131 (although alcoholics are individuals with disabilities, subject to the protections of the statute).

A distinction is also made between the use of a substance and the status of being addicted to that substance. Addiction is a disability, and addicts are individuals with disabilities protected by the Act. The protection, however, does not extend to actions based on the illegal use of the substance. In other words, an addict cannot use the fact of his or her addiction as a defense to an action based on illegal use of drugs. This distinction is not artificial. Congress intended to deny protection to people who engage in the illegal use of drugs, whether or not they are addicted, but to provide protection to addicts so long as they are not currently using drugs.

A third distinction is the difficult one between current use and former use. The definition of "current illegal use of drugs" in § 35.104, which is based on the report of the Conference Committee, H.R. Conf. Rep. No. 596, 101st Cong., 2d Sess. 64 (1990) (hereinafter "Conference report"), is "illegal use of drugs that occurred recently enough to justify a reasonable belief that a person's drug use is current or that continuing use is a real and ongoing problem."

Paragraph (a)(2)(i) specifies that an individual who has successfully completed a supervised drug rehabilitation program or has otherwise been rehabilitated successfully and who is not engaging in current illegal use of drugs is protected. Paragraph (a)(2)(ii) clarifies that an individual who is currently participating in a supervised rehabilitation program and is not engaging in current illegal use of drugs is protected. Paragraph (a)(2)(iii) provides that a person who is erroneously regarded as engaging in current illegal use of drugs, but who is not engaging in such use, is protected.

Paragraph (b) provides a limited exception to the exclusion of current illegal users of drugs from the protections of the Act. It prohibits denial of health services, or services provided in connection with drug rehabilitation to an individual on the basis of current illegal use of drugs, if the individual is otherwise entitled to such services. A health care facility, such as a hospital or clinic, may not refuse treatment to an individual in need of the services it provides on the grounds that the individual is illegally using drugs, but it is not required by this section to provide services that it does not ordinarily provide. For example, a health care facility that specializes in a particular type of treatment, such as care of burn victims, is not required to provide drug rehabilitation services, but it cannot refuse to treat an individual's burns on the grounds that the individual is illegally using drugs.

Some commenters pointed out that abstinence from the use of drugs is an essential condition of participation in some drug rehabilitation programs, and may be a necessary requirement in inpatient or residential settings. The Department believes that this comment is well-founded. Congress clearly intended to prohibit exclusion from drug treatment programs of the very individuals who need such programs because of their use of drugs, but, once an individual has been admitted to a program, abstinence may be a necessary and appropriate condition to continued participation. The final rule therefore provides that a drug rehabilitation or treatment program may prohibit illegal use of drugs by individuals while they are participating in the program.

Paragraph (c) expresses Congress' intention that the Act be neutral with respect to testing for illegal use of drugs. This paragraph implements the provision in section 510(b) of the Act that allows entities "to adopt or administer reasonable policies or procedures, including but not limited to drug testing," that ensure that an individual who is participating in a supervised rehabilitation program, or who has completed such a program or otherwise been rehabilitated successfully is no longer engaging in the illegal use of drugs. The section is not to be "construed to encourage, prohibit, restrict, or authorize the conducting of testing for the illegal use of drugs."

Paragraph 35.131(c) clarifies that it is not a violation of this part to adopt or administer reasonable policies or procedures to ensure that an individual who formerly engaged in the illegal use of drugs is not currently engaging in

illegal use of drugs. Any such policies or procedures must, of course, be reasonable, and must be designed to identify accurately the illegal use of drugs. This paragraph does not authorize inquiries, tests, or other procedures that would disclose use of substances that are not controlled substances or are taken under supervision by a licensed health care professional, or other uses authorized by the Controlled Substances Act or other provisions of Federal law, because such uses are not included in the definition of "illegal use of drugs." A commenter argued that the rule should permit testing for lawful use of prescription drugs, but most commenters preferred that tests must be limited to unlawful use in order to avoid revealing the lawful use of prescription medicine used to treat disabilities.

Section 35.132 Smoking

Section 35.132 restates the clarification in section 501(b) of the Act that the Act does not preclude the prohibition of, or imposition of restrictions on, smoking in transportation covered by title II. Some commenters argued that this section is too limited in scope, and that the regulation should prohibit smoking in all facilities used by public entities. The reference to smoking in section 501, however, merely clarifies that the Act does not require public entities to accommodate smokers by permitting them to smoke in transportation facilities.

Section 35.133 Maintenance of Accessible Features

Section 35.133 provides that a public entity shall maintain in operable working condition those features of facilities and equipment that are required to be readily accessible to and usable by persons with disabilities by the Act or this part. The Act requires that, to the maximum extent feasible, facilities must be accessible to, and usable by, individuals with disabilities. This section recognizes that it is not sufficient to provide features such as accessible routes, elevators, or ramps, if those features are not maintained in a manner that enables individuals with disabilities to use them. Inoperable elevators, locked accessible doors, or "accessible" routes that are obstructed by furniture, filing cabinets, or potted plants are neither "accessible to" nor "usable by" individuals with disabilities.

Some commenters objected that this section appeared to establish an absolute requirement and suggested that language from the preamble be included

in the text of the regulation. It is, of course, impossible to guarantee that mechanical devices will never fail to operate. Paragraph (b) of the final regulation provides that this section does not prohibit isolated or temporary interruptions in service or access due to maintenance or repairs. This paragraph is intended to clarify that temporary obstructions or isolated instances of mechanical failure would not be considered violations of the Act or this part. However, allowing obstructions or "out of service" equipment to persist beyond a reasonable period of time would violate this part, as would repeated mechanical failures due to improper or inadequate maintenance. Failure of the public entity to ensure that accessible routes are properly maintained and free of obstructions, or failure to arrange prompt repair of inoperable elevators or other equipment intended to provide access would also violate this part.

Other commenters requested that this section be expanded to include specific requirements for inspection and maintenance of equipment, for training staff in the proper operation of equipment, and for maintenance of specific items. The Department believes that this section properly establishes the general requirement for maintaining access and that further details are not necessary.

Section 35.134 Retaliation or Coercion

Section 35.134 implements section 503 of the ADA, which prohibits retaliation against any individual who exercises his or her rights under the Act. This section is unchanged from the proposed rule. Paragraph (a) of § 35.134 provides that no private or public entity shall discriminate against any individual because that individual has exercised his or her right to oppose any act or practice made unlawful by this part, or because that individual made a charge, testified, assisted, or participated in any manner in an investigation, proceeding, or hearing under the Act or this part.

Paragraph (b) provides that no private or public entity shall coerce, intimidate, threaten, or interfere with any individual in the exercise of his or her rights under this part or because that individual aided or encouraged any other individual in the exercise or enjoyment of any right granted or protected by the Act or this part.

This section protects not only individuals who allege a violation of the Act or this part, but also any individuals who support or assist them. This section applies to all investigations or proceedings initiated under the Act or this part without regard to the ultimate

resolution of the underlying allegations. Because this section prohibits any act of retaliation or coercion in response to an individual's effort to exercise rights established by the Act and this part (or to support the efforts of another individual), the section applies not only to public entities subject to this part, but also to persons acting in an individual capacity or to private entities. For example, it would be a violation of the Act and this part for a private individual to harass or intimidate an individual with a disability in an effort to prevent that individual from attending a concert in a State-owned park. It would, likewise, be a violation of the Act and this part for a private entity to take adverse action against an employee who appeared as a witness on behalf of an individual who sought to enforce the Act.

Section 35.135 Personal Devices and Services

The final rule includes a new § 35.135, entitled "Personal devices and services," which states that the provision of personal devices and services is not required by title II. This new section, which serves as a limitation on all of the requirements of the regulation, replaces § 35.160(b)(2) of the proposed rule, which addressed the issue of personal devices and services explicitly only in the context of communications. The personal devices and services limitation was intended to have general application in the proposed rule in all contexts where it was relevant. The final rule, therefore, clarifies this point by including a general provision that will explicitly apply not only to auxiliary aids and services but across-the-board to include other relevant areas such as, for example, modifications in policies, practices, and procedures (§ 35.130(b)(7)). The language of § 35.135 parallels an analogous provision in the Department's title III regulations (28 CFR 36.306) but preserves the explicit reference to "readers for personal use or study" in § 35.160(b)(2) of the proposed rule. This section does not preclude the short-term loan of personal receivers that are part of an assistive listening system.

Subpart C—Employment

Section 35.140 Employment Discrimination Prohibited

Title II of the ADA applies to all activities of public entities, including their employment practices. The proposed rule cross-referenced the definitions, requirements, and procedures of title I of the ADA, as established by the Equal Employment

Opportunity Commission in 29 CFR part 1630. This proposal would have resulted in use, under § 35.140, of the title I definition of "employer," so that a public entity with 25 or more employees would have become subject to the requirements of § 35.140 on July 26, 1992, one with 15 to 24 employees on July 26, 1994, and one with fewer than 15 employees would have been excluded completely.

The Department received comments objecting to this approach. The commenters asserted that Congress intended to establish nondiscrimination requirements for employment by all public entities, including those that employ fewer than 15 employees; and that Congress intended the employment requirements of title II to become effective at the same time that the other requirements of this regulation become effective, January 26, 1992. The Department has reexamined the statutory language and legislative history of the ADA on this issue and has concluded that Congress intended to cover the employment practices of all public entities and that the applicable effective date is that of title II.

The statutory language of section 204(b) of the ADA requires the Department to issue a regulation that is consistent with the ADA and the Department's coordination regulation under section 504, 28 CFR part 41. The coordination regulation specifically requires nondiscrimination in employment, 28 CFR 41.52-41.55, and does not limit coverage based on size of employer. Moreover, under all section 504 implementing regulations issued in accordance with the Department's coordination regulation, employment coverage under section 504 extends to all employers with federally assisted programs or activities, regardless of size, and the effective date for those employment requirements has always been the same as the effective date for nonemployment requirements established in the same regulations. The Department therefore concludes that § 35.140 must apply to all public entities upon the effective date of this regulation.

In the proposed regulation the Department cross-referenced the regulations implementing title I of the ADA, issued by the Equal Employment Opportunity Commission at 29 CFR part 1630, as a compliance standard for § 35.140 because, as proposed, the scope of coverage and effective date of coverage under title II would have been coextensive with title I. In the final regulation this language is modified slightly Subparagraph (1) of new

paragraph (b) makes it clear that the standards established by the Equal Employment Opportunity Commission in 29 CFR part 1630 will be the applicable compliance standards if the public entity is subject to title I. If the public entity is not covered by title I, or until it is covered by title I, subparagraph (b)(2) cross-references section 504 standards for what constitutes employment discrimination, as established by the Department of Justice in 28 CFR part 41. Standards for title I of the ADA and section 504 of the Rehabilitation Act are for the most part identical because title I of the ADA was based on requirements set forth in regulations implementing section 504.

The Department, together with the other Federal agencies responsible for the enforcement of Federal laws prohibiting employment discrimination on the basis of disability, recognizes the potential for jurisdictional overlap that exists with respect to coverage of public entities and the need to avoid problems related to overlapping coverage. The other Federal agencies include the Equal Employment Opportunity Commission, which is the agency primarily responsible for enforcement of title I of the ADA, the Department of Labor, which is the agency responsible for enforcement of section 503 of the Rehabilitation Act of 1973, and 26 Federal agencies with programs of Federal financial assistance, which are responsible for enforcing section 504 in those programs. Section 107 of the ADA requires that coordination mechanisms be developed in connection with the administrative enforcement of complaints alleging discrimination under title I and complaints alleging discrimination in employment in violation of the Rehabilitation Act. Although the ADA does not specifically require inclusion of employment complaints under title II in the coordinating mechanisms required by title I, Federal investigations of title II employment complaints will be coordinated on a government-wide basis also. The Department is currently working with the EEOC and other affected Federal agencies to develop effective coordinating mechanisms, and final regulations on this issue will be issued on or before January 26, 1992.

Subpart D—Program Accessibility

Section 35.149 Discrimination Prohibited

Section 35.149 states the general nondiscrimination principle underlying the program accessibility requirements of §§ 35.150 and 35.151.

Section 35.150 Existing Facilities

Consistent with section 204(b) of the Act, this regulation adopts the program accessibility concept found in the section 504 regulations for federally conducted programs or activities (e.g., 28 CFR part 39). The concept of "program accessibility" was first used in the section 504 regulation adopted by the Department of Health, Education, and Welfare for its federally assisted programs and activities in 1977. It allowed recipients to make their federally assisted programs and activities available to individuals with disabilities without extensive retrofitting of their existing buildings and facilities, by offering those programs through alternative methods. Program accessibility has proven to be a useful approach and was adopted in the regulations issued for programs and activities conducted by Federal Executive agencies. The Act provides that the concept of program access will continue to apply with respect to facilities now in existence, because the cost of retrofitting existing facilities is often prohibitive.

Section 35.150 requires that each service, program, or activity conducted by a public entity, when viewed in its entirety, be readily accessible to and usable by individuals with disabilities. The regulation makes clear, however, that a public entity is not required to make each of its existing facilities accessible (§ 35.150(a)(1)). Unlike title III of the Act, which requires public accommodations to remove architectural barriers where such removal is "readily achievable," or to provide goods and services through alternative methods, where those methods are "readily achievable," title II requires a public entity to make its programs accessible in all cases, except where to do so would result in a fundamental alteration in the nature of the program or in undue financial and administrative burdens. Congress intended the "undue burden" standard in title II to be significantly higher than the "readily achievable" standard in title III. Thus, although title II may not require removal of barriers in some cases where removal would be required under title III, the program access requirement of title II should enable individuals with disabilities to participate in and benefit from the services, programs, or activities of public entities in all but the most unusual cases.

Paragraph (a)(2), which establishes a special limitation on the obligation to ensure program accessibility in historic

preservation programs, is discussed below in connection with paragraph (b).

Paragraph (a)(3), which is taken from the section 504 regulations for federally conducted programs, generally codifies case law that defines the scope of the public entity's obligation to ensure program accessibility. This paragraph provides that, in meeting the program accessibility requirement, a public entity is not required to take any action that would result in a fundamental alteration in the nature of its service, program, or activity or in undue financial and administrative burdens. A similar limitation is provided in § 35.164.

This paragraph does not establish an absolute defense; it does not relieve a public entity of all obligations to individuals with disabilities. Although a public entity is not required to take actions that would result in a fundamental alteration in the nature of a service, program, or activity or in undue financial and administrative burdens, it nevertheless must take any other steps necessary to ensure that individuals with disabilities receive the benefits or services provided by the public entity.

It is the Department's view that compliance with § 35.150(a), like compliance with the corresponding provisions of the section 504 regulations for federally conducted programs, would in most cases not result in undue financial and administrative burdens on a public entity. In determining whether financial and administrative burdens are undue, all public entity resources available for use in the funding and operation of the service, program, or activity should be considered. The burden of proving that compliance with paragraph (a) of § 35.150 would fundamentally alter the nature of a service, program, or activity or would result in undue financial and administrative burdens rests with the public entity.

The decision that compliance would result in such alteration or burdens must be made by the head of the public entity or his or her designee and must be accompanied by a written statement of the reasons for reaching that conclusion. The Department recognizes the difficulty of identifying the official responsible for this determination, given the variety of organizational forms that may be taken by public entities and their components. The intention of this paragraph is that the determination must be made by a high level official, no lower than a Department head, having budgetary authority and responsibility for making spending decisions.

Any person who believes that he or she or any specific class of persons has been injured by the public entity head's

decision or failure to make a decision may file a complaint under the compliance procedures established in subpart F.

Paragraph (b)(1) sets forth a number of means by which program accessibility may be achieved, including redesign of equipment, reassignment of services to accessible buildings, and provision of aides.

The Department wishes to clarify that, consistent with longstanding interpretation of section 504, carrying an individual with a disability is considered an ineffective and therefore an unacceptable method for achieving program accessibility. Department of Health, Education, and Welfare, Office of Civil Rights, Policy Interpretation No. 4, 43 FR 36035 (August 14, 1978). Carrying will be permitted only in manifestly exceptional cases, and only if all personnel who are permitted to participate in carrying an individual with a disability are formally instructed on the safest and least humiliating means of carrying. "Manifestly exceptional" cases in which carrying would be permitted might include, for example, programs conducted in unique facilities, such as an oceanographic vessel, for which structural changes and devices necessary to adapt the facility for use by individuals with mobility impairments are unavailable or prohibitively expensive. Carrying is not permitted as an alternative to structural modifications such as installation of a ramp or a chairlift.

In choosing among methods, the public entity shall give priority consideration to those that will be consistent with provision of services in the most integrated setting appropriate to the needs of individuals with disabilities. Structural changes in existing facilities are required only when there is no other feasible way to make the public entity's program accessible. (It should be noted that "structural changes" include all physical changes to a facility; the term does not refer only to changes to structural features, such as removal of or alteration to a load-bearing structural member.) The requirements of § 35.151 for alterations apply to structural changes undertaken to comply with this section. The public entity may comply with the program accessibility requirement by delivering services at alternate accessible sites or making home visits as appropriate.

Historic Preservation Programs

In order to avoid possible conflict between the congressional mandates to preserve historic properties, on the one

hand, and to eliminate discrimination against individuals with disabilities on the other, paragraph (a)(2) provides that a public entity is not required to take any action that would threaten or destroy the historic significance of an historic property. The special limitation on program accessibility set forth in paragraph (a)(2) is applicable only to historic preservation programs, as defined in § 35.104, that is, programs that have preservation of historic properties as a primary purpose. Narrow application of the special limitation is justified because of the inherent flexibility of the program accessibility requirement. Where historic preservation is not a primary purpose of the program, the public entity is not required to use a particular facility. It can relocate all or part of its program to an accessible facility, make home visits, or use other standard methods of achieving program accessibility without making structural alterations that might threaten or destroy significant historic features of the historic property. Thus, government programs located in historic properties, such as an historic State Capitol, are not excused from the requirement for program access.

Paragraph (a)(2), therefore, will apply only to those programs that uniquely concern the preservation and experience of the historic property itself. Because the primary benefit of an historic preservation program is the experience of the historic property, paragraph (b)(2) requires the public entity to give priority to methods of providing program accessibility that permit individuals with disabilities to have physical access to the historic property. This priority on physical access may also be viewed as a specific application of the general requirement that the public entity administer programs in the most integrated setting appropriate to the needs of qualified individuals with disabilities (§ 35.130(d)). Only when providing physical access would threaten or destroy the historic significance of an historic property, or would result in a fundamental alteration in the nature of the program or in undue financial and administrative burdens, may the public entity adopt alternative methods for providing program accessibility that do not ensure physical access. Examples of some alternative methods are provided in paragraph (b)(2).

Time Periods

Paragraphs (c) and (d) establish time periods for complying with the program accessibility requirement. Like the regulations for federally assisted

programs (e.g., 28 CFR 41.57(b)), paragraph (c) requires the public entity to make any necessary structural changes in facilities as soon as practicable, but in no event later than three years after the effective date of this regulation.

The proposed rule provided that, aside from structural changes, all other necessary steps to achieve compliance with this part must be taken within sixty days. The sixty day period was taken from regulations implementing section 504, which generally were effective no more than thirty days after publication. Because this regulation will not be effective until January 26, 1992, the Department has concluded that no additional transition period for non-structural changes is necessary, so the sixty day period has been omitted in the final rule. Of course, this section does not reduce or eliminate any obligations that are already applicable to a public entity under section 504.

Where structural modifications are required, paragraph (d) requires that a transition plan be developed by an entity that employs 50 or more persons, within six months of the effective date of this regulation. The legislative history of title II of the ADA makes it clear that, under title II, "local and state governments are required to provide curb cuts on public streets." Education and Labor report at 84. As the rationale for the provision of curb cuts, the House report explains, "The employment, transportation, and public accommodation sections of * * * (the ADA) would be meaningless if people who use wheelchairs were not afforded the opportunity to travel on and between the streets." Id. Section 35.151(e), which establishes accessibility requirements for new construction and alterations, requires that all newly constructed or altered streets, roads, or highways must contain curb ramps or other sloped areas at any intersection having curbs or other barriers to entry from a street level pedestrian walkway, and all newly constructed or altered street level pedestrian walkways must have curb ramps or other sloped areas at intersections to streets, roads, or highways. A new paragraph (d)(2) has been added to the final rule to clarify the application of the general requirement for program accessibility to the provision of curb cuts at existing crosswalks. This paragraph requires that the transition plan include a schedule for providing curb ramps or other sloped areas at existing pedestrian walkways, giving priority to walkways serving entities covered by the Act, including State and local government offices and

facilities, transportation, public accommodations, and employers, followed by walkways serving other areas. Pedestrian "walkways" include locations where access is required for use of public transportation, such as bus stops that are not located at intersections or crosswalks.

Similarly, a public entity should provide an adequate number of accessible parking spaces in existing parking lots or garages over which it has jurisdiction.

Paragraph (d)(3) provides that, if a public entity has already completed a transition plan required by a regulation implementing section 504, the transition plan required by this part will apply only to those policies and practices that were not covered by the previous transition plan. Some commenters suggested that the transition plan should include all aspects of the public entity's operations, including those that may have been covered by a previous transition plan under section 504. The Department believes that such a duplicative requirement would be inappropriate. Many public entities may find, however, that it will be simpler to include all of their operations in the transition plan than to attempt to identify and exclude specifically those that were addressed in a previous plan. Of course, entities covered under section 504 are not shielded from their obligations under that statute merely because they are included under the transition plan developed under this section.

Section 35.151 New Construction and Alterations

Section 35.151 provides that those buildings that are constructed or altered by, on behalf of, or for the use of a public entity shall be designed, constructed, or altered to be readily accessible to and usable by individuals with disabilities if the construction was commenced after the effective date of this part. Facilities under design on that date will be governed by this section if the date that bids were invited falls after the effective date. This interpretation is consistent with Federal practice under section 504.

Section 35.151(c) establishes two standards for accessible new construction and alteration. Under paragraph (c), design, construction, or alteration of facilities in conformance with the Uniform Federal Accessibility Standards (UFAS) or with the Americans with Disabilities Act Accessibility Guidelines for Buildings and Facilities (hereinafter ADAAG) shall be deemed to comply with the requirements of this section with respect

to those facilities except that, if ADAAG is chosen, the elevator exemption contained at §§ 36.401(d) and 36.404 does not apply. ADAAG is the standard for private buildings and was issued as guidelines by the Architectural and Transportation Barriers Compliance Board (ATBCB) under title III of the ADA. It has been adopted by the Department of Justice and is published as appendix A to the Department's title III rule in today's Federal Register. Departures from particular requirements of these standards by the use of other methods shall be permitted when it is clearly evident that equivalent access to the facility or part of the facility is thereby provided. Use of two standards is a departure from the proposed rule.

The proposed rule adopted UFAS as the only interim accessibility standard because that standard was referenced by the regulations implementing section 504 of the Rehabilitation Act promulgated by most Federal funding agencies. It is, therefore, familiar to many State and local government entities subject to this rule. The Department, however, received many comments objecting to the adoption of UFAS. Commenters pointed out that, except for the elevator exemption, UFAS is not as stringent as ADAAG. Others suggested that the standard should be the same to lessen confusion.

Section 204(b) of the Act states that title II regulations must be consistent not only with section 504 regulations but also with "this Act." Based on this provision, the Department has determined that a public entity should be entitled to choose to comply either with ADAAG or UFAS.

Public entities who choose to follow ADAAG, however, are not entitled to the elevator exemption contained in title III of the Act and implemented in the title III regulation at § 36.401(d) for new construction and § 36.404 for alterations. Section 303(b) of title III states that, with some exceptions, elevators are not required in facilities that are less than three stories or have less than 3000 square feet per story. The section 504 standard, UFAS, contains no such exemption. Section 501 of the ADA makes clear that nothing in the Act may be construed to apply a lesser standard to public entities than the standards applied under section 504. Because permitting the elevator exemption would clearly result in application of a lesser standard than that applied under section 504, paragraph (c) states that the elevator exemption does not apply when public entities choose to follow ADAAG. Thus, a two-story courthouse, whether built according to UFAS or

ADAAG, must be constructed with an elevator. It should be noted that Congress did not include an elevator exemption for public transit facilities covered by subtitle B of title II, which covers public transportation provided by public entities, providing further evidence that Congress intended that public buildings have elevators.

Section 504 of the ADA requires the ATBCB to issue supplemental Minimum Guidelines and Requirements for Accessible Design of buildings and facilities subject to the Act, including title II. Section 204(c) of the ADA provides that the Attorney General shall promulgate regulations implementing title II that are consistent with the ATBCB's ADA guidelines. The ATBCB has announced its intention to issue title II guidelines in the future. The Department anticipates that, after the ATBCB's title II guidelines have been published, this rule will be amended to adopt new accessibility standards consistent with the ATBCB's rulemaking. Until that time, however, public entities will have a choice of following UFAS or ADAAG, without the elevator exemption.

Existing buildings leased by the public entity after the effective date of this part are not required by the regulation to meet accessibility standards simply by virtue of being leased. They are subject, however, to the program accessibility standard for existing facilities in § 35.150. To the extent the buildings are newly constructed or altered, they must also meet the new construction and alteration requirements of § 35.151.

The Department received many comments urging that the Department require that public entities lease only accessible buildings. Federal practice under section 504 has always treated newly leased buildings as subject to the existing facility program accessibility standard. Section 204(b) of the Act states that, in the area of "program accessibility, existing facilities," the title II regulations must be consistent with section 504 regulations. Thus, the Department has adopted the section 504 principles for these types of leased buildings. Unlike the construction of new buildings where architectural barriers can be avoided at little or no cost, the application of new construction standards to an existing building being leased raises the same prospect of retrofitting buildings as the use of an existing Federal facility, and the same program accessibility standard should apply to both owned and leased existing buildings. Similarly, requiring that public entities only lease accessible space would significantly restrict the

options of State and local governments in seeking leased space, which would be particularly burdensome in rural or sparsely populated areas.

On the other hand, the more accessible the leased space is, the fewer structural modifications will be required in the future for particular employees whose disabilities may necessitate barrier removal as a reasonable accommodation. Pursuant to the requirements for leased buildings contained in the Minimum Guidelines and Requirements for Accessible Design published under the Architectural Barriers Act by the ATBCB, 36 CFR 1190.34, the Federal Government may not lease a building unless it contains (1) One accessible route from an accessible entrance to those areas in which the principal activities for which the building is leased are conducted, (2) accessible toilet facilities, and (3) accessible parking facilities, if a parking area is included within the lease (36 CFR 1190.34). Although these requirements are not applicable to buildings leased by public entities covered by this regulation, such entities are encouraged to look for the most accessible space available to lease and to attempt to find space complying at least with these minimum Federal requirements.

Section 35.151(d) gives effect to the intent of Congress, expressed in section 504(c) of the Act, that this part recognize the national interest in preserving significant historic structures. Commenters criticized the Department's use of descriptive terms in the proposed rule that are different from those used in the ADA to describe eligible historic properties. In addition, some commenters criticized the Department's decision to use the concept of "substantially impairing" the historic features of a property, which is a concept employed in regulations implementing section 504 of the Rehabilitation Act of 1973. Those commenters recommended that the Department adopt the criteria of "adverse effect" published by the Advisory Council on Historic Preservation under the National Historic Preservation Act, 36 CFR 800.9, as the standard for determining whether an historic property may be altered.

The Department agrees with these comments to the extent that they suggest that the language of the rule should conform to the language employed by Congress in the ADA. A definition of "historic property," drawn from section 504 of the ADA, has been added to § 35.104 to clarify that the term applies to those properties listed or eligible for

listing in the National Register of Historic Places, or properties designated as historic under State or local law.

The Department intends that the exception created by this section be applied only in those very rare situations in which it is not possible to provide access to an historic property using the special access provisions established by UFAS and ADAAG. Therefore, paragraph (d)(1) of § 35.151 has been revised to clearly state that alterations to historic properties shall comply, to the maximum extent feasible, with section 4.1.7 of UFAS or section 4.1.7 of ADAAG. Paragraph (d)(2) has been revised to provide that, if it has been determined under the procedures established in UFAS and ADAAG that it is not feasible to provide physical access to an historic property in a manner that will not threaten or destroy the historic significance of the property, alternative methods of access shall be provided pursuant to the requirements of § 35.150.

In response to comments, the Department has added to the final rule a new paragraph (e) setting out the requirements of § 36.151 as applied to curb ramps. Paragraph (e) is taken from the statement contained in the preamble to the proposed rule that all newly constructed or altered streets, roads, and highways must contain curb ramps at any intersection having curbs or other barriers to entry from a street level pedestrian walkway, and that all newly constructed or altered street level pedestrian walkways must have curb ramps at intersections to streets, roads, or highways.

Subpart E—Communications

Section 35.160 General

Section 35.160 requires the public entity to take such steps as may be necessary to ensure that communications with applicants, participants, and members of the public with disabilities are as effective as communications with others.

Paragraph (b)(1) requires the public entity to furnish appropriate auxiliary aids and services when necessary to afford an individual with a disability an equal opportunity to participate in, and enjoy the benefits of, the public entity's service, program, or activity. The public entity must provide an opportunity for individuals with disabilities to request the auxiliary aids and services of their choice. This expressed choice shall be given primary consideration by the public entity (§ 35.160(b)(2)). The public entity shall honor the choice unless it can demonstrate that another effective

means of communication exists or that use of the means chosen would not be required under § 35.164.

Deference to the request of the individual with a disability is desirable because of the range of disabilities, the variety of auxiliary aids and services, and different circumstances requiring effective communication. For instance, some courtrooms are now equipped for "computer-assisted transcripts," which allow virtually instantaneous transcripts of courtroom argument and testimony to appear on displays. Such a system might be an effective auxiliary aid or service for a person who is deaf or has a hearing loss who uses speech to communicate, but may be useless for someone who uses sign language.

Although in some circumstances a notepad and written materials may be sufficient to permit effective communication, in other circumstances they may not be sufficient. For example, a qualified interpreter may be necessary when the information being communicated is complex, or is exchanged for a lengthy period of time. Generally, factors to be considered in determining whether an interpreter is required include the context in which the communication is taking place, the number of people involved, and the importance of the communication.

Several commenters asked that the rule clarify that the provision of readers is sometimes necessary to ensure access to a public entity's services, programs or activities. Reading devices or readers should be provided when necessary for equal participation and opportunity to benefit from any governmental service, program, or activity, such as reviewing public documents, examining demonstrative evidence, and filling out voter registration forms or forms needed to receive public benefits. The importance of providing qualified readers for examinations administered by public entities is discussed under § 35.130. Reading devices and readers are appropriate auxiliary aids and services where necessary to permit an individual with a disability to participate in or benefit from a service, program, or activity.

Section 35.160(b)(2) of the proposed rule, which provided that a public entity need not furnish individually prescribed devices, readers for personal use or study, or other devices of a personal nature, has been deleted in favor of a new section in the final rule on personal devices and services (see § 35.135).

In response to comments, the term "auxiliary aids and services" is used in place of "auxiliary aids" in the final rule. This phrase better reflects the

range of aids and services that may be required under this section.

A number of comments raised questions about the extent of a public entity's obligation to provide access to television programming for persons with hearing impairments. Television and videotape programming produced by public entities are covered by this section. Access to audio portions of such programming may be provided by closed captioning.

Section 35.161 Telecommunication Devices for the Deaf (TDD's)

Section 35.161 requires that, where a public entity communicates with applicants and beneficiaries by telephone, TDD's or equally effective telecommunication systems be used to communicate with individuals with impaired speech or hearing.

Problems arise when a public entity which does not have a TDD needs to communicate with an individual who uses a TDD or vice versa. Title IV of the ADA addresses this problem by requiring establishment of telephone relay services to permit communications between individuals who communicate by TDD and individuals who communicate by the telephone alone. The relay services required by title IV would involve a relay operator using both a standard telephone and a TDD to type the voice messages to the TDD user and read the TDD messages to the standard telephone user.

Section 204(b) of the ADA requires that the regulation implementing title II with respect to communications be consistent with the Department's regulation implementing section 504 for its federally conducted programs and activities at 28 CFR part 39. Section 35.161, which is taken from § 39.160(a)(2) of that regulation, requires the use of TDD's or equally effective telecommunication systems for communication with people who use TDD's. Of course, where relay services, such as those required by title IV of the ADA are available, a public entity may use those services to meet the requirements of this section.

Many commenters were concerned that public entities should not rely heavily on the establishment of relay services. The commenters explained that while relay services would be of vast benefit to both public entities and individuals who use TDD's, the services are not sufficient to provide access to all telephone services. First, relay systems do not provide effective access to the increasingly popular automated systems that require the caller to respond by pushing a button on a touch tone phone. Second, relay systems cannot operate

fast enough to convey messages on answering machines, or to permit a TDD user to leave a recorded message. Third, communication through relay systems may not be appropriate in cases of crisis lines pertaining to rape, domestic violence, child abuse, and drugs. The Department believes that it is more appropriate for the Federal Communications Commission to address these issues in its rulemaking under title IV.

Some commenters requested that those entities with frequent contacts with clients who use TDD's have on-site TDD's to provide for direct communication between the entity and the individual. The Department encourages those entities that have extensive telephone contact with the public such as city halls, public libraries, and public aid offices, to have TDD's to insure more immediate access. Where the provision of telephone service is a major function of the entity, TDD's should be available.

Section 35.162 Telephone Emergency Services

Many public entities provide telephone emergency services by which individuals can seek immediate assistance from police, fire, ambulance, and other emergency services. These telephone emergency services—including "911" services—are clearly an important public service whose reliability can be a matter of life or death. The legislative history of title II specifically reflects congressional intent that public entities must ensure that telephone emergency services, including 911 services, be accessible to persons with impaired hearing and speech through telecommunication technology (Conference report at 67; Education and Labor report at 84-85).

Proposed § 35.162 mandated that public entities provide emergency telephone services to persons with disabilities that are "functionally equivalent" to voice services provided to others. Many commenters urged the Department to revise the section to make clear that direct access to telephone emergency services is required by title II of the ADA as indicated by the legislative history (Conference report at 67-68; Education and Labor report at 85). In response, the final rule mandates "direct access," instead of "access that is functionally equivalent" to that provided to all other telephone users. Telephone emergency access through a third party or through a relay service would not satisfy the requirement for direct access.

Several commenters asked about a separate seven-digit emergency call number for the 911 services. The requirement for direct access disallows the use of a separate seven-digit number where 911 service is available. Separate seven-digit emergency call numbers would be unfamiliar to many individuals and also more burdensome to use. A standard emergency 911 number is easier to remember and would save valuable time spent in searching in telephone books for a local seven-digit emergency number.

Many commenters requested the establishment of minimum standards of service (e.g., the quantity and location of TDD's and computer modems needed in a given emergency center). Instead of establishing these scoping requirements, the Department has established a performance standard through the mandate for direct access.

Section 35.162 requires public entities to take appropriate steps, including equipping their emergency systems with modern technology, as may be necessary to promptly receive and respond to a call from users of TDD's and computer modems. Entities are allowed the flexibility to determine what is the appropriate technology for their particular needs. In order to avoid mandating use of particular technologies that may become outdated, the Department has eliminated the references to the Baudot and ASCII formats in the proposed rule.

Some commenters requested that the section require the installation of a voice amplification device on the handset of the dispatcher's telephone to amplify the dispatcher's voice. In an emergency, a person who has a hearing loss may be using a telephone that does not have an amplification device. Installation of speech amplification devices on the handsets of the dispatchers' telephones would respond to that situation. The Department encourages their use.

Several commenters emphasized the need for proper maintenance of TDD's used in telephone emergency services. Section 35.133, which mandates maintenance of accessible features, requires public entities to maintain in operable working condition TDD's and other devices that provide direct access to the emergency system.

Section 35.163 Information and Signage

Section 35.163(a) requires the public entity to provide information to individuals with disabilities concerning accessible services, activities, and facilities. Paragraph (b) requires the public entity to provide signage at all

inaccessible entrances to each of its facilities that directs users to an accessible entrance or to a location with information about accessible facilities.

Several commenters requested that, where TDD-equipped pay phones or portable TDD's exist, clear signage should be posted indicating the location of the TDD. The Department believes that this is required by paragraph (a). In addition, the Department recommends that, in large buildings that house TDD's, directional signage indicating the location of available TDD's should be placed adjacent to banks of telephones that do not contain a TDD.

Section 35.164 Duties

Section 35.164, like paragraph (a)(3) of § 35.150, is taken from the section 504 regulations for federally conducted programs. Like paragraph (a)(3), it limits the obligation of the public entity to ensure effective communication in accordance with *Davis* and the circuit court opinions interpreting it. It also includes specific requirements for determining the existence of undue financial and administrative burdens. The preamble discussion of § 35.150(a) regarding that determination is applicable to this section and further explains the public entity's obligation to comply with §§ 35.160-35.164. Because of the essential nature of the services provided by telephone emergency systems, the Department assumes that § 35.164 will rarely be applied to § 35.162.

Subpart F—Compliance Procedures

Subpart F sets out the procedures for administrative enforcement of this part. Section 203 of the Act provides that the remedies, procedures, and rights set forth in section 505 of the Rehabilitation Act of 1973 (29 U.S.C. 794a) for enforcement of section 504 of the Rehabilitation Act, which prohibits discrimination on the basis of handicap in programs and activities that receive Federal financial assistance, shall be the remedies, procedures, and rights for enforcement of title II. Section 505, in turn, incorporates by reference the remedies, procedures, and rights set forth in title VI of the Civil Rights Act of 1964 (42 U.S.C. 2000d to 2000d-4a). Title VI, which prohibits discrimination on the basis of race, color, or national origin in federally assisted programs, is enforced by the Federal agencies that provide the Federal financial assistance to the covered programs and activities in question. If voluntary compliance cannot be achieved, Federal agencies enforce title VI either by the termination of Federal funds to a program that is found to discriminate, following an

administrative hearing, or by a referral to this Department for judicial enforcement.

Title II of the ADA extended the requirements of section 504 to all services, programs, and activities of State and local governments, not only those that receive Federal financial assistance. The House Committee on Education and Labor explained the enforcement provisions as follows:

It is the Committee's intent that administrative enforcement of section 202 of the legislation should closely parallel the Federal government's experience with section 504 of the Rehabilitation Act of 1973. The Attorney General should use section 504 enforcement procedures and the Department's coordination role under Executive Order 12250 as models for regulation in this area.

The Committee envisions that the Department of Justice will identify appropriate Federal agencies to oversee compliance activities for State and local governments. As with section 504, these Federal agencies, including the Department of Justice, will receive, investigate, and where possible, resolve complaints of discrimination. If a Federal agency is unable to resolve a complaint by voluntary means, . . . the major enforcement sanction for the Federal government will be referral of cases by these Federal agencies to the Department of Justice.

The Department of Justice may then proceed to file suits in Federal district court. As with section 504, there is also a private right of action for persons with disabilities, which includes the full panoply of remedies. Again, consistent with section 504, it is not the Committee's intent that persons with disabilities need to exhaust Federal administrative remedies before exercising their private right of action.

Education & Labor report at 98. See also S. Rep. No. 116, 101st Cong., 1st Sess., at 57-58 (1989).

Subpart F effectuates the congressional intent by deferring to section 504 procedures where those procedures are applicable, that is, where a Federal agency has jurisdiction under section 504 by virtue of its provision of Federal financial assistance to the program or activity in which the discrimination is alleged to have occurred. Deferral to the 504 procedures also makes the sanction of fund termination available where necessary to achieve compliance. Because the Civil Rights Restoration Act (Pub. L. 100-259) extended the application of section 504 to all of the operations of the public entity receiving the Federal financial assistance, many activities of State and local governments are already covered by section 504. The procedures in subpart F apply to complaints concerning services, programs, and

activities of public entities that are covered by the ADA.

Subpart G designates the Federal agencies responsible for enforcing the ADA with respect to specific components of State and local government. It does not, however, displace existing jurisdiction under section 504 of the various funding agencies. Individuals may still file discrimination complaints against recipients of Federal financial assistance with the agencies that provide that assistance, and the funding agencies will continue to process those complaints under their existing procedures for enforcing section 504. The substantive standards adopted in this part for title II of the ADA are generally the same as those required under section 504 for federally assisted programs, and public entities covered by the ADA are also covered by the requirements of section 504 to the extent that they receive Federal financial assistance. To the extent that title II provides greater protection to the rights of individuals with disabilities, however, the funding agencies will also apply the substantive requirements established under title II and this part in processing complaints covered by both this part and section 504, except that fund termination procedures may be used only for violations of section 504.

Subpart F establishes the procedures to be followed by the agencies designated in subpart G for processing complaints against State and local government entities when the designated agency does not have jurisdiction under section 504.

Section 35.170 Complaints

Section 35.170 provides that any individual who believes that he or she or a specific class of individuals has been subjected to discrimination on the basis of disability by a public entity may, by himself or herself or by an authorized representative, file a complaint under this part within 180 days of the date of the alleged discrimination, unless the time for filing is extended by the agency for good cause. Although § 35.107 requires public entities that employ 50 or more persons to establish grievance procedures for resolution of complaints, exhaustion of those procedures is not a prerequisite to filing a complaint under this section. If a complainant chooses to follow the public entity's grievance procedures, however, any resulting delay may be considered good cause for extending the time allowed for filing a complaint under this part.

Filing the complaint with any Federal agency will satisfy the requirement for timely filing. As explained below, a

complaint filed with an agency that has jurisdiction under section 504 will be processed under the agency's procedures for enforcing section 504.

Some commenters objected to the complexity of allowing complaints to be filed with different agencies. The multiplicity of enforcement jurisdiction is the result of following the statutorily mandated enforcement scheme. The Department has, however, attempted to simplify procedures for complainants by making the Federal agency that receives the complaint responsible for referring it to an appropriate agency.

The Department has also added a new paragraph (c) to this section providing that a complaint may be filed with any agency designated under subpart G of this part, or with any agency that provides funding to the public entity that is the subject of the complaint, or with the Department of Justice. Under § 35.171(a)(2), the Department of Justice will refer complaints for which it does not have jurisdiction under section 504 to an agency that does have jurisdiction under section 504, or to the agency designated under subpart G as responsible for complaints filed against the public entity that is the subject of the complaint or in the case of an employment complaint that is also subject to title I of the Act, to the Equal Employment Opportunity Commission. Complaints filed with the Department of Justice may be sent to the Coordination and Review Section, P.O. Box 66118, Civil Rights Division, U.S. Department of Justice, Washington, DC 20035-6118.

Section 35.171 Acceptance of Complaints

Section 35.171 establishes procedures for determining jurisdiction and responsibility for processing complaints against public entities. The final rule provides complainants an opportunity to file with the Federal funding agency of their choice. If that agency does not have jurisdiction under section 504, however, and is not the agency designated under subpart G as responsible for that public entity, the agency must refer the complaint to the Department of Justice, which will be responsible for referring it either to an agency that does have jurisdiction under section 504 or to the appropriate designated agency, or in the case of an employment complaint that is also subject to title I of the Act, to the Equal Employment Opportunity Commission.

Whenever an agency receives a complaint over which it has jurisdiction under section 504, it will process the complaint under its section 504 procedures. When the agency designated under subpart G receives a

complaint for which it does not have jurisdiction under section 504, it will treat the complaint as an ADA complaint under the procedures established in this subpart.

Section 35.171 also describes agency responsibilities for the processing of employment complaints. As described in connection with § 35.140, additional procedures regarding the coordination of employment complaints will be established in a coordination regulation issued by DOJ and EEOC. Agencies with jurisdiction under section 504 for complaints alleging employment discrimination also covered by title I will follow the procedures established by the coordination regulation for those complaints. Complaints covered by title I but not section 504 will be referred to the EEOC, and complaints covered by this part but not title I will be processed under the procedures in this part.

Section 35.172 Resolution of Complaints

Section 35.172 requires the designated agency to either resolve the complaint or issue to the complainant and the public entity a Letter of Findings containing findings of fact and conclusions of law and a description of a remedy for each violation found.

The Act requires the Department of Justice to establish administrative procedures for resolution of complaints, but does not require complainants to exhaust these administrative remedies. The Committee Reports make clear that Congress intended to provide a private right of action with the full panoply of remedies for individual victims of discrimination. Because the Act does not require exhaustion of administrative remedies, the complainant may elect to proceed with a private suit at any time.

Section 35.173 Voluntary Compliance Agreements

Section 35.173 requires the agency to attempt to resolve all complaints in which it finds noncompliance through voluntary compliance agreements enforceable by the Attorney General.

Section 35.174 Referral

Section 35.174 provides for referral of the matter to the Department of Justice if the agency is unable to obtain voluntary compliance.

Section 35.175 Attorney's Fees

Section 35.175 states that courts are authorized to award attorneys fees, including litigation expenses and costs, as provided in section 505 of the Act. Litigation expenses include items such as expert witness fees, travel expenses,

etc. The Judiciary Committee Report specifies that such items are included under the rubric of "attorneys fees" and not "costs" so that such expenses will be assessed against a plaintiff only under the standard set forth in *Christiansburg Garment Co. v. Equal Employment Opportunity Commission*, 434 U.S. 412 (1978). (Judiciary report at 73.)

Section 35.176 Alternative Means of Dispute Resolution

Section 35.176 restates section 513 of the Act, which encourages use of alternative means of dispute resolution.

Section 35.177 Effect of Unavailability of Technical Assistance

Section 35.177 explains that, as provided in section 506(e) of the Act, a public entity is not excused from compliance with the requirements of this part because of any failure to receive technical assistance.

Section 35.178 State Immunity

Section 35.178 restates the provision of section 502 of the Act that a State is not immune under the eleventh amendment to the Constitution of the United States from an action in Federal or State court for violations of the Act, and that the same remedies are available for any such violations as are available in an action against an entity other than a State.

Subpart G—Designated Agencies

Section 35.190 Designated Agencies

Subpart G designates the Federal agencies responsible for investigating complaints under this part. At least 26 agencies currently administer programs of Federal financial assistance that are subject to the nondiscrimination requirements of section 504 as well as other civil rights statutes. A majority of these agencies administer modest programs of Federal financial assistance and/or devote minimal resources exclusively to "external" civil rights enforcement activities. Under Executive Order 12250, the Department of Justice has encouraged the use of delegation agreements under which certain civil rights compliance responsibilities for a class of recipients funded by more than one agency are delegated by an agency or agencies to a "lead" agency. For example, many agencies that fund institutions of higher education have signed agreements that designate the Department of Education as the "lead" agency for this class of recipients.

The use of delegation agreements reduces overlap and duplication of effort, and thereby strengthens overall civil rights enforcement. However, the

use of these agreements to date generally has been limited to education and health care recipients. These classes of recipients are funded by numerous agencies and the logical connection to a lead agency is clear (e.g., the Department of Education for colleges and universities, and the Department of Health and Human Services for hospitals).

The ADA's expanded coverage of State and local government operations further complicates the process of establishing Federal agency jurisdiction for the purpose of investigating complaints of discrimination on the basis of disability. Because all operations of public entities now are covered irrespective of the presence or absence of Federal financial assistance, many additional State and local government functions and organizations now are subject to Federal jurisdiction. In some cases, there is no historical or single clear-cut subject matter relationship with a Federal agency as was the case in the education example described above. Further, the 33,000 governmental jurisdictions subject to the ADA differ greatly in their organization, making a detailed and workable division of Federal agency jurisdiction by individual State, county, or municipal entity unrealistic.

This regulation applies the delegation concept to the investigation of complaints of discrimination on the basis of disability by public entities under the ADA. It designates eight agencies, rather than all agencies currently administering programs of Federal financial assistance, as responsible for investigating complaints under this part. These "designated agencies" generally have the largest civil rights compliance staffs, the most experience in complaint investigations and disability issues, and broad yet clear subject area responsibilities. This division of responsibilities is made functionally rather than by public entity type or name designation. For example, all entities (regardless of their title) that exercise responsibilities, regulate, or administer services or programs relating to lands and natural resources fall within the jurisdiction of the Department of Interior.

Complaints under this part will be investigated by the designated agency most closely related to the functions exercised by the governmental component against which the complaint is lodged. For example, a complaint against a State medical board, where such a board is a recognizable entity, will be investigated by the Department of Health and Human Services (the designated agency for regulatory

activities relating to the provision of health care), even if the board is part of a general umbrella department of planning and regulation (for which the Department of Justice is the designated agency). If two or more agencies have apparent responsibility over a complaint, § 35.190(c) provides that the Assistant Attorney General shall determine which one of the agencies shall be the designated agency for purposes of that complaint.

Thirteen commenters, including four proposed designated agencies, addressed the Department of Justice's identification in the proposed regulation of nine "designated agencies" to investigate complaints under this part. Most comments addressed the proposed specific delegations to the various individual agencies. The Department of Justice agrees with several commenters who pointed out that responsibility for "historic and cultural preservation" functions appropriately belongs with the Department of Interior rather than the Department of Education. The Department of Justice also agrees with the Department of Education that "museums" more appropriately should be delegated to the Department of Interior, and that "preschool and daycare programs" more appropriately should be assigned to the Department of Health and Human Services, rather than to the Department of Education. The final rule reflects these decisions.

The Department of Commerce opposed its listing as the designated agency for "commerce and industry, including general economic development, banking and finance, consumer protection, insurance, and small business". The Department of Commerce cited its lack of a substantial existing section 504 enforcement program and experience with many of the specific functions to be delegated. The Department of Justice accedes to the Department of Commerce's position, and has assigned itself as the designated agency for these functions.

In response to a comment from the Department of Health and Human Services, the regulation's category of "medical and nursing schools" has been clarified to read "schools of medicine, dentistry, nursing, and other health-related fields". Also in response to a comment from the Department of Health and Human Services, "correctional institutions" have been specifically added to the public safety and administration of justice functions assigned to the Department of Justice.

The regulation also assigns the Department of Justice as the designated agency responsible for all State and

local government functions not assigned to other designated agencies. The Department of Justice, under an agreement with the Department of the Treasury, continues to receive and coordinate the investigation of complaints filed under the Revenue Sharing Act. This entitlement program, which was terminated in 1986, provided civil rights compliance jurisdiction for a wide variety of complaints regarding the use of Federal funds to support various general activities of local governments. In the absence of any similar program of Federal financial assistance administered by another Federal agency, placement of designated agency responsibilities for miscellaneous and otherwise undesignated functions with the Department of Justice is an appropriate continuation of current practice.

The Department of Education objected to the proposed rule's inclusion of the functional area of "arts and humanities" within its responsibilities, and the Department of Housing and Urban Development objected to its proposed designation as responsible for activities relating to rent control, the real estate industry, and housing code enforcement. The Department has deleted these areas from the lists assigned to the Departments of Education and Housing and Urban Development, respectively, and has added a new paragraph (c) to § 35.190, which provides that the Department of Justice may assign responsibility for components of State or local governments that exercise responsibilities, regulate, or administer services, programs, or activities relating to functions not assigned to specific designated agencies by paragraph (b) of this section to other appropriate agencies. The Department believes that this approach will provide more flexibility in determining the appropriate agency for investigation of complaints involving those components of State and local governments not specifically addressed by the listings in paragraph (b). As provided in §§ 35.170 and 35.171, complaints filed with the Department of Justice will be referred to the appropriate agency.

Several commenters proposed a stronger role for the Department of Justice, especially with respect to the receipt and assignment of complaints, and the overall monitoring of the effectiveness of the enforcement activities of Federal agencies. As discussed above, §§ 35.170 and 35.171 have been revised to provide for referral of complaints by the Department of Justice to appropriate enforcement

agencies. Also, language has been added to § 35.190(a) of the final regulation stating that the Assistant Attorney General shall provide policy guidance and interpretations to designated agencies to ensure the consistent and effective implementation of this part.

List of Subjects in 28 CFR Part 35

Administrative practice and procedure, Alcoholism, Americans with disabilities, Buildings, Civil rights, Drug abuse, Handicapped, Historic preservation, Intergovernmental relations, Reporting and recordkeeping requirements.

By the authority vested in me as Attorney General by 28 U.S.C. 509, 510, 5 U.S.C. 301, and section 204 of the Americans with Disabilities Act, and for the reasons set forth in the preamble, chapter I of title 28 of the Code of Federal Regulations is amended by adding a new part 35 to read as follows:

PART 35—NONDISCRIMINATION ON THE BASIS OF DISABILITY IN STATE AND LOCAL GOVERNMENT SERVICES

Subpart A—General

- Sec.
- 35.101 Purpose.
 - 35.102 Application.
 - 35.103 Relationship to other laws.
 - 35.104 Definitions.
 - 35.105 Self-evaluation.
 - 35.106 Notice.
 - 35.107 Designation of responsible employee and adoption of grievance procedures.
 - 35.108–35.129 [Reserved]

Subpart B—General Requirements

- 35.130 General prohibitions against discrimination.
- 35.131 Illegal use of drugs.
- 35.132 Smoking.
- 35.133 Maintenance of accessible features.
- 35.134 Retaliation or coercion.
- 35.135 Personal devices and services.
- 35.136–35.139 [Reserved]

Subpart C—Employment

- 35.140 Employment discrimination prohibited.
- 35.141–35.148 [Reserved]

Subpart D—Program Accessibility

- 35.149 Discrimination prohibited.
- 35.150 Existing facilities.
- 35.151 New construction and alterations.
- 35.152–35.159 [Reserved]

Subpart E—Communications

- 35.160 General.
- 35.161 Telecommunication devices for the deaf (TDD's).
- 35.162 Telephone emergency services.
- 35.163 Information and signage.
- 35.164 Duties.
- 35.165–35.169 [Reserved]

Subpart F—Compliance Procedures

- 35.170 Complaints.
- 35.171 Acceptance of complaints.
- 35.172 Resolution of complaints.
- 35.173 Voluntary compliance agreements.
- 35.174 Referral.
- 35.175 Attorney's fees.
- 35.176 Alternative means of dispute resolution.
- 35.177 Effect of unavailability of technical assistance.
- 35.178 State immunity.
- 35.179–35.189 [Reserved]

Subpart G—Designated Agencies

- 35.190 Designated agencies.
- 35.191–35.999 [Reserved]

Appendix A to Part 35—Preamble to Regulation on Nondiscrimination on the Basis of Disability in State and Local Government Services (Published July 26, 1991)

Authority: 5 U.S.C. 301; 28 U.S.C. 509, 510; Title II, Pub. L. 101-336 (42 U.S.C. 12134).

Subpart A—General

§ 35.101 Purpose.

The purpose of this part is to effectuate subtitle A of title II of the Americans with Disabilities Act of 1990, (42 U.S.C. 12131), which prohibits discrimination on the basis of disability by public entities.

§ 35.102 Application.

(a) Except as provided in paragraph (b) of this section, this part applies to all services, programs, and activities provided or made available by public entities.

(b) To the extent that public transportation services, programs, and activities of public entities are covered by subtitle B of title II of the ADA (42 U.S.C. 12141), they are not subject to the requirements of this part.

§ 35.103 Relationship to other laws.

(a) *Rule of interpretation.* Except as otherwise provided in this part, this part shall not be construed to apply a lesser standard than the standards applied under title V of the Rehabilitation Act of 1973 (29 U.S.C. 791) or the regulations issued by Federal agencies pursuant to that title.

(b) *Other laws.* This part does not invalidate or limit the remedies, rights, and procedures of any other Federal laws, or State or local laws (including State common law) that provide greater or equal protection for the rights of individuals with disabilities or individuals associated with them.

§ 35.104 Definitions.

For purposes of this part, the term—
Act means the Americans with Disabilities Act (Pub. L. 101-336, 104

Stat. 327, 42 U.S.C. 12101-12213 and 47 U.S.C. 225 and 611).

Assistant Attorney General means the Assistant Attorney General, Civil Rights Division, United States Department of Justice.

Auxiliary aids and services includes—

(1) Qualified interpreters, notetakers, transcription services, written materials, telephone handset amplifiers, assistive listening devices, assistive listening systems, telephones compatible with hearing aids, closed caption decoders, open and closed captioning, telecommunications devices for deaf persons (TDD's), videotext displays, or other effective methods of making aurally delivered materials available to individuals with hearing impairments;

(2) Qualified readers, taped texts, audio recordings, Brailled materials, large print materials, or other effective methods of making visually delivered materials available to individuals with visual impairments;

(3) Acquisition or modification of equipment or devices; and

(4) Other similar services and actions.

Complete complaint means a written statement that contains the complainant's name and address and describes the public entity's alleged discriminatory action in sufficient detail to inform the agency of the nature and date of the alleged violation of this part. It shall be signed by the complainant or by someone authorized to do so on his or her behalf. Complaints filed on behalf of classes or third parties shall describe or identify (by name, if possible) the alleged victims of discrimination.

Current illegal use of drugs means illegal use of drugs that occurred recently enough to justify a reasonable belief that a person's drug use is current or that continuing use is a real and ongoing problem.

Designated agency means the Federal agency designated under subpart G of this part to oversee compliance activities under this part for particular components of State and local governments.

Disability means, with respect to an individual, a physical or mental impairment that substantially limits one or more of the major life activities of such individual; a record of such an impairment; or being regarded as having such an impairment.

(1)(i) The phrase *physical or mental impairment* means—

(A) Any physiological disorder or condition, cosmetic disfigurement, or anatomical loss affecting one or more of the following body systems: Neurological, musculoskeletal, special sense organs, respiratory (including

speech organs), cardiovascular, reproductive, digestive, genitourinary, hemic and lymphatic, skin, and endocrine;

(B) Any mental or psychological disorder such as mental retardation, organic brain syndrome, emotional or mental illness, and specific learning disabilities.

(ii) The phrase *physical or mental impairment* includes, but is not limited to, such contagious and noncontagious diseases and conditions as orthopedic, visual, speech and hearing impairments, cerebral palsy, epilepsy, muscular dystrophy, multiple sclerosis, cancer, heart disease, diabetes, mental retardation, emotional illness, specific learning disabilities, HIV disease (whether symptomatic or asymptomatic), tuberculosis, drug addiction, and alcoholism.

(iii) The phrase *physical or mental impairment* does not include homosexuality or bisexuality.

(2) The phrase *major life activities* means functions such as caring for one's self, performing manual tasks, walking, seeing, hearing, speaking, breathing, learning, and working.

(3) The phrase *has a record of such an impairment* means has a history of, or has been misclassified as having, a mental or physical impairment that substantially limits one or more major life activities.

(4) The phrase *is regarded as having an impairment* means—

(i) Has a physical or mental impairment that does not substantially limit major life activities but that is treated by a public entity as constituting such a limitation;

(ii) Has a physical or mental impairment that substantially limits major life activities only as a result of the attitudes of others toward such impairment; or

(iii) Has none of the impairments defined in paragraph (1) of this definition but is treated by a public entity as having such an impairment.

(5) The term *disability* does not include—

(i) Transvestism, transsexualism, pedophilia, exhibitionism, voyeurism, gender identity disorders not resulting from physical impairments, or other sexual behavior disorders;

(ii) Compulsive gambling, kleptomania, or pyromania; or

(iii) Psychoactive substance use disorders resulting from current illegal use of drugs.

Drug means a controlled substance, as defined in schedules I through V of section 202 of the Controlled Substances Act (21 U.S.C. 812).

Facility means all or any portion of buildings, structures, sites, complexes, equipment, rolling stock or other conveyances, roads, walks, passageways, parking lots, or other real or personal property, including the site where the building, property, structure, or equipment is located.

Historic preservation programs means programs conducted by a public entity that have preservation of historic properties as a primary purpose.

Historic Properties means those properties that are listed or eligible for listing in the National Register of Historic Places or properties designated as historic under State or local law.

Illegal use of drugs means the use of one or more drugs, the possession or distribution of which is unlawful under the Controlled Substances Act (21 U.S.C. 812). The term *illegal use of drugs* does not include the use of a drug taken under supervision by a licensed health care professional, or other uses authorized by the Controlled Substances Act or other provisions of Federal law.

Individual with a disability means a person who has a disability. The term *individual with a disability* does not include an individual who is currently engaging in the illegal use of drugs, when the public entity acts on the basis of such use.

Public entity means—

(1) Any State or local government;

(2) Any department, agency, special purpose district, or other instrumentality of a State or States or local government; and

(3) The National Railroad Passenger Corporation, and any commuter authority (as defined in section 103(8) of the Rail Passenger Service Act).

Qualified individual with a disability means an individual with a disability who, with or without reasonable modifications to rules, policies, or practices, the removal of architectural, communication, or transportation barriers, or the provision of auxiliary aids and services, meets the essential eligibility requirements for the receipt of services or the participation in programs or activities provided by a public entity.

Qualified interpreter means an interpreter who is able to interpret effectively, accurately, and impartially both receptively and expressively, using any necessary specialized vocabulary.

Section 504 means section 504 of the Rehabilitation Act of 1973 (Pub. L. 93-112, 87 Stat. 394 (29 U.S.C. 794)), as amended.

State means each of the several States, the District of Columbia, the Commonwealth of Puerto Rico, Guam, American Samoa, the Virgin Islands, the

Trust Territory of the Pacific Islands, and the Commonwealth of the Northern Mariana Islands.

§ 35.105 Self-evaluation.

(a) A public entity shall, within one year of the effective date of this part, evaluate its current services, policies, and practices, and the effects thereof, that do not or may not meet the requirements of this part and, to the extent modification of any such services, policies, and practices is required, the public entity shall proceed to make the necessary modifications.

(b) A public entity shall provide an opportunity to interested persons, including individuals with disabilities or organizations representing individuals with disabilities, to participate in the self-evaluation process by submitting comments.

(c) A public entity that employs 50 or more persons shall, for at least three years following completion of the self-evaluation, maintain on file and make available for public inspection:

- (1) A list of the interested persons consulted;
- (2) A description of areas examined and any problems identified; and
- (3) A description of any modifications made.

(d) If a public entity has already complied with the self-evaluation requirement of a regulation implementing section 504 of the Rehabilitation Act of 1973, then the requirements of this section shall apply only to those policies and practices that were not included in the previous self-evaluation.

§ 35.106 Notice.

A public entity shall make available to applicants, participants, beneficiaries, and other interested persons information regarding the provisions of this part and its applicability to the services, programs, or activities of the public entity, and make such information available to them in such manner as the head of the entity finds necessary to apprise such persons of the protections against discrimination assured them by the Act and this part.

§ 35.107 Designation of responsible employee and adoption of grievance procedures.

(a) *Designation of responsible employee.* A public entity that employs 50 or more persons shall designate at least one employee to coordinate its efforts to comply with and carry out its responsibilities under this part, including any investigation of any complaint communicated to it alleging its noncompliance with this part or

alleging any actions that would be prohibited by this part. The public entity shall make available to all interested individuals the name, office address, and telephone number of the employee or employees designated pursuant to this paragraph.

(b) *Complaint procedure.* A public entity that employs 50 or more persons shall adopt and publish grievance procedures providing for prompt and equitable resolution of complaints alleging any action that would be prohibited by this part.

§§ 35.108-35.129 [Reserved]

Subpart B—General Requirements

§ 35.130 General prohibitions against discrimination.

(a) No qualified individual with a disability shall, on the basis of disability, be excluded from participation in or be denied the benefits of the services, programs, or activities of a public entity, or be subjected to discrimination by any public entity.

(b) (1) A public entity, in providing any aid, benefit, or service, may not, directly or through contractual, licensing, or other arrangements, on the basis of disability—

- (i) Deny a qualified individual with a disability the opportunity to participate in or benefit from the aid, benefit, or service;
- (ii) Afford a qualified individual with a disability an opportunity to participate in or benefit from the aid, benefit, or service that is not equal to that afforded others;
- (iii) Provide a qualified individual with a disability with an aid, benefit, or service that is not as effective in affording equal opportunity to obtain the same result, to gain the same benefit, or to reach the same level of achievement as that provided to others;
- (iv) Provide different or separate aids, benefits, or services to individuals with disabilities or to any class of individuals with disabilities than is provided to others unless such action is necessary to provide qualified individuals with disabilities with aids, benefits, or services that are as effective as those provided to others;
- (v) Aid or perpetuate discrimination against a qualified individual with a disability by providing significant assistance to an agency, organization, or person that discriminates on the basis of disability in providing any aid, benefit, or service to beneficiaries of the public entity's program;
- (vi) Deny a qualified individual with a disability the opportunity to participate as a member of planning or advisory boards;

(vii) Otherwise limit a qualified individual with a disability in the enjoyment of any right, privilege, advantage, or opportunity enjoyed by others receiving the aid, benefit, or service.

(2) A public entity may not deny a qualified individual with a disability the opportunity to participate in services, programs, or activities that are not separate or different, despite the existence of permissibly separate or different programs or activities.

(3) A public entity may not, directly or through contractual or other arrangements, utilize criteria or methods of administration:

(i) That have the effect of subjecting qualified individuals with disabilities to discrimination on the basis of disability;

(ii) That have the purpose or effect of defeating or substantially impairing accomplishment of the objectives of the public entity's program with respect to individuals with disabilities; or

(iii) That perpetuate the discrimination of another public entity if both public entities are subject to common administrative control or are agencies of the same State.

(4) A public entity may not, in determining the site or location of a facility, make selections—

(i) That have the effect of excluding individuals with disabilities from, denying them the benefits of, or otherwise subjecting them to discrimination; or

(ii) That have the purpose or effect of defeating or substantially impairing the accomplishment of the objectives of the service, program, or activity with respect to individuals with disabilities.

(5) A public entity, in the selection of procurement contractors, may not use criteria that subject qualified individuals with disabilities to discrimination on the basis of disability.

(6) A public entity may not administer a licensing or certification program in a manner that subjects qualified individuals with disabilities to discrimination on the basis of disability, nor may a public entity establish requirements for the programs or activities of licensees or certified entities that subject qualified individuals with disabilities to discrimination on the basis of disability. The programs or activities of entities that are licensed or certified by a public entity are not, themselves, covered by this part.

(7) A public entity shall make reasonable modifications in policies, practices, or procedures when the modifications are necessary to avoid discrimination on the basis of disability,

unless the public entity can demonstrate that making the modifications would fundamentally alter the nature of the service, program, or activity.

(8) A public entity shall not impose or apply eligibility criteria that screen out or tend to screen out an individual with a disability or any class of individuals with disabilities from fully and equally enjoying any service, program, or activity, unless such criteria can be shown to be necessary for the provision of the service, program, or activity being offered.

(c) Nothing in this part prohibits a public entity from providing benefits, services, or advantages to individuals with disabilities, or to a particular class of individuals with disabilities beyond those required by this part.

(d) A public entity shall administer services, programs, and activities in the most integrated setting appropriate to the needs of qualified individuals with disabilities.

(e)(1) Nothing in this part shall be construed to require an individual with a disability to accept an accommodation, aid, service, opportunity, or benefit provided under the ADA or this part which such individual chooses not to accept.

(2) Nothing in the Act or this part authorizes the representative or guardian of an individual with a disability to decline food, water, medical treatment, or medical services for that individual.

(f) A public entity may not place a surcharge on a particular individual with a disability or any group of individuals with disabilities to cover the costs of measures, such as the provision of auxiliary aids or program accessibility, that are required to provide that individual or group with the nondiscriminatory treatment required by the Act or this part.

(g) A public entity shall not exclude or otherwise deny equal services, programs, or activities to an individual or entity because of the known disability of an individual with whom the individual or entity is known to have a relationship or association.

§ 35.131 Illegal use of drugs.

(a) *General.* (1) Except as provided in paragraph (b) of this section, this part does not prohibit discrimination against an individual based on that individual's current illegal use of drugs.

(2) A public entity shall not discriminate on the basis of illegal use of drugs against an individual who is not engaging in current illegal use of drugs and who—

(i) Has successfully completed a supervised drug rehabilitation program

or has otherwise been rehabilitated successfully;

(ii) Is participating in a supervised rehabilitation program; or

(iii) Is erroneously regarded as engaging in such use.

(b) *Health and drug rehabilitation services.* (1) A public entity shall not deny health services, or services provided in connection with drug rehabilitation, to an individual on the basis of that individual's current illegal use of drugs, if the individual is otherwise entitled to such services.

(2) A drug rehabilitation or treatment program may deny participation to individuals who engage in illegal use of drugs while they are in the program.

(c) *Drug testing.* (1) This part does not prohibit a public entity from adopting or administering reasonable policies or procedures, including but not limited to drug testing, designed to ensure that an individual who formerly engaged in the illegal use of drugs is not now engaging in current illegal use of drugs.

(2) Nothing in paragraph (c) of this section shall be construed to encourage, prohibit, restrict, or authorize the conduct of testing for the illegal use of drugs.

§ 35.132 Smoking.

This part does not preclude the prohibition of, or the imposition of restrictions on, smoking in transportation covered by this part.

§ 35.133 Maintenance of accessible features.

(a) A public accommodation shall maintain in operable working condition those features of facilities and equipment that are required to be readily accessible to and usable by persons with disabilities by the Act or this part.

(b) This section does not prohibit isolated or temporary interruptions in service or access due to maintenance or repairs.

§ 35.134 Retaliation or coercion.

(a) No private or public entity shall discriminate against any individual because that individual has opposed any act or practice made unlawful by this part, or because that individual made a charge, testified, assisted, or participated in any manner in an investigation, proceeding, or hearing under the Act or this part.

(b) No private or public entity shall coerce, intimidate, threaten, or interfere with any individual in the exercise or enjoyment of, or on account of his or her having exercised or enjoyed, or on account of his or her having aided or encouraged any other individual in the

exercise or enjoyment of, any right granted or protected by the Act or this part.

§ 35.135 Personal devices and services.

This part does not require a public entity to provide to individuals with disabilities personal devices, such as wheelchairs; individually prescribed devices, such as prescription eyeglasses or hearing aids; readers for personal use or study; or services of a personal nature including assistance in eating, toileting, or dressing.

§§ 35.136-35.139 [Reserved]

Subpart C—Employment

§ 35.140 Employment discrimination prohibited.

(a) No qualified individual with a disability shall, on the basis of disability, be subjected to discrimination in employment under any service, program, or activity conducted by a public entity.

(b)(1) For purposes of this part, the requirements of title I of the Act, as established by the regulations of the Equal Employment Opportunity Commission in 29 CFR part 1630, apply to employment in any service, program, or activity conducted by a public entity if that public entity is also subject to the jurisdiction of title I.

(2) For the purposes of this part, the requirements of section 504 of the Rehabilitation Act of 1973, as established by the regulations of the Department of Justice in 28 CFR part 41, as those requirements pertain to employment, apply to employment in any service, program, or activity conducted by a public entity if that public entity is not also subject to the jurisdiction of title I.

§§ 35.141-35.148 [Reserved]

Subpart D—Program Accessibility

§ 35.149 Discrimination prohibited.

Except as otherwise provided in § 35.150, no qualified individual with a disability shall, because a public entity's facilities are inaccessible to or unusable by individuals with disabilities, be excluded from participation in, or be denied the benefits of the services, programs, or activities of a public entity, or be subjected to discrimination by any public entity.

§ 35.150 Existing facilities.

(a) *General.* A public entity shall operate each service, program, or activity so that the service, program, or activity, when viewed in its entirety, is readily accessible to and usable by

individuals with disabilities. This paragraph does not—

(1) Necessarily require a public entity to make each of its existing facilities accessible to and usable by individuals with disabilities;

(2) Require a public entity to take any action that would threaten or destroy the historic significance of an historic property; or

(3) Require a public entity to take any action that it can demonstrate would result in a fundamental alteration in the nature of a service, program, or activity or in undue financial and administrative burdens. In those circumstances where personnel of the public entity believe that the proposed action would fundamentally alter the service, program, or activity or would result in undue financial and administrative burdens, a public entity has the burden of proving that compliance with § 35.150(a) of this part would result in such alteration or burdens. The decision that compliance would result in such alteration or burdens must be made by the head of a public entity or his or her designee after considering all resources available for use in the funding and operation of the service, program, or activity, and must be accompanied by a written statement of the reasons for reaching that conclusion. If an action would result in such an alteration or such burdens, a public entity shall take any other action that would not result in such an alteration or such burdens but would nevertheless ensure that individuals with disabilities receive the benefits or services provided by the public entity.

(b) *Methods*—(1) *General*. A public entity may comply with the requirements of this section through such means as redesign of equipment, reassignment of services to accessible buildings, assignment of aides to beneficiaries, home visits, delivery of services at alternate accessible sites, alteration of existing facilities and construction of new facilities, use of accessible rolling stock or other conveyances, or any other methods that result in making its services, programs, or activities readily accessible to and usable by individuals with disabilities. A public entity is not required to make structural changes in existing facilities where other methods are effective in achieving compliance with this section. A public entity, in making alterations to existing buildings, shall meet the accessibility requirements of § 35.151. In choosing among available methods for meeting the requirements of this section, a public entity shall give priority to those methods that offer services, programs, and activities to qualified

individuals with disabilities in the most integrated setting appropriate.

(2) *Historic preservation programs*. In meeting the requirements of § 35.150(a) in historic preservation programs, a public entity shall give priority to methods that provide physical access to individuals with disabilities. In cases where a physical alteration to an historic property is not required because of paragraph (a)(2) or (a)(3) of this section, alternative methods of achieving program accessibility include—

(i) Using audio-visual materials and devices to depict those portions of an historic property that cannot otherwise be made accessible;

(ii) Assigning persons to guide individuals with handicaps into or through portions of historic properties that cannot otherwise be made accessible; or

(iii) Adopting other innovative methods.

(c) *Time period for compliance*. Where structural changes in facilities are undertaken to comply with the obligations established under this section, such changes shall be made within three years of January 26, 1992, but in any event as expeditiously as possible.

(d) *Transition plan*. (1) In the event that structural changes to facilities will be undertaken to achieve program accessibility, a public entity that employs 50 or more persons shall develop, within six months of January 26, 1992, a transition plan setting forth the steps necessary to complete such changes. A public entity shall provide an opportunity to interested persons, including individuals with disabilities or organizations representing individuals with disabilities, to participate in the development of the transition plan by submitting comments. A copy of the transition plan shall be made available for public inspection.

(2) If a public entity has responsibility or authority over streets, roads, or walkways, its transition plan shall include a schedule for providing curb ramps or other sloped areas where pedestrian walks cross curbs, giving priority to walkways serving entities covered by the Act, including State and local government offices and facilities, transportation, places of public accommodation, and employers, followed by walkways serving other areas.

(3) The plan shall, at a minimum—

(i) Identify physical obstacles in the public entity's facilities that limit the accessibility of its programs or activities to individuals with disabilities;

(ii) Describe in detail the methods that will be used to make the facilities accessible;

(iii) Specify the schedule for taking the steps necessary to achieve compliance with this section and, if the time period of the transition plan is longer than one year, identify steps that will be taken during each year of the transition period; and

(iv) Indicate the official responsible for implementation of the plan.

(4) If a public entity has already complied with the transition plan requirement of a Federal agency regulation implementing section 504 of the Rehabilitation Act of 1973, then the requirements of this paragraph (d) shall apply only to those policies and practices that were not included in the previous transition plan.

§ 35.151 New construction and alterations.

(a) *Design and construction*. Each facility or part of a facility constructed by, on behalf of, or for the use of a public entity shall be designed and constructed in such manner that the facility or part of the facility is readily accessible to and usable by individuals with disabilities, if the construction was commenced after January 26, 1992.

(b) *Alteration*. Each facility or part of a facility altered by, on behalf of, or for the use of a public entity in a manner that affects or could affect the usability of the facility or part of the facility shall, to the maximum extent feasible, be altered in such manner that the altered portion of the facility is readily accessible to and usable by individuals with disabilities, if the alteration was commenced after January 26, 1992.

(c) *Accessibility standards*. Design, construction, or alteration of facilities in conformance with the Uniform Federal Accessibility Standards (UFAS) (Appendix A to 41 CFR part 101-19.6) or with the Americans with Disabilities Act Accessibility Guidelines for Buildings and Facilities (ADAAG) (Appendix A to 28 CFR part 36) shall be deemed to comply with the requirements of this section with respect to those facilities, except that the elevator exemption contained at section 4.1.3(5) and section 4.1.6(1)(j) of ADAAG shall not apply. Departures from particular requirements of either standard by the use of other methods shall be permitted when it is clearly evident that equivalent access to the facility or part of the facility is thereby provided.

(d) *Alterations: Historic properties*. (1) Alterations to historic properties shall comply, to the maximum extent feasible, with section 4.1.7 of UFAS or section 4.1.7 of ADAAG.

(2) If it is not feasible to provide physical access to an historic property in a manner that will not threaten or destroy the historic significance of the building or facility, alternative methods of access shall be provided pursuant to the requirements of § 35.150.

(e) *Curb ramps.* (1) Newly constructed or altered streets, roads, and highways must contain curb ramps or other sloped areas at any intersection having curbs or other barriers to entry from a street level pedestrian walkway.

(2) Newly constructed or altered street level pedestrian walkways must contain curb ramps or other sloped areas at intersections to streets, roads, or highways.

§§ 35.152-35.159 [Reserved]

Subpart E—Communications

§ 35.160 General.

(a) A public entity shall take appropriate steps to ensure that communications with applicants, participants, and members of the public with disabilities are as effective as communications with others.

(b)(1) A public entity shall furnish appropriate auxiliary aids and services where necessary to afford an individual with a disability an equal opportunity to participate in, and enjoy the benefits of, a service, program, or activity conducted by a public entity.

(2) In determining what type of auxiliary aid and service is necessary, a public entity shall give primary consideration to the requests of the individual with disabilities.

§ 35.161 Telecommunication devices for the deaf (TDD's).

Where a public entity communicates by telephone with applicants and beneficiaries, TDD's or equally effective telecommunication systems shall be used to communicate with individuals with impaired hearing or speech.

§ 35.162 Telephone emergency services.

Telephone emergency services, including 911 services, shall provide direct access to individuals who use TDD's and computer modems.

§ 35.163 Information and signage.

(a) A public entity shall ensure that interested persons, including persons with impaired vision or hearing, can obtain information as to the existence and location of accessible services, activities, and facilities.

(b) A public entity shall provide signage at all inaccessible entrances to each of its facilities, directing users to an accessible entrance or to a location at which they can obtain information

about accessible facilities. The international symbol for accessibility shall be used at each accessible entrance of a facility.

§ 35.164 Duties.

This subpart does not require a public entity to take any action that it can demonstrate would result in a fundamental alteration in the nature of a service, program, or activity or in undue financial and administrative burdens. In those circumstances where personnel of the public entity believe that the proposed action would fundamentally alter the service, program, or activity or would result in undue financial and administrative burdens, a public entity has the burden of proving that compliance with this subpart would result in such alteration or burdens. The decision that compliance would result in such alteration or burdens must be made by the head of the public entity or his or her designee after considering all resources available for use in the funding and operation of the service, program, or activity and must be accompanied by a written statement of the reasons for reaching that conclusion. If an action required to comply with this subpart would result in such an alteration or such burdens, a public entity shall take any other action that would not result in such an alteration or such burdens but would nevertheless ensure that, to the maximum extent possible, individuals with disabilities receive the benefits or services provided by the public entity.

§§ 35.165-35.169 [Reserved]

Subpart F—Compliance Procedures

§ 35.170 Complaints.

(a) *Who may file.* An individual who believes that he or she or a specific class of individuals has been subjected to discrimination on the basis of disability by a public entity may, by himself or herself or by an authorized representative, file a complaint under this part.

(b) *Time for filing.* A complaint must be filed not later than 180 days from the date of the alleged discrimination, unless the time for filing is extended by the designated agency for good cause shown. A complaint is deemed to be filed under this section on the date it is first filed with any Federal agency.

(c) *Where to file.* An individual may file a complaint with any agency that he or she believes to be the appropriate agency designated under subpart G of this part, or with any agency that provides funding to the public entity that is the subject of the complaint, or with

the Department of Justice for referral as provided in § 35.171(a)(2).

§ 35.171 Acceptance of complaints.

(a) *Receipt of complaints.* (1)(i) Any Federal agency that receives a complaint of discrimination on the basis of disability by a public entity shall promptly review the complaint to determine whether it has jurisdiction over the complaint under section 504.

(ii) If the agency does not have section 504 jurisdiction, it shall promptly determine whether it is the designated agency under subpart G of this part responsible for complaints filed against that public entity.

(2)(i) If an agency other than the Department of Justice determines that it does not have section 504 jurisdiction and is not the designated agency, it shall promptly refer the complaint, and notify the complainant that it is referring the complaint to the Department of Justice.

(ii) When the Department of Justice receives a complaint for which it does not have jurisdiction under section 504 and is not the designated agency, it shall refer the complaint to an agency that does have jurisdiction under section 504 or to the appropriate agency designated in subpart G of this part or, in the case of an employment complaint that is also subject to title I of the Act, to the Equal Employment Opportunity Commission.

(3)(i) If the agency that receives a complaint has section 504 jurisdiction, it shall process the complaint according to its procedures for enforcing section 504.

(ii) If the agency that receives a complaint does not have section 504 jurisdiction, but is the designated agency, it shall process the complaint according to the procedures established by this subpart.

(b) *Employment complaints.* (1) If a complaint alleges employment discrimination subject to title I of the Act, and the agency has section 504 jurisdiction, the agency shall follow the procedures issued by the Department of Justice and the Equal Employment Opportunity Commission under section 107(b) of the Act.

(2) If a complaint alleges employment discrimination subject to title I of the Act, and the designated agency does not have section 504 jurisdiction, the agency shall refer the complaint to the Equal Employment Opportunity Commission for processing under title I of the Act.

(3) Complaints alleging employment discrimination subject to this part, but not to title I of the Act shall be processed in accordance with the procedures established by this subpart.

(c) *Complete complaints.* (1) A designated agency shall accept all

complete complaints under this section and shall promptly notify the complainant and the public entity of the receipt and acceptance of the complaint.

(2) If the designated agency receives a complaint that is not complete, it shall notify the complainant and specify the additional information that is needed to make the complaint a complete complaint. If the complainant fails to complete the complaint, the designated agency shall close the complaint without prejudice.

§ 35.172 Resolution of complaints.

(a) The designated agency shall investigate each complete complaint, attempt informal resolution, and, if resolution is not achieved, issue to the complainant and the public entity a Letter of Findings that shall include—

- (1) Findings of fact and conclusions of law;
- (2) A description of a remedy for each violation found; and
- (3) Notice of the rights available under paragraph (b) of this section.

(b) If the designated agency finds noncompliance, the procedures in §§ 35.173 and 35.174 shall be followed. At any time, the complainant may file a private suit pursuant to section 203 of the Act, whether or not the designated agency finds a violation.

§ 35.173 Voluntary compliance agreements.

(a) When the designated agency issues a noncompliance Letter of Findings, the designated agency shall—

(1) Notify the Assistant Attorney General by forwarding a copy of the Letter of Findings to the Assistant Attorney General; and

(2) Initiate negotiations with the public entity to secure compliance by voluntary means.

(b) Where the designated agency is able to secure voluntary compliance, the voluntary compliance agreement shall—

- (1) Be in writing and signed by the parties;
- (2) Address each cited violation;
- (3) Specify the corrective or remedial action to be taken, within a stated period of time, to come into compliance;
- (4) Provide assurance that discrimination will not recur; and
- (5) Provide for enforcement by the Attorney General.

§ 35.174 Referral.

If the public entity declines to enter into voluntary compliance negotiations or if negotiations are unsuccessful, the designated agency shall refer the matter to the Attorney General with a recommendation for appropriate action.

§ 35.175 Attorney's fees.

In any action or administrative proceeding commenced pursuant to the Act or this part, the court or agency, in its discretion, may allow the prevailing party, other than the United States, a reasonable attorney's fee, including litigation expenses, and costs, and the United States shall be liable for the foregoing the same as a private individual.

§ 35.176 Alternative means of dispute resolution.

Where appropriate and to the extent authorized by law, the use of alternative means of dispute resolution, including settlement negotiations, conciliation, facilitation, mediation, factfinding, minitrials, and arbitration, is encouraged to resolve disputes arising under the Act and this part.

§ 35.177 Effect of unavailability of technical assistance.

A public entity shall not be excused from compliance with the requirements of this part because of any failure to receive technical assistance, including any failure in the development or dissemination of any technical assistance manual authorized by the Act.

§ 35.178 State immunity.

A State shall not be immune under the eleventh amendment to the Constitution of the United States from an action in Federal or State court of competent jurisdiction for a violation of this Act. In any action against a State for a violation of the requirements of this Act, remedies (including remedies both at law and in equity) are available for such a violation to the same extent as such remedies are available for such a violation in an action against any public or private entity other than a State.

§§ 35.179-35.189 [Reserved]

Subpart G—Designated Agencies

§ 35.190 Designated agencies.

(a) The Assistant Attorney General shall coordinate the compliance activities of Federal agencies with respect to State and local government components, and shall provide policy guidance and interpretations to designated agencies to ensure the consistent and effective implementation of the requirements of this part.

(b) The Federal agencies listed in paragraph (b) (1) through (8) of this section shall have responsibility for the implementation of subpart F of this part for components of State and local governments that exercise responsibilities, regulate, or administer

services, programs, or activities in the following functional areas.

(1) *Department of Agriculture:* All programs, services, and regulatory activities relating to farming and the raising of livestock, including extension services.

(2) *Department of Education:* All programs, services, and regulatory activities relating to the operation of elementary and secondary education systems and institutions, institutions of higher education and vocational education (other than schools of medicine, dentistry, nursing, and other health-related schools), and libraries.

(3) *Department of Health and Human Services:* All programs, services, and regulatory activities relating to the provision of health care and social services, including schools of medicine, dentistry, nursing, and other health-related schools, the operation of health care and social service providers and institutions, including "grass-roots" and community services organizations and programs, and preschool and daycare programs.

(4) *Department of Housing and Urban Development:* All programs, services, and regulatory activities relating to state and local public housing, and housing assistance and referral.

(5) *Department of Interior:* All programs, services, and regulatory activities relating to lands and natural resources, including parks and recreation, water and waste management, environmental protection, energy, historic and cultural preservation, and museums.

(6) *Department of Justice:* All programs, services, and regulatory activities relating to law enforcement, public safety, and the administration of justice, including courts and correctional institutions; commerce and industry, including general economic development, banking and finance, consumer protection, insurance, and small business; planning, development, and regulation (unless assigned to other designated agencies); state and local government support services (e.g., audit, personnel, comptroller, administrative services); all other government functions not assigned to other designated agencies.

(7) *Department of Labor:* All programs, services, and regulatory activities relating to labor and the work force.

(8) *Department of Transportation:* All programs, services, and regulatory activities relating to transportation, including highways, public transportation, traffic management (non-

law enforcement), automobile licensing and inspection, and driver licensing.

(c) Responsibility for the implementation of subpart F of this part for components of State or local governments that exercise responsibilities, regulate, or administer services, programs, or activities relating to functions not assigned to specific designated agencies by paragraph (b) of this section may be assigned to other specific agencies by the Department of Justice.

(d) If two or more agencies have apparent responsibility over a

complaint, the Assistant Attorney General shall determine which one of the agencies shall be the designated agency for purposes of that complaint.

§§ 35.191-35.999 [Reserved]

Appendix A to Part 35—Preamble to Regulation on Nondiscrimination on the Basis of Disability in State and Local Government Services (Published July 26, 1991)

Note: For the convenience of the reader, this appendix contains the text of the preamble to the final regulation on nondiscrimination on the basis of disability in State and local government services

beginning at the heading "Section-by-Section Analysis" and ending before "List of Subjects in 28 CFR Part 35" (56 FR (INSERT FR PAGE CITATIONS); July 26, 1991).

Dated: July 17, 1991.

Dick Thornburgh,

Attorney General.

[FR Doc. 91-17368 Filed 7-25-91; 8:45 am]

BILLING CODE 4410-01-M



Federal Register

Friday
July 26, 1991

Part V

Equal Employment Opportunity Commission

29 CFR Part 1630

Equal Employment Opportunity for
Individuals With Disabilities; Final Rule

29 CFR Parts 1602 and 1627

Recordkeeping and Reporting Under Title
VII of the Civil Rights Act of 1964 and
the Americans With Disabilities Act
(ADA); Final Rule

Equal Employment Opportunity Commission

29 CFR Part 1630

Equal Employment Opportunity for Individuals With Disabilities

AGENCY: Equal Employment Opportunity Commission.

ACTION: Final rule.

SUMMARY: On July 26, 1990, the Americans With Disabilities Act (ADA) was signed into law. Section 106 of the ADA requires that the Equal Employment Opportunity Commission (EEOC) issue substantive regulations implementing title I (Employment) within one year of the date of enactment of the Act. Pursuant to this mandate, the Commission is publishing a new part 1630 to its regulations to implement title I and sections 3(2), 3(3), 501, 503, 506(e), 508, 510, and 511 of the ADA as those sections pertain to employment. New part 1630 prohibits discrimination against qualified individuals with disabilities in all aspects of employment.

EFFECTIVE DATE: July 26, 1992.

FOR FURTHER INFORMATION CONTACT: Elizabeth M. Thornton, Deputy Legal Counsel, (202) 663-4638 (voice), (202) 663-7026 (TDD) or Christopher G. Bell, Acting Associate Legal Counsel for Americans With Disabilities Act Services, (202) 663-4679 (voice), (202) 663-7026.

Copies of this final rule and interpretive appendix may be obtained by calling the Office of Communications and Legislative Affairs at (202) 663-4900. Copies in alternate formats may be obtained from the Office of Equal Employment Opportunity by calling (202) 663-4398 or (202) 663-4395 (voice) or (202) 663-4399 (TDD). The alternate formats available are: Large print, braille, electronic file on computer disk, and audio-tape.

SUPPLEMENTARY INFORMATION:

Rulemaking History

The Commission actively solicited and considered public comment in the development of part 1630. On August 1, 1990, the Commission published an advance notice of proposed rulemaking (ANPRM), 55 FR 31192, informing the public that the Commission had begun the process of developing substantive regulations pursuant to title I of the ADA and inviting comment from interested groups and individuals. The comment period ended on August 31, 1990. In response to the ANPRM, the Commission received 138 comments from various disability rights organizations, employer groups, and

individuals. Comments were also solicited at 62 ADA input meetings conducted by Commission field offices throughout the country. More than 2400 representatives from disability rights organizations and employer groups participated in these meetings.

On February 28, 1991, the Commission published a notice of proposed rulemaking (NPRM), 56 FR 8578, setting forth proposed part 1630 for public comment. The comment period ended April 29, 1991. In response to the NPRM, the Commission received 697 timely comments from interested groups and individuals. In many instances, a comment was submitted on behalf of several parties and represented the views of numerous groups, employers, or individuals with disabilities. The comments have been analyzed and considered in the development of this final rule.

Overview of Regulations

The format of part 1630 reflects congressional intent, as expressed in the legislative history, that the regulations implementing the employment provisions of the ADA be modeled on the regulations implementing section 504 of the Rehabilitation Act of 1973, as amended, 34 CFR part 104. Accordingly, in developing part 1630, the Commission has been guided by the section 504 regulations and the case law interpreting those regulations.

It is the intent of Congress that the regulations implementing the ADA be comprehensive and easily understood. Part 1630, therefore, defines terms not previously defined in the regulations implementing section 504 of the Rehabilitation Act, such as "substantially limits," "essential functions," and "reasonable accommodation." Of necessity, many of the determinations that may be required by this part must be made on a case-by-case basis. Where possible, part 1630 establishes parameters to serve as guidelines in such inquiries.

The Commission is also issuing interpretive guidance concurrently with the issuance of part 1630 in order to ensure that qualified individuals with disabilities understand their rights under this part and to facilitate and encourage compliance by covered entities. Therefore, part 1630 is accompanied by an appendix. This appendix represents the Commission's interpretation of the issues discussed, and the Commission will be guided by it when resolving charges of employment discrimination. The appendix addresses the major provisions of part 1630 and explains the major concepts of disability rights. Further, the appendix cites to the

authority, such as the legislative history of the ADA and case law interpreting section 504 of the Rehabilitation Act, that provides the basis and purpose of the rule and interpretive guidance.

More detailed guidance on specific issues will be forthcoming in the Commission's Compliance Manual. Several Compliance Manual sections and policy guidances on ADA issues are currently under development and are expected to be issued prior to the effective date of the Act. Among the issues to be addressed in depth are the theories of discrimination; definitions of disability and of qualified individual with a disability; reasonable accommodation and undue hardship, including the scope of reassignment; and pre-employment inquiries.

To assist us in the development of this guidance, the Commission requested comment in the NPRM from disability rights organizations, employers, unions, state agencies concerned with employment or workers compensation practices, and interested individuals on specific questions about insurance, workers' compensation, and collective bargaining agreements. Many commenters responded to these questions, and several commenters addressed other matters pertinent to these areas. The Commission has considered these comments in the development of the final rule and will continue to consider them as it develops further ADA guidance.

In the NPRM, the Commission raised questions about a number of insurance-related matters. Specifically, the Commission asked commenters to discuss risk assessment and classification, the relationship between "risk" and "cost," and whether employers should consider the effects that changes in insurance coverage will have on individuals with disabilities before making those changes. Many commenters provided information about insurance practices and explained some of the considerations that affect insurance decisions. In addition, some commenters discussed their experiences with insurance plans and coverage. The commenters presented a wide range of opinions on insurance-related matters, and the Commission will consider the comments as it continues to analyze these complex matters.

The Commission received a large number of comments concerning inquiries about an individual's workers' compensation history. Many employers asserted that such inquiries are job related and consistent with business necessity. Several individuals with disabilities and disability rights

organizations, however, argued that such inquiries are prohibited pre-employment inquiries and are not job related and consistent with business necessity. The Commission has addressed this issue in the interpretive guidance accompanying § 1630.14(a) and will discuss the matter further in future guidance.

There was little controversy about the submission of medical information to workers' compensation offices. A number of employers and employer groups pointed out that the workers' compensation offices of many states request medical information in connection with the administration of second-injury funds. Further, they noted that the disclosure of medical information may be necessary to the defense of a workers' compensation claim. The Commission has responded to these comments by amending the interpretive guidance accompanying § 1630.14(b). This amendment, discussed below, notes that the submission of medical information to workers' compensation offices in accordance with state workers' compensation laws is not inconsistent with § 1630.14(b). The Commission will address this area in greater detail and will discuss other issues concerning workers' compensation matters in future guidances, including the policy guidance on pre-employment inquiries.

With respect to collective bargaining agreements, the Commission asked commenters to discuss the relationship between collective bargaining agreements and such matters as undue hardship, reassignment to a vacant position, the determination of what constitutes a "vacant" position, and the confidentiality requirements of the ADA. The comments that we received reflected a wide variety of views. For example, some commenters argued that it would always be an undue hardship for an employer to provide a reasonable accommodation that conflicted with the provisions of a collective bargaining agreement. Other commenters, however, argued that an accommodation's effect on an agreement should not be considered when assessing undue hardship. Similarly, some commenters stated that the appropriateness of reassignment to a vacant position should depend upon the provisions of a collective bargaining agreement while others asserted that an agreement cannot limit the right to reassignment. Many commenters discussed the relationship between an agreement's seniority provisions and an employer's reasonable accommodation obligations.

In response to comments, the Commission has amended § 1630.2(n)(3) to include "the terms of a collective bargaining agreement" in the types of evidence relevant to determining the essential functions of a position. The Commission has made a corresponding change to the interpretive guidance on § 1630.2(n)(3). In addition, the Commission has amended the interpretive guidance on § 1630.15(d) to note that the terms of a collective bargaining agreement may be relevant to determining whether an accommodation would pose an undue hardship on the operation of a covered entity's business.

The divergent views expressed in the public comments demonstrate the complexity of employment-related issues concerning insurance, workers' compensation, and collective bargaining agreement matters. These highly complex issues require extensive research and analysis and warrant further consideration. Accordingly, the Commission has decided to address the issues in depth in future Compliance Manual sections and policy guidances. The Commission will consider the public comments that it received in response to the NPRM as it develops further guidance on the application of title I of the ADA to these matters.

The Commission has also decided to address burdens-of-proof issues in future guidance documents, including the Compliance Manual section on the theories of discrimination. Many commenters discussed the allocation of the various burdens of proof under title I of the ADA and asked the Commission to clarify those burdens. The comments in this area addressed such matters as determining whether a person is a qualified individual with a disability, job relatedness and business necessity, and undue hardship. The Commission will consider these comments as it prepares further guidance in this area.

A discussion of other significant comments and an explanation of the changes made in part 1630 since publication of the NPRM follows.

Section-by-Section Analysis of Comments and Revisions

Section 1630.1 Purpose, Applicability, and Construction

The Commission has made a technical correction to § 1630.1(a) by adding section 506(e) to the list of statutory provisions implemented by this part. Section 506(e) of the ADA provides that the failure to receive technical assistance from the federal agencies that administer the ADA is not a

defense to failing to meet the obligations of title I.

Some commenters asked the Commission to note that the ADA does not preempt state claims, such as state tort claims, that confer greater remedies than are available under the ADA. The Commission has added a paragraph to that effect in the appendix discussion of §§ 1630.1 (b) and (c). This interpretation is consistent with the legislative history of the Act. See H.R. Rep. No. 485 part 3, 101st Cong., 2d Sess. 69-70 (1990) (hereinafter referred to as House Judiciary Report).

In addition, the Commission has made a technical amendment to the appendix discussion to note that the ADA does not automatically preempt medical standards or safety requirements established by Federal law or regulations. The Commission has also amended the discussion to refer to a direct threat that cannot be eliminated "or reduced" through reasonable accommodation. This language is consistent with the regulatory definition of direct threat. (See § 1630.2(r), below.)

Section 1630.2 Definitions

Section 1630.2(h) Physical or Mental Impairment

The Commission has amended the interpretive guidance accompanying § 1630.2(h) to note that the definition of the term "impairment" does not include characteristic predisposition to illness or disease.

In addition, the Commission has specifically noted in the interpretive guidance that pregnancy is not an impairment. This change responds to the numerous questions that the Commission has received concerning whether pregnancy is a disability covered by the ADA. Pregnancy, by itself, is not an impairment and is therefore not a disability.

Section 1630.2(j) Substantially Limits

The Commission has revised the interpretive guidance accompanying § 1630.2(j) to make clear that the determination of whether an impairment substantially limits one or more major life activities is to be made without regard to the availability of medicines, assistive devices, or other mitigating measures. This interpretation is consistent with the legislative history of the ADA. See S. Rep. No. 116, 101st Cong., 1st Sess. 23 (1989) (hereinafter referred to as Senate Report); H.R. Rep. No. 485 part 2, 101st Cong., 2d Sess. 52 (1990) (hereinafter referred to as House Labor Report); House Judiciary Report at 28. The Commission has also revised the examples in the third paragraph of this

section's guidance. The examples now focus on the individual's capacity to perform major life activities rather than on the presence or absence of mitigating measures. These revisions respond to comments from disability rights groups, which were concerned that the discussion could be misconstrued to exclude from ADA coverage individuals with disabilities who function well because of assistive devices or other mitigating measures.

In an amendment to the paragraph concerning the factors to consider when determining whether an impairment is substantially limiting, the Commission has provided a second example of an impairment's "impact." This example notes that a traumatic head injury's affect on cognitive functions is the "impact" of that impairment.

Many commenters addressed the provisions concerning the definition of "substantially limits" with respect to the major life activity of working (§ 1630.2(j)(3)). Some employers generally supported the definition but argued that it should be applied narrowly. Other employers argued that the definition is too broad. Disability rights groups and individuals with disabilities, on the other hand, argued that the definition is too narrow, unduly limits coverage, and places an onerous burden on individuals seeking to establish that they are covered by the ADA. The Commission has responded to these comments by making a number of clarifications in this area.

The Commission has revised § 1630.2(j)(3)(ii) and the accompanying interpretive guidance to note that the listed factors "may" be considered when determining whether an individual is substantially limited in working. This revision clarifies that the factors are relevant to, but are not required elements of, a showing of a substantial limitation in working.

Disability rights groups asked the Commission to clarify that "substantially limited in working" applies only when an individual is not substantially limited in any other major life activity. In addition, several other commenters indicated confusion about whether and when the ability to work should be considered when assessing if an individual has a disability. In response to these comments, the Commission has amended the interpretive guidance by adding a new paragraph clarifying the circumstances under which one should determine whether an individual is substantially limited in the major life activity of working. This paragraph makes clear that a determination of whether an individual is substantially limited in the

ability to work should be made only when the individual is not disabled in any other major life activity. Thus, individuals need not establish that they are substantially limited in working if they already have established that they are, have a record of, or are regarded as being substantially limited in another major life activity.

The proposed interpretive guidance in this area provided an example concerning a surgeon with a slight hand impairment. Several commenters expressed concern about this example. Many of these comments indicated that the example confused, rather than clarified, the matter. The Commission, therefore, has deleted this example. To explain further the application of the "substantially limited in working" concept, the Commission has provided another example (concerning a commercial airline pilot) in the interpretive guidance.

In addition, the Commission has clarified that the terms "numbers and types of jobs" (see § 1630.2(j)(3)(ii)(B)) and "numbers and types of other jobs" (see § 1630.2(j)(3)(ii)(C)) do not require an onerous evidentiary showing.

In the proposed Appendix, after the interpretive guidance accompanying § 1630.2(l), the Commission included a discussion entitled "Frequently Disabling Impairments." Many commenters expressed concern about this discussion. In response to these comments, and to avoid confusion, the Commission has revised the discussion and has deleted the list of frequently disabling impairments. The revised discussion now appears in the interpretive guidance accompanying § 1630.2(j).

Section 1630.2(l) Is Regarded as Having Such an Impairment

Section 1630.2(l)(3) has been changed to refer to "a substantially limiting impairment" rather than "such an impairment." This change clarifies that an individual meets the definition of the term "disability" when a covered entity treats the individual as having a substantially limiting impairment. That is, § 1630.2(l)(3) refers to any substantially limiting impairment, rather than just to one of the impairments described in §§ 1630.2(l)(1) or (2).

The proposed interpretive guidance on § 1630.2(l) stated that, when determining whether an individual is regarded as substantially limited in working, "it should be assumed that all similar employers would apply the same exclusionary qualification standard that the employer charged with discrimination has used." The Commission specifically requested

comment on this proposal, and many commenters addressed this issue. The Commission has decided to eliminate this assumption and to revise the interpretive guidance. The guidance now explains that an individual meets the "regarded as" part of the definition of disability if he or she can show that a covered entity made an employment decision because of a perception of a disability based on "myth, fear, or stereotype." This is consistent with the legislative history of the ADA. See House Judiciary Report at 30.

Section 1630.2(m) Qualified Individual With a Disability

Under the proposed part 1630, the first step in determining whether an individual with a disability is a qualified individual with a disability was to determine whether the individual "satisfies the requisite skill, experience and education requirements of the employment position" the individual holds or desires. Many employers and employer groups asserted that the proposed regulation unduly limited job prerequisites to skill, experience, and education requirements and did not permit employers to consider other job-related qualifications. To clarify that the reference to skill, experience, and education requirements was not intended to be an exhaustive list of permissible qualification requirements, the Commission has revised the phrase to include "skill, experience, education, and other job-related requirements." This revision recognizes that other types of job-related requirements may be relevant to determining whether an individual is qualified for a position.

Many individuals with disabilities and disability rights groups asked the Commission to emphasize that the determination of whether a person is a qualified individual with a disability must be made at the time of the employment action in question and cannot be based on speculation that the individual will become unable to perform the job in the future or may cause increased health insurance or workers' compensation costs. The Commission has amended the interpretive guidance on § 1630.2(m) to reflect this point. This guidance is consistent with the legislative history of the Act. See Senate Report at 26, House Labor Report at 55, 136; House Judiciary Report at 34, 71.

Section 1630.2(n) Essential Functions

Many employers and employer groups objected to the use of the terms "primary" and "intrinsic" in the definition of essential functions. To

avoid confusion about the meanings of "primary" and "intrinsic," the Commission has deleted these terms from the definition. The final regulation defines essential functions as "fundamental job duties" and notes that essential functions do not include the marginal functions of a position.

The proposed interpretive guidance accompanying § 1630.2(n)(2)(ii) noted that one of the factors in determining whether a function is essential is the number of employees available to perform a job function or among whom the performance of that function can be distributed. The proposed guidance explained that "(t)his may be a factor either because the total number of employees is low, or because of the fluctuating demands of the business operations." Some employers and employer groups expressed concern that this language could be interpreted as requiring an assessment of whether a job function could be distributed among all employees in any job at any level. The Commission has amended the interpretive guidance on this factor to clarify that the factor refers only to distribution among "available" employees.

Section 1630.2(n)(3) lists several kinds of evidence that are relevant to determining whether a particular job function is essential. Some employers and unions asked the Commission to recognize that collective bargaining agreements may help to identify a position's essential functions. In response to these comments, the Commission has added "(t)he terms of a collective bargaining agreement" to the list. In addition, the Commission has amended the interpretive guidance to note specifically that this type of evidence is relevant to the determination of essential functions. This addition is consistent with the legislative history of the Act. See Senate Report at 32; House Labor Report at 63.

Proposed § 1630.2(n)(3) referred to the evidence on the list as evidence "that may be considered in determining whether a particular function is essential." The Commission has revised this section to refer to evidence "of" whether a particular function is essential. The Commission made this revision in response to concerns about the meaning of the phrase "may be considered." In that regard, some commenters questioned whether the phrase meant that some of the listed evidence might not be considered when determining whether a function is essential to a position. This revision clarifies that all of the types of evidence on the list, when available, are relevant

to the determination of a position's essential functions. As the final rule and interpretive guidance make clear, the list is not an exhaustive list of all types of relevant evidence. Other types of available evidence may also be relevant to the determination.

The Commission has amended the interpretive guidance concerning § 1630.2(n)(3)(ii) to make clear that covered entities are not required to develop and maintain written job descriptions. Such job descriptions are relevant to a determination of a position's essential functions, but they are not required by part 1630.

Several commenters suggested that the Commission establish a rebuttable presumption in favor of the employer's judgment concerning what functions are essential. The Commission has not done so. On that point, the Commission notes that the House Committee on the Judiciary specifically rejected an amendment that would have created such a presumption. See House Judiciary Report at 33-34.

The last paragraph of the interpretive guidance on § 1630.2(n) notes that the inquiry into what constitutes a position's essential functions is not intended to second guess an employer's business judgment regarding production standards, whether qualitative or quantitative. In response to several comments, the Commission has revised this paragraph to incorporate examples of qualitative production standards.

Section 1630.2(o) Reasonable Accommodation

The Commission has deleted the reference to undue hardship from the definition of reasonable accommodation. This is a technical change reflecting that undue hardship is a defense to, rather than an aspect of, reasonable accommodation. As some commenters have noted, a defense to a term should not be part of the term's definition. Accordingly, we have separated the concept of undue hardship from the definition of reasonable accommodation. This change does not affect the obligations of employers or the rights of individuals with disabilities. Accordingly, a covered entity remains obligated to make reasonable accommodation to the known physical or mental limitations of an otherwise qualified individual with a disability unless to do so would impose an undue hardship on the operation of the covered entity's business. See § 1630.9.

With respect to § 1630.2(o)(1)(i), some commenters expressed confusion about the use of the phrase "qualified individual with a disability." In that

regard, they noted that the phrase has a specific definition under this part (see § 1630.2(m)) and questioned whether an individual must meet that definition to request an accommodation with regard to the application process. The Commission has substituted the phrase "qualified applicant with a disability" for "qualified individual with a disability." This change clarifies that an individual with a disability who requests a reasonable accommodation to participate in the application process must be eligible only with respect to the application process.

The Commission has modified § 1630.2(o)(1)(iii) to state that reasonable accommodation includes modifications or adjustments that enable employees with disabilities to enjoy benefits and privileges that are "equal" to (rather than "the same" as) the benefits and privileges that are enjoyed by other employees. This change clarifies that such modifications or adjustments must ensure that individuals with disabilities receive equal access to the benefits and privileges afforded to other employees but may not be able to ensure that the individuals receive the same results of those benefits and privileges or precisely the same benefits and privileges.

Many commenters discussed whether the provision of daily attendant care is a form of reasonable accommodation. Employers and employer groups asserted that reasonable accommodation does not include such assistance. Disability rights groups and individuals with disabilities, however, asserted that such assistance is a form of reasonable accommodation but that this part did not make that clear. To clarify the extent of the reasonable accommodation obligation with respect to daily attendant care, the Commission has amended the interpretive guidance on § 1630.2(o) to make clear that it may be a reasonable accommodation to provide personal assistants to help with specified duties related to the job.

The Commission also has amended the interpretive guidance to note that allowing an individual with a disability to provide and use equipment, aids, or services that an employer is not required to provide may also be a form of reasonable accommodation. Some individuals with disabilities and disability rights groups asked the Commission to make this clear.

The interpretive guidance points out that reasonable accommodation may include making non-work areas accessible to individuals with disabilities. Many commenters asked

the Commission to include rest rooms in the examples of accessible areas that may be required as reasonable accommodations. In response to those comments, the Commission has added rest rooms to the examples.

In response to other comments, the Commission has added a paragraph to the guidance concerning job restructuring as a form of reasonable accommodation. The new paragraph notes that job restructuring may involve changing when or how an essential function is performed.

Several commenters asked the Commission to provide additional guidance concerning the reasonable accommodation of reassignment to a vacant position. Specifically, commenters asked the Commission to clarify how long an employer must wait for a vacancy to arise when considering reassignment and to explain whether the employer is required to maintain the salary of an individual who is reassigned from a higher-paying position to a lower-paying one. The Commission has amended the discussion of reassignment to refer to reassignment to a position that is vacant "within a reasonable amount of time * * * in light of the totality of the circumstances." In addition, the Commission has noted that an employer is not required to maintain the salaries of reassigned individuals with disabilities if it does not maintain the salaries of individuals who are not disabled.

Section 1630.2(p) Undue Hardship

The Commission has substituted "facility" or "facilities" for "site," or "sites" in § 1630.2(p)(2) and has deleted the definition of the term "site." Many employers and employer groups expressed concern about the use and meaning of the term "site." The final regulation's use of the terms "facility" and "facilities" is consistent with the language of the statute.

The Commission has amended the last paragraph of the interpretive guidance accompanying § 1630.2(p) to note that, when the cost of a requested accommodation would result in an undue hardship and outside funding is not available, an individual with a disability should be given the option of paying the portion of the cost that constitutes an undue hardship. This amendment is consistent with the legislative history of the Act. See Senate Report at 36; House Labor Report at 69.

Several employers and employer groups asked the Commission to expand the list of factors to be considered when determining if an accommodation would impose an undue hardship on a covered entity by adding another factor: The

relationship of an accommodation's cost to the value of the position at issue, as measured by the compensation paid to the holder of the position. Congress, however, specifically rejected this type of factor. See House Judiciary Report at 41 (noting that the House Judiciary Committee rejected an amendment proposing that an accommodation costing more than ten percent of the employee's salary be treated as an undue hardship). The Commission, therefore, has not added this to the list.

Section 1630.2(q) Qualification Standards

The Commission has deleted the reference to direct threat from the definition of qualification standards. This revision is consistent with the revisions the Commission has made to §§ 1630.10 and 1630.15(b). (See discussion below.)

Section 1630.2(r) Direct Threat

Many disability rights groups and individuals with disabilities asserted that the definition of direct threat should not include a reference to the health or safety of the individual with a disability. They expressed concern that the reference to "risk to self" would result in direct threat determinations that are based on negative stereotypes and paternalistic views about what is best for individuals with disabilities. Alternatively, the commenters asked the Commission to clarify that any assessment of risk must be based on the individual's present condition and not on speculation about the individual's future condition. They also asked the Commission to specify evidence other than medical knowledge that may be relevant to the determination of direct threat.

The final regulation retains the reference to the health or safety of the individual with a disability. As the appendix notes, this is consistent with the legislative history of the ADA and the case law interpreting section 504 of the Rehabilitation Act.

To clarify the direct threat standard, the Commission has made four revisions to § 1630.2(r). First, the Commission has amended the first sentence of the definition of direct threat to refer to a significant risk of substantial harm that cannot be eliminated "or reduced" by reasonable accommodation. This amendment clarifies that the risk need not be eliminated entirely to fall below the direct threat definition; instead, the risk need only be reduced to the level at which there no longer exists a significant risk of substantial harm. In addition, the Commission has rephrased the second sentence of § 1630.2(r) to

clarify that an employer's direct threat standard must apply to all individuals, not just to individuals with disabilities. Further, the Commission has made clear that a direct threat determination must be based on "an individualized assessment of the individual's present ability to safely perform the essential functions of the job." This clarifies that a determination that employment of an individual would pose a direct threat must involve an individualized inquiry and must be based on the individual's current condition. In addition, the Commission has added "the imminence of the potential harm" to the list of factors to be considered when determining whether employment of an individual would pose a direct threat. This change clarifies that both the probability of harm and the imminence of harm are relevant to direct threat determinations. This definition of direct threat is consistent with the legislative history of the Act. See Senate Report at 27; House Labor Report at 56-57, 73-75; House Judiciary Report at 45-46.

Further, the Commission has amended the interpretive guidance on § 1630.2(r) to highlight the individualized nature of the direct threat assessment. In addition, the Commission has cited examples of evidence other than medical knowledge that may be relevant to determining whether employment of an individual would pose a direct threat.

Section 1630.3 Exceptions to the Definitions of "Disability" and "Qualified Individual With a Disability"

Many commenters asked the Commission to clarify that the term "rehabilitation program" includes self-help groups. In response to these comments, the Commission has amended the interpretive guidance in this area to include a reference to professionally recognized self-help programs.

The Commission has added a paragraph to the guidance on § 1630.3 to note that individuals who are not excluded under this provision from the definitions of the terms "disability" and "qualified individual with a disability" must still establish that they meet those definitions to be protected by part 1630. Several employers and employer groups asked the Commission to clarify that individuals are not automatically covered by the ADA simply because they do not fall into one of the exclusions listed in this section.

The proposed interpretive guidance on § 1630.3 noted that employers are entitled to seek reasonable assurances that an individual is not currently

engaging in the illegal use of drugs. In that regard, the guidance stated, "It is essential that the individual offer evidence, such as a drug test, to prove that he or she is not currently engaging" in such use. Many commenters interpreted this guidance to require individuals to come forward with evidence even in the absence of a request by the employer. The Commission has revised the interpretive guidance to clarify that such evidence is required only upon request.

Section 1630.6 Contractual or Other Arrangements

The Commission has added a sentence to the first paragraph of the interpretive guidance on § 1630.6 to clarify that this section has no impact on whether one is a covered entity or employer as defined by § 1630.2.

The proposed interpretive guidance on contractual or other relationships noted that § 1630.6 applied to parties on either side of the relationship. To illustrate this point, the guidance stated that "a copier company would be required to ensure the provision of any reasonable accommodation necessary to enable its copier service representative with a disability to service a client's machine." Several employers objected to this example. In that respect, the commenters argued that the language of the example was too broad and could be interpreted as requiring employers to make all customers premises accessible. The Commission has revised this example to provide a clearer, more concrete indication of the scope of the reasonable accommodation obligations in this area.

In addition, the Commission has clarified the interpretive guidance by noting that the existence of a contractual relationship adds no new obligations "under this part."

Section 1630.8 Relationship or Association With an Individual With a Disability

The Commission has added the phrase "or otherwise discriminate against" to § 1630.8. This change clarifies that harassment or any other form of discrimination against a qualified individual because of the known disability of a person with whom the individual has a relationship or an association is also a prohibited form of discrimination.

The Commission has revised the first sentence of the interpretive guidance to refer to a person's relationship or association with an individual who has a "known" disability. This revision makes the language of the interpretive guidance consistent with the language of

the regulation. In addition, to reflect current, preferred terminology, the Commission has substituted the term "people who have AIDS" for the term "AIDS patients." Finally, the Commission has added a paragraph to clarify that this provision applies to discrimination in other employment privileges and benefits, such as health insurance benefits.

Section 1630.9 Not Making Reasonable Accommodation

Section 1630.9(c) provides that "(a) covered entity shall not be excused from the requirements of this part because of any failure to receive technical assistance * * *." Some employers asked the Commission to revise this section and to state that the failure to receive technical assistance is a defense to not providing reasonable accommodation. The Commission has not made the requested revision. Section 1630.9(c) is consistent with section 506(e) of the ADA, which states that the failure to receive technical assistance from the federal agencies that administer the ADA does not excuse a covered entity from compliance with the requirements of the Act.

The first paragraph of the interpretive guidance accompanying § 1630.9 notes that the reasonable accommodation obligation does not require employers to provide adjustments or modifications that are primarily for the personal use of the individual with a disability. The Commission has amended this guidance to clarify that employers may be required to provide items that are customarily personal-use items where the items are specifically designed or required to meet job-related needs.

In addition, the Commission has amended the interpretive guidance to clarify that there must be a nexus between an individual's disability and the need for accommodation. Thus, the guidance notes that an individual with a disability is "otherwise qualified" if he or she is qualified for the job except that, "because of the disability," the individual needs reasonable accommodation to perform the essential functions of the job. Similarly, the guidance notes that employers are required to accommodate only the physical or mental limitations "resulting from the disability" that are known to the employer.

In response to commenters' requests for clarification, the Commission has noted that employers may require individuals with disabilities to provide documentation of the need for reasonable accommodation when the need for a requested accommodation is not obvious.

In addition, the Commission has amended the last paragraph of the interpretive guidance on the "Process of Determining the Appropriate Reasonable Accommodation." This amendment clarifies that an employer must consider allowing an individual with a disability to provide his or her own accommodation if the individual wishes to do so. The employer, however, may not require the individual to provide the accommodation.

Section 1630.10 Qualification Standards, Tests, and Other Selection Criteria

The Commission has added the phrase "on the basis of disability" to § 1630.10(a) to clarify that a selection criterion that is not job related and consistent with business necessity violates this section only when it screens out an individual with a disability (or a class of individuals with disabilities) on the basis of disability. That is, there must be a nexus between the exclusion and the disability. A selection criterion that screens out an individual with a disability for reasons that are not related to the disability does not violate this section. The Commission has made similar changes to the interpretive guidance on this section.

Proposed § 1630.10(b) stated that a covered entity could use as a qualification standard the requirement that an individual not pose a direct threat to the health or safety of the individual or others. Many individuals with disabilities objected to the inclusion of the direct threat reference in this section and asked the Commission to clarify that the direct threat standard must be raised by the covered entity as a defense. In that regard, they specifically asked the Commission to move the direct threat provision from § 1630.10 (qualification standards) to § 1630.15 (defenses). The Commission has deleted the direct threat provision from § 1630.10 and has moved it to § 1630.15. This is consistent with section 103 of the ADA, which refers to defenses and states (in section 103(b)) that the term "qualification standards" may include a requirement that an individual not pose a direct threat.

Section 1630.11 Administration of Tests

The Commission has revised the interpretive guidance concerning § 1630.11 to clarify that a request for an alternative test format or other testing accommodation generally should be made prior to the administration of the test or as soon as the individual with a

disability becomes aware of the need for accommodation. In addition, the Commission has amended the last paragraph of the guidance on this section to note that an employer can require a written test of an applicant with dyslexia if the ability to read is "the skill the test is designed to measure." This language is consistent with the regulatory language, which refers to the skills a test purports to measure.

Some commenters noted that certain tests are designed to measure the speed with which an applicant performs a function. In response to these comments, the Commission has amended the interpretive guidance to state that an employer may require an applicant to complete a test within a specified time frame if speed is one of the skills being tested.

In response to comments, the Commission has amended the interpretive guidance accompanying § 1630.14(a) to clarify that employers may invite applicants to request accommodations for taking tests. (See § 1630.14(a), below.)

Section 1630.12 Retaliation and Coercion

The Commission has amended § 1630.12 to clarify that this section also prohibits harassment.

Section 1630.13 Prohibited Medical Examinations and Inquiries

In response to the Commission's request for comment on certain workers' compensation matters, many commenters addressed whether a covered entity may ask applicants about their history of workers' compensation claims. Many employers and employer groups argued that an inquiry about an individual's workers' compensation history is job related and consistent with business necessity. Disability rights groups and individuals with disabilities, however, asserted that such an inquiry could disclose the existence of a disability. In response to comments and to clarify this matter, the Commission has amended the interpretive guidance accompanying § 1630.13(a). The amendment states that an employer may not inquire about an individual's workers' compensation history at the pre-offer stage.

The Commission has made a technical change to § 1630.13(b) by deleting the phrase "unless the examination or inquiry is shown to be job-related and consistent with business necessity" from the section. This change does not affect the substantive provisions of § 1630.13(b). The Commission has incorporated the job-relatedness and

business-necessity requirement into a new § 1630.14(c), which clarifies the scope of permissible examinations or inquiries of employees. (See § 1630.14(c), below.)

Section 1630.14 Medical Examinations and Inquiries Specifically Permitted

Section 1630.14(a) Acceptable Pre-employment Inquiry

Proposed § 1630.14(a) stated that a covered entity may make pre-employment inquiries into an applicant's ability to perform job-related functions. The interpretive guidance accompanying this section noted that an employer may ask an individual whether he or she can perform a job function with or without reasonable accommodation.

Many employers asked the Commission to provide additional guidance in this area. Specifically, the commenters asked whether an employer may ask how an individual will perform a job function when the individual's known disability appears to interfere with or prevent performance of job-related functions. To clarify this matter, the Commission has amended § 1630.14(a) to state that a covered entity "may ask an applicant to describe or to demonstrate how, with or without reasonable accommodation, the applicant will be able to perform job-related functions." The Commission has amended the interpretive guidance accompanying § 1630.14(a) to reflect this change.

Many commenters asked the Commission to state that employers may inquire, before tests are taken, whether candidates will require any reasonable accommodations to take the tests. They asked the Commission to acknowledge that such inquiries constitute permissible pre-employment inquiries. In response to these comments, the Commission has added a new paragraph to the interpretive guidance on § 1630.14(a). This paragraph clarifies that employers may ask candidates to inform them of the need for reasonable accommodation within a reasonable time before the administration of the test and may request documentation verifying the need for accommodation.

The Commission has received many comments from law enforcement and other public safety agencies concerning the administration of physical agility tests. In response to those comments, the Commission has added a new paragraph clarifying that such tests are not medical examinations.

Many employers and employer groups have asked the Commission to discuss whether employers may invite applicants to self-identify as individuals

with disabilities. In that regard, many of the commenters noted that section 503 of the Rehabilitation Act imposes certain obligations on government contractors. The interpretive guidance accompanying § 1630.1(b) and (c) notes that "title I of the ADA would not be a defense to failing to collect information required to satisfy the affirmative action requirements of section 503 of the Rehabilitation Act." To reiterate this point, the Commission has amended the interpretive guidance accompanying § 1630.14(a) to note specifically that this section does not restrict employers from collecting information and inviting individuals to identify themselves as individuals with disabilities as required to satisfy the affirmative action requirements of section 503 of the Rehabilitation Act.

Section 1630.14(b) Employment Entrance Examinations

Section 1630.14(b) has been amended to include the phrase "(and/or inquiry)" after references to medical examinations. Some commenters were concerned that the regulation as drafted prohibited covered entities from making any medical inquiries or administering questionnaires that did not constitute examinations. This change clarifies that the term "employment entrance examinations" includes medical inquiries as well as medical examinations.

Section 1630.14(b)(2) has been revised to state that the results of employment entrance examinations "shall not be used for any purpose inconsistent with this part." This language is consistent with the language used in § 1630.14(c)(2).

The second paragraph of the proposed interpretive guidance on this section referred to "relevant" physical and psychological criteria. Some commenters questioned the use of the term "relevant" and expressed concern about its meaning. The Commission has deleted this term from the paragraph.

Many commenters addressed the confidentiality provisions of this section. They noted that it may be necessary to disclose medical information in defense of workers' compensation claims or during the course of other legal proceedings. In addition, they pointed out that the workers' compensation offices of many states request such information for the administration of second-injury funds or for other administrative purposes.

The Commission has revised the last paragraph of the interpretive guidance on § 1630.14(b) to reflect that the information obtained during a permitted employment entrance examination or

inquiry may be used only "in a manner not inconsistent with this part." In addition, the Commission has added language clarifying that it is permissible to submit the information to state workers' compensation offices.

Several commenters asked the Commission to clarify whether information obtained from employment entrance examinations and inquiries may be used for insurance purposes. In response to these comments, the Commission has noted in the interpretive guidance that such information may be used for insurance purposes described in § 1630.16(f).

Section 1630.14(c) Examination of Employees

The Commission has added a new § 1630.14(c), Examination of employees, that clarifies the scope of permissible medical examinations and inquiries. Several employers and employer groups expressed concern that the proposed version of part 1630 did not make it clear that covered entities may require employee medical examinations, such as fitness-for-duty examinations, that are job related and consistent with business necessity. New § 1630.14(c) clarifies this by expressly permitting covered entities to require employee medical examinations and inquiries that are job related and consistent with business necessity. The information obtained from such examinations or inquiries must be treated as a confidential medical record. This section also incorporates the last sentence of proposed § 1630.14(c). The remainder of proposed § 1630.14(c) has become § 1630.14(d).

To comport with this technical change in the regulation, the Commission has made corresponding changes in the interpretive guidance. Thus, the Commission has moved the second paragraph of the proposed guidance on § 1630.13(b) to the guidance on § 1630.14(c). In addition, the Commission has reworded the paragraph to note that this provision permits (rather than does not prohibit) certain medical examinations and inquiries.

Some commenters asked the Commission to clarify whether employers may make inquiries or require medical examinations in connection with the reasonable accommodation process. The Commission has noted in the interpretive guidance that such inquiries and examinations are permissible when they are necessary to the reasonable accommodation process described in this part.

Section 1630.15 Defenses

The Commission has added a sentence to the interpretive guidance on § 1630.15(a) to clarify that the assertion that an insurance plan does not cover an individual's disability or that the disability would cause increased insurance or workers' compensation costs does not constitute a legitimate, nondiscriminatory reason for disparate treatment of an individual with a disability. This clarification, made in response to many comments from individuals with disabilities and disability rights groups, is consistent with the legislative history of the ADA. See Senate Report at 85; House Labor Report at 136; House Judiciary Report at 71.

The Commission has amended § 1630.15(b) by stating that the term "qualification standard" may include a requirement that an individual not pose a direct threat. As noted above, this is consistent with section 103 of the ADA and responds to many comments from individuals with disabilities.

The Commission has made a technical correction to § 1630.15(c) by changing the phrase "an individual or class of individuals with disabilities" to "an individual with a disability or a class of individuals with disabilities."

Several employers and employer groups asked the Commission to acknowledge that undue hardship considerations about reasonable accommodations at temporary work sites may be different from the considerations relevant to permanent work sites. In response to these comments, the Commission has amended the interpretive guidance on § 1630.15(d) to note that an accommodation that poses an undue hardship in a particular job setting, such as a temporary construction site, may not pose an undue hardship in another setting. This guidance is consistent with the legislative history of the ADA. See House Labor Report at 69-70; House Judiciary Report at 41-42.

The Commission also has amended the interpretive guidance to note that the terms of a collective bargaining agreement may be relevant to the determination of whether a requested accommodation would pose an undue hardship on the operation of a covered entity's business. This amendment, which responds to commenters' requests that the Commission recognize the relevancy of collective bargaining agreements, is consistent with the legislative history of the Act. See Senate Report at 32; House Labor Report at 63.

Section 1630.2(p)(2)(v) provides that the impact of an accommodation on the

ability of other employees to perform their duties is one of the factors to be considered when determining whether the accommodation would impose an undue hardship on a covered entity. Many commenters addressed whether an accommodation's impact on the morale of other employees may be relevant to a determination of undue hardship. Some employers and employer groups asserted that a negative impact on employee morale should be considered an undue hardship. Disability rights groups and individuals with disabilities, however, argued that undue hardship determinations must not be based on the morale of other employees. It is the Commission's view that a negative effect on morale, by itself, is not sufficient to meet the undue hardship standard. Accordingly, the Commission has noted in the guidance on § 1630.15(d) that an employer cannot establish undue hardship by showing only that an accommodation would have a negative impact on employee morale.

Section 1630.16 Specific Activities Permitted

The Commission has revised the second sentence of the interpretive guidance on § 1630.16(b) to state that an employer may hold individuals with alcoholism and individuals who engage in the illegal use of drugs to the same performance and conduct standards to which it holds "all of its" other employees. In addition, the Commission has deleted the term "otherwise" from the third sentence of the guidance. These revisions clarify that employers may hold all employees, disabled (including those disabled by alcoholism or drug addiction) and nondisabled, to the same performance and conduct standards.

Many commenters asked the Commission to clarify that the drug testing provisions of § 1630.16(c) pertain only to tests to determine the illegal use of drugs. Accordingly, the Commission has amended § 1630.16(c)(1) to refer to the administration of "such" drug tests and § 1630.16(c)(3) to refer to information obtained from a "test to determine the illegal use of drugs." We have also made a change in the grammatical structure of the last sentence of § 1630.16(c)(1). We have made similar changes to the corresponding section of the interpretive guidance. In addition, the Commission has amended the interpretive guidance to state that such tests are neither encouraged, "authorized," nor prohibited. This amendment conforms the language of the guidance to the language of § 1630.16(c)(1).

The Commission has revised § 1630.16(e)(1) to refer to communicable diseases that "are" (rather than "may be") transmitted through the handling of food. Several commenters asked the Commission to make this technical change, which adopts the statutory language.

Several commenters also asked the Commission to conform the language of proposed § 1630.16(f) (1) and (2) to the language of sections 501(c) (1) and (2) of the Act. The Commission has made this change. Thus, § 1630.16(f) (1) and (2) now refer to risks that are "not inconsistent with State law."

Executive Order 12291 and Regulatory Flexibility Act

The Commission published a Preliminary Regulatory Impact Analysis on February 28, 1991 (56 FR 8578). Based on the Preliminary Regulatory Impact Analysis, the Commission certifies that this final rule will not have a significant economic impact on a substantial number of small business entities. The Commission is issuing this final rule at this time in the absence of a Final Regulatory Impact Analysis in order to meet the statutory deadline. The Commission's Preliminary Regulatory Impact Analysis was based upon existing data on the costs of reasonable accommodation. The Commission received few comments on this aspect of its rulemaking. Because of the complexity inherent in assessing the economic costs and benefits of this rule and the relative paucity of data on this issue, the Commission will further study the economic impact of the regulation and intends to issue a Final Regulatory Impact Analysis prior to January 1, 1992. As indicated above, the Preliminary Regulatory Impact Analysis was published on February 28, 1991 (56 FR 8578) for comment. The Commission will also provide a copy to the public upon request by calling the Commission's Office of Communications and Legislative Affairs at (202) 663-4900. Commenters are urged to provide additional information as to the costs and benefits associated with this rule. This will further facilitate the development of a Final Regulatory Impact Analysis. Comments must be received by September 26, 1991. Written comments should be submitted to Frances M. Hart, Executive Officer, Executive Secretariat, Equal Employment Opportunity Commission, 1801 "L" Street, NW., Washington, DC 20507.

As a convenience to commenters, the Executive Secretariat will accept public comments transmitted by facsimile ("FAX") machine. The telephone

number of the FAX receiver is (202) 663-4114. (This is not a toll-free number). Only public comments of six or fewer pages will be accepted via FAX transmittal. This limitation is necessary in order to assure access to the equipment. Comments sent by FAX in excess of six pages will not be accepted. Receipt of FAX transmittals will not be acknowledged, except that the sender may request confirmation of receipt by calling the Executive Secretariat Staff at (202) 663-4078. (This is not a toll-free number).

Comments received will be available for public inspection in the EEOC Library, room 6502, by appointment only, from 9 a.m. to 5 p.m., Monday through Friday except legal holidays from October 15, 1991, until the Final Regulatory Impact Analysis is published. Persons who need assistance to review the comments will be provided with appropriate aids such as readers or print magnifiers. To schedule an appointment call (202) 663-4630 (voice), (202) 663-4630 (TDD).

List of Subjects in 29 CFR Part 1630

Equal employment opportunity, Handicapped, Individuals with disabilities.

For the Commission,
Evan J. Kemp, Jr.,
Chairman.

Accordingly, 29 CFR chapter XIV is amended by adding part 1630 to read as follows:

PART 1630—REGULATIONS TO IMPLEMENT THE EQUAL EMPLOYMENT PROVISIONS OF THE AMERICANS WITH DISABILITIES ACT

- Sec.
- 1630.1 Purpose, applicability, and construction.
- 1630.2 Definitions.
- 1630.3 Exceptions to the definitions of "Disability" and "Qualified Individual with a Disability."
- 1630.4 Discrimination prohibited.
- 1630.5 Limiting, segregating, and classifying.
- 1630.6 Contractual or other arrangements.
- 1630.7 Standards, criteria, or methods of administration.
- 1630.8 Relationship or association with an individual with a disability.
- 1630.9 Not making reasonable accommodation.
- 1630.10 Qualification standards, tests, and other selection criteria.
- 1630.11 Administration of tests.
- 1630.12 Retaliation and coercion.
- 1630.13 Prohibited medical examinations and inquiries.
- 1630.14 Medical examinations and inquiries specifically permitted.
- 1630.15 Defenses.
- 1630.16 Specific activities permitted.

Appendix to Part 1630—Interpretive Guidance on Title I of the Americans with Disabilities Act

Authority: 42 U.S.C. 12116.

§ 1630.1 Purpose, applicability, and construction.

(a) *Purpose.* The purpose of this part is to implement title I of the Americans with Disabilities Act (42 U.S.C. 12101, *et seq.*) (ADA), requiring equal employment opportunities for qualified individuals with disabilities, and sections 3(2), 3(3), 501, 503, 506(e), 508, 510, and 511 of the ADA as those sections pertain to the employment of qualified individuals with disabilities.

(b) *Applicability.* This part applies to "covered entities" as defined at § 1630.2(b).

(c) *Construction.*—(1) *In general.* Except as otherwise provided in this part, this part does not apply a lesser standard than the standards applied under title V of the Rehabilitation Act of 1973 (29 U.S.C. 790-794a), or the regulations issued by Federal agencies pursuant to that title.

(2) *Relationship to other laws.* This part does not invalidate or limit the remedies, rights, and procedures of any Federal law or law of any State or political subdivision of any State or jurisdiction that provides greater or equal protection for the rights of individuals with disabilities than are afforded by this part.

§ 1630.2 Definitions.

(a) *Commission* means the Equal Employment Opportunity Commission established by section 705 of the Civil Rights Act of 1964 (42 U.S.C. 2000e-4).

(b) *Covered Entity* means an employer, employment agency, labor organization, or joint labor management committee.

(c) *Person, labor organization, employment agency, commerce and industry affecting commerce* shall have the same meaning given those terms in section 701 of the Civil Rights Act of 1964 (42 U.S.C. 2000e).

(d) *State* means each of the several States, the District of Columbia, the Commonwealth of Puerto Rico, Guam, American Samoa, the Virgin Islands, the Trust Territory of the Pacific Islands, and the Commonwealth of the Northern Mariana Islands.

(e) *Employer.*—(1) *In general.* The term employer means a person engaged in an industry affecting commerce who has 15 or more employees for each working day in each of 20 or more calendar weeks in the current or preceding calendar year, and any agent of such person, except that, from July 26,

1992 through July 25, 1994, an employer means a person engaged in an industry affecting commerce who has 25 or more employees for each working day in each of 20 or more calendar weeks in the current or preceding year and any agent of such person.

(2) *Exceptions.* The term employer does not include—

(i) The United States, a corporation wholly owned by the government of the United States, or an Indian tribe; or

(ii) A bona fide private membership club (other than a labor organization) that is exempt from taxation under section 501(c) of the Internal Revenue Code of 1986.

(f) *Employee* means an individual employed by an employer.

(g) *Disability* means, with respect to an individual—

(1) A physical or mental impairment that substantially limits one or more of the major life activities of such individual;

(2) A record of such an impairment; or

(3) being regarded as having such an impairment.

(See § 1630.3 for exceptions to this definition).

(h) *Physical or mental impairment* means:

(1) Any physiological disorder, or condition, cosmetic disfigurement, or anatomical loss affecting one or more of the following body systems: neurological, musculoskeletal, special sense organs, respiratory (including speech organs), cardiovascular, reproductive, digestive, genito-urinary, hemic and lymphatic, skin, and endocrine; or

(2) Any mental or psychological disorder, such as mental retardation, organic brain syndrome, emotional or mental illness, and specific learning disabilities.

(i) *Major Life Activities* means functions such as caring for oneself, performing manual tasks, walking, seeing, hearing, speaking, breathing, learning, and working.

(j) *Substantially limits*—(1) The term *substantially limits* means:

(i) Unable to perform a major life activity that the average person in the general population can perform; or

(ii) Significantly restricted as to the condition, manner or duration under which an individual can perform a particular major life activity as compared to the condition, manner, or duration under which the average person in the general population can perform that same major life activity.

(2) The following factors should be considered in determining whether an individual is substantially limited in a major life activity:

(i) The nature and severity of the impairment;

(ii) The duration or expected duration of the impairment; and

(iii) The permanent or long term impact, or the expected permanent or long term impact of or resulting from the impairment.

(3) With respect to the major life activity of *working*—

(i) The term *substantially limits* means significantly restricted in the ability to perform either a class of jobs or a broad range of jobs in various classes as compared to the average person having comparable training, skills and abilities. The inability to perform a single, particular job does not constitute a substantial limitation in the major life activity of *working*.

(ii) In addition to the factors listed in paragraph (j)(2) of this section, the following factors may be considered in determining whether an individual is substantially limited in the major life activity of "working":

(A) The geographical area to which the individual has reasonable access;

(B) The job from which the individual has been disqualified because of an impairment, and the number and types of jobs utilizing similar training, knowledge, skills or abilities, within that geographical area, from which the individual is also disqualified because of the impairment (class of jobs); and/or

(C) The job from which the individual has been disqualified because of an impairment, and the number and types of other jobs not utilizing similar training, knowledge, skills or abilities, within that geographical area, from which the individual is also disqualified because of the impairment (broad range of jobs in various classes).

(k) *Has a record of such impairment* means has a history of, or has been misclassified as having, a mental or physical impairment that substantially limits one or more major life activities.

(l) *Is regarded as having such an impairment* means:

(1) Has a physical or mental impairment that does not substantially limit major life activities but is treated by a covered entity as constituting such limitation;

(2) Has a physical or mental impairment that substantially limits major life activities only as a result of the attitudes of others toward such impairment; or

(3) Has none of the impairments defined in paragraphs (h) (1) or (2) of this section but is treated by a covered entity as having a substantially limiting impairment.

(m) *Qualified individual with a disability* means an individual with a

disability who satisfies the requisite skill, experience, education and other job-related requirements of the employment position such individual holds or desires, and who, with or without reasonable accommodation, can perform the essential functions of such position. (See § 1630.3 for exceptions to this definition).

(n) *Essential functions.*—(1) *In general.* The term *essential functions* means the fundamental job duties of the employment position the individual with a disability holds or desires. The term "essential functions" does not include the marginal functions of the position.

(2) A job function may be considered essential for any of several reasons, including but not limited to the following:

(i) The function may be essential because the reason the position exists is to perform that function;

(ii) The function may be essential because of the limited number of employees available among whom the performance of that job function can be distributed; and/or

(iii) The function may be highly specialized so that the incumbent in the position is hired for his or her expertise or ability to perform the particular function.

(3) Evidence of whether a particular function is essential includes, but is not limited to:

(i) The employer's judgment as to which functions are essential;

(ii) Written job descriptions prepared before advertising or interviewing applicants for the job;

(iii) The amount of time spent on the job performing the function;

(iv) The consequences of not requiring the incumbent to perform the function;

(v) The terms of a collective bargaining agreement;

(vi) The work experience of past incumbents in the job; and/or

(vii) The current work experience of incumbents in similar jobs.

(o) *Reasonable accommodation.* (1) The term *reasonable accommodation* means:

(i) Modifications or adjustments to a job application process that enable a qualified applicant with a disability to be considered for the position such qualified applicant desires; or

(ii) Modifications or adjustments to the work environment, or to the manner or circumstances under which the position held or desired is customarily performed, that enable a qualified individual with a disability to perform the essential functions of that position; or

(iii) Modifications or adjustments that enable a covered entity's employee with a disability to enjoy equal benefits and privileges of employment as are enjoyed by its other similarly situated employees without disabilities.

(2) *Reasonable accommodation* may include but is not limited to:

(i) Making existing facilities used by employees readily accessible to and usable by individuals with disabilities; and

(ii) Job restructuring; part-time or modified work schedules; reassignment to a vacant position; acquisition or modifications of equipment or devices; appropriate adjustment or modifications of examinations, training materials, or policies; the provision of qualified readers or interpreters; and other similar accommodations for individuals with disabilities.

(3) To determine the appropriate reasonable accommodation it may be necessary for the covered entity to initiate an informal, interactive process with the qualified individual with a disability in need of the accommodation. This process should identify the precise limitations resulting from the disability and potential reasonable accommodations that could overcome those limitations.

(p) *Undue hardship*—(1) *In general.* *Undue hardship* means, with respect to the provision of an accommodation, significant difficulty or expense incurred by a covered entity, when considered in light of the factors set forth in paragraph (p)(2) of this section.

(2) *Factors to be considered.* In determining whether an accommodation would impose an undue hardship on a covered entity, factors to be considered include:

(i) The nature and net cost of the accommodation needed under this part, taking into consideration the availability of tax credits and deductions, and/or outside funding;

(ii) The overall financial resources of the facility or facilities involved in the provision of the reasonable accommodation, the number of persons employed at such facility, and the effect on expenses and resources;

(iii) The overall financial resources of the covered entity, the overall size of the business of the covered entity with respect to the number of its employees, and the number, type and location of its facilities;

(iv) The type of operation or operations of the covered entity, including the composition, structure and functions of the workforce of such entity, and the geographic separateness and administrative or fiscal relationship

of the facility or facilities in question to the covered entity; and

(v) The impact of the accommodation upon the operation of the facility, including the impact on the ability of other employees to perform their duties and the impact on the facility's ability to conduct business.

(q) *Qualification standards* means the personal and professional attributes including the skill, experience, education, physical, medical, safety and other requirements established by a covered entity as requirements which an individual must meet in order to be eligible for the position held or desired.

(r) *Direct Threat* means a significant risk of substantial harm to the health or safety of the individual or others that cannot be eliminated or reduced by reasonable accommodation. The determination that an individual poses a "direct threat" shall be based on an individualized assessment of the individual's present ability to safely perform the essential functions of the job. This assessment shall be based on a reasonable medical judgment that relies on the most current medical knowledge and/or on the best available objective evidence. In determining whether an individual would pose a direct threat, the factors to be considered include:

(1) The duration of the risk;

(2) The nature and severity of the potential harm;

(3) The likelihood that the potential harm will occur; and

(4) The imminence of the potential harm.

§ 1630.3 Exceptions to the definitions of "Disability" and "Qualified individual with a Disability."

(a) The terms *disability* and *qualified individual with a disability* do not include individuals currently engaging in the illegal use of drugs, when the covered entity acts on the basis of such use.

(1) *Drug* means a controlled substance, as defined in schedules I through V of Section 202 of the Controlled Substances Act (21 U.S.C. 812)

(2) *Illegal use of drugs* means the use of drugs the possession or distribution of which is unlawful under the Controlled Substances Act, as periodically updated by the Food and Drug Administration. This term does not include the use of a drug taken under the supervision of a licensed health care professional, or other uses authorized by the Controlled Substances Act or other provisions of Federal law.

(b) However, the terms *disability* and *qualified individual with a disability* may not exclude an individual who:

(1) Has successfully completed a supervised drug rehabilitation program and is no longer engaging in the illegal use of drugs, or has otherwise been rehabilitated successfully and is no longer engaging in the illegal use of drugs; or

(2) Is participating in a supervised rehabilitation program and is no longer engaging in such use; or

(3) Is erroneously regarded as engaging in such use, but is not engaging in such use.

(c) It shall not be a violation of this part for a covered entity to adopt or administer reasonable policies or procedures, including but not limited to drug testing, designed to ensure that an individual described in paragraph (b) (1) or (2) of this section is no longer engaging in the illegal use of drugs. (See § 1630.16(c) Drug testing).

(d) *Disability* does not include:

(1) Transvestism, transsexualism, pedophilia, exhibitionism, voyeurism, gender identity disorders not resulting from physical impairments, or other sexual behavior disorders;

(2) Compulsive gambling, kleptomania, or pyromania; or

(3) Psychoactive substance use disorders resulting from current illegal use of drugs.

(e) *Homosexuality and bisexuality* are not impairments and so are not disabilities as defined in this part.

§ 1630.4 Discrimination prohibited.

It is unlawful for a covered entity to discriminate on the basis of disability against a qualified individual with a disability in regard to:

(a) Recruitment, advertising, and job application procedures;

(b) Hiring, upgrading, promotion, award of tenure, demotion, transfer, layoff, termination, right of return from layoff, and rehiring;

(c) Rates of pay or any other form of compensation and changes in compensation;

(d) Job assignments, job classifications, organizational structures, position descriptions, lines of progression, and seniority lists;

(e) Leaves of absence, sick leave, or any other leave;

(f) Fringe benefits available by virtue of employment, whether or not administered by the covered entity;

(g) Selection and financial support for training, including: apprenticeships, professional meetings, conferences and other related activities, and selection for leaves of absence to pursue training;

(h) Activities sponsored by a covered entity including social and recreational programs; and

(i) Any other term, condition, or privilege of employment.

The term *discrimination* includes, but is not limited to, the acts described in §§ 1630.5 through 1630.13 of this part.

§ 1630.5 Limiting segregating, and classifying.

It is unlawful for a covered entity to limit, segregate, or classify a job applicant or employee in a way that adversely affects his or her employment opportunities or status on the basis of disability.

§ 1630.6 Contractual or other arrangements.

(a) *In general.* It is unlawful for a covered entity to participate in a contractual or other arrangement or relationship that has the effect of subjecting the covered entity's own qualified applicant or employee with a disability to the discrimination prohibited by this part.

(b) *Contractual or other arrangement defined.* The phrase *contractual or other arrangement or relationship* includes, but is not limited to, a relationship with an employment or referral agency; labor union, including collective bargaining agreements; an organization providing fringe benefits to an employee of the covered entity; or an organization providing training and apprenticeship programs.

(c) *Application.* This section applies to a covered entity, with respect to its own applicants or employees, whether the entity offered the contract or initiated the relationship, or whether the entity accepted the contract or acceded to the relationship. A covered entity is not liable for the actions of the other party or parties to the contract which only affect that other party's employees or applicants.

§ 1630.7 Standards, criteria, or methods of administration.

It is unlawful for a covered entity to use standards, criteria, or methods of administration, which are not job-related and consistent with business necessity, and:

(a) That have the effect of discriminating on the basis of disability; or

(b) That perpetuate the discrimination of others who are subject to common administrative control.

§ 1630.8 Relationship or association with an individual with a disability.

It is unlawful for a covered entity to exclude or deny equal jobs or benefits to, or otherwise discriminate against, a qualified individual because of the known disability of an individual with whom the qualified individual is known

to have a family, business, social or other relationship or association.

§ 1630.9 Not making reasonable accommodation.

(a) It is unlawful for a covered entity not to make reasonable accommodation to the known physical or mental limitations of an otherwise qualified applicant or employee with a disability, unless such covered entity can demonstrate that the accommodation would impose an undue hardship on the operation of its business.

(b) It is unlawful for a covered entity to deny employment opportunities to an otherwise qualified job applicant or employee with a disability based on the need of such covered entity to make reasonable accommodation to such individual's physical or mental impairments.

(c) A covered entity shall not be excused from the requirements of this part because of any failure to receive technical assistance authorized by section 506 of the ADA, including any failure in the development or dissemination of any technical assistance manual authorized by that Act.

(d) A qualified individual with a disability is not required to accept an accommodation, aid, service, opportunity or benefit which such qualified individual chooses not to accept. However, if such individual rejects a reasonable accommodation, aid, service, opportunity or benefit that is necessary to enable the individual to perform the essential functions of the position held or desired, and cannot, as a result of that rejection, perform the essential functions of the position, the individual will not be considered a qualified individual with a disability.

§ 1630.10 Qualification standards, tests, and other selection criteria.

It is unlawful for a covered entity to use qualification standards, employment tests or other selection criteria that screen out or tend to screen out an individual with a disability or a class of individuals with disabilities, on the basis of disability, unless the standard, test or other selection criteria, as used by the covered entity, is shown to be job-related for the position in question and is consistent with business necessity.

§ 1630.11 Administration of tests.

It is unlawful for a covered entity to fail to select and administer tests concerning employment in the most effective manner to ensure that, when a test is administered to a job applicant or employee who has a disability that

impairs sensory, manual or speaking skills, the test results accurately reflect the skills, aptitude, or whatever other factor of the applicant or employee that the test purports to measure, rather than reflecting the impaired sensory, manual, or speaking skills of such employee or applicant (except where such skills are the factors that the test purports to measure).

§ 1630.12 Retaliation and coercion.

(a) *Retaliation.* It is unlawful to discriminate against any individual because that individual has opposed any act or practice made unlawful by this part or because that individual made a charge, testified, assisted, or participated in any manner in an investigation, proceeding, or hearing to enforce any provision contained in this part.

(b) *Coercion, interference or intimidation.* It is unlawful to coerce, intimidate, threaten, harass or interfere with any individual in the exercise or enjoyment of, or because that individual aided or encouraged any other individual in the exercise of, any right granted or protected by this part.

§ 1630.13 Prohibited medical examinations and inquiries.

(a) *Pre-employment examination or inquiry.* Except as permitted by § 1630.14, it is unlawful for a covered entity to conduct a medical examination of an applicant or to make inquiries as to whether an applicant is an individual with a disability or as to the nature or severity of such disability.

(b) *Examination or inquiry of employees.* Except as permitted by § 1630.14, it is unlawful for a covered entity to require a medical examination of an employee or to make inquiries as to whether an employee is an individual with a disability or as to the nature or severity of such disability.

§ 1630.14 Medical examinations and inquiries specifically permitted.

(a) *Acceptable pre-employment inquiry.* A covered entity may make pre-employment inquiries into the ability of an applicant to perform job-related functions, and/or may ask an applicant to describe or to demonstrate how, with or without reasonable accommodation, the applicant will be able to perform job-related functions.

(b) *Employment entrance examination.* A covered entity may require a medical examination (and/or inquiry) after making an offer of employment to a job applicant and before the applicant begins his or her employment duties, and may condition an offer of employment on the results of

such examination (and/or inquiry), if all entering employees in the same job category are subjected to such an examination (and/or inquiry) regardless of disability.

(1) Information obtained under paragraph (b) of this section regarding the medical condition or history of the applicant shall be collected and maintained on separate forms and in separate medical files and be treated as a confidential medical record, except that:

(i) Supervisors and managers may be informed regarding necessary restrictions on the work or duties of the employee and necessary accommodations;

(ii) First aid and safety personnel may be informed, when appropriate, if the disability might require emergency treatment; and

(iii) Government officials investigating compliance with this part shall be provided relevant information on request.

(2) The results of such examination shall not be used for any purpose inconsistent with this part.

(3) Medical examinations conducted in accordance with this section do not have to be job-related and consistent with business necessity. However, if certain criteria are used to screen out an employee or employees with disabilities as a result of such an examination or inquiry, the exclusionary criteria must be job-related and consistent with business necessity, and performance of the essential job functions cannot be accomplished with reasonable accommodation as required in this part. (See § 1630.15(b) Defenses to charges of discriminatory application of selection criteria.)

(c) *Examination of employees.* A covered entity may require a medical examination (and/or inquiry) of an employee that is job-related and consistent with business necessity. A covered entity may make inquiries into the ability of an employee to perform job-related functions.

(1) Information obtained under paragraph (c) of this section regarding the medical condition or history of any employee shall be collected and maintained on separate forms and in separate medical files and be treated as a confidential medical record, except that:

(i) Supervisors and managers may be informed regarding necessary restrictions on the work or duties of the employee and necessary accommodations;

(ii) First aid and safety personnel may be informed, when appropriate, if the

disability might require emergency treatment; and

(iii) Government officials investigating compliance with this part shall be provided relevant information on request.

(2) Information obtained under paragraph (c) of this section regarding the medical condition or history of any employee shall not be used for any purpose inconsistent with this part.

(d) *Other acceptable examinations and inquiries.* A covered entity may conduct voluntary medical examinations and activities, including voluntary medical histories, which are part of an employee health program available to employees at the work site.

(1) Information obtained under paragraph (d) of this section regarding the medical condition or history of any employee shall be collected and maintained on separate forms and in separate medical files and be treated as a confidential medical record, except that:

(i) Supervisors and managers may be informed regarding necessary restrictions on the work or duties of the employee and necessary accommodations;

(ii) First aid and safety personnel may be informed, when appropriate, if the disability might require emergency treatment; and

(iii) Government officials investigating compliance with this part shall be provided relevant information on request.

(2) Information obtained under paragraph (d) of this section regarding the medical condition or history of any employee shall not be used for any purpose inconsistent with this part.

§ 1630.15 Defenses.

Defenses to an allegation of discrimination under this part may include, but are not limited to, the following:

(a) *Disparate treatment charges.* It may be a defense to a charge of disparate treatment brought under §§ 1630.4 through 1630.8 and 1630.11 through 1630.12 that the challenged action is justified by a legitimate, nondiscriminatory reason.

(b) *Charges of discriminatory application of selection criteria—(1) In general.* It may be a defense to a charge of discrimination, as described in § 1630.10, that an alleged application of qualification standards, tests, or selection criteria that screens out or tends to screen out or otherwise denies a job or benefit to an individual with a disability has been shown to be job-related and consistent with business necessity, and such performance cannot

be accomplished with reasonable accommodation, as required in this part.

(2) *Direct threat as a qualification standard.* The term "qualification standard" may include a requirement that an individual shall not pose a direct threat to the health or safety of the individual or others in the workplace. (See § 1630.2(r) defining direct threat.)

(c) *Other disparate impact charges.* It may be a defense to a charge of discrimination brought under this part that a uniformly applied standard, criterion, or policy has a disparate impact on an individual with a disability or a class of individuals with disabilities that the challenged standard, criterion or policy has been shown to be job-related and consistent with business necessity, and such performance cannot be accomplished with reasonable accommodation, as required in this part.

(d) *Charges of not making reasonable accommodation.* It may be a defense to a charge of discrimination, as described in § 1630.9, that a requested or necessary accommodation would impose an undue hardship on the operation of the covered entity's business.

(e) *Conflict with other federal laws.* It may be a defense to a charge of discrimination under this part that a challenged action is required or necessitated by another Federal law or regulation, or that another Federal law or regulation prohibits an action (including the provision of a particular reasonable accommodation) that would otherwise be required by this part.

(f) *Additional defenses.* It may be a defense to a charge of discrimination under this part that the alleged discriminatory action is specifically permitted by §§ 1630.14 or 1630.16.

§ 1630.16 Specific activities permitted.

(a) *Religious entities.* A religious corporation, association, educational institution, or society is permitted to give preference in employment to individuals of a particular religion to perform work connected with the carrying on by that corporation, association, educational institution, or society of its activities. A religious entity may require that all applicants and employees conform to the religious tenets of such organization. However, a religious entity may not discriminate against a qualified individual, who satisfies the permitted religious criteria, because of his or her disability.

(b) *Regulation of alcohol and drugs.* A covered entity:

(1) May prohibit the illegal use of drugs and the use of alcohol at the workplace by all employees;

(2) May require that employees not be under the influence of alcohol or be engaging in the illegal use of drugs at the workplace;

(3) May require that all employees behave in conformance with the requirements established under the Drug-Free Workplace Act of 1988 (41 U.S.C. 701 et seq.);

(4) May hold an employee who engages in the illegal use of drugs or who is an alcoholic to the same qualification standards for employment or job performance and behavior to which the entity holds its other employees, even if any unsatisfactory performance or behavior is related to the employee's drug use or alcoholism;

(5) May require that its employees employed in an industry subject to such regulations comply with the standards established in the regulations (if any) of the Departments of Defense and Transportation, and of the Nuclear Regulatory Commission, regarding alcohol and the illegal use of drugs; and

(6) May require that employees employed in sensitive positions comply with the regulations (if any) of the Departments of Defense and Transportation and of the Nuclear Regulatory Commission that apply to employment in sensitive positions subject to such regulations.

(c) *Drug testing*—(1) *General policy.* For purposes of this part, a test to determine the illegal use of drugs is not considered a medical examination.

Thus, the administration of such drug tests by a covered entity to its job applicants or employees is not a violation of § 1630.13 of this part. However, this part does not encourage, prohibit, or authorize a covered entity to conduct drug tests of job applicants or employees to determine the illegal use of drugs or to make employment decisions based on such test results.

(2) *Transportation Employees.* This part does not encourage, prohibit, or authorize the otherwise lawful exercise by entities subject to the jurisdiction of the Department of Transportation of authority to:

(i) Test employees of entities in, and applicants for, positions involving safety sensitive duties for the illegal use of drugs or for on-duty impairment by alcohol; and

(ii) Remove from safety-sensitive positions persons who test positive for illegal use of drugs or on-duty impairment by alcohol pursuant to paragraph (c)(2)(i) of this section.

(3) *Confidentiality.* Any information regarding the medical condition or history of any employee or applicant obtained from a test to determine the illegal use of drugs, except information

regarding the illegal use of drugs, is subject to the requirements of § 1630.14(b) (2) and (3) of this part.

(d) *Regulation of smoking.* A covered entity may prohibit or impose restrictions on smoking in places of employment. Such restrictions do not violate any provision of this part.

(e) *Infectious and communicable diseases; food handling jobs*—(1) *In general.* Under title I of the ADA, section 103(d)(1), the Secretary of Health and Human Services is to prepare a list, to be updated annually, of infectious and communicable diseases which are transmitted through the handling of food. (Copies may be obtained from Center for Infectious Diseases, Centers for Disease Control, 1600 Clifton Road, NE., Mailstop C09, Atlanta, GA 30333.) If an individual with a disability is disabled by one of the infectious or communicable diseases included on this list, and if the risk of transmitting the disease associated with the handling of food cannot be eliminated by reasonable accommodation, a covered entity may refuse to assign or continue to assign such individual to a job involving food handling. However, if the individual with a disability is a current employee, the employer must consider whether he or she can be accommodated by reassignment to a vacant position not involving food handling.

(2) *Effect on state or other laws.* This part does not preempt, modify, or amend any State, county, or local law, ordinance or regulation applicable to food handling which:

(i) Is in accordance with the list, referred to in paragraph (e)(1) of this section, of infectious or communicable diseases and the modes of transmissibility published by the Secretary of Health and Human Services; and

(ii) Is designed to protect the public health from individuals who pose a significant risk to the health or safety of others, where that risk cannot be eliminated by reasonable accommodation.

(f) *Health insurance, life insurance, and other benefit plans*—(1) An insurer, hospital, or medical service company, health maintenance organization, or any agent or entity that administers benefit plans, or similar organizations may underwrite risks, classify risks, or administer such risks that are based on or not inconsistent with State law.

(2) A covered entity may establish, sponsor, observe or administer the terms of a bona fide benefit plan that are based on underwriting risks, classifying risks, or administering such risks that

are based on or not inconsistent with State law.

(3) A covered entity may establish, sponsor, observe, or administer the terms of a bona fide benefit plan that is not subject to State laws that regulate insurance.

(4) The activities described in paragraphs (f) (1), (2), and (3) of this section are permitted unless these activities are being used as a subterfuge to evade the purposes of this part.

Appendix to Part 1630—Interpretive Guidance on Title I of the Americans with Disabilities Act

Background

The ADA is a federal antidiscrimination statute designed to remove barriers which prevent qualified individuals with disabilities from enjoying the same employment opportunities that are available to persons without disabilities.

Like the Civil Rights Act of 1964 that prohibits discrimination on the bases of race, color, religion, national origin, and sex, the ADA seeks to ensure access to equal employment opportunities based on merit. It does not guarantee equal results, establish quotas, or require preferences favoring individuals with disabilities over those without disabilities.

However, while the Civil Rights Act of 1964 prohibits any consideration of personal characteristics such as race or national origin, the ADA necessarily takes a different approach. When an individual's disability creates a barrier to employment opportunities, the ADA requires employers to consider whether reasonable accommodation could remove the barrier.

The ADA thus establishes a process in which the employer must assess a disabled individual's ability to perform the essential functions of the specific job held or desired. While the ADA focuses on eradicating barriers, the ADA does not relieve a disabled employee or applicant from the obligation to perform the essential functions of the job. To the contrary, the ADA is intended to enable disabled persons to compete in the workplace based on the same performance standards and requirements that employers expect of persons who are not disabled.

However, where that individual's functional limitation impedes such job performance, an employer must take steps to reasonably accommodate, and thus help overcome the particular impediment, unless to do so would impose an undue hardship. Such accommodations usually take the form of adjustments to the way a job customarily is performed, or to the work environment itself.

This process of identifying whether, and to what extent, a reasonable accommodation is required should be flexible and involve both the employer and the individual with a disability. Of course, the determination of whether an individual is qualified for a particular position must necessarily be made on a case-by-case basis. No specific form of accommodation is guaranteed for all individuals with a particular disability.

Rather, an accommodation must be tailored to match the needs of the disabled individual with the needs of the job's essential functions.

This case-by-case approach is essential if qualified individuals of varying abilities are to receive equal opportunities to compete for an infinitely diverse range of jobs. For this reason, neither the ADA nor this part can supply the "correct" answer in advance for each employment decision concerning an individual with a disability. Instead, the ADA simply establishes parameters to guide employers in how to consider, and take into account, the disabling condition involved.

Introduction

The Equal Employment Opportunity Commission (the Commission or EEOC) is responsible for enforcement of title I of the Americans with Disabilities Act (ADA), 42 U.S.C. 12101 *et seq.* (1990), which prohibits employment discrimination on the basis of disability. The Commission believes that it is essential to issue interpretive guidance concurrently with the issuance of this part in order to ensure that qualified individuals with disabilities understand their rights under this part and to facilitate and encourage compliance by covered entities. This appendix represents the Commission's interpretation of the issues discussed, and the Commission will be guided by it when resolving charges of employment discrimination. The appendix addresses the major provisions of this part and explains the major concepts of disability rights.

The terms "employer" or "employer or other covered entity" are used interchangeably throughout the appendix to refer to all covered entities subject to the employment provisions of the ADA.

Section 1630.1 Purpose, Applicability and Construction

Section 1630.1(a) Purpose

The Americans with Disabilities Act was signed into law on July 26, 1990. It is an antidiscrimination statute that requires that individuals with disabilities be given the same consideration for employment that individuals without disabilities are given. An individual who is qualified for an employment opportunity cannot be denied that opportunity because of the fact that the individual is disabled. The purpose of title I and this part is to ensure that qualified individuals with disabilities are protected from discrimination on the basis of disability.

The ADA uses the term "disabilities" rather than the term "handicaps" used in the Rehabilitation Act of 1973, 29 U.S.C. 701-796. Substantively, these terms are equivalent. As noted by the House Committee on the Judiciary, "[t]he use of the term 'disabilities' instead of the term 'handicaps' reflects the desire of the Committee to use the most current terminology. It reflects the preference of persons with disabilities to use that term rather than 'handicapped' as used in previous laws, such as the Rehabilitation Act of 1973 * * * H.R. Rep. No. 485 part 3, 101st Cong., 2d Sess. 26-27 (1990) (hereinafter House Judiciary Report); see also S. Rep. No. 116, 101st Cong., 1st Sess. 21 (1989) (hereinafter Senate Report); H.R. Rep. No. 485 part 2, 101st

Cong., 2d Sess. 50-51 (1990) [hereinafter House Labor Report].

The use of the term "Americans" in the title of the ADA is not intended to imply that the Act only applies to United States citizens. Rather, the ADA protects all qualified individuals with disabilities, regardless of their citizenship status or nationality.

Section 1630.1(b) and (c) Applicability and Construction

Unless expressly stated otherwise, the standards applied in the ADA are not intended to be lesser than the standards applied under the Rehabilitation Act of 1973.

The ADA does not preempt any Federal law, or any state or local law, that grants to individuals with disabilities protection greater than or equivalent to that provided by the ADA. This means that the existence of a lesser standard of protection to individuals with disabilities under the ADA will not provide a defense to failing to meet a higher standard under another law. Thus, for example, title I of the ADA would not be a defense to failing to collect information required to satisfy the affirmative action requirements of section 503 of the Rehabilitation Act. On the other hand, the existence of a lesser standard under another law will not provide a defense to failing to meet a higher standard under the ADA. See House Labor Report at 135; House Judiciary Report at 69-70.

This also means that an individual with a disability could choose to pursue claims under a state discrimination or tort law that does not confer greater substantive rights, or even confers fewer substantive rights, if the potential available remedies would be greater than those available under the ADA and this part. The ADA does not restrict an individual with a disability from pursuing such claims in addition to charges brought under this part. House Judiciary at 69-70.

The ADA does not automatically preempt medical standards or safety requirements established by Federal law or regulations. It does not preempt State, county, or local laws, ordinances or regulations that are consistent with this part, and are designed to protect the public health from individuals who pose a direct threat, that cannot be eliminated or reduced by reasonable accommodation, to the health or safety of others. However, the ADA does preempt inconsistent requirements established by state or local law for safety or security sensitive positions. See Senate Report at 27; House Labor Report at 57.

An employer allegedly in violation of this part cannot successfully defend its actions by relying on the obligation to comply with the requirements of any state or local law that imposes prohibitions or limitations on the eligibility of qualified individuals with disabilities to practice any occupation or profession. For example, suppose a municipality has an ordinance that prohibits individuals with tuberculosis from teaching school children. If an individual with dormant tuberculosis challenges a private school's refusal to hire him or her because of the tuberculosis, the private school would not be able to rely on the city ordinance as a defense under the ADA.

Sections 1630.2(o)-(f) Commission, Covered Entity, etc.

The definitions section of part 1630 includes several terms that are identical, or almost identical, to the terms found in title VII of the Civil Rights Act of 1964. Among these terms are "Commission," "Person," "State," and "Employer." These terms are to be given the same meaning under the ADA that they are given under title VII.

In general, the term "employee" has the same meaning that it is given under title VII. However, the ADA's definition of "employee" does not contain an exception, as does title VII, for elected officials and their personal staffs. It should be further noted that all state and local governments are covered by title II of the ADA whether or not they are also covered by this part. Title II, which is enforced by the Department of Justice, becomes effective on January 26, 1992. See 28 CFR part 35.

The term "covered entity" is not found in title VII. However, the title VII definitions of the entities included in the term "covered entity" (e.g., employer, employment agency, etc.) are applicable to the ADA.

Section 1630.2(g) Disability

In addition to the term "covered entity," there are several other terms that are unique to the ADA. The first of these is the term "disability." Congress adopted the definition of this term from the Rehabilitation Act definition of the term "individual with handicaps." By so doing, Congress intended that the relevant caselaw developed under the Rehabilitation Act be generally applicable to the term "disability" as used in the ADA. Senate Report at 21; House Labor Report at 50; House Judiciary Report at 27.

The definition of the term "disability" is divided into three parts. An individual must satisfy at least one of these parts in order to be considered an individual with a disability for purposes of this part. An individual is considered to have a "disability" if that individual either (1) has a physical or mental impairment which substantially limits one or more of that person's major life activities, (2) has a record of such an impairment, or, (3) is regarded by the covered entity as having such an impairment. To understand the meaning of the term "disability," it is necessary to understand, as a preliminary matter, what is meant by the terms "physical or mental impairment," "major life activity," and "substantially limits." Each of these terms is discussed below.

Section 1630.2(h) Physical or Mental Impairment

This term adopts the definition of the term "physical or mental impairment" found in the regulations implementing section 504 of the Rehabilitation Act at 34 CFR part 104. It defines physical or mental impairment as any physiological disorder or condition, cosmetic disfigurement, or anatomical loss affecting one or more of several body systems, or any mental or psychological disorder.

The existence of an impairment is to be determined without regard to mitigating measures such as medicines, or assistive or prosthetic devices. See Senate Report at 23,

House Labor Report at 52, House Judiciary Report at 28. For example, an individual with epilepsy would be considered to have an impairment even if the symptoms of the disorder were completely controlled by medicine. Similarly, an individual with hearing loss would be considered to have an impairment even if the condition were correctable through the use of a hearing aid.

It is important to distinguish between conditions that are impairments and physical, psychological, environmental, cultural and economic characteristics that are not impairments. The definition of the term "impairment" does not include physical characteristics such as eye color, hair color, left-handedness, or height, weight or muscle tone that are within "normal" range and are not the result of a physiological disorder. The definition, likewise, does not include characteristic predisposition to illness or disease. Other conditions, such as pregnancy, that are not the result of a physiological disorder are also not impairments. Similarly, the definition does not include common personality traits such as poor judgment or a quick temper where these are not symptoms of a mental or psychological disorder. Environmental, cultural, or economic disadvantages such as poverty, lack of education or a prison record are not impairments. Advanced age, in and of itself, is also not an impairment. However, various medical conditions commonly associated with age, such as hearing loss, osteoporosis, or arthritis would constitute impairments within the meaning of this part. See Senate Report at 22-23; House Labor Report at 51-52; House Judiciary Report at 28-29.

Section 1630.2(i) Major Life Activities

This term adopts the definition of the term "major life activities" found in the regulations implementing section 504 of the Rehabilitation Act at 34 CFR part 104. "Major life activities" are those basic activities that the average person in the general population can perform with little or no difficulty. Major life activities include caring for oneself, performing manual tasks, walking, seeing, hearing, speaking, breathing, learning, and working. This list is not exhaustive. For example, other major life activities include, but are not limited to, sitting, standing, lifting, reaching. See Senate Report at 22; House Labor Report at 52; House Judiciary Report at 28.

Section 1630.2(j) Substantially Limits

Determining whether a physical or mental impairment exists is only the first step in determining whether or not an individual is disabled. Many impairments do not impact an individual's life to the degree that they constitute disabling impairments. An impairment rises to the level of disability if the impairment substantially limits one or more of the individual's major life activities. Multiple impairments that combine to substantially limit one or more of an individual's major life activities also constitute a disability.

The ADA and this part, like the Rehabilitation Act of 1973, do not attempt a "laundry list" of impairments that are "disabilities." The determination of whether

an individual has a disability is not necessarily based on the name or diagnosis of the impairment the person has, but rather on the effect of that impairment on the life of the individual. Some impairments may be disabling for particular individuals but not for others, depending on the stage of the disease or disorder, the presence of other impairments that combine to make the impairment disabling or any number of other factors.

Other impairments, however, such as HIV infection, are inherently substantially limiting.

On the other hand, temporary, non-chronic impairments of short duration, with little or no long term or permanent impact, are usually not disabilities. Such impairments may include, but are not limited to, broken limbs, sprained joints, concussions, appendicitis, and influenza. Similarly, except in rare circumstances, obesity is not considered a disabling impairment.

An impairment that prevents an individual from performing a major life activity substantially limits that major life activity. For example, an individual whose legs are paralyzed is substantially limited in the major life activity of walking because he or she is unable, due to the impairment, to perform that major life activity.

Alternatively, an impairment is substantially limiting if it significantly restricts the duration, manner or condition under which an individual can perform a particular major life activity as compared to the average person in the general population's ability to perform that same major life activity. Thus, for example, an individual who, because of an impairment, can only walk for very brief periods of time would be substantially limited in the major life activity of walking. An individual who uses artificial legs would likewise be substantially limited in the major life activity of walking because the individual is unable to walk without the aid of prosthetic devices. Similarly, a diabetic who without insulin would lapse into a coma would be substantially limited because the individual cannot perform major life activities without the aid of medication. See Senate Report at 23; House Labor Report at 52. It should be noted that the term "average person" is not intended to imply a precise mathematical "average."

Part 1630 notes several factors that should be considered in making the determination of whether an impairment is substantially limiting. These factors are (1) the nature and severity of the impairment, (2) the duration or expected duration of the impairment, and (3) the permanent or long term impact, or the expected permanent or long term impact of, or resulting from, the impairment. The term "duration," as used in this context, refers to the length of time an impairment persists, while the term "impact" refers to the residual effects of an impairment. Thus, for example, a broken leg that takes eight weeks to heal is an impairment of fairly brief duration. However, if the broken leg heals improperly, the "impact" of the impairment would be the resulting permanent limp. Likewise, the effect on cognitive functions resulting from traumatic head injury would be the "impact" of that impairment.

The determination of whether an individual is substantially limited in a major life activity must be made on a case by case basis, without regard to mitigating measures such as medicines, or assistive or prosthetic devices. An individual is not substantially limited in a major life activity if the limitation, when viewed in light of the factors noted above, does not amount to a significant restriction when compared with the abilities of the average person. For example, an individual who had once been able to walk at an extraordinary speed would not be substantially limited in the major life activity of walking if, as a result of a physical impairment, he or she were only able to walk at an average speed, or even at moderately below average speed.

It is important to remember that the restriction on the performance of the major life activity must be the result of a condition that is an impairment. As noted earlier, advanced age, physical or personality characteristics, and environmental, cultural, and economic disadvantages are not impairments. Consequently, even if such factors substantially limit an individual's ability to perform a major life activity, this limitation will not constitute a disability. For example, an individual who is unable to read because he or she was never taught to read would not be an individual with a disability because lack of education is not an impairment. However, an individual who is unable to read because of dyslexia would be an individual with a disability because dyslexia, a learning disability, is an impairment.

If an individual is not substantially limited with respect to any other major life activity, the individual's ability to perform the major life activity of working should be considered. If an individual is substantially limited in any other major life activity, no determination should be made as to whether the individual is substantially limited in working. For example, if an individual is blind, *i.e.*, substantially limited in the major life activity of seeing, there is no need to determine whether the individual is also substantially limited in the major life activity of working. The determination of whether an individual is substantially limited in working must also be made on a case by case basis.

This part lists specific factors that may be used in making the determination of whether the limitation in working is "substantial." These factors are:

(1) The geographical area to which the individual has reasonable access;

(2) The job from which the individual has been disqualified because of an impairment, and the number and types of jobs utilizing similar training, knowledge, skills or abilities, within that geographical area, from which the individual is also disqualified because of the impairment (class of jobs); and/or

(3) The job from which the individual has been disqualified because of an impairment, and the number and types of other jobs not utilizing similar training, knowledge, skills or abilities, within that geographical area, from which the individual is also disqualified because of the impairment (broad range of jobs in various classes).

Thus, an individual is not substantially limited in working just because he or she is unable to perform a particular job for one employer, or because he or she is unable to perform a specialized job or profession requiring extraordinary skill, prowess or talent. For example, an individual who cannot be a commercial airline pilot because of a minor vision impairment, but who can be a commercial airline co-pilot or a pilot for a courier service, would not be substantially limited in the major life activity of working. Nor would a professional baseball pitcher who develops a bad elbow and can no longer throw a baseball be considered substantially limited in the major life activity of working. In both of these examples, the individuals are not substantially limited in the ability to perform any other major life activity and, with regard to the major life activity of working, are only unable to perform either a particular specialized job or a narrow range of jobs. See *Forrisi v. Bowen*, 794 F.2d 931 (4th Cir. 1986); *Jasany v. U.S. Postal Service*, 755 F.2d 1244 (6th Cir. 1985); *EE Block, Ltd. v. Marshall*, 497 F. Supp. 1068 (D. Hawaii 1980).

On the other hand, an individual does not have to be totally unable to work in order to be considered substantially limited in the major life activity of working. An individual is substantially limited in working if the individual is significantly restricted in the ability to perform a class of jobs or a broad range of jobs in various classes, when compared with the ability of the average person with comparable qualifications to perform those same jobs. For example, an individual who has a back condition that prevents the individual from performing any heavy labor job would be substantially limited in the major life activity of working because the individual's impairment eliminates his or her ability to perform a class of jobs. This would be so even if the individual were able to perform jobs in another class, e.g., the class of semi-skilled jobs. Similarly, suppose an individual has an allergy to a substance found in most high rise office buildings, but seldom found elsewhere, that makes breathing extremely difficult. Since this individual would be substantially limited in the ability to perform the broad range of jobs in various classes that are conducted in high rise office buildings within the geographical area to which he or she has reasonable access, he or she would be substantially limited in working.

The terms "number and types of jobs" and "number and types of other jobs," as used in the factors discussed above, are not intended to require an onerous evidentiary showing. Rather, the terms only require the presentation of evidence of general employment demographics and/or of recognized occupational classifications that indicate the approximate number of jobs (e.g., "few," "many," "most") from which an individual would be excluded because of an impairment.

If an individual has a "mental or physical impairment" that "substantially limits" his or her ability to perform one or more "major life activities," that individual will satisfy the first part of the regulatory definition of "disability" and will be considered an individual with a disability. An individual

who satisfies this first part of the definition of the term "disability" is not required to demonstrate that he or she satisfies either of the other parts of the definition. However, if an individual is unable to satisfy this part of the definition, he or she may be able to satisfy one of the other parts of the definition.

Section 1630.2(k) Record of a Substantially Limiting Condition

The second part of the definition provides that an individual with a record of an impairment that substantially limits a major life activity is an individual with a disability. The intent of this provision, in part, is to ensure that people are not discriminated against because of a history of disability. For example, this provision protects former cancer patients from discrimination based on their prior medical history. This provision also ensures that individuals are not discriminated against because they have been misclassified as disabled. For example, individuals misclassified as learning disabled are protected from discrimination on the basis of that erroneous classification. Senate Report at 23; House Labor Report at 52-53; House Judiciary Report at 29.

This part of the definition is satisfied if a record relied on by an employer indicates that the individual has or has had a substantially limiting impairment. The impairment indicated in the record must be an impairment that would substantially limit one or more of the individual's major life activities. There are many types of records that could potentially contain this information, including but not limited to, education, medical, or employment records.

The fact that an individual has a record of being a disabled veteran, or of disability retirement, or is classified as disabled for other purposes does not guarantee that the individual will satisfy the definition of "disability" under part 1630. Other statutes, regulations and programs may have a definition of "disability" that is not the same as the definition set forth in the ADA and contained in part 1630. Accordingly, in order for an individual who has been classified in a record as "disabled" for some other purpose to be considered disabled for purposes of part 1630, the impairment indicated in the record must be a physical or mental impairment that substantially limits one or more of the individual's major life activities.

Section 1630.2(l) Regarded as Substantially Limited in a Major Life Activity

If an individual cannot satisfy either the first part of the definition of "disability" or the second "record of" part of the definition, he or she may be able to satisfy the third part of the definition. The third part of the definition provides that an individual who is regarded by an employer or other covered entity as having an impairment that substantially limits a major life activity is an individual with a disability.

There are three different ways in which an individual may satisfy the definition of "being regarded as having a disability":

(1) The individual may have an impairment which is not substantially limiting but is perceived by the employer or other covered entity as constituting a substantially limiting impairment;

(2) The individual may have an impairment which is only substantially limiting because of the attitudes of others toward the impairment; or

(3) The individual may have no impairment at all but is regarded by the employer or other covered entity as having a substantially limiting impairment.

Senate Report at 23; House Labor Report at 53; House Judiciary Report at 29.

An individual satisfies the first part of this definition if the individual has an impairment that is not substantially limiting, but the covered entity perceives the impairment as being substantially limiting. For example, suppose an employee has controlled high blood pressure that is not substantially limiting. If an employer reassigns the individual to less strenuous work because of unsubstantiated fears that the individual will suffer a heart attack if he or she continues to perform strenuous work, the employer would be regarding the individual as disabled.

An individual satisfies the second part of the "regarded as" definition if the individual has an impairment that is only substantially limiting because of the attitudes of others toward the condition. For example, an individual may have a prominent facial scar or disfigurement, or may have a condition that periodically causes an involuntary jerk of the head but does not limit the individual's major life activities. If an employer discriminates against such an individual because of the negative reactions of customers, the employer would be regarding the individual as disabled and acting on the basis of that perceived disability. See Senate Report at 24; House Labor Report at 53; House Judiciary Report at 30-31.

An individual satisfies the third part of the "regarded as" definition of "disability" if the employer or other covered entity erroneously believes the individual has a substantially limiting impairment that the individual actually does not have. This situation could occur, for example, if an employer discharged an employee in response to a rumor that the employee is infected with Human Immunodeficiency Virus (HIV). Even though the rumor is totally unfounded and the individual has no impairment at all, the individual is considered an individual with a disability because the employer perceived of this individual as being disabled. Thus, in this example, the employer, by discharging this employee, is discriminating on the basis of disability.

The rationale for the "regarded as" part of the definition of disability was articulated by the Supreme Court in the context of the Rehabilitation Act of 1973 in *School Board of Nassau County v. Arline*, 480 U.S. 273 (1987). The Court noted that, although an individual may have an impairment that does not in fact substantially limit a major life activity, the reaction of others may prove just as disabling. "Such an impairment might not diminish a person's physical or mental capabilities, but could nevertheless substantially limit that person's ability to work as a result of the negative reactions of others to the impairment." 480 U.S. at 283. The Court concluded that by including "regarded as" in the Rehabilitation Act's

definition, "Congress acknowledged that society's accumulated myths and fears about disability and diseases are as handicapping as are the physical limitations that flow from actual impairment." 480 U.S. at 284.

An individual rejected from a job because of the "myths, fears and stereotypes" associated with disabilities would be covered under this part of the definition of disability, whether or not the employer's or other covered entity's perception were shared by others in the field and whether or not the individual's actual physical or mental condition would be considered a disability under the first or second part of this definition. As the legislative history notes, sociologists have identified common attitudinal barriers that frequently result in employers excluding individuals with disabilities. These include concerns regarding productivity, safety, insurance, liability, attendance, cost of accommodation and accessibility, workers' compensation costs, and acceptance by coworkers and customers.

Therefore, if an individual can show that an employer or other covered entity made an employment decision because of a perception of disability based on "myth, fear or stereotype," the individual will satisfy the "regarded as" part of the definition of disability. If the employer cannot articulate a non-discriminatory reason for the employment action, an inference that the employer is acting on the basis of "myth, fear or stereotype" can be drawn.

Section 1630.2(m) Qualified Individual With a Disability

The ADA prohibits discrimination on the basis of disability against qualified individuals with disabilities. The determination of whether an individual with a disability is "qualified" should be made in two steps. The first step is to determine if the individual satisfies the prerequisites for the position, such as possessing the appropriate educational background, employment experience, skills, licenses, etc. For example, the first step in determining whether an accountant who is paraplegic is qualified for a certified public accountant (CPA) position is to examine the individual's credentials to determine whether the individual is a licensed CPA. This is sometimes referred to in the Rehabilitation Act caselaw as determining whether the individual is "otherwise qualified" for the position. See Senate Report at 33; House Labor Report at 64-65. (See § 1630.9 Not Making Reasonable Accommodation).

The second step is to determine whether or not the individual can perform the essential functions of the position held or desired, with or without reasonable accommodation. The purpose of this second step is to ensure that individuals with disabilities who can perform the essential functions of the position held or desired are not denied employment opportunities because they are not able to perform marginal functions of the position. House Labor Report at 55.

The determination of whether an individual with a disability is qualified is to be made at the time of the employment decision. This determination should be based on the capabilities of the individual with a disability

at the time of the employment decision, and should not be based on speculation that the employee may become unable in the future or may cause increased health insurance premiums or workers compensation costs.

Section 1630.2(n) Essential Functions

The determination of which functions are essential may be critical to the determination of whether or not the individual with a disability is qualified. The essential functions are those functions that the individual who holds the position must be able to perform unaided or with the assistance of a reasonable accommodation.

The inquiry into whether a particular function is essential initially focuses on whether the employer actually requires employees in the position to perform the functions that the employer asserts are essential. For example, an employer may state that typing is an essential function of a position. If, in fact, the employer has never required any employee in that particular position to type, this will be evidence that typing is not actually an essential function of the position.

If the individual who holds the position is actually required to perform the function the employer asserts is an essential function, the inquiry will then center around whether removing the function would fundamentally alter that position. This determination of whether or not a particular function is essential will generally include one or more of the following factors listed in part 1630.

The first factor is whether the position exists to perform a particular function. For example, an individual may be hired to proofread documents. The ability to proofread the documents would then be an essential function, since this is the only reason the position exists.

The second factor in determining whether a function is essential is the number of other employees available to perform that job function or among whom the performance of that job function can be distributed. This may be a factor either because the total number of available employees is low, or because of the fluctuating demands of the business operation. For example, if an employer has a relatively small number of available employees for the volume of work to be performed, it may be necessary that each employee perform a multitude of different functions. Therefore, the performance of those functions by each employee becomes more critical and the options for reorganizing the work become more limited. In such a situation, functions that might not be essential if there were a larger staff may become essential because the staff size is small compared to the volume of work that has to be done. See *Treadwell v. Alexander*, 707 F.2d 473 (11th Cir. 1983).

A similar situation might occur in a larger work force if the workflow follows a cycle of heavy demand for labor intensive work followed by low demand periods. This type of workflow might also make the performance of each function during the peak periods more critical and might limit the employer's flexibility in reorganizing operating procedures. See *Dexler v. Tisch*, 660 F. Supp. 1418 (D. Conn. 1987).

The third factor is the degree of expertise or skill required to perform the function. In certain professions and highly skilled positions the employee is hired for his or her expertise or ability to perform the particular function. In such a situation, the performance of that specialized task would be an essential function.

Whether a particular function is essential is a factual determination that must be made on a case by case basis. In determining whether or not a particular function is essential, all relevant evidence should be considered. Part 1630 lists various types of evidence, such as an established job description, that should be considered in determining whether a particular function is essential. Since the list is not exhaustive, other relevant evidence may also be presented. Greater weight will not be granted to the types of evidence included on the list than to the types of evidence not listed.

Although part 1630 does not require employers to develop or maintain job descriptions, written job descriptions prepared before advertising or interviewing applicants for the job, as well as the employer's judgment as to what functions are essential are among the relevant evidence to be considered in determining whether a particular function is essential. The terms of a collective bargaining agreement are also relevant to the determination of whether a particular function is essential. The work experience of past employees in the job or of current employees in similar jobs is likewise relevant to the determination of whether a particular function is essential. See H.R. Conf. Rep. No. 101-596, 101st Cong., 2d Sess. 58 (1990) [hereinafter Conference Report]; House Judiciary Report at 33-34. See also *Hall v. U.S. Postal Service*, 857 F.2d 1073 (6th Cir. 1988).

The time spent performing the particular function may also be an indicator of whether that function is essential. For example, if an employee spends the vast majority of his or her time working at a cash register, this would be evidence that operating the cash register is an essential function. The consequences of failing to require the employee to perform the function may be another indicator of whether a particular function is essential. For example, although a firefighter may not regularly have to carry an unconscious adult out of a burning building, the consequence of failing to require the firefighter to be able to perform this function would be serious.

It is important to note that the inquiry into essential functions is not intended to second guess an employer's business judgment with regard to production standards, whether qualitative or quantitative, nor to require employers to lower such standards. (See § 1630.10 Qualification Standards, Tests and Other Selection Criteria). If an employer requires its typists to be able to accurately type 75 words per minute, it will not be called upon to explain why an inaccurate work product, or a typing speed of 85 words per minute, would not be adequate. Similarly, if a hotel requires its service workers to thoroughly clean 16 rooms per day, it will not have to explain why it requires thorough

cleaning, or why it chose a 16 room rather than a 10 room requirement. However, if an employer does require accurate 75 word per minute typing or the thorough cleaning of 16 rooms, it will have to show that it actually imposes such requirements on its employees in fact, and not simply on paper. It should also be noted that, if it is alleged that the employer intentionally selected the particular level of production to exclude individuals with disabilities, the employer may have to offer a legitimate, nondiscriminatory reason for its selection.

Section 1630.2(o) Reasonable Accommodation

An individual is considered a "qualified individual with a disability" if the individual can perform the essential functions of the position held or desired with or without reasonable accommodation. In general, an accommodation is any change in the work environment or in the way things are customarily done that enables an individual with a disability to enjoy equal employment opportunities. There are three categories of reasonable accommodation. These are (1) accommodations that are required to ensure equal opportunity in the application process; (2) accommodations that enable the employer's employees with disabilities to perform the essential functions of the position held or desired; and (3) accommodations that enable the employer's employees with disabilities to enjoy equal benefits and privileges of employment as are enjoyed by employees without disabilities. It should be noted that nothing in this part prohibits employers or other covered entities from providing accommodations beyond those required by this part.

Part 1630 lists the examples, specified in title I of the ADA, of the most common types of accommodation that an employer or other covered entity may be required to provide. There are any number of other specific accommodations that may be appropriate for particular situations but are not specifically mentioned in this listing. This listing is not intended to be exhaustive of accommodation possibilities. For example, other accommodations could include permitting the use of accrued paid leave or providing additional unpaid leave for necessary treatment, making employer provided transportation accessible, and providing reserved parking spaces. Providing personal assistants, such as a page turner for an employee with no hands or a travel attendant to act as a sighted guide to assist a blind employee on occasional business trips, may also be a reasonable accommodation. Senate Report at 31; House Labor Report at 62; House Judiciary Report at 39.

It may also be a reasonable accommodation to permit an individual with a disability the opportunity to provide and utilize equipment, aids or services that an employer is not required to provide as a reasonable accommodation. For example, it would be a reasonable accommodation for an employer to permit an individual who is blind to use a guide dog at work, even though the employer would not be required to provide a guide dog for the employee.

The accommodations included on the list of reasonable accommodations are generally

self explanatory. However, there are a few that require further explanation. One of these is the accommodation of making existing facilities used by employees readily accessible to, and usable by, individuals with disabilities. This accommodation includes both those areas that must be accessible for the employee to perform essential job functions, as well as non-work areas used by the employer's employees for other purposes. For example, accessible break rooms, lunch rooms, training rooms, restrooms etc., may be required as reasonable accommodations.

Another of the potential accommodations listed is "job restructuring." An employer or other covered entity may restructure a job by reallocating or redistributing nonessential, marginal job functions. For example, an employer may have two jobs, each of which entails the performance of a number of marginal functions. The employer hires a qualified individual with a disability who is able to perform some of the marginal functions of each job but not all of the marginal functions of either job. As an accommodation, the employer may redistribute the marginal functions so that all of the marginal functions that the qualified individual with a disability can perform are made a part of the position to be filled by the qualified individual with a disability. The remaining marginal functions that the individual with a disability cannot perform would then be transferred to the other position. See Senate Report at 31; House Labor Report at 62.

An employer or other covered entity is not required to reallocate essential functions. The essential functions are by definition those that the individual who holds the job would have to perform, with or without reasonable accommodation, in order to be considered qualified for the position. For example, suppose a security guard position requires the individual who holds the job to inspect identification cards. An employer would not have to provide an individual who is legally blind with an assistant to look at the identification cards for the legally blind employee. In this situation the assistant would be performing the job for the individual with a disability rather than assisting the individual to perform the job. See *Coleman v. Darden*, 595 F.2d 533 (10th Cir. 1979).

An employer or other covered entity may also restructure a job by altering when and/or how an essential function is performed. For example, an essential function customarily performed in the early morning hours may be rescheduled until later in the day as a reasonable accommodation to a disability that precludes performance of the function at the customary hour. Likewise, as a reasonable accommodation, an employee with a disability that inhibits the ability to write, may be permitted to computerize records that were customarily maintained manually.

Reassignment to a vacant position is also listed as a potential reasonable accommodation. In general, reassignment should be considered only when accommodation within the individual's current position would pose an undue hardship. Reassignment is not available to

applicants. An applicant for a position must be qualified for, and be able to perform the essential functions of, the position sought with or without reasonable accommodation.

Reassignment may not be used to limit, segregate, or otherwise discriminate against employees with disabilities by forcing reassignments to undesirable positions or to designated offices or facilities. Employers should reassign the individual to an equivalent position, in terms of pay, status, etc., if the individual is qualified, and if the position is vacant within a reasonable amount of time. A "reasonable amount of time" should be determined in light of the totality of the circumstances. As an example, suppose there is no vacant position available at the time that an individual with a disability requests reassignment as a reasonable accommodation. The employer, however, knows that an equivalent position for which the individual is qualified, will become vacant next week. Under these circumstances, the employer should reassign the individual to the position when it becomes available.

An employer may reassign an individual to a lower graded position if there are no accommodations that would enable the employee to remain in the current position and there are no vacant equivalent positions for which the individual is qualified with or without reasonable accommodation. An employer, however, is not required to maintain the reassigned individual with a disability at the salary of the higher graded position if it does not so maintain reassigned employees who are not disabled. It should also be noted that an employer is not required to promote an individual with a disability as an accommodation. See Senate Report at 31-32; House Labor Report at 63.

The determination of which accommodation is appropriate in a particular situation involves a process in which the employer and employee identify the precise limitations imposed by the disability and explore potential accommodations that would overcome those limitations. This process is discussed more fully in § 1630.9 Not Making Reasonable Accommodation.

Section 1630.2(p) Undue Hardship

An employer or other covered entity is not required to provide an accommodation that will impose an undue hardship on the operation of the employer's or other covered entity's business. The term "undue hardship" means significant difficulty or expense in, or resulting from, the provision of the accommodation. The "undue hardship" provision takes into account the financial realities of the particular employer or other covered entity. However, the concept of undue hardship is not limited to financial difficulty. "Undue hardship" refers to any accommodation that would be unduly costly, extensive, substantial, or disruptive, or that would fundamentally alter the nature or operation of the business. See Senate Report at 35; House Labor Report at 67.

For example, suppose an individual with a disabling visual impairment that makes it extremely difficult to see in dim lighting applies for a position as a waiter in a

nightclub and requests that the club be brightly lit as a reasonable accommodation. Although the individual may be able to perform the job in bright lighting, the nightclub will probably be able to demonstrate that that particular accommodation, though inexpensive, would impose an undue hardship if the bright lighting would destroy the ambience of the nightclub and/or make it difficult for the customers to see the stage show. The fact that that particular accommodation poses an undue hardship, however, only means that the employer is not required to provide that accommodation. If there is another accommodation that will not create an undue hardship, the employer would be required to provide the alternative accommodation.

An employer's claim that the cost of a particular accommodation will impose an undue hardship will be analyzed in light of the factors outlined in part 1630. In part, this analysis requires a determination of whose financial resources should be considered in deciding whether the accommodation is unduly costly. In some cases the financial resources of the employer or other covered entity in its entirety should be considered in determining whether the cost of an accommodation poses an undue hardship. In other cases, consideration of the financial resources of the employer or other covered entity as a whole may be inappropriate because it may not give an accurate picture of the financial resources available to the particular facility that will actually be required to provide the accommodation. See House Labor Report at 68-69; House Judiciary Report at 40-41; see also Conference Report at 56-57.

If the employer or other covered entity asserts that only the financial resources of the facility where the individual will be employed should be considered, part 1630 requires a factual determination of the relationship between the employer or other covered entity and the facility that will provide the accommodation. As an example, suppose that an independently owned fast food franchise that receives no money from the franchisor refuses to hire an individual with a hearing impairment because it asserts that it would be an undue hardship to provide an interpreter to enable the individual to participate in monthly staff meetings. Since the financial relationship between the franchisor and the franchise is limited to payment of an annual franchise fee, only the financial resources of the franchise would be considered in determining whether or not providing the accommodation would be an undue hardship. See House Labor Report at 68; House Judiciary Report at 40.

If the employer or other covered entity can show that the cost of the accommodation would impose an undue hardship, it would still be required to provide the accommodation if the funding is available from another source, e.g., a State vocational rehabilitation agency, or if Federal, State or local tax deductions or tax credits are available to offset the cost of the accommodation. If the employer or other covered entity receives, or is eligible to receive, monies from an external source that would pay the entire cost of the

accommodation, it cannot claim cost as an undue hardship. In the absence of such funding, the individual with a disability requesting the accommodation should be given the option of providing the accommodation or of paying that portion of the cost which constitutes the undue hardship on the operation of the business. To the extent that such monies pay or would pay for only part of the cost of the accommodation, only that portion of the cost of the accommodation that could not be recovered—the final net cost to the entity—may be considered in determining undue hardship. (See § 1630.9 Not Making Reasonable Accommodation). See Senate Report at 38; House Labor Report at 69.

Section 1630.2(r) Direct Threat

An employer may require, as a qualification standard, that an individual not pose a direct threat to the health or safety of himself/herself or others. Like any other qualification standard, such a standard must apply to all applicants or employees and not just to individuals with disabilities. If, however, an individual poses a direct threat as a result of a disability, the employer must determine whether a reasonable accommodation would either eliminate the risk or reduce it to an acceptable level. If no accommodation exists that would either eliminate or reduce the risk, the employer may refuse to hire an applicant or may discharge an employee who poses a direct threat.

An employer, however, is not permitted to deny an employment opportunity to an individual with a disability merely because of a slightly increased risk. The risk can only be considered when it poses a significant risk, i.e., high probability, of substantial harm; a speculative or remote risk is insufficient. See Senate Report at 27; House Report Labor Report at 56-57; House Judiciary Report at 45.

Determining whether an individual poses a significant risk of substantial harm to others must be made on a case by case basis. The employer should identify the specific risk posed by the individual. For individuals with mental or emotional disabilities, the employer must identify the specific behavior on the part of the individual that would pose the direct threat. For individuals with physical disabilities, the employer must identify the aspect of the disability that would pose the direct threat. The employer should then consider the four factors listed in part 1630:

- (1) The duration of the risk;
- (2) The nature and severity of the potential harm;
- (3) The likelihood that the potential harm will occur; and

(4) The imminence of the potential harm. Such consideration must rely on objective, factual evidence—not on subjective perceptions, irrational fears, patronizing attitudes, or stereotypes—about the nature or effect of a particular disability, or of disability generally. See Senate Report at 27; House Labor Report at 56-57; House Judiciary Report at 45-46. See also *Strathie v. Department of Transportation*, 716 F.2d 227 (3d Cir. 1983). Relevant evidence may include input from the individual with a disability,

the experience of the individual with a disability in previous similar positions, and opinions of medical doctors, rehabilitation counselors, or physical therapists who have expertise in the disability involved and/or direct knowledge of the individual with the disability.

An employer is also permitted to require that an individual not pose a direct threat of harm to his or her own safety or health. If performing the particular functions of a job would result in a high probability of substantial harm to the individual, the employer could reject or discharge the individual unless a reasonable accommodation that would not cause an undue hardship would avert the harm. For example, an employer would not be required to hire an individual, disabled by narcolepsy, who frequently and unexpectedly loses consciousness for a carpentry job the essential functions of which require the use of power saws and other dangerous equipment, where no accommodation exists that will reduce or eliminate the risk.

The assessment that there exists a high probability of substantial harm to the individual, like the assessment that there exists a high probability of substantial harm to others, must be strictly based on valid medical analyses and/or on other objective evidence. This determination must be based on individualized factual data, using the factors discussed above, rather than on stereotypic or patronizing assumptions and must consider potential reasonable accommodations. Generalized fears about risks from the employment environment, such as exacerbation of the disability caused by stress, cannot be used by an employer to disqualify an individual with a disability. For example, a law firm could not reject an applicant with a history of disabling mental illness based on a generalized fear that the stress of trying to make partner might trigger a relapse of the individual's mental illness. Nor can generalized fears about risks to individuals with disabilities in the event of an evacuation or other emergency be used by an employer to disqualify an individual with a disability. See Senate Report at 58; House Labor Report at 73-74; House Judiciary Report at 45. See also *Mantalet v. Balger*, 767 F.2d 1418 (9th Cir. 1985); *Bentivegna v. U.S. Department of Labor*, 694 F.2d 619 (9th Cir. 1982).

Section 1630.3 Exceptions to the Definitions of "Disability" and "Qualified Individual with a Disability"

Section 1630.3 (a) through (c) Illegal Use of Drugs

Part 1630 provides that an individual currently engaging in the illegal use of drugs is not an individual with a disability for purposes of this part when the employer or other covered entity acts on the basis of such use. Illegal use of drugs refers both to the use of unlawful drugs, such as cocaine, and to the unlawful use of prescription drugs.

Employers, for example, may discharge or deny employment to persons who illegally use drugs, on the basis of such use, without fear of being held liable for discrimination. The term "currently engaging" is not intended

to be limited to the use of drugs on the day of, or within a matter of days or weeks before, the employment action in question. Rather, the provision is intended to apply to the illegal use of drugs that has occurred recently enough to indicate that the individual is actively engaged in such conduct. See Conference Report at 64.

Individuals who are erroneously perceived as engaging in the illegal use of drugs, but are not in fact illegally using drugs are not excluded from the definitions of the terms "disability" and "qualified individual with a disability." Individuals who are no longer illegally using drugs and who have either been rehabilitated successfully or are in the process of completing a rehabilitation program are, likewise, not excluded from the definitions of those terms. The term "rehabilitation program" refers to both in-patient and out-patient programs, as well as to appropriate employee assistance programs, professionally recognized self-help programs, such as Narcotics Anonymous, or other programs that provide professional (not necessarily medical) assistance and counseling for individuals who illegally use drugs. See Conference Report at 64; see also House Labor Report at 77; House Judiciary Report at 47.

It should be noted that this provision simply provides that certain individuals are not excluded from the definitions of "disability" and "qualified individual with a disability." Consequently, such individuals are still required to establish that they satisfy the requirements of these definitions in order to be protected by the ADA and this part. An individual erroneously regarded as illegally using drugs, for example, would have to show that he or she was regarded as a drug addict in order to demonstrate that he or she meets the definition of "disability" as defined in this part.

Employers are entitled to seek reasonable assurances that no illegal use of drugs is occurring or has occurred recently enough so that continuing use is a real and ongoing problem. The reasonable assurances that employers may ask applicants or employees to provide include evidence that the individual is participating in a drug treatment program and/or evidence, such as drug test results, to show that the individual is not currently engaging in the illegal use of drugs. An employer, such as a law enforcement agency, may also be able to impose a qualification standard that excludes individuals with a history of illegal use of drugs if it can show that the standard is job-related and consistent with business necessity. (See § 1630.10 Qualification Standards, Tests and Other Selection Criteria) See Conference Report at 64.

Section 1630.4 Discrimination Prohibited

This provision prohibits discrimination against a qualified individual with a disability in all aspects of the employment relationship. The range of employment decisions covered by this nondiscrimination mandate is to be construed in a manner consistent with the regulations implementing section 504 of the Rehabilitation Act of 1973.

Part 1630 is not intended to limit the ability of covered entities to choose and maintain a

qualified workforce. Employers can continue to use job-related criteria to select qualified employees, and can continue to hire employees who can perform the essential functions of the job.

Section 1630.5 Limiting, Segregating and Classifying

This provision and the several provisions that follow describe various specific forms of discrimination that are included within the general prohibition of § 1630.4. Covered entities are prohibited from restricting the employment opportunities of qualified individuals with disabilities on the basis of stereotypes and myths about the individual's disability. Rather, the capabilities of qualified individuals with disabilities must be determined on an individualized, case by case basis. Covered entities are also prohibited from segregating qualified employees with disabilities into separate work areas or into separate lines of advancement.

Thus, for example, it would be a violation of this part for an employer to limit the duties of an employee with a disability based on a presumption of what is best for an individual with such a disability, or on a presumption about the abilities of an individual with such a disability. It would be a violation of this part for an employer to adopt a separate track of job promotion or progression for employees with disabilities based on a presumption that employees with disabilities are uninterested in, or incapable of, performing particular jobs. Similarly, it would be a violation for an employer to assign or reassign (as a reasonable accommodation) employees with disabilities to one particular office or installation, or to require that employees with disabilities only use particular employer provided non-work facilities such as segregated break-rooms, lunch rooms, or lounges. It would also be a violation of this part to deny employment to an applicant or employee with a disability based on generalized fears about the safety of an individual with such a disability, or based on generalized assumptions about the absenteeism rate of an individual with such a disability.

In addition, it should also be noted that this part is intended to require that employees with disabilities be accorded equal access to whatever health insurance coverage the employer provides to other employees. This part does not, however, affect pre-existing condition clauses included in health insurance policies offered by employers. Consequently, employers may continue to offer policies that contain such clauses, even if they adversely affect individuals with disabilities, so long as the clauses are not used as a subterfuge to evade the purposes of this part.

So, for example, it would be permissible for an employer to offer an insurance policy that limits coverage for certain procedures or treatments to a specified number per year. Thus, if a health insurance plan provided coverage for five blood transfusions a year to all covered employees, it would not be discriminatory to offer this plan simply because a hemophiliac employee may require more than five blood transfusions annually.

However, it would not be permissible to limit or deny the hemophiliac employee coverage for other procedures, such as heart surgery or the setting of a broken leg, even though the plan would not have to provide coverage for the additional blood transfusions that may be involved in these procedures. Likewise, limits may be placed on reimbursements for certain procedures or on the types of drugs or procedures covered (e.g. limits on the number of permitted X-rays or non-coverage of experimental drugs or procedures), but that limitation must be applied equally to individuals with and without disabilities. See Senate Report at 28-29; House Labor Report at 58-59; House Judiciary Report at 36.

Leave policies or benefit plans that are uniformly applied do not violate this part simply because they do not address the special needs of every individual with a disability. Thus, for example, an employer that reduces the number of paid sick leave days that it will provide to all employees, or reduces the amount of medical insurance coverage that it will provide to all employees, is not in violation of this part, even if the benefits reduction has an impact on employees with disabilities in need of greater sick leave and medical coverage. Benefits reductions adopted for discriminatory reasons are in violation of this part. See *Alexander v. Choate*, 469 U.S. 287 (1985). See Senate Report at 85; House Labor Report at 137. (See also, the discussion at § 1630.16(f) Health Insurance, Life Insurance, and Other Benefit Plans).

Section 1630.6 Contractual or Other Arrangements

An employer or other covered entity may not do through a contractual or other relationship what it is prohibited from doing directly. This provision does not affect the determination of whether or not one is a "covered entity" or "employer" as defined in § 1630.2.

This provision only applies to situations where an employer or other covered entity has entered into a contractual relationship that has the effect of discriminating against its own employees or applicants with disabilities. Accordingly, it would be a violation for an employer to participate in a contractual relationship that results in discrimination against the employer's employees with disabilities in hiring, training, promotion, or in any other aspect of the employment relationship. This provision applies whether or not the employer or other covered entity intended for the contractual relationship to have the discriminatory effect.

Part 1630 notes that this provision applies to parties on either side of the contractual or other relationship. This is intended to highlight that an employer whose employees provide services to others, like an employer whose employees receive services, must ensure that those employees are not discriminated against on the basis of disability. For example, a copier company whose service representative is a dwarf could be required to provide a stepstool, as a reasonable accommodation, to enable him to perform the necessary repairs. However, the employer would not be required, as a

reasonable accommodation, to make structural changes to its customer's inaccessible premises.

The existence of the contractual relationship adds no new obligations under part 1630. The employer, therefore, is not liable through the contractual arrangement for any discrimination by the contractor against the contractor's own employees or applicants, although the contractor, as an employer, may be liable for such discrimination.

An employer or other covered entity, on the other hand, cannot evade the obligations imposed by this part by engaging in a contractual or other relationship. For example, an employer cannot avoid its responsibility to make reasonable accommodation subject to the undue hardship limitation through a contractual arrangement. See Conference Report at 59; House Labor Report at 59-61; House Judiciary Report at 36-37.

To illustrate, assume that an employer is seeking to contract with a company to provide training for its employees. Any responsibilities of reasonable accommodation applicable to the employer in providing the training remain with that employer even if it contracts with another company for this service. Thus, if the training company were planning to conduct the training at an inaccessible location, thereby making it impossible for an employee who uses a wheelchair to attend, the employer would have a duty to make reasonable accommodation unless to do so would impose an undue hardship. Under these circumstances, appropriate accommodations might include (1) having the training company identify accessible training sites and relocate the training program; (2) having the training company make the training site accessible; (3) directly making the training site accessible or providing the training company with the means by which to make the site accessible; (4) identifying and contracting with another training company that uses accessible sites; or (5) any other accommodation that would result in making the training available to the employee.

As another illustration, assume that instead of contracting with a training company, the employer contracts with a hotel to host a conference for its employees. The employer will have a duty to ascertain and ensure the accessibility of the hotel and its conference facilities. To fulfill this obligation the employer could, for example, inspect the hotel first-hand or ask a local disability group to inspect the hotel. Alternatively, the employer could ensure that the contract with the hotel specifies it will provide accessible guest rooms for those who need them and that all rooms to be used for the conference, including exhibit and meeting rooms, are accessible. If the hotel breaches this accessibility provision, the hotel may be liable to the employer, under a non-ADA breach of contract theory, for the cost of any accommodation needed to provide access to the hotel and conference, and for any other costs accrued by the employer. (In addition, the hotel may also be independently liable under title III of the ADA.) However, this would not relieve the employer of its

responsibility under this part nor shield it from charges of discrimination by its own employees. See House Labor Report at 40; House Judiciary Report at 37.

Section 1630.8 Relationship or Association With an Individual With a Disability

This provision is intended to protect any qualified individual, whether or not that individual has a disability, from discrimination because that person is known to have an association or relationship with an individual who has a known disability. This protection is not limited to those who have a familial relationship with an individual with a disability.

To illustrate the scope of this provision, assume that a qualified applicant without a disability applies for a job and discloses to the employer that his or her spouse has a disability. The employer thereupon declines to hire the applicant because the employer believes that the applicant would have to miss work or frequently leave work early in order to care for the spouse. Such a refusal to hire would be prohibited by this provision. Similarly, this provision would prohibit an employer from discharging an employee because the employee does volunteer work with people who have AIDS, and the employer fears that the employee may contract the disease.

This provision also applies to other benefits and privileges of employment. For example, an employer that provides health insurance benefits to its employees for their dependents may not reduce the level of those benefits to an employee simply because that employee has a dependent with a disability. This is true even if the provision of such benefits would result in increased health insurance costs for the employer.

It should be noted, however, that an employer need not provide the applicant or employee without a disability with a reasonable accommodation because that duty only applies to qualified applicants or employees with disabilities. Thus, for example, an employee would not be entitled to a modified work schedule as an accommodation to enable the employee to care for a spouse with a disability. See Senate Report at 30; House Labor Report at 61-62; House Judiciary Report at 38-39.

Section 1630.9 Not Making Reasonable Accommodation

The obligation to make reasonable accommodation is a form of non-discrimination. It applies to all employment decisions and to the job application process. This obligation does not extend to the provision of adjustments or modifications that are primarily for the personal benefit of the individual with a disability. Thus, if an adjustment or modification is job-related, e.g., specifically assists the individual in performing the duties of a particular job, it will be considered a type of reasonable accommodation. On the other hand, if an adjustment or modification assists the individual throughout his or her daily activities, on and off the job, it will be considered a personal item that the employer is not required to provide. Accordingly, an employer would generally not be required to

provide an employee with a disability with a prosthetic limb, wheelchair, or eyeglasses. Nor would an employer have to provide as an accommodation any amenity or convenience that is not job-related, such as a private hot plate, hot pot or refrigerator that is not provided to employees without disabilities. See Senate Report at 31; House Labor Report at 62.

It should be noted, however, that the provision of such items may be required as a reasonable accommodation where such items are specifically designed or required to meet job-related rather than personal needs. An employer, for example, may have to provide an individual with a disabling visual impairment with eyeglasses specifically designed to enable the individual to use the office computer monitors, but that are not otherwise needed by the individual outside of the office.

The term "supported employment," which has been applied to a wide variety of programs to assist individuals with severe disabilities in both competitive and non-competitive employment, is not synonymous with reasonable accommodation. Examples of supported employment include modified training materials, restructuring essential functions to enable an individual to perform a job, or hiring an outside professional ("job coach") to assist in job training. Whether a particular form of assistance would be required as a reasonable accommodation must be determined on an individualized, case by case basis without regard to whether that assistance is referred to as "supported employment." For example, an employer, under certain circumstances, may be required to provide modified training materials or a temporary "job coach" to assist in the training of a qualified individual with a disability as a reasonable accommodation. However, an employer would not be required to restructure the essential functions of a position to fit the skills of an individual with a disability who is not otherwise qualified to perform the position, as is done in certain supported employment programs. See 34 CFR part 363. It should be noted that it would not be a violation of this part for an employer to provide any of these personal modifications or adjustments, or to engage in supported employment or similar rehabilitative programs.

The obligation to make reasonable accommodation applies to all services and programs provided in connection with employment, and to all non-work facilities provided or maintained by an employer for use by its employees. Accordingly, the obligation to accommodate is applicable to employer sponsored placement or counseling services, and to employer provided cafeterias, lounges, gymnasiums, auditoriums, transportation and the like.

The reasonable accommodation requirement is best understood as a means by which barriers to the equal employment opportunity of an individual with a disability are removed or alleviated. These barriers may, for example, be physical or structural obstacles that inhibit or prevent the access of an individual with a disability to job sites, facilities or equipment. Or they may be rigid

work schedules that permit no flexibility as to when work is performed or when breaks may be taken, or inflexible job procedures that unduly limit the modes of communication that are used on the job, or the way in which particular tasks are accomplished.

The term "otherwise qualified" is intended to make clear that the obligation to make reasonable accommodation is owed only to an individual with a disability who is qualified within the meaning of § 1630.2(m) in that he or she satisfies all the skill, experience, education and other job-related selection criteria. An individual with a disability is "otherwise qualified," in other words, if he or she is qualified for a job, except that, because of the disability, he or she needs a reasonable accommodation to be able to perform the job's essential functions.

For example, if a law firm requires that all incoming lawyers have graduated from an accredited law school and have passed the bar examination, the law firm need not provide an accommodation to an individual with a visual impairment who has not met these selection criteria. That individual is not entitled to a reasonable accommodation because the individual is not "otherwise qualified" for the position.

On the other hand, if the individual has graduated from an accredited law school and passed the bar examination, the individual would be "otherwise qualified." The law firm would thus be required to provide a reasonable accommodation, such as a machine that magnifies print, to enable the individual to perform the essential functions of the attorney position, unless the necessary accommodation would impose an undue hardship on the law firm. See Senate Report at 33-34; House Labor Report at 64-65.

The reasonable accommodation that is required by this part should provide the qualified individual with a disability with an equal employment opportunity. Equal employment opportunity means an opportunity to attain the same level of performance, or to enjoy the same level of benefits and privileges of employment as are available to the average similarly situated employee without a disability. Thus, for example, an accommodation made to assist an employee with a disability in the performance of his or her job must be adequate to enable the individual to perform the essential functions of the relevant position. The accommodation, however, does not have to be the "best" accommodation possible, so long as it is sufficient to meet the job-related needs of the individual being accommodated. Accordingly, an employer would not have to provide an employee disabled by a back impairment with a state-of-the-art mechanical lifting device if it provided the employee with a less expensive or more readily available device that enabled the employee to perform the essential functions of the job. See Senate Report at 35; House Labor Report at 66; see also *Carter v. Bennett*, 840 F.2d 63 (DC Cir. 1988).

Employers are obligated to make reasonable accommodation only to the physical or mental limitations resulting from the disability of a qualified individual with a disability that is known to the employer.

Thus, an employer would not be expected to accommodate disabilities of which it is unaware. If an employee with a known disability is having difficulty performing his or her job, an employer may inquire whether the employee is in need of a reasonable accommodation. In general, however, it is the responsibility of the individual with a disability to inform the employer that an accommodation is needed. When the need for an accommodation is not obvious, an employer, before providing a reasonable accommodation, may require that the individual with a disability provide documentation of the need for accommodation.

See Senate Report at 34; House Labor Report at 65.

Process of Determining the Appropriate Reasonable Accommodation

Once a qualified individual with a disability has requested provision of a reasonable accommodation, the employer must make a reasonable effort to determine the appropriate accommodation. The appropriate reasonable accommodation is best determined through a flexible, interactive process that involves both the employer and the qualified individual with a disability. Although this process is described below in terms of accommodations that enable the individual with a disability to perform the essential functions of the position held or desired, it is equally applicable to accommodations involving the job application process, and to accommodations that enable the individual with a disability to enjoy equal benefits and privileges of employment. See Senate Report at 34-35; House Labor Report at 65-67.

When a qualified individual with a disability has requested a reasonable accommodation to assist in the performance of a job, the employer, using a problem solving approach, should:

- (1) Analyze the particular job involved and determine its purpose and essential functions;
- (2) Consult with the individual with a disability to ascertain the precise job-related limitations imposed by the individual's disability and how those limitations could be overcome with a reasonable accommodation;
- (3) In consultation with the individual to be accommodated, identify potential accommodations and assess the effectiveness each would have in enabling the individual to perform the essential functions of the position; and
- (4) Consider the preference of the individual to be accommodated and select and implement the accommodation that is most appropriate for both the employee and the employer.

In many instances, the appropriate reasonable accommodation may be so obvious to either or both the employer and the qualified individual with a disability that it may not be necessary to proceed in this step-by-step fashion. For example, if an employee who uses a wheelchair requests that his or her desk be placed on blocks to elevate the desktop above the arms of the wheelchair and the employer complies, an appropriate accommodation has been requested, identified, and provided without either the employee or employer being aware

of having engaged in any sort of "reasonable accommodation process."

However, in some instances neither the individual requesting the accommodation nor the employer can readily identify the appropriate accommodation. For example, the individual needing the accommodation may not know enough about the equipment used by the employer or the exact nature of the work site to suggest an appropriate accommodation. Likewise, the employer may not know enough about the individual's disability or the limitations that disability would impose on the performance of the job to suggest an appropriate accommodation. Under such circumstances, it may be necessary for the employer to initiate a more defined problem solving process, such as the step-by-step process described above, as part of its reasonable effort to identify the appropriate reasonable accommodation.

This process requires the individual assessment of both the particular job at issue, and the specific physical or mental limitations of the particular individual in need of reasonable accommodation. With regard to assessment of the job, "individual assessment" means analyzing the actual job duties and determining the true purpose or object of the job. Such an assessment is necessary to ascertain which job functions are the essential functions that an accommodation must enable an individual with a disability to perform.

After assessing the relevant job, the employer, in consultation with the individual requesting the accommodation, should make an assessment of the specific limitations imposed by the disability on the individual's performance of the job's essential functions. This assessment will make it possible to ascertain the precise barrier to the employment opportunity which, in turn, will make it possible to determine the accommodation(s) that could alleviate or remove that barrier.

If consultation with the individual in need of the accommodation still does not reveal potential appropriate accommodations, then the employer, as part of this process, may find that technical assistance is helpful in determining how to accommodate the particular individual in the specific situation. Such assistance could be sought from the Commission, from state or local rehabilitation agencies, or from disability constituent organizations. It should be noted, however, that, as provided in § 1630.9(c) of this part, the failure to obtain or receive technical assistance from the federal agencies that administer the ADA will not excuse the employer from its reasonable accommodation obligation.

Once potential accommodations have been identified, the employer should assess the effectiveness of each potential accommodation in assisting the individual in need of the accommodation in the performance of the essential functions of the position. If more than one of these accommodations will enable the individual to perform the essential functions or if the individual would prefer to provide his or her own accommodation, the preference of the individual with a disability should be given

primary consideration. However, the employer providing the accommodation has the ultimate discretion to choose between effective accommodations, and may choose the less expensive accommodation or the accommodation that is easier for it to provide. It should also be noted that the individual's willingness to provide his or her own accommodation does not relieve the employer of the duty to provide the accommodation should the individual for any reason be unable or unwilling to continue to provide the accommodation.

Reasonable Accommodation Process Illustrated

The following example illustrates the informal reasonable accommodation process. Suppose a Sack Handler position requires that the employee pick up fifty pound sacks and carry them from the company loading dock to the storage room, and that a sack handler who is disabled by a back impairment requests a reasonable accommodation. Upon receiving the request, the employer analyzes the Sack Handler job and determines that the essential function and purpose of the job is not the requirement that the job holder physically lift and carry the sacks, but the requirement that the job holder cause the sack to move from the loading dock to the storage room.

The employer then meets with the sack handler to ascertain precisely the barrier posed by the individual's specific disability to the performance of the job's essential function of relocating the sacks. At this meeting the employer learns that the individual can, in fact, lift the sacks to waist level, but is prevented by his or her disability from carrying the sacks from the loading dock to the storage room. The employer and the individual agree that any of a number of potential accommodations, such as the provision of a dolly, hand truck, or cart, could enable the individual to transport the sacks that he or she has lifted.

Upon further consideration, however, it is determined that the provision of a cart is not a feasible effective option. No carts are currently available at the company, and those that can be purchased by the company are the wrong shape to hold many of the bulky and irregularly shaped sacks that must be moved. Both the dolly and the hand truck, on the other hand, appear to be effective options. Both are readily available to the company, and either will enable the individual to relocate the sacks that he or she has lifted. The sack handler indicates his or her preference for the dolly. In consideration of this expressed preference, and because the employer feels that the dolly will allow the individual to move more sacks at a time and so be more efficient than would a hand truck, the employer ultimately provides the sack handler with a dolly in fulfillment of the obligation to make reasonable accommodation.

Section 1630.9(b)

This provision states that an employer or other covered entity cannot prefer or select a qualified individual without a disability over an equally qualified individual with a disability merely because the individual with a disability will require a reasonable

accommodation. In other words, an individual's need for an accommodation cannot enter into the employer's or other covered entity's decision regarding hiring, discharge, promotion, or other similar employment decisions, unless the accommodation would impose an undue hardship on the employer. See House Labor Report at 70.

Section 1630.9(d)

The purpose of this provision is to clarify that an employer or other covered entity may not compel a qualified individual with a disability to accept an accommodation, where that accommodation is neither requested nor needed by the individual. However, if a necessary reasonable accommodation is refused, the individual may not be considered qualified. For example, an individual with a visual impairment that restricts his or her field of vision but who is able to read unaided would not be required to accept a reader as an accommodation. However, if the individual were not able to read unaided and reading was an essential function of the job, the individual would not be qualified for the job if he or she refused a reasonable accommodation that would enable him or her to read. See Senate Report at 34; House Labor Report at 65; House Judiciary Report at 71-72.

Section 1630.10 Qualification Standards, Tests, and Other Selection Criteria

The purpose of this provision is to ensure that individuals with disabilities are not excluded from job opportunities unless they are actually unable to do the job. It is to ensure that there is a fit between job criteria and an applicant's (or employee's) actual ability to do the job. Accordingly, job criteria that even unintentionally screen out, or tend to screen out, an individual with a disability or a class of individuals with disabilities because of their disability may not be used unless the employer demonstrates that that criteria, as used by the employer, are job-related to the position to which they are being applied and are consistent with business necessity. The concept of "business necessity" has the same meaning as the concept of "business necessity" under section 504 of the Rehabilitation Act of 1973.

Selection criteria that exclude, or tend to exclude, an individual with a disability or a class of individuals with disabilities because of their disability but do not concern an essential function of the job would not be consistent with business necessity.

The use of selection criteria that are related to an essential function of the job may be consistent with business necessity. However, selection criteria that are related to an essential function of the job may not be used to exclude an individual with a disability if that individual could satisfy the criteria with the provision of a reasonable accommodation. Experience under a similar provision of the regulations implementing section 504 of the Rehabilitation Act indicates that challenges to selection criteria are, in fact, most often resolved by reasonable accommodation. It is therefore anticipated that challenges to selection criteria brought under this part will generally be resolved in a like manner.

This provision is applicable to all types of selection criteria, including safety requirements, vision or hearing requirements, walking requirements, lifting requirements, and employment tests. See Senate Report at 37-39; House Labor Report at 70-72; House Judiciary Report at 42. As previously noted, however, it is not the intent of this part to second guess an employer's business judgment with regard to production standards. (See section 1630.2(n) Essential Functions). Consequently, production standards will generally not be subject to a challenge under this provision.

The Uniform Guidelines on Employee Selection Procedures (UGESP) 29 CFR part 1607 do not apply to the Rehabilitation Act and are similarly inapplicable to this part.

Section 1630.11 Administration of Tests

The intent of this provision is to further emphasize that individuals with disabilities are not to be excluded from jobs that they can actually perform merely because a disability prevents them from taking a test, or negatively influences the results of a test, that is a prerequisite to the job. Read together with the reasonable accommodation requirement of section 1630.9, this provision requires that employment tests be administered to eligible applicants or employees with disabilities that impair sensory, manual, or speaking skills in formats that do not require the use of the impaired skill.

The employer or other covered entity is, generally, only required to provide such reasonable accommodation if it knows, prior to the administration of the test, that the individual is disabled and that the disability impairs sensory, manual or speaking skills. Thus, for example, it would be unlawful to administer a written employment test to an individual who has informed the employer, prior to the administration of the test, that he is disabled with dyslexia and unable to read. In such a case, as a reasonable accommodation and in accordance with this provision, an alternative oral test should be administered to that individual. By the same token, a written test may need to be substituted for an oral test if the applicant taking the test is an individual with a disability that impairs speaking skills or impairs the processing of auditory information.

Occasionally, an individual with a disability may not realize, prior to the administration of a test, that he or she will need an accommodation to take that particular test. In such a situation, the individual with a disability, upon becoming aware of the need for an accommodation, must so inform the employer or other covered entity. For example, suppose an individual with a disabling visual impairment does not request an accommodation for a written examination because he or she is usually able to take written tests with the aid of his or her own specially designed lens. When the test is distributed, the individual with a disability discovers that the lens is insufficient to distinguish the words of the test because of the unusually low color contrast between the paper and the ink, the

individual would be entitled, at that point, to request an accommodation. The employer or other covered entity would, thereupon, have to provide a test with higher contrast, schedule a retest, or provide any other effective accommodation unless to do so would impose an undue hardship.

Other alternative or accessible test modes or formats include the administration of tests in large print or braille, or via a reader or sign interpreter. Where it is not possible to test in an alternative format, the employer may be required, as a reasonable accommodation, to evaluate the skill to be tested in another manner (e.g., through an interview, or through education license, or work experience requirements). An employer may also be required, as a reasonable accommodation, to allow more time to complete the test. In addition, the employer's obligation to make reasonable accommodation extends to ensuring that the test site is accessible. (See § 1630.9 Not Making Reasonable Accommodation) See Senate Report at 37-38; House Labor Report at 70-72; House Judiciary Report at 42; see also *Stutts v. Freeman*, 694 F.2d 666 (11th Cir. 1983); *Crane v. Dole*, 617 F. Supp. 156 (D.D.C. 1985).

This provision does not require that an employer offer every applicant his or her choice of test format. Rather, this provision only requires that an employer provide, upon advance request, alternative, accessible tests to individuals with disabilities that impair sensory, manual, or speaking skills needed to take the test.

This provision does not apply to employment tests that require the use of sensory, manual, or speaking skills where the tests are intended to measure those skills. Thus, an employer could require that an applicant with dyslexia take a written test for a particular position if the ability to read is the skill the test is designed to measure. Similarly, an employer could require that an applicant complete a test within established time frames if speed were one of the skills for which the applicant was being tested. However, the results of such a test could not be used to exclude an individual with a disability unless the skill was necessary to perform an essential function of the position and no reasonable accommodation was available to enable the individual to perform that function, or the necessary accommodation would impose an undue hardship.

Section 1630.13 Prohibited Medical Examinations and Inquiries

Section 1630.13(a) Pre-employment Examination or Inquiry

This provision makes clear that an employer cannot inquire as to whether an individual has a disability at the pre-offer stage of the selection process. Nor can an employer inquire at the pre-offer stage about an applicant's workers' compensation history.

Employers may ask questions that relate to the applicant's ability to perform job-related functions. However, these questions should not be phrased in terms of disability. An employer, for example, may ask whether the applicant has a driver's license, if driving is a job function, but may not ask whether the

applicant has a visual disability. Employers may ask about an applicant's ability to perform both essential and marginal job functions. Employers, though, may not refuse to hire an applicant with a disability because the applicant's disability prevents him or her from performing marginal functions. See Senate Report at 39; House Labor Report at 72-73; House Judiciary Report at 42-43.

Section 1630.13(b) Examination or Inquiry of Employees

The purpose of this provision is to prevent the administration to employees of medical tests or inquiries that do not serve a legitimate business purpose. For example, if an employee suddenly starts to use increased amounts of sick leave or starts to appear sickly, an employer could not require that employee to be tested for AIDS, HIV infection, or cancer unless the employer can demonstrate that such testing is job-related and consistent with business necessity. See Senate Report at 39; House Labor Report at 75; House Judiciary Report at 44.

Section 1630.14 Medical Examinations and Inquiries Specifically Permitted

Section 1630.14(a) Pre-employment Inquiry

Employers are permitted to make pre-employment inquiries into the ability of an applicant to perform job-related functions. This inquiry must be narrowly tailored. The employer may describe or demonstrate the job function and inquire whether or not the applicant can perform that function with or without reasonable accommodation. For example, an employer may explain that the job requires assembling small parts and ask if the individual will be able to perform that function, with or without reasonable accommodation. See Senate Report at 39; House Labor Report at 73; House Judiciary Report at 43.

An employer may also ask an applicant to describe or to demonstrate how, with or without reasonable accommodation, the applicant will be able to perform job-related functions. Such a request may be made of all applicants in the same job category regardless of disability. Such a request may also be made of an applicant whose known disability may interfere with or prevent the performance of a job-related function, whether or not the employer routinely makes such a request of all applicants in the job category. For example, an employer may ask an individual with one leg who applies for a position as a home washing machine repairman to demonstrate or to explain how, with or without reasonable accommodation, he would be able to transport himself and his tools down basement stairs. However, the employer may not inquire as to the nature or severity of the disability. Therefore, for example, the employer cannot ask how the individual lost the leg or whether the loss of the leg is indicative of an underlying impairment.

On the other hand, if the known disability of an applicant will not interfere with or prevent the performance of a job-related function, the employer may only request a description or demonstration by the applicant if it routinely makes such a request of all applicants in the same job category. So, for

example, it would not be permitted for an employer to request that an applicant with one leg demonstrate his ability to assemble small parts while seated at a table, if the employer does not routinely request that all applicants provide such a demonstration.

An employer that requires an applicant with a disability to demonstrate how he or she will perform a job-related function must either provide the reasonable accommodation the applicant needs to perform the function or permit the applicant to explain how, with the accommodation, he or she will perform the function. If the job-related function is not an essential function, the employer may not exclude the applicant with a disability because of the applicant's inability to perform that function. Rather, the employer must, as a reasonable accommodation, either provide an accommodation that will enable the individual to perform the function, transfer the function to another position, or exchange the function for one the applicant is able to perform.

An employer may not use an application form that lists a number of potentially disabling impairments and ask the applicant to check any of the impairments he or she may have. In addition, as noted above, an employer may not ask how a particular individual became disabled or the prognosis of the individual's disability. The employer is also prohibited from asking how often the individual will require leave for treatment or use leave as a result of incapacitation because of the disability. However, the employer may state the attendance requirements of the job and inquire whether the applicant can meet them.

An employer is permitted to ask, on a test announcement or application form, that individuals with disabilities who will require a reasonable accommodation in order to take the test so inform the employer within a reasonable established time period prior to the administration of the test. The employer may also request that documentation of the need for the accommodation accompany the request. Requested accommodations may include accessible testing sites, modified testing conditions and accessible test formats. (See § 1630.11 Administration of Tests).

Physical agility tests are not medical examinations and so may be given at any point in the application or employment process. Such tests must be given to all similarly situated applicants or employees regardless of disability. If such tests screen out or tend to screen out an individual with a disability or a class of individuals with disabilities, the employer would have to demonstrate that the test is job-related and consistent with business necessity and that performance cannot be achieved with reasonable accommodation. (See § 1630.9 Not Making Reasonable Accommodation: Process of Determining the Appropriate Reasonable Accommodation).

As previously noted, collecting information and inviting individuals to identify themselves as individuals with disabilities as required to satisfy the affirmative action requirements of Section 503 of the Rehabilitation Act is not restricted by this

part. (See § 1630.1 (b) and (c) Applicability and Construction).

Section 1630.14(b) Employment Entrance Examination

An employer is permitted to require post-offer medical examinations before the employee actually starts working. The employer may condition the offer of employment on the results of the examination, provided that all entering employees in the same job category are subjected to such an examination, regardless of disability, and that the confidentiality requirements specified in this part are met.

This provision recognizes that in many industries, such as air transportation or construction, applicants for certain positions are chosen on the basis of many factors including physical and psychological criteria, some of which may be identified as a result of post-offer medical examinations given prior to entry on duty. Only those employees who meet the employer's physical and psychological criteria for the job, with or without reasonable accommodation, will be qualified to receive confirmed offers of employment and begin working.

Medical examinations permitted by this section are not required to be job-related and consistent with business necessity. However, if an employer withdraws an offer of employment because the medical examination reveals that the employee does not satisfy certain employment criteria, either the exclusionary criteria must not screen out or tend to screen out an individual with a disability or a class of individuals with disabilities, or they must be job-related and consistent with business necessity. As part of the showing that an exclusionary criteria is job-related and consistent with business necessity, the employer must also demonstrate that there is no reasonable accommodation that will enable the individual with a disability to perform the essential functions of the job. See Conference Report at 59-60; Senate Report at 39; House Labor Report at 73-74; House Judiciary Report at 43.

As an example, suppose an employer makes a conditional offer of employment to an applicant, and it is an essential function of the job that the incumbent be available to work every day for the next three months. An employment entrance examination then reveals that the applicant has a disabling impairment that, according to reasonable medical judgment that relies on the most current medical knowledge, will require treatment that will render the applicant unable to work for a portion of the three month period. Under these circumstances, the employer would be able to withdraw the employment offer without violating this part.

The information obtained in the course of a permitted entrance examination or inquiry is to be treated as a confidential medical record and may only be used in a manner not inconsistent with this part. State workers' compensation laws are not preempted by the ADA or this part. These laws require the collection of information from individuals for state administrative purposes that do not conflict with the ADA or this part. Consequently, employers or other covered

entities may submit information to state workers' compensation offices or state injury funds in accordance with state workers' compensation laws without violating this part.

Consistent with this section and with § 1630.16(f) of this part, information obtained in the course of a permitted entrance examination or inquiry may be used for insurance purposes described in § 1630.16(f).

Section 1630.14(c) Examination of Employees

This provision permits employers to make inquiries or require medical examinations (fitness for duty exams) when there is a need to determine whether an employee is still able to perform the essential functions of his or her job. The provision permits employers or other covered entities to make inquiries or require medical examinations necessary to the reasonable accommodation process described in this part. This provision also permits periodic physicals to determine fitness for duty or other medical monitoring if such physicals or monitoring are required by medical standards or requirements established by Federal, state, or local law that are consistent with the ADA and this part (or in the case of a federal standard, with section 504 of the Rehabilitation Act) in that they are job-related and consistent with business necessity.

Such standards may include federal safety regulations that regulate bus and truck driver qualifications, as well as laws establishing medical requirements for pilots or other air transportation personnel. These standards also include health standards promulgated pursuant to the Occupational Safety and Health Act of 1970, the Federal Coal Mine Health and Safety Act of 1969, or other similar statutes that require that employees exposed to certain toxic and hazardous substances be medically monitored at specific intervals. See House Labor Report at 74-75.

The information obtained in the course of such examination or inquiries is to be treated as a confidential medical record and may only be used in a manner not inconsistent with this part.

Section 1630.14(d) Other Acceptable Examinations and Inquiries

Part 1630 permits voluntary medical examinations, including voluntary medical histories, as part of employee health programs. These programs often include, for example, medical screening for high blood pressure, weight control counseling, and cancer detection. Voluntary activities, such as blood pressure monitoring and the administering of prescription drugs, such as insulin, are also permitted. It should be noted, however, that the medical records developed in the course of such activities must be maintained in the confidential manner required by this part and must not be used for any purpose in violation of this part, such as limiting health insurance eligibility. House Labor Report at 75; House Judiciary Report at 43-44.

Section 1630.15 Defenses

The section on defenses in part 1630 is not intended to be exhaustive. However, it is

intended to inform employers of some of the potential defenses available to a charge of discrimination under the ADA and this part.

Section 1630.15(a) Disparate Treatment Defenses

The "traditional" defense to a charge of disparate treatment under title VII, as expressed in *McDonnell Douglas Corp. v. Green*, 411 U.S. 792 (1973), *Texas Department of Community Affairs v. Burdine*, 450 U.S. 248 (1981), and their progeny, may be applicable to charges of disparate treatment brought under the ADA. See *Prewitt v. U.S. Postal Service*, 662 F.2d 292 (5th Cir. 1981). Disparate treatment means, with respect to title I of the ADA, that an individual was treated differently on the basis of his or her disability. For example, disparate treatment has occurred where an employer excludes an employee with a severe facial disfigurement from staff meetings because the employer does not like to look at the employee. The individual is being treated differently because of the employer's attitude towards his or her perceived disability. Disparate treatment has also occurred where an employer has a policy of not hiring individuals with AIDS regardless of the individuals' qualifications.

The crux of the defense to this type of charge is that the individual was treated differently not because of his or her disability but for a legitimate nondiscriminatory reason such as poor performance unrelated to the individual's disability. The fact that the individual's disability is not covered by the employer's current insurance plan or would cause the employer's insurance premiums or workers' compensation costs to increase, would not be a legitimate nondiscriminatory reason justifying disparate treatment of an individual with a disability. Senate Report at 85; House Labor Report at 136 and House Judiciary Report at 70. The defense of a legitimate nondiscriminatory reason is rebutted if the alleged nondiscriminatory reason is shown to be pretextual.

Section 1630.15 (b) and (c) Disparate Impact Defenses

Disparate impact means, with respect to title I of the ADA and this part, that uniformly applied criteria have an adverse impact on an individual with a disability or a disproportionately negative impact on a class of individuals with disabilities. Section 1630.15(b) clarifies that an employer may use selection criteria that have such a disparate impact, i.e., that screen out or tend to screen out an individual with a disability or a class of individuals with disabilities only when they are job-related and consistent with business necessity.

For example, an employer interviews two candidates for a position, one of whom is blind. Both are equally qualified. The employer decides that while it is not essential to the job it would be convenient to have an employee who has a driver's license and so could occasionally be asked to run errands by car. The employer hires the individual who is sighted because this individual has a driver's license. This is an example of a uniformly applied criterion, having a driver's permit, that screens out an individual who

has a disability that makes it impossible to obtain a driver's permit. The employer would, thus, have to show that this criterion is job-related and consistent with business necessity. See House Labor Report at 55.

However, even if the criterion is job-related and consistent with business necessity, an employer could not exclude an individual with a disability if the criterion could be met or job performance accomplished with a reasonable accommodation. For example, suppose an employer requires, as part of its application process, an interview that is job-related and consistent with business necessity. The employer would not be able to refuse to hire a hearing impaired applicant because he or she could not be interviewed. This is so because an interpreter could be provided as a reasonable accommodation that would allow the individual to be interviewed, and thus satisfy the selection criterion.

With regard to safety requirements that screen out or tend to screen out an individual with a disability or a class of individuals with disabilities, an employer must demonstrate that the requirement, as applied to the individual, satisfies the "direct threat" standard in § 1630.2(r) in order to show that the requirement is job-related and consistent with business necessity.

Section 1630.15(c) clarifies that there may be uniformly applied standards, criteria and policies not relating to selection that may also screen out or tend to screen out an individual with a disability or a class of individuals with disabilities. Like selection criteria that have a disparate impact, non-selection criteria having such an impact may also have to be job-related and consistent with business necessity, subject to consideration of reasonable accommodation.

It should be noted, however, that some uniformly applied employment policies or practices, such as leave policies, are not subject to challenge under the adverse impact theory. "No-leave" policies (e.g., no leave during the first six months of employment) are likewise not subject to challenge under the adverse impact theory. However, an employer, in spite of its "no-leave" policy, may, in appropriate circumstances, have to consider the provision of leave to an employee with a disability as a reasonable accommodation, unless the provision of leave would impose an undue hardship. See discussion at § 1630.5 Limiting, Segregating and Classifying, and § 1630.10 Qualification Standards, Tests, and Other Selection Criteria.

Section 1630.15(d) Defense to Not Making Reasonable Accommodation

An employer or other covered entity alleged to have discriminated because it did not make a reasonable accommodation, as required by this part, may offer as a defense that it would have been an undue hardship to make the accommodation.

It should be noted, however, that an employer cannot simply assert that a needed accommodation will cause it undue hardship, as defined in § 1630.2(p), and thereupon be relieved of the duty to provide accommodation. Rather, an employer will have to present evidence and demonstrate

that the accommodation will, in fact, cause it undue hardship. Whether a particular accommodation will impose an undue hardship for a particular employer is determined on a case by case basis. Consequently, an accommodation that poses an undue hardship for one employer at a particular time may not pose an undue hardship for another employer, or even for the same employer at another time. Likewise, an accommodation that poses an undue hardship for one employer in a particular job setting, such as a temporary construction worksite, may not pose an undue hardship for another employer, or even for the same employer at a permanent worksite. See House Judiciary Report at 42.

The concept of undue hardship that has evolved under Section 504 of the Rehabilitation Act and is embodied in this part is unlike the "undue hardship" defense associated with the provision of religious accommodation under title VII of the Civil Rights Act of 1964. To demonstrate undue hardship pursuant to the ADA and this part, an employer must show substantially more difficulty or expense than would be needed to satisfy the "de minimis" title VII standard of undue hardship. For example, to demonstrate that the cost of an accommodation poses an undue hardship, an employer would have to show that the cost is undue as compared to the employer's budget. Simply comparing the cost of the accommodation to the salary of the individual with a disability in need of the accommodation will not suffice. Moreover, even if it is determined that the cost of an accommodation would unduly burden an employer, the employer cannot avoid making the accommodation if the individual with a disability can arrange to cover that portion of the cost that rises to the undue hardship level, or can otherwise arrange to provide the accommodation. Under such circumstances, the necessary accommodation would no longer pose an undue hardship. See Senate Report at 36; House Labor Report at 68-69; House Judiciary Report at 40-41.

Excessive cost is only one of several possible bases upon which an employer might be able to demonstrate undue hardship. Alternatively, for example, an employer could demonstrate that the provision of a particular accommodation would be unduly disruptive to its other employees or to the functioning of its business. The terms of a collective bargaining agreement may be relevant to this determination. By way of illustration, an employer would likely be able to show undue hardship if the employer could show that the requested accommodation of the upward adjustment of the business' thermostat would result in it becoming unduly hot for its other employees, or for its patrons or customers. The employer would thus not have to provide this accommodation. However, if there were an alternate accommodation that would not result in undue hardship, the employer would have to provide that accommodation.

It should be noted, moreover, that the employer would not be able to show undue hardship if the disruption to its employees were the result of those employees' fears or prejudices toward the individual's disability and not the result of the provision of the

accommodation. Nor would the employer be able to demonstrate undue hardship by showing that the provision of the accommodation has a negative impact on the morale of its other employees but not on the ability of these employees to perform their jobs.

Section 1630.15(e) Defense—Conflicting Federal Laws and Regulations

There are several Federal laws and regulations that address medical standards and safety requirements. If the alleged discriminatory action was taken in compliance with another Federal law or regulation, the employer may offer its obligation to comply with the conflicting standard as a defense. The employer's defense of a conflicting Federal requirement or regulation may be rebutted by a showing of pretext, or by showing that the Federal standard did not require the discriminatory action, or that there was a nonexclusionary means to comply with the standard that would not conflict with this part. See House Labor Report at 74.

Section 1630.16 Specific Activities Permitted

Section 1630.16(a) Religious Entities

Religious organizations are not exempt from title I of the ADA or this part. A religious corporation, association, educational institution, or society may give a preference in employment to individuals of the particular religion, and may require that applicants and employees conform to the religious tenets of the organization. However, a religious organization may not discriminate against an individual who satisfies the permitted religious criteria because that individual is disabled. The religious entity, in other words, is required to consider qualified individuals with disabilities who satisfy the permitted religious criteria on an equal basis with qualified individuals without disabilities who similarly satisfy the religious criteria. See Senate Report at 42; House Labor Report at 76-77; House Judiciary Report at 46.

Section 1630.16(b) Regulation of Alcohol and Drugs

This provision permits employers to establish or comply with certain standards regulating the use of drugs and alcohol in the workplace. It also allows employers to hold alcoholics and persons who engage in the illegal use of drugs to the same performance and conduct standards to which it holds all of its other employees. Individuals disabled by alcoholism are entitled to the same protections accorded other individuals with disabilities under this part. As noted above, individuals currently engaging in the illegal use of drugs are not individuals with disabilities for purposes of part 1630 when the employer acts on the basis of such use.

Section 1630.16(c) Drug Testing

This provision reflects title I's neutrality toward testing for the illegal use of drugs. Such drug tests are neither encouraged, authorized nor prohibited. The results of such drug tests may be used as a basis for disciplinary action. Tests for the illegal use of

drugs are not considered medical examinations for purposes of this part. If the results reveal information about an individual's medical condition beyond whether the individual is currently engaging in the illegal use of drugs, this additional information is to be treated as a confidential medical record. For example, if a test for the illegal use of drugs reveals the presence of a controlled substance that has been lawfully prescribed for a particular medical condition, this information is to be treated as a confidential medical record. See House Labor Report at 79; House Judiciary Report at 47.

Section 1630.16(e) Infectious and Communicable Diseases; Food Handling Jobs

This provision addressing food handling jobs applies the "direct threat" analysis to the particular situation of accommodating individuals with infectious or communicable diseases that are transmitted through the handling of food. The Department of Health and Human Services is to prepare a list of infectious and communicable diseases that are transmitted through the handling of food. If an individual with a disability has one of the listed diseases and works in or applies for a position in food handling, the employer must determine whether there is a reasonable accommodation that will eliminate the risk of transmitting the disease through the handling of food. If there is an accommodation that will not pose an undue hardship, and that will prevent the transmission of the disease through the handling of food, the employer must provide the accommodation to the individual. The employer, under these circumstances, would not be permitted to discriminate against the individual because of the need to provide the reasonable accommodation and would be required to maintain the individual in the food handling job.

If no such reasonable accommodation is possible, the employer may refuse to assign, or to continue to assign the individual to a position involving food handling. This means that if such an individual is an applicant for a food handling position the employer is not required to hire the individual. However, if the individual is a current employee, the employer would be required to consider the accommodation of reassignment to a vacant position not involving food handling for which the individual is qualified. Conference Report at 61-63. (See § 1630.2(r) Direct Threat).

Section 1630.16(f) Health Insurance, Life Insurance, and Other Benefit Plans

This provision is a limited exemption that is only applicable to those who establish, sponsor, observe or administer benefit plans, such as health and life insurance plans. It does not apply to those who establish, sponsor, observe or administer plans not involving benefits, such as liability insurance plans.

The purpose of this provision is to permit the development and administration of benefit plans in accordance with accepted principles of risk assessment. This provision is not intended to disrupt the current regulatory structure for self-insured employers. These employers may establish,

sponsor, observe, or administer the terms of a bona fide benefit plan not subject to state laws that regulate insurance. This provision is also not intended to disrupt the current nature of insurance underwriting, or current insurance industry practices in sales, underwriting, pricing, administrative and other services, claims and similar insurance related activities based on classification of risks as regulated by the States.

The activities permitted by this provision do not violate part 1630 even if they result in limitations on individuals with disabilities, provided that these activities are not used as a subterfuge to evade the purposes of this part. Whether or not these activities are being used as a subterfuge is to be determined without regard to the date the insurance plan or employee benefit plan was adopted.

However, an employer or other covered entity cannot deny a qualified individual with a disability equal access to insurance or subject a qualified individual with a disability to different terms or conditions of insurance based on disability alone, if the disability does not pose increased risks. Part 1630 requires that decisions not based on risk classification be made in conformity with non-discrimination requirements. See Senate Report at 84-86; House Labor Report at 136-138; House Judiciary Report at 70-71. See the discussion of § 1630.5 Limiting, Segregating and Classifying.

[FR Doc. 91-17512 Filed 7-25-91; 8:45 am]

BILLING CODE 6750-06-M

EQUAL EMPLOYMENT OPPORTUNITY COMMISSION

29 CFR Parts 1602 and 1627

Recordkeeping and Reporting Under Title VII and the ADA

AGENCY: Equal Employment Opportunity Commission (EEOC).

ACTION: Final rule.

SUMMARY: This final rule is based on two separate Notices of Proposed Rulemaking (NPRM) published on February 13, 1989 (54 FR 6551), and March 5, 1991 (56 FR 9185). This final rule amends 29 CFR part 1602, EEOC's regulations on Recordkeeping and Reporting under title VII of the Civil Rights Act of 1964 (title VII), to add recordkeeping requirements under the Americans with Disabilities Act of 1990 (ADA). It increases the records retention period required in part 1602 for title VII and the ADA from 6 months to one year. The Commission also is adding a new subpart R to part 1602, 29 CFR 1602.56, that will clarify that the Commission has the authority to investigate persons to determine whether they comply with the reporting or recordkeeping requirements of part 1602. In addition, the Commission is making several minor changes to §§ 1602.7 and 1602.10.

The Commission also is deleting § 1602.14(b) of its title VII recordkeeping regulations, which provides that the § 1602 recordkeeping requirements do not apply to temporary or seasonal positions. Information regarding such employees now must be reported on Standard Form 100 on September 30 of each year, in the same fashion as information regarding permanent employees is reported. Similarly, the Commission is deleting §§ 1627.3(b) and 1627.4(a)(2) of the Age Discrimination in Employment Act recordkeeping regulations, which provide for a 90-day retention period for temporary positions, and is clarifying the mandatory nature of such recordkeeping. The Commission is not issuing a final rule on proposed § 1602.57 at this time.

EFFECTIVE DATE: August 26, 1991.

FOR FURTHER INFORMATION CONTACT: Thomas J. Schlageter, Acting Assistant Legal Counsel, Grace C. Karmiol, General Attorney, or Wendy Adams, General Attorney, at (202) 663-4669 (voice) or (202) 663-4399 (TDD).

SUPPLEMENTARY INFORMATION: The Commission received nine comments in response to the NPRM published in the March 5, 1991 Federal Register on Recordkeeping and Reporting under title VII and the ADA. The comments responded to the invitation in the preamble of the NPRM for comment on whether there should be a reporting requirement under the ADA, how the reported information should be used, and how it should be collected. Four comments recommended that there be a reporting requirement although one of them suggested that it be collected by sampling rather than universal reporting. Five comments opposed any new reporting requirements on the grounds of administrative burden. One of these suggested that no reporting requirement be imposed at this time, but that the need for reporting be reassessed at a later date. Another of these argued that if a reporting requirement is necessary, it should be accomplished by using the existing EEO-1 rather than a separate report, should be collected by both employer visual identification and employee self-identification, and should be used to monitor the impact of the ADA and to document utilization of persons with disabilities, not for affirmative action purposes. The Commission is continuing its consideration of possible reporting requirements under the ADA and will confer with the Department of Labor, and any other affected federal agency, to discuss whether a reporting requirement would be appropriate under

the ADA. If it concludes that a reporting requirement may be appropriate, it will issue an NPRM.

The Commission received over 20 comments in response to the February 13, 1989 NPRM. While this preamble does not address each individual comment, it addresses the most significant issues raised in the comments. Current § 1602.7 concerns the filing of Standard Form 100, and has been interpreted in conjunction with the instructions accompanying the form. In order to clarify which of the employers that are subject to title VII must file the report, the Commission has incorporated some of the information that is contained in the instructions into § 1602.7.

Current § 1602.14 provides that personnel or employment records made or kept by an employer shall be preserved by the employer for a period of six months from the date of the making of the record or of the personnel action involved, whichever is later. This requirement was promulgated before title VII was amended in 1972 to change the time limit for filing a charge from 90 days to 180 days (or, in some instances, to 300 days). Requiring an employer or labor organization to maintain records for six months when the charge filing limit was 90 days ensured that all applicable records were kept. Due to the lengthening of the filing period, however, it no longer is true that employers or labor organizations necessarily will have retained records until the title VII filing period expires. Under the current regulation, an employer or labor organization may have already lawfully destroyed its employment records before it is notified that a charge has been filed. Moreover, a one year retention period for employers and labor organizations subject to title VII and the ADA will make the records retention period the same as that required by the Commission's regulations under the Age Discrimination in Employment Act, 29 U.S.C. 621 *et seq.* (ADEA), 29 CFR 1627.3(b)(1) and 1627.4(a)(1). This uniform retention period will simplify and clarify recordkeeping for employers who are also subject to the ADEA.

In order to promote efficiency and to eliminate confusion as to recordkeeping requirements regarding temporary and seasonal employees, the Commission is deleting § 1602.14(b) which provides that the part 1602 recordkeeping requirements do not apply to temporary or seasonal positions. Similarly, the Commission is deleting §§ 1627.3(b)(3) and 1627.4(a)(2) of the ADEA recordkeeping regulations, which

provide for a 90 day records retention period for temporary positions, and is clarifying the mandatory nature of such recordkeeping. These changes will require employers to retain records on all employees, permanent and temporary, for a one year period. They will, however, impose a new recordkeeping requirement only on the relatively few employers who are not subject to the recordkeeping provisions of the ADEA.

Section 709(c) of title VII, 42 U.S.C. 2000e-8(c), provides, *inter alia*, that any person who fails to maintain information as required by that subsection and by Commission regulations may, upon application of the Commission or the Attorney General in a case involving a government, governmental agency or political subdivision, be ordered to comply by the appropriate United States district court. At present, Commission regulations do not explicitly provide that the Commission may conduct an investigation when it has reason to believe an employer or other entity subject to title VII has failed to comply with the recordkeeping requirements of part 1602, as when, for example, an employer does not provide the required recordkeeping information to the Commission. The Commission is adding § 1602.56 to give clear notice of its authority to enforce section 709(c) of title VII. The addition of this section is consistent with the Commission's authority to issue suitable procedural regulations to carry out the provisions of title VII, 42 U.S.C. 2000e-12(a), and is an appropriate procedural mechanism for investigating apparent violations of those provisions.

The revisions to § 1602.7 change the annual Standard Form 100 reporting date from March 31 to September 30. By changing the reporting date the Commission also is changing the dates for which the information should be reported, i.e., from the three months preceding March 31, to the three months preceding September 30. Any employer that has received permission to use a different period for reporting may continue to use that approved period. The Commission has determined that this change will result in a reporting date that is less affected by the variation in seasonal employment, such as employment in the construction industry, than the present date and will provide employment figures which reflect annual average employment more closely than the present date does. This change will not affect the date by which employers must report VETS information to the United States

Department of Labor, as the VETS data and the Standard Form 100 data are processed separately. The revisions also change the address for obtaining necessary reporting supplies from "Jeffersonville, Indiana" to "the Commission or its delegate."

The revision to § 1602.10 deletes the reference to "section 4(c) of the instructions" and substitutes "section 5 of the instructions." The reference to the 100 employee jurisdictional test of section 701(b) of title VII is deleted since the number of employees required for an employer to be subject to title VII now is 15 or more. This change in no way affects the present Standard Form 100 reporting requirement of 100 or more employees that is set out in the instructions accompanying the form and now is made explicit in the regulation.

In order to provide a mechanism for those subject to the reporting requirements to seek a change in the reporting date or the date by which data should be reported, the Commission has revised § 1602.10 to permit employers to seek changes in those requirements. The Commission notes that retention of the records for the period of one year will increase only minimally, if at all, the employer's cost of maintaining the records. Employers already are required to maintain the records for a period of six months. The cost of retaining the records for an additional six months will be minimal. Moreover, most employers subject to Title VII also are subject to the ADEA, which presently requires that these records be retained for a period of one year.

The Commission estimates that the changes to §§ 1602.14 and 1602.28(a) increasing the title VII records retention period from six months to one year will result in an increased recordkeeping burden on employers of approximately 9,000 burden hours annually. The Commission estimates that the changes in the title VII and ADEA recordkeeping requirements for employers with temporary employees will result in an increased recordkeeping burden of approximately 20,800 burden hours annually. The Commission believes that this increase in burden hours is *de minimis* and that the modifications will not have a significant impact on a substantial number of small employers. Further, the Commission believes that the above cited benefits of the modifications, by establishing a uniform period of recordkeeping for full time and part time employees under title VII, ADA and the ADEA, outweigh the minimal increase in recordkeeping burden hours on employers. For the above reasons, the regulatory change

will simplify the recordkeeping requirements. The Commission also certifies under 5 U.S.C. 605(b), enacted by the Regulatory Flexibility Act (Pub. L. No. 96-354), that these modifications will not result in a significant economic impact on a substantial number of small employers and that a regulatory flexibility analysis therefore is not required.

List of Subjects in 29 CFR Parts 1602 and 1627

Equal employment opportunity, Reporting and recordkeeping requirements.

For the Commission,
Evan J. Kemp, Jr.,
Chairman.

Accordingly, 29 CFR parts 1602 and 1627 are amended as follows:

PART 1602—[AMENDED]

1. The heading for part 1602 is revised to read as follows:

PART 1602—RECORDKEEPING AND REPORTING REQUIREMENTS UNDER TITLE VII AND THE ADA

2. The authority citation for part 1602 is revised to read as follows:

Authority: 42 U.S.C. 2000e-8, 2000e-12; 44 U.S.C. 3501 et seq.; 42 U.S.C. 12117.

3. Section 1602.1 is revised to read as follows:

§ 1602.1 Purpose and scope.

Section 709 of title VII (42 U.S.C. 2000e) and section 107 of the Americans with Disabilities Act (ADA) (42 U.S.C. 12117) require the Commission to establish regulations pursuant to which employers, labor organizations, joint labor-management committees, and employment agencies subject to those Acts shall make and preserve certain records and shall furnish specified information to aid in the administration and enforcement of the Acts.

4. The heading for Subpart A is revised to read as follows:

Subpart A—General

§ 1602.1 [Amended]

5. Section 1602.1 is moved under subpart A.

§§ 1602.2-1602.6 [Removed]

6. Sections 1602.2-1602.6 are removed and reserved.

§ 1602.7 [Amended]

7. Section 1602.7 is amended by revising the first and last sentences to read as follows:

§ 1602.7 Requirement for filing of report.

On or before September 30 of each year, every employer that is subject to title VII of the Civil Rights Act of 1964, as amended, and that has 100 or more employees, shall file with the Commission or its delegate executed copies of Standard Form 100, as revised (otherwise known as "Employer Information Report EEO-1") in conformity with the directions set forth in the form and accompanying instructions. * * * Appropriate copies of Standard Form 100 in blank will be supplied to every employer known to the Commission to be subject to the reporting requirements, but it is the responsibility of all such employers to obtain necessary supplies of the form from the Commission or its delegate prior to the filing date.

8. Section 1602.10 is revised to read as follows:

§ 1602.10 Employer's exemption from reporting requirements.

If an employer claims that the preparation or filing of the report would create undue hardship, the employer may apply to the Commission for an exemption from the requirements set forth in this part, according to instruction 5. If an employer is engaged in activities for which the reporting unit criteria described in section 5 of the instructions are not readily adaptable, special reporting procedures may be required. If an employer seeks to change the date for filing its Standard Form 100 or seeks to change the period for which data are reported, an alternative reporting date or period may be permitted. In such instances, the employer should so advise the Commission by submitting to the Commission or its delegate a specific written proposal for an alternative reporting system prior to the date on which the report is due.

§ 1602.11 [Amended]

9. Section 1602.11 is amended as follows:

a. In the first sentence, after "purposes of title VII" insert "or the ADA".

b. In the second sentence, after "section 709(c) of title VII" insert "or section 107 of the ADA".

§ 1602.12 [Amended]

10. Section 1602.12 is amended as follows:

a. In the first sentence, after "purposes of Title VII" insert "or the ADA".

b. In the second sentence, after "section 709(c)" insert "of Title VII, or section 107 of the ADA".

c. By revising the parenthetical at the end of the section to read as follows:

(Approved by the Office of Management and Budget under control number 3046-0040)

§ 1602.14 [Amended]

11. Section 1602.14(a) is amended as follows:

a. By removing the words "6 months" wherever they appear and replacing them with the words "one year".

b. In the first sentence, after "not necessarily limited to" insert "requests for reasonable accommodation,".

c. In the third sentence, after "under title VII" insert "or the ADA".

d. By revising the parenthetical at the end of the section to read as follows:

(Approved by the Office of Management and Budget under control number 3046-0040)

§ 1602.14 [Amended]

12. Section 1602.14 is amended by removing paragraph (b), by removing the designation from paragraph (a), and by revising the parenthetical at the end of the section to read as follows:

(Approved by the Office of Management and Budget under control number 3046-0040)

§ 1602.19 [Amended]

13. Section 1602.19 is amended as follows:

a. In the first sentence, after "purpose of Title VII" insert "or the ADA".

b. In the second sentence, after "section 709(c) of title VII" insert "or section 107 of the ADA".

§ 1602.21 [Amended]

14. Section 1602.21(b) is amended as follows:

a. In the first sentence, after "not necessarily limited to" insert "requests for reasonable accommodation,".

b. In the second sentence, after "under Title VII" insert "or the ADA".

§ 1602.26 [Amended]

15. Section 1602.26 is amended as follows:

a. In the first sentence, after "purposes of Title VII" insert "or the ADA".

b. In the second sentence, after "section 709(c)" insert "of Title VII or section 107 of the ADA".

§ 1602.28 [Amended]

16. Section 1602.28(a) is amended as follows:

a. By removing the words "6 months" wherever they appear and replacing them with the words "one year".

b. In the third sentence, after "under title VII" insert "or the ADA".

c. By revising the parenthetical at the end of the section to read as follows:

(Approved by the Office of Management and Budget under control number 3046-0040)

§ 1602.31 [Amended]

17. Section 1602.31 is amended as follows:

a. By removing paragraph (b) and the designation from paragraph (a).

b. In the first sentence, after "not necessarily limited to" insert "requests for reasonable accommodation."

c. In the third sentence, after "under title VII" insert "or the ADA".

d. By revising the parenthetical at the end of the section to read as follows:

(Approved by the Office of Management and Budget under control number 3046-0040)

§ 1602.37 [Amended]

18. Section 1602.37 is amended as follows:

a. In the first sentence, after "purposes of title VII" insert "or the ADA".

b. In the second sentence, after "section 709(c) of title VII" insert "or section 107 of the ADA".

§ 1602.40 [Amended]

19. Section 1602.40 is amended as follows:

a. By removing paragraph (b) and the designation from paragraph (a).

b. In the first sentence, after "not necessarily limited to" insert "requests for reasonable accommodation."

c. By revising the parenthetical at the end of the section to read as follows:

(Approved by the Office of Management and Budget under control number 3046-0040)

§ 1602.45 [Amended]

20. Section 1602.45 is amended as follows:

a. In the first sentence, after "purposes of title VII" insert "or the ADA".

b. In the second sentence, after "section 709(c) of title VII" insert "or section 107 of the ADA".

§ 1602.49 [Amended]

21. Section 1602.49 is amended as follows:

a. By removing paragraph (b) and redesignating paragraph (c) as new paragraph (b).

b. In the first sentence of paragraph (a), after "not necessarily limited to" insert "requests for reasonable accommodation."

c. By revising the parenthetical at the end of the section to read as follows:

(Approved by the Office of Management and Budget under control number 3046-0040)

§ 1602.54 [Amended]

22. Section 1602.54 is amended as follows:

a. In the first sentence, after "purposes of title VII" insert "or the ADA".

b. In the second sentence, after "section 709(c) of title VII" insert "or section 107 of the ADA".

23. A new subpart R consisting of § 1602.56 is added, to read as follows:

Subpart R—Investigation of Reporting or Recordkeeping Violations

§ 1602.56 Investigation of reporting or recordkeeping violations.

When it has received an allegation, or has reason to believe, that a person has not complied with the reporting or recordkeeping requirements of this Part or of Part 1607 of this chapter, the Commission may conduct an

investigation of the alleged failure to comply.

Part 1627—[Amended]

24. The authority citation for 29 CFR part 1627 continues to read as follows:

Authority: Sec. 7, 81 Stat. 604; 29 U.S.C. 626; sec. 11, 52 Stat. 1066; 29 U.S.C. 211; sec. 12, 29 U.S.C. 631, Pub. L. No. 99-592, 100 Stat. 3342; sec. 2, Reorg. Plan No. 1 of 1978, 43 FR 19807.

§ 1627.3 [Amended]

25. In § 1627.3, paragraph (b)(3) is removed and paragraph (b)(4) is redesignated as new paragraph (b)(3).

26. Newly designated § 1627.3(b)(3) is amended by removing the word "may" and replacing it with the word "shall" and by revising the words "paragraph (b) (1), (2), or (3)" to read "paragraph (b) (1) or (2)".

§ 1627.4 [Amended]

27. In § 1627.4, paragraph (a)(2) is removed and paragraph (a)(3) is redesignated as new paragraph (a)(2).

28. Newly designated § 1627.4(a)(2) is amended by removing the word "may" and replacing it with the word "shall" and by revising the words "paragraph (a) (1) or (2)" to read "paragraph (a)(1)".

§ 1627.5 [Amended]

29. Section 1627.5(c) is amended by removing the word "may" and replacing it with the word "shall".

[FR Doc. 91-17513 Filed 7-25-91; 8:45 am]

BILLING CODE 6750-08-M

Environmental Register

Friday
July 26, 1991

Part VI

Environmental Protection Agency

40 CFR Parts 261, 271, and 302
Identification and Listing of Hazardous
Waste; Coke By-Products Waste;
Proposed Rule and Request for
Comments

ENVIRONMENTAL PROTECTION AGENCY

49 CFR Parts 261, 271, and 302

[FRL-3901-8]

Hazardous Waste Management Systems: Identification and Listing of Hazardous Waste; CERCLA Hazardous Substance Designation; Reportable Quantity Adjustment, Coke By-Products Waste Listings

AGENCY: Environmental Protection Agency.

ACTION: Proposed rule and request for comments.

SUMMARY: The Environmental Protection Agency (EPA) is today proposing to amend the regulations for hazardous waste listing under the Resource Conservation and Recovery Act (RCRA) by adding seven additional wastes generated during the production, recovery, and refining of coke by-products produced from coal to the list of hazardous wastes under 40 CFR 261.32. The EPA is also proposing to amend appendix VII of 40 CFR part 261 to add the constituents for which these wastes are being listed. The listings are being proposed pursuant to the Hazardous and Solid Waste Amendments (HSWA) of 1984.

In addition, the Agency is proposing amendments to the Comprehensive Environmental Response, Compensation, and Liability Act (CERCLA) regulations in 40 CFR part 302 that are related to today's proposed waste listings. The EPA is proposing to designate all of the wastes proposed in today's rule as hazardous substances under CERCLA and is proposing to adjust the reportable quantities (RQs) that would be applicable to these wastes from the statutory level of one pound to their final RQs.

The effect of this proposed regulation, if promulgated, would be to subject these wastes to the hazardous waste regulations under 40 CFR parts 124, 262 through 268, 268, 270, and 271, and to the notification requirements under RCRA section 3010; and the notification requirements under CERCLA section 103.

In addition to the listings, the Agency is proposing a series of exclusions to the definition of solid waste designed to facilitate the recycling of the wastes proposed in today's notice. The effect of these proposals, if promulgated, will be to allow the reinsertion of the proposed wastes into a coke oven or mixing with coal tar products in an environmentally responsible fashion.

DATES: EPA will accept public comments on this proposed rule until September 24, 1991. For the recycling exclusions proposed in 40 CFR 261.4(a)(12), EPA will accept public comments only until August 16, 1991. Comments received after these dates will be marked late and may not be considered. Any person may request a public hearing on this proposed regulation by filing a request with EPA, to be received no later than August 12, 1991.

ADDRESSES: The public must send an original and three copies of their comments to: EPA RCRA Docket Clerk (OS-305), 401 M Street SW., Washington, DC 20460. The Docket Number F-91-CBPP-FFFFF should appear on all comments. The RCRA docket is located in room M2427 at the above address and is open from 9 a.m. to 4 p.m., Monday through Friday, excluding Federal holidays. The public must make an appointment to review docket materials by calling (202) 475-9327. The public may copy a maximum of 100 pages of material from any one regulatory docket at no cost; additional copies cost \$0.15 per page. Copies of the listing Background Document, Health and Environmental Effects Profiles (HEEPs), and other references that are not readily available can be viewed and copied in the RCRA docket. Certain sections of the background document contain Confidential Business Information (CBI) and are not available to the public.

Copies of materials that support the Reportable Quantities (RQs) for waste streams K141 through K145, K147, and K148 are available in Room M2427 at the U.S. Environmental Protection Agency, 401 M Street SW., Washington, DC 20460. This docket is available for inspection between the hours of 9 a.m. and 4 p.m., Monday through Friday, excluding Federal holidays. As provided in 40 CFR part 2, a reasonable fee may be charged for copying services. Comments on the CERCLA portion of today's proposal should be sent in triplicate to: Emergency Response Division, Superfund Docket and Information Center, Attention: Docket Clerk (OS-245), Docket No. 102RQ-7COKE, room M2514, U.S. Environmental Protection Agency, 401 M Street SW., Washington, DC 20460. The docket number 102RQ-7COKE should appear on all comments.

Requests for a hearing should be addressed to Mr. David Bussard, Director, Characterization and Assessment Division, Office of Solid Waste, U.S. Environmental Protection

Agency (OS-330), 401 M Street SW., Washington, DC 20460.

FOR FURTHER INFORMATION CONTACT: The RCRA/Superfund Hotline at (800) 424-9346 or (202) 382-3000. For technical information on the RCRA portion of the proposal, contact Mr. Ron Josephson, Listing Section, Office of Solid Waste (OS-333), U.S. Environmental Protection Agency, 401 M Street SW., Washington, DC 20460, (202) 382-4770. For technical information on the CERCLA portion of the proposal, contact Ms. Gerain Perry, Response Standards and Criteria Branch, Office of Emergency and Remedial Response (OS-210), U.S. Environmental Protection Agency, 401 M Street SW., Washington, DC 20460, (202) 382-2190.

SUPPLEMENTARY INFORMATION: The contents of today's preamble are listed in the following outline:

- I. Background
 - A. Introduction
 - B. Previous Listings
 - C. Proposal to List Tar Refining Wastewaters
 - D. Toxicity Characteristic Rule
 - E. Industrial Furnace Rules
 - F. Today's Proposal
- II. Summary of the Proposed Regulation
 - A. Overview of the Proposal
 - B. Industry Description
 - C. Description of Wastes
 1. Process and Waste Descriptions
 - a. Coke By-Products
 - b. Tar Refining
 2. Quantities of Waste Generated
 3. Waste Management Practices
 - D. Basis for Listing
 1. Summary of Basis for Listing
 - a. Leaching Protocols
 - b. Groundwater Models
 2. Waste Characterization and Constituents of Concern
 3. Mobility of Constituents of Concern
 4. Persistence of Constituents of Concern
 5. Health Effects of Concern
 6. Mismanagement Case Histories
 7. Conclusions
 - E. Recycling
 1. Classification as a Solid Waste
 2. Rationale for Exclusions from the Definition of Solid Waste for Coke By-Products Residuals Recycled to the Coke Oven or when Mixed with Coal Tar
 3. Descriptions of Management Practices for the Wastes Proposed for Listing as Hazardous from the Point of Generation to the Point of Reinsertion into Coke Ovens or Mixing with Coal Tar
 - a. Management Practices for Residuals from their Point of Generation to the Point of Reinsertion into Coke Ovens
 - (i) Conveyance to storage or blending unit
 - (ii) Blending of residuals with coal
 - (iii) Feeding the coke oven
 - b. Management Practices for Residuals Proposed for Listing as Hazardous Prior to Blending with Coal Tar

4. Similar Exclusion for Decanter Tank Tar Sludge (K087) when Reinserted into Coke Ovens or Blended with Coal Tar
 5. Generator Requirements
 6. Other Options
 7. Conclusions
- F. Proposal Not to List Coke By-Products Wastewaters
- G. Impact of Future Land Disposal Restrictions (LDR) Determinations
1. Request for Comment on the Agency's Approach to Pollution Prevention in the LDR Program
 2. Request for Comment on the Agency's Approach to the Development of BDAT Treatment Standards
 3. Request for Comment on the Agency's Approach to the Analyses of BDAT Treatment Capacity
- III. State Authority
- A. Applicability of Rules in States
 - B. Effect on State Authorizations
- IV. CERCLA Designation and RQ Adjustment
- V. Cost and Economic Analysis
- VI. Regulatory Flexibility Act
- VII. Paperwork Reduction Act
- VIII. Compliance and Implementation
- A. Section 3010 Notification
 - B. Compliance Dates for Facilities
- IX. References

I. Background

A. Introduction

Pursuant to section 3001 of subtitle C of RCRA, EPA proposes to list as hazardous seven wastes generated from the production, recovery, and refining of coke by-products produced from coal. Three wastes generated by this industry (EPA Hazardous Waste No. K035—Wastewater treatment sludges generated in the production of creosote; EPA Hazardous Waste No. K060—Ammonia still lime sludge from coking operations; and EPA Hazardous Waste No. K087—Decanter tank tar sludge from coking operations) currently are listed and are regulated as hazardous wastes. Another waste (process wastewater from the production of creosote) was proposed for regulation under RCRA previously (see 45 FR 33136); however, this proposal has never been finalized. The following discussion provides a brief overview of prior regulatory action affecting wastes from this industry as well as summarizes the Agency's basis for proposing to list as hazardous the wastes covered by this rule.

B. Previous Listings

As part of its final and interim final regulations implementing Section 3001 of RCRA, EPA published several lists of hazardous wastes generated from specific and nonspecific sources. These lists have been amended several times

and are published in 40 CFR 261.31 and 261.32. Among other things, on May 19, 1980, EPA listed ammonia still lime sludge (EPA Hazardous Waste No. K060) under the category of iron and steel, and wastewater treatment sludge from the production of creosote (EPA Hazardous Waste No. K035) under the category of pesticides (see 45 FR 33123–33124).¹ Decanter tank tar sludge (EPA Hazardous Waste No. K087) was added to the list of hazardous wastes on July 16, 1980, under the category of coking (see 45 FR 47832).

C. Proposal to List Tar Refining Wastewaters

The Agency also proposed to add process wastewaters from the production of creosote (*i.e.*, tar refining) to the list of hazardous wastes from specific sources (see 45 FR 33136, May 19, 1980). This proposed listing was never made final. The Agency has now tentatively decided not to list process wastewater from creosote production for the reasons explained later in this preamble (see Section I.F of today's proposal).

D. Toxicity Characteristic Rule

On March 29, 1990, as part of its regulations implementing the Hazardous and Solid Waste Amendments of 1984, the Agency amended the Toxicity Characteristics rule (TC) (40 CFR 261.24) by adding 25 additional organic hazardous constituents to the list of toxic constituents of concern and substituting a new leaching procedure called the Toxicity Characteristic Leaching Procedure (TCLP) (55 FR 11798–11862). With the promulgation of the Toxicity Characteristic, a number of wastes generated by coke by-products plants and tar refining operations, including wastes proposed for listing in today's proposal, are expected to be characteristically hazardous because they fail the Toxicity Characteristic for benzene (one of the 25 additional organic compounds). Some wastes generated by coke by-products plants and tar refining operations may also fail the TC levels for ortho-, meta- and/or para-cresol. For some of the wastes addressed in today's proposal, analytical results from the TCLP may not completely reveal the true nature of

the toxicity of these wastes owing to the difficulties that may be experienced while performing the test.² Specifically, tarry samples pose problems with sample homogenization, filtration, and dispersion of solids in the leaching medium. Because of these difficulties, EPA believes that the TCLP tends to provide analytical results which underestimate the concentrations of hazardous constituents in leachate from these wastes. Further details on the relationship of the TC and these wastes are discussed in section II.D.1 of today's proposal.

E. Industrial Furnace Rules

On January 4, 1985, EPA promulgated amendments to the definition of solid waste which made clear that secondary materials that are burned in boilers and industrial furnaces for energy and materials recovery were solid wastes (see 50 FR 614, *et seq.*). The Agency also defined industrial furnaces as a specific list of "... enclosed devices that are integral components of manufacturing processes and that use controlled flame devices to accomplish recovery of materials or energy..." (40 CFR 260.10). Coke ovens were included on the list of devices considered to be industrial furnaces, although coke ovens do not "burn" coal.

On February 21, 1991 (see 56 FR 7134–7240), EPA promulgated permitting standards for boilers and industrial furnaces that burn hazardous waste. The standards include controls for emissions of toxic organic compounds, toxic metals, and hydrogen chloride. In addition, the rule includes provisions that subject owners and operators of boilers and industrial furnaces that burn hazardous waste to the same general facility standards applicable to hazardous waste treatment, storage, and disposal facilities.

In the preamble to the February 21, 1991 rule, EPA stated that the permitting standards apply to boilers and industrial furnaces that burn hazardous waste for the purpose of both materials and energy recovery. The February 21, 1991 preamble identified coke ovens as industrial furnaces that use hazardous waste for these two purposes and stated that these devices would be subject to regulation. However, the February 21, 1991 rule also excludes from the definition of solid waste coke and coal tar from the iron and steel industry that contain or are produced from EPA

¹ Creosote, one of the major products produced by the refining of coal tar in coke by-products plants, is used as a pesticide in the preservation of wood. The Agency elected to list K035 under the industrial category of pesticides and used the term creosote production to describe the overall operation of tar refining. All tar refining operations produce creosote; therefore, there is no substantive difference in scope between the terms tar refining and creosote production.

² Research Triangle Institute, Evaluation and Modification of Method 1311 for Determining the Release Potential of Difficult-to-Filter Wastes, Final Report, April 1990.

Hazardous Waste No. K087, decanter tar tank sludge (see 56 FR 7202-7203). This exclusion extends to by-products recovered from coke oven gas generated by coke ovens charged with mixtures of coal and decanter tar tank sludge which otherwise would be considered hazardous. The Agency is today proposing to modify this exclusion for K087 wastes somewhat, and is proposing a similar exclusion for the wastes proposed to be listed in today's notice.

F. Today's Proposal

EPA is proposing today to amend 40 CFR part 261 by adding seven waste streams to the list of hazardous wastes from specific sources. Five wastes generated during the production and recovery of coke by-products will be added to the "Coking" section of the list, and two wastes from the refining of coal tar will be added to the "Pesticides" section.

Sections 3001 (a), (b)(1), and (e)(2) of RCRA and the Hazardous and Solid Waste Amendments (HSWA) requires that EPA determine whether to list wastes from the coke by-products industry as hazardous. A wide variety of materials fall within the scope of the term coke by-products, including coal tar, light oil, naphthalene, phenol, and coke oven gas. EPA has extensively studied the coke by-products industry and proposes, based on this evaluation and pursuant to the HSWA mandate, to list as hazardous the following seven wastes that are associated with the production, recovery, and refining of coke by-products:

K141 Process residues from the recovery of coal tar, including, but not limited to, tar collecting sump residues from the production of coke from coal or the recovery of coke by-products produced from coal. This listing does not include K087 (decanter tank tar sludge from coking operations).

K142 Tar storage tank residues from the production of coke from coal or from the recovery of coke by-products produced from coal.

K143 Process residues from the recovery of light oil, including, but not limited to, those generated in stills, decanters, and wash oil recovery units from the recovery of coke by-products produced from coal.

K144 Wastewater treatment sludges from light oil refining, including, but not limited to, intercepting or contamination sump sludges from the recovery of coke by-products produced from coal.

K145 Residues from naphthalene collection and recovery operations from the recovery of coke by-products produced from coal.

K147 Tar storage tank residues from coal tar refining.

K148 Residues from coal tar distillation, including, but not limited to, still bottoms.

The wastes covered in today's proposal (which are more fully described in Section II) include process residues and storage tank residues. The constituents of concern that are present in the proposed listed wastes are benzene and polynuclear aromatic hydrocarbons (PAHs), including benz(a)anthracene, benzo(a)pyrene, benzo(b and k)fluoranthene, dibenz(a,h)anthracene, indeno(1,2,3-cd)pyrene, and naphthalene. The proposed listings do not include residuals already listed as EPA Hazardous Waste Nos. K035, K060, and K087. Rather, these proposed listings, if finalized, would supplement the existing listings and increase the quantity of waste from coke by-products recovery processes and tar refining processes regulated under subtitle C of RCRA. As discussed below, the proposed listings do not include wastewaters from coke by-products recovery and tar refining.

The Agency has collected data showing that the wastes proposed today for listing typically contain significant concentrations of hazardous constituents that cause carcinogenic, mutagenic, teratogenic, and chronically toxic effects in laboratory animals. The hazardous constituents are demonstrated to be mobile and persistent in the environment and, thus, can reach environmental receptors in harmful concentrations when the wastes are mismanaged. The Agency has evaluated these wastes using the criteria for listing hazardous wastes, which are identified in 40 CFR 261.11(a). The Agency has determined that these wastes are hazardous because they contain toxic constituents that are capable of posing a substantial present or potential hazard to human health and the environment when improperly treated, stored, transported, disposed, or otherwise mismanaged.

The sources of the wastes proposed for listing as hazardous are described in section II below and in more detail in the background document (available from the public docket at EPA Headquarters—see "ADDRESSES" section—and from the EPA Regional Libraries). Certain sections of the background document, however, contain CBI material and are not available to the public. EPA will accept petitions submitted in accordance with 40 CFR part 2 for declassifying CBI material.

A number of wastes included in today's proposal are recycled by a substantial segment of the coke by-products industry. For managing proposed EPA Hazardous Waste Nos.

K141 through K145, K147, and K148, two recycling techniques are commonly used: (1) Combining the residue with coal feedstock prior to or just after charging the coal into the coke oven; and (2) mixing the residue with coal tar prior to its being sold as a product. In addition, these same recycling practices are typical for tar decanter tank sludge, already listed as EPA Hazardous Waste No. K087.

To address both of these recycling practices, EPA today is proposing, first, to exclude the wastes proposed for listing in today's proposal from the definition of solid waste at the point of their reinsertion with feedstock into coke ovens, and, second, to exclude from the definition of solid waste coal tar products that contain or are produced from these wastes. EPA is extending the promulgation (contained in the February 21, 1991 Boiler and Industrial Furnace rule) of an exclusion from the definition of solid waste for K087 when reinserted into coke ovens (see section II.E of today's proposal and 56 FR 7202-7203).

The current and proposed exclusions would not apply prior to the point of reinsertion of the wastes into the coke ovens or prior to the point at which they are mixed with coal tar. (See 56 FR 7203.) Therefore, management of the wastes from their point of generation through the point at which they are reinserted into the coke oven or mixed with coal tar, including interim storage, would be regulated under subtitle C of RCRA. The Agency believes that recycling of wastes from these facilities achieves its goals of waste minimization in a beneficial, environmentally responsible manner. Discussion of the details of the recycling exclusion may be found in section II.E of today's proposal and in a future separate rulemaking.

Generators should note that, under 40 CFR 261.6(a)(1), hazardous wastes that are recycled are subject to the requirements for generators, transporters, and storage facilities of paragraphs (b) and (c) of that section, except for materials listed in (a)(2) and (a)(3) of that section. Under 40 CFR 261.6(b), generators and transporters of recyclable materials are subject to the applicable requirements of parts 262 and 263, and notification requirements under section 3010 of RCRA, except for materials listed in § 261.6 (a)(2) and (a)(3).

Under 40 CFR 261.6(c)(1), owners or operators of facilities that store recyclable materials before they are recycled are regulated under all applicable provisions of subparts A through L of parts 264 and 265, and

under parts 124, 266, 268, and 270, and the notification requirements under section 3010 of RCRA, except for materials listed in § 261.6 (a)(2) and (a)(3). Under 40 CFR 261.6(c)(2), owners or operators of facilities that recycle recyclable materials without storing them before they are recycled are subject to the following requirements, except for materials listed in § 261.6 (a)(2) and (a)(3):

(i) Notification requirements under section 3010 of RCRA.

(ii) Section 265.71 and 265.72 (dealing with the use of a manifest system and manifest discrepancies).

Today's proposal does not list wastewaters from the production, recovery, and refining of coke by-products. The Agency expects that some of these wastewaters may be TC hazardous for benzene. The Agency does not have sufficient data showing that PAHs are typically present in these wastewaters at levels of regulatory concern. The Agency solicits comment and any information relevant to hazardous constituents found in these wastewaters. If such data are received and they demonstrate that several hazardous constituents are typically and frequently present in wastewaters at levels of regulatory concern, the Agency may reconsider whether to list these wastewaters as hazardous.

The Agency is also not proposing to list process wastewaters from the production of creosote (tar refining operations) as hazardous. Sludges generated from the treatment of these wastewaters are already regulated under subtitle C of RCRA since they are listed as hazardous wastes (EPA Hazardous Waste No. K035).

HSWA requires the Agency to promulgate standards restricting the land disposal of newly identified wastes within six months of promulgating new listings. While today's notice does not propose land disposal restrictions for these wastes, the Agency will propose such standards in the future. The Agency's information requirements as they relate to land disposal restrictions are outlined in section II.G of this proposal.

II. Summary of the Proposed Regulation

A. Overview of the Proposal

This notice proposes to add seven wastes from the production, recovery, and refining of coke by-products to the list of hazardous wastes from specific sources (40 CFR 261.32).

The seven wastes are:

K141 Process residues from the recovery of coal tar, including, but not limited to, tar collecting sump residues from the production of coke from coal or the recovery of coke by-products produced from coal. This listing does not include K087 (decant tank tar sludge from coking operations).

K142 Tar storage tank residues from the production of coke from coal or from the recovery of coke by-products produced from coal.

K143 Process residues from the recovery of light oil, including, but limited to, those generated in stills, decanters, and wash oil recovery units from the recovery of coke by-products produced from coal.

K144 Wastewater treatment sludges from light oil refining, including, but not limited to, intercepting or contamination sump sludges from the recovery of coke by-products produced from coal.

K145 Residues from naphthalene collection and recovery operations from the recovery of coke by-products produced from coal.

K147 Tar storage tank residues from coal tar refining.

K148 Residues from coal tar distillation, including, but not limited to, still bottoms.

EPA has found that these wastes typically contain toxic constituents, including some that may be carcinogenic, that when mismanaged may pose a substantial present or potential threat to human health and the environment. In addition, the Agency has compiled evidence to demonstrate that the toxic constituents are mobile and persistent in the environment and are capable of reaching receptors in harmful concentrations. The information that supports these findings is summarized in this preamble and is presented in detail in the background document and other supporting materials that are available in the RCRA Docket for this proposal (see "ADDRESSES" section).

Upon promulgation of these proposed listings, all wastes meeting the listing descriptions would become hazardous

wastes under RCRA. Wastes generated prior to promulgation, however, would not be subject to regulation as hazardous waste as long as they are not actively managed after the effective date of this rule.

B. Industry Description

The proposed regulations would list residuals from the production, recovery, and refining of coke by-products produced from coal as hazardous wastes. Coke oven gas, a coke by-product, is produced from coal along with the main product, coke. Coke by-products recovered from the coke oven gas include naphthalene, light oil, coal tar, and other marketable products. Light oil is processed further to recover benzene, toluene, and xylene. The processing of light oil to produce these products is not included in today's rule because these products are not necessarily by-products of the coke manufacturing process but may be produced by a variety of other processes. By-products and sludges generated by the light oil recovery process itself, however, are included for listing in today's proposal (K143 and K144). Coal tars usually are shipped to other facilities for coal tar refining. Because these operations usually are conducted at separate locations, the descriptions of coke production and coal tar refining industries are presented separately in this section.

In 1987, 21 domestic companies produced approximately 28 million metric tons (MT) of coke at 34 plants. The coke by-products industry is divided into two distinct segments—captive coke producers (23 plants) and merchant coke producers (11 plants). Table 1 provides the distribution of coke plants (captive and merchant) and tar refining plants by state. The 23 captive coke plants are operated by major iron and steel companies and produce blast furnace coke that is generally used on-site at integrated iron and steel plants to produce steel.

The 11 merchant coke plants generally produce coke for sale on the open market. These plants produce blast furnace coke for sale to iron and steel companies, and metallurgical coke for sale to iron and steel foundries and to other metallurgical and chemical industries.

TABLE 1.—DISTRIBUTION OF COKE PLANTS AND TAR REFINING PLANTS BY STATE

| State | Number of coke plants | | | Number of tar refining plants |
|---------------|-----------------------|----------|-------|-------------------------------|
| | Captive | Merchant | Total | |
| Alabama..... | 1 | 4 | 5 | 2 |
| Illinois..... | 3 | 0 | 3 | 2 |

TABLE 1.—DISTRIBUTION OF COKE PLANTS AND TAR REFINING PLANTS BY STATE—Continued

| State | Number of coke plants | | | Number of tar refining plants |
|---------------------|-----------------------|----------|-------|-------------------------------|
| | Captive | Merchant | Total | |
| Indiana | 4 | 2 | 6 | 0 |
| Kentucky | 1 | 0 | 1 | 0 |
| Maryland | 1 | 0 | 1 | 0 |
| Michigan | 1 | 1 | 2 | 1 |
| New York | 1 | 1 | 2 | 0 |
| Ohio | 4 | 2 | 6 | 1 |
| Pennsylvania | 5 | 1 | 6 | 0 |
| Tennessee | 0 | 0 | 0 | 1 |
| Texas | 0 | 0 | 0 | 2 |
| Utah | 1 | 0 | 1 | 1 |
| West Virginia | 1 | 0 | 1 | 1 |
| Total | 23 | 11 | 34 | 11 |

The major by-products from coke production are coke oven gas, coal tar, naphthalene, sodium phenolate, and light oils. The coke oven gas is processed to remove the coal tars, phenols (which are used to produce sodium phenolate), naphthalene, and light oils and then is used as a fuel for noncontact heating of the coke ovens or in other processes in the coke or steel plant. In 1985, about 1,200 million liters of coal tar, 3.7 million liters of sodium phenolate, 7,700 short tons of naphthalene, and 580 million liters of light oil were produced by coke plants.

Historically, coal tar refining was a part of the coke by-products recovery operation at coke-making facilities. However, most coke plants have eliminated or have sold their tar refining operations. The crude coal tar that is produced at most coke plants now is sold to independent tar refiners for the production of other coal tar by-products.

In 1987, four companies operated 11 tar refining operations (see Table 1). Because tar refining plants depend on coke plants for their raw material, they are generally located in the vicinity of coke-making facilities. The primary products produced from coal tar at these refining facilities are light oil, creosote oil (middle fraction), refined tar (heavy fraction), and tar pitch (bottom fraction).

The 1985 production of these products was approximately 45 million liters of light oil, 500 million liters of creosote oils, 550 million liters of refined tar (excluding tar used as road tar), and 470,000 metric tons (MT) of coal tar pitch.

C. Description of Wastes

1. Process and Waste Descriptions

a. Coke By-Products. While coke-making operations vary somewhat with respect to the products formed, oven size, and coking time, the general process is common to all plants. Coke by-products recovery operations, however, vary to a greater extent from plant to plant, and each plant is unique in terms of the coke by-products recovered and the specific steps used for recovery operations. The most common processes involve recovery of light oil and coal tar, as well as production of ammonia, naphthalene, and phenol. Further refining of light oil and coal tar also may occur at coke plants, but, generally, these products are sent to off-site refiners for further processing. The following description provides an overview of the coke production and coke by-products recovery processed. For completeness and continuity, background information on currently listed wastes also is presented.

However, EPA is not soliciting and will not respond to comments pertaining to those wastes currently listed (K087, K060, and K035).

For coke production, coking coals are selected mainly on the basis of quality and amount of coke they will produce. About 65-70% of the coal charged is converted to coke. Mature coals (>75% carbon) are comprised mainly of polynuclear carbon ring systems connected by a variety of functional groups. Volatile matter in the coal, arising from coal decomposition, is released as coke oven gas during the coking (carbonization) process. The coke oven gas, containing benzene and PAHs, is captured to recover coke by-products and finally used as a fuel. Coke produced in the coking process is used in the manufacture of steel.

Figure 1 is a general process flow diagram that shows the points where the proposed wastes typically are generated. This process flow diagram is presented for illustrative purposes only and should not be construed to show all the unit operations in the manufacture of coke by-products. Individual facilities may have processes that are different from those shown in Figure 1 and may generate the proposed wastes at different points in the process.

BILLING CODE 6560-60-M

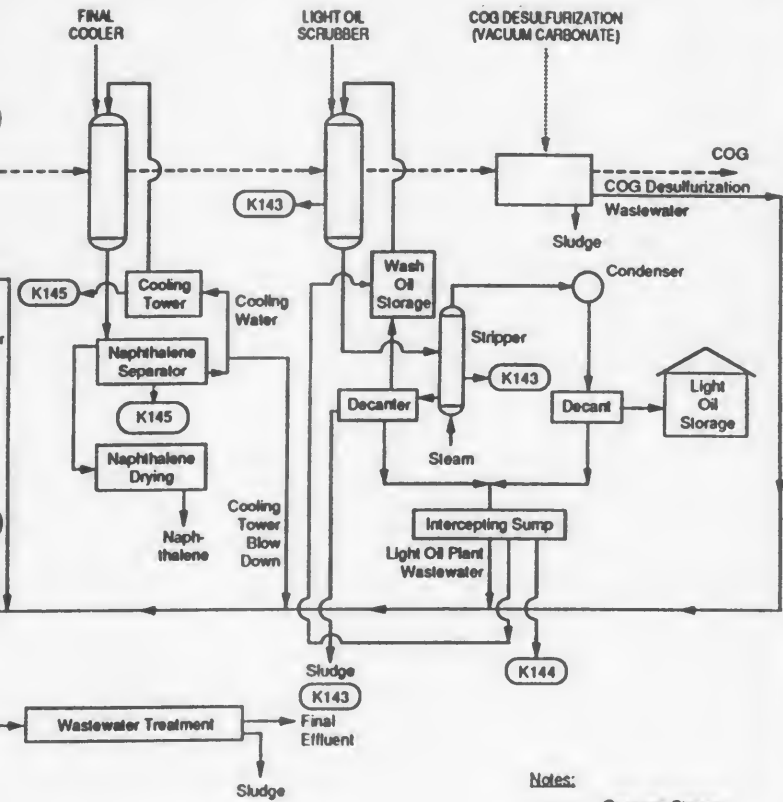

Notes:

- Gaseous Stream
- Solid or Liquid Stream
- COG - Coke Oven Gas

Figure 1
PRODUCTS RECOVERY

The following discussion describes the processes illustrated in Figure 1. Coal is charged to the coke oven and heated to temperatures between 700° and 900° C to produce coke and coke oven gas (COG). In coke ovens, the carefully blended coal charge is heated on two opposite sides so that heat travels toward the center and thus produces shorter and more solid pieces of coke. Air is excluded so that no burning takes place within the oven; the heat is supplied completely by the flues on the sides. The raw coke oven gas exits the oven at temperatures ranging from 760° to 870° C through the collecting main where it is sprayed with flushing liquor. The flushing liquor, composed primarily of water, tar, light oils, and heavy hydrocarbons, cools the coke oven gas to temperatures between 80° and 100° C. At these temperatures, the tar precipitates, and most of the nonvolatile organics condense from the gas. Coal tar, water, and ammonia are carried with the flushing liquor to the tar decanter tank (i.e., flushing liquor decanter tank). The uncondensed gas flows from the collecting main through crossover mains to the suction main, from which it enters the primary cooler. About 40 percent of the coke oven gas, after being stripped of its by-products, is returned and burned for the underfiring of a battery of ovens, and some is used on-site as fuel gas or for other purposes.

The uncondensed gas that leaves the collecting main enters the primary cooler where the gas temperature is reduced to approximately 40° C. The temperature reduction causes condensation of additional tar and liquor. Primary cooling is accomplished directly, by contacting the gas with cooling liquor in a baffled tower, or indirectly, by using countercurrent water flow in a heat exchanger. The condensate from the primary cooler flows into a tar collecting sump and is discharged into a tar decanter. The sludge that accumulates at the bottom of the collecting sump, tar collecting sump residue, must be removed periodically. The tar collecting sump residue is proposed to be listed as EPA Hazardous Waste No. K141. In most cases, this residue is recycled to the tar decanter.

The gas that exits the primary cooler is compressed in an exhauster and sent to an electrostatic precipitator (ESP), which removes entrained coal tar. The coal tar typically is routed to the tar collecting sump. In some facilities, tar from the primary cooler and ESP is discharged directly into the tar decanter tank, thereby eliminating the need for a tar collecting sump.

In the tar decanter tank, the material separates into three phases: the top layer is a dilute ammonia flushing liquor; the middle layer is coal tar; and the bottom layer contains heavy carbonaceous deposits that were entrained with the tar and liquor in the collecting main. Ammonia is a coke by-product and is removed with a dilute ammonia flushing liquor that is skimmed from the top layer in the tar decanter tank. A portion of this liquor is recycled to the collecting main. The flushing liquor system is a net generator of excess ammonia liquor that is sent to the excess ammonia liquor tank for storage. Phenols can be extracted from the excess ammonia liquor by direct contact with a countercurrent flow of light oil from the light oil recovery unit. The phenol containing light oil flows to the phenol column where the phenols are removed by reaction with caustic (sodium hydroxide or NaOH) to form sodium phenolate. The sodium phenolate and the separated light oil fraction are both sold as by-products.

Excess ammonia liquor leaving the phenol recovery unit is then sent to ammonia stills for ammonia recovery. The ammonia stills employ either caustic (NaOH) or lime (calcium hydroxide or Ca(OH)₂) to react with any fixed ammonium salt to render 'free' ammonia. Alternatively, lime can be added to the ammonia liquor before it enters the ammonia still in a vessel called a preliher. Ammonia still lime sludge is generated in the ammonia stills. This ammonia still lime sludge is currently listed as EPA Hazardous Waste No. K060. No sludge (K060) is generated if only NaOH is used in the process. The waste ammonia liquor resulting from the ammonia recovery ultimately is sent to a wastewater treatment system.

The tar is drained from the middle layer of the tar decanter tank and sent for tar dewatering and then for storage. Tar dewatering reduces the water content of the tar by gravity separation. The water from tar dewatering is sent to the wastewater treatment system. Dewatered tar is sent for storage. The Agency does not have any data indicating that sludges are generated from the tar dewatering step.

Over time, a tar residue, identified in today's proposal as proposed EPA Hazardous Waste Nos. K142 for coke by-products facilities and K147 for tar distillation facilities, accumulates at the bottom of the tar storage tanks. This tar residue must be removed periodically to maintain capacity of tar storage tanks. The accumulated carbonaceous deposits at the bottom of the tar decanter tank

currently are listed as EPA Hazardous Waste No. K087—Decanter Tank Tar Sludge. This residue is collected continuously by scrapers and is either recycled via ball mills to the coke ovens or treated and disposed.

Coke oven gas exiting the electrostatic precipitator (ESP) and the reheater, is sent for ammonia recovery. The recovery of ammonia from coke oven gas is practiced at most coke by-products plants. Ammonia may be recovered from the gas stream (i.e., coke oven gas) using either the direct or indirect recovery process. The direct process involves contacting the entire gas stream with a solution of sulfuric acid (H₂SO₄) in an absorber to produce ammonium sulfate crystals (after a series of drying and crystallization steps). The ammonium sulfate crystals are sold or disposed depending on market conditions. When indirect ammonia recovery is used, the gas is scrubbed with cooling water to absorb the ammonia, and the scrubbing liquor is distilled with steam in ammonia stills to yield ammonia vapor. This vapor is then reacted with sulfuric acid to produce ammonium sulfate crystals.

Coke oven gas exiting the ammonia absorber (saturator) is sent to the final cooler for naphthalene removal. Coke by-product plants use one of two distinct processes for final cooling. The most common method is direct contact final cooling (see Figure 1), which uses water as a cooling medium. The alternative cooling process uses countercurrent wash oil as a cooling/collection medium.

When water is used in the final cooler, naphthalene in the coke oven gas condenses and must be removed from the recirculating cooling water. The effluent stream from the final cooler is first sent to a sump called the naphthalene separator where the naphthalene is skimmed mechanically from the surface of the water. Naphthalene collection and recovery residue (proposed EPA Hazardous Waste No. K145) accumulates at the bottom of the naphthalene separator sump over a period of time. From the separator sump, the water is discharged to a hot sump, which acts as a collection or surge vessel for the cooling tower. From the hot sump, the water is routed at a constant flow rate through the cooling tower to a cold sump, which serves as a collection or surge tank for the cooled water before it reenters the final cooler. Naphthalene collection and recovery residues (proposed EPA Hazardous Waste No. K145) also accumulate in the hot and cold sumps, and on the surfaces of the cooling tower.

Naphthalene may also be separated from the final cooler water by sending the coke oven gas stream through a layer of tar at the bottom of the final cooler. The use of a tar-bottom final cooler allows the naphthalene to dissolve in the tar and to be included with the tar in any further refining operation. The same effect can be produced by sending the final cooler effluent stream to the tar collecting sump. The naphthalene dissolves in the tar, and the water separates out by gravity. This separated water can either be recycled to the cooling process or sent for wastewater treatment.

When the alternative wash oil cooling process is used, the material recovered from the final cooler contains naphthalene and some light oil. This stream is sent to a wash oil decanter (to remove condensed water) and then to a wash oil circulation tank. Some of the wash oil from the recirculation tank is recycled back to the final cooler through an indirect heat exchanger. The remainder is routed eventually to the light oil recovery plant (or benzol plant), which is described below, for removal of both the naphthalene and the light oil. Naphthalene collection and recovery residues (K145) are formed in the final cooler and the wash oil decanter.

After final cooling, the gas stream enters the light oil recovery stage in which the gas is scrubbed countercurrently with petroleum wash oil in a scrubber called the light oil scrubber (or benzol plant scrubber) to absorb the light oil. Material that builds up in this scrubber over time will be listed as light oil recovery residues (proposed EPA Hazardous Waste No. K143). From the scrubber, the "benzolized" wash oil is sent to the light oil stripping still or stripper to separate the wash oil from the light oil. Light oil recovery residue (proposed EPA Hazardous Waste No. K143) also includes material that accumulates in the still. Recovered light oil is then stored and subsequently sold. The wash oil is recycled to the light oil scrubber.

As the wash oil recycles through the light oil recovery process, a high-boiling-point resin is formed through polymerization reactions, which degrades the quality of the wash oil. A portion of the wash oil is removed continuously and is treated to separate this polymerized resin. The cleanup can be accomplished thermally in a wash oil purifier, gravitationally in wash oil decanters, or by using the difference in densities between the resin and the wash oil in a centrifuge (only gravitational separation in a decanter is shown in Figure 1). The polymerized

resin known as wash oil muck or muck oil (proposed EPA Hazardous Waste No. K143) accumulates over time and is removed periodically from the decanter. The cleaned wash oil is recycled to the light oil recovery cycle via the wash oil storage or recirculation tank. The material that accumulates in the storage or recirculation tank is also referred to as a light oil recovery residue (proposed EPA Hazardous Waste No. K143).

Most plants that practice light oil recovery have a sump that collects wastewaters generated in the light oil recovery area. Such wastewaters would include decanter water from the primary, intermediate, and secondary separators, as well as equipment and floor wash water. The primary purpose of the intercepting sump is to provide sufficient residence time for oil and water to separate. The separated light oil fraction is recovered by skimming and returned to the process. Sludge that accumulates in the bottom of the intercepting sump typically is removed on a periodic basis. These settled solids are residues that are defined as wastewater sump sludges from light oil recovery (proposed EPA Hazardous Waste No. K144). Wastewater from the intercepting sump usually is treated onsite prior to disposal or is used to extinction in the coke quench system.

The coke oven gas (COG) that exists from the light oil plant has a relatively high heating value. At captive plants, about 40 percent of the COG is used as fuel for the coke ovens, and the remainder is used as fuel in other steel plant operations. Merchant plants use about 40 percent of the COG as fuel for the coke ovens, and the remainder is sold as a fuel or flared. Historically, the gas from the light oil scrubber has been used as a fuel without further pretreatment. However, because the COG contains significant quantities of hydrogen sulfide (H_2S) (roughly 1 g of H_2S per 100 m^3 of COG) that are converted to sulfur dioxide (SO_2) and sulfur trioxide (SO_3) when the gas is burned, many plants now practice COG desulfurization to reduce SO_2 (SO_2 and SO_3) emissions. The three basic types of COG desulfurization processes are (a) liquid absorption processes, (b) wet oxidative processes, and (c) dry oxidative processes. Sulfur compounds recovered from these processes may be sold or disposed, depending on market conditions.

In the coke by-products recovery plant, wastewaters from the light oil recovery process, waste ammonia liquor, and final cooler blow-down constitute the majority of liquid wastes. Other minor sources of aqueous waste

are barometric condenser wastes from ammonia crystallizers, desulfurization wastes, and contaminated waters from air pollution emission scrubbers used at charging, pushing, preheating, or screening stations.

Based on the information available from RCRA 3007 questionnaires, 49 percent of the facilities discharge these wastewaters to a POTW, 25 percent of the facilities discharge these wastewaters to surface water, 21 percent reuse these wastewaters in their process (e.g., use as quench water), and the remaining four percent of the facilities dispose of these wastewaters in underground injection wells. According to the information available to the Agency, a significant number of facilities use biological treatment to treat these wastewaters before discharging them to a POTW or through their NPDES permitted outfall. However, some facilities do discharge their wastewaters to a POTW without any treatment onsite. Most of the facilities treat their wastewaters in tanks. However, six facilities use surface impoundments to manage their wastewaters.

Based on the limited information available to the Agency, four facilities have reported storing sludges resulting from wastewater treatment in surface impoundment, one facility has reported storing sludges from wastewater treatment in waste piles, three facilities have reported disposing of sludges from wastewater treatment in landfills, one facility has reported incinerating sludges from wastewater treatment.

b. Tar Refining. Coal tars typically are refined at facilities other than coke plants. Coal tar is refined by either batch or continuous distillation into a number of products, including pitch, creosote, naphthalene, and tar acids. The following paragraphs discuss the tar refining steps.

A batch still is a horizontal tank used to heat the crude coal tar. Vapors from the material being distilled leave the top of the still and pass through a water-cooled condenser. The pitch (at the bottom of the horizontal tank) is heated until it reaches its softening point. At that point, the pitch is discharged from the still, cooled, and poured into barrels for storage. In the batch distillation process, high-boiling-point residues accumulate on the fire tubes and at the bottom of the still and must be removed periodically. This residue is called tar distillation bottoms or residue (proposed EPA Hazardous Waste No. K148).

When coal tar is refined using continuous distillation, the crude material is first heated in a dehydration

column, then flashed to separate its components. The heavy liquid components such as pitch and creosote are sent to a distillation column for further refining. Vapors from the flash chambers and distillation columns are sent to a fractionating column. Finished commercial products include heavy naphtha, naphthalene, creosote, and anthracene oil. No still residues are generated from the continuous process.

Tar from either of these processes is stored in tanks and, over time, a tar residue may accumulate at the bottom of the storage tanks and, if it reaches a certain level, is removed periodically. This tar residue is identified in today's proposal as EPA Hazardous Waste No. K147 (for the refining facilities). Currently EPA does not have any data that indicate residues are generated from chemical or oil storage.

The Agency realizes that the tar refining industry generates products

from still bottoms, as opposed to relying purely on distillate products. The Agency seeks comment as to which bottoms are really products, by-products, or co-products and which are, in fact, wastes. The Agency is proposing to limiting the listings to materials that are wastes, not legitimate products. The Agency also seeks comments and suggestions as to the wording of the K147 and K148 listings, so that there is no confusion in the regulated community as to the scope of the listings, if promulgated.

2. Quantities of Waste Generated

Table 2 presents estimates of the quantities of waste generated from the production of coke and coke by-products, recovery of coke by-products, and coal tar refining. These estimates are based on data supplied to EPA by the industry in response to the questionnaires sent to each operating facility in 1985, and on supplemental

data collected from all tar refiners and approximately 50 percent of the coke plants in 1987. The industry questionnaires were issued under the authority of RCRA Section 3007. The estimates were calculated using a best-estimate, production-normalized waste generation rate for each residual stream. Plant-specific waste/residual estimates of waste quantities were made based on the process description or residual characterization supplied by the plant, and using plant-specific production rates for those plants that were known to generate the residual stream. The assumptions and data used to generate these estimates are provided in detail in the Background Document for this proposed listing and in confidential data memoranda referenced in the Background Document. EPA will accept petitions submitted in accordance with 40 CFR part 2 for declassifying CBI material.

TABLE 2.—ESTIMATED NATIONWIDE WASTE QUANTITIES (MT/YR)

| Waste | Quantity |
|--|----------|
| K141—Process residues from the recovery of coal tar, including, but not limited to, tar collecting sump residues from the production of coke from coal or the recovery of coke by-products produced from coal. This listing does not include K087 (decanter tank tar sludge from coking operations)..... | 3,100 |
| K142—Tar storage tank residues from the production of coke from coal or from the recovery of coke by-products produced from coal..... | 10,000 |
| K143—Process residues from the recovery of light oil, including, but not limited to, those generated in stills, decanters, and wash oil recovery units from the recovery of coke by-products produced from coal..... | 4,500 |
| K144—Wastewater treatment sludges from light oil refining, including, but not limited to, intercepting or contamination sump sludges from the recovery of coke by-products produced from coal..... | 900 |
| K145—Residues from naphthalene collection and recovery operations from the recovery of coke by-products produced from coal..... | 450 |
| K147—Tar storage tank residues from coal tar refining..... | > 2,800 |
| K148—Residues from coal tar distillation, including, but not limited to, still bottoms..... | 270 |

Source: Background Document (USEPA 1990).

3. Waste Management Practices

The principal sources of information on waste management practices are the responses to the 1985 EPA

questionnaires, the supplemental information collected in 1987, and information from States and other government agencies. Table 3 summarizes the information obtained on

management practices for the coke plant residual streams. Coal tar refining waste management practices are summarized in Table 4.

TABLE 3.—WASTE MANAGEMENT PRACTICES FOR COKE BY-PRODUCTS RECOVERY WASTES (PERCENT) ¹

| Waste management practice | K141 | K142 | K143 | K144 | K145 |
|--|---|---------------------------|------------------------------------|--|--|
| | Residues from tar recovery ² | Tar storage tank residues | Residues from light oil processing | Wastewater treatment sludges from light oil refining | Residues from naphthalene collection, recovery |
| Reuse, returned to process..... | ³ 100 | 31 | 53 | 43 | 100 |
| Removed by waste removal contractor..... | 0 | 8 | 13 | 29 | 0 |
| Burned in boiler/used as fuel..... | 0 | 31 | 19 | 14 | 0 |
| Landfill..... | 0 | 31 | 6 | 14 | 0 |
| Other..... | 0 | 0 | ² 6 | 0 | 0 |
| No. of facilities responding..... | 1 | 13 | 17 | 8 | 5 |
| Percent of total coke production by responding facilities..... | 5 | 44 | 27 | 27 | 16 |

¹ Percentages are based on number of facilities responding to RCRA 3007 questionnaire, which reported management practices, not number of facilities that generated waste. Totals may exceed 100 percent because many facilities reported more than one management practice.

² Only one plant reported management practices for tar collecting sump residues and that plant indicated that residues are recycled to the tar decanter. This number may not be representative of all facilities.

³ Sold or stored.

Source: RCRA 3007 questionnaires.

TABLE 4.—WASTE MANAGEMENT PRACTICES FOR TAR REFINING WASTES (PERCENT) ¹

| Waste management practice | K147 tar storage tank residual | K148 tar distillation residue |
|---|--------------------------------|-------------------------------|
| Reuse, return to process..... | 0 | 33 |
| Removed by waste removal contractor..... | 50 | 33 |
| Burned in boiler/used as fuel..... | 0 | 0 |
| Landfill..... | 50 | 33 |
| Thermal evaporation in tanks..... | 0 | 0 |
| Other..... | 0 | 0 |
| Number of facilities responding..... | 4 | 6 |
| Percent of total tar production by responding facilities..... | 50 | 55 |

¹ Percentages are based on number of facilities responding to the RCRA 3007 questionnaire, which reported management practices, not number of facilities that generated waste. Totals may exceed 100 percent because many facilities reported more than one waste management practice.

Source: RCRA 3007 Questionnaires.

The four primary waste management practices for coke plant residual streams are landfilling, removal by designated contractors for off-site disposal, combustion as a fuel, and reuse in the process. Further details on off-site waste management practices utilized by the contractors were not reported in the RCRA 3007 questionnaires, but presumably the wastes are either landfilled or used as a fuel because of their high heating value (>12,000 BTU/lb).

Several recycling options are available for reuse of residuals in the process. For example, for residues from tar recovery (proposed EPA Hazardous Waste No. K141), one option is to recycle the residue to the tar decanter. Tar storage tank residuals (proposed EPA Hazardous Waste No. K142) are generally recycled to the coke oven and

introduced with the coal as feedstock. Residues from naphthalene production (proposed EPA Hazardous Waste No. K145) can be returned to the coke oven or dissolved in the tar and processed as a component of the crude coal tar. The two light oil recovery residues (proposed EPA Hazardous Waste Nos. K143 and K144) can be dissolved in the tar, dissolved in the wash oil and recycled in the light oil recovery process, or recycled to the coke oven with the coal. Two facilities reported recycling tar distillation residue (proposed EPA Hazardous Waste No. K148). One plant recycled the residue with the tar. The other plant recycled the residue to a coke plant where it was returned to the coke oven with the coal feed.

D. Basis for Listing

1. Summary of Basis for Listing

Each of the seven wastes from coke, coke by-products, and tar refining meets the criteria for listing wastes as hazardous that is presented in 40 CFR 261.11(a)(3). Consequently, EPA is proposing that they be added to the list of hazardous wastes from specific sources appearing at 40 CFR 261.32. Hazardous constituents are typically present in these wastes at such levels that ground-water concentrations of these constituents are expected to exceed health-based levels of concern when the wastes are improperly managed. As discussed later, all the constituents of concern are carcinogens and/or systemic toxicants. All of the constituents of concern are listed as hazardous constituents in 40 CFR part 261, appendix VIII. Under plausible mismanagement scenarios, the Agency believes that these proposed hazardous wastes (proposed EPA Hazardous Waste Nos. K141 through K145, K147,

and K148) are capable of posing a substantial present or potential hazard to human health or the environment. By mismanagement scenario, the Agency means disposal in a sanitary or industrial (RCRA subtitle D) landfill, surface impoundment, open dumping, etc.

Table 5 presents the selected constituents of concern in each of the proposed wastes. Tables 6 and 7 present the range of measured concentrations of constituents in coke by-products and tar refining wastes. EPA selected the constituents of concern based on two principal factors: their known toxicity and their average concentrations in the waste. In the past, EPA's selection of constituents of concern for listed hazardous wastes has relied on comparisons of maximum reported waste constituent concentrations with health-based levels of concern. The Agency used the same selection procedure to identify the constituents of concern in the wastes being proposed for listing as hazardous. In this case, the Agency has found, as is shown and discussed later in Tables 8 through 8F, that the concentrations of constituents of concern in coke by-products wastes are so high that even projections of ground water contamination levels based on average waste concentrations (rather than maximum concentrations) exceed health-based levels of concern. Other constituents were detected in these wastes but were not selected as constituents of concern at this time because their levels of toxicity are not well established or because they typically are not present in concentrations of regulatory concern. Data on these constituents can be found in the Background Document for today's proposal.

TABLE 5.—CONSTITUENTS OF CONCERN

| Constituents | K141 | K142 | K143 | K144 | K145 | K147 | K148 |
|---------------------------------|------|------|------|------|------|------|------|
| Benzene..... | X | X | X | X | X | X | - |
| Benz(a)anthracene..... | X | X | X | X | X | X | X |
| Benzo(a)pyrene..... | X | X | X | X | X | X | X |
| Benzo(b and k)fluoranthene..... | X | X | X | X | - | X | X |
| Dibenz(a,h)anthracene..... | X | X | - | X | X | X | X |
| Indeno(1,2,3-cd)pyrene..... | X | X | - | - | - | X | X |
| Naphthalene..... | - | - | - | - | X | - | - |

Note.—X indicates that the constituent has been found to be present at levels of regulatory concern in the individual waste stream.

TABLE 6—Coke and Coke By-Product Wastes: Constituents of Concern and Range of Measured Concentrations (All Values in PPM)

| Constituent | K141—Process residues from coal tar recovery ^a | K142—Tar storage tank residues | | K143—Residues from light oil processing | | K144—Wastewater treatment sludges from light oil refining | | K145—Residues from naphthalene collection and recovery | |
|------------------------------------|---|--------------------------------|--------|---|-----------------|---|-----------------|--|------------------|
| | | Range | Avg. | Range | Avg. | Range | Avg. | Range | Avg. |
| Benzene | 3,850 | 230-290 | 260 | 39-8,500 | 1,600 | 200-14,000 | 3,000 | 120-3,000 | 1,000 |
| Benz(a)anthracene | 7,850 | 5,400-7,400 | 6,600 | ND-320 | ^b 69 | <15-140 | ^b 68 | <3-46 | ^b 22 |
| Benzo(a)pyrene | 6,450 | 4,500-8,300 | 6,500 | <10-130 | ^b 34 | <20-130 | ^b 65 | ND-22 | ^c 7 |
| Benzo(b)fluoranthene ^d | | | | | | | | | |
| Benzo(k)fluoranthene ^{ea} | 5,450 | 5,200-10,000 | 7,500 | <5-230 | ^b 59 | 15-220 | ^d 75 | ND-5 | ^b 26 |
| Dibenz(a,h)anthracene | 1,750 | 720-1,600 | 1,000 | ND-250 | ^b 38 | <7-31 | ^b 15 | ND-5 | ^b 1.3 |
| Indeno(1,2,3-cd)pyrene | 6,150 | 2,000-4,100 | 2,900 | ND-250 | ^b 40 | <15-77 | ^b 36 | ND-9.9 | ^b 4 |
| Naphthalene | 95,000 | 32,000-84,000 | 55,000 | 1,400-480,000 | 52,000 | 360-53,000 | 27,000 | 5.7-300,000 | 140,000 |

^a Only one data point exists. However, this residual is presumed to be comparable in composition to tar decanter sludge (listed waste K087).

^b Arithmetic averages are based on one half the quantitation limit for constituents detected below quantitation limits and zero for constituents not detected (ND).

^c Value represents one half the quantitation limit because the constituent was detected at trace levels.

^d GC peak resolution was not adequate to provide quantitation of the two isomers individually. The results shown are the sum of the two isomers.

TABLE 7.—TAR REFINING WASTES: CONSTITUENTS OF CONCERN AND RANGE OF MEASURED CONCENTRATIONS (ALL VALUES IN PPM)

| Constituent | K147—Tar storage tank residuals | | K148—Tar Distillation residuals | |
|-----------------------------------|---------------------------------|--------|---------------------------------|-----------------|
| | Range | Avg | Range | Avg |
| Benzene | 230-290 | 260 | NA ^a | NA ^a |
| Benz(a)anthracene | 5,400-7,400 | 6,600 | 160-10,000 | 4,500 |
| Benzo(a)pyrene | 4,500-8,300 | 6,500 | 330-7,300 | 3,600 |
| Benzo(b)fluoranthene ^b | | | | |
| Benzo(k)fluoranthene ^b | 5,200-10,000 | 7,500 | 150-13,000 | 6,100 |
| Dibenz(a,h)anthracene | 720-1,600 | 1,000 | 36-1,400 | 800 |
| Indeno(1,2,3-cd)pyrene | 2,000-4,100 | 2,900 | 110-3,300 | 1,700 |
| Naphthalene | 32,000-84,000 | 55,000 | 17-2,400 | 650 |

^a Constituent not analyzed (volatiles were not anticipated in still bottoms that have been heated to high temperatures).

^b GC peak resolution was not adequate to provide quantitation of the two isomers individually. The results are the sum of the isomers.

Source: Background Document.

The Agency lists a waste as hazardous if the waste poses a potential hazard to human health or the environment. In order to assess the potential hazard that a waste may pose, the Agency evaluates the potential human health and environmental risk if the waste is disposed of improperly. This risk is estimated as a function of the amount of exposure and the toxicity of hazardous constituents present in the waste stream of concern. In evaluating the risk posed by today's wastes, the Agency considered human exposure and exposure to environmental receptors from contaminated ground water. The amount of exposure to humans through ingestion of contaminated drinking water and environmental receptors via ground water is estimated from the expected concentrations of hazardous constituents in drinking water and the average amount of water consumed over the entire life span of an individual.

The expected drinking water concentrations of hazardous constituents from the wastes can be estimated as follows. First, the concentrations of these constituents

released to a leachate generated from the wastes are estimated. Then, the concentrations of these constituents in drinking water are estimated after transportation of the leachate to a drinking water well. Various alternatives, discussed below, were considered for estimating the exposure concentrations.

In order to estimate the concentration of the constituents of regulatory concern present in the proposed coke by-products wastes, EPA considered the use of leachability models and subsurface fate and transport models to estimate concentrations of these constituents in drinking water. Specifically, the Agency considered the use of the Organic Leachate Model (OLM) and the Toxicity Characteristic Leaching Procedure (TCLP) to estimate the leachate concentrations that are likely to result from the proposed wastes. This would be followed by the use of EPA's Composite Model for Landfills (EPACML) to estimate the migration of the hazardous constituents to the drinking water well. However, due to limitations in the applicability of

these models to the wastes being addressed in today's proposal, the Agency has determined that they may not be appropriate for these wastes. These limitations are discussed below.

a. Leaching Protocols. On November 27, 1985, the Agency proposed an organic leachate model (OLM) to estimate the amount of organic contaminants that will leach from a waste (see 51 FR 41082 and 50 FR 48886). The OLM is an empirical equation which was developed through application of modeling techniques to a data base of waste constituent concentrations and experimentally measured leachate concentrations. The OLM takes into account the concentrations of organic constituents of concern and their aqueous solubility.

However, OLM does not consider cosolvency effects and therefore, tends to underestimate pollutant mobility in waste matrices where cosolvency may be significant. EPA believes that, with the possible exception of tar distillation residues, wastes addressed in today's proposal may be subject to significant cosolvency effects.

EPA also analyzed samples of the wastes addressed in today's proposal for selected organic constituents, using the Toxicity Characteristic Leaching Procedure (TCLP) (see 55 FR 11798-11862 for details on the TC rule). Problems were encountered in applying the leaching procedure to these wastes. The principal problem with the samples of these wastes is associated with the variable amounts of tar (*i.e.*, percent solids). Tarry samples pose problems with sample homogenization, filtration, and dispersion of solids in the leaching medium when performing the TCLP. The tendency of tar to adhere to surfaces causes mass balance problems. Because of these difficulties, EPA believes that the TCLP procedure tends to provide analytical results which may underestimate the concentrations of hazardous constituents in leachates from these wastes if they are disposed of in a landfill environment. (The analytical results are provided in the Background Document for today's proposal.)

b. Groundwater Models. The modelling method referred to as EPACML has been used to estimate the attenuation and dilution of specific constituents during their migration through the unsaturated zone beneath a municipal landfill, and their transport through the saturated zone to a potential drinking water source (exposure point). EPACML accounts for dispersion in the longitudinal, lateral, and vertical directions; one-dimensional steady and uniform advective flow; sorption; and chemical degradation from hydrolysis.

EPACML accounts for the unsaturated zone transport modules and implements them using the Monte Carlo (probabilistic) framework.

The input concentration to the unsaturated zone transport module of EPACML corresponds to the leachate concentration at the bottom of the landfill. Under certain conditions, particularly very high constituent concentration, immiscible liquid flow can occur. For such situations, the model's inability to account for the immiscible flow condition may result in an underestimation of the receptor well concentrations. As discussed below, the wastes addressed in today's proposal typically have very high concentrations of certain hazardous constituents. Therefore, use of EPACML may result in an underestimate of concentrations of these constituents at drinking well sites.

For the reasons stated above, EPA believes that the use of available leaching and subsurface fate and transport models is not optimal for the wastes addressed in today's proposal. In addition, analytical results from the application of the TCLP to waste samples tend to understate the concentrations of hazardous constituents in leachates which may possibly originate from the wastes. However, in spite of the limitations of available methodologies for evaluating the potential health threats from these wastes, the Agency believes that the methodologies reveal high concentrations of hazardous constituents in these wastes. For that reason and because of the toxicity of

these constituents, the mobility of the hazardous constituents, and the persistence of the constituents in the environment, EPA believes that the wastes are hazardous.

After considering all of the factors of 40 CFR 261.11(a)(3), EPA concludes that these wastes are capable of posing a substantial present or potential hazard to human health or the environment when improperly treated, stored, transported, or disposed of. The concentrations and toxicities of hazardous constituents in the wastes are of such a magnitude that, even under conservative assumptions regarding the potential for release of these constituents to the environment and their subsequent transport in the subsurface environment, improper management of the wastes poses an unacceptable health risk. The following discussion illustrates this concern.

Tables 8 through 8F summarize the average concentrations of hazardous constituents in the wastes and the health-based concentrations of these constituents in drinking water at specified risk levels. For illustrative purposes, the tables also indicate the concentrations of these constituents when hypothetical environmental exposure factors (HEEFs), ranging from 100 to 10,000, are applied to the concentrations in the wastes. The purpose of this illustration is to indicate the concentrations of the constituents which result under a range of assumptions regarding the release of these constituents and their fate and transport in the environment.

TABLE 8.—BASIS FOR LISTING: HEALTH EFFECTS OF THE CONSTITUENTS OF CONCERN IN K141

| Hazardous constituent | Average waste concentration detected (ppm) | Health-based water concentration limits (ppm) | Basis ^a | Estimated drinking well concentration ^b (ppm) | | | Calculated concentration to health-based limit ratios ^c | | |
|--|--|---|-----------------------|--|-----------|-------------|--|-----------|-------------|
| | | | | HEEF 100 | HEEF 1000 | HEEF 10,000 | HEEF 100 | HEEF 1000 | HEEF 10,000 |
| Benzene..... | 3,850 | 5.0×10^{-3} | MCL (A) | 38.5 | 3.85 | 0.385 | 7,700 | 770 | 77 |
| Benz(a)anthracene..... | 7,850 | 1.1×10^{-5} | RSD (B ₂) | 78.5 | 7.85 | 0.785 | 7,100,000 | 710,000 | 71,000 |
| Benzo(a)pyrene..... | 8,450 | 3.0×10^{-6} | RSD (B ₂) | 84.5 | 8.45 | 0.845 | 28,000,000 | 2,800,000 | 280,000 |
| Benzo(b)fluoranthene Benzo(k)fluoranthene ^d | 5,450 | 4.0×10^{-5} | RSD (B ₂) | 54.5 | 5.45 | .0545 | 14,000 | 1,400 | 140 |
| Dibenz(a,h)anthracene..... | 1,750 | 7.1×10^{-7} | RSD (B ₂) | 17.5 | 1.75 | 0.175 | 25,000,000 | 2,500,000 | 250,000 |
| Indeno(1,2,3-cd)pyrene..... | 6,150 | 2.0×10^{-3} | RSD (C) | 61.5 | 6.15 | 0.615 | 3,100 | 310 | 31 |

^a Reference Dose (RfD), Risk-Specific Dose (RSD), and Maximum Contaminant Level (MCL) are explained later in the preamble, as are the classes of RSDs. Class A and B carcinogens are based on exposure limits at a 10^{-6} risk level. Class C carcinogens are based on exposure limits at a 10^{-5} risk level.

^b Calculated for three hypothetical environmental exposure factors (HEEFs).

^c Ratio obtained by dividing values in estimated drinking well concentration column by values in health-based, water concentration limit column for all three HEEFs.

^d GC peak resolution was not adequate to provide quantitation of the two isomers individually. The results show the sum of the two isomers.

Source: Background Document.

TABLE 8A.—BASIS FOR LISTING: HEALTH EFFECTS OF THE CONSTITUENTS OF CONCERN IN K142

| Hazardous constituent | Average waste concentration detected (ppm) | Health-based water concentration limits (ppm) | Basis ^a | Estimated drinking well concentration ^b (ppm) | | | Calculated concentration to health-based limit ratios ^c | | |
|--|--|---|-----------------------|--|-----------|-------------|--|-----------|-------------|
| | | | | HEEF 100 | HEEF 1000 | HEEF 10,000 | HEEF 100 | HEEF 1000 | HEEF 10,000 |
| Benzene | 260 | 5.0 × 10 ⁻³ | MCL (A) | 2.6 | 0.26 | 0.026 | 520 | 52 | 5 |
| Benz(a)anthracene | 6,600 | 1.1 × 10 ⁻³ | RSD (B ₂) | 66 | 6.6 | 0.66 | 66,000,000 | 600,000 | 60,000 |
| Benzo(a)pyrene | 6,500 | 3.0 × 10 ⁻³ | RDS (B ₂) | 65 | 6.5 | 0.65 | 22,000,000 | 2,200,000 | 220,000 |
| Benzo(b)fluoranthene Benzo(k)fluoranthene ^d | 7,500 | 4.0 × 10 ⁻³ | RSD (B ₂) | 75 | 7.5 | 0.75 | 19,000 | 1,900 | 190 |
| Dibenz(a,h)anthracene | 1,000 | 7.1 × 10 ⁻⁷ | RSD (B ₂) | 10 | 1.0 | 0.1 | 14,000,000 | 1,400,000 | 14,000 |
| Indeno(1,2,3-cd)pyrene | 2,900 | 2.0 × 10 ⁻³ | RSD (C) | 29 | 2.9 | 0.29 | 1,400 | 140 | 14 |

^a Reference Dose (RfD), Risk-Specific Dose (RSD), and Maximum Contaminant Level (MCL) are explained later in the preamble, as are the classes of RSDs. Class A and B carcinogens are based on exposure limits at a 10⁻⁶ risk level. Class C carcinogens are based on exposure limits at a 10⁻³ risk level.

^b Calculated for three hypothetical environmental exposure factors (HEEFs).

^c Ratio obtained by dividing values in estimated drinking well concentration column by values in health-based, water concentration limit column for all three HEEFs.

^d GC peak resolution was not adequate to provide quantitation of the two isomers individually. The results show the sum of the two isomers.

Source: Background Document.

TABLE 8B.—BASIS FOR LISTING: HEALTH EFFECTS OF THE CONSTITUENTS OF CONCERN IN K143

| Hazardous constituent | Average waste concentration detected (ppm) | Health-based water concentration limits (ppm) | Basis ^a | Estimated drinking well concentration ^b (ppm) | | | Calculated concentration to health-based limit ratios ^c | | |
|--|--|---|-----------------------|--|-----------|-------------|--|-----------|-------------|
| | | | | HEEF 100 | HEEF 1000 | HEEF 10,000 | HEEF 100 | HEEF 1000 | HEEF 10,000 |
| Benzene | 1,600 | 5.0 × 10 ⁻³ | MCL (A) | 16 | 1.6 | 0.16 | 3,200 | 320 | 32 |
| Benz(a)anthracene | 69 | 1.1 × 10 ⁻³ | RSD (B ₂) | 0.69 | 0.069 | 0.007 | 63,000 | 6,300 | 630 |
| Benzo(a)pyrene | 34 | 3.0 × 10 ⁻³ | RSD (B ₂) | 0.34 | 0.034 | 0.003 | 110,000 | 11,000 | 1,100 |
| Benzo(b)fluoranthene Benzo(k)fluoranthene ^d | 59 | 4.0 × 10 ⁻³ | RSD (B ₂) | 0.59 | 0.059 | 0.006 | 150 | 15 | 1.5 |

^a Reference Dose (RfD), Risk-Specific Dose (RSD), and Maximum Contaminant Level (MCL) are explained later in the preamble, as are the classes of RSDs. Class A and B carcinogens are based on exposure limits at a 10⁻⁶ risk level. Class C carcinogens are based on exposure limits at a 10⁻³ risk level.

^b Calculated for three hypothetical environmental exposure factors (HEEFs).

^c Ratio obtained by dividing values in estimated drinking well concentration column by values in health-based, water concentration limit column for all three HEEFs.

^d GC peak resolution was not adequate to provide quantitation of the two isomers individually. The results show the sum of the two isomers.

Source: Background Document.

TABLE 8C.—BASIS FOR LISTING: HEALTH EFFECTS OF THE CONSTITUENTS OF CONCERN IN K144

| Hazardous constituent | Average waste concentration detected (ppm) | Health-based water concentration limits (ppm) | Basis ^a | Estimated drinking well concentration ^b (ppm) | | | Calculated concentration to health-based limit ratios ^c | | |
|--|--|---|-----------------------|--|-----------|-------------|--|-----------|-------------|
| | | | | HEEF 100 | HEEF 1000 | HEEF 10,000 | HEEF 100 | HEEF 1000 | HEEF 10,000 |
| Benzene | 3,000 | 5.0 × 10 ⁻³ | MCL (A) | 30 | 3.0 | 0.30 | 6,000 | 600 | 60 |
| Benz(a)anthracene | 68 | 1.1 × 10 ⁻³ | RSD (B ₂) | 0.68 | 0.068 | 0.007 | 61,000 | 6,100 | 610 |
| Benzo(a)pyrene | 65 | 3.0 × 10 ⁻³ | RSD (B ₂) | 0.65 | 0.065 | 0.007 | 210,000 | 21,000 | 2,100 |
| Benzo(b)fluoranthene Benzo(k)fluoranthene ^d | 75 | 4.0 × 10 ⁻³ | RSD (B ₂) | 0.75 | 0.075 | 0.008 | 180 | 18 | 1.8 |
| Dibenz(a,h)anthracene | 15 | 7.1 × 10 ⁻⁷ | RSD (B ₂) | 0.15 | 0.015 | 0.002 | 210,000 | 21,000 | 2,100 |

^a Reference Dose (RfD), Risk-Specific Dose (RSD), and Maximum Contaminant Level (MCL) are explained later in the preamble, as are the classes of RSDs. Class A and B carcinogens are based on exposure limits at a 10⁻⁶ risk level. Class C carcinogens are based on exposure limits at a 10⁻³ risk level.

^b Calculated for three hypothetical environmental exposure factors (HEEFs).

^c Ratio obtained by dividing values in estimated drinking well concentration column by values in health-based, water concentration limit column for all three HEEFs.

^d GC peak resolution was not adequate to provide quantitation of the two isomers individually. The results show the sum of the two isomers.

Source: Background Document.

TABLE 8D.—BASIS FOR LISTING: HEALTH EFFECTS OF THE CONSTITUENTS OF CONCERN IN K145

| Hazardous constituent | Average waste concentration detected (ppm) | Health-based water concentration limits (ppm) | Basis ^a | Estimated drinking well concentration ^b (ppm) | | | Calculated concentration to health-based limit ratios ^c | | |
|-----------------------------|--|---|-----------------------|--|-----------|-------------|--|-----------|-------------|
| | | | | HEEF 100 | HEEF 1000 | HEEF 10,000 | HEEF 100 | HEEF 1000 | HEEF 10,000 |
| Benzene | 1,000 | 5.0 × 10 ⁻³ | MCL (A) | 10 | 1.0 | 0.10 | 2,200 | 220 | 22 |
| Benz(a)anthracene | 22 | 1.1 × 10 ⁻³ | RSD (B ₂) | 0.22 | 0.022 | 0.002 | 20,000 | 2,000 | 200 |
| Benzo(a)pyrene | 7 | 3.0 × 10 ⁻³ | RSD (B ₂) | 0.07 | 0.007 | 0.001 | 23,000 | 2,300 | 230 |
| Dibenz(a,h)anthracene | 15 | 7.1 × 10 ⁻⁷ | RSD (B ₂) | 0.15 | 0.015 | 0.002 | 210,000 | 21,000 | 2,100 |
| Naphthalene | 140,000 | 14 | RfD | 1,400 | 140 | 14 | 100 | 10 | 1 |

^a Reference Dose (RfD), Risk-Specific Dose (RSD), and Maximum Contaminant Level (MCL) are explained later in the preamble, as are the classes of RSDs. Class A and B carcinogens are based on exposure limits at 10⁻⁶ risk level. Class C carcinogens are based on exposure limits at a 10⁻⁵ risk level.
^b Calculated for three hypothetical environmental exposure factors (HEEFs).
^c Ratio obtained by dividing values in estimated drinking well concentration column by values in health-based, water concentration limit column for all three HEEFs.

Source: Background Document.

TABLE 8E.—BASIS FOR LISTING: HEALTH EFFECTS OF THE CONSTITUENTS OF CONCERN IN K145

| Hazardous constituent | Average waste concentration detected (ppm) | Health-based water concentration limits (ppm) | Basis ^a | Estimated drinking well concentration ^b (ppm) | | | Calculated concentration to health-based limit ratios ^c | | |
|--|--|---|-----------------------|--|-----------|-------------|--|-----------|-------------|
| | | | | HEEF 100 | HEEF 1000 | HEEF 10,000 | HEEF 100 | HEEF 1000 | HEEF 10,000 |
| Benzene | 260 | 5.0 × 10 ⁻³ | MCL (A) | 2.6 | 0.26 | 0.026 | 520 | 52 | 5 |
| Benz(a)anthracene | 6,660 | 1.1 × 10 ⁻⁶ | RSD (B ₂) | 66 | 6.6 | 0.66 | 66,000,000 | 600,000 | 60,000 |
| Benzo(a)pyrene | 6,500 | 3.0 × 10 ⁻⁶ | RSD (B ₂) | 65 | 6.5 | 0.65 | 22,000,000 | 2,200,000 | 220,000 |
| Benzo(b)fluoranthene Benzo(k)fluoranthene ^d | 7,500 | 4.0 × 10 ⁻³ | RSD (B ₂) | 75 | 7.5 | 0.75 | 19,000 | 1,900 | 190 |
| Dibenz(a,h)anthracene | 1,000 | 7.1 × 10 ⁻⁷ | RSD (B ₂) | 10 | 1.0 | 0.1 | 14,000,000 | 1,400,000 | 140,000 |
| Indeno(1,2,3-cd)pyrene | 2,900 | 2.0 × 10 ⁻³ | RSD (C) | 29 | 2.9 | 0.29 | 1,400 | 140 | 14 |

^a Reference Dose (RfD), Risk-Specific Dose (RSD), and Maximum Contaminant Level (MCL) are explained later in the preamble, as are the classes of RSDs. Class A and B carcinogens are based on exposure limits at 10⁻⁶ risk level. Class C carcinogens are based on exposure limits at a 10⁻⁵ risk level.
^b Calculated for three hypothetical environmental exposure factors (HEEFs).
^c Ratio obtained by dividing values in estimated drinking well concentration column by values in health-based, water concentration limit column for all three HEEFs.

^d GC peak resolution was not adequate to provide quantitation of the two isomers individually. The results show the sum of the two isomers.

Source: Background Document.

TABLE 8 F.—BASIS FOR LISTING: HEALTH EFFECTS OF THE CONSTITUENTS OF CONCERN IN K148

| Hazardous constituent | Average waste concentration detected (ppm) | Health-based water concentration limits (ppm) | Basis ^a | Estimated drinking well concentration ^b (ppm) | | | Calculated concentration to health-based limit ratios ^c | | |
|--|--|---|-----------------------|--|-----------|-------------|--|-----------|-------------|
| | | | | HEEF 100 | HEEF 1000 | HEEF 10,000 | HEEF 100 | HEEF 1000 | HEEF 10,000 |
| Benz(a)anthracene | 4,500 | 1.1 × 10 ⁻⁶ | RSD (B ₂) | 45 | 4.5 | 0.45 | 44,100,000 | 410,000 | 41,000 |
| Benzo(a)pyrene | 3,600 | 3.0 × 10 ⁻⁶ | RSD (B ₂) | 36 | 3.6 | 0.36 | 12,000,000 | 1,200,000 | 120,000 |
| Benzo(b)fluoranthene Benzo(k)fluoranthene ^d | 6,100 | 4.0 × 10 ⁻³ | RSD (B ₂) | 61 | 6.1 | 0.61 | 15,000 | 1,500 | 150 |
| Dibenz(a,h)anthracene | 800 | 7.1 × 10 ⁻⁷ | RSD (B ₂) | 8 | 0.8 | 0.08 | 11,000,000 | 1,100,000 | 110,000 |
| Indeno(1,2,3-cd)pyrene | 1,700 | 2.0 × 10 ⁻³ | RSD (C) | 17 | 1.7 | 0.17 | 860 | 86 | 8.6 |

^a Reference Dose (RfD), Risk-Specific Dose (RSD), and Maximum Contaminant Level (MCL) are explained later in the preamble, as are the classes of RSDs. Class A and B carcinogens are based on exposure limits at a 10⁻⁶ risk level. Class C carcinogens are based on exposure limits at a 10⁻⁵ risk level.
^b Calculated for three hypothetical environmental exposure factors (HEEFs).
^c Ratio obtained by dividing values in estimated drinking well concentration column by values in health-based, water concentration limit column for all three HEEFs.

^d GC peak resolution was not adequate to provide quantitation of two isomers individually. The results show the sum of the two isomers.

Source: Background Document.

The constituent levels, once the HEEF multipliers have been applied to them, are compared to their health-based numbers. Health-based numbers are based upon consideration of risk-specific doses for the constituent (see section II.D.3 of today's proposal). If the calculated level of the applicable constituent in a well is above the health-based number, the Agency considers the constituent to be one of concern and, therefore, a part of the basis for listing. The Agency also proposes to add these constituents to 40 CFR part 261 appendix VII for each of the proposed waste codes in today's proposal. The data in the tables illustrate that the wastes examined pose a potential threat to human health and the environment across an extremely broad range of assumptions regarding the mobility, fate, and transport of constituents in the wastes.

Tables 8 through 8F show that for each of the proposed wastes, the

concentrations of the constituents of concern in ground water would exceed the corresponding health-based levels of concern. The calculated ratios of estimated drinking water concentration values to health-based water-concentration-limit values presented in these tables also illustrate that even if only 0.01 percent of the average constituent levels in the wastes (*i.e.*, HEEF of 10,000) reaches environmental receptors, the exposure concentrations could exceed the health-based levels of concern by up of three orders of magnitude.

In addition to the high concentrations of hazardous constituents and the toxicity of the hazardous constituents in the wastes, the Agency also considered the mobility and persistence of the constituents in the environment. Information on the mobility and persistence of the constituents of concern are provided in sections II.D.3 and II.D.4, respectively. Information on

the toxicity of these constituents is provided in section II.D.5. Based on considerations of the concentrations of hazardous constituents in the wastes, on the toxicity of these constituents, on the mobility and persistence of these constituents in the environment, and on the other factors of 40 CFR 261.11(a)(3), EPA is proposing to list these wastes as hazardous.

2. Waste Characterization and Constituents of Concern

Tables 5, 6, and 7 list selected constituents of concern found in wastes from the production and recovery of coke by-products and tar refining, as well as the range and average concentrations for these constituents. The constituents of concern listed in the tables are carcinogens and/or systemic toxicants. All of the constituents of concern are already listed as hazardous constituents in 40 CFR part 261, appendix VIII. Waste composition data

were obtained from sampling and analysis of representative waste streams at various coke plants and tar refineries. All of the selected constituents of concern were found in concentrations of regulatory concern (*i.e.*, under plausible improper management scenarios, the constituent concentration likely to be present in ground waters are expected to be significantly higher than their health-based levels of concern for these constituents).

Other constituents that were detected in the proposed waste streams were not selected as constituents of concern for today's proposed listings because they were either not present in concentrations of regulatory concern or they do not have an established health-based number. The Agency may, however, add other constituents that were detected in today's proposed wastes to the list of constituents of concern for these wastes when the listing is promulgated based upon consideration of comments and/or additional data. Following is a list of

constituents known to be present in the proposed wastes that were not selected as constituents of concern: acenaphthene, acenaphthylene, anthracene, benzo(g,h,i) perylene, chrysene, 2,4-dimethyl phenol, 2,4-dinitrotoluene, ethyl benzene, fluoranthene, fluorene, 1-methyl naphthalene, 2-methyl naphthalene, 2-methyl phenol, 4-methyl phenol, phenanthrene, phenol, pyrene, styrene, and toluene. The Agency solicits comments on the list of constituents that have not been included as constituents of concern. The measured concentrations of these compounds in the proposed K141 through K145, K147 and K148 wastes, and available health data on their toxicity are presented in the Background Document for this proposed rule. The addition of any or all of these constituents as constituents of concern would not affect the Agency's decision regarding listing these wastes.

3. Mobility of Constituents of Concern

The exposure pathway of principal concern is leaching and migration to

ground water. The water solubility of a given hazardous constituent is one of the indicators of its mobility (*i.e.*, the likelihood that it will be released from a management site, will dissolve in water, and would reach a water resource of concern), and is considered by EPA among other factors in evaluating the potential of the constituent to migrate in the environment. Leaching is of concern because several of these compounds are soluble in water and could, therefore, leach from the wastes and potentially contaminate ground water. For example, the water solubility of benzene is significantly greater than its corresponding health-based level in drinking water. Thus, this constituent is capable of existing in water at significant concentrations. The solubilities and projected ground-water mobilities of the selected constituents of concern from the production, recovery, and refining of coke by-products wastes are presented in Table 9.

TABLE 9.—GROUND-WATER MOBILITY AND PERSISTENCE OF CONSTITUENTS OF CONCERN

| Constituents of concern | Health-based water concentration limits (ppm) | Water solubility (ppm) | LOG ^a K _{ow} | K _{oc} ^b | Mobility ^c | | Persistence ^d |
|--|---|-------------------------|----------------------------------|------------------------------|---|---|--------------------------|
| | | | | | Slightly ^e contaminated medium | Highly ^f contaminated medium | |
| Benzene..... | 5.0 x 10 ⁻³ | 1.780 x 10 ³ | 2.13 | 65 | moderate..... | moderate..... | low. |
| Benz(a)anthracene..... | 1.1 x 10 ⁻⁶ | 5.7 x 10 ⁻³ | 5.61 | 20,000 | low..... | high..... | high. |
| Benzo(a)pyrene..... | 3.0 x 10 ⁻⁶ | 3.8 x 10 ⁻³ | 6.06 | 550,000 | low..... | high..... | high. |
| Benzo(b)fluoranthene, ^f Benzo(k)fluoranthene ^f | 4.0 x 10 ⁻³ | 4.3 x 10 ⁻³ | 6.06 | 550,000 | low..... | high..... | high. |
| Dibenz(a,h)anthracene..... | 7.1 x 10 ⁻⁷ | 5 x 10 ⁻⁴ | 6.84 | 3,300,000 | low..... | high..... | high. |
| Indeno(1,2,3-cd)pyrene..... | 2.0 x 10 ⁻³ | 5 x 10 ⁻⁴ | 6.50 | 1,600,000 | low..... | high..... | high. |
| Naphthalene..... | 14 | 31.7 | 3.29 | 940 | low..... | high..... | high. |

Source: CHEMWISE Database.

^aK_{ow} = Octanol-water partition coefficient.

^bK_{oc} = Soil sorption coefficient.

^cQualitative relative evaluation of mobility and persistence, based on water solubility, log K_{ow}, and K_{oc}.

^dSlightly contaminated medium represents a mismanagement scenario where release of hazardous constituents does not result in saturation of the underlying soil by organic hazardous constituents.

^eHighly contaminated medium represents a mismanagement scenario where release of hazardous constituents results in saturation of the underlying soil by organic hazardous constituents.

^fGC peak resolution was not adequate to provide quantitation of the two isomers individually. The results are the sum of the two isomers.

Also, data available to the Agency indicate that toxic PAHs are present in ground water at concentrations that far exceed their water solubility. At one site, benzo(a)pyrene was measured in ground water at a concentration of 0.08 ppm, which is greater than its reported solubility. Although the exact reason for this phenomenon is not fully understood, it is believed that the presence of these constituents in ground water is due to the oily nature of these wastes and multiphase transport. This phenomenon is discussed in greater detail in the Background Document to today's proposal.

Another factor that can provide an indication of the mobility of each

constituent is its log octanol/water partition coefficient (log K_{ow}). The log K_{ow} value for benzene is 2.13. According to Briggs (1977), this value indicates that benzene is moderately mobile in soil.

The PAHs (*i.e.*, benzo(a) anthracene, benzo(a)pyrene, benzo(b)fluoranthene, benzo(k)fluoranthene, dibenz(a,h)anthracene, ideno(1,2,3-cd)pyrene, and naphthalene) have high log octanol/water partition coefficients and may be predicted to be relatively immobile in soil and sediment. However, available evidence indicates that these constituents may move more readily than would be predicted in soil with a low organic content or when codisposed with other solvents or oils,

or when the waste itself is of an oily nature. They can also be transported while suspended on particulate matter in air or water.

The exact transport mechanisms for the constituents of concern in proposed EPA Hazardous Waste Nos. K141 through K145, K147, and K148 are not fully understood. However, under the plausible types of improper management to which the wastes could be subjected, the constituent concentrations that reach ground waters could be significantly higher than corresponding health-based numbers. This is shown by concentrations of some PAHs found in ground water samples as a result of

solvent assisted transport. The Background Document for today's proposal provides information on PAH levels found in the ground water samples. This conclusion is consistent with the conclusions derived from application of HEEFs in the range of 100 to 10,000 for these wastes, as discussed in section II.D.1 of today's proposal.

4. Persistence of Constituents of Concern

The persistence of a constituent in the environment is an important criterion considered by the Agency when determining the potential of a waste to pose a threat to human health and the environment. The chemical and biological reactivity of the constituents of concern present in today's proposed wastes indicate that they are persistent and, thus, capable of posing a significant hazard to human health and the environment. All the constituents of concern in today's proposed wastes are sufficiently persistent to result in human exposure if they are released into ground water. The principal processes that limit the persistence of these constituents in ground water are hydrolysis and biodegradation.

None of the constituents are expected to hydrolyze in water between pH 2 and 12 at ambient temperature at a rate high enough to be a limiting factor in human exposure. This is because none of the constituents of concern have structural components that would be expected to react with water under those conditions. Benzene, for example, does not react with acidic (pH 2) or alkaline (pH 14) water. Therefore, it is unlikely that hydrolysis is a significant fate for benzene. The PAHs of concern do not contain groups amenable to hydrolysis. Hydrolysis is, therefore, not thought to be a significant fate process for PAHs (Radding *et al.*, 1976). PAHs are known to be persistent in the environment. PAHs have also been detected in drinking water, surface water, ground water, soils, sediments, and air. Persistence of benzene and PAHs in the environment has been confirmed by detection of these constituents in ground water, surface water, drinking water, soil, and air.

Biodegradation is another potential degradation mechanism for each of the organic constituents of concern. Under certain aerobic conditions, organic hazardous constituents are biodegradable, as shown in controlled laboratory experiments. Although benzene is expected to biodegrade in biologically active surface water systems, it is not expected to undergo biodegradation in ground water due to

the relatively low level of biological activity in ground-water systems.

Biological degradation processes are not known to occur at a rate sufficient to prevent the spread of PAHs in the environment. Three studies reported no appreciable degradation of benzo(a)pyrene in contaminated water and sediment (Herbes and Schwall, 1977; Muller and Korte, 1975; Herbes, 1981).

5. Health Effects of Concern

The Agency has obtained data demonstrating that the constituents found in the wastes generated by the production, recovery, and refining of coke by-products and tar refining are systemic toxicants and/or carcinogens. These toxic constituents are present in concentrations capable of causing adverse health effects as shown by Tables 8 through 8F. These tables illustrate that even if only 0.01 percent of the average constituent levels in the wastes reaches environmental receptors, the exposure concentrations are often three orders of magnitude higher than the health-based levels of concern. The health-based levels of concern are calculated using the three basic indicators of toxicity discussed in the following paragraphs. If the Agency assumes more conservative hypothetical environmental exposure factors (projecting less dilution prior to reaching environmental receptors) the exposure concentrations would be even higher.

For the purpose of listing wastes as hazardous under RCRA, the Agency often uses three basic indicators of toxic levels of concern: (1) Maximum Contaminant (MCLs); (2) Risk-Specific Doses (RSDs) for known carcinogens; and (3) Reference Doses (RfDs) for systemic toxicants.

MCLs are final Drinking Water Standards promulgated under Section 1412 of the Safe Drinking Water Act of 1974, as amended in 1986, for both carcinogenic and noncarcinogenic compounds. In setting MCLs, EPA considers a range of pertinent factors (for details, see 52 FR 25697-25701, July 8, 1987).

Where MCLs are not yet established, the Agency has developed oral RSDs for many carcinogenic constituents. The RSD is a dose that corresponds to a specified level of risk of an individual contracting cancer over a 70-year lifetime due to the presence of the toxicant in drinking water. In order to develop an RSD, a risk level must be specified. EPA specifies the risk level for a constituent of concern by using a weight-of-evidence scheme that is based on an assessment of the quality and adequacy of experimental data and the

kinds of responses induced by a suspect carcinogen. The carcinogenic constituents of concern in proposed EPA Hazardous Waste Nos. K141 through K145, K147, and K148 for which no MCLs exist are either probable human carcinogens (Class B₂)—based on a combination of sufficient evidence, in animals and inadequate human or no human data—or possible human carcinogens (Class C)—based on limited evidence in animals and the absence of human data. Details on the other classes of carcinogens are given in the Background Document. The oral RSDs for carcinogenic agents are calculated at the 10⁻⁶ risk level for Class B carcinogens and at the 10⁻⁵ risk level for Class C carcinogens. These risk levels are consistent with the risk levels used to delist specific waste streams.

In addition, oral Reference Dose numbers (RfDs) are established for non-carcinogenic constituents for which MCLs have not been developed. An RfD is an estimate of the daily exposure to a substance for the human population (including sensitive subgroups) that appears to be without an appreciable risk of deleterious effects during a lifetime of exposure. If frequent exposures that exceed the RfD occur, the probability that adverse effects may be observed increases. The method for estimating the RfD for non-carcinogenic end points was described in the proposed rule for the Toxicity Characteristic (51 FR 21648, June 13, 1986).

The hazardous constituents of concern found in the wastes proposed for listing today have produced carcinogenic or other chronic systemic effects in laboratory animals or humans. EPA has established RfDs, RSDs or MCLs for all of the constituents of concern in coke by-products and tar refining wastes. These constituents have been detected in the wastes from the production, recovery, and refining of coke by-products in concentrations sufficient to pose a substantial threat to human health and the environment. The health-based levels of concern calculated for the constituents of concern in Table 8 through 8F are based on two assumptions: (1) That the average person has a body mass of 70 kg and, (2) that a person drinks an average of 2 liters of test solution daily over a period of 70 years. The Agency's Carcinogen Assessment Group (CAG) has determined that there is substantial evidence to suggest that benz (a) anthracene, benzene, benzo (a) pyrene, benzo (b and k) fluoranthene, dibenz (a, h) anthracene, and indeno (1, 2, 3-cd) pyrene are carcinogens. Epidemiological

evidence from studies of coke oven workers and tar roofers demonstrates the carcinogenic potential of the materials generated by coke ovens and tar refining. A brief summary of the toxicity and health effects of these constituents is presented in this preamble. A more detailed discussion is included in the Background Document for today's proposal.

Benzene is a class A carcinogen. Benzene is carcinogenic in rats after exposure by gavage and in mice following exposure by inhalation (IARC, 1982). An epidemiological study that correlated benzene exposure with the incidence of leukemia provides sufficient evidence that benzene is carcinogenic in humans (NTP 85-002).

Benz(a)anthracene (BA) is a Class B² carcinogen. BA has been found to be carcinogenic in experimental mice following oral administration, dermal application, subcutaneous injection, and bladder implantation (IARC, 1973). Oral exposure to BA resulted in an increased incidence of hepatomas and pulmonary adenomas in the mouse (Klein, 1963).

Benzo(a)pyrene (BaP) is a Class B₂ carcinogen. BaP is perhaps one of the most potent animal carcinogens known. Microgram quantities have been shown to induce tumors in a number of experimental animal species via several routes of exposure, including oral, inhalation, and dermal application (IARC, 1973). The types of tumors seen after exposure to BaP include mammary tumors in rats (IARC, 1973); squamous cell papillomas and/or carcinomas of the forestomach in mice (Rigdon and Neal, 1966); and skin tumors in mice (Poel, 1963). BaP can also act as a transplacental carcinogen in mice (Bulay and Waterberg, 1971).

Benzo(b and k)fluoranthenes (BbF and BkF) are class B₂ carcinogens. BbF and BkF have both been shown to be dermal carcinogens in mice (IARC, 1973). BkF also induces tumor formation when injected subcutaneously in mice (Lacassagne *et al.*, 1963) and directly into the pulmonary tissue of rats (Deutsch-Wenzel *et al.*, 1983).

Dibenz(a, h)anthracene (DBA) is a Class B₂ carcinogen. DBA produced tumors in mice following oral, dermal, or subcutaneous administration (IARC, 1973). The types of tumors seen in mice after exposure to DBA by various routes include adenomas carcinomas of the skin (Wonder and Hoffman, 1959); pulmonary alveogenic carcinomas and adenomatosis; mixed-type mammary tumors; hemangioendotheliomas involving the pancreas and mesenteric and abdominal lymph nodes; and precancerous lesions of the small intestine (Snell and Stewart, 1962).

Indeno(1,2,3-cd)pyrene (IP) is a Class C carcinogen. IP is considered carcinogenic to experimental animals based on dermal application and subcutaneous injection studies on the mouse. Dose-related increases in the incidence of skin tumors have been observed in mice that received dermal applications of this chemical (IARC, 1973).

Several of the constituents of concern, including benzene (IARC, 1982), BaP (Shum *et al.*, 1979), DBA (Wolfe and Byran, 1939), and naphthalene (Harris *et al.*, 1979) have also been shown to be embryotoxic and/or teratogenic in experimental animals. Also, naphthalene has been shown to be embryotoxic in humans (Zinkham and Childs, 1958; Anziulewisc *et al.*, 1959).

In addition to their ability to act as carcinogens, several of these constituents (as well as other PAHs that express no carcinogenicity on their own) have been found to act as initiators or promoters (cocarcinogens) of skin tumors in mice. Chemicals found to initiate skin tumors after a single application or multiple applications followed by croton oil treatment (a classical promoter) include BA (Hadler *et al.*, 1959); BbF (Van Duuren *et al.*, 1966); BkF (LaVoie *et al.*, 1982); DBA (Klein, 1960); and IP (IARC, 1973).

It is important to note that PAHs other than the constituents of concern, are known to be present in the wastes proposed for listing in today's notice, and may have the ability to act as cocarcinogens. PAHs such as benzo(g,h,i)perylene (BghiP), fluoranthene, and pyrene are not carcinogenic *per se*. When applied to the skin of mice along with a carcinogen such as BaP, however, they can often enhance the carcinogenic effect of BaP (e.g., IARC, 1983; Van Duuren and Goldschmidt, 1976). This cocarcinogenic phenomenon is of concern because many of the waste streams proposed for listing in today's notice contain mixtures of PAHs that are carcinogens and cocarcinogens. This factor indicates that, for some PAH mixtures, the health-based levels of concern presented earlier (which are based on exposure to individual compounds) may underestimate the toxicity of these compounds when found in the wastes as mixtures of PAHs.

Almost all of the PAHs considered here possess some degree of mutagenicity in short-term tests for genotoxicity. Chemicals found to induce mutations in at least one strain of *Salmonella typhimurium* include BA (e.g., Claxton, 1983); BaP (e.g., McCann *et al.*, 1975); and IP (e.g., LaVoie *et al.*, 1979). Other evidence for genotoxicity

includes induction of sister chromatid exchanges by BA (Tong *et al.*, 1981a, 1981b) and by BaP, BbF, and DBA (Rozinski and Kocher *et al.*, 1979); and morphological transformation in a number of *in vitro* test systems by DBA and IP (Chen and Heidelberger, 1969 and Emura *et al.*, 1982).

6. Mismanagement Case Histories

A number of environmental damage incidents have occurred in the past due to the mismanagement of coke by-products and tar refining wastes. These incidents show that constituents present in these wastes are capable of reaching environmental receptors in potentially harmful concentrations. The cases describing environmental contamination with coke by-products and tar refining wastes can be found in the docket supporting the listing of EPA Hazardous Waste Nos. K141 through K145, K147, and K148.

As a basis for illustrating the environmental contamination associated with coke by-products, EPA has identified several incidents where the management of the coking wastes in question has resulted in environmental damage and increased risk to human health. To illustrate the hazards posed by these wastes when mismanaged, EPA has summarized the following studies:

Polynuclear Aromatic Hydrocarbon Sediment Investigations conducted in Region V, including five sites involved in coke production; and,

Six specific case studies conducted at plants that engage in various types of activities that involve coal tar and other coking by-products.

The case studies presented below illustrate the threat posed to human health and environment by these wastes. As discussed previously, these wastes may contain levels of benzene and PAHs including benzo(a)anthracene, benzo(a)pyrene, benzo(b and k)-fluoranthene, dibenzo(a,h)anthracene, indeno(1,2,3-cd)pyrene, and naphthalene. When improperly treated, stored, transported, or disposed, the PAHs and benzene in these wastes have been shown to migrate into the environment. In such case, these wastes pose a threat to human health and the environment.

In previous discussions (sections II.D.1.a and II.D.1.b of this proposal), EPA focused upon quantifying the levels of constituents (benzene and select PAHs) that would pose a hazard to the environment when mismanaged. In summarizing these case studies, EPA provides actual examples where the mismanagement of the coking wastes of concern has resulted in environmental

damage. Specifically, the Agency supplies examples where the concentrations of benzene or select PAHs in ground water exceeds acceptable health levels.

a. PAH Sediment Investigation. Results of sediment studies conducted downstream of the coke operation discharges on the Black River in Ohio indicate that high levels of PAHs are present and that these contaminants adversely affect fisheries located on the river. For example, it is documented (Baumann and Fabacher, 1985) that elevated levels of PAHs are responsible for the occurrence of tumors on fish from the Black River. Due to these results and because of the large number of coke plants in EPA Region V, the Region decided to undertake a series of surveys to determine the extent of sediment contamination by PAHs in the Region. The case studies include six sites in Illinois, Indiana, Ohio, and Michigan that are or were engaged in the production of coke and steel. As a result of operations at these plants, the surrounding rivers, including the Calumet, the Cuyahoga, the Mahoning, the Ohio and the Rouge Rivers, have been contaminated by PAHs through the discharge of treatment wastewaters bearing coking processing wastes.

The wastewaters from the sites resulted from such processes as coke quenches, ammonia liquor distillation, and processing of coal tars. These wastewaters varied in the degree of both contamination and treatment that they underwent before discharge and contained some or all of the wastes that are considered under this listing. The exact percentage of coke wastes discharged with the wastewaters, however, has not been quantified.

At each facility, river sediments were collected above and below each wastewater discharge, as well as the area immediately surrounding the discharge. At each site, these samples confirmed that high levels of PAH contamination had occurred below and near the site being studied. The levels of contamination varied directly with the distance away from the outfall from the plant, both upstream and downstream with downstream concentrations markedly higher than those upstream. The PAHs were found to have contaminated the rivers at the various sample sites at levels up to and including the following concentrations: naphthalene—38,000 ppm, benzo(a)anthracene—7,600 ppm, benzo(b)fluoranthene—8,000 ppm, indeno(1,2,3-cd)pyrene—6,000 ppm, and dibenz(a,h)anthracene—1,100 ppm. These levels of contamination were

found to be significantly higher than the levels that are acceptable by health-based standards.

The sampling measurements, however, reflect concentrations in sediments while the health-based standards refer to maximum allowable concentrations in water. While this difference may limit the comparability of the two measurements, the studies still indicate a hazard since the water and sediment at the sites are in direct contact. Further, since the PAHs occur in the sediments in high concentrations, the constituents may migrate to the surface and drinking waters and present an even greater hazard to human health and the environment.

b. Specific Site Evaluations. Summaries of selected cases describing environmental contamination by constituents of concern present in coke by-products and tar refining wastes are described below. These sites include a manufacturing plant (which conducted coking operations), a coal tar by-products manufacturing plant, a coal gasification plant, a tar refiner, a wood preserving and coal tar distillation facility, and a disposal site for wastes from three sources. Each of these sites described below involved ground water contamination by PAHs and benzene.

Site 1

A steel manufacturing plant operating in New York from 1920 through 1983 on Lake Erie was the site of contamination caused by several different wastes, including coking wastes. Various coking wastes were mixed with other wastes at most of the sites involved, although two disposal areas received coking wastes almost exclusively.

At this facility, excess blast furnace and steelmaking slags, as well as steel scrap and coking wastes were initially dumped directly into Lake Erie and then into pits and landfills located on a man-made peninsula created at the point where a creek discharges into Lake Erie. The slag fill extended approximately 1,700 feet off the shoreline of the lake and raised the subsurface elevation more than 50 feet. Of 160 pits/landfills located on the peninsula, two waste management areas, a pit and a landfill, have been identified as areas that were designated to receive coking wastes. Ground-water monitoring wells were installed in the areas to assess the migration of contaminants from these hazardous waste management areas to ground water. Coking wastes that were co-disposed in the pit and landfill include K060, K087, and the proposed K141-K145 wastes. As a result of this co-disposal, constituents in the coking wastes have migrated from the fill

materials to the ground water and possibly to the lake.

The concentrations of naphthalene and benzene (up to 720 ppm and 340 ppm respectively) from these two sites were found to be well above the accepted health-based levels for these constituents. Although the source of these constituents may include non-coking process wastes, the coking process wastes have contributed significantly to the problem. Coking waste is the main contributor to the PAH problem, although non-coking process wastes may also affect the level of PAHs and benzene present in the samples. The ground-water monitoring results indicate that the levels of PAHs and benzene in this case are significant and that they pose a threat to human health and the environment.

Site 2

A manufacturer of coal tar by-products along the east bank of the Ohio River in West Virginia was involved in ground-water monitoring to examine the level of contamination resulting from plant activities. These activities included using crude coal tar as feedstock to produce three major products: refined chemical oil, creosote, and industrial pitch. Monitoring results showed that activities both at this plant and at a nearby coke facility led to ground water contamination by coal tar residuals (proposed K147 and K148). The studies examined the shallow, perched aquifer and the alluvial aquifer. These investigations revealed varying extent of contamination in all aquifers. This contamination was due to uncontrolled seepage and discharge of pollutants into the Ohio River. The following constituents were found to have contaminated the aquifers at levels up to and including the following concentrations: naphthalene—92,000 ppm, benzo(a)anthracene—4,000 ppm, benzo(b)fluoranthene—4,100 ppm, indeno(1,2,3-cd)pyrene—1,200 ppm, and dibenz(a,h)anthracene—21 ppm. These concentrations are well above the accepted health-based levels for these constituents.

Site 3

A coal gasification plant was the site of soil and groundwater contamination. Tar and soil contaminated with tar were widely distributed over the site as a result of plant operations. Materials found at coal gasification sites are similar in nature to those found at coke by-products facilities. The site is listed in the National Priorities List (NPL) of hazardous waste sites.

The coal gasification site is known to have coal tar and other coal gasification wastes present in three locations: a tar pit, two ponds, and in an area of tar boils (tar refining). The total estimated volume of tar in these areas is 5000 yd³. The deepest penetration of tar was observed at a location adjacent to the ponds where a slight tar odor was also detected at a depth of 50 feet.

Three shallow, water-bearing strata (aquifers) exist at a depth of less than 60 feet under the site. In some locations at the site these three aquifers are separated by fine clay materials, while in other locations one aquifer is in direct contact with a deeper aquifer, allowing waters from the two aquifers to mix. There is evidence of contamination in the two shallower aquifers.

Concentrations of benzene, phenols, and PAHs ranging from 5 to 30 µg/L were detected in the shallowest aquifer water, while PAH concentrations up to 14,000 µg/L were detected in wells tapping the middle aquifer. Surface water quality was determined on several occasions at five locations. Analytical data indicate that a variety of organic compounds are present in surface waters, including some of the constituents of concern in today's proposal

Site 4

A former sand and gravel pit was the disposal site of wastes from three sources from 1945 to 1977. Wastes from a tar refining plant, foundry sand from an iron foundry, and wastes from a gravel company were disposed at this site. The site was assigned to the NPL in September 1983 due to the extent of its soil and ground-water contamination.

Both soil and ground water in areas around the pit showed evidence of contamination. Soil boring and ground-water samples confirmed that the ground water below and near the site was contaminated with organics. This contamination reaches the Ohio River with a north plume extending to the iron company's production wells, in which benzene has been measured from nondetectable levels to 36 ppb (parts per billion).

Evidence of ground-water contamination below the pit includes trace levels of anthracene and phenanthrene detected in nine out of ten wells drilled through the north end of the pit at varying depths (detection limits for these compounds ranged from 10 µg/L to 16,000 µg/L). Benz(a)anthracene was also detected at trace levels in four of these wells. The highest ground-water concentration of benzene was at 18,000 µg/L.

In addition, analysis of soil borings indicated that a 10 to 15 foot layer on

top of the bedrock underlying the pit appears to be contaminated with organics (the bedrock begins at a depth of 80 ft). The intermediate zone between the bottom of the pit and the lower contaminated zone appears to be only slightly contaminated. This phenomenon suggests that nonaqueous phase substance contaminants have moved through the sand and gravel aquifer to the underlying impermeable layer.

Site 5

At another site, a tar refiner functioned from 1917 to 1972. As a result of PAH contamination of four area aquifers, this site is now included on the NPL. According to the Record of Decision (ROD) report, contamination of one of the deeper aquifers is believed to be the result of injection of creosote and process waste products directly into the facility's deep well located on-site. The well permeates the deep aquifers. Another method of migration of contaminants into this aquifer, called the Prairie du Chien-Jordan Aquifer, is believed to be from overflow into the well casing during on-site runoff events and spills.

Primary methods of contamination of the uppermost aquifers, the Drift and Platteville aquifers, are believed to be through contaminated soil at the site and at the bog south of the site. Contamination is not evenly distributed throughout the bog but appears to be more representative of a channel through the bog. According to the ROD data, the migration of contaminants from the ditches used to dispose of wastes has caused contamination of the aquifers. The Minnesota Department of Health (MDH) believes that the St. Peter Aquifer, which is located to the east of the site probably is contaminated due to ground-water migration from the Drift and Platteville aquifers. Further sampling of wells near the site is expected to confirm this assumption.

Site 6

An NPL site was used as a wood preserving and coal tar distillation facility from 1910 to 1962. Stormwater runoff flows to two stormwater drainage ditches which flow into an aquatic habitat. Sampling of the site indicated that there were two discrete areas of contamination: (1) the southern portion of the site, which was where the coal tar refining and wood treating operations were located, and (2) the northern portion of the site where an inactive disposal pond was situated. The average attenuation depth of organic compounds in the soils in the southern site area is about 58 feet. The primary contaminants of concern affecting the ground water,

soils, and sediments are volatile organic compounds (VOCs) including benzene, toluene, and xylenes; other organics, including PAHs; and metals.

Soil staining was observed at 15 of 139 auger boring locations and at 29 of 82 soil boring locations. Total surficial soil PAH concentrations in the four surface/surficial soil samples which were analyzed ranged from below detection limits to 8,567 mg/kg. Benzo(a)pyrene was measured at a concentration as high as 210 mg/kg, benz(a)anthracene was measured as high as 340 mg/kg, and the concentration for combined benzo(b and k) fluoranthene was measured as high as 290 mg/kg.

The primary compounds found in the shallow aquifer below the site were PAHs, VOCs, and metals. The maximum concentrations of total PAHs were measured at 22,000 mg/L. Benzo(a)pyrene was measured at a maximum concentration of 570 µg/L, and benzo(b and k) fluoranthene was measured at a maximum concentration of 1,200 µg/L. The ROD data indicate that the same contaminants were present in an adjacent deeper aquifer, but at lower concentrations.

A total of eighteen surface water samples and five sediment samples were collected from on-site drainage ditches bordering the site. Surface water data did not show any site-specific contamination. In the sediment samples, PAH compounds were detected in concentrations ranging from 2.3 mg/kg to 240 mg/kg. Benzo(a)pyrene was measured at a concentration of 30 mg/kg. Benz(a)anthracene was measured at 5.6 mg/kg, and benzo(b and k) fluoranthene was measured at 59 mg/kg.

7. Conclusions

The criteria in 40 CFR 261.11(a)(3) specify that the Agency will list a waste as hazardous if it contains constituents listed in Appendix VIII and, after considering the factors enumerated in 40 CFR 261.11(a)(3), the Agency concludes that the waste is capable of posing a substantial present or potential hazard to human health or the environment when improperly managed. After considering these factors, particularly the toxicity, mobility, persistence, and the concentration of hazardous constituents in these wastes, the Agency concludes that these wastes meet the criteria for listing. The Agency, therefore, is proposing to add the wastes described in this notice to the list of hazardous wastes in 40 CFR 261.32.

E. Recycling

A number of residuals proposed to be listed as hazardous wastes are recycled by a substantial segment of the coke by-products industry (see Tables 3 and 4 for waste management practices for the residuals proposed for listing). Two recycling techniques are currently in use: (1) Using mixtures of the residuals and coal to charge coke ovens and (2) mixing the residuals with coal tar prior to its being sold or refined. These recycling practices are also commonly used for tar decanter sludge, which is already listed as a hazardous waste (EPA Hazardous Waste No. K087) from the coke by-products industry. Coke and coal tar containing tar decanter sludge, K087, are currently exempt from regulation as hazardous wastes under 40 CFR 261.4(a)(10); however, the sludge is still considered a solid waste if not recycled. In the November 29, 1985 final rule (50 FR 49170) and the February 21, 1991 final rule (56 FR 7203), EPA concluded that the hazardous constituents are not present in coke derived from K087 at levels that would pose substantial risk to human health and the environment and that the recycling of K087 into coke by-products does not increase levels of hazardous constituents in coal tar.

EPA has studied and analyzed these practices for each of the proposed listed residuals to determine (a) whether these practices constitute waste management and should, therefore, be regulated as such or (b) whether the proposed residuals are being used in ongoing, continuous manufacturing processes and should, therefore, not be regulated under RCRA. Based on this analysis, the Agency has determined that while the proposed residuals would be solid wastes under 40 CFR 261.2, the Agency has determined it is appropriate to exclude proposed EPA Hazardous Waste Nos. K141 through K145, K147, and K148 from the definition of solid waste when these wastes are reinserted into coke ovens and when blended with coal tar product that is sold. As explained fully below, EPA believes that regulation of the material when reinserted is not necessary to protect human health and the environment, and will further the objectives of waste minimization and pollution prevention.

The effect of these exclusions would be that the coke oven, using mixtures of these residuals as feedstock, and the materials derived from them in the coking process, would not be regulated under Subtitle C of RCRA. Also, the tar refining process, using mixtures of these residuals and coal tar as feedstock would not be subject to regulation under

Subtitle C of RCRA. EPA's rationale for providing these exclusions from the definition of solid waste is presented in section 2.

The proposed exclusions would not apply prior to the reinsertion of the wastes into coke ovens or mixtures with coal tar for use as product. Management of these wastes up to that point may present a hazard to human health and the environment and would, therefore, be regulated under RCRA subtitle C. These waste management practices include removal and transportation, interim storage, or processing of the residuals at any time from their point of generation to the point of reinsertion into coke ovens or mixing with coal tar. In addition, residuals which are not reinserted into coke ovens or otherwise excluded from RCRA regulations would be subject to RCRA Subtitle C regulations. Section 2 provides a description of management practices for the wastes proposed for listing as hazardous from the point of generation to the point of reinsertion into coke ovens or mixing with coal tar.

The recycling of wastes from this industry is affected by the combined promulgation of two major rules. One of them, the Toxicity Characteristic, was promulgated on March 29, 1990. The other, the Boiler and Industrial Furnace rule, was promulgated on February 21, 1991. Because these rules were promulgated before this listing (with its attached exclusions) could become effective, the Agency is proposing a set of exclusions (§ 261.4(a)(10), (11), and (12)) for wastes from the coke by-products industry that are recycled. These exclusions will be discussed in section 6.

1. Classifications as a Solid Waste

The definition of solid waste (40 CFR 261.2) states that certain secondary materials, when used as or to produce a fuel, are solid waste (see 40 CFR 261.2(c)(2)(i)(B)). The regulations also state that materials which are reused as ingredients in an industrial process or as substitutes for commercial products are *not* solid wastes; however, those used in production of a "fuel" are considered to be solid wastes (see § 261.2(e)(2)(ii)). Waste-derived coke and coal tar are considered by-products for regulatory purposes and are sometimes burned, albeit not exclusively, or necessarily, for energy recovery. Since some energy recovery ultimately occurs, they are considered solid wastes under the current classification scheme.

2. Rationale for Exclusions from the Definition of Solid Waste for Coke By-Products Residuals Recycled to the Coke Oven or when Mixed with Coal Tar

The residuals being proposed for listing as hazardous when recycled into the coke ovens act as feedstock to the process, providing a source of carbon that is needed for the manufacture of coke. Although the iron and steel industry generally uses only small volumes of residuals with respect to the amount of coal used, the Agency believes that the practice of reinserting these residuals into coke ovens serves to replace the raw material (*i.e.*, coal). Similarly, the practice of mixing the proposed residuals with coal tar prior to its sale or refining constitutes replacing a product (*i.e.*, coal tar). The Agency has concluded that the quality of coke (*i.e.*, levels of hazardous constituents) produced is unaffected by the use of mixtures of the residuals and coal as a feedstock as typically practiced by the industry. Similarly, EPA believes that the quality of coal tar is unaffected by mixing certain wastes with coal tar prior to its sale or refining as typically practiced by the industry (see 50 FR 49170, November 29, 1985 and 56 FR 7203, February 21, 1991.) For these reasons, the Agency believes that reinsertion of these residuals into coke ovens and mixing of these residuals with coal tar to be sold as a product are recycling practices that do not increase the levels of hazardous constituents in the final coke by-product, and therefore do not pose any significantly increased risk to human health and the environment.

EPA has evaluated whether concentrations of toxic constituents in the residuals were likely to have a significant effect on the products of the recycling processes as compared with the products derived solely from raw materials (*i.e.*, coal that is feedstock for coke ovens and coal tar that is feedstock for tar refining). This evaluation was performed by using the results and supporting data considered in developing the Agency's exclusion of coke and coal tar produced from or containing recycled tar decanter sludge (EPA Hazardous Waste No. K087) from the definition of solid waste. This exclusion was based on the Agency's findings that: (1) The recycle of tar decanter sludge by application to the coal charge does not appear to have a significant effect on the chemical make-up of coke, (2) the organic chemical make-up of the sludge does not appear to be significantly different from the coal tar, and (3) although the

concentration of one metal, lead, appears to be slightly higher in the sludge than in the coal tar, the increase does not appear to be statistically significant. EPA, therefore, has determined that recycling of EPA Hazardous Waste No. K087 does not significantly affect the concentrations of toxic metals and organic constituents in coal tar or coke. Based on this determination and on the fact that coke, coal tar, and sludge arise from a single process, are similar materials, and contain the same contaminants, EPA had excluded coke and coal tar containing or produced from K087 (see 56 FR 7202—7203, February 21, 1991).

Since EPA does not have analytical data for coke or coal tar produced from feed containing the wastes being proposed for listing, the Agency's approach for evaluating these wastes was to compare the concentrations of the hazardous organic constituents in these wastes with the same constituents in EPA Hazardous Waste No. K087. In performing this comparative analysis, the Agency used data available for K087 that demonstrates the effects of using recycled materials on quality of coke and coal tar produced. The Agency believes the same results would also apply to wastes that are recycled in the same manner, are physically similar to K087, and have concentrations of hazardous constituents similar or lower than the concentrations of these constituents in EPA Hazardous Waste No. K087. In general, EPA found that typical concentrations of the constituents of regulatory concern in the wastes (*i.e.*, organic constituents) proposed for listing were similar to or lower than the concentrations of the same constituents in EPA Hazardous Waste No. K087. These results are summarized in the Background Document to this proposal. The Agency's general understanding of the process would indicate that the levels of toxic metals would not increase from K087 to the other wastes proposed for listing today.

3. Descriptions of Management Practices for the Wastes Proposed for Listing as Hazardous from the Point of Generation to the Point of Reinsertion into Coke Ovens or Mixing with Coal Tar

For the purposes of determining and clarifying at what point the recycling exclusions apply, the Agency is describing existing practices in the coke by-products industry. (These practices apply to K087 wastes as well as to the wastes proposed in today's notice.) The Agency considered the reclamation process involved, the manner in which these residuals are handled, the

transportation methods employed (*i.e.*, mechanisms used to transport the residuals from the point of generation to the point of their recycling), and any intermittent storage that takes place. The waste management practices are discussed below. Since, up to the point of reinsertion, the listed materials are solid and hazardous waste, the requirements of § 261.6(a)(1), (b), and (c) apply. See part 5 of this section and section I.F of today's proposal.

The Agency considered excluding the wastes proposed for listing from the definition of solid waste when destined for recycling, rather than when reinserted. The rationale for this was based on interpretations of certain court decisions as whether or not materials were part of the waste disposal problem. However, due to concerns about hazardous constituents in the waste as well as real and potential waste mismanagement scenarios (particularly placement on the land), the Agency tentatively prefers the option of excluding these wastes only at the point of reinsertion into the coke ovens or mixing with crude coal tar.

a. Management Practices for Residuals From Their Point of Generation to the Point of Reinsertion Into Coke Ovens.—(i) Conveyance to Storage or Blending Unit

Based on the information available to EPA, the transportation of these residuals from their point of generation to the storage or blending site typically takes place in trucks or hopper cars. Facilities involved in recycling these residuals transport them to the blending site or store them in tanks (see 40 CFR 260.10 for EPA's definition of tanks). Hopper cars or trucks are currently used to transport these residuals from the point of generation to the point of reinsertion into coke ovens or mixing with coal tar. Interim management practices include storage of these residuals and mixing with coal. Wastes recycled on site may be stored up to 90 days without a permit.

To comply with Land Disposal Restrictions (LDR, 40 CFR Part 268), many facilities have had to discontinue putting K087 wastes on the ground, in a pit, or on a low-walled concrete pad in order to mix these wastes with coal. Instead, these wastes are managed in a unit such as a tank to accommodate K087 (and other) wastes. The Agency believes that recycling the proposed wastes will cause minimal extra requirements to construct recycling equipment over and above what already exists, and solicits comment on this point.

Some of the wastes proposed for listing may also be transported from one facility to another (in particular, K147 and K148). Such transportation may occur across a property boundary of adjacent facilities or over several hundred miles and across state lines. The Agency requires a manifest to ensure proper transport and delivery of these hazardous wastes prior to recycling. In addition, storage of wastes received from another facility may require a permit.

(ii) Blending of Residuals With Coal

The blending of these residuals with a portion of the coal feed is typically practiced to make the recyclable material physically similar to the coal feed (*i.e.*, to give the feedstock-blend a solid consistency as opposed to the semisolid form in which some of the residuals are generated). Based on the limited information available to the Agency, a homogenizing agent may also be used in some cases in the blending process. In a limited number of cases, earthmoving equipment is used for mixing these residuals with coal. In other cases, ball milling of the residuals is required to make a homogeneous mixture with the coal feed. Most of the processing steps involved in preparing the residual/coal mixture are carried out to avoid "hot spots" in the coke oven, operational problems that may be encountered, and any long term damage to the coke oven as a result of using these residuals as a part of the feedstock. However, the recycling process is typically carried out in a way such that the quality of coke manufactured is unaffected. The residual mixture thus prepared is then usually transported to the coal feed site.

(iii) Feeding the Coke Oven

Typically, the residual mixture is put on the conveyor that feeds the coke oven, or it is sprayed on the coal as it ascends a conveyor belt. In many cases, the residual mixture is heated before it is combined with the main coal feed to ensure an even feed mix and easier material handling. It should be noted that the residual mixture would be a hazardous waste before it is fed to the coke oven.

b. Management Practices for Residuals Proposed for Listing as Hazardous Prior to Blending with Crude Coal Tar.

Today's proposed residuals would be solid and hazardous wastes subject to RCRA subtitle C regulations prior to their mixing with the crude coal tar and subsequently sold as a product. The coal tar itself is subsequently refined into tar, pitch, or creosote. The

management practices for these residuals prior to blending with coal tar are similar to the management practices described above for residuals mixed with coal to be fed to the coke oven. Some of the proposed residuals are sent to ball mills to produce a uniform material before they are mixed with coal tar. The proposed exclusion under 40 CFR 261.4(a)(11) would only exempt the residuals proposed for listing as hazardous at the point where blending with crude coal tar occurs.

4. Similar Exclusion for Decanter Tank Tar Sludge (K087) When Reinserted into Coke Ovens or Blended with Coal Tar

EPA also proposes today to modify slightly this same exclusion for decanter tank tar sludge (EPA Hazardous Waste No. K087) when it is reinserted into coke ovens. Coke and coal tar containing decanter tank tar sludge currently are excluded from regulation as a hazardous waste under 40 CFR 261.4(a)(10) when used as a fuel. The exclusion classifies mixtures of the waste and coal tar, and coke derived from such mixtures, as products rather than wastes. However, other by-products, such as light oil recovered from coke oven gas generated by coke ovens charged with mixtures of coal and the waste, would have been hazardous wastes without the exclusion because of the "derived from" rule. Therefore, EPA excluded decanter tank tar sludge from the definition of solid waste at the point of reinsertion into coke ovens.

In addition, the wording of the exclusion in § 261.4(a)(10) is being corrected to delete the phrase "when used as a fuel." The Agency has found that inclusion of this phrase in the regulations will lead to confusion as to the scope of the exclusion, since coal tar is not generally used as a fuel (although it has high fuel value).

5. Generator Requirements

Generators should note that, under CFR 261.6(a)(1), hazardous wastes that are recycled are subject to the requirements for generators, transporters, and storage facilities of paragraphs (b) and (c) of that section, except for materials listed in (a)(2) and (a)(3) of that section. Under 40 CFR 261.6(b), generators and transporters of recyclable materials are subject to the applicable requirements of parts 262 and 263, and notification requirements under section 3010 of RCRA, except for materials listed in (a)(2) and (a)(3) of that section.

Under 40 CFR 261.6(c)(1), owners or operators of facilities that store recyclable materials before they are recycled are regulated under all

applicable provisions of subparts A through L of parts 264 and 265, and under Parts 124, 266, 268, and 270, and the notification requirements under section 3010 of RCRA, except as provided in paragraph (a) of that section. Under 40 CFR 261.6(c)(2), owners or operators of facilities that recycle materials without storing them before they are recycled are subject to the following requirements, except as provided in paragraph (a) of that section:

- (i) Notification requirements under section 3010 of RCRA.
- (ii) Section 265.71 and 265.72 (dealing with the use of a manifest system and manifest discrepancies).

6. Other Options

Recognizing the significant role recycling plays in this industry, and the implications of the definition of solid waste and RCRA Subtitle C regulations, the Agency has considered various options in designing a regulatory structure to allow recycling of certain coke by-products wastes. The options considered are oriented around: 1) whether or not to facilitate the recycling, 2) at what point would the wastes be outside the scope of RCRA regulation, and 3) an exclusion for wastes which exhibit the newly-promulgated Toxicity Characteristic (TC).

On March 29, 1990, the Agency promulgated the amended Toxicity Characteristic rule (55 FR 11798). The Agency believes that many of the wastes proposed to be listed as hazardous in today's rule already may be hazardous wastes because they contain levels of organic constituents (e.g., benzene) in excess of levels of these constituents published in the Toxicity Characteristic rule. Since these wastes may already be hazardous, recycling the wastes into the coke oven may also subject coke ovens to the strict management standards of the Boiler and Industrial Furnace rule mentioned above, unless an exclusion from the Definition of Solid Waste as described in this section were also effective.

In the period of time between the promulgation of the Boiler and Industrial Furnace rule and the K141-K145, K147, and K148 listings, recycling of these wastes would be discouraged if they are TC hazardous. As explained in Section I.1 of this proposal, any hazardous waste (listed or characteristic) that is used as a fuel or to make a fuel is still considered a solid waste. Therefore, the Agency is proposing (here and in a separate rulemaking) an exclusion from the definition of solid waste for characteristically hazardous wastes generated at coke by-products

manufacturing facilities that are recycled into the coke oven (40 CFR 261.4(a)(12)). Those wastes which fail the TC for benzene and are recycled into the coke oven (as described above in this section) will not be considered solid wastes at the point they are inserted into the coke oven. The Agency is not proposing to limit the scope of the exclusion to wastes which fail the TC for organic chemicals only. Since natural coal contains inorganic constituents, limiting the proposal only to organics would be anomalous.

The Agency notes that if the wastes proposed for listing today are TC hazardous for benzene, and they are mixed with K087 wastes prior to recycling into the coke ovens, the entire mixture would assume the K087 listing. Since under 40 CFR 268.43, K087 waste already has a treatment standard for benzene, no additional notification for TC hazardous wastes is required for the combined wastes. (This classification scheme is clarified in the technical corrections to the Third Third rule at 56 FR 3872, January 31, 1991.) The Agency will still promulgate the exclusions for recycled TC hazardous wastes at coking facilities in order not to cause confusion among the regulated community, and to avoid any difficulties for facilities that find prior mixing of these wastes with K087 is not always possible.

The Agency is also considering options other than the ones presented in the description of management practices. Some of these options may be addressed by commenters as to the specifics of recycling practices (see requests under "Conclusions" in this section). The Agency is also considering whether to exclude or exempt those wastes from this industry that are destined for recycling, as long as these wastes do not touch the ground or are placed on land. Specifically, the Agency is concerned with: (1) transportation of the wastes from one point to another (whether on one plant site or from one site to another), (2) what sort of facilities for handling the wastes could keep the wastes qualified for this exclusion (particularly in light of the recently promulgated land disposal restrictions regulations in 40 CFR part 268), (3) what alternatives may exist for specific waste streams if the wastes are chemically incompatible with the process equipment or with each other, (4) the legal jurisdiction the Agency has over the wastes at various points in the process, and (5) the extent of closed-loop recycling that takes place at coke by-products facilities.

7 Conclusions

In conclusion, the practice of reinserting these residuals (proposed K141 through K145, K147, and K148) back into the coke ovens serves to replace the raw material, coal, and the practice of mixing these residuals with coal tar serves to replace the product, coal tar. The practice, based on available information, seems to pose no additional hazard to human health and the environment. Therefore, the Agency is proposing to exclude these residuals when reinserted into the coke ovens or when mixed with product coal tar from the definition of solid waste under 40 CFR 261.4(a) (10), (11), and (12).

EPA recognizes that certain common management practices for coke by-products wastes may present a threat to human health and the environment. Even in cases where the wastes are recycled, some of the management steps prior to recycling could provide opportunity for the release of hazardous materials. As such, the proposed listing and recycling exclusions have been developed to require that the wastes be handled in accordance with subtitle C regulations after generation and up to the point of recycling.

The Agency notes that waste management practices are subject to change as new technologies are developed, economic incentives change, or as the Agency publishes other regulatory programs. Specifically, new regulations under the Clean Air Act (National Emissions Standards for hazardous Air Pollutants, or NESHAPs) published in September 1989 and March 1990 affect the coke by-products industry, and may have a direct effect on industrial operations and waste management practices. The Agency believes that compliance with NESHAP regulations will further reduce the potential for hazardous constituent releases into the environment; however, the Agency requests comment on this particular postulation. Given the fact that several of the wastes contain constituents of relatively high molecular

weight, EPA does not expect that mixing of the proposed wastes with coal tar would contribute to increased benzene emissions for the most part. Depending on the location of tar refining, storage, and mixing operations, the NESHAP regulations may apply to the mixing of coal tar with the wastes proposed in today's notice at certain facilities. However, the exclusions from the definition of solid waste will mean that facilities will not be subject to RCRA air rules (sections 264 and 265, subparts AA and BB) when mixing wastes with coal tar or reinserting wastes into the coke oven.

The February 21, 1991 Boiler and Industrial Furnace rule concluded that the sludge recycling does not affect the amount of toxic constituents in coke or coal tar, or emissions from their manufacturing processes. Furthermore, management of the wastes in question does not contribute to the waste disposal problem, rendering the regulation of coke and coal tar as RCRA solid wastes unnecessary. Additionally, the process of making coke and coal tar from K087, K060, K141-K145, K147, and K148 need not be subject to RCRA control. Since making coke and mixing coal tar are subject to special criteria under the Clean Air Act, RCRA regulation of some of these practices may be disruptive and inappropriate to the CAA regulatory scheme. As described above, the K087, K060, K141-K145, K147, and K148 wastes are subject to full RCRA regulation prior to entering the recycling process. Exclusions would not apply to the coking or coal tar producing process if other hazardous wastes (e.g., spent solvents) are mixed into the process. (See 56 FR 7203.)

EPA requests comment on its decision to exclude the proposed residuals when reinserted into coke ovens or mixed with coal tar product from the definition of solid waste under 40 CFR 261.4(a) (10), (11), and (12). Comments and data on the extent and nature of recycling and reclamation practices of these wastes, and the relationship of these

practices to the definition of solid waste are requested. Specific information on the following is requested: the length of time over which residuals accumulate; the manner in which they are returned to the process; the chemical compatibility of the wastes with the industrial process and with each other; the percentage of material recycled or reclaimed; the ability of the materials in question to be wastes under some circumstances and products in others; whether the recycling or reclamation takes place continuously; and, any other relevant information or data on the recycling or reclamation of these wastes.

F. Proposal Not To List Coke By-Products Wastewaters

EPA is not proposing to list coke by-products wastewaters as hazardous wastes. This decision is based on the Agency's expectation that at least some of the wastewater streams at coke by-products facilities may fail the TC test for benzene. EPA, therefore, expects that such wastewaters could be effectively regulated under the TC rule. In particular, final cooler blowdown and wastewaters from light oil recovery contain benzene levels ranging from 0.44 to 140 ppm. Table 10 presents the ranges of concentrations found for the hazardous constituents present in these wastewaters. EPA found that out of twelve samples, seven analyzed by EPA had benzene levels higher than the promulgated TC level of 0.5 ppm. Therefore, these wastes are now regulated Subtitle C wastes because they are characteristically hazardous. As shown in Table 10, wastewaters do not typically and frequently contain PAHs at quantifiable levels of regulatory concern. The Agency notes that if the wastes proposed for listing in today's notice (or any other listed hazardous waste) were to be deliberately mixed with coke by-product wastewaters, the mixture would become a hazardous waste pursuant to the mixture rule in 40 CFR 261.3(a)(2)(iv).

TABLE 10.—COKE BY-PRODUCTS PLANT WASTEWATERS

| Constituent of concern | Health-based water concentration limits (ppm) | Basis ¹ | IC regulatory level ² (ppm) | Coke by-products wastewater concentrations (ppm) ³ | | | | | | | | | | | |
|------------------------|---|-----------------------------|--|---|--------------------|---------|-----------------------|--------------------|---------|-------------------------------|--------------------|---------|------------------------------|--------------------|---------|
| | | | | Waste ammonia liquor | | | Final cooler blowdown | | | Light oil recovery wastewater | | | Mixed coke plant wastewaters | | |
| | | | | Range | No. of data points | Average | Range | No. of data points | Average | Range | No. of data points | Average | Range | No. of data points | Average |
| Benzene | 5.0×10^{-3} | HCL | 0.5 | <0.002 | 2 | 0.001 | 0.44-36 | 4 | 16 | 23-86 | 4 | 47 | 0.1-0.3 | 2 | 0.2 |
| Benz(a)anthracene | 1.1×10^{-4} | RSD (Class B ₁) | NA | <0.05-0.32 | 2 | <0.17 | <0.14-0.11 | 3 | 0.09 | ND-1.2 | 4 | 0.43 | <0.04-<0.06 | 2 | 0.03 |
| Benzo(a)pyrene | 3.0×10^{-4} | RSD (Class B ₁) | NA | <0.05-0.21 | 2 | 0.12 | ND-0.083 | 3 | 0.03 | ND-<1 | 4 | 0.1 | ND-<0.06 | 2 | 0.02 |

TABLE 10.—COKE BY-PRODUCTS PLANT WASTEWATERS—Continued

| Constituent of concern | Health-based water concentration limits (ppm) | Basis ¹ | IC regulatory level ² (ppm) | Coke by-products wastewater concentrations (ppm) ³ | | | | | | | | | | | |
|----------------------------|---|-----------------------------|--|---|--------------------|---------|-----------------------|--------------------|---------|-------------------------------|--------------------|---------|------------------------------|--------------------|---------|
| | | | | Waste ammonia liquor | | | Final cooler blowdown | | | Light oil recovery wastewater | | | Mixed coke plant wastewaters | | |
| | | | | Range | No. of data points | Average | Range | No. of data points | Average | Range | No. of data points | Average | Range | No. of data points | Average |
| Benzo(b and k)fluoranthene | 4.0×10^{-3} | RSD (Class B ₂) | NA | <0.05-0.36 | 2 | 0.19 | NO | 2 | NO | ND-<1 | 2 | 0.25 | ND-<0.06 | 2 | 0.02 |
| Dibenz(a,h)anthracene | 7.1×10^{-7} | RSD (Class B ₂) | NA | ND-<0.1 | 2 | 0.03 | NO | 2 | ND | ND-<2.5 | 2 | 0.63 | NO | 2 | NO |

Source: Background Document.

¹ MCL—Maximum Contaminant Level.

² RSD—Risk Specific Dose—Toxicity Characteristic (TC) levels were promulgated on March 29, 1990 (See 55 FR 11798-11862).

³ RSD—Risk Specific Dose— = Not Reported.

ND = Not Detected.

< = Detected but not quantifiable.

Pursuant to 40 CFR 261.11(a)(1) the Agency could have listed other wastewater streams from coke by-products plants (e.g., final cooler blowdown and wastewaters from light oil recovery) on the basis of the concentrations of benzene present in these waste streams. However, the Agency has currently decided not to list them and considers their regulation by the promulgated TC rule to be sufficiently protective of human health and the environment (for details on the TC rule, see 55 FR 11798-11862).

EPA does not have analytical data on the concentrations of benzene and other hazardous constituents of concern in sludges generated from the treatment of coke by-product wastewaters. However, since concentrations of most of these constituents in wastewaters with the exception of benzene are not typically and frequently present at levels of regulatory concern, the Agency does not believe that listing of sludges is warranted.

G. Impact of Future Land Disposal Restrictions (LDR) Determinations

The Hazardous and Solid Waste Amendments of 1984 (HSWA) impose substantial new responsibilities on those who handle hazardous waste. HSWA prohibits, in particular, the continued placement of hazardous waste in or on the land unless the Agency makes the determination that the prohibition is not required to protect human health and environment for as long as the waste remains hazardous. Land disposal of these wastes is only allowed if the wastes meet treatment standards promulgated by the Agency. These standards must substantially reduce the toxicity of or the likelihood of migration of hazardous constituents from the wastes. The statute also established a rigorous schedule for making determinations regarding the continued land disposal of these wastes. This schedule placed special emphasis

on all hazardous wastes that were identified prior to the enactment of HSWA (November 8, 1984).

The Agency is also required to make a land disposal prohibition determination for any hazardous waste that is newly identified or listed in 40 CFR Part 261 after November 8, 1984, within six months of the date of identification or effective date of listing (section 3004(g)(4), 42 U.S.C. 6924(g)(4)). Once promulgated, the coke by-products wastes being proposed in today's rule would, therefore, be subject to this requirement.

This section of today's preamble addresses activities EPA is planning to perform in order to comply with the mandatory requirements to develop land disposal restrictions for coke by-products wastes. The Agency is requesting comments and information in the areas of pollution prevention, recycling, treatment, and treatment capacity for these wastes.

1. Request for Comment on the Agency's Approach to Pollution Prevention in the LDR Program

EPA has made considerable progress over the years in improving environmental quality through its media-specific pollution control programs. Standard practice in several industries, however, has relied traditionally on land disposal of solid wastes, including those residuals generated from the control of air and water emissions. Treatment of many of these wastes was primarily motivated by industry's desire to reduce liability and costs of disposal. In part to conserve energy, industry began to recycle and burn or otherwise process many wastes as fuel substitutes where such technologies were relatively easy to implement. Elimination or reduction of the generation of these wastes, while instituted by a number of corporations, was typically not a high priority management practice.

This changed dramatically in 1984, as HSWA established a national policy reversing this scheme of priorities that was previously practiced by industry and inadvertently spawned by regulatory efforts. HSWA thus established elimination or reduction of wastes as the first priority for managing all wastes. Recycling and treatment came next in order of priority. While land disposal was established as the least preferred means of managing wastes, it was recognized as necessary for some wastes, provided they were treated prior to disposal.

The Agency intends to gather information on pollution prevention potential wherever feasible and thus is requesting comment on particular opportunities for volume and toxicity reduction for coke by-products wastes. Through cooperative efforts such as these, the Agency can better inform the public and make enlightened decisions on regulatory matters. At the same time, the information collected as a response to today's notice can be assembled, evaluated, and potentially disseminated through the Agency's technology transfer program potentially resulting in short-term positive impact on volume reductions. The Agency points out that even if the listing of these wastes is not promulgated, the pollution prevention ideas gathered from this notice can still be very useful to regulatory agencies, industry, and to the public.

Successful reduction in waste generation is often erroneously interpreted by industry to result only from complex and/or expensive process changes. Often there are relatively simple engineering solutions that can be easily implemented that will achieve this goal. Evaluation of adherence to existing process control measures along with slight modifications of these can often result in significant volume reduction. These evaluations may also point out the need for more complex

engineering evaluations (e.g., mixing effectiveness, process temperatures and pressures, and mutual compatibility of wastes). Simple physical audits of current waste generation and in-plant management practices for the wastes can also yield very positive results. These audits often turn up simple non-engineering practices that can be successfully implemented. They may point out the need for the repair/replacement of leaking pipes, valves, and simple equipment, or may result in modification of inspection and maintenance schedules.

The likelihood exists that pollution prevention opportunities for the manufacturing processes generating the wastes proposed in today's notice may potentially result in significant reductions in waste generation and, thus, considerable cost-savings for industry. The Agency is interested in comments and data on such opportunities, including both successful and unsuccessful attempts to reduce waste generation, as well as the potential for volume or toxicity reductions. It is also possible that, due to previous implementation of waste minimization procedures, some facilities or specific processes have very little potential for decreases in waste generation rates or toxicity. The Agency is particularly interested in specific information such as: (1) Data on the quantities of wastes that have been or could be reduced; (2) a means of calculating percent reductions that are achievable (accounting for changes in production rates); (3) potential for reduction in toxicity of the wastes; (4) the results of waste audits that have been performed; (5) capacity for recycling the wastes to the coke oven (or another part of the process); and (6) potential cost savings that can be (or have been) achieved.

In the case of wastes generated by the coke by-products industry, the Agency has some information concerning waste recycling practices, as discussed in the previous section of this preamble. EPA has collected this information as a result of other rulemaking efforts, such as the Boiler and Industrial Furnaces Rule, and is, in fact, proposing exclusions from the definition of solid waste for certain wastes as they are recycled. Any additional information provided by commenters will greatly ameliorate the Agency's ability to take into account past and present waste management practices for the purposes of LDR.

2. Request for Comment on the Agency's Approach to the Development of BDAT Treatment Standards

While the Agency prefers source reduction/pollution prevention and recycling/recovery over conventional treatment, inevitably some wastes (such as residues from recycling and inadvertent spill residues) will be generated. Thus, standards based on treatment using Best Demonstrated Available Technology (BDAT) will be required to be developed, at a minimum, for these wastes. (Note: The Agency does recognize there may be some special situations where the generation of a particular waste can be totally eliminated. This is unlikely, however, for most wastes.)

A general overview of the Agency's approach in performing analysis of BDAT for hazardous wastes can be found in Section III.A.1 of the preamble to the final rule for Third Third wastes (55 FR 22535-22542, June 1, 1990). If all or part of the proposed listing of the coke by-product wastes is promulgated in a later rulemaking, the Agency may develop BDAT treatment standards for these wastes based on the transfer of performance data from the treatment of wastes (such as K087) with similar chemical and physical characteristics or similar concentrations of hazardous constituents. Treatment standards will be established for these wastes on a constituent-specific basis, with the regulated constituents selected based on their presence in the untreated wastes. These constituents are not necessarily limited to the hazardous constituents of concern (proposed for 40 CFR part 261 appendix VII) identified as present in the wastes in today's rule.

The technologies required by and those forming the basis of the treatment standards, in general, are determined by whether the wastes contain organics and/or metals. For wastes such as the ones proposed in today's notice containing primarily organics, the Agency has found that incineration and other thermal destruction techniques can destroy most organics to concentrations at or near the limit of detection as measured in the ash residues. Many people, however, are apprehensive about incineration of hazardous wastes and prefer the use of alternative treatment technologies for wastes that must be treated. While the Agency believes that incineration and other thermal destruction technologies achieve a level of relatively complete destruction for the organics, it typically establishes concentration-based standards based on these data rather than requiring the wastes to be

incinerated. Thus, any alternative technologies that can achieve these levels may be used. In fact, where alternative treatment technologies cannot achieve these levels, but achieve reasonably comparable results, the Agency may promulgate adjusted treatment standards achievable by both incineration and the alternative technologies.

As stated above, the Agency has extensive information that the coking industry recycles many of its wastes by reinjecting them into the coke ovens. Because of this practice, the likelihood exists that this practice will be proposed as the BDAT for treatment of these wastes.

Thus, the Agency is soliciting or updating data and information on appropriate treatment technologies for the wastes proposed in today's rule. Information should include, but not be limited to, the following: (1) Technical descriptions of the treatment systems that are currently used for these wastes; (2) descriptions of alternative technologies that might be currently available or anticipated as applicable; (3) performance data for the treatment of these wastes (in particular, constituent concentrations in both treated and untreated wastes, as well as equipment design and operating conditions); (4) information on known or perceived difficulties in analyzing treatment residues or specific constituents; and (5) quality assurance/control information for all data submissions.

3. Request for Comment on the Agency's Approach to the Analyses of BDAT Treatment Capacity

In today's notice, the Agency is proposing to list coke by-product wastes as hazardous under 40 CFR 261.32. Although data on waste characteristics and current management practices have been gathered for the purpose of listing the wastes, the Agency has not evaluated these data for the purposes of developing specific BDAT treatment standards or assessing the capacity to treat (or recycle) these wastes. As a result, we are soliciting comments on the completeness of the existing data (which can be found in the RCRA docket) and requesting additional data and information with respect to treatment and capacity.

The Agency is particularly interested in updating the following information about the proposed wastes (identified by the proposed waste codes): (1) The total quantities of each waste generated; (2) the quantities (on-site and off-site) stored, treated, recycled, or disposed

(and types of units) with particular emphasis on those managed in units designated as land disposal under HSWA (Note: Besides landfills, this also includes underground injection units, surface impoundments, land treatment, and waste piles); (3) the treatability group classifications of the wastes (*i.e.*, wastewaters or nonwastewaters as defined in the Third Third rule); (4) the chemical/physical characteristics of the wastes, including information such as total organic carbon content, BTU value, concentration of organic and metal constituents, etc.; and (5) specific chemical composition or physical form of the waste that could potentially interfere or otherwise limit the application of specific treatment or recycling technologies and thus would impact EPA's analysis of capacity.

The Agency also needs additional data on the number of facilities and volume of wastes currently regulated under other regulations (*e.g.*, the Clean Water Act or the Clean Air Act), along with State or local waste management requirements. EPA needs to evaluate the impact of shifting these wastes from land disposal to on-site, captive, and commercial treatment or recycling capacity. The Agency is also soliciting comment on the viability of treating or recycling these wastes at commercial treatment and/or recycling facilities. It is particularly important that short-term and long-term trends (including potential capacity shortfalls) be identified, especially for new treatment and for recycling technologies. Finally, it is important to have this information provided on a facility-specific basis in order to address the impacts of the land disposal restrictions program on the regulated community.

III. State Authority

A. Applicability of Rules in States

Under section 3006 of RCRA, EPA may authorize qualified States to administer and enforce RCRA programs within the State. (See 40 CFR part 271 for the standards and requirements for authorization.) Following authorization, EPA retains enforcement authority under sections 3008, 7003, and 3013 of RCRA, although authorized States have primary enforcement responsibility.

Prior to the Hazardous and Solid Waste Amendments of 1984 (HSWA), a State with final RCRA authorization administered its authorized hazardous waste program entirely in lieu of EPA. The Federal requirements no longer applied in the authorized State, and EPA could not issue permits for any facilities in the State which the State was authorized to permit. When new, more-

stringent Federal requirements were promulgated or enacted, the State was obliged to enact equivalent authority within specified time frames. New Federal requirements did not take effect in an authorized State until the State adopted the requirements as State law.

In contrast, under section 3006(g) of RCRA (42 U.S.C. 6926(g)), new requirements and prohibitions imposed by the HSWA take effect in authorized States at the same time that they take effect in nonauthorized States. EPA is directed to implement these requirements and prohibitions in authorized States, including the issuance of permits, until the State modifies its program to reflect the Federal standards, and applies for and is granted authorization. While States must still adopt HSWA-related provisions as State law to retain final authorization, HSWA applies in authorized States in the interim.

Today's proposal for listing EPA Hazardous Waste Nos. K141 through K145, K147, and K148 is being proposed pursuant to section 3001(e)(2) of RCRA, a provision added by HSWA. When the final rules are promulgated, EPA will consider its HSWA obligation to make a determination regarding listing coke by-products wastes to be fulfilled.

Therefore, the Agency is proposing to add these requirements to Table 1 in 40 CFR 271.1(j), which identifies the Federal program requirements that are promulgated pursuant to HSWA and that take effect in all States, regardless of their authorization status. States may apply for either interim or final authorization for the HSWA provisions identified in 40 CFR 271.1(j) table 1, as discussed in the following section of the preamble.

B. Effect on State Authorizations

As noted previously, today's rule is being proposed pursuant to provisions added by HSWA. The addition of K141 through K145, K147, and K148 to the list of hazardous wastes from specific sources is proposed pursuant to section 3001(e)(2) of RCRA, a provision added by HSWA.

As noted above, EPA will implement the HSWA portions of today's rule (*i.e.*, the addition of K141 through K145, K147, and K148 to the list of hazardous wastes from specific sources) in authorized States until they modify their programs to adopt these rules and such modifications are approved by EPA. Because this rule will be promulgated pursuant to HSWA, a State submitting a program modification may apply to receive either interim or final RCRA authorization under section 3006(g)(2) or 3006(b), respectively, on the basis that

State regulations are substantially equivalent or fully equivalent to EPA's regulations. The procedures and schedule for State program modifications for either interim or final authorization are described in 40 CFR 271.21. It should be noted that all HSWA interim authorizations will expire on January 1, 1993 (see 40 CFR 271.24(c)).

It should be noted that 40 CFR 271.21(e) requires that States having final RCRA authorization must modify their programs to reflect Federal program changes and must subsequently submit the modifications to EPA for approval. The deadline by which States must modify their programs to adopt today's proposed rule will be determined by the date of promulgation of the final rule in accordance with 40 CFR 271.21(e)(2). Once EPA approves the modification, the State requirements become RCRA subtitle C requirements.

States with authorized RCRA programs may already have regulations similar to those proposed in today's rule. Such State regulations have not been assessed against the Federal regulations being proposed today to determine whether they meet the tests for authorization. Thus, a State is not authorized to implement its regulations as RCRA requirements until the State program modification is submitted to EPA and approved. Of course, States with existing regulations may continue to administer and enforce those regulations as a matter of State law. In addition, in implementing the Federal program, EPA will work with the States under cooperative agreements to minimize duplication of efforts; in many cases, EPA will be able to defer to the States in their efforts to implement their programs, rather than take separate actions under Federal authority.

States that submit their official applications for final authorization less than 12 months after the effective date of EPA's regulations are not required to include regulations equivalent to the EPA regulations in their application. However, States must modify their programs by the deadlines set forth in 40 CFR 271.21(e). States that submit official applications for final authorization 12 months after the effective date of these standards must include standards equivalent to these standards in their application. The requirements States must meet when submitting final authorization applications are set forth in 40 CFR 271.3.

IV. CERCLA Designation and RQ Adjustment

Pursuant to section 101(14)(C) of the Comprehensive Environmental

Response, Compensation, and Liability Act of 1980 (CERCLA), as amended, the wastes proposed to be listed as hazardous in today's notice will, on the effective date of the final rule, automatically become hazardous substances under CERCLA by virtue of their listing under RCRA. The CERCLA hazardous substances are listed in Table 302.4 at 40 CFR 302.4 along with their reportable quantities (RQs). CERCLA section 103(a) requires that persons in charge of vessels or facilities from which a hazardous substance has been released in a quantity that is equal to or greater than its RQ shall immediately notify the National Response Center of the release at (800) 424-8802 or at (202) 426-2675. In addition, section 304 of the Superfund Amendments and Reauthorization Act of 1986 (SARA) requires the owners or operator of a facility to report the release of a CERCLA hazardous substance or an extremely hazardous substance to the appropriate State emergency response commission (SERC) and to the local emergency planning committee (LEPC) when the amount released equals or exceeds the RQ for the substance or one pound where no RQ has been set.

The release of a hazardous waste to the environment must be reported when the amount released equals or exceeds

the RQ for the waste, unless the concentrations of the constituents of the waste are known (48 FR 23566, May 25, 1983). If the concentrations of the constituents of the waste are known, then the mixture rule may be applied. According to the "mixture rule" developed in connection with the Clean Water Act Section 311 regulations (40 CFR 302.6(b)) and also used in notification under CERCLA and SARA (50 FR 13463, April 4, 1985 and amended on August 14, 1989, 54 FR 33481), the release of mixtures or solutions (including hazardous waste streams) of hazardous substances would need to be reported to the NRC, and to the SERC and LEPC: (1) If the quantity of all of the hazardous constituent(s) of the mixture or solution is known, when an RQ or more of any hazardous constituent is released, or (2) if the quantity of one or more of the hazardous constituent(s) of the mixture or solution is unknown, when the total amount of the mixture or solution released equals or exceeds the RQ for the hazardous constituent with the lowest RQ. RQs of different hazardous substances are not additive under the mixture rule, so that spilling a mixture containing half an RQ of one hazardous substance and half an RQ of another hazardous substance need not be reported.

Under section 102(b) of CERCLA, all hazardous wastes newly designated under RCRA will have a statutorily-imposed RQ of one pound unless and until adjusted by regulation under CERCLA. In order to coordinate the RCRA and CERCLA rulemaking with respect to new waste listings, the Agency today is proposing regulatory amendments under CERCLA authority in connection with the proposed listing of wastes K141, K142, K143, K144, K145, K147, and K148. The Agency is proposing to: (1) Designate wastes K141, K142, K143, K144, K145, K147, and K148 as hazardous substances under section 102(a) of CERCLA and (2) adjust the RQs of wastes K141, K142, K143, K144, K145, K147, and K148 to one pound. Releases of a waste stream are reportable if any hazardous constituent of the waste stream is released in a quantity greater than or equal to the RQ for that constituent (50 FR 13463, April 4, 1985). Wastes K141, K142, K143, K144, K145, K147, and K148 each contain one or more hazardous constituents that have a 1-pound RQ; therefore, the RQs of the wastes are also proposed as 1 pound. The RQs for each of the hazardous constituents and the proposed RQs for each waste are identified in Table 11.

TABLE 11.—RQs FOR CONSTITUENTS OF CONCERN FOR WASTES K141–K145, K147, AND K148

| Hazardous substance | Constituent | RQ (lbs) |
|---------------------|-----------------------------|----------|
| Waste No. K141..... | Benzene..... | 1 |
| | Benz(a)anthracene..... | 10 |
| | Benzo(a)pyrene..... | 10 |
| | Benzo(b)fluoranthene..... | 1 |
| | Benzo(k)fluoranthene..... | 1 |
| | Dibenz(a,h)anthracene..... | 5,000 |
| | Indeno(1,2,3-cd)pyrene..... | 1 |
| Waste No. K142..... | Benzene..... | 1 |
| | Benz(a)anthracene..... | 10 |
| | Benzo(a)pyrene..... | 10 |
| | Benzo(b)fluoranthene..... | 1 |
| | Benzo(k)fluoranthene..... | 1 |
| | Dibenz(a,h)anthracene..... | 5,000 |
| | Indeno(1,2,3-cd)pyrene..... | 100 |
| Waste No. K143..... | Benzene..... | 1 |
| | Benz(a)anthracene..... | 10 |
| | Benzo(a)pyrene..... | 10 |
| | Benzo(b)fluoranthene..... | 1 |
| | Benzo(k)fluoranthene..... | 1 |
| Waste No. K144..... | Benzene..... | 1 |
| | Benz(a)anthracene..... | 10 |
| | Benzo(a)pyrene..... | 10 |
| | Benzo(b)fluoranthene..... | 1 |
| | Benzo(k)fluoranthene..... | 1 |
| Waste No. K145..... | Benzene..... | 5,000 |
| | Benz(a)anthracene..... | 1 |
| | Benzo(a)pyrene..... | 1 |
| | Benzo(b)fluoranthene..... | 1 |
| | Dibenz(a,h)anthracene..... | 1 |

TABLE 11.—RQS FOR CONSTITUENTS OF CONCERN FOR WASTES K141–K145, K147, AND K148—Continued

| Hazardous substance | Constituent | RQ (lbs) |
|---------------------|-----------------------------|----------|
| Waste No. K147 | Naphthalene..... | 100 |
| | Benzene..... | 1 |
| | Benz(a)anthracene..... | 10 |
| | Benzo(a)pyrene..... | 10 |
| | Benzo(b)fluoranthene..... | 1 |
| | Benzo(k)fluoranthene..... | 1 |
| | Dibenz(a,h)anthracene..... | 5,000 |
| Waste No. K148 | Indeno(1,2,3-cd)pyrene..... | 1 |
| | Benz(a)anthracene..... | 100 |
| | Benzo(a)pyrene..... | 1 |
| | Benzo(b)fluoranthene..... | 10 |
| | Benzo(k)fluoranthene..... | 1 |
| | Dibenz(a,h)anthracene..... | 5,000 |
| | Indeno(1,2,3-cd)pyrene..... | 1 |

V. Cost and Economic Analysis

Executive Order No. 12291 requires EPA to prepare an analysis of the costs and economic impacts associated with a proposed regulation. The results of this analysis are used to determine whether the regulation will result in: (1) Incremental annual costs that exceed \$100 million, (2) significant increases in costs or prices for consumers or individual industries, or (3) significant adverse effects on competition, employment, investment, innovation, or international trade. If a proposed rule meets any of these criteria, it is a "major rule," as defined by Executive Order No. 12291, and a Regulatory Impact Analysis must be completed before the rule is promulgated.

Today's proposed rule is not a "major" rule because it would not have an annual economic effect of more than \$100 million and would not have significant adverse effects on the coke by-products and tar refining industries. This section of the preamble discusses the results of the cost analyses undertaken to assess the effects of the proposed rule. The draft Cost and Economic Impact Analysis (DPRA, 1990) is available in the public docket for this proposal.

In order to assess the effects of the proposed rule, EPA first identified wastes and facilities which would be affected by the rule. Incremental costs for each facility were estimated based on the changes in waste management practices that would be required once the wastes are regulated as hazardous. The incremental costs for the individual facilities were aggregated to estimate national costs of the rule.

To determine the nationwide costs of the proposed rule, waste quantities, baseline management practices, and compliance management practices for proposed EPA Hazardous Waste Nos.

K141 through K145, K147, and K148 were developed based on the information in RCRA 3007 questionnaires and best engineering judgment. For these wastes, the baseline management practices included recycling of wastes to coke ovens, burning as fuels, and disposal in off-site landfills. The most-costly compliance management practice for all these wastes was assumed to be incineration in a permitted RCRA incinerator.

Incremental costs were calculated by subtracting costs of baseline management practices from costs of management practices if all of the proposed wastes are regulated as hazardous. Management practices were developed for both the least-costly compliance option and most-costly compliance option based on waste types and quantities.

EPA's analysis indicates that the total annualized incremental cost to the industry, excluding regulatory costs for 40 CFR parts 262 and 266, would range from approximately \$150,000 for the least-costly compliance option to \$18 million for the most-costly compliance option. The least costly compliance option involves costs associated with managing today's proposed wastes as hazardous before they are reinserted into the coke oven. Costs involved in this option would result from upgrading existing storage and secondary containment systems, and the transportation of those tar refining wastes that are not currently being recycled to the coke ovens. The most costly compliance option involves incineration of all residuals in RCRA permitted incinerators.

The annualized administrative costs for complying with 40 CFR parts 262 are estimated to be \$52,000, which includes costs for reporting and record keeping. Therefore, even for the most costly

compliance option (*i.e.*, incineration of these wastes) the total annualized incremental cost of this rule is estimated to be less than \$100 million.

Additionally, the Agency's analysis concluded that these costs would not result in significant price increases or significant adverse effects on competition, trade, employment or investment. Therefore, because impacts of the proposed rule do not meet the criteria for major rules set by Executive Order No. 12291, the Agency has determined that today's rule is not a major rule.

VI. Regulatory Flexibility Act

Pursuant to the Regulatory Flexibility Act (5 U.S.C. 601–612), whenever an Agency is required to publish a General Notice of Rulemaking for any proposed or final rule, it must prepare and make available for public comment a regulatory flexibility analysis (RFA) that describes the impact of the rule on small entities (*i.e.*, small businesses, small organizations, and small governmental jurisdictions). No RFA is required, however, if the head of the Agency certifies that the rule will not have a significant impact on a substantial number of small entities.

Since EPA has determined the hazardous wastes proposed for listing here are not generated by small entities (as defined by the Regulatory Flexibility Act), and the Agency believes that small entities will not generate them in significant quantities. This regulation, therefore, does not require an RFA. Accordingly, I hereby certify that this regulation will not have a significant economic impact on a substantial number of small entities.

VII. Paperwork Reduction Act

This rule does not contain any information collection requirements

subject to OMB review under the Paperwork Reduction Act of 1980, 44 U.S.C. 3501 et seq.

VIII. Compliance and Implementation

A. Section 3010 Notification

Generally, when new hazardous wastes are listed, all persons who generate, transport, treat, store, or dispose the newly listed waste(s) are required to notify either EPA, or a State authorized by EPA to operate the hazardous waste program, of their activities pursuant to section 3010 of RCRA. However, under the Solid Waste Disposal Amendments of 1980 (Pub. L. 96-482), EPA was given the option of waiving the notification requirements under section 3010 of RCRA following revision of the section 3001 regulations, at the discretion of the Administrator. EPA is proposing to waive this notification requirement for persons who handle wastes that are covered by today's proposed listing and have already notified EPA that they manage other hazardous wastes and have received an EPA identification number. This waiver is being proposed because of the likelihood that persons managing today's proposed wastes already are managing one or more hazardous wastes that generally are associated with the generation of proposed EPA Hazardous Waste Nos. K141 through K145, K147, and K148 and have, therefore, previously notified EPA and received an EPA identification number. In the event that any person who generates, transports, treats, stores, or disposes these wastes and has not previously notified and received an identification number, that person must obtain an identification number pursuant to 40 CFR 262.12 before that person can generate, transport, treat, store, or dispose of these wastes.

B. Compliance Dates for Facilities

Today's proposed listings will be promulgated pursuant to HSWA. HSWA requirements are applicable in authorized States at the same time as in unauthorized States. Therefore, EPA will regulate the wastes being proposed today until States are authorized to regulate these wastes. Once these regulations are promulgated in a final rule by EPA, the Agency will apply these Federal regulations to these wastes and to their management in both authorized and unauthorized States.

Newly regulated facilities (*i.e.*, facilities at which the only hazardous wastes that are managed are today's proposed wastes in units subject to permit requirements when these listings are finalized) must qualify for interim

status within six months of publication of the rule in order to continue managing these wastes in such units. To retain interim status, a newly-regulated land disposal facility must submit a part B permit application within eighteen months after publication of the rule and certify that the facility is in compliance with all applicable ground-water monitoring and financial responsibility requirements (see RCRA section 3005(e)(3)).

Interim status facilities that manage today's proposed wastes after these listings are finalized, must file an amended Part A permit application within six months of publication of the final rule if they are to continue managing these wastes in units that require a permit. The facilities must file the necessary amendments by the effective date of the rule, or they will not retain interim status with respect to today's proposed wastes (*i.e.*, they will be prohibited from managing additionally listed coke by-products wastes until permitted).

Currently permitted facilities that manage today's proposed wastes after their listings are finalized by EPA, must request permit modifications if they are to continue managing these wastes in units that require a permit. Since EPA will initially be responsible for processing these permit modifications, the new Federal procedures for permit modifications will be followed (see 53 FR 37934, September 28, 1988). These new procedures contain a specific provision for newly listed or identified wastes (see § 270.42(g)). This provision generally requires that a permitted facility that is "in existence" for the newly listed or identified waste on the effective date of the waste listing must submit a Class 1 modification by that date. Essentially, this modification notifies the Agency and the public that the facility is handling the waste and identifies the units involved. By submitting this notice, the facility is temporarily allowed to continue management of the newly listed wastes until the Agency can make a final change to the permit. Next, within 180 days of the effective date the permittee must submit a more detailed permit modification request (*i.e.*, a Class 2 or 3 modification). This information will be used by the Agency to develop a final permit change. For more information on permit modifications see the September 28, 1988 preamble discussion referenced above.

List of Subjects

40 CFR Part 261

Hazardous waste, Recycling.

40 CFR Part 271

Administrative practice and procedure, Confidential business information, Hazardous materials transportation, Hazardous waste, Indian lands, Intergovernmental relations, Penalties, Reporting and record keeping requirements, Water pollution control, Water supply.

40 CFR Part 302

Air pollution control, Chemicals, Hazardous substances, Hazardous materials, Hazardous waste, Intergovernmental relations, Natural resources, Reporting and recordkeeping requirements, Superfund, Water pollution control, and water supply.

Dated: July 12, 1991.

William K. Reilly,
Administrator.

IX. References

1. Van Osdell, D.W., *et al.*, Environmental Assessment of Coke By-Product Recovery Plants. U.S. Environmental Protection Agency, Research Triangle Park, North Carolina. Publication No. EPA-600/2-79-016. January 1979.
2. U.S. Environmental Protection Agency. Benzene Emissions from Coke By-Product Recovery Plants, Benzene Storage Vessels, Equipment Leaks, and Ethylbenzene/Styrene Process Vents—Background Information and Responses to Technical Comments for 1989 Final Decisions. Final Environmental Impact Statement (EIS). Research Triangle Park, North Carolina. Publication No. EPA-450/3-89-31. August 1989.
3. U.S. Environmental Protection Agency. Development Document for Effluent Guidelines. New Source Performance Standards and Pretreatment Standards for the Iron and Steel Manufacturing Point Source Category, Volume II. Washington, DC Publication No. EPA 440/1-82/024. Final Draft. May 1982.
4. RCRA 3007 Questionnaire Responses. 1985.
5. RCRA 3007 Clarification Request Responses. 1987
6. Shine, B. Memorandum to Coke Project File documenting waste generation estimates. February 1989.
7. Development Planning and Research Associates, Inc. (DPRA). Draft Final Report on Cost and Economic Impact Analyses of Listing Additional Hazardous Wastes From the for the Coke By-Products (Coking and Tar Refining) Industry. Prepared for Economic Analysis Branch, Office of Solid Waste, U.S. Environmental Protection Agency, June 1990.
8. Background Document for the Proposed Listing of Coke By-Products Wastes. June 1990.

For the reasons set out in the preamble, it is proposed to amend title 40 of the Code of Federal Regulations as follows:

PART 261—IDENTIFICATION AND LISTING OF HAZARDOUS WASTE

1. The authority citation for Part 261 continues to read as follows:

Authority: 42 U.S.C. 6905, 6912(a), 6921, 6922 and 6938.

2. Section 261.4 paragraph (a)(10) is revised and paragraphs (a)(11) and (a)(12) are added to read as follows:

§ 261.4 Exclusions.

(a) * * *

(10) Coke and coal tar from the iron and steel industry that contain or are produced by recycling EPA Hazardous Waste Nos. K060, K087, K141, K142, K143, K144, K145, K147, and K148. The process of producing coke and coal tar from these wastes is likewise excluded from regulation. This exclusion does not apply prior to the point of mixing wastes with coal or coal tar.

(11) EPA Hazardous Waste Nos. K060, K087, K141, K142, K143, K144, K145, K147, and K148 when reinserted into coke ovens as feedstock to produce coke. This exclusion does not apply prior to the point of reinsertion of wastes into coke ovens.

(12) All wastes from the coke by-products industry that are hazardous only because they exceed levels for hazardous constituents in § 261.24, when these wastes are reinserted into coke ovens as a feedstock to produce coke. This exclusion does not apply prior to the point of reinsertion of wastes into coke ovens.

* * * * *

3. Section 261.32 is amended by adding the following hazardous waste listings to the subgroups Coking and Pesticides:

§ 261.32 Hazardous wastes from specific sources.

* * * * *

| Industry and EPA hazardous waste no. | Hazardous waste | Hazard code |
|--------------------------------------|---|-------------|
| * * * * * | | |
| Pesticides: | | |
| K147..... | Tar storage tank residuals from coal tar refining. | (T) |
| K148..... | Residues from coal tar distillation, including, but not limited to, still bottoms. | (T) |
| * * * * * | | |
| Coking: | | |
| K141..... | Process residues from the recovery of coal tar, including, but not limited to, collecting sump residues from the production of coke from coal or the recovery of coke by-products produced from coal. This listing does not include K087 (decanting tank tar sludges from coking operations). | (T) |
| K142..... | Tar storage tank residues from the production of coke from coal or from the recovery of coke by-products produced from coal. | (T) |
| K143..... | Process residues from the recovery of light oil, including those generated in stills, decanters, and wash oil recovery units from the recovery of coke by-products produced from coal. | (T) |
| K144..... | Wastewater treatment sludges from light oil refining, including, but not limited to, interception or contamination sump sludges from the recovery of coke by-products produced from coal. | (T) |
| K145..... | Residues from naphthalene collection and recovery operations from the recovery of coke by-products produced from coal. | (T) |

4. Appendix VII of part 261 is amended by adding the following waste streams in alphanumeric order as follows:

APPENDIX VII.—BASIS FOR LISTING HAZARDOUS WASTE

| EPA hazardous waste no. | Hazardous constituents for which listed |
|-------------------------|--|
| * * * * * | |
| K141..... | Benzene, benz(a)anthracene, benzo(a)pyrene, benzo(b)fluoranthene, benzo(k)fluoranthene, dibenz(a,h)anthracene, indeno(1,2,3-cd)pyrene. |
| K142..... | Benzene, benz(a)anthracene, benzo(a)pyrene, benzo(b)fluoranthene, benzo(k)fluoranthene, dibenz(a,h)anthracene, indeno(1,2,3-cd)pyrene. |
| K143..... | Benzene, benz(a)anthracene, benzo(a)pyrene, benzo(b)fluoranthene, benzo(k)fluoranthene. |
| K144..... | Benzene, benz(a)anthracene, benzo(a)pyrene, benzo(b)fluoranthene, benzo(k)fluoranthene, dibenz(a,h)anthracene. |
| K145..... | Benzene, benz(a)anthracene, benzo(a)pyrene, dibenz(a,h)anthracene, naphthalene. |
| K147..... | Benzene, benz(a)anthracene, benzo(a)pyrene, benzo(b)fluoranthene, benzo(k)fluoranthene, dibenz(a,h)anthracene, indeno(1,2,3-cd)pyrene. |
| K148..... | Benz(a)anthracene, benzo(a)pyrene, benzo(b)fluoranthene, benzo(k)fluoranthene, dibenz(a,h)anthracene, indeno(1,2,3-cd)pyrene. |

* * * * *

PART 271—REQUIREMENT FOR AUTHORIZATION OF STATE HAZARDOUS WASTE PROGRAMS

5. The authority citation for part 271 continues to read as follows:

Authority: 42 U.S.C. 6905, 6912(a), and 6926.

6. Section 271.1(j) is amended by adding the following entry to Table 1 in chronological order by date of publication:

§ 271.1 Purpose and scope.

* * * * *

(j) * * *

TABLE 1.—REGULATIONS IMPLEMENTING THE HAZARDOUS AND SOLID WASTE AMENDMENTS OF 1984

| Promulgation date | Title of regulation | Federal Register reference | Effective date |
|--|---|--|--|
| [Insert date of final rule publication]..... | The listing of wastes from the production, recovery, and refining of coke by-products produced from coal. | XX FR XX [Insert page citation of final rule]. | [Insert effective date of final rule.] |

Authority: 42 U.S.C. 9602; 33 U.S.C. 1321 and 1361.

republished without change.

**PART 302—DESIGNATION,
REPORTABLE QUANTITIES, AND
NOTIFICATION**

7. The authority citation for part 302 continues to read as follows:

§ 302.4 [Amended]

8. Section 302.4 is amended by adding the waste streams K141 through K145, K147 and K148 to Table 302.4. The appropriate footnotes to Table 302.4 are

TABLE 302.4.—LIST OF HAZARDOUS SUBSTANCES AND REPORTABLE QUANTITIES

| Hazardous substance | CASRN | Regulatory synonyms | Statutory | | Final RQ | | |
|--|-------|---------------------|-----------|--------|----------------|----------|-------------|
| | | | RQ | Code † | RCRA waste No. | Category | Pounds (Kg) |
| K141..... Process residues from the recovery of coal tar, including, but not limited to, tar collecting sump residues from the production of coke from coal or the recovery of coke by-products produced from coal. This listing does not include K087 (decanter tank tar sludge from coking operations). | | | 1* | 4 | K141 | X | 1 (0.454) |
| K142..... Tar storage tank residues from the production of coke from coal or from the recovery of coke by-products produced from coal. | | | 1* | 4 | K142 | X | 1 (0.454) |
| K143..... Process residues from the recovery of light oil, including, but not limited to, those generated in stills, decanters, and wash oil recovery units from the recovery of coke by-products produced from coal. | | | 1* | 4 | K143 | X | 1 (0.454) |
| K144..... Wastewater treatment sludges from light oil refining, including, but not limited to, intercepting or contamination sump sludges from the recovery of coke by-products produced from coal. | | | 1* | 4 | K144 | X | 1 (0.454) |
| K145..... Residues from naphthalene collection and recovery operations from the recovery of coke by-products produced from coal. | | | 1* | 4 | K145 | X | 1 (0.454) |
| K147..... Tar storage tank residues from coal tar refining. | | | 1* | 4 | K147 | X | 1 (0.454) |
| K148..... Residues from coal tar distillation, including, but not limited to, still bottoms. | | | 1* | 4 | K148 | X | 1 (0.454) |

† —indicates the statutory source as defined by 1, 2, 3, 4, or 5 below.

4 —indicates that the statutory source for designation of this hazardous substance under CERCLA is RCRA Section 3001.

1* —indicates that the 1-pound RQ is a CERCLA statutory RQ.

[FR Doc. 91-17238 Filed 7-25-91; 8:45 am]

BILLING CODE 6560-50-M

Register Federal Project

**Friday
July 26, 1991**

Part VII

Department of Education

**Institutional Quality Control Project;
Notice of Deadline for Participation**

DEPARTMENT OF EDUCATION**Institutional Quality Control Project****AGENCY:** Department of Education.**ACTION:** Notice of deadline date for participation in the Institutional Quality Control Project and revision of selection criteria.

SUMMARY: The Secretary issues a deadline date for the submission of a written notice by an institution that it wishes to participate in the Institutional Quality Control (IQC) Project. The criteria used to select institutions for the IQC Project were published in the *Federal Register* of December 27, 1988, 53 FR 52387. However, the Secretary is revising certain elements of those selection criteria.

The IQC Project is an alternative management approach to verification of information provided on student financial assistance applications, under which a participating institution develops and implements a quality control system in connection with its administration of the Pell Grant, campus-based (Perkins Loan, College Work-Study, and Supplemental Educational Opportunity Grant), and Stafford Loan programs.

EFFECTIVE DATE: These selection criteria take effect either 45 days after publication in the *Federal Register* or later if the Congress takes certain adjournments. These selection criteria will become effective after the information collection requirement in this notice has been submitted by the Department of Education and approved by the Office of Management and Budget under the Paperwork Reduction Act of 1980. If you want to know the effective date of these criteria, call or write the Department of Education contact person.

DEADLINE DATE FOR REQUEST TO PARTICIPATE IN IQC PROJECT: An institution must submit its request to participate in the IQC Project by August 26, 1991.

FOR FURTHER INFORMATION CONTACT: Barbara Mroz, Division of Quality Assurance, U.S. Department of Education, 400 Maryland Avenue SW. (Regional Office Building 3, Room 5042), Washington, DC, 20202-5243. Telephone Number: (202) 708-8439. Deaf and hearing impaired individuals may call the Federal Dual Party Relay Service at 1-800-877-8339 (in the Washington, DC 202 area code, telephone 708-9300) between 8 a.m. and 7 p.m., Eastern time.

SUPPLEMENTARY INFORMATION: The Secretary plans to publish separately regulations to extend the Project through

the end of the 1993-94 award year. An institution that is selected to participate in the IQC Project is exempt, for the period of its participation in the IQC Project, from selected requirements set forth in the verification regulations of subpart E of the Student Assistance General Provisions Regulations, 34 CFR part 668.

These requirements are contained in the following sections:

- Section 668.53(a) (1) through (4).
- Section 668.54(a) (1), (2), and (4).
- Section 668.56
- Section 668.57, except that an institution shall require an applicant that it has selected for verification to submit to it a copy of the income tax return, if filed, of the applicant, his or her spouse, and his or her parents, if the income reported on the income tax return was used in determining the expected family contribution.
- Section 668.60(a).

In lieu of these regulatory requirements, the Secretary requires a participating institution to develop and implement a quality control system in connection with its administration of the Title IV, HEA programs. Under such a quality control system, the institution must 1) evaluate its current procedures for administering the Title IV, HEA programs ("management assessment component"); 2) identify the errors that result from its current procedures ("error measurement component"); and 3) design corrections to its procedures that will enable it to eliminate or significantly reduce those errors ("corrective actions component").

The Secretary published Final Selection Criteria for participation in the IQC Project in the *Federal Register* of December 27, 1988, 53 FR 52387. When the Secretary published the Final Selection Criteria he indicated that, to administer the IQC Project properly, the number of institutions participating in the IQC Project should not exceed 102. Currently 61 institutions participate in the IQC Project, and these institutions need not reapply to continue participating. Therefore, if all 61 of the current participants choose to remain in the IQC Project, the Secretary will select no more than 41 new participants. Should any currently participating institution choose not to continue in the IQC Project, the Secretary will select the maximum number of new participants, resulting in a total of no more than 102 participants.

The selection criteria indicated that selected institutions should have experience in the Pell Grant, campus-based (Perkins Loan, College Work-Study, and Supplemental Educational

Opportunity Grant), and Stafford Loan programs and in dealing with a significant number of students and Federal dollars in all those programs. Accordingly, the selection criteria required that an institution be a participant in the above programs during the 1988-89 award year and have participated in all five programs during the preceding two award years (the 1986-87 and 1987-88 award years).

The Secretary is amending those criteria and updating the pertinent award years. Therefore, for institutions that wish to participate in the IQC Project for the first time during the 1991-92 award year, they must be participating in the five programs during the 1990-91 award year, and have participated in all five programs during the 1988-89 and 1989-90 award years.

The Secretary encourages participation in the IQC Project by junior and community colleges, and by two- and four-year colleges serving predominantly low-income populations, provided that these institutions otherwise qualify under the Final Selection Criteria. Any institution applying to participate should have a strong interest in increasing the quality of its management and award of student financial assistance dollars.

The Secretary is republishing only Final Selection Criteria I and II. The Secretary will select all applicants that meet Selection Criterion I provided that, when that number of applicants is added to the number of current participants, the total does not exceed 102. In the event that the number of new applicants meeting Selection Criterion I would bring the total number of participants over 102, the Secretary will select applicants on the basis of additional criteria published under Final Selection Criterion III in the *Federal Register* of December 1, 1986, 51 FR 43334-43335. Criterion III pertains exclusively to the Department's selection process and has no bearing on institutional applications.

Application Procedures

There are no application forms from the Department of Education that must be used to apply to participate in the IQC Project. An institution applies to participate in the IQC Project by sending a written notice to the Secretary of its request to participate. In this notice, an interested institution must include a written statement of not more than 500 words that demonstrates its commitment to quality control and error reduction in processing and awarding student financial assistance dollars. In addition to a description of the

institution's procedures for verification of student data and eligibility, the statement must include a description of activities and procedures that its financial aid office routinely uses to control, reduce, and correct errors in its administration of the Title IV, HEA programs. In addition, the statement must indicate the resources, such as automated data processing, personnel and the degree of management support at all levels of the organization that will be committed to efficient administration of the project. Interested institutions may request background information and materials on the IQC Project from the Department of Education contact person.

Public reporting burden for this collection of information is estimated to average 1 hour per response, including the time for reviewing instructions, searching existing data sources, gathering and maintaining the data needed, and completing and reviewing the collection of information. Send comments regarding this burden estimate or any other aspect of this collection of information, including suggestions for reducing this burden, to the U.S. Department of Education, Information Management and

Compliance Division, Washington, DC 20202-4651; and to the Office of Management and Budget, Paperwork Reduction Project 1840 NEW, Washington, DC 20503.

Waiver of Rulemaking

In accordance with section 431(b)(2)(A) of the General Education Provisions Act (20 U.S.C. 1232(b)(2)(A)), and the Administrative Procedure Act, 5 U.S.C. 553, it is the practice of the Secretary to offer interested parties the opportunity to comment on proposed rules. However, the changes to the criteria are technical in nature and establish no new substantive policy.

Therefore, pursuant to 5 U.S.C. 553(b)(B) the Secretary finds that publication of proposed selection criteria is unnecessary and contrary to public interest.

Final Selection Criteria I and II

I. In order to be selected to participate in the IQC Project, an institution must:

1. Participate in the Pell Grant, campus-based (Perkins Loan, College Work-Study and Supplemental Educational Opportunity Grant) and Stafford Loan programs during the 1990-91 award year and have participated in

all five programs during the 1988-89 and 1989-90 award years;

2. Have had, in the aggregate, at least 1,000 Pell Grant and campus-based program recipients during the 1988-89 award year;

3. Have awarded, in the aggregate, at least \$1 million under the Pell Grant and campus-based programs combined in the 1988-89 award year; and

4. Have submitted and had approved by the Secretary its most recent audit report in which the reported liability was less than \$150,000.

II. If not more than 41 applicants meet the above criterion, the Secretary selects all the applicants who meet the criterion to participate in the IQC Project.

(Catalog of Federal Domestic Assistance Numbers: Number 84.007, Supplemental Educational Opportunity Grant Program; Number 84.032, Guaranteed Student Loan Program; Number 84.033, College Work-Study Program; Number 84.038, Perkins Loan Program; Number 84.063, Pell Grant Program)

Authority: 20 U.S.C. 1070 *et seq.*

Dated: July 12, 1991.

Lamar Alexander,

Secretary of Education.

[FR Doc. 91-17743 Filed 7-25-91; 8:45 am]

BILLING CODE 4000-01-M

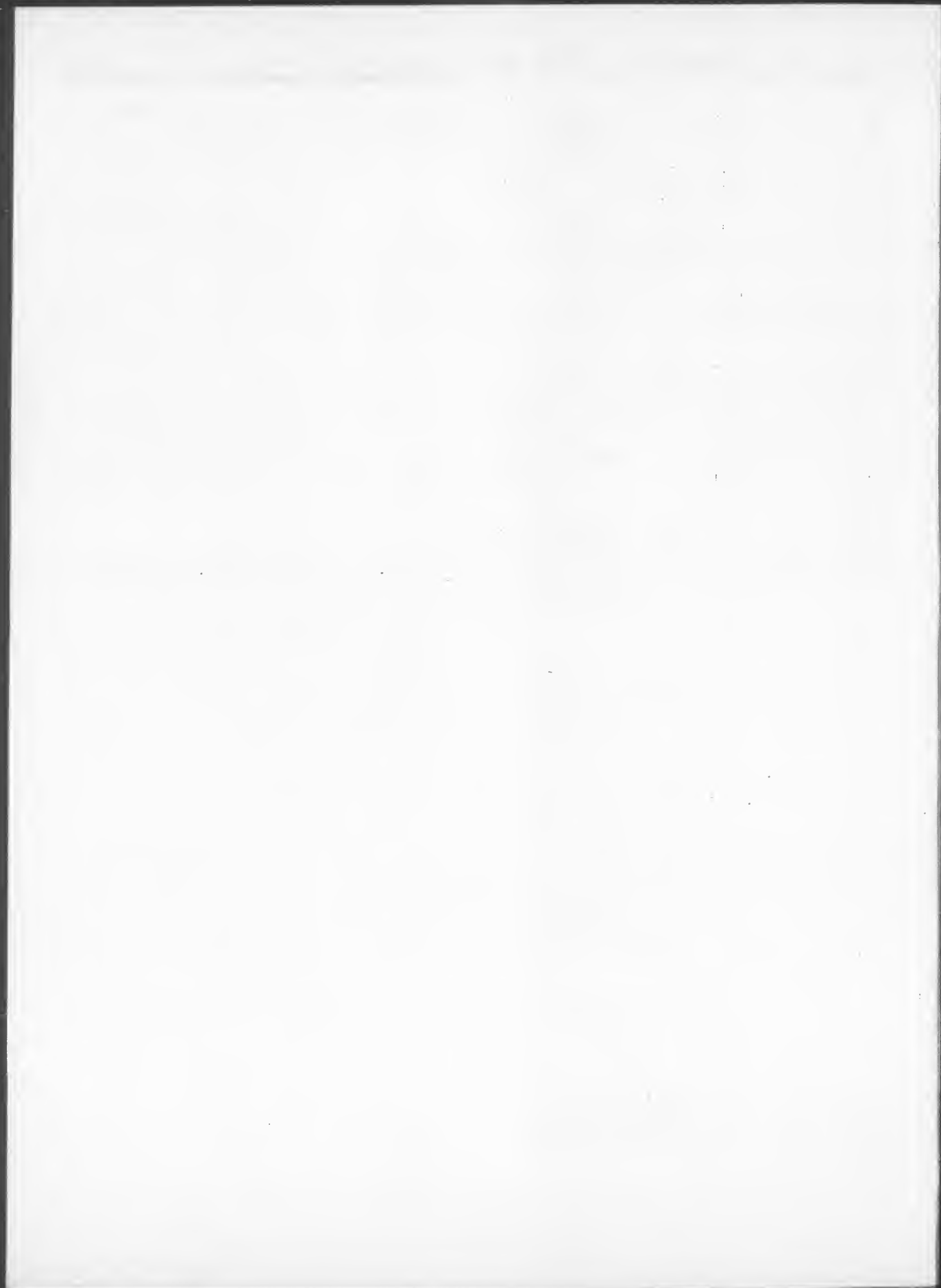

federal register

Friday
July 26, 1991

Part VIII

Department of the Interior

Bureau of Indian Affairs

**25 CFR Part 39
Indian School Equalization Program;
Administrative Cost Formula; Final Rule**

DEPARTMENT OF THE INTERIOR

Bureau of Indian Affairs

25 CFR Part 39

RIN 1076-AC58

Indian School Equalization Program;
Subpart J—Administrative Cost
Formula

June 28, 1991.

AGENCY: Bureau of Indian Affairs,
Interior.**ACTION:** Final rule.

SUMMARY: Beginning on page 53312 of the December 28, 1990, *Federal Register* (55 FR 53312), there was published a notice of proposed rulemaking to amend subpart J of 25 CFR part 39. These rules are to describe the method which will be used to distribute administrative funds to agency and area education offices of the Bureau of Indian Affairs by removing the existing subpart J in its entirety and replacing it with the new subpart J contained in this rule. This action formally implements an administrative decision of the Bureau under 25 U.S.C. 13.

EFFECTIVE DATE: These regulations shall become effective on July 21, 1991.

FOR FURTHER INFORMATION CONTACT: Edward F. Parisian, Director (Office of Indian Education Programs), Mail Stop 3530, 1849 C St., NW., Washington, DC 20240, telephone (202) 208-6175, (FTS) 268-6175.

SUPPLEMENTARY INFORMATION: These rules are published in exercise of the authority delegated by the Secretary of the Interior (Secretary) to the Assistant Secretary-Indian Affairs in the Departmental Manual at 209 DM 8.

The primary author of this document is Edward Parisian, Director, Office of Indian Education Programs.

There are no information collection requirements contained in part 39 which require approval by the Office of Management and Budget under 44 U.S.C. 3501 *et seq.*

On December 28, 1990, (55 FR 53312), the Bureau of Indian Affairs published a proposed rule describing the method for distributing administrative funds for the operation of agency and area education offices (Element 10 funds). The public was invited to offer comments on the proposed rule on or before March 28, 1991. Fourteen public comments were received from individuals or groups.

COMMENTS AND RESPONSES:

1. (Section 39.122) One commentator recommended that the formula consider the unique characteristics of offices. *Response:* A review of the proposed

distribution formula indicates that the formula takes into consideration six different variables within the offices; this is felt to be an acceptable consideration of the unique characteristics of the affected offices.

2. (Section 39.122) One commentator recommended the use of weighted factors for education programs. *Response:* The distribution formula uses the weighted student units for distributing a part of the funds and the number of schools weighted for type of operation (contract, grant or Bureau). Consequently no revision of the formula was attempted.

3. (Section 39.121) One commentator opposed the definitions of agency education office and area education office, stating that the definitions were in conflict with the functions in 25 CFR part 33.5 and 33.6. *Response:* The functions in 25 CFR part 33 are not changed by these definitions. The functions referenced are established by law. These definitions are included only for clarification of which offices received funds under this part.

4. (Section 39.122(a)) Four commentators suggested increasing the base amount from \$50,000 to another amount ranging from \$75,000 to \$175,000. One commentator suggested establishing a base of \$50,000 per state served. *Response:* Prior to publication of the proposed rule, the Bureau consulted with tribes throughout the United States in May and July, 1990. Various options, including base amounts of \$50,000, \$75,000 and \$100,000, were discussed at that time. The general reaction of most tribes was that they preferred that funds be directed at the level closest to tribes (the agency) and that reductions should be taken at the area and central office level. Since increasing the base has the primary result of increasing funds at area offices and decreasing funds at agency offices, this comment is not adopted.

5. (Section 39.122(b)) Three commentators suggested increasing the percentage of funds for administration of Johnson-O'Malley, higher education and adult education from 2 percent to an amount from two and one half per cent to eight percent. *Response:* Since all of Johnson-O'Malley funds and the great majority of higher education and adult education funds are contracted to tribes or other non-Bureau entities, a determination was made that two percent is adequate for administering these programs.

6. (Section 39.122(c)) One commentator suggested that the same weight be used for contract and grant schools as for Bureau-operated schools. *Response:* The administrative workload for an

education office is far less for contract and grant schools than for Bureau-operated schools. For example, the education office is responsible for contract monitoring for contract schools and review of the annual audit and progress report for grant schools. Therefore, a lesser weight for contract and grant schools is appropriate.

7. (Section 39.122(d)) One commentator suggested that the funds in this section be distributed for post-secondary and Johnson-O'Malley program administration rather than by weighted student units. *Response:* Funds are provided for post-secondary and Johnson-O'Malley operations under § 39.122(b). Education offices are not given credit for student enrollment in any other section. Therefore, this comment was not adopted.

8. Two commentators requested the establishment and funding of a new education office for the Nevada tribes. *Response:* This section is only a fund distribution formula and such a request is beyond the scope of this part.

9. Two commentators requested that the Bureau increase available funds for distribution under this part. Another commentator recommended developing a formula to generate funds rather than distribute them. *Response:* This formula is only for fund distribution and such requests are beyond the scope of this part. The nature of the Federal budget process precludes the use of the formula to generate funds, since only a specified amount of funds are available for the funding of agency and area education offices.

10. One commentator suggested changing the CFR to allow agency education offices to administer off-reservation boarding schools. *Response:* Such a request requires a legislative change and is beyond the scope of this part.

11. One commentator suggested using the number of contracts in each office in establishing the formula. *Response:* The number of contract schools is considered in the formula. The number of other contracts is not considered as it is too easily manipulated. It is felt that the 2 percent allowed for administration of Johnson-O'Malley, higher education and adult education is adequate for contract administration at all affected offices.

12. One commentator recommended publishing the formula as part of 25 CFR part 32. *Response:* Part 32 is concerned with policies on Indian education. This rule replaces an existing part of part 39, which is the only part which is concerned with funds distribution for

education programs. Therefore, part 39 is the appropriate part for these rules.

The Department of the Interior has determined that this is not a major rule under E.O. 12291 because only a limited number of individuals will be affected and the action proposed will not have a significant gross annual effect on the economy.

The Department of the Interior has determined that this rule will not have a significant economic impact on a substantial number of small entities within the meaning of the Regulatory Flexibility Act (5 U.S.C. 601 et seq.) because of the limited applicability as stated above.

The Department of the Interior has determined that this rule is not a major Federal action significantly affecting the quality of the human environment and that neither an environmental assessment nor an environmental impact statement is required.

List of Subjects in 25 CFR Part 39

Elementary and secondary education, Government contracts, Grant programs—education, Grant programs—Indians, Indians—education, Schools.

For the reasons set out in the preamble, part 39 of subchapter E of chapter I of title 25 of the Code of Federal Regulations is revised as set forth below.

PART 39—INDIAN SCHOOL EQUALIZATION PROGRAM

1. The authority citation for part 39 is revised to read as follows:

Authority: 25 U.S.C. 13; 25 U.S.C. 2008.

2. Subpart J is revised to read as follows:

Subpart J—Administrative Cost Formula

Sec.

39.120 Purpose and scope.

39.121 Definitions.

39.122 Allotment of education administrative funds.

39.123 Allotment exception for FY 1991.

Subpart J—Administrative Cost Formula

§ 39.120 Purpose and scope.

The purpose of this subpart is to provide funds at the agency and area education offices for FY 1991 and future years for administration of all Bureau of Indian Affairs education functions, including but not limited to school operations, continuing education, early childhood education, post-secondary education and Johnson-O'Malley Programs.

§ 39.121 Definitions.

(a) *Agency Education Office* means a field office of the Office of Indian Education Programs providing administrative direction and supervision to one or more Bureau-operated schools as well as being responsible for all other education functions serving tribes within that agency's jurisdiction.

(b) *Area Education Office* means a field office of the Office of Indian Education Programs responsible for all education functions serving tribes not serviced by an agency education office and in some cases providing administrative direction to one or more off-reservation boarding schools not under an agency education office.

§ 39.122 Allotment of education administrative funds.

The total annual budget for agencies/areas shall be allotted to the Director and through him/her to agency and area education offices. This total budget shall

be distributed to the various agency and area education offices as follows:

(a) Each agency or area education office as defined above shall receive a base amount of \$50,000 for basic administrative costs; and

(b) Each agency or area education office as defined above shall receive an amount under these funds equal to two percent of the total higher education, Johnson-O'Malley and adult education funds administered by each office, except that the Navajo Agencies are restricted to a maximum of \$50,000 for administering the Johnson-O'Malley and higher education programs; and

(c) Eighty percent of the remaining funds shall be distributed proportionately based on the number of schools operated under the jurisdiction of each agency or area education office, with Bureau-operated schools counting as 1 and contract/grant schools counting as 0.6; and

(d) The remaining twenty percent shall be distributed proportionately based on the total weighted student units generated by all schools under the jurisdiction of each agency or area education office.

§ 39.123 Allotment exception for FY 1991.

For FY 1991 only, the Director may reserve an amount equal to no more than one half of the funds received in FY 1990 by those offices to be closed in FY 1991 to cover severance pay costs, lump sum leave payments and relocation costs for those individuals affected by the closures. Any balance uncommitted by March 31, 1991, shall be distributed in accordance with the formula in 39.122.

Eddie F. Brown,

Assistant Secretary, Indian Affairs.

[FR Doc. 91-17747 Filed 7-25-91; 8:45 am]

BILLING CODE 4310-02-M



Federal Register

Friday
July 26, 1991

Part IX

Department of Energy

Office of Procurement, Assistance and
Program Management

10 CFR Part 707

Workplace Substance Abuse Program at
DOE Facilities; Notice of Cancellation of
Public Hearing in Albuquerque, NM

DEPARTMENT OF ENERGY**Office of Procurement, Assistance
and Program Management****10 CFR Part 707****Workplace Substance Abuse
Programs at DOE Facilities****AGENCY:** Department of Energy.**ACTION:** Notice of cancellation of public hearing in Albuquerque, NM.

SUMMARY: On July 3, 1991, the Department of Energy (DOE) published in the Federal Register a notice of proposed rulemaking and public hearing, together with a request for public comments. The rulemaking proposed to add a new part 707 to title 10, Code of Federal Regulations, dealing with workplace substance abuse programs at DOE facilities. (56 FR 30644.) That publication contained a notice of two public hearings to be held on the rulemaking, one in Washington, DC, on July 29, 1991, and one in Albuquerque, New Mexico, on July 31, 1991, "unless there are not a sufficient number of advance requests to present views, in

which event a hearing will be cancelled." DOE received requests to appear at the hearings and present views before and up to 4:30 p.m. on Friday, July 19, 1991, as provided in the notice. When the period for receiving requests to appear at the hearings expired, only two requests to appear at the hearing in Albuquerque had been received. DOE does not consider this to be "a sufficient number of advance requests" to justify the expense of holding a second hearing in Albuquerque after the hearing in Washington. Those persons who requested to appear at the Albuquerque hearing are invited to attend the Washington hearing, or to submit their written comments. Written public comments shall, of course, continue to be received up until September 3, 1991, the date originally specified in the notice of proposed rulemaking. For further information, see the original notice.

DATES: Written comments must be received by September 3, 1991, as provided in the original notice. Six copies of all comments should be provided. A public hearing will be held in the Forrestal Building, Room GJ-015,

1000 Independence Avenue SW., Washington, DC, on Monday, July 29, 1991, beginning at 9 a.m., e.d.t., and concluding at 4:30 p.m., e.d.t., or when all persons present who have given proper and timely notice of their intention to present views have done so, whichever is sooner, also as provided in the original notice.

ADDRESSES: Written comments are to be submitted to: Director, Office of Contractor Human Resource Management, Department of Energy, Washington, DC 20585. The public hearing will be held at the location given in the above paragraph.

FOR FURTHER INFORMATION CONTACT: Juanita E. Smith or Armin Behr at (202) 586-9023 (FTS 896-9023).

For the foregoing reasons, the public hearing on proposed 10 CFR part 707, set for Albuquerque, New Mexico, on July 31, 1991, is hereby cancelled.

Washington, DC.
Dated: July 23, 1991.

Berton J. Roth,

*Deputy Director, Office of Procurement,
Assistance and Program Management.*

[FR Doc. 91-17881 Filed 7-25-91; 8:45 am]

BILLING CODE 6450-01-M

Reader Aids

Federal Register

Vol. 56, No. 144

Friday, July 26, 1991

INFORMATION AND ASSISTANCE

Federal Register

| | |
|---|----------|
| Index, finding aids & general information | 523-5227 |
| Public inspection desk | 523-5215 |
| Corrections to published documents | 523-5237 |
| Document drafting information | 523-5237 |
| Machine readable documents | 523-3447 |

Code of Federal Regulations

| | |
|---|----------|
| Index, finding aids & general information | 523-5227 |
| Printing schedules | 523-3419 |

Laws

| | |
|---|----------|
| Public Laws Update Service (numbers, dates, etc.) | 523-6641 |
| Additional information | 523-5230 |

Presidential Documents

| | |
|--|----------|
| Executive orders and proclamations | 523-5230 |
| Public Papers of the Presidents | 523-5230 |
| Weekly Compilation of Presidential Documents | 523-5230 |

The United States Government Manual

| | |
|---------------------|----------|
| General information | 523-5230 |
|---------------------|----------|

Other Services

| | |
|---|----------|
| Data base and machine readable specifications | 523-3408 |
| Guide to Record Retention Requirements | 523-3187 |
| Legal staff | 523-4534 |
| Library | 523-5240 |
| Privacy Act Compilation | 523-3187 |
| Public Laws Update Service (PLUS) | 523-6641 |
| TDD for the hearing impaired | 523-5229 |

FEDERAL REGISTER PAGES AND DATES, JULY

| | |
|-------------|----|
| 29889-30306 | 1 |
| 30307-30482 | 2 |
| 30483-30678 | 3 |
| 30679-30856 | 5 |
| 30857-31042 | 8 |
| 31043-31304 | 9 |
| 31305-31532 | 10 |
| 31533-31854 | 11 |
| 31855-32060 | 12 |
| 32061-32318 | 15 |
| 32319-32498 | 16 |
| 32499-32950 | 17 |
| 32951-33188 | 18 |
| 33189-33366 | 19 |
| 33367-33702 | 22 |
| 33703-33838 | 23 |
| 33839-34002 | 24 |
| 34003-34140 | 25 |
| 34141-35798 | 26 |

CFR PARTS AFFECTED DURING JULY

At the end of each month, the Office of the Federal Register publishes separately a List of CFR Sections Affected (LSA), which lists parts and sections affected by documents published since the revision date of each title.

| | | |
|-------------------------------|-------|--------------|
| 1 CFR | 17 | 33367 |
| 305 | 33841 | 32951 |
| 3 CFR | | 31533, 34003 |
| Administrative Orders: | | 32474 |
| Memorandums: | | 30485, 33854 |
| June 25, 1991 | 31041 | 32919 |
| Presidential Determinations: | | 32919 |
| No. 91-41 of | | 32919 |
| June 19, 1991 | 31303 | 32919 |
| No. 91-42 of | | 32919 |
| June 21, 1991 | 30483 | 32919 |
| No. 91-43 of | | 32919 |
| June 24, 1991 | 31037 | 32919 |
| No. 91-44 of | | 32919 |
| June 24, 1991 | 31039 | 32919 |
| No. 91-45 of | | 32919 |
| July 8, 1991 | 33837 | 32919 |
| No. 91-46 of | | 32919 |
| July 13, 1991 | 33839 | 32919 |
| Proclamations: | | 32919 |
| 3019 (See Proc. 6313) | | 32919 |
| 6310 | 30303 | 32919 |
| 6311 | 30307 | 32919 |
| 6312 | 30855 | 32919 |
| 6313 | 31853 | 32919 |
| 6314 | 32059 | 32919 |
| 6315 | 32497 | 32919 |
| 6316 | 34139 | 32919 |
| Executive Orders: | | 32919 |
| 12473 (See EO | | 32919 |
| 12767) | 30283 | 32919 |
| 12484 (See EO | | 32919 |
| 12767) | 30283 | 32919 |
| 12532 (Revoked by | | 32919 |
| EO 12769) | 31855 | 32919 |
| 12535 (Revoked by | | 32919 |
| EO 12769) | 31855 | 32919 |
| 12550 (See EO | | 32919 |
| 12767) | 30283 | 32919 |
| 12571 (See EO | | 32919 |
| 12769) | 31855 | 32919 |
| 12586 (See EO | | 32919 |
| 12767) | 30283 | 32919 |
| 12700 (Amended by | | 32919 |
| EO 12768) | 30301 | 32919 |
| 12708 (See EO | | 32919 |
| 12767) | 30283 | 32919 |
| 12767 | 30283 | 32919 |
| 12768 | 30301 | 32919 |
| 12769 | 31855 | 32919 |
| 5 CFR | | 32919 |
| 532 | 31305 | 32919 |
| 2412 | 33189 | 32919 |
| Proposed Rules: | | 32919 |
| 842 | 30701 | 32919 |
| 843 | 30701 | 32919 |
| 2635 | 33778 | 32919 |
| 7 CFR | | 32919 |
| 2 | 32951 | 32919 |

| | | |
|------------------------|---------------------|-------|
| Proposed Rules: | | 32919 |
| 1 | 32340 | 32919 |
| 28 | 30618 | 32919 |
| 52 | 32121 | 32919 |
| 210 | 30339, 32241 | 32919 |
| 235 | 30339, 32241 | 32919 |
| 245 | 30339, 32241 | 32919 |
| 800 | 29907, 30342 | 32919 |
| 810 | 29907, 30342 | 32919 |
| 905 | 32340 | 32919 |
| 906 | 33393 | 32919 |
| 910 | 30878, 30879, 33213 | 32919 |
| 916 | 30881 | 32919 |
| 917 | 30881 | 32919 |
| 927 | 33394 | 32919 |
| 931 | 33730 | 32919 |
| 945 | 32128 | 32919 |
| 967 | 32129 | 32919 |
| 981 | 34034 | 32919 |
| 993 | 33731 | 32919 |
| 1001 | 33395 | 32919 |
| 1002 | 33395 | 32919 |
| 1004 | 33395 | 32919 |
| 1005 | 33395 | 32919 |
| 1007 | 32519, 33395 | 32919 |
| 1011 | 33395 | 32919 |
| 1030 | 33395 | 32919 |
| 1033 | 33395 | 32919 |
| 1036 | 33395 | 32919 |
| 1040 | 33395 | 32919 |
| 1044 | 33395 | 32919 |
| 1046 | 33395 | 32919 |

| | | | |
|----------------------------|---|------------------------|--|
| 1049.....33395 | 312.....29893 | 289.....32078 | 31350, 31689, 31887-31890, 32525, 32533, 33488, 34044 |
| 1065.....33395 | 506.....34005 | 290.....32081 | 20.....31362 |
| 1068.....33395 | 563.....31061, 32474, 34005 | Proposed Rules: | 25.....31362 |
| 1079.....33395 | 584.....31061 | 146.....32358 | 48.....30359 |
| 1093.....33395 | 612.....32956 | 240.....31349 | 301.....31362, 31890, 33888- 33890 |
| 1094.....33395 | 1618.....30836 | 18 CFR | |
| 1096.....33395 | 1680.....34014 | 4.....31327 | 27 CFR |
| 1097.....33395 | 13 CFR | 37.....33378 | 4.....31076 |
| 1098.....33395 | 107.....30850, 31774 | 284.....30692 | 5.....31076 |
| 1099.....33395 | 14 CFR | 401.....30500 | 6.....31076 |
| 1106.....33395 | 39.....30313-30316, 30319- 30324, 30680-30683, 31070- 31072, 31324-31326, 31868, 31869, 32072-32075, 32320, 32957, 32958, 33213, 33372- 33374, 33705, 33863, 34019, 34142-34146 | 19 CFR | 7.....31076 |
| 1108.....33395 | 71.....30684, 30685, 31689, 32076, 33961, 33374, 34147 | 4.....32084, 34149 | 9.....31076 |
| 1120.....33395 | 73.....30685, 34148 | 122.....32085 | 19.....31076 |
| 1124.....32130, 33395 | 75.....33375, 33865 | 178.....32085 | 24.....31076 |
| 1126.....32131, 33395 | 95.....30686 | Proposed Rules: | 53.....31076 |
| 1131.....33395 | 97.....30317, 32502 | 19.....33733 | 70.....31076 |
| 1132.....33395 | 129.....30122 | 24.....31576 | 178.....32507 |
| 1135.....33395 | 157.....33994 | 113.....33735 | 252.....31076 |
| 1138.....33395 | 158.....30867 | 118.....33734 | Proposed Rules: |
| 1205.....31209 | 1214.....31073 | 144.....33733 | 4.....29913 |
| 1211.....30517 | Proposed Rules: | 20 CFR | |
| 1413.....32132 | Ch. I.....33213 | Proposed Rules: | |
| 1421.....29912 | 21.....31879 | 320.....30714 | 28 CFR |
| 1942.....31548 | 23.....33688 | 340.....32523 | 0.....30693 |
| 1943.....30347 | 25.....31879 | 404.....31266, 33130 | 2.....30867-30872 |
| 1951.....30347 | 39.....30350, 30351, 31881- 31885, 32136, 33214, 33215, 33396, 33732 | 416.....30884, 33130 | 35.....35694 |
| 1980.....30347 | 71.....30353, 30354, 30618, 30683, 32138, 32519-32522, 32991, 33217, 34155 | 656.....32244 | 36.....35544 |
| 3400.....30256 | 73.....30355 | 21 CFR | 50.....32326 |
| 8 CFR | 91.....30618, 34000 | 58.....32087 | 64.....32327 |
| 103.....31060, 32500 | 207.....31092 | 520.....31075 | 500.....31350 |
| 214.....31305, 33370 | 208.....31092 | 522.....31075 | 503.....31350 |
| 217.....32952 | 212.....31092 | 524.....31075 | 524.....30676 |
| 240.....32500 | 241.....32992 | 558.....29896 | 541.....31350 |
| 242.....33204 | 294.....31092 | 812.....32241 | 545.....31350 |
| 245a.....31060 | 298.....31092 | Proposed Rules: | 546.....31350 |
| 251.....31305 | 380.....31092 | 101.....30452, 30468 | 75.....29914 |
| 258.....31305 | 15 CFR | 102.....30452 | 29 CFR |
| 287.....33204 | 8a.....29896 | 310.....32282 | 500.....30326 |
| 338.....30679 | 29a.....29896 | 333.....33644 | 870.....32254 |
| Proposed Rules: | 29b.....29896 | 357.....32282 | 1600.....30502 |
| 204.....30703 | 771.....34021 | 369.....33644 | 1602.....35753 |
| 214.....31553, 33886 | 774.....34021 | 864.....32359 | 1627.....35753 |
| 9 CFR | 16 CFR | 888.....32145 | 1630.....35726 |
| 78.....32604, 32605, 34141 | 305.....30494 | 22 CFR | 2610.....32088 |
| 92.....31858, 33862 | 1000.....30495 | 40.....30422 | 2622.....32088 |
| 166.....34142 | Proposed Rules: | 41.....30422 | 2644.....32089 |
| Proposed Rules: | 1500.....31348, 32352 | 42.....30422, 32322 | 2676.....32090 |
| 54.....32342 | 1700.....30355 | 43.....30422 | Proposed Rules: |
| 79.....32342 | 17 CFR | 44.....30422 | 1910.....32302 |
| 10 CFR | 200.....30036 | 45.....32503 | 30 CFR |
| 2.....32066, 34104 | 201.....30036 | 47.....32324 | 56.....32091 |
| 9.....32070 | 210.....30036 | Proposed Rules: | 57.....32091 |
| 20.....32071 | 211.....33376 | 121.....34037-34044 | 250.....31890, 32091 |
| 35.....34104 | 229.....30036 | 24 CFR | 901.....30502, 32509 |
| 50.....31306 | 230.....30036 | Subtitle A.....32325 | 904.....32961 |
| 52.....31472 | 239.....30036 | 50.....30325 | 906.....33381 |
| 55.....32066 | 240.....30036, 32077 | 58.....30325 | Proposed Rules: |
| 71.....31472 | 249.....30036 | 86.....30430 | 218.....31891 |
| 170.....31472 | 260.....30036 | Proposed Rules: | 230.....31891 |
| 171.....31472 | 269.....30036 | 961.....30176 | 772.....32050 |
| Proposed Rules: | 11 CFR | 25 CFR | 913.....31577 |
| 61.....34035 | 102.....34124 | 39.....35794 | 914.....31093 |
| 707.....30644, 35798 | 113.....34124 | Proposed Rules: | 917.....30722, 33398 |
| 11 CFR | 9034.....34130 | 151.....32278 | 920.....30517 |
| 102.....34124 | 9036.....34130 | 26 CFR | 935.....31986 |
| 113.....34124 | 9037.....34130 | Proposed Rules: | 948.....33399 |
| 9034.....34130 | 12 CFR | 740.....33152 | 950.....31898 |
| 9036.....34130 | 268.....32954 | 761.....33152, 33170 | 963.....31094 |
| 9037.....34130 | | 772.....33152 | Proposed Rules: |
| 12 CFR | | | 1.....30718-30721, 31349, |

| | | | | | | | |
|------------------------|---|------------------------|---|------------------------|---|------------------------|---|
| 784..... | 33170 | 261..... | 30192, 32688, 32993 | 64..... | 31337-31339, 34023 | 506..... | 33721 |
| 817..... | 33170 | 262..... | 30192 | 65..... | 32329, 32330, 34026, 34027 | 510..... | 33721 |
| 31 CFR | | 264..... | 30192, 30200, 32688 | 67..... | 32330, 34028 | 519..... | 30618 |
| 545..... | 32055 | 265..... | 30192, 30200, 32688 | 302..... | 29903 | 549..... | 33721 |
| 32 CFR | | 266..... | 32688 | 361..... | 32490 | 1513..... | 32518 |
| Ch. I..... | 31085, 31537 | 270..... | 30192, 32688 | Proposed Rules: | | 1804..... | 32115 |
| 192..... | 32964 | 271..... | 30336, 32328, 32688, 33206, 33717, 33866 | 67..... | 32490, 34047 | 1806..... | 32115 |
| 195..... | 32965 | 721..... | 29902, 29903 | 45 CFR | | 1807..... | 32115 |
| 199..... | 32965 | Proposed Rules: | | 233..... | 32152 | 1825..... | 32115 |
| 286b..... | 32965 | 22..... | 33401 | 1160..... | 32155 | 1839..... | 32115 |
| 300..... | 32965 | 28..... | 29996 | Proposed Rules: | | 1842..... | 32115 |
| 301..... | 32964 | 52..... | 29918, 31364, 33738 | 586..... | 30373 | 1845..... | 32115 |
| 352..... | 31537 | 60..... | 33490 | 46 CFR | | 1852..... | 32115 |
| 362..... | 31540 | 79..... | 33228 | 16..... | 31030 | 1853..... | 32115 |
| 806b..... | 33384 | 80..... | 29919, 31148-31176, 32533 | 221..... | 30654 | Proposed Rules: | |
| 861..... | 30327 | 86..... | 30228, 32533 | Proposed Rules: | | 10..... | 31844 |
| Proposed Rules: | | 136..... | 30519 | 586..... | 30373 | 15..... | 33330, 33826 |
| 153..... | 33218 | 172..... | 33890 | 47 CFR | | 28..... | 31278 |
| 199..... | 30360, 30887 | 180..... | 33236 | 0..... | 33720 | 31..... | 33822 |
| 228..... | 30365 | 185..... | 33236 | 1..... | 33720 | 33..... | 33892 |
| 33 CFR | | 186..... | 33236 | 2..... | 32474 | 51..... | 33822 |
| 1..... | 30242 | 260..... | 30519, 33490 | 22..... | 34149 | 52..... | 31278, 31844, 33330, 33822, 33826 |
| 88..... | 33384 | 261..... | 30519, 33238, 35758 | 61..... | 33879 | 209..... | 32159 |
| 100..... | 29897-29899, 30507, 31085, 31872-31875, 33707, 33708, 34022 | 264..... | 30201, 33490 | 69..... | 33879 | 242..... | 32159 |
| 117..... | 30332 | 265..... | 30201, 33490 | 73..... | 30337, 30510-30512, 31087, 31545, 31548, 31876, 32113, 32114, 32371, 32372, 32975-32978, 33386, 33387, 33720, 33721 | 49 CFR | |
| 165..... | 30334, 30507-30509, 31086, 31876, 32111, 32112, 33708 | 270..... | 33490 | 76..... | 33387 | 1..... | 31343 |
| Proposed Rules: | | 271..... | 33490, 35758 | 80..... | 34028 | 40..... | 30512, 33882 |
| 100..... | 29916, 31879, 32115 | 280..... | 30201 | 90..... | 32515 | 190..... | 31087, 33208 |
| 117..... | 32151, 34046 | 300..... | 31900 | 94..... | 30698, 34149 | 192..... | 31087, 33208 |
| 34 CFR | | 302..... | 35758 | 97..... | 32515 | 193..... | 31087, 33208 |
| 361..... | 33148 | 372..... | 34158 | Proposed Rules: | | 195..... | 31087, 33208 |
| 668..... | 33332 | 721..... | 34047 | Ch. I..... | 30373 | 199..... | 31087, 33208 |
| 682..... | 33332 | 761..... | 30201 | 2..... | 31095 | 234..... | 33722 |
| Proposed Rules: | | 798..... | 32537 | 61..... | 33891, 34159 | 1017..... | 32333 |
| 361..... | 30620 | 799..... | 32292 | 69..... | 33891, 34159 | 1039..... | 31546 |
| 35 CFR | | 41 CFR | | 73..... | 30374, 30375, 30524- 30526, 31902, 32158, 32474, 33013, 33413, 33414, 33739, 33740, 34162 | 1051..... | 30873 |
| 101..... | 31362 | 50-202..... | 32257 | 76..... | 30526, 30726, 33414, 34162 | 1152..... | 32336 |
| 36 CFR | | 101-5..... | 33873 | 90..... | 31097 | 1220..... | 30873 |
| 7..... | 30694 | 101-40..... | 33876 | 48 CFR | | Proposed Rules: | |
| 1191..... | 35408 | 42 CFR | | 1..... | 33487 | 571..... | 30528, 32544, 33239 |
| 37 CFR | | 405..... | 31332 | 5..... | 33487 | 1039..... | 32159 |
| Proposed Rules: | | 442..... | 30696 | 8..... | 33487 | 50 CFR | |
| 201..... | 31580, 32474 | 484..... | 32987 | 9..... | 33487 | 17..... | 32978, 34151 |
| 38 CFR | | Proposed Rules: | | 10..... | 33487 | 611..... | 33208 |
| 21..... | 31331 | 417..... | 30723, 31597, 33403 | 14..... | 33487 | 630..... | 29905, 31347 |
| 36..... | 29899 | 431..... | 33403 | 15..... | 33487 | 641..... | 30513, 33883 |
| Proposed Rules: | | 434..... | 33403 | 16..... | 33487 | 646..... | 33210 |
| 3..... | 30893 | 1003..... | 33403 | 17..... | 33487 | 650..... | 30514 |
| 39 CFR | | 43 CFR | | 19..... | 33487 | 651..... | 33884 |
| Proposed Rules: | | 38..... | 33719 | 25..... | 33487 | 661..... | 34031, 34032 |
| 265..... | 31363 | 5460..... | 33830 | 27..... | 33487 | 663..... | 30338 |
| 40 CFR | | 5470..... | 33830 | 31..... | 33487 | 672..... | 30874, 31547, 32119, 32983, 33884 |
| 52..... | 30335, 32511, 32512, 33710-33715 | 6865..... | 32515 | 35..... | 33487 | 675..... | 30515, 30699, 30874, 32338, 32984, 33210 |
| 82..... | 30873 | Proposed Rules: | | 36..... | 33487 | 685..... | 31689, 33211 |
| 141..... | 30264, 32112, 33050 | 11..... | 30367 | 42..... | 33487 | Proposed Rules: | |
| 142..... | 30264, 32212, 33050 | 415..... | 31601 | 43..... | 33487 | 17..... | 31902, 33241, 33741, 33892, 34162 |
| 143..... | 30264 | 3160..... | 29920 | 44..... | 33487 | 20..... | 32264-32275 |
| 180..... | 29900, 32514 | 3400..... | 32002 | 45..... | 33487 | 23..... | 33894 |
| 260..... | 32688 | 3410..... | 32002 | 49..... | 33487 | 298..... | 32160 |
| | | 3420..... | 32002 | 52..... | 33487 | 646..... | 32000 |
| | | 3440..... | 32002 | 225..... | 34030 | 642..... | 29920 |
| | | 3450..... | 32002 | 232..... | 31341 | 648..... | 29922, 32000 |
| | | 3460..... | 32002 | 252..... | 31341 | 651..... | 29934 |
| | | 3470..... | 32002 | 352..... | 33881 | 662..... | 33416 |
| | | 3480..... | 32002 | | | 663..... | 32165 |
| | | 3800..... | 31602 | | | 680..... | 30893 |
| | | 3810..... | 30367 | | | | |
| | | 3820..... | 30367 | | | | |
| | | 4700..... | 30372 | | | | |
| | | 44 CFR | | | | | |
| | | 8..... | 32328 | | | | |

685..... 30376, 34049

LIST OF PUBLIC LAWS

Note: No public bills which have become law were received by the Office of the Federal Register for inclusion in today's List of Public Laws.

Last List July 15, 1991

The authentic text behind the news . . .

The Weekly Compilation of Presidential Documents

Administration of George Bush

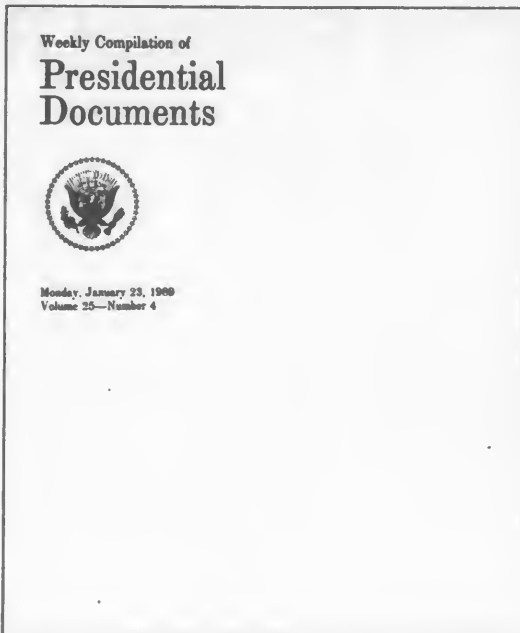

This unique service provides up-to-date information on Presidential policies and announcements. It contains the full text of the President's public speeches, statements, messages to Congress, news conferences, personnel appointments and nominations, and other Presidential materials released by the White House.

The Weekly Compilation carries a Monday dateline and covers materials released during the preceding week. Each issue contains an Index of Contents and a Cumulative Index to Prior Issues.

Separate indexes are published periodically. Other features include

lists of acts approved by the President, nominations submitted to the Senate, a checklist of White House press releases, and a digest of other Presidential activities and White House announcements.

Published by the Office of the Federal Register, National Archives and Records Administration.

Superintendent of Documents Subscriptions Order Form

Order Processing Code

*6466

Charge your order.
It's easy!



Charge orders may be telephoned to the GPO order desk at (202) 783-3238 from 8:00 a.m. to 4:00 p.m. eastern time, Monday-Friday (except holidays)

YES, please enter my subscription for one year to the **WEEKLY COMPILATION OF PRESIDENTIAL DOCUMENTS (PD)** so I can keep up to date on Presidential activities.

\$96.00 First Class

\$55.00 Regular Mail

1. The total cost of my order is \$ _____. All prices include regular domestic postage and handling and are subject to change. International customers please add 25%.

Please Type or Print

2. _____
(Company or personal name)

(Additional address/attention line)

(Street address)

(City, State, ZIP Code)

()

(Daytime phone including area code)

3. Please choose method of payment:

Check payable to the Superintendent of Documents

GPO Deposit Account []-[]

VISA or MasterCard Account

[]-[]

(Credit card expiration date) **Thank you for your order!**

(Signature)

(Rev. 1-20-89)

4. Mail To: Superintendent of Documents, Government Printing Office, Washington, D.C. 20402-9371

The Federal Register

Regulations appear as agency documents which are published daily in the **Federal Register** and codified annually in the **Code of Federal Regulations**

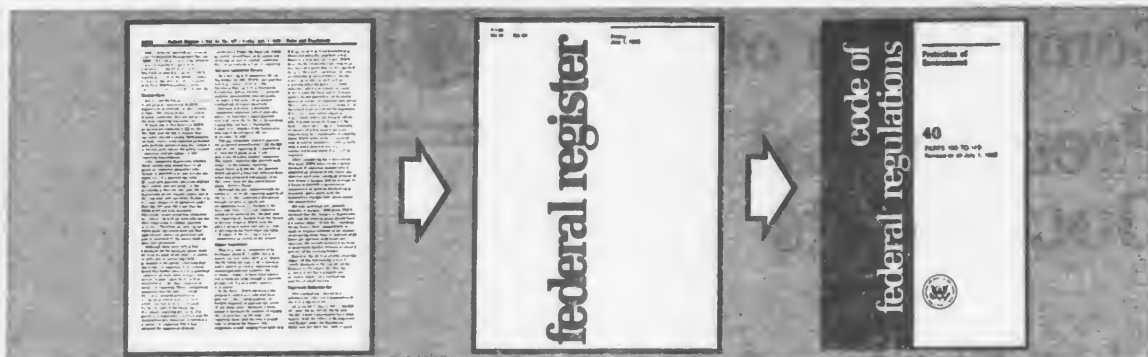

The **Federal Register**, published daily, is the official publication for notifying the public of proposed and final regulations. It is the tool for you to use to participate in the rulemaking process by commenting on the proposed regulations. And it keeps you up to date on the Federal regulations currently in effect.

Mailed monthly as part of a **Federal Register** subscription are: the LSA (List of CFR Sections Affected) which leads users of the **Code of Federal Regulations** to amendatory actions published in the daily **Federal Register**; and the cumulative **Federal Register Index**.

The **Code of Federal Regulations (CFR)** comprising approximately 196 volumes contains the annual codification of the final regulations printed in the **Federal Register**. Each of the 50 titles is updated annually.

Individual copies are separately priced. A price list of current CFR volumes appears both in the **Federal Register** each Monday and the monthly LSA (List of CFR Sections Affected). Price inquiries may be made to the Superintendent of Documents, or the Office of the Federal Register.

Superintendent of Documents Subscription Order Form

Order Processing Code:

* **6463**

Charge your order.
It's easy!



Charge orders may be telephoned to the GPO order desk at (202) 783-3238 from 8:00 a.m. to 4:00 p.m. eastern time, Monday-Friday (except holidays)

YES, please send me the following indicated subscriptions:

• **Federal Register**

• **Paper:**

___\$340 for one year
___\$170 for six-months

• **24 x Microfiche Format:**

___\$195 for one year
___\$97.50 for six-months

• **Magnetic tape:**

___\$37,500 for one year
___\$18,750 for six-months

• **Code of Federal Regulations**

• **Paper**

___\$620 for one year

• **24 x Microfiche Format:**

___\$188 for one year

• **Magnetic tape:**

___\$21,750 for one year

1. The total cost of my order is \$_____. All prices include regular domestic postage and handling and are subject to change. International customers please add 25%.

Please Type or Print

2. _____
(Company or personal name)

(Additional address/attention line)

(Street address)

(City, State, ZIP Code)

(_____) _____
(Daytime phone including area code)

3. Please choose method of payment:

Check payable to the Superintendent of Documents

GPO Deposit Account

VISA or MasterCard Account

(Credit card expiration date)

(Signature) (Rev. 2/90)

Thank you for your order!

4. Mail To: Superintendent of Documents, Government Printing Office, Washington, D.C. 20402-9371

